

NOTICE INVITING TENDER

FOR

EMERGENCY DIESEL GENERATOR PACKAGE

OPEN DOMESTIC COMPETITIVE BIDDING

(NIT NO : PNMM/PC-183/E- 4022/NCB)



TALCHER FERTILIZERS LIMITED

[A JOINT VENTURE OF M/s GAIL (INDIA) LIMITED (GAIL), M/s RASHTRIYA CHEMICALS & FERTILIZERS LTD. (RCF), M/s COAL INDIA LTD. (CIL), & M/s FERTILIZER CORPORATION OF INDIA LTD (FCIL)]



ISSUED BY



PROJECTS & DEVELOPMENT INDIA LTD.
(A Govt. Of India Enterprise)
PDIL BHAWAN, A-14, Sector-1,
NOIDA U.P. (India)





06.09.2023



	EMERGENCY DIESEL GENERATOR PACKAGE TALCHER FERTILIZERS LIMITED, ODISHA (INDIA) MASTER INDEX	PC183/E-4022	0	
		DOC. NO.	REV.	
		SHEET 1 OF 3		

MASTER INDEX

PART-I, COMMERCIAL	
Section	Description
Section-I	
1.0	Invitation For Bid (IFB)
Section-II	
2.1	Bid Evaluation Criteria (BEC)
2.2	Evaluation Methodology
Section-III	
3.0	Instructions to Bidders (ITB), Annexures and Forms & Format
Annexures	
Annexure-I	Procedure For Action In Case Corrupt/fraudulent/Collusive/ Coercive Practices
Annexure-II	Vendor Performance Evaluation
	ANNEXURE-1: Performance Rating Data Sheet
	ANNEXURE-2: Performance Rating Data Sheet
Annexure-III	Instruction For Participation In E-Tender
Annexure-IV	Bidding Data Sheet (BDS)
Annexure-V:	Public Procurement Policy (PPP)
Annexure-VI:	Preamble to Schedule of Rates
Annexure-VII:	Provision for Procurement from a Bidder Which Shares a Land Border With India

	EMERGENCY DIESEL GENERATOR PACKAGE TALCHER FERTILIZERS LIMITED, ODISHA (INDIA) MASTER INDEX	PC183/E-4022	0	
		DOC. NO.	REV.	
		SHEET 2 OF 3		

Forms & Formats	
F-1	BIDDER'S GENERAL INFORMATION
F-2A	PROFORMA OF "BANK GUARANTEE"FOR "EARNEST MONEY / BID SECURITY"
F-2B	FORMAT OF " DECLARATION FOR BID SECURITY "
F-3	LETTER OF AUTHORITY
F-4	PROFORMA OF "BANK GUARANTEE" FOR "CONTRACT PERFORMANCE SECURITY / SECURITY DEPOSIT"
F-4(a)	MATTER TO BE MENTIONED IN COVERING LETTER TO BE SUBMITTED BY VENDOR ALONG WITH BANK GUARANTEE (BG)
F-5	AGREED TERMS & CONDITIONS
F-6	ACKNOWLEDGEMENT CUM CONSENT LETTER
F-7	BIDDER'S EXPERIENCE
F-8(A)	CHECKLIST
F-8(B)	CHECKLIST FOR BID EVALUATION CRITERIA (BEC) QUALIFYING DOCUMENTS
F-9	FORMAT FOR CERTIFICATE FROM BANKIF BIDDER'S WORKING CAPITAL IS INADEQUATE
F-10	FORMAT FOR CHARTERED ACCOUNTANT CERTIFICATE FOR FINANCIAL CAPABILITY OF THE BIDDER
F-11	FORMAT FOR CONSORTIUM AGREEMENT
F-12	BIDDER'S QUERIES FOR PRE BID MEETING
F-13	E-BANKING FORMAT
F-14	INTEGRITY PACT
F-15	INDEMNITY BOND
F-16	FREQUENTLY ASKED QUESTIONS (FAQS)
F-17	PROFORMA OF BANK GUARANTEE FOR MOBILISATIONS ADVANCE PAYMENT
F-17 (a)	MATTER TO BE MENTIONED IN COVERING LETTER TO BE SUBMITTED BY VENDOR ALONG WITH BANK GUARANTEE (BG)
F-18	PROFORMA OF BANK GUARANTEE FOR PAYMENTS TOWARDS PLACEMENT OF ALL PURCHASE ORDERS OF MAJOR TAGGED ITEMS
F-19	FORMAT OF LETTER OF NO DEVIATIONS
F-20	FORMAT FOR POWER OF ATTORNEY
F-21	UNDERTAKING REGARDING SUBMISSION OF ELECTRONIC INVOICE(E-INVOICE AS PER GST LAW)
F-22	UNDERTAKING REGARDING SUBMISSION CONTRACT PERFORMANCE SECURITY (CPS) / SECURITY DEPOSIT (SD) WITHIN STIPULATED TIME LINE
F-23	PROFORMA FOR CONTRACT AGREEMENT
F-24	NO CLAIM CERTIFICATE

	EMERGENCY DIESEL GENERATOR PACKAGE TALCHER FERTILIZERS LIMITED, ODISHA (INDIA) MASTER INDEX	PC183/E-4022	0	
		DOC. NO.	REV.	
		SHEET 3 OF 3		

	Forms for Public Procurement (Preference to Make in India) Policy
FORM – I of Annexure V	Certificate from Statutory Auditor or Cost Auditor of the company (in the case of companies) or from a Practicing Cost Accountant or Practicing Chartered Accountant (in respect of suppliers other than companies) towards minimum local content
FORM-II of Annexure-V	Salient points of Public Procurement (Preference to Make in India) Policy
Annexure VI	PREAMBLE TO SCHEDULE OF RATES
	Forms related to Annexure-VII
Form of Annexure-VII	Undertaking on Letterhead
Section-IV	
4.0	General Conditions of Contract (GCC)
Section-V	
5.0	Special Conditions Of Contract (SCC)

CONTENTS (TECHNICAL)

SECTION-VI	DESCRIPTION
VI-1.0	PROJECT DESCRIPTION
VI-2.0	BIDDER'S SCOPE OF WORK
VI-3.0	DESIGN PHILOSOPHY
VI-3.1	❖ ELECTRICAL
VI-3.2	❖ MECHANICAL
VI-3.2.1	➤ EOT CRANE & HOIST
VI-4.0	PROJECT EXECUTION PLAN
VI-5.0	CONSTRUCTION / ERECTION, PRECOMMISSIONING, COMMISSIONING AND START – UP
VI-6.0	PERFORMANCE AND GUARANTEE TEST
VI-7.0	DRAWING & DOCUMENTS
VI-8.0	SPARE PARTS
VI-9.0	SITE WORKING AND SAFETY CONDITIONS
VI-10.0	VENDOR LIST

Section-VII	Schedule of Rates
--------------------	-------------------

SECTION-I

INVITATION FOR BID (IFB)

SECTION-I
"INVITATION FOR BID (IFB)"

Ref No: PNMM/PC-183/E-4022/NCB

Dated: 06.09.2023

To,

PROSPECTIVE BIDDERS

SUB: TENDER DOCUMENT FOR EMERGENCY DIESEL GENERATOR ON PACKAGE BASIS.

Dear Sir/Madam,

1.0 INTRODUCTION:

1.1 GAIL (India) Limited (GAIL), Rashtriya Chemicals & Fertilizers Limited (RCF), Coal India Limited (CIL) and Fertilizer Corporation of India Limited (FCIL) have formed a Joint Venture company in the name of Talcher Fertilizers Limited (TFL) hereinafter also referred to as "Owner", intends to carry out the work of **EMERGENCY DIESEL GENERATOR ON PACKAGE BASIS** for its Ammonia Urea Plant, an integrated fertilizer and chemical complex comprising of Coal Gasification and Gas Purification Unit, Ammonia Synthesis Unit, Urea Plant, along with necessary offsite and utility facilities at Talcher Unit, Angul district, in the state of Odisha, India.

1.2 GAIL (India) Limited is a Public Sector Unit under the Ministry of Petroleum & Natural Gas and Rashtriya Chemicals & Fertilizers Limited (RCF) & Fertilizer Corporation of India Limited (FCIL) are two Public Sector Units under the Ministry of Chemicals & Fertilizers and Coal India Limited (CIL) is a Public Sector Unit under the Ministry of Coal, Govt. of India.

1.3 Projects and Development India Limited (PDIL), hereinafter referred to as PROJECT MANAGEMENT CONSULTANT (PMC) on behalf of M/s Talcher Fertilizers Ltd. (TFL), hereinafter referred as OWNER, has the pleasure of inviting bids from eligible domestic bidders to submit Bid ONLINE through Central Public Procurement (CPP) Portal under Single Stage Two Bid System, for the subject works.

2.0 The brief details of the tender are as under:

(A)	NAME OF WORK / BRIEF SCOPE OF SERVICE/JOB	EMERGENCY DIESEL GENERATOR ON PACKAGE BASIS AT TALCHER FERTILIZERS LIMITED, ODISHA (INDIA)
(B)	NIT NO. & DATE	PNMM/PC-183/E-4022/NCB DATED 06.09.2023 ON OPEN DOMESTIC COMPETITIVE BIDDING BASIS

(C)	TYPE OF BIDDING SYSTEM	SINGLE BID SYSTEM	<input type="checkbox"/>
		TWO BID SYSTEM	<input checked="" type="checkbox"/>
(D)	TYPE OF TENDER	E-TENDER (CPP PORTAL)	<input checked="" type="checkbox"/>
		MANUAL	<input type="checkbox"/>
(E)	COMPLETION PERIOD	Please Refer Clause 20.0 of SPECIAL CONDITIONS OF CONTRACT.	
(F)	BID SECURITY /EARNEST MONEY DEPOSIT (EMD)	APPLICABLE	<input checked="" type="checkbox"/>
		NOT APPLICABLE	<input type="checkbox"/>
		EMD value: Rs.20 Lakhs (Rupees Twenty Lakh Only)	
		Exempted Bidders (i.e. MSEs, Start-ups and Govt Dept./PSUs) are required to submit declaration for Bid security as per Form F-2B (Refer clause no.16 of ITB).	
(G)	AVAILABILITY OF TENDER DOCUMENT ON WEBSITE(S)	(i) CPP Portal (https://eprocure.gov.in/eprocure/app) (ii) TFL Website - http://tflonline.co.in (iii) PDIL website - www.pdil.in	
(H)	LAST DATE OF RECEIPT OF BIDDER'S PRE-BID QUERIES	18.09.2023	
(I)	DATE, TIME OF PRE-BID MEETING (Through Video Conferencing)	21.09.2023 at 11:30 Hrs. (IST) Click here to join the meeting	
(J)	BID SUBMISSION START DATE	09.10.2023 at 15:00 Hrs (IST)	
(K)	BID CLOSING DATE	23.10.2023 at 15:00 Hrs. (IST)	
(L)	BID OPENING DATE	24.10.2023 at 15:00 Hrs. (IST)	

(M)	Address for Communication	
(i)	PDIL	<p>M/s Projects & Development India Limited, P.D.I.L Bhawan, A-14, Sector-1, Dist. Gautam Budh Nagar (UP). (India) Noida, (PIN 201301)</p> <p>Kind Attention: Mrs. Anjali Thakur Dy. General Manager (M.M) Fax no. : +91-120-2529801 Tel no. : +91-120-2544063 E-mail : anjali@pdilin.com alam@pdilin.com</p>
(ii)	TFL	<p>M/s Talcher Fertilizers Ltd. (TFL), C/O GAIL Training Institute, PARC Building, Plot No. 24, Sector-16A, Film City, Noida, District – G.B. Nagar, U.P. - 201301</p> <p>Kind Attention : Mr. S M Badruddoja DGM (Projects) Tel No. : +91-8859500094 E-mail : sm.badruddoja@gail.co.in; mannapaul@gail.co.in</p>
(N)	Original Documents to be submitted at	<p>Projects & Development India Limited, (Materials Management Department) P.D.I.L Bhawan, A-14, Sector-1, Gautam Budh Nagar (UP). (India) Noida 201301</p> <p>Kind Attention: Mrs. Anjali Thakur, Dy. General Manager (M.M) Fax no. : +91-120-2529801 Tel no. : +91-120-2544063. E-mail : anjali@pdilin.com</p>
(O)	Contact Person for Site visit	<p>M/s Talcher Fertilizers Ltd. (TFL), Administrative Building, Talcher, Post: Vikrampur Dist: Angul, Pincode-759106, Odisha</p> <p>Kind Attention: Mr. Satyabrata Mishra General Manager (Projects) Tel No. : +91-9927339444 E-mail : smishra@gail.co.in</p>

In case the days specified above happens to be a holiday in TFL/PDIL, the next working day shall be implied.

- 3.0 Bids must be submitted strictly in accordance with Clause No. 11 of ITB (Section-III of tender) depending upon Type of Tender as mentioned at Clause no. 2.0 (D) above. The IFB is an integral and inseparable part of the bidding document.

- 4.0 Bid must be submitted only on CPP Portal (<https://eprocure.gov.in/eprocure/app>). Further, the following documents in addition to uploading the bid on CPPP's Portal shall also be submitted in Original (in physical form) within 7 (seven) days(*) from the bid due date, provided the scanned copies of the same have been uploaded in e-tender by the bidder along with e-bid within the due date and time to the address mentioned in Clause no. 2.0 (M) of IFB:-
- i) EMD (for all bidders except exempted category) /Declaration for Bid Security (for exempted bidders)
 - ii) Power of Attorney
 - iii) Integrity Pact
 - iv) Original Letter of TPI as per Appendix-I at Section-II
 - v) Line of Credit (If applicable)
- 5.0 Bidder(s) are advised to quote strictly as per terms and conditions of the tender documents and not to stipulate any deviations/exceptions.
- 6.0 Any bidder, who meets the Bid Evaluation Criteria (BEC) and wishes to quote against this Tender Document, may download the complete Tender Document along with its amendment(s) if any from websites as mentioned at 2.0 (G) of IFB and submit their Bid complete in all respect as per terms & conditions of Tender Document on or before the Due Date & Time of Bid Submission.
- 7.0 Bid(s) received from bidders to whom tender/information regarding this Tender Document has been issued as well as offers received from the bidder(s) by downloading Tender Document from above mentioned website(s) shall be taken into consideration for evaluation & award provided that the Bidder is found responsive subject to provisions contained in Clause No. 2 of ITB (Section-III of tender).
- The Tender Document calls for offers on single point "Sole Bidder" responsibility basis (except where JV/Consortium bid is allowed pursuant to clause no. 3.0 of ITB) and in total compliance of Scope of Works as specified in Tender Document.
- 8.0 Any revision, clarification, corrigendum, time extension, etc. to this Tender Document will be hosted on the website(s) only as mentioned at 2.0 (G) of IFB. Bidders are requested to visit the CPP Portal regularly to keep themselves updated. No complaint/representation shall be entertained from bidders in case they do not see / download the amendments, etc. issued to the tender document by TFL from time to time on the CPP Portal.
- 9.0 All bidders including those who are not willing to submit their bid are required to submit F-6 (Acknowledgement cum Consent letter) duly filled within 7 days from date of receipt of tender information.

This is not an Order.

Thanking You,
For and on behalf of
Talcher Fertilizers limited

(Anjali Thakur)

Dy. General Manager (M.M)
Projects & Development India Limited

PHYSICAL DOCUMENTS (EMD/Declaration for Bid Security, POA, Integrity Pact & Original Letter of TPI)

Tender Document No. : PNMM/PC-183/E-4018/NCB dated 13.03.2023

**Description : EMERGENCY DIESEL GENERATOR ON PACKAGE BASIS
AT TALCHER FERTILIZERS LIMITED, ODISHA (INDIA)**

Due Date & Time : 23.10.2023 at 15:00 hrs.

From:	To: M/s Projects & Development India Limited, P.D.I.L Bhawan, A-14, Sector-1, Noida, (PIN 201301) Dist. Gautam Budh Nagar (UP). (India) Kind Attention: Mrs. Anjali Thakur, Dy. General Manager (M.M)
--	---

(To be pasted on the envelope containing Physical Document)



SECTION-II

BID EVALUATION CRITERIA

&

EVALUATION METHODOLOGY

SECTION-II

1.0 BID EVALUATION CRITERIA (BEC) FOR SINGLE BIDDER

Bids are hereby invited from competent Domestic Bidders meeting the technical and financial criteria of respective BEC stated hereunder.

Evaluation of Techno-Commercial offers shall be carried out for only those Bidders who shall meet the BEC.

(A) Technical Criteria:

A.1 The bidder must have completed “**Similar work**“ during the last seven (07) years reckoned from the original bid due date.

“**Similar work**” shall mean the following:

Supply, installation/erection and testing/commissioning of 11 kV, 2000 KVA or higher rating of Diesel Generator Set

OR

Supply, supervision of installation/erection and testing/commissioning of 11 kV, 2000 KVA or higher rating of Diesel Generator Set

Bidder meeting the criteria above must have completed

The bidder must have completed One “**Similar work**”, having completed value not less than **INR 11.22 Crore** (including all applicable taxes & duties).

(OR)

The bidder must have completed Two “**Similar works**”, each having completed value not less than **INR 7.01 Crore** (including all applicable taxes & duties).

(OR)

The bidder must have completed Three “**Similar works**”, each having completed value not less than **INR 5.61 Crore** (including all applicable taxes & duties).

Note:

In case bidder has executed and completed composite works which includes any of the qualifying works(s) stated above i.e. (A.1), then value of such qualifying works out of the total value of composite works shall be considered for the purpose of qualification.

A.2 The said “**Similar Work**” referred at **A.1 above** must have been in operation for at least 1 (one) year reckoned on the original bid due date from the Date of Acceptance / Commissioning of the works.

A.3 Applicability of Policy for providing preference to Domestically Manufactured Iron & Steel (DMI & SP) products.

Bidder should have minimum prescribed domestic value addition requirement in line with the Domestic Manufactured iron & Steel Policy (DMI & SP) for the Iron & Steel products involved in execution of the contract. Bidder shall submit affidavit from the domestic manufacturers of such Iron & steel products as per the Form-I mentioned in the policy document.

A bidder who is not manufacturer of Iron & Steel product and is unable to submit the Affidavit from domestic manufacturers at bidding stage, such bidder can submit the Affidavit issued by domestic manufacturers after placement of order. In this case bidder along with his bid shall submit an undertaking as per attached format in NIT.

If a bidder does not submit above affidavit/ undertaking as per format, the offer of bidder shall be rejected.

Notes for A.1 & A.2 above:

- I. Job completed by a Bidder for its own plant/ project cannot be considered as experience for the purpose of meeting BEC of the tender. However, jobs completed for Subsidiary/ Fellow subsidiary/ Holding company will be considered as experience for the purpose of meeting BEC subject to submission of tax paid invoice(s) duly certified by Statutory Auditor of the Bidder towards payments of statutory tax in support of the job completed for Subsidiary/ Fellow subsidiary/ Holding company. Such Bidders to submit these documents in addition to the documents specified to meet BEC.
- II. The bidder must submit the completion certificate/acceptance certificate issued by end user/ owner (or their consultant who has been duly authorized by them to issue such certificate) only after completion of work/ supply in all aspects.
- III. Only documents (Work order, completion certificate, execution certificate etc.) which have been referred /specified in the bid shall be considered in reply to the queries during evaluation of bids.
- IV. In case more than one contract/order/agreement/DLOA are emanating against same tender, these contracts are to be considered as single contract for evaluation of credentials of a bidder for meeting their experience criteria.
- V. Experience of bidder acquired as a sub-contractor is acceptable against submission of certificate from end user by such bidder along with other specified documents.
- VI. Bids from Consortium / Joint Venture is not acceptable

(B) Financial Criteria:

B.1 The Average Annual financial Turnover during the three (03) preceding financial years of the bidder should be minimum **INR 7.01 Crore.**

B.2 Net Worth of the bidder should be positive as per last audited financial year.

B.3 The Bidder should have minimum working capital equal to **INR 1.68 Crore** as per last audited financial year. However, if the bidder's working capital is negative or inadequate, the bidder shall submit a letter from their Bank having Net worth of the bank not less than Rs. 100.0 Crore (or equivalent USD), confirming the availability of line of credit for **INR 1.68 Crore**. The line of credit from bank shall be submitted strictly as per prescribed format.

“Notes for B.1, B.2 & B.3”

Annual Turnover: Preceding 3 financial years mentioned in aforesaid BEC refer to immediate 3 preceding financial years wherever the closing date of the bid is after 30th September of the relevant financial year. In case the tenders having the due date for submission of bid up to 30th Sep. of the relevant financial year, and audited financial results of the immediate 3 preceding financial years are not available, the audited financial results of the 3 years immediately prior to that will be considered.

Net Worth/Working Capital: Immediate preceding financial year mentioned in aforesaid BEC refer to audited financial results for the immediate preceding financial year wherever the closing date of the bid is after 30th September of the relevant financial year. In case the tenders having the due date for submission of bid up to 30th Sep. of the relevant financial year, and audited financial results of the immediate preceding financial year is not available, in such case the audited financial results of the year immediately prior to that year will be considered. Bidder is to submit Audited Financial Statement of immediate preceding financial years (as mentioned above) along with format F-10 accordingly for Network / Working Capital.

Any shortfall information / documents on the Audited Annual Report / Financial Statement of the Bidder and/or line of credit for working capital issued on or before the final bid due date can only be sought against Commercial queries (CQs). Any information/ documents issued post final bid due date shall not be considered for evaluation.

2.0 General Notes (for both Technical BEC and Financial BEC) wherever applicable:

Exchange rate for conversion of currency for evaluation of documents relating to BEC (if applicable):

Exchange rate for Conversion of Currency for evaluation of documents submitted by bidders for BEC which are in a currency other than INR, shall be as follows:

- a) **BEC (Technical):** Bill Selling (foreign exchange) Rate of State Bank of India as prevailing on the date of award of order / contract submitted by bidder.
- b) **BEC (Financial)**
 - (i) **For Annual Turnover:** The average of Bill Selling (foreign exchange) Rate of State Bank of India as prevailing on the First date and Last date of the respective Financial Year.

- (ii) **For Net Worth & Working Capital:** The Bill Selling (foreign exchange) Rate of State Bank of India as prevailing on the Last date of the respective Financial Year
- c) In case, the SBI Selling rate is not available as on the date of conversion as specified above for respective cases, the exchange rate for conversion of currency shall be taken from the internet, such as -

<https://www.xe.com/currencyconverter>

<https://economictimes.indiatimes.com/markets/forex/currency-converter>

<https://www.oanda.com/currency/converter>

3.0 BEC for START-UPS:

The Technical and Financial BEC as stipulated above shall also be applicable for start-ups.

4.0 Documents to be submitted for Compliance to BEC

(i) Technical Criteria of BEC:

To meet the criteria of **A.1** above, Bidder must submit copy of Detailed Letter of Acceptance (DLOA) / Work Order /relevant extract of work Order/ Contract Agreement along with detailed scope of work and Completion / Acceptance Certificate. Such certificate shall be issued by order issuing authority/ Owner/End user.

The Detailed Letter of Acceptance (DLOA) / Work Order / Contract Agreement must *inter alia* include Scope of work, completion time, contract value, etc. Similarly, the Completion Certificate/ Acceptance Certificate must clearly indicate reference of relevant work order/DLOA/Contract Agreement, Name of Work, Completed order value and date of completion.

To meet the criteria of **A.2** above, a certificate in respect of minimum one year successful operation of the Plant/System from the date of acceptance/Commissioning of work issued by the Owner/End user.

In cases where bidder has executed the work as a sub-contractor, such Completion certificate and Operation certificates (for compliance to **A.1** and **A.2** above) issued by the "Order issuing Authority" is also acceptable, provided that a certificate or letter from End User/Owner is submitted certifying that the bidder has worked as a sub-contractor for that project.

To meet the criteria **A.3** above, Bidder shall submit affidavit from the domestic manufacturers of Iron & steel products as per the Form-I enclosed with the policy documents. A bidder who is not manufacturer of Iron & Steel product and is unable to submit the Affidavit from domestic manufacturers at bidding stage, such bidder can submit the Affidavit issued by domestic manufacturers after placement of order. In this case bidder along with his bid shall submit an undertaking as per prescribed format.

(ii) Financial Criteria of BEC:

- (a) To meet the criteria for Sr. No. **B.1**, Bidder shall submit the Audited Financial Statements of the company for last preceding three (03) financial years.
- (b) To meet the criteria for Sr. No. **B.2**, Bidder shall submit the Audited Financial Statements of the last financial year.
- (c) To meet the criteria for Sr. No. **B.3**, Bidder shall submit the Audited Financial Statements of last financial year along with (i) Bank's Letter (if applicable)
- (d) If the bidder's working capital is negative or inadequate, the bidder shall submit a letter from their bank having net worth not less than Rs.100 Crores (or equivalent USD), confirming the availability of line of credit for working capital amount mentioned herein above. The line of credit letter from bank to be submitted strictly as per prescribed format.

For 4 (ii) above, the "Notes for B.1, B.2 & B.3 under B" (Financial Criteria of BEC) shall apply.

- (iii) Bidder shall submit Checklist as per prescribed format in respect of documents to be submitted by bidder towards BEC.

5.0 Authentication of documents submitted against BEC

(i) Technical BEC

All documents in support of Sl. No. A.1 & A.2 of Technical Criteria of BEC to be furnished by the Bidder shall necessarily be duly certified/attested by Chartered Engineer as well as Notary Public with legible stamp.

(I) Financial BEC

Bidder shall submit "Details of financial capability of Bidder" in prescribed format (F-10) duly signed and stamped by a chartered accountant/ Certified Public Accountant (CPA).

Further, copy of audited annual financial statements submitted in bid shall be duly certified/ attested by Notary Public with legible stamp.

6.0 EVALUATION METHODOLOGY:

The subject work is indivisible and complete work shall be awarded to successful overall lowest bidder as per evaluation methodology described below.

The Evaluation methodology shall be arrived as per following.

- i. The TOTAL CONTRACT PRICE (Including all taxes, duties, levies and GST) as derived from the SCHEDULE OF PRICES as quoted by the Bidder.
- ii. In case any cess on GST is applicable, same shall also be considered in evaluation.
- iii. In case any unregistered bidder is submitting their bid, their prices will be loaded with applicable GST (CGST & SGST/UTGST or IGST) while evaluation of bid (if applicable as per Govt. Act/Law in vogue).
- iv. The Price Evaluation will be subject to applicability of Purchase Preference Policies as mentioned in the tender document.

7.0 Applicability of Public Procurement (Make in India) Policy

The said policy shall be applicable for this package. Further, as the work is non divisible/non-splittable, therefore, the relevant provisions of policy shall be applicable. The minimum local content and all other provisions shall be as per Public Procurement (Make in India) Policy latest policy no. P-45021/2/2017-PP (BE-II) dated 16th September, 2020 or as updated from time to time.

8.0 Applicability of purchase preference of MSE's

Considering that the subject work falls under "Works Contract", Purchase preference to MSE Bidders shall not be applicable as per government guidelines.

Deleted

**POLICY FOR PROVIDING PREFERENCE TO DOMESTICALLY
MANUFACTURED IRON & STEEL PRODUCTS
IN GOVERNMENT PROCUREMENT**



भारत का राजपत्र The Gazette of India

असाधारण

EXTRAORDINARY

भाग II—खण्ड 3—उप-खण्ड (i)

PART II—Section 3—Sub-section (i)

प्राधिकार से प्रकाशित

PUBLISHED BY AUTHORITY

सं. 324]

नई दिल्ली, बुधवार, मई 29, 2019/ज्येष्ठ 8, 1941

No. 324]

NEW DELHI, WEDNESDAY, MAY 29, 2019/JYAISTHA 8, 1941

इस्पात मंत्रालय

अधिसूचना

नई दिल्ली, 29 मई, 2019

सा.का.नि. 385(अ).—घरेलू रूप से उत्पादित किए जाने वाले लौह एवं स्टील उत्पाद की सरकारी खरीद को प्राथमिकता दिए जाने के लिए संशोधित नीति सामान्य सूचना हेतु प्रकाशित की जाती है।

[फा. सं. 3(2)/2018-आईडीडी]

रसिका चौबे, अपर सचिव

सरकारी खरीद में घरेलू स्तर पर निर्मित लौह एवं इस्पात उत्पादों को बरीयता देने के लिए नीति - संशोधित, 2019

1. भूमिका

- 1.1 यह नीति सरकारी खरीद में घरेलू स्तर पर निर्मित लौह एवं इस्पात उत्पादों (डी एम आई एंड एस पी) को बरीयता देती है।
- 1.2 यह नीति यथा लागू निर्धारित गुणवत्ता मानदंडों के अनुपालन में उत्पादित लौह एवं इस्पात उत्पादों जिसे परिशिष्ट क में दिया गया है और परिशिष्ट ख में दिए गए लौह एवं इस्पात उत्पादों के लिए पूंजीगत माल पर लागू होती है।
- 1.3 यह नीति सरकार के प्रत्येक मंत्रालय अथवा विभाग और उनके प्रशासनिक नियंत्रण के अधीन सभी एजेंसियों/प्रतिष्ठानों तथा सरकारी परियोजनाओं के वास्ते लौह एवं इस्पात उत्पादों की खरीद के लिए इन एजेंसियों द्वारा वित्त पोषित परियोजनाओं पर लागू है। हालांकि, यह नीति वाणिज्यिक पुनः बिक्री के उद्देश्य से अथवा वाणिज्यिक बिक्री के लिए वस्तुओं के उत्पादन में उपयोग करने के उद्देश्य से लौह एवं इस्पात उत्पादों की खरीद पर लागू नहीं होगी।

2. परिभाषाएं

- 2.1 **बोली** लगाने वाला लौह एवं इस्पात का कोई घरेलू/विदेशी निर्माता अथवा उनके बिक्री एजेंट/अधिकृत वितरक/अधिकृत डीलर/अधिकृत आपूर्ति गृह अथवा सरकारी एजेंसियों द्वारा वित्त पोषित निधि परियोजनाओं की बोली लगाने में कार्यरत कोई अन्य कंपनी हो सकती है।

- 2.2 **घरेलू स्तर पर निर्मित लौह एवं इस्पात उत्पाद (डी एम आई एंड एस पी)** वे लौह एवं इस्पात उत्पाद हैं जिनका निर्माण उन प्रतिष्ठानों द्वारा किया जाता है जो भारत में पंजीकृत और स्थापित हैं, जिसमें विशेष आर्थिक क्षेत्र (एम ई ज़ेड) शामिल है। इसके अलावा, इस प्रकार के उत्पाद परिशिष्ट क में किये गये उल्लेख के अनुसार घरेलू न्यूनतम मूल्यवर्धन के मानदंडों को पूरा करेंगे।
- 2.3 **घरेलू निर्माता** खंड 7 में दिशा-निर्देशों और केंद्रीय उत्पाद शुल्क अधिनियम में दी गई 'निर्माता' की परिभाषा के अनुरूप लौह एवं इस्पात उत्पादों का एक निर्माता है।
- 2.4 इस नीति के प्रयोजन से **सरकार** का तात्पर्य भारत सरकार से है।
- 2.5 **सरकारी एजेंसियों** में सरकार के सार्वजनिक क्षेत्र के उपक्रम, सरकार द्वारा स्थापित सोसायटी, ट्रस्ट और सांविधिक निकाय शामिल हैं।
- 2.6 **एम ओ एस** का आशय इस्पात मंत्रालय, भारत सरकार से है।
- 2.7 **निवल बिक्री कीमत** बीजक कीमत होगी जिसमें निवल घरेलू कर और शुल्क शामिल नहीं होंगे।
- 2.8 **अर्ध तैयार इस्पात** का तात्पर्य इनगोट्स, बिलेट, ब्लूम और स्लेब्स से है, जिसे बाद में प्रसाधित कर तैयार इस्पात बनाया जा सकता है।
- 2.9 **तैयार इस्पात** का तात्पर्य सपाट और लंबे उत्पादों से होगा जिन्हें बाद में प्रसाधित कर निर्मित मद बनाया जा सकता है।
- 2.10 **एल1** का तात्पर्य निविदा अथवा अन्य खरीद संबंधी अनुरोध के अनुसार मूल्यांकन प्रक्रिया में यथाघोषित निविदा, बोली लगाने संबंधी प्रक्रिया अथवा अन्य खरीद संबंधी अनुरोधों में प्राप्त निम्नतम निविदा अथवा निम्नतम बोली अथवा निम्नतम भाव से होगा।
- 2.11 **खरीद वरीयता के मार्जिन** का तात्पर्य उस अधिकतम सीमा से है जिस सीमा तक किसी घरेलू आपूर्तिकर्ता द्वारा लगाई गई कीमत खरीद वरीयता के प्रयोजन से एल1 से अधिक हो। डी एम आई एंड एस पी नीति के मामले में, खरीद वरीयता का मार्जिन परिशिष्ट ख में मदों के लिए 20 प्रतिशत होगा।
- 2.12 **लौह एवं इस्पात उत्पाद** का तात्पर्य ऐसे लौह एवं इस्पात उत्पादों से होगा जिनका उल्लेख परिशिष्ट क में किया गया है।
- 2.13 **घरेलू मूल्यवर्धन** निवल बिक्री कीमत (निवल घरेलू करों और शुल्कों को छोड़कर बीजक कीमत) होगी जिससे प्रतिशत में निवल बिक्री कीमत के एक अनुपात के रूप में भारत में निर्माण संयंत्र (सभी सीमा शुल्कों सहित) में आयात की गई इनपुट सामग्री की पहुंच लागत घटाई गई हो, 'घरेलू मूल्यवर्धन' परिभाषा डी पी आई आई टी (पूर्व में डी आई पी पी) के दिशानिर्देशों के अनुरूप होगी और उसमें भविष्य में डी पी आई आई टी द्वारा परिवर्तन किये जाने की स्थिति में उपयुक्त रूप से संशोधन किया जाएगा। इस नीति दस्तावेज के प्रयोजन के लिए घरेलू मूल्यवर्धन और स्थानीय विषय वस्तु का उपयोग एक दूसरे के स्थान पर किया गया है।
- 3. अपवर्जन**
- 3.1 इस्पात मंत्रालय द्वारा इस प्रकार की सभी सरकारी खरीदों के लिये निम्नलिखित शर्तों के अधीन छूट प्रदान की जाएगी।
- 3.1.1 जहां विशिष्ट शेडों के इस्पात का निर्माण इस देश में नहीं किया जाता हो, अथवा
- 3.1.2 जहां परियोजना की मांग के अनुसार इन मात्राओं को घरेलू स्रोतों के माध्यम से पूरा नहीं किया जा सकता हो।
- अपवर्जन संबंधी अनुरोधों को घरेलू स्तर पर निर्मित लौह एवं इस्पात उत्पादों के उपलब्ध न होने के पर्याप्त प्रमाण के साथ स्थायी समिति को प्रस्तुत किया जाएगा।
- 4. स्थायी समिति**
- इस नीति के कार्यान्वयन का पर्यवेक्षण करने के लिए इस्पात मंत्रालय (एम ओ एस) के अधीन एक स्थायी समिति का गठन किया जाएगा। जिसके अध्यक्ष सचिव इस्पात होंगे। इस समिति में उद्योग/उद्योग संघ/सरकारी संस्था अथवा निकाय/इस्पात मंत्रालय (एम ओ एस) से लिए गए विशेषज्ञ होंगे। इस्पात मंत्रालय में उक्त समिति के पास निम्नलिखित के लिए अधिदेश होगा :
- 4.1 इस नीति के कार्यान्वयन की मॉनीटरिंग करना
- 4.2 परिशिष्ट क और परिशिष्ट ख में यथा उल्लिखित लौह एवं इस्पात उत्पादों की सूची और घरेलू बिक्री वर्धन की आवश्यकता से संबंधित मानदंडों की समीक्षा करना और उसे अधिसूचित।

- 4.3 खंड 3 के अनुसार खरीद एजेंसियों को अपवर्जन की स्वीकृति देने सहित इस नीति के कार्यान्वयन के लिए आवश्यक स्पष्टीकरण जारी करना।
- 4.4 शिक्कायत निवारण करने के लिए एक अलग समिति का गठन करना।
- 4.5 स्थायी समिति इस्पात मंत्रालय को अनुमोदन हेतु अपनी सिफारिशें प्रस्तुत करेगी।
- 5. सरकार द्वारा खरीदे जाने वाले लौह एवं इस्पात उत्पादों को अधिसूचित करना**
- 5.1 निम्नलिखित दिशानिर्देशों का उपयोग इस नीति के अंतर्गत उपरोक्त उत्पादों की पहचान करने और उमें अधिसूचित करने के लिए किया जा सकता है :
- 5.1.1 यह नीति परिशिष्ट क में दिए गए अनुसार लौह एवं इस्पात उत्पादों और परिशिष्ट ख में लौह एवं इस्पात उत्पादों का निर्माण करने के लिए पूंजीगत माल पर लागू है।
- 5.1.2 परिशिष्ट क में लौह एवं इस्पात उत्पादों की सूची दी गई है जिसका निर्माण अनन्य रूप से घरेलू स्तर पर किया जाना है और उसका आयात इस्पात मंत्रालय के अनुमोदन के बिना नहीं किया जा सकता है।
- 5.1.3 परिशिष्ट ख में पूंजीगत माल की एक सूची (जो विस्तृत नहीं है) दी गई है जिसके लिए खरीद संबंधी बरीयता घरेलू स्तर पर निर्मित पूंजीगत माल को दी जाएगी, यदि उनकी दी गई कीमत सदृश्य आयात किये गये पूंजीगत माल के लिए दी गई कीमत के 20 प्रतिशत के अंदर आती हो।
- 5.1.4 इस नीति का उद्देश्य सभी लौह एवं इस्पात उत्पादों को अधिसूचित करना है जिसकी खरीद सरकारी एजेंसियों द्वारा सरकारी परियोजनाओं के लिए की जाती है और न कि वाणिज्यिक पुनः बिक्री के उद्देश्य से अथवा वाणिज्यिक बिक्री के लिए उत्पादों के उत्पादन में प्रयोग करने के उद्देश्य से की गई हो।
- 5.1.5 यह नीति सरकार के मंत्रालय अथवा विभाग के द्वारा निधि प्रदत्त सभी परियोजनाओं और उनके प्रशासनिक नियंत्रण के अधीन सभी एजेंसियों/प्रतिष्ठानों पर लौह एवं इस्पात उत्पादों की खरीद के लिए लागू है।
- 5.1.6 यह नीति उन परियोजनाओं पर लागू होगी जहां लौह एवं इस्पात उत्पादों का खरीद मूल्य 25 करोड़ रुपए से अधिक होता हो। यह नीति अन्य खरीद (गैर परियोजना) के लिए भी लागू होगी जहां उस सरकारी संगठन के लिए लौह एवं इस्पात उत्पादों का वार्षिक खरीद मूल्य 25 करोड़ रुपए से अधिक होता हो।
- 5.1.7 यह नीति सरकार के मंत्रालय अथवा विभाग अथवा उनके सार्वजनिक क्षेत्र के उपक्रमों की किसी अन्य आवश्यकता को पूरा करने के लिए और/अथवा ई पी सी संविदा को पूरा करने के लिए प्राइवेट एजेंसियों द्वारा लौह एवं इस्पातों की खरीद पर लागू है।
- 5.1.8 घरेलू लौह एवं इस्पात उत्पादों के विभिन्न ग्रेडों की उपलब्धता का विश्लेषण इस नीति के अंतर्गत अधिसूचित करने से पहले करना होगा। केवल उन लौह एवं इस्पात को उत्पादों को जिनके संबंध में कम से कम एक घरेलू निर्माता मौजूद हो, अधिसूचित किया जाएगा। स्थायी समिति से परामर्श किया जा सकता है।
- 5.1.9 यह नीति यथा लागू निर्धारित गुणवत्ता मानदंडों के अनुपालन में उत्पादित परिशिष्ट ख में दिए गए लौह एवं इस्पात उत्पादों का निर्माण करने के लिए पूंजीगत माल के लिए लागू है।
- 5.1.10 लौह एवं इस्पात उत्पादों का निर्माण करने के लिए पूंजीगत मालों की घरेलू खरीद के लिए नीति लौह एवं इस्पात उत्पादों का निर्माण करने के लिए और न कि वाणिज्यिक पुनः बिक्री के उद्देश्य से पूंजीगत मालों की खरीद के वास्ते और सार्वजनिक क्षेत्र के इस्पात विनिर्माताओं और उनके प्रशासनिक नियंत्रणाधीन सभी एजेंसियों/प्रतिष्ठानों पर लागू है।
- 5.1.11 यह नीति ई पी सी संविदा और/अथवा सार्वजनिक क्षेत्र से इस्पात निर्माताओं और उनके प्रशासनिक नियंत्रण के अधीन सभी एजेंसियों/प्रतिष्ठानों की किसी अन्य आवश्यकता को पूरा करने के लिए निजी एजेंसियों द्वारा लौह एवं इस्पात उत्पादों का निर्माण करने के लिए पूंजीगत माल की खरीद पर लागू है।
- 5.1.12 सरकारी एजेंसियां जो लौह एवं इस्पात उत्पादों के निर्माण के लिए पूंजीगत माल और लौह एवं इस्पात उत्पादों की खरीद में उन स्थितियों में शामिल है जहां लौह एवं इस्पात उत्पादों का उल्लेख परिशिष्ट क और परिशिष्ट ख में नहीं किया गया हो, स्थायी समिति को निर्धारित मानदंडों के साथ इस उत्पाद के विवरण और तकनीकी विनिर्देशन उपलब्ध करायेगा। स्थायी समिति खंड 3 और खंड 4 में अधिदेश के अनुसार कार्य करेगी।

- 5.2 इस्पात मंत्रालय (एम ओ एम) परिशिष्ट क में दिए गए न्यूनतम निर्धारित घरेलू मूल्यवर्धन के साथ लौह एवं इस्पात उत्पादों को अधिसूचित करेगा।
- 5.3 लौह एवं इस्पात उत्पादों का निर्माण करने के लिए पूंजीगत माल के संबंध में नीतिगत दिशानिर्देश, परियोजना के आकार पर विचार किये बिना परिशिष्ट ख में लौह एवं इस्पात उत्पादों का निर्माण करने के लिए पूंजीगत माल की सभी खरीदों के लिए सार्वजनिक क्षेत्र के इस्पात निर्माताओं पर लागू होंगे।
- 5.4 परिशिष्ट क में लौह एवं इस्पात उत्पादों के लिए तथा परिशिष्ट ख में लौह एवं इस्पात उत्पादों का निर्माण करने के लिए पूंजीगत माल के लिए सुझाव दिए गए न्यूनतम घरेलू मूल्यवर्धन आवश्यकता घरेलू आपूर्तिकर्ता का आधार, आपूर्तिकर्ताओं की संख्या और खपत की तुलना में आयात का अनुपात जैसे कारकों के आधार पर तय किया गया है।
- 5.5 घरेलू मूल्यवर्धन आवश्यकता संबंधी मानदंडों का इस प्रकार से निर्धारण किया जाएगा जिस से कि यह किमी दिए गए समय में लौह एवं इस्पात उत्पादों के लिए घरेलू उद्योग की औसत/औसत से अधिक निर्माण क्षमता दर्शाता हो। स्थायी समिति द्वारा समय समय पर उपयुक्त रूप से इसकी समीक्षा की जाएगी और आवश्यकता पड़ने पर इस्पात मंत्रालय के अनुमोदन से इसमें संशोधन किया जाएगा।
- 6. सरकार एवं सरकारी एजेंसियों द्वारा खरीद के लिए निविदा प्रक्रिया**
- 6.1 खरीद करने वाली/सरकारी एजेंसियां डी एम आई एंड एस पी का पालन करते समय वित्त मंत्रालय और सी वी सी के अनुदेशों के अनुसार मानक खरीद संबंधी प्रक्रियाओं का पालन करेगी। यह नीति सभी निविदाओं जहां कीमत बोली नहीं खोली गई है, में इसके अधिसूचना की तिथि से लागू होगी।
- 6.2 दोनों वस्तुओं की खरीद तथा ई पी सी संविदाओं के लिए निविदा दस्तावेज में लौह एवं इस्पात उत्पादों का निर्माण करने के लिए लौह एवं इस्पात उत्पादों तथा पूंजीगत माल (जैसा कि परिशिष्ट क और परिशिष्ट ख में दर्शाया गया है, के लिए बोली लगाने वाले द्वारा न्यूनतम निर्धारित घरेलू मूल्यवर्धन का पालन करने के लिए अर्हता मानदंडों का स्पष्ट उल्लेख होना चाहिए।
- 6.3 घरेलू उत्पादों के विकास का सहयोग करने में, लौह एवं इस्पात व्यापार क्रियाकलापों में घरेलू मूल्यवर्धन का लक्ष्य निर्धारित किया गया है जिसे परिशिष्ट क और परिशिष्ट ख में दिया गया है।
- 6.4 परिशिष्ट क में लौह और इस्पात उत्पादों के खरीद की प्रक्रिया केवल उन निर्माताओं/आपूर्तिकर्ताओं के लिए ही खुली रहेगी जिसमें घरेलू मूल्यवर्धन लक्ष्यों को पूरा करने/उमसे ज्यादा पूरा करने की क्षमता हो। घरेलू मूल्यवर्धन लक्ष्यों को पूरा न करने वाले निर्माता/आपूर्तिकर्ता बोली लगाने में भाग लेने के लिए पात्र नहीं हैं।
- 6.5 परिशिष्ट ख में दी गई मदों के मामलों में, यदि खरीद करने वाली कंपनी की राय में, निविदाओं (खरीदी गई मात्रा) को 50:50 के निर्धारित अनुपात में नहीं बांटा जा सकता है, तब उनके पास मात्रा जो 50 प्रतिशत से कम नहीं हो, जो कि विभाज्य हो, के लिए पात्र घरेलू निर्माता को संविदा देने का अधिकार होगा।
- 6.6 उपर्युक्त शर्त को जारी रखते हुए, परिशिष्ट ख की मदों के लिए, यदि निविदा दी गई मद विभाज्य न हो (खरीद करने वाली कंपनी द्वारा निविदा दस्तावेज में शामिल किए जाने के लिए) यह संविदा समग्र मात्रा के लिए पात्र घरेलू निर्माता को दी जा सकती है।
- 6.7 परिशिष्ट ख के मदों के मामलों में, यदि घरेलू मूल्यवर्धन की आवश्यकताओं को पूरा करने वाले पात्र निर्माताओं में से कोई भी एल1 की बोली के अनुरूप न हो, तब एल1 की बोली धारण करने वाले मूल बोली लगाने वाला खरीद के पूर्ण मूल्य के लिए आदेश प्राप्त करेंगे।
- 6.8 वे बोली लगाने वाले जो लौह एवं इस्पात उत्पादों के घरेलू निर्माताओं के बिक्री एजेंट/अधिकृत वितरक/अधिकृत डीलर/अधिकृत आपूर्ति गृह हैं इस नीति के अंतर्गत घरेलू निर्माताओं की ओर से बोली लगाने के लिए पात्र हैं। हालांकि, यह निम्नलिखित शर्तों के अध्वधीन होगा।
- 6.8.1 बोली लगाने वाले घरेलू स्तर पर निर्मित लौह एवं इस्पात उत्पादों की बिक्री करने के लिए घरेलू निर्माता द्वारा जारी किए गए अधिकार प्रमाण पत्र प्रस्तुत करेगा।

- 6.8.2 यदि खरीद को डी एम आई एंड एम पी नीति के परिशिष्ट क के अंतर्गत शामिल किया गया हो तब बोली लगाने वाला यह घोषणा करते हुए खरीद करने वाली एजेंसी को घरेलू निर्माता द्वारा जारी किया गया स्व-प्रमाणन का शपथ पत्र प्रस्तुत करेगा कि लौह और इस्पात उत्पादों का घरेलू स्तर पर निर्माण निर्धारित घरेलू मूल्यवर्धन के मामले में किया जाता है।
- 6.8.3 यदि खरीद को डी एम आई एंड एम पी नीति के परिशिष्ट ख के अंतर्गत शामिल किया गया हो तब बोली लगाने वाला यह घोषणा करते हुए घरेलू निर्माता को सांविधिक लेखा परीक्षक द्वारा जारी किया गया प्रमाणन प्रस्तुत करेगा कि लौह और इस्पात उद्योग में उपयोग किये जाने वाले पूंजीगत माल का घरेलू स्तर पर निर्माण निर्धारित घरेलू मूल्यवर्धन के मामले में किया जाता है।
- 6.8.4 बोली लगाने वाले की यह जिम्मेदारी होगी कि वह इस नीति के अनुसार खरीद करने वाली एजेंसी को घरेलू निर्माता द्वारा जारी किये जाने के लिए अपेक्षित अन्य आवश्यक दस्तावेज प्रस्तुत करे।

7. घरेलू मूल्यवर्धन आवश्यकता

- 7.1 घरेलू रूप में निर्मित लौह और इस्पात उत्पाद अथवा पूंजीगत माल के रूप में उत्पाद के रूप में पात्र होने के लिए न्यूनतम घरेलू मूल्यवर्धन आवश्यकता का उल्लेख परिशिष्ट क और परिशिष्ट ख में किया गया है।
- 7.2 घरेलू मूल्यवर्धन निवल बिक्री कीमत (निवल घरेलू करों और शुल्कों को छोड़कर बीजक कीमत) होगी जिसमें से प्रतिशत में निवल बिक्री कीमत के एक अनुपात के रूप में भारत में निर्माण करने वाले संयंत्र में आयात की गई इनपुट सामग्री की पहुंच लागत (सभी सीमा शुल्कों को शामिल करते हुए) घटाई जाएगी।
- 7.2.1 यदि लौह और इस्पात उत्पादों को घरेलू इनपुट इस्पात (अर्ध तैयार/तैयार इस्पात) का उपयोग करके निर्माण किया जाता हो, तब खरीदी गई मात्रा और अन्य संबंधित दस्तावेजों के साथ वास्तविक घरेलू उत्पादों से खरीद का बीजक खरीद करने वाली सरकारी एजेंसी को अवश्य प्रस्तुत किया जाना चाहिए।
- 7.2.2 यदि लौह एवं इस्पात उत्पादों ने इनपुट इस्पात का आयात किया हो तब खरीदी गई मात्रा और अन्य संबंधित दस्तावेजों के साथ वास्तविक उत्पादकों से खरीदों के बीजकों को अलग से प्रस्तुत किया जाना चाहिए। घरेलू मूल्यवर्धन की सीमा निकालने के लिए, दोनों इनपुट इस्पातों (आयात किये और घरेलू) की भारित औसत पर विचार यह सुनिश्चित करने के लिए किया जाएगा कि इस नीति की न्यूनतम निर्धारित घरेलू मूल्यवर्धन आवश्यकता का पालन किया गया है।
- 7.3 यह सिफारिश की जाती है कि निविदा की प्रक्रिया में भाग लेने वाले प्रत्येक बोली लगाने वाले को नीचे दिए गए सूत्र का उपयोग करते हुए घरेलू मूल्यवर्धन की गणना करनी चाहिए ताकि यह सुनिश्चित किया जा सके कि दावा किये गये घरेलू मूल्यवर्धन इस नीति के न्यूनतम निर्धारित घरेलू मूल्यवर्धन के अनुरूप है।

लौह एवं इस्पात उत्पादों के लिए

% घरेलू मूल्यवर्धन

$$= \frac{\text{अंतिम उत्पाद की निवल बिक्री कीमत} - \text{संयंत्र में आयात किये गये लौह अथवा इस्पात की पहुंच लागत}}{\text{अंतिम उत्पाद की निवल बिक्री कीमत}} \times 100\%$$

पूंजीगत माल के लिए

% घरेलू मूल्यवर्धन

$$= \frac{\text{अंतिम उत्पाद की निवल बिक्री कीमत} - \text{संयंत्र में आयात किये गये इनपुट सामग्री की पहुंच लागत}}{\text{अंतिम उत्पाद की निवल बिक्री कीमत}} \times 100\%$$

8. प्रमाणन और लेखा परीक्षण

- 8.1 परिशिष्ट क में दिए गए उत्पादों के लिए, प्रत्येक घरेलू निर्माता यह घोषणा करते हुए खरीद करने वाली सरकारी एजेंसी को स्व-प्रमाणन का शपथ पत्र प्रस्तुत करेगा कि लौह एवं इस्पात उत्पाद का निर्धारित घरेलू मूल्यवर्धन के संबंध में घरेलू स्तर पर निर्माण किया गया है। परिशिष्ट ख के पूंजीगत माल के लिए, बोली लगाने वाला यह घोषणा करते हुए घरेलू निर्माता को सांविधिक लेखा परीक्षक द्वारा जारी किया गया प्रमाणन प्रस्तुत करेगा कि पूंजीगत माल का निर्माण घरेलू स्तर पर निर्धारित घरेलू मूल्यवर्धन के संबंध में किया गया है। वे बोली लगाने वाले जो लौह एवं इस्पात उत्पादों के घरेलू निर्माताओं का एकमात्र बिक्री एजेंट/अधिकृत वितरक/अधिकृत डीलर/अधिकृत आपूर्ति गृह हैं, ई पी सी के अंतर्गत घरेलू निर्माताओं की ओर से बोली लगाने के लिए पात्र हैं।

बोली लगाने वाला घरेलू निर्माताओं के द्वारा जारी किए गए स्व-प्रमाणन और सांविधिक लेखा परीक्षकों द्वारा जारी किये गये प्रमाणनों को यह घोषणा करते हुए खरीद करने वाली एजेंसी को प्रस्तुत करेगा कि लौह एवं इस्पात उत्पादों का घरेलू स्तर पर निर्माण निर्धारित घरेलू मूल्यवर्धन के संबंध में किया गया है। स्व-प्रमाणन का शपथ पत्र इन दिशानिर्देशों से संलग्न **प्रपत्र 1** में प्रस्तुत किया जाएगा।

- 8.2 घरेलू निर्माता की यह जिम्मेदारी होगी कि वह यह सुनिश्चित करे कि इस प्रकार से दावा किये गये उत्पादों का घरेलू स्तर पर उम उत्पाद के लिए निर्धारित घरेलू मूल्यवर्धन के संबंध में किया गया है। बोली लगाने वाले से यह भी अपेक्षित होगा कि वह घरेलू निर्माता के सांविधिक लेखा परीक्षकों द्वारा विधिवत प्रमाणित अर्धवार्षिक (मिंतंबर 30 और मार्च 31) आधार पर घरेलू मूल्यवर्धन प्रमाणपत्र उपलब्ध कराये कि पहले 6 महीनों के दौरान इस उत्पाद के लिए किये गये घरेलू मूल्यवर्धन के दावे इस नीति के अनुसार हैं। इस प्रकार के प्रमाण पत्र को संबंधित सरकारी एजेंसियों को प्रत्येक छमाही के शुरू होने के 60 दिनों के भीतर प्रस्तुत किया जाएगा और उस उत्पादों की आपूर्ति को पूरा करने तक प्रस्तुत करता रहेगा।
- 8.3 खरीद करने वाली एजेंसी बोली लगाने वाले द्वारा प्रस्तुत किये गये इस्पात उत्पाद में घरेलू मूल्यवर्धन के संबंध में स्व-प्रमाणन का शपथ पत्र स्वीकार करेगा। सामान्य तौर पर खरीद करने वाली एजेंसी की यह जिम्मेदारी होगी कि वह इस दावे की सत्यता की जांच करे। इसकी सत्यता प्रदर्शित करने की जिम्मेदारी बोली लगाने वाले की होगी जब उसे ऐसा करने के लिए कहा जाए।
- 8.4 यदि खरीद करने वाली एजेंसी अथवा संबंधित सरकारी एजेंसी द्वारा लौह एवं इस्पात उत्पादों में घरेलू मूल्यवर्धन के संबंध में बोली लगाने वाले के दावे के विरुद्ध कोई शिकायत प्राप्त होती है तब खरीद करने वाली एजेंसी के पास सभी संबंधित दस्तावेजों का निरीक्षण करने और उसकी जांच करने तथा निर्णय लेने का पूर्ण अधिकार होगा। यदि कोई स्पष्टीकरण की आवश्यकता होती है तब मामले को तकनीकी सहायता के लिए अनुरोध के साथ इस्पात मंत्रालय को भेजा जा सकता है।
- 8.5 सरकारी एजेंसी को भेजे गए किसी शिकायत का निपटारा सभी आवश्यक दस्तावेजों को प्रस्तुत करने के साथ इसे भेजे जाने के 4 सप्ताह के भीतर किया जाएगा। बोली लगाने वाले से यह अपेक्षित होगा कि वह शिकायत दायर करने के 2 सप्ताह के भीतर सरकारी एजेंसी को लौह एवं इस्पात उत्पादों में दावा किये गये घरेलू मूल्यवर्धन के समर्थन में आवश्यक दस्तावेज प्रस्तुत करे।
- 8.6 यदि इस मामले को इस्पात मंत्रालय के पास भेजा जाता है तब इस्पात मंत्रालय के अधीन गठित शिकायत निवारण समिति सरकारी एजेंसी के दृष्टिकोण पर विचार करने के बाद बोली लगाने वाले से सभी दस्तावेजों के प्राप्त होने और उसका संदर्भ भेजे जाने के 4 सप्ताह के भीतर शिकायत का निपटारा करेगी। बोली लगाने वाले से यह अपेक्षित होगा कि वे इस मामले के संदर्भ के 2 सप्ताह के भीतर इस्पात मंत्रालय के अंतर्गत शिकायत निवारण समिति को लौह एवं इस्पात उत्पादों में दावा किए गए घरेलू मूल्यवर्धन के समर्थन में आवश्यक दस्तावेज प्रस्तुत करे। यदि बोली लगाने वाले द्वारा कोई सूचना प्रस्तुत नहीं की जाती है तब शिकायत निवारण समिति दावे की प्रमाणिकता अधिक करने के लिए सरकारी एजेंसी के परामर्श से आगे आवश्यक कार्रवाई कर सकती है।
- 8.7 घरेलू मूल्यवर्धन की निर्धारित सीमा का आकलन करने की लागत का वहन खरीद करने वाली एजेंसी द्वारा किया जाएगा यदि घरेलू मूल्यवर्धन प्रमाण पत्र के अनुसार सही पाया गया हो। हालांकि, यदि ऐसा पाया गया हो कि दावा किए गए अनुसार घरेलू मूल्यवर्धन सही नहीं है तब आकलन की लागत बोली लगाने वाले द्वारा भुगतान के योग्य होगी जिन्होंने एक गलत प्रमाण पत्र प्रस्तुत किया है। इसे लागू करने के तरीके को निविदा दस्तावेज में परिभाषित किया जाएगा।

9. प्रतिबंध

- 9.1 प्रत्येक सरकारी एजेंसी निविदा दस्तावेज में निर्धारित घरेलू मूल्यवर्धन का बोली लगाने वाले के द्वारा गलत घोषणा किए जाने की स्थिति में दण्ड को स्पष्ट रूप से परिभाषित करेगा। इस दण्ड में ऐसे निर्माता/सेवा प्रदाता की ई एम डी को जब्त करना, अन्य वित्तीय दंड लगाना और उसे काली सूची में डालना शामिल हो सकता है।
- 9.2 संबंधित बोली लगाने वाले के द्वारा इस्पात मंत्रालय को किसी प्रकार की शिकायत भेजे जाने की स्थिति में, 10 लाख रुपए अथवा खरीदी जा रही डी एम आई एंड एस पी के मूल्य का 0.2 प्रतिशत (अधिकतम 20 लाख के अध्येधीन) इसमें से जो भी अधिक हो, का शिकायत शुल्क होगा जिसका भुगतान शिकायतकर्ता द्वारा शिकायत के साथ इस्पात मंत्रालय के अधीन शिकायत निवारण समिति के पास जमा किए गए डिमाण्ड ड्राफ्ट के द्वारा किया जाएगा। यदि, शिकायत को सही नहीं पाया जाता है तब सरकारी एजेंसी के पास उक्त राशि को जब्त करने का अधिकार सुरक्षित है। यदि शिकायत पर्याप्त रूप से सही पाई जाती है तब शिकायतकर्ता द्वारा जमा किए गए शुल्क को बिना किसी ब्याज के वापिस किया जाएगा।

10. इस्पात मंत्रालय द्वारा कार्यान्वयन की मॉनीटरिंग

- 10.1 इस नीति के प्रावधान प्रकाशन की तिथि से 5 वर्षों की अवधि के लिए लागू रहेंगे। इस नीति की अवधि को इस्पात मंत्रालय के विवेक से और आगे बढ़ाया जा सकता है।
- 10.2 इस्पात मंत्रालय इस नीति के कार्यान्वयन की मानीटरिंग करने के लिए नोडल मंत्रालय होगा।
- 10.3 डी एम आई एंड एस पी नीति के अंतर्गत सभी लागू एजेंसियां इस नीति का कार्यान्वयन मुनिश्चित करेंगी और वार्षिक रूप से जून के महीने में एक घोषणा भेजेगी जिसमें इस नीति के अनुपालन की सीमा और पिछले वित्तीय वर्ष के दौरान उसके अनुपालन न किए जाने के कारणों को दर्शाया जाएगा।

इस्पात मंत्रालय को संदर्भ

किमी ऐसे प्रश्न की स्थिति में कि क्या खरीदी जा रही मद इस नीति के अंतर्गत शामिल किए जाने वाले डी एम आई एंड एस पी है, इस मामले को स्पष्टीकरण के लिए इस्पात मंत्रालय के पास भेजा जाएगा।

परिशिष्ट क - धरेलू स्तर पर निर्मित उत्पादों के लिए अनन्य

क्र. सं.	लौह एवं इस्पात उत्पादों की सांकेतिक सूची	लागू एच एस कोड	न्यूनतम धरेलू मूल्यवर्धन आवश्यकता
1	600 मि. मी. अथवा उससे अधिक की चौड़ाई वाले लौह अथवा गैर एलॉय इस्पात का फ्लेट रोल उत्पाद, हॉट रोलड, न ढका हुआ, प्लेट लगाया हुआ अथवा कोट किया हुआ	7208	50%
2	600 मि. मी. अथवा उससे अधिक की चौड़ाई वाले लौह अथवा गैर एलॉय इस्पात का फ्लेट रोल उत्पाद, कोल्ड रोलड (कोल्ड - कम किया हुआ), न ढका हुआ, प्लेट लगाया हुआ अथवा कोट किया हुआ	7209	50%
3	600 मि. मी. अथवा उससे अधिक की चौड़ाई वाले लौह अथवा गैर एलॉय इस्पात का फ्लेट रोल उत्पाद, ढका हुआ, प्लेट लगाया हुआ अथवा कोट किया हुआ	7210	50%
4	600 मि. मी. से कम की चौड़ाई वाले लौह अथवा गैर एलॉय इस्पात का फ्लेट रोल उत्पाद, न ढका हुआ, प्लेट लगाया हुआ अथवा कोट किया हुआ	7211	35%
5	600 मि. मी. से कम की चौड़ाई का लौह अथवा गैर एलॉय इस्पात का फ्लेट रोल उत्पाद, ढका हुआ, प्लेट लगाया हुआ अथवा कोट किया हुआ	7212	35%
6	लौह एवं गैर एलॉय इस्पात का अनियमित रूप से षंठा हुआ क्वाडल में बार्स और रॉड, हॉट रोलड	7213	35%
7	लौह अथवा गैर एलॉय इस्पात के अन्य बार्स और रॉड्स जिसे फोर्ज किए जाने की तुलना में आगे अधिक वर्क नहीं किया हुआ, हॉट रोलड, हॉट ड्रॉन अथवा हॉट एक्सट्रूडेड परंतु रोलिंग के बाद उसे टिबिस्ट किये जाने सहित	7214	35%
8	लौह अथवा गैर एलॉय इस्पात का अन्य बार्स एंड रोड्स	7215	35%
9	लौह अथवा गैर एलॉय इस्पात का एंगल, शेप और सेक्शनस	7216	35%
10	लौह अथवा गैर एलॉय इस्पात का तार	7217	50%
11	600 मि. मी. अथवा उससे अधिक की चौड़ाई का स्टेनलैस इस्पात का फ्लेट रोलड इस्पात	7219	50%
12	600 मि. मी. से कम की चौड़ाई का स्टेनलैस इस्पात का फ्लेट रोलड इस्पात	7220	50%
13	स्टेनलैस स्टील का अन्य बार्स और रोड्स; स्टेनलैस स्टील का एंगल शेप और सेक्शनस	7222	50%
14	अन्य एलॉय इस्पात का तार	7229	35%
15	लौह अथवा इस्पात को रेल, रेलवे अथवा ट्रामवे ट्रेक निर्माण सामग्री	7302	50%

16	कास्ट लौह का ढूब, पाइप और होलो पाइप	7303	35%
17	लौह (कास्ट आयरन को छोड़कर) अथवा इस्पात का ढूब पाइप और होलो प्रोफाइल, मीमलैस	7304	35%
18	लौह अथवा इस्पात का सर्कुलर क्रॉस सेक्शन वाले अन्य ढूब और पाइप (उदाहरण के लिए, वेल्ड किया हुआ, रिबेट किया हुआ अथवा समान रूप से बंद किया गया हुआ), जिमकी बाहरी त्रिज्या 406.4 मि. मी. से अधिक हो	7305	35%
19	लौह अथवा इस्पात के अन्य ढूब, पाइप और होलो प्रोफाइल (उदाहरण के लिए ओपन मीन अथवा वेल्ड किया हुआ, रिबेट किया हुआ अथवा समान रूप से बंद किया गया हुआ)	7306	35%
20	लौह अथवा इस्पात का ढूब अथवा पाइप फिटिंग (उदाहरण के लिए, कनेक्टर/कप्लिंग, एल्बो स्लीव्स)	7307	35%
21	स्टेनलैस स्टील का अनियमित रूप से ँंठा हुआ क्वाइल में बार्स और रॉड, हॉट रोल्ड	7221	35%
22	स्टेनलैस स्टील का वायर	7223	35%
23	इलेक्ट्रिकल स्टील सहित 600 मि. मी. अथवा उससे अधिक की चौड़ाई वाले अन्य एलॉय स्टील का फ्लेट रोल्ड इस्पात	7225	35%
24	इलेक्ट्रिकल स्टील सहित 600 मि. मी. से कम की चौड़ाई वाले अन्य एलॉय स्टील का फ्लेट रोल्ड इस्पात	7226	35%
25	अन्य एलॉय स्टील का अनियमित रूप से ँंठा हुआ क्वाइल में बार्स और रोड, हॉट रोल्ड	7227	15%
26	अन्य एलॉय स्टील का अन्य बार्स और रोड्स; अन्य एलॉय स्टील का एंगल, शेप्स और सेक्शन्स; एलॉय अथवा नॉन एलॉय स्टील का होलो ड्रिल बार्स और रोड्स	7228	35%
27	लौह अथवा इस्पात की शीट पाइलिंग, चाहे ड्रिल किया हुआ हो अथवा नहीं, चाहे पंच किया हुआ हो अथवा नहीं, चाहे असेम्बल किये हुए तत्वों से बना हुआ हो अथवा नहीं; लौह अथवा इस्पात का वेल्ड किया हुआ एंगल, शेप और सेक्शन्स	7301	15%
28	स्ट्रक्चर्स (9406 के शीर्ष का प्रीफैब्रिकेटेड भवनों को छोड़कर) और स्ट्रक्चर्स का हिस्सा	7308	15%
29	300 लीटर से अधिक क्षमता का लौह अथवा इस्पात का किसी सामग्री (कम्प्रेस किए हुए अथवा सरलीकृत गैस को छोड़कर) के लिए भंडार, टैंक, वैट और समान कन्टेनर चाहे उसे लाइन किया गया हो अथवा नहीं या उसे हीट से इन्सुलेट किया गया हो अथवा नहीं लेकिन यांत्रिक अथवा तापीय उपक्रम से युक्त न हो	7309	15%
30	अधिकतम 300 लीटर की क्षमता का लौह अथवा इस्पात का किसी सामग्री (कम्प्रेस किए हुए अथवा सरलीकृत गैस को छोड़कर) के लिए टैंक, कास्ट, ड्रम, केन, बॉक्स और समान कन्टेनर चाहे उसे लाइन किया गया हो अथवा नहीं या उसे हीट से इन्सुलेट किया गया हो अथवा नहीं लेकिन यांत्रिक अथवा तापीय उपक्रम से युक्त न हो	7310	15%
31	लौह अथवा इस्पात का कम्प्रेस किया हुआ अथवा सरलीकृत गैस के लिए कन्टेनर	7311	15%
32	लौह अथवा इस्पात का स्टेंडिड वायर, रोप, केबल, प्लेटिड बैंड, स्लिंग और उसके समान वस्तु जिसे त्रिचूतीय रूप से इन्सुलेट न किया गया	7312	15%
33	लौह अथवा इस्पात का फेनसिंग के लिए उपयोग किये जाने वाला बार किया हुआ वायर; ट्रिवस्ट किया हुआ हूप अथवा सिंगल प्लेट वायर, बार्स किया हुआ अथवा नहीं और लूज तरीके से ट्रिवस्ट किया हुआ डबल वायर	7313	15%
34	लौह अथवा इस्पात तार का ड्रिल, नेटिंग और फेनसिंग; लौह अथवा इस्पात का विस्तार किया हुआ धातु	7314	15%

35	लौह अथवा इस्पात का चैन और उसका हिस्सा	7315	15%
36	लौह अथवा इस्पात का टैंकर, ग्रेपनेल्म और उसका हिस्सा	7316	15%
37	लौह एवं इस्पात की वस्तुएं	7317	15%
38	लौह एवं इस्पात की वस्तुएं	7318	15%
39	लौह एवं इस्पात की वस्तुएं	7319	15%
40	लौह अथवा इस्पात का स्प्रिंग और स्प्रिंग के लिए लीन्स	7320	15%
41	लौह अथवा इस्पात का स्टोव्स, रेंज, ग्रेड, कूकर (केंद्रीय हार्डिंग के लिए सहायक बायलरों के साथ उन वस्तुओं सहित), वारवेक्यूज, ब्रेजियर्स, गैस रिंग, प्लेट वामर्स और समान गैर-विद्युतीय घरेलू उपकरण और उसका हिस्सा	7321	15%
42	लौह अथवा इस्पात का केंद्रीय हार्डिंग के लिए रेडियेटर जिसे विद्युतीय रूप से हीट न किया गया हो और उसका हिस्सा; लौह अथवा इस्पात का हेयर हीटर और हॉट एयर वितरक जिसे विद्युतीय रूप से हीट न किया गया हो, फेन अथवा ब्लोअर जो मोटर से चलती हो और उसके हिस्से को शामिल करते हुए	7322	15%
43	लौह अथवा इस्पात का टेबल और समान घरेलू वस्तुएं और उसका हिस्सा	7323	15%
44	लौह अथवा इस्पात का सेनेटरी वेयर और उसको पार्ट्स	7324	15%
45	लौह अथवा इस्पात का अन्य कास्ट सामान	7325	15%
46	लौह अथवा इस्पात का विद्युतीय इस्पात और अन्य वस्तु	7326	15%
47	रेलवे अथवा ट्रामवे पेसेंजर कोच जो स्वयं आगे नहीं बढ़ता हो	8605	50%
48	रेलवे अथवा ट्रामवे माल वेन और वेगेन जो स्वयं आगे नहीं बढ़ता हो	8606	50%
49	रेलवे अथवा ट्रामवे लोकोमोटिव का हिस्सा अथवा रोलिंग स्टॉक जैसे बोगिज, बिसल बोगिज, एक्सेल और फोज्ड किया हुआ पहिया और उसका हिस्सा	8607	50%

विवरणों में शामिल किए गए उत्पाद सांकेतिक हैं, विनिर्दिष्ट एच एम कोड के अंतर्गत सभी उत्पादों को परिशिष्ट के भाग के रूप में शामिल किया गया है।

परिशिष्ट ख

लौह और इस्पात उत्पादों का निर्माण करने के लिए पूंजीगत माल की सांकेतिक सूची (जो विस्तृत नहीं है)

क्र. सं.	संयंत्र शॉप	पूंजीगत माल	न्यूनतम घरेलू मूल्यवर्धन आवश्यकता
1	कच्चा माल संभाल प्रणाली	चूर्ण की हुई सामग्री के लिए एप्रोन फीडर, बेरल कप्लिंग, हैवी ड्यूटी वियेरिंग, हाइड्रोलिक डिक्स ब्रेक्स, टैंकर एंड कंटेनर, पाइप कंवेयर के लिए कंवेयर बेल्ट, हार्ड एंगल कंवेयर प्रणाली, क्रशर्स, क्रेन रेल लुब्रिकेशन, चार गरडर ग्राइडर ई ओ टी क्रेन, क्रेन वेइंग प्रणाली, क्रेन एयर कंडीशनिंग, फ्यूड कप्लिंग, 4 लिफ्ट ट्रक्स, हाइड्रोलिक मोटर्स, हाइड्रोलिक सिस्टम, लॉकिंग एसेम्बली (फ्रिक्शन ग्रिप), लोड सेल्स, लेवल सेन्सर्स, पाइप कंवेयर प्रणाली, प्लग/पाडेल फीडर, न्यूमेटिक हुलाई - धना एवं लिन फेस, रिक्लेमर्स, रेडियो रिमोट कंट्रोल, रेल फिक्सिंग व्यवस्था (विशेष), रेपिड/फ्लेड लोडिंग प्रणाली, स्टेर्स, स्पेशल स्क्रीन, स्लिव रिंग वियेरिंग, ट्रिप्लर्स, ट्रांसफर कार, टॉर्स (स्पेशल), वाइब्रेशन, आइसोलेशन प्रणाली (स्प्रिंग डम्पर) वेगन टिप्लर्स, वेगन लोडर	50%
2	मिनिरल बेनिफिकेशन (लौह अयस्क और कोयला) उपकरण	इंडस्ट्रीयल क्रशर्स, ग्राइनिंग मिल, परम्परागत स्क्रीन, स्लूरी पम्पस, हिरेट थिकनर्स, फिल्टर्स, हाइड्रोक्लोन्स	50%

3	कोक अवेन	कोक ओवन मिलिका रिफेक्टरी, एन्क्रेज सिस्टम, ब्रंच तरडन के साथ वेस्ट गैस वाल, फनेस प्लेट, डोर फ्रेम, डोर बॉडी, माइनर कास्टिंग: गुजनेक, बाल बॉक्स, ए पी लिड, चार्जिंग और इन्स्पेक्शन होल लिड एंड फ्रेम रिचर्सिंग मंकेनिजम, केंद्रीकृत लूत्रिकेशन प्रणाली हाइड्रोजेट डोर क्लीनिंग तंत्र, कोड कंवेयर सिस्टम, स्क्रिप होइस्ट, डोर लोवरिंग रैक, आइसोलेशन/रिचर्सिंग कॉक्स, II ऑटोमेशन, अवेन मशीन	50%
4	उप-उत्पाद संयंत्र	प्राथमिक गैस कूलर, इलेक्ट्रोस्टैटिक तार प्रेसिपिटेटर, H ₂ S, NH ₃ और नपथलिन स्कूब्वर, कोम्बी स्ट्रीप्पर, फ्लेशिंग लिक्व पम्प, क्लास किन, क्लाक रियेक्टर, वेस्ट हीट बायलर, डिक्लेटर्स	50%
5	सिंटर संयंत्र उपकरण	पेलेट कार, ड्राइव/डिस्चार्ज इंड स्पोकेट एंसेम्बली कब्ड रेल, स्लाइड रेल, हॉट सिंटर ब्रेकर और गिजली, डिप रेल एंड रनिंग रेल, प्रोसेस फेन के लिए इम्पेलर एंसेम्बली, सिंटर मशीन का ड्राइव एंसेम्बली, उच्च तीव्रता वाला मिक्सर और नोडूलाइजर	50%
6	पेलेट संयंत्र उपकरण	पेलेट कार, ड्राइव/डिस्चार्ज इंड स्पोकेट एंसेम्बली कब्ड रेल, स्लाइड रेल, रनिंग रेल बरटिकल रोलर मिल, प्रोसेस फेन के लिए इम्पेलर एंसेम्बली, इनडूरेटिंग मशीन का ड्राइव एंसेम्बली, उच्च तीव्रता वाला मिक्सर, बालिंग डिक्स, सिंगल डेक्स रोलर स्क्रीन एंड डबल डेक्स रोलर स्क्रीन	50%
7	ब्लास्ट फरनेस उपकरण	ब्लेडर बाल के साथ बेल रहित टॉप प्रणाली, एस जी आयरन स्टेव कूलर, कोपर स्टेव कूलर, स्टॉक लेवल इंडिकेटर (रडार टाइप), मड गन, ड्रिलिंग मशीन एंड मेनिपुलेटर, गैस किल्लिंग प्लांट प्रणाली, इसके बाइस-पास वाल सहित टॉप रिक्वरी टूबाइन सिस्टम, डि-ब्रिक्किंग मशीन, रि-रेलिंग उपकरण, पी सी आई प्रणाली, पी सी आई के लिए ग्राइनिंग मिल, स्टॉक लेवल इंडिकेटर, टूयेरे स्टाक एंसेम्बली, वेस्ट हीट रिक्वरी प्रणाली, बी एफ एवं हॉट ब्लास्ट स्टोव प्रौद्योगिकीय वाल, एन्व ब्रंडन प्रोब्स, स्लग ग्रेन्यूलेशन यूनिट, टूयेरे एंड टूयेरे कूलर, टोरपेडो लेडल कार, बी एफ हरथ रिफेक्ट्री	50%
8	डायरेक्ट रिडक्शन प्लांट उपकरण	चार्ज डिस्चार्ज, अपर एंड लोअर सील लेग, रिफोमर एंड रि-क्यूरेटर सिस्टम, बर्डन फिडर्स, टूबो-एक्सपेंडर, प्रोसेस गैस कम्प्रेसर, सील गैस कम्प्रेसर एवं बोटम सील गैस कम्प्रेसर, सील गैस जेनरेटर एवं डायर्स, प्रोसेस गैस हीटर, CO ₂ रिमूवल प्लांट	50%
9	वेमिक ऑक्सीजन फर्नेस उपकरण	मुख्य और अनुरक्षण उपकरण जिसमें कंवेटर, गनिंग मशीन, रिफेक्ट्री/स्लग मॉनीटरिंग उपकरण, कंवेटर वेसेल, ट्रनिअन रिंग एंड सम्पेशन प्रणाली, ट्रनिअन बियरिंग और हाउसिंग, कंवेटर बुल गियर यूनिट और टिल्ट ड्राइव सिस्टम, कंवेटर के रोटेरी ज्वाइंट, बोटम स्ट्रिंग सिस्टम, क्लपिंग के साथ लांस बाडी, लांस कोपर टिप्स, ऑक्सीजन ब्लोबिंग/बोटम स्टीरिंग के लिए बाल स्टेशन, सब-लान सिस्टम, प्रोसेस मॉड्यूल अर्थात् प्रोसेस साफ्टवेयर/हार्डवेयर के साथ ऑफ गैस एनेलाइजर, कंटेनर लैब मेजरमेंट प्रोब, स्विच ओवर स्टेशन, प्राइमरी गैस के लिए आई डी फेन, हॉट मेटल और स्टील लेडल, लेडल ट्रांसफर कार, लेडल अनुरक्षण उपकरण, स्लेग पोट, स्लग पोट ट्रांसफर कार, स्क्रैप बॉक्स क्रेप ट्रांसफर कार, लांस करेज, लांस गाइड, क्रेन एंड हाइस्ट, लांस होइस्ट एंड ट्राली, लांस टिल्टिंग उपकरण, लांस को लिफ्ट करने के लिए ट्रेवस, विभिन्न आकर के बंकर, बिन बाइब्रेटर, वेइंग हूपर, अनुरक्षण स्टेण्ड, डी इस्टिंग सक्शन हूड, टीमिंग/एच एम, लेडल रिलाइनिंग स्टैंड, स्टैंड कूलिंग स्टेक इन्स्पेक्शन उपकरण, हूड ट्रेवर्स करेज, रिफेक्ट्री, बाइपास एवं आइसोलेशन वाल्व, फ्लेयर स्टेक एवं इगनिशन सिस्टम, स्क्रबिंग टोवर सेल - वेट गैस क्लीनिंग सिस्टम, डॉंग हाउस लेडल डायर, लेडल	50%

		प्री-हीटर, लेडल कूलर, फ्यूम कोलेक्शन हूड्स, क्लीन गैस स्टेक, इस्ट मिलो, वेग ब्रिज, म्लग रिट्रैनिंग उपकरण	
10	इलेक्ट्रिक आर्क फर्नेस	फर्नेस प्रोपर (जिसमें फर्नेस लोवर सेल, अपर सेल और रूफ, टिल्टिंग प्लेटफार्म, फर्नेस गेन्ट्री शामिल है) और ट्रांसफार्मर, इलेक्ट्रोल रेगुलेशन प्रणाली, हाइड्रोलिक सिस्टम, रिफैक्ट्री, लेवल I एंड II आटोमेशन सिस्टम के पार्ट्स। एल एफ - वाटर कूल्ड लेडल रूफ, इलेक्ट्रोड मास्ट एंड आमर्स, इलेक्ट्रोड रेगुलैटिंग सिस्टम, वायर फिडिंग सिस्टम, बोटम इनडरट गैस स्टिरिंग बाल सिस्टम पोरुस प्लग और टॉप लांस के लिए, इमरजेंसी लांसतंत्र, ड्राइव यूनिट के साथ लांस केरेजि सिस्टम, स्वचालित तापक्रम, सेम्पलिंग और बाथ लेबल/ओ2 मेजरमेंट, तापक्रम और आक्सीजन इम्मजन लांस, ड्राइव यूनिट के साथ लांस केरेज सिस्टम, हाइड्रोलिक सिस्टम, रिफैक्ट्री, लेडल रूफ डेल्टा पोरशन, आर एच प्रोपर (जिसमें लेडल ट्रांसफर कार, बेक्यूम वेमेल, वेमेल लिफ्टिंग और लोवरिंग सिस्टम शामिल है, हाइड्रोलिंग सिस्टम, मल्टी फंक्शन लांस, वाल्व रेक्स/स्टेशन, इलेक्ट्रोड क्लेप यूनिट, इलेक्ट्रोड आमर्स का कंडक्टर, वाटर कूल्ड केबल, ए आर स्टेरिंग वाल्व रेक, लांस ट्रांसपोर्ट कार, रिफैक्ट्री लांस, हाइड्रोलिक सिलेंडर, लेडल रूफ लिफ्टिंग सिलेंडर, लूत्रिकेशन प्रणाली, सक्शन हूड, डम्पर, वाइब्रो फीडर, वेडंग होपर, वायर फिडिंग प्रणाली, इलेक्ट्रोड निपिलिंग स्टेड, क्रेन, होइस्ट, तापमान और सेम्पलिंग टिप्स, लेडल स्टैंड, ई एस पी, डिडिक्टिंग हूड, रिफैक्ट्री, वेग फिल्टर, क्रेन इत्यादि।	50%
11	सतत कास्टिंग उपकरण	लाइले टरेट, लेडल कवर मेनिपुलेटर, लेडल शारउड मेनिपुलेटर, टनडिस कार, कंटिन्यूअस टनडिस टेम्पेचर मेजरमेंट सिस्टम, टनडिस स्टोपर रूड मेकेनिजम, इमरजेंसी कट-आफ गेट, मोल्ड एसेम्बली, नोजल क्लिक चेंज डिवाइस, मोल्ड ओसीलेटर एंड ई एम एस सिस्टम, इलेक्ट्रो-मेगेनेटिक ब्रेकिंग सिस्टम, स्ट्रेड गाइड सेगमेंट, विदड्रावल एंड स्ट्रेघटेनिंग यूनिट (डब्ल्यू एस यू), रोल गेप चेकर इमरजेंसी टार्च कटर, टार्च कटिंग मशीन, डेबरर, मार्किंग मशीन, टेकेनोलोजी कंट्रोल सिस्टम एंड प्रोसेस मोडल, ब्लेक रिफैक्ट्रीज, स्ट्रेड गन्डे सेगमेंट, टनडिश, लाइले कवर, रोलर टेबल एंड आक्सीलिरीज, माल्ड एंड सेगमेंट मेनटेनेस इक्यूपमेंट टनडिस मेनटेनेस इक्यूपमेंट, ई एम बी आर सिस्टम	50%
12	फ्लेट मिल	लार्ज कास्टिंग एंड फाजिग लाइक मिल हाउसिंग, बेड प्लेट्स वर्क्स रोल, बेकअप रोल, इंड स्पिडल्स; रोलर टेबल, बेकअप रोल एंड वर्क रोल चक्स क्वाडलर/टेनशन रिल/अनक्वाइलर, ए जी सी सिलेंडर, शेयर्स, लेवेलेर्स, लाजेर वेल्डर, पेकेजिंग मशीन, नॉन कान्टेक्ट, गेज/प्रोफाइल गेज, एंटी-फ्रिक्शन रोल नेक बियेरिंग, आयल फिल्म बियेरिंग, गियर बॉक्स, मिल मोटर्स	50%
13	लॉग मिल	मिलम हाउसिंग, बेड प्लेट, वर्क रोल, बेकअप रोल, स्पिनडेल्स; रोलर टेबल, कॉयलर /टेंशन रिल /अनकॉयलर, शेयर्स, बिल्डट वेल्डर, पेकेजिंग मशीन, नान-कान्टेक्ट गॉज/प्रोफाइल गॉज, एंटी-फ्रिक्शन रोल नेक बियेरिंग, आयल फिल्म बियेरिंग, फिनिशिंग ब्लाक्स, गियर बॉक्स, मिल मोटर	50%

* परिशिष्ट ख में मर्दाने निर्माण करने वाले इस्पात के लिए पूंजीगत सामानों की एक सांकेतिक सूची है। यह सूची विस्तृत नहीं है। इस्पात के निर्माण के लिए सभी पूंजीगत मालों पर 50% की न्यूनतम घरेलू मूल्यवर्धन आवश्यकता के साथ इस नीति के अंतर्गत खरीद बरीयता के लिए विचार किया जाएगा।

फार्म - 1

100/- रुपए के स्टाम्प पेपर पर दिए जाने के लिए लौह एवं इस्पात उत्पादों/पूँजीगत मालों में घरेलू मूल्यवर्धन के संबंध में स्व-प्रमाणन शपथ के लिए प्रपत्र :

मैं _____ सुपुत्र, सुपुत्री, पत्नी, _____ का निवासी _____
एतद् द्वारा निष्ठापूर्वक नीचे दिए गए अनुसार वचन देता हूँ और घोषण करता हूँ :

कि मैं अधिसूचना सं. : _____ के माध्यम से जारी किए गए भारत सरकार की नीति के नियम और शर्तों का पालन करने के लिए सहमत होऊंगा।

कि यहां नीचे दी गई सूचना मेरे सर्वोत्तम ज्ञान और विश्वास के अनुसार सही है और मैं घरेलू मूल्यवर्धन का आकलन करने के प्रयोजन से खरीद करने वाली एजेंसी के समक्ष संगत रिकार्ड प्रस्तुत करने का वचन देता हूँ।

कि सभी इनपुट्स के लिए घरेलू मूल्यवर्धन जिसमें उक्त लौह एवं इस्पात उत्पाद शामिल हैं का सत्यापन मेरे द्वारा कर लिया गया है और मैं उसमें किये गये दावों की सत्यता के लिए जिम्मेदार हूँ।

कि इसमें उल्लिखित उत्पाद घरेलू मूल्यवर्धन सही नहीं पाये जाने और मूल्यवर्धन के लिए निर्धारित मानदंडों को पूरा नहीं किये जाने की स्थिति में, घरेलू मूल्यवर्धन का आकलन करने के उद्देश्य से खरीद करने वाली एजेंसी के आकलन के आधार पर मैं 36 महीनों की अवधि के लिए किसी सरकारी निविदा से अयोग्य ठहराया जाऊंगा। इसके अलावा मैं इस प्रकार के आकलन की सभी लागतों का वहन करूंगा।

कि मैंने अधिसूचना संख्या _____ जिसमें सरकारी खरीद में घरेलू स्तर पर निर्मित लौह एवं इस्पात उत्पादों को बरीयता दी गई है, में संदर्भित सभी शर्तों का पालन किया है और यह कि खरीद करने वाली एजेंसी को एतद् द्वारा अधिकार दिया जाता है कि वह मेरे ई एम डी को जप्त करे। मैं यह भी वचन देता हूँ कि आकलन की लागत का भुगतान करूंगा और निविदा दस्तावेज में यथा उल्लिखित सभी दण्ड राशि का भुगतान करूंगा।

मैं 8 वर्षों की अवधि के लिए कम्पनी के रिकॉर्ड में निम्नलिखित सूचना रखने के लिए सहमत हूँ और किसी सांविधिक प्राधिकारी को सत्यापन के लिए इसे उपलब्ध कराऊंगा।

- i. बोली लगाने वाले का नाम और ब्यौरा (पंजीकृत कार्यालय, विनिर्माण इकाई का स्थान, कानूनी प्रतिष्ठान की प्रकृति)
- ii. वह तिथि जब यह प्रमाण पत्र जारी किया गया है।
- iii. लौह एवं इस्पात उत्पाद जिसके लिए इस प्रमाण पत्र को प्रस्तुत किया जाता है।
- iv. खरीद करने वाली एजेंसी जिसे यह प्रमाण पत्र प्रस्तुत किया जाता है।
- v. दावा की गई घरेलू मूल्यवर्धन की प्रतिशतता और क्या यह निर्धारित घरेलू मूल्यवर्धन के आरंभिक मूल्य को पूरा करता है।
- vi. विनिर्माता की इकाई का नाम और संपर्क विवरण
- vii. लौह और इस्पात उत्पादों की निवल बिक्री कीमत
- viii. संयंत्र तक भाड़ा, बीमा और रखरखाव
- ix. लौह एवं इस्पात उत्पादों का निर्माण करने के लिए उपयोग की जाने वाली इनपुट इस्पात (आयात किया गया) की सूची और कुल लागत मूल्य।
- x. इनपुट इस्पात जिसकी आपूर्ति घरेलू स्तर पर की जाती है की सूची और कुल लागत
- xi. कृपया यदि इनपुट इन हाऊस नहीं हो तब आपूर्तिकर्ताओं से प्राप्त घरेलू मूल्यवर्धन प्रमाणपत्र संलग्न करें।
- xii. आयात किये गये इनपुट इस्पात के लिए, सी आई एफ मूल्य, शुल्क और करों, पोर्ट पर उतारने से संबंधित प्रभारों और अंतर्देशीय भाड़े की लागत के ब्यौरे के साथ भारतीय पोर्ट पर पहुंच कीमत।

(प्रतिष्ठान/कंपनी का नाम) के लिए और उसकी ओर से

अधिकृत हस्ताक्षरकर्ता (निदेशक बोर्ड द्वारा विधिवत अधिकृत किये जाने के लिए)

<नाम, पदनाम और संपर्क सं. की प्रविष्टि करें>

MINISTRY OF STEEL

NOTIFICATION

New Delhi, the 29th May, 2019

G.S.R. 385(E).—The revised Policy for providing preference to domestically manufactured Iron & Steel Products in Government procurement is hereby published for general information.

[F. No.3(2)/2018-IDD]

RASIKA CHAUBE, Addl. Secy.

POLICY FOR PROVIDING PREFERENCE TO DOMESTICALLY MANUFACTURED IRON & STEEL PRODUCTS IN GOVERNMENT PROCUREMENT- REVISED, 2019

1 Background

- 1.1 This policy provides preference to Domestically Manufactured Iron and Steel Products (DMI&SP) in Government procurement.
- 1.2 The policy is applicable to iron & steel products as provided in Appendix A and capital goods for manufacturing iron & steel products in Appendix B, produced in compliance to prescribed quality standards, as applicable.
- 1.3 The policy is applicable to every Ministry or Department of Government and all agencies/entities under their administrative control and to projects funded by these agencies for purchase of iron & steel products for government projects. However, this policy shall not apply for purchase of iron & steel products with a view to commercial resale or with a view to use in the production of goods for commercial sale.

2 Definitions

- 2.1 **Bidder** may be a domestic/ foreign manufacturer of iron & steel or their selling agents/ authorized distributors/ authorized dealers/ authorized supply houses or any other company engaged in the bidding of projects funded by Government agencies.
- 2.2 **Domestically Manufactured Iron & Steel Products (DMI&SP)** are those iron and steel products which are manufactured by entities that are registered and established in India, including in Special Economic Zones (SEZs). In addition, such products shall meet the criteria of domestic minimum value-addition as mentioned in Appendix A.
- 2.3 **Domestic Manufacturer** is a manufacturer of iron & steel products conforming to guidelines in section 7 and confirming to the definition of 'manufacturer' as per Central Excise Act.
- 2.4 **Government** for the purpose of the Policy means Government of India.
- 2.5 **Government agencies** include Government PSUs, Societies, Trusts and Statutory bodies set up by the Government.
- 2.6 **MoS** shall mean Ministry of Steel, Government of India.
- 2.7 **Net Selling Price** shall be the invoiced price excluding net domestic taxes and duties
- 2.8 **Semi-Finished Steel** shall mean Ingots, billet, blooms and slabs, which can be subsequently processed to finished steel.
- 2.9 **Finished Steel** shall mean Flat and Long products, which can be subsequently processed into manufactured items.
- 2.10 **L1** means the lowest tender or the lowest bid or the lowest quotation received in a tender, bidding process or other procurement solicitation as adjudged in the evaluation process as per the tender or other procurement solicitation.
- 2.11 **Margin of purchase preference** means the maximum extent to which the price quoted by a domestic supplier may be above L1 for the purpose of purchase preference. In case of DMI&SP policy, the margin of purchase preference shall be 20% for items in Appendix B.
- 2.12 **Iron & Steel Product(s)** shall mean such iron and steel product(s) which are mentioned in Appendix A.
- 2.13 **Domestic value addition** shall be the net selling price (invoiced price excluding net domestic taxes and duties) minus the landed cost of imported input materials at the manufacturing plant in India (including all customs duties) as a proportion of the net selling price, in percent. The 'domestic value addition' definition shall be in line with the DPIIT (formerly DIPP) guidelines, and shall be suitably amended in case of any changes by DPIIT in the future. For the purpose of this policy document, domestic value addition and local content have been used interchangeably.

3 Exclusions

3.1 Waivers shall be granted by the Ministry of Steel to all such Government procurements subject to the below conditions.

3.1.1 Where specific grades of steel are not manufactured in the country, or

3.1.2 Where the quantities as per the demand of the project cannot be met through domestic sources

The exclusion requests shall be submitted to the Standing Committee along with sufficient proof of unavailability of domestically manufactured iron & steel products

4 Standing Committee

A Standing Committee under the Ministry of Steel (MoS) to be chaired by the Secretary (Steel), shall be constituted to oversee the implementation of the policy. The Committee shall comprise of experts drawn from Industry / Industry Association / Government Institution or Body / Ministry of Steel (MoS). The said Committee in MoS shall have the mandate for the following:

4.1 Monitoring the implementation of the policy

4.2 Review and notify the list of Iron & Steel products and the domestic value addition requirement criteria as mentioned at Appendix A and Appendix B.

4.3 Issue necessary clarifications for implementation of the policy including grant of exclusions to procuring agencies as per section 3

4.4 Constitute a separate committee to carry out grievance redressal

4.5 The Standing Committee shall submit its recommendations for approval to Ministry of Steel.

5 Notifying Iron & Steel Products Procured by Government

5.1 The following guidelines may be used for identifying and notifying the aforementioned products under the policy:

5.1.1 The policy is applicable to iron & steel products as provided in Appendix A and to capital goods for manufacturing iron & steel products in Appendix B.

5.1.2 Appendix A contains list of iron & steel products which are to be exclusively domestically manufactured and cannot be imported without the approval of the Ministry of Steel

5.1.3 Appendix B contains a list (non-exhaustive) of capital goods for which purchase preference shall be provided to domestically manufactured capital goods, if their quoted price falls within 20% of the price quoted for corresponding imported capital good.

5.1.4 The objective of the policy is to notify all iron & steel products which are procured by Government Agencies for government projects and not with a view to commercial resale or with a view to use in the production of products for commercial sale.

5.1.5 The policy is applicable to all projects funded by Ministry or Department of Government and all agencies/entities under their administrative control for purchase of iron & steel products.

5.1.6 The policy shall be applicable to projects where the procurement value of iron and steel products is greater than Rs. 25 crores. The policy shall also be applicable for other procurement (non-project), where annual procurement value of iron and steel products for that Government organization is greater than Rs. 25 crores.

5.1.7 The policy is applicable to purchase of iron & steel products by private agencies for fulfilling an EPC contract and/or any other requirement of Ministry or Department of Government or their PSUs.

5.1.8 Analysis of the availability of various grades of domestic iron and steel products needs to precede for notification under the policy. Only those iron & steel products, in respect of which at least one domestic manufacturer exists, shall be notified. Consultation may be carried out by the Standing Committee.

5.1.9 The policy is applicable to capital goods for manufacturing iron & steel products in Appendix B produced in compliance to prescribed quality standards, as applicable.

5.1.10 Policy for domestic procurement of capital goods for manufacturing iron and steel products is applicable to all public sector steel manufacturers and all agencies/entities under their administrative control for purchase of capital goods for manufacturing iron & steel products, not with a view to commercial resale.

5.1.11 The policy is applicable to purchase of capital goods for manufacturing iron & steel products by private agencies for fulfilling an EPC contract and/or any other requirement of public sector steel manufacturers and all agencies/entities under their administrative control

- 5.1.12 Government agencies which are involved in procurement of iron and steel products, and capital goods for manufacturing of iron and steel products, in cases where the iron and steel products are not mentioned in Appendix A and Appendix B, shall provide description and technical specifications of the product along with prescribed standards to the Standing Committee. The Standing Committee will act as per mandate in section 3 and section 4.
- 5.2 The Ministry of Steel (MoS) would notify iron & steel products along with the minimum prescribed domestic value addition, furnished at Appendix A.
- 5.3 The policy guidelines on capital goods for manufacturing iron & steel products shall be applicable to public sector steel manufacturers for all purchases of capital goods for manufacturing iron & steel products in Appendix B, irrespective of the project size.
- 5.4 Minimum domestic value addition requirement suggested for iron and steel products in Appendix A, and for capital goods for manufacturing iron and steel products in Appendix B have been decided on the basis of factors such as domestic supplier base, number of suppliers and import to consumption ratio.
- 5.5 The domestic value addition requirement norm shall be so calibrated that it reflects the average/above average manufacturing capability of the domestic industry for the iron & steel products at a point of time. This shall be suitably reviewed by the Standing Committee from time to time and amended, if required with the approval of Ministry of Steel.

6 Tender procedure for procurement by government and government agencies

- 6.1 The procuring/ Government agencies shall follow standard procurement procedures, in accordance with instructions of Ministry of Finance and CVC while adhering to DMI&SP. The policy shall come into effect from the date of its notification in all tenders where price bid have not been opened.
- 6.2 The tender document, for procurement of both Goods as well as for EPC contracts, should explicitly outline the qualification criteria for adherence to minimum prescribed domestic value addition by the bidder for iron and steel products and capital goods for manufacturing iron & steel products(as indicated in Appendix A and Appendix B)
- 6.3 In supporting the growth of domestic products, the target of domestic value addition in iron and steel business activities has been set as contained in **Appendix A and Appendix B**.
- 6.4 For iron and steel products in Appendix A, the procurement process shall be open only to the manufacturers / suppliers having the capability of meeting / exceeding the domestic value addition targets. Manufacturers / suppliers not meeting the domestic value addition targets are not eligible to participate in the bidding.
- 6.5 In case of Appendix B items, if in the opinion of the procuring company, the tenders (procured quantity) cannot be divided in the prescribed ratio of 50:50, then they shall have the right to award contract to the eligible domestic manufacturer for quantity not less than 50%, as may be divisible.
- 6.6 In continuation to the above clause, for Appendix B items, if the tendered item is non divisible, (to be included in the tender document by procuring company) the contract can be awarded to the eligible domestic manufacturer for the entire quantity.
- 6.7 In case of Appendix B items, if none of the eligible manufacturers meeting domestic value addition requirements match the L1 bid, the original bidder holding L1 bid shall secure the order for full value of procurement.
- 6.8 The bidders who are selling agents/ authorized distributors/ authorized dealers/ authorized supply houses of the domestic manufacturers of iron & steel products are eligible to bid on behalf of the domestic manufacturers under the policy. However, this shall be subject to the following conditions:
- 6.8.1 The bidder shall furnish the authorization certificate issued by the domestic manufacturer for selling domestically manufactured iron & steel products.
- 6.8.2 In case the procurement is covered under Appendix A of the DMI&SP policy, the bidder shall furnish the Affidavit of self-certification issued by the domestic manufacturer to the procuring agency declaring that the iron & steel products is domestically manufactured in terms of the domestic value addition prescribed.
- 6.8.3 In case the procurement is covered under Appendix B of the DMI&SP policy, the bidder shall furnish the certification issued by the statutory auditor to domestic manufacturer declaring that the capital goods to be used in Iron & Steel industry are domestically manufactured in terms of the domestic value addition prescribed.
- 6.8.4 It shall be the responsibility of the bidder to furnish other requisite documents required to be issued by the domestic manufacturer to the procuring agency as per the policy.

7 Domestic value addition requirement

- 7.1 Minimum domestic value addition requirement to qualify the product as a domestically manufactured iron & steel product or a Capital good are mentioned in Appendix A and B.
- 7.2 Domestic value addition shall be the net selling price (invoiced price excluding net domestic taxes and duties) minus the landed cost of imported input materials at the manufacturing plant in India (including all customs duties) as a proportion of the net selling price, in per cent.
- 7.2.1 In case the iron & steel products are made using domestic input steel (semi-finished/ finished steel), invoices of purchases from the actual domestic producers along with quantities purchased and the other related documents must be furnished to the procuring Government agency.
- 7.2.2 In case the iron & steel products have imported input steel, the invoices of purchases from the actual producers along with quantities purchased and the other related documents must be furnished separately. To derive the extent of domestic value addition, the weighted average of both (imported & domestic) input steel shall be considered to ensure that the minimum stipulated domestic value addition requirement of the policy is complied with.
- 7.3 It is recommended that each bidder participating in the tender process should calculate the domestic value addition using the below formula below so as to ensure the domestic value addition claimed is consistent with the minimum stipulated domestic value addition requirement of the policy.

For Iron and Steel products

% Domestic value addition

$$= \frac{\text{Net selling price of final product} - \text{Landed cost of imported iron or steel at plant}}{\text{Net selling price of final product}} \times 100\%$$

For Capital Goods

% Domestic value addition

$$= \frac{\text{Net selling price of final product} - \text{Landed cost of imported input materials at plant}}{\text{Net selling price of final product}} \times 100\%$$

8 Certification and audit

- 8.1 For products in Appendix A, each domestic manufacturer shall furnish the Affidavit of self-certification to the procuring Government agency declaring that the iron & steel products are domestically manufactured in terms of the domestic value addition prescribed. For capital goods in Appendix B, the bidder shall furnish the certification issued by the statutory auditor to the domestic manufacturer declaring that the capital goods are domestically manufactured in terms of the domestic value addition prescribed. The bidders who are sole selling agents / authorized distributors / authorized dealers / authorized supply houses of the domestic manufacturers of iron & steel products are eligible to bid on behalf of domestic manufacturers under the policy. The bidder shall furnish the Affidavits of self-certification issued by the domestic manufacturers and the certifications issued by the statutory auditors, to the procuring agency declaring that the iron & steel products are domestically manufactured in terms of the domestic value addition prescribed. The Affidavit of self-certification shall be furnished in **Form I** attached to these guidelines.
- 8.2 It shall be the responsibility of the domestic manufacturer to ensure that the products so claimed are domestically manufactured in terms of the domestic value addition prescribed for the product. The bidder shall also be required to provide a domestic value addition certificate on half-yearly basis (Sep 30 and Mar 31), duly certified by the Statutory Auditors of the domestic manufacturer, that the claims of domestic value addition made for the product during the preceding 6 months are in accordance with the Policy. Such certificate shall be filed within 60 days of commencement of each half year, to the concerned Government agencies and shall continue to be filed till the completion of supply of the said products.
- 8.3 The procuring agency shall accept the Affidavit of self-certification regarding domestic value addition in a steel product submitted by a bidder. It shall not normally be the responsibility of procuring agency to verify the correctness of the claim. The onus of demonstrating the correctness of the same shall be on the bidder when asked to do so.
- 8.4 In case a complaint is received by the procuring agency or the concerned Government Agency against the claim

of a bidder regarding domestic value addition in iron & steel products, the procuring agency shall have full rights to inspect and examine all the related documents and take a decision. In case any clarification is needed, matter may be referred to MoS with a request for technical assistance.

- 8.5 Any complaint referred to the Government Agency shall be disposed off within 4 weeks of the reference along with submission of all necessary documents. The bidder shall be required to furnish the necessary documentation in support of the domestic value addition claimed in iron & steel products to the Government Agency within 2 weeks of filing the complaint.
- 8.6 In case, the matter is referred to the Ministry of Steel, the grievance redressal committee setup under the MoS shall dispose of the complaint within 4 weeks of its reference and receipt of all documents from the bidder after taking in consideration, the view of the Government Agency. The bidder shall be required to furnish the necessary documentation in support of domestic value addition claimed in iron & steel products to the grievance redressal committee under MoS within 2 weeks of the reference of the matter. If no information is furnished by the bidder, the grievance redressal committee may take further necessary action, in consultation with Government Agency to establish bonafides of claim.
- 8.7 The cost of assessing the prescribed extent of domestic value addition shall be borne by the procuring agency if the domestic value addition is found to be correct as per the certificate. However, if it is found that the domestic value addition as claimed is incorrect, the cost of assessment will be payable by the bidder who has furnished an incorrect certificate. The manner of enforcing the same shall be defined in the tender document.

9 Sanctions

- 9.1 Each Government Agency shall clearly define the penalties, in case of wrong declaration by the bidder of the prescribed domestic value addition, in the tender document. The penalties may include forfeiting of the EMD, other financial penalties and blacklisting of such manufacturer/ service provider.
- 9.2 In case of reference of any complaint to MoS by the concerned bidder, there would be a complaint fee of Rs. 10 Lakh or 0.2 % of the value of the DMI&SP being procured (subject to a maximum of Rs. 20 Lakh), whichever is higher, to be paid by Demand Draft deposited with the grievance redressal committee under MoS along with the complaint by the complainant. In case, the complaint is found to be incorrect, the Government Agency reserves the right to forfeit the said amount. In case, the complaint is found to be substantially correct, deposited fee of the complainant would be refunded without any interest.

10 Implementation monitoring by Ministry of Steel

- 10.1 The policy provisions shall be applicable for a period of 5 years from the date of publication. The policy period may further be extended at the discretion of Ministry of Steel.
- 10.2 MoS shall be the nodal ministry to monitor the implementation of the policy.
- 10.3 All applicable agencies under DMI&SP policy shall ensure implementation of the policy and shall annually, in the month of June, send a declaration indicating the extent of compliance to the policy and reasons for noncompliance thereof, during the preceding financial year.

Reference to Ministry of Steel

In case of a question whether an item being procured is a DMI&SP to be covered under the policy, the matter would be referred to the Ministry of Steel for clarification.

Appendix A - Exclusive for domestically manufactured products

Sl. No.	Indicative list of Iron & Steel Products	Applicable HS code	Minimum domestic value addition requirement
1	Flat-rolled products of iron or non alloy steel, of a width of 600 mm or more, hot rolled, not clad, plated or coated	7208	50%
2	Flat-rolled products of iron or non alloy steel, of a width of 600 mm or more, cold rolled (cold-reduced), not clad, plated or coated	7209	50%
3	Flat-rolled products of iron or non alloy steel, of a width of 600 mm or more, clad, plated or coated	7210	50%

4	Flat-rolled products of iron or non alloy steel, of a width of less than 600 mm, not clad, plated or coated	7211	35%
5	Flat-rolled products of iron or non alloy steel, of a width of less than 600 mm, clad, plated or coated	7212	35%
6	Bars and rods, hot-rolled, in irregularly wound coils, of iron or non-alloy steel	7213	35%
7	Other bars and rods of iron or non alloy steel, not further worked than forged, hot rolled, hot-drawn or hot-extruded, but including those twisted after rolling	7214	35%
8	Other bars and rods of iron or non alloy steel	7215	35%
9	Angles, shapes and sections of iron or non-alloy steel	7216	35%
10	Wire of iron or non-alloy steel	7217	50%
11	Flat-rolled products of stainless steel, of a width of 600 mm or more	7219	50%
12	Flat-rolled products of stainless steel, of a width of less than 600 mm	7220	50%
13	Other bars and rods of stainless steel; angles, shapes and sections of stainless steel	7222	50%
14	Wire of other alloy steel	7229	35%
15	Rails, railway or tramway track construction material of iron or steel	7302	50%
16	Tubes, pipes and hollow profiles, of cast iron	7303	35%
17	Tubes, pipes and hollow profiles, seamless, of iron (other than cast iron) or steel	7304	35%
18	Other tubes and pipes (for example, welded, riveted or similarly closed), having circular cross-sections, the external diameter of which exceeds 406.4 mm, of iron or steel	7305	35%
19	Other tubes, pipes and hollow profiles (for example, open seam or welded, riveted or similarly closed), of iron or steel	7306	35%
20	Tube or pipe fittings (for example, connectors/couplings, elbow sleeves), of iron or steel	7307	35%
21	Bars and rods, hot-rolled, in irregularly wound coils, of stainless steel	7221	35%
22	Wire of stainless steel	7223	35%
23	Flat-rolled products of other alloy steel, of a width of 600 mm or more, including electrical steel	7225	35%
24	Flat-rolled products of other alloy steel, of a width of less than 600 mm, including electrical steel	7226	35%
25	Bars and rods, hot-rolled, in irregularly wound coils, of other alloy steel	7227	15%
26	Other bars and rods of other alloy steel; angles, shapes and sections, of other alloy steel; hollow drill bars and rods, of alloy or nonalloy steel	7228	35%
27	Sheet piling of iron or steel, whether or not drilled, punched or made from assembled elements; welded angles, shapes and sections, of iron or steel	7301	15%
28	Structures (excluding prefabricated buildings of heading 9406) and parts of structures	7308	15%
29	Reservoirs, tanks, vats and similar containers for any material (other than compressed or liquefied gas), of iron or steel, of a capacity exceeding 300 whether or not lined or heatinsulated, but not fitted with mechanical or Thermal equipment	7309	15%

30	Tanks, casks, drums, cans, boxes and similar containers, for any material (other than compressed or liquefied gas), of iron or steel, of a capacity not exceeding 300 L, whether or not lined or heat-insulated, but not fitted with mechanical or thermal equipment	7310	15%
31	Containers for compressed or liquefied gas, of iron or steel	7311	15%
32	Stranded wire, ropes, cables, plaited bands, slings and the like, of iron or steel, not electrically insulated	7312	15%
33	Barbed wire of iron or steel; twisted hoop or single flat wire, barbed or not, and loosely twisted double wire, of a kind used for fencing, of iron or steel	7313	15%
34	Grill, netting and fencing, of iron or steel wire; expanded metal of iron or steel	7314	15%
35	Chain and parts thereof, of iron or steel	7315	15%
36	Anchors, grapnels and parts thereof, of iron or steel	7316	15%
37	Articles of iron and steel	7317	15%
38	Articles of iron and steel	7318	15%
39	Articles of iron and steel	7319	15%
40	Springs and leaves for springs, of iron or steel	7320	15%
41	Stoves, ranges, grates, cookers (including those with subsidiary boilers for central heating), barbecues, braziers, gas-rings, plate warmers and similar non-electric domestic appliances, and parts thereof, of iron or steel	7321	15%
42	Radiators for central heating, not electrically heated, and parts thereof, of iron or steel; air heaters and hot air distributors, not electrically heated, incorporating a motor-driven fan or blower, and parts thereof, of iron or steel	7322	15%
43	Tables and similar household articles and parts thereof, of iron or steel	7323	15%
44	Sanitary ware and parts thereof, of iron or steel	7324	15%
45	Other cast articles of iron or steel	7325	15%
46	Electrical steel and other articles of iron or steel	7326	15%
47	Railway or tramway passenger coaches, not self-propelled	8605	50%
48	Railway or tramway goods vans and wagons, not self-propelled	8606	50%
49	Parts of railway or tramway locomotives or rolling-stock; such as bogies, bissel-bogies, axles and forged wheels, and parts thereof	8607	50%

Products included in descriptions are indicative; all products under the specified HS codes are included as part of the appendix

Appendix B

Indicative list of capital goods(non-exhaustive) for manufacturing iron & steel products

Sl. No.	Plant shop	Capital goods	Minimum domestic value addition requirement
1	Raw material handling system	Apron feeder, barrel couplings, heavy duty bearings, hydraulic disc brakes, tanker & container for powdered materials, conveyor belt for pipe conveyors, high angle conveyor system, crushers, crane rail lubrication system, four girder EOT Crane, crane weighing system, crane air conditioning, fluid couplings, fork lift trucks, hydraulic motors, hydraulic system, locking assembly (friction grip), load cells, level sensors, pipe	50%

		conveyor system, plough/ paddle feeder, pneumatic transportation - dense & lean phase, reclaimers, radio remote control, rail fixing arrangements (special), rapid/ flood loading system, stackers, special screen, slew ring bearings, tipplers, transfer cars, tongs (special), vibration, isolation system (spring damper), wagon tipplers, wagon loaders	
2	Mineral beneficiation (iron ore and coal) equipment	Industrial crushers, grinding mills, conventional screens, slurry pumps, hire thickeners, filters, hydroclones	50%
3	Coke oven	Coke Oven Silica Refractory, Anchorage System, Waste gas valve with branch pipe, Flash Plate, Door Frame, door body, Minor Casting: Gooseneck, Valve box, AP Lid, Charging & inspection hole lid and frame Reversing mechanism, Centralised lubrication system, Hydrojet Door Cleaning Mechanism, Spillage code conveyor system, skip hoist, Door Lowering Rack, Isolation/ Reversing Cocks, Level II automation, Oven machines	50%
4	By-product plant	Primary Gas Cooler, Electrostatic Tar Precipitator, H ₂ S, NH ₃ & Naphthalene Scrubber, Combi Stripper, Flushing Liquor Pump, Claus Kiln, Claus reactors, Waste Heat Boilers, Decanters	50%
5	Sinter plant equipment	Pallet car, Drive/discharge end Sprocket assembly, Curved rail, Slide rails, Hot sinter breaker and Grizzly, Dip rail & running rail, Impeller assembly for Process fan, Drive assembly of Sinter machine, Hi-intensity Mixer & Noduliser	50%
6	Pellet plant equipment	Pallet car, Drive/discharge end Sprocket assembly, Curved rail, Slide rails, running rail, Vertical roller mill, Impeller assembly for Process fan, Drive assembly of Indurating machine, Hi-intensity Mixer, Balling disc, Single deck roller screen and Double deck roller screen	50%
7	Blast furnace equipment	Bell less top system with Bleeder valve, SG Iron stove coolers, Copper stove coolers, Stock level indicator (Radar Type), Mud gun, Drilling machine and Manipulator, Gas Cleaning Plant system, Top Recovery Turbine system including its by-pass valve, De-bricking Machine, Re-railing equipment, PCI system, Grinding mill for PCI, Stock level indicator, Tuyere Stock assembly, Waste Heat Recovery system, BF & Hot Blast Stoves Technological Valves, Above Burden probes, Slag granulation unit, Tuyere & Tuyere cooler, Torpedo Ladle Car, BF hearth refractory	50%
8	Direct reduction plant equipment	Charge distributor, Upper & lower seal leg, Reformer & Re-cuperator system, Burden feeders, Turbo-expander, Process Gas Compressor, Seal gas compressors & bottom seal gas compressors, Seal gas generators & driers, Process Gas Heater, CO ₂ removal plant	50%
9	Basic oxygen furnace equipment	Main and Maintenance equipment comprising of converter, gunning machine, Refractory/ slag monitoring device, converter vessel, trunnion ring and suspension system, trunnion bearings and housing, Converter bull gear unit and tilt drive system, Rotary joint for converter, bottom stirring system, Lance body with clamping, Lance copper tips, Valve stations for oxygen blowing/ bottom stirring, Sub-lance system, Off gas analyzer with process module i.e. Process software/ hardware, container lab Measurement probes, Switch over station, ID fan for primary gas, Hot metal and steel ladle, Ladle Transfer car, Ladle maintenance equipment, Slag pot, Slag pot transfer car, Scrap boxes, Scrap Transfer car, Lance carriage, Lance guide, Crane & hoist, Lance hoist & trolley, Lance tilting device, Traverse for lifting lances, Bunker of various sizes, Bin Vibrator, Weighing Hopper, Maintenance stands, De dusting suction hood, Teeming/HM, ladle relining stands, Stand Cooling stack inspection device, Hood traverse carriage, Refractories, Bypass & isolation valves, Flare stack & ignition system, Scrubbing tower	50%

		shell - Wet gas cleaning system, Dog house, Ladle drier, ladle pre-heater, ladle cooler, Fume collection hoods, Clean gas stack, Dust silo, Weigh Bridge, Slag retaining device	
10	Electric arc furnace	Furnace proper (includes furnace lower shell, upper shell and roof, Tilting platform, Furnace Gantry) and transformer, Electrode regulation system, Hydraulic system, Refractories, Parts of Level I & Level II Automation system. LF - water cooled ladle roof, electrode mast and arms, electrode regulating system, wire feeding system, Bottom inert gas stirring Valve stand for porous plug and top lance, Emergency lance mechanism, Lance carriage system with drive unit, Automatic temperature, sampling & bath level / O ₂ measurement, Temp. & oxygen immersion lance, lance carriage system with drive unit, Hydraulic system, Refractories, Ladle roof Delta portion, RH proper (includes Ladle transfer car, vacuum vessel, Vessel lifting & lowering system. Hydraulic system, Multi Function lance, Valve racks/station, Electrode clamp unit, conductor of electrode arms, water cooled cable, A R stirring valve rack, lance transport car, Refractory lance, Hydraulic cylinder, Ladle roof lifting cylinder, Lubrication system, Suction hood, damper, Vibro feeder, weighing hopper, wire feeding system, Electrode nipping stand, Cranes, hoist, Temperature & sampling tips, ladle stands, ESP, Deducing hoods, Refractories, bag filter, Cranes etc.	50%
11	Continuous casting equipment	Ladle turret, ladle cover manipulator, Ladle Shroud manipulator, tundish car, Continuous tundish temperature measurement system, Tundish stopper rod mechanism, emergency cut-off gate, mould assembly, Nozzle quick change device, mould oscillator and EMS system. Electro-Magnetic braking system, Strand guide segment, Withdrawal & Straightening unit (WSU), Roll gap checker, Emergency torch cutter, Torch cutting machine, Deburrer, Marking machine, Technological control system & process models, Black Refractories, strand gunde segment, tundish, ladle cover, roller tables & auxiliaries, mould& segment maintenance equipments, tundish maintenance equipments, EMBR system	50%
12	Flat product mills	Large castings and forgings like mill housing, bed plates, work rolls, backup rolls, end spindles; roller tables, backup roll and work roll chucks, coilers / tension reels / uncoilers, AGC cylinders, shears, levelers, lazer welders, packaging machines, non-contact gauges / profile gauges, anti-friction roll neck bearings, oil film bearings, gear boxes, mill motors	50%
13	Long product mills	Mill housing, bed plates, work rolls, backup rolls, spindles; roller tables, coilers / tension reels / uncoilers, shears, billet welder, packaging machines, non-contact gauges / profile gauges, anti-friction roll neck bearings, oil film bearings, finishing blocks, gear boxes, mill motors	50%

**Items in appendix B are an indicative list of capital goods for manufacturing steel, the list is not exhaustive. All capital goods for steel manufacturing shall be considered for purchase preference under the policy with a minimum domestic value addition requirement of 50%*

Form-1

Format for Affidavit of Self Certification regarding Domestic Value Addition in Iron & Steel Products/capital goods to be provided on Rs.100/- Stamp Paper Date:

I _____ S/o, D/o, W/o, _____ Resident of _____ hereby solemnly affirm and declare as under:

That I will agree to abide by the terms and conditions of the policy of Government of India issued vide Notification No: _____.

That the information furnished hereinafter is correct to the best of my knowledge and belief and I undertake to produce relevant records before the procuring agency (ies) for the purpose of assessing the domestic value addition.

That the domestic value addition for all inputs which constitute the said iron & steel products has been verified by me and I am responsible for the correctness of the claims made therein.

That in the event of the domestic value addition of the product mentioned herein is found to be incorrect and not meeting the prescribed value-addition criteria, based on the assessment of procuring agency (ies) for the purpose of assessing the domestic value-addition, I will be disqualified from any Government tender for a period of 36 months. In addition, I will bear all costs of such an assessment.

That I have complied with all conditions referred to in the Notification No. _____ wherein preference to domestically manufactured iron & steel products in Government procurement is provided and that the procuring agency (ies) is hereby authorized to forfeit and my EMD. I also undertake to pay the assessment cost and pay all penalties as specified in the tender document.

I agree to maintain the following information in the Company's record for a period of 8 years and shall make this available for verification to any statutory authority.

- i. Name and details of the Bidder (Registered Office, Manufacturing unit location, nature of legal entity)
- ii. Date on which this certificate is issued
- iii. Iron & Steel Products for which the certificate is produced
- iv. Procuring agency to whom the certificate is furnished
- v. Percentage of domestic value addition claimed and whether it meets the threshold value of domestic value addition prescribed
- vi. Name and contact details of the unit of the manufacturer (s)
- vii. Net Selling Price of the iron & steel products
- viii. Freight, insurance and handling till plant
- ix. List and total cost value of input steel (imported) used to manufacture the iron & steel products
- x. List and total cost of input steel which are domestically sourced.
- xi. Please attach domestic value addition certificates from suppliers, if the input is not in house.
- xii. For imported input steel, landed cost at Indian port with break-up of CIF value, duties & taxes, port handling charges and inland freight cost.

For and on behalf of (Name of firm / entity)

Authorized signatory (To be duly authorized by the Board of Directors)

<Insert Name, Designation and Contact No.>



सत्यमेव जयते

भारत का राजपत्र

The Gazette of India

सी.जी.-डी.एल.-अ.-04012021-224171
CG-DL-E-04012021-224171

असाधारण
EXTRAORDINARY

भाग II—खण्ड 3—उप-खण्ड (i)
PART II—Section 3—Sub-section (i)

प्राधिकार से प्रकाशित
PUBLISHED BY AUTHORITY

सं. 1]
No. 1]

नई दिल्ली, शुक्रवार, जनवरी 1, 2021/पौष 11, 1942
NEW DELHI, FRIDAY, JANUARY 1, 2021/PAUSHA 11, 1942

इस्पात मंत्रालय

अधिसूचना

नई दिल्ली, 31 दिसम्बर, 2020

सा.का.नि. 1(अ).—सरकारी प्रापण में देशी निर्मित लोहा और इस्पात उत्पादों को प्राथमिकता प्रदान करने हेतु नीति (डीएमआई एंड एसपी नीति) - परिशोधित, 2019 में संशोधनों को आम सूचना के लिए एतद्वारा प्रकाशित किया जाता है:

"सं. S-13026/1/-2020-आईडीडी

इस्पात मंत्रालय

आईडीडी प्रभाग

उद्योग भवन,

नई दिल्ली 31 दिसंबर, 2020

विषय : सरकारी खरीद में घरेलू निर्मित लोहा और इस्पात उत्पादों को प्राथमिकता प्रदान करने की नीति-परिशोधित, 2019-में संशोधन/परिवर्धन

सरकारी खरीदमें स्वदेशी निर्मित लोहा और इस्पात उत्पादों को प्राथमिकता प्रदान करने की नीति-परिशोधित, 2019-(डीएमआईएंडएसपी परिशोधित, 2019) में निम्नलिखित संशोधन/ परिवर्धन तत्काल प्रभाव से लागू हैं। ये संशोधन/

परिवर्धन ऐसी निविदा या खरीद पर लागू नहीं होंगे जिनके लिए निविदा आमंत्रित करने वाला नोटिस अथवा अन्य प्रकार का खरीद अधिवाचन इस अधिसूचना के जारी होने से पूर्व जारी हुआ है।

1 - संशोधन:तालिका 1

क्रम सं.	डीएमआईएंडएसपी परिशोधित 2019 ,में मौजूदा खंड	डीएमआईएंडएसपी परिशोधित 2019 ,में संशोधित खंड
1	<p>खंड 1.3:</p> <p>यह नीति सरकार के प्रत्येक मंत्रालय अथवा विभाग और उनके प्रशासनिक नियंत्रण के अधीन सभी एजेंसियों/ प्रतिष्ठानों तथा सरकारी परियोजनाओं के वास्ते लौह एवं इस्पात उत्पादों की खरीद के लिए इन एजेंसियों द्वारा वित्तपोषित परियोजनाओं पर लागू है। हालांकि, यह नीति वाणिज्यिक पुनः बिक्री के उद्देश्य से अथवा वाणिज्यिक बिक्री के लिए वस्तुओं के उत्पादन में उपयोग करने के उद्देश्य से लौह एवं इस्पात उत्पादों की खरीद पर लागू नहीं होगी।</p>	<p>खंड 1.3:</p> <p>यह नीति सरकार के प्रत्येक मंत्रालय अथवा विभाग और उनके प्रशासनिक नियंत्रण के अधीन सभी एजेंसियों/ प्रतिष्ठानों तथा सरकारी परियोजनाओं के वास्ते लौह एवं इस्पात उत्पादों की खरीद के लिए इन एजेंसियों द्वारा वित्त पोषित परियोजनाओं पर लागू है। केन्द्रीय क्षेत्र की सभी योजनाएं (सीएस)/ केन्द्रीय प्रायोजित योजनाएं (सीएसएस) जिनके लिए राज्यों और स्थानीय निकायों द्वारा खरीद की जाती है, इस नीति की परिधि में आएंगी यदि उस परियोजना/योजना को भारत सरकार द्वारा पूर्णतया/ अंशतः वित्तपोषित किया जाता है।</p> <p>हालांकि, यह नीति वाणिज्यिक पुनः बिक्री के उद्देश्य से अथवा वाणिज्यिक बिक्री के लिए वस्तुओं के उत्पादन में उपयोग करने के उद्देश्य से लौह एवं इस्पात उत्पादों की खरीद पर लागू नहीं होगी।</p>
2	<p>खंड 2.13:</p> <p>घरेलू मूल्यवर्धन निवल बिक्री कीमत(निवलघरेलू करों और शुल्कों को छोड़कर बीजक कीमत) होगी जिससे प्रतिशत में निवल बिक्री कीमत के एक अनुपात के रूप में भारत में निर्माण संयंत्र(सभी सीमा शुल्कों सहित) में आयात की गई इनपुट सामग्री की पहुंच लागत घटाई गई हो, 'घरेलू मूल्यवर्धन'परिभाषा डी पी आई आई टी (पूर्व में डी आई पी पी) के दिशानिर्देशों के अनुरूपहोगी और उसमें भविष्य में डी पी आई आई टी द्वारा परिवर्तन किये जाने की स्थिति में उपयुक्त रूप से संशोधन किया जायेगा। इस नीति दस्तावेज के प्रयोजन के लिए घरेलूमूल्यवर्धन और स्थानीय विषय वस्तु का उपयोग एक दूसरे के स्थान पर किया गया है।</p>	<p>खंड 2.13:</p> <p>घरेलू मूल्यवर्धन का तात्पर्य है- भारत में वर्धित मूल्य की राशि जो खरीदी/बेची जाने वाली वस्तुओं का कुल मूल्य होगा (निवल घरेलू अप्रत्यक्ष करों को छोड़कर)- खरीदी/बेची जाने वाली वस्तुओं के कुल मूल्य के समानुपात के रूप में प्रतिशत में मद में आयातित सामग्री का मूल्य (सभी सीमा शुल्कों सहित)। घरेलू मूल्यवर्धन निवल बिक्री कीमत (निवल घरेलू करों और शुल्कों को छोड़कर बीजक कीमत) होगी जिससे प्रतिशत में निवल बिक्री कीमत के एक अनुपात के रूप में भारत में निर्माण संयंत्र (सभी सीमा शुल्कों सहित) में आयात की गई इनपुट सामग्री की पहुंच लागत घटाई गई हो, 'घरेलू मूल्यवर्धन'परिभाषा डी पी आई आई टी (पूर्व में डी आई पी पी) के दिशानिर्देशों के अनुरूप होगी और उसमें भविष्य में डी पी आई आई टी द्वारा परिवर्तन किये जाने की स्थिति में उपयुक्त रूप से संशोधन किया जायेगा। इस नीति दस्तावेज के प्रयोजन के लिए घरेलू मूल्यवर्धन और स्थानीय विषय वस्तु का उपयोग एक दूसरे के स्थान पर किया गया है।</p>

<p>3 खंड 5.1.5</p> <p>यह नीति सरकार के मंत्रालय अथवा विभाग के द्वारा वित्त-पोषित सभी परियोजनाओं और उनके प्रशासनिक नियंत्रण के अधीन सभी एजेंसियों/ प्रतिष्ठानों पर लौह एवं इस्पात उत्पादों की खरीद के लिए लागू है।</p>	<p>खंड 5.1.5</p> <p>यह नीति सरकार के मंत्रालय अथवा विभाग के द्वारा वित्त पोषित सभी परियोजनाओं और उनके प्रशासनिक नियंत्रण के अधीन सभी एजेंसियों/ प्रतिष्ठानों पर लौह एवं इस्पात उत्पादों की खरीद के लिए लागू है। केन्द्रीय क्षेत्र की सभी योजनाएं (सीएस)/ केन्द्रीय प्रायोजित योजनाएं (सीएसएस) जिनके लिए राज्यों और स्थानीय निकायों द्वारा खरीद की जाती है, इस नीति की परिधि में आएंगी यदि उस परियोजना/योजना को भारत सरकार द्वारा पूर्णतया/ अंशतः वित्तपोषित किया जाता है</p>
<p>4 खंड 5.1.6</p> <p>यह नीति उन परियोजनाओं पर लागू होगी जहां लौह एवं इस्पात उत्पादों का खरीद मूल्य 25 करोड़ रुपए से अधिक होता हो। यह नीति अन्य खरीद (गैर परियोजना) के लिए भी लागू होगी जहां उस सरकारी संगठन के लिए लौह एवं इस्पात उत्पादों का वार्षिक खरीद मूल्य 25 करोड़ रुपए से अधिक होता हो।</p>	<p>खंड 5.1.6</p> <p>यह नीति उन परियोजनाओं पर लागू होगी जहां लौह एवं इस्पात उत्पादों (डीएमआई एंड एसपी नीति का परिशिष्ट-क) का खरीद मूल्य 5लाख रुपए से अधिक होता हो। यह नीति अन्य खरीद (गैर परियोजना) के लिए भी लागू होगी जहां उस सरकारी संगठन के लिए लौह एवं इस्पात उत्पादों का वार्षिक खरीद मूल्य 5 लाख करोड़ रुपए से अधिक होता हो। तथापि, प्रापण इकाइयों द्वारा इस बात को सुनिश्चित किया जाएगा कि इस नीति के प्रावधानों से बचने के प्रयोजनार्थ खरीद का विभाजन न किया जाए।</p>
<p>5 खंड 7.2</p> <p>घरेलू मूल्यवर्धन निवल बिक्री कीमत (निवल घरेलू करों और शुल्कों को छोड़कर बीजककीमत) होगी जिसमें से प्रतिशत में निवल बिक्री कीमत के एक अनुपात के रूप में भारत में निर्माण करने वाले संयंत्र में आयात की गई इनपुट सामग्री की पहुंच लागत (सभी सीमा शुल्कों को शामिल करते हुए) घटाई जायेगी।</p>	<p>खंड 7.2</p> <p>घरेलू मूल्यवर्धन का तात्पर्य है- भारत में वर्धित मूल्य की राशि जो खरीदी/बेची जाने वाली वस्तुओं का कुल मूल्य होगा (निवल घरेलू अप्रत्यक्ष करों को छोड़कर)- खरीदी/बेची जाने वाली वस्तुओं के कुल मूल्य के समानुपात के रूप में प्रतिशत में मद में आयातित सामग्री का मूल्य (सभी सीमा शुल्कों सहित)।</p>
<p>6 खंड 7.3</p> <p>यह सिफारिश की जाती है कि निविदा की प्रक्रिया में भाग लेने वाले प्रत्येक बोली लगाने वाले को नीचे दिए गए सूत्र का उपयोग करते हुए घरेलू मूल्यवर्धन की गणना करनी चाहिए ताकि यह सुनिश्चित किया जा सके कि दावा किये गये घरेलू मूल्यवर्धन इस नीति के न्यूनतम निर्धारित घरेलू मूल्यवर्धन के अनुरूप है।</p> <p>लौह एवं इस्पात उत्पादों के लिए % घरेलू मूल्यवर्धन</p> <p>अंतिम उत्पाद की निवल बिक्री कीमत- संयंत्र में आयात किये गये लौह अथवा इस्पात की पहुंच लागत----- X100%</p>	<p>खंड 7.3</p> <p>यह सिफारिश की जाती है कि प्रापण करने वाली सरकारी एजेंसी/ निविदा की प्रक्रिया में भाग लेने वाले प्रत्येक बोली लगाने वाले को नीचे दिए गए सूत्र का उपयोग करते हुए घरेलू मूल्यवर्धन की गणना करनी चाहिए ताकि यह सुनिश्चित किया जा सके कि दावा किये गये घरेलू मूल्यवर्धन इस नीति के न्यूनतम निर्धारित घरेलू मूल्यवर्धन के अनुरूप है।</p> <p>लौह एवं इस्पात उत्पादों तथा पूंजीगत माल के लिए % घरेलू मूल्यवर्धन</p> <p>खरीदी/बेची जाने वाली वस्तु का कुल मूल्य (निवल घरेलू अप्रत्यक्ष करों को छोड़कर - मद में आयातित सामग्री का मूल्य (सभी सीमा शुल्कों सहित) ----- -----X100%</p>

अंतिम उत्पाद की निवल ब्रिकी कीमत पूँजीगत माल के लिए % घरेलू मूल्यवर्धन अंतिम उत्पाद की निवल ब्रिकी कीमत- संयंत्र में आयात किये गये इनपुट सामग्री की पहुंच लागत-----X 100% अंतिम उत्पाद की निवल ब्रिकी कीमत	खरीदी/बेची जाने वाली वस्तु का कुल मूल्य
--	---

II डीएमआईएंडएसपी परिशोधित, 2019 के परिशिष्ट क में निम्नलिखित संशोधन किया जाता है:- जहां कहीं न्यूनतम घरेलू मूल्य वर्धन आवश्यकता कॉलम के अंतर्गत डीएमआईएंडएसपी परिशोधित, 2019 के परिशिष्ट क में 15% का न्यूनतम घरेलू मूल्य वर्धन विनिर्दिष्ट होगा, वहां उसे 20% न्यूनतम घरेलू मूल्यवर्धन से प्रतिस्थापित कर दिया जाएगा (परिशोधित परिशिष्ट-क संलग्न है)

III- परिवर्धन/सन्निवेशन: तालिका 2

क्रम सं	डीएमआईएंडएसपी परिशोधित, 2019 में शामिल/जोड़े गये खंड
1	<p>खण्ड 5.1.13 को खण्ड 5.1.12 के नीचे निम्नवत जोड़ा जाता है:</p> <p>खण्ड 5.1.13: लोहे और इस्पात उत्पादों की खरीद से संबंधित निविदाओं के लिए कोई वैश्विक निविदा इन्क्वायरी (जीटीई) आमंत्रित नहीं की जाएगी (डीएमआई और एसपी नीति का परिशिष्ट-क)। लोहे और इस्पात उत्पादों के विनिर्माण जिनका अनुमानित मूल्य 200 करोड़ रु तक हो, (डीएमआई और एसपी नीति के परिशिष्ट- ख) के लिए पूँजीगत सामानों की खरीद से संबंधित निविदाओं के लिए कोई वैश्विक निविदा इन्क्वायरी (जीटीई) व्यय विभाग द्वारा यथा नाम-निर्दिष्ट सक्षम प्राधिकारी के अनुमोदन के अलावा आमंत्रित नहीं की जाएगी,</p>
2	<p>खंड 6.9 को खंड 6.8 के नीचे निम्नवत जोड़ा जाता है:</p> <p>खंड 6.9: निविदाओं और अन्य खरीद अधियाचनों में विनिर्देशन:</p> <p>6.9.1 प्रत्येक क्रय इकाई यह सुनिश्चित करेगी कि किसी भी निविदा या अधियाचन में निर्धारित पिछले अनुभव के संबंध में पात्रता की शर्तों हेतु अन्य देशों में आपूर्ति के प्रमाण या निर्यात के प्रमाण की आवश्यकता नहीं है।</p> <p>6.9.2 क्रय इकाईयों यह देखने का प्रयास करेंगी कि पात्रता की शर्तों, जैसे टर्नओवर, उत्पादन क्षमता और वित्तीय ताकत जैसे मामलों में वैसे स्थानीय आपूर्तिकर्ता का अनुचित अपवर्जन नहीं होता है जो आपूर्तिकर्ता की गुणवत्ता या साख संबंधी पात्रता सुनिश्चित करने के लिए जो आवश्यक है, उससे परे अन्यथा पात्र होंगे।</p> <p>6.9.3 क्रय इकाईयों, इस नीति के जारी होने के 2 महीने के भीतर ऊपर उप-पैराग्राफ 6.9.1 और 6.9.2 के संदर्भ में सभी मौजूदा पात्रता मानदंडों और शर्तों की समीक्षा करेंगी।</p> <p>6.9.4 यदि इस्पात मंत्रालय इस बात से संतुष्ट है कि लौह और इस्पात उत्पादों के भारतीय आपूर्तिकर्ताओं को प्रतिबंधात्मक निविदा शर्तों के कारण किसी भी विदेशी सरकार द्वारा खरीद में भाग लेने और / या प्रतिस्पर्धा करने की अनुमति नहीं है, जिसका भारतीय कंपनियों को प्रतिबंधित करने पर प्रत्यक्ष या अप्रत्यक्ष प्रभाव पड़ता है, जैसे कि प्रापण देश में पंजीकरण, प्रापण देश इत्यादि में विशिष्ट मूल्य की परियोजना का निष्पादन इत्यादि। यदि उपयुक्त समझा जाएगा तो उस देश के बोलीदाताओं को इस्पात मंत्रालय से संबंधित उस वस्तु तथा/ या अन्य वस्तुओं की खरीद के लिए पात्रता से प्रतिबंधित या अपवर्जित किया जा सकता है।</p> <p>6.9.5 ऊपर उप-पैरा 6.9.4 के प्रयोजन से, किसी आपूर्तिकर्ता या बोलीदाता को उस देश से माना जाएगा यदि (i) इकाई को उस देश में निगमित किया गया है, या (ii) उसकी शेयरधारिता या इकाई का प्रभावी नियंत्रण उस देश से किया जाता है; या (iii) आपूर्ति की जा रही वस्तु के मूल्य का 50% से अधिक उस देश में शामिल किया गया है। भारतीय आपूर्तिकर्ताओं का अर्थ उन संस्थाओं से होगा जो भारत के संबंध में इनमें से किसी भी मानदंड को पूरा करते हैं। किसी देश की 'इकाई' (एन्टिटी) शब्द का अर्थ वहीं होगा जो डीपीआईआईटी की एफडीआई नीति के तहत समय-समय पर यथा संशोधित के अंतर्गत है।</p>

3	<p>खंड 6.10 को खंड 6.9 के नीचे निम्नवत जोड़ा जाता है:</p> <p>खंड 6.10: यदि घरेलू आपूर्तिकर्ताओं के खिलाफ प्रतिबंधात्मक या भेदभावपूर्ण शर्तों को बोली दस्तावेजों में शामिल किया जाता है, तो उस के लिए जिम्मेदारी तय करने के लिए खरीद (इसके प्रशासनिक नियंत्रणाधीन किसी ईकाई द्वारा खरीद सहित) करने वाले प्रशासनिक विभाग द्वारा जांच शुरू की जाएगी। तत्पश्चात्, संबंधित प्रावधानों के तहत खरीद संस्थाओं के अधिकारियों के खिलाफ उचित, प्रशासनिक या अन्यथा कार्रवाई की जाएगी। ऐसी सभी कार्रवाई की सूचना डीएमआई और एसपी नीति के तहत स्थायी समिति को भेजी जाएगी।</p>
---	---

संशोधित परिशिष्ट क - घरेलू स्तर पर निर्मित उत्पादों के लिए विशिष्ट रूप से

क्र. सं.	लौह एवं इस्पात उत्पादों की सांकेतिक सूची	लागू एच एस कोड	न्यूनतम घरेलू मूल्यवर्धन आवश्यकता
1	600 मि. मी. अथवा उससे अधिक की चौड़ाई वाले लौह अथवा गैर एलॉय इस्पात का फ्लेट रोल उत्पाद, हॉट रोल्ड, न ढका हुआ, प्लेट लगाया हुआ अथवा कोट किया हुआ	7208	50%
2	600 मि. मी. अथवा उससे अधिक की चौड़ाई वाले लौह अथवा गैर एलॉय इस्पात का फ्लेट रोल उत्पाद, कोल्ड रोल्ड (कोल्ड - कम किया हुआ), न ढका हुआ, प्लेट लगाया हुआ अथवा कोट किया हुआ	7209	50%
3	600 मि. मी. अथवा उससे अधिक की चौड़ाई वाले लौह अथवा गैर एलॉय इस्पात का फ्लेट रोल उत्पाद, ढका हुआ, प्लेट लगाया हुआ अथवा कोट किया हुआ	7210	50%
4	600 मि. मी. से कम की चौड़ाई वाले लौह अथवा गैर एलॉय इस्पात का फ्लेट रोल उत्पाद, न ढका हुआ, प्लेट लगाया हुआ अथवा कोट किया हुआ	7211	35%
5	600 मि. मी. कम की चौड़ाई का लौह अथवा गैर एलॉय इस्पात का फ्लेट रोल उत्पाद, ढका हुआ, प्लेट लगाया हुआ अथवा कोट किया हुआ	7212	35%
6	लौह एवं गैर एलॉय इस्पात का अनियमित रूप से ऎंठा हुआ क्वाइल में बार्स और रॉड, हॉट रोल्ड	7213	35%
7	लौह अथवा गैर एलॉय इस्पात के अन्य बार्स और रॉड्स जिसे फोर्ज किए जाने की तुलना में आगे अधिक वर्क नहीं किया हुआ, हॉट रोल्ड, हॉट ड्रॉन अथवा हॉट एक्सट्रूडेड परंतु रोलिंग के बाद उसे टिबिस्ट किये जाने सहित	7214	35%
8	लौह अथवा गैर एलॉय इस्पात का अन्य बार्स एंड रोड्स	7215	35%
9	लौह अथवा गैर एलॉय इस्पात का एंगल, शेष और सेक्शन्स	7216	35%
10	लौह अथवा गैर एलॉय इस्पात का तार	7217	50%
11	600 मि. मी. अथवा उससे अधिक की चौड़ाई का स्टेनलैस इस्पातका फ्लेट रोल्ड इस्पात	7219	50%
12	600 मि. मी. से कम की चौड़ाई का स्टेनलैस इस्पातका फ्लेट रोल्ड इस्पात	7220	50%
13	स्टेनलैस स्टील का अन्य बार्स और रोड्स; स्टेनलैस स्टील का एंगल शेष और सेक्शन्स	7222	50%
14	अन्य एलॉय इस्पात का तार	7229	35%
15	लौह अथवा इस्पात को रेल, रेलवे अथवा ट्रामवे ट्रेक निर्माण सामग्री	7302	50%

16	कास्ट लौह का ट्यूब, पाइप और होलो पाइप	7303	35%
17	लौह (कास्ट आयरन को छोड़कर) अथवा इस्पात का ट्यूब पाइप और होलो प्रोफाइल, सीमलैस	7304	35%
18	लौह अथवा इस्पात का सर्कुलर क्रॉस सेक्शन वाले अन्य ट्यूब और पाइप (उदाहरण के लिए, वेल्ड किया हुआ, रिबेट किया हुआ अथवा समान रूप से बंद किया गया हुआ), जिसकी बाहरी त्रिज्या 406.4 मि. मी. से अधिक हो	7305	35%
19	लौह अथवा इस्पात के अन्य ट्यूब, पाइप और होलो प्रोफाइल (उदाहरण के लिए ओपन सीन अथवा वेल्ड किया हुआ, रिबेट किया हुआ अथवा समान रूप से बंद किया गया हुआ)	7306	35%
20	लौह अथवा इस्पात का ट्यूब अथवा पाइप फिटिंग (उदाहरण के लिए, कनेक्टर/ कप्लिंग, एल्बो स्लीव्स)	7307	35%
21	स्टेनलैस स्टील का अनियमित रूप से ऎंठा हुआ क्वाइल में बार्स और रॉड, हॉट रोल्ड	7221	35%
22	स्टेनलैस स्टील का वायर	7223	35%
23	इलेक्ट्रिकल स्टील सहित 600 मि. मी. अथवा उससे अधिक की चौड़ाई वाले अन्य एलॉय स्टील का फ्लेट रोल्ड इस्पात	7225	35%
24	इलेक्ट्रिकल स्टील सहित 600 मि. मी. से कम की चौड़ाई वाले अन्य एलॉय स्टील का फ्लेट रोल्ड इस्पात	7226	35%
25	अन्य एलॉय स्टील का अनियमित रूप से ऎंठा हुआ क्वाइल में बार्स और रॉड, हॉट रोल्ड	7227	20%
26	अन्य एलॉय स्टील का अन्य बार्स और रॉड्स; अन्य एलॉय स्टील का एंगल, शेप्स और सेक्शन्स; एलॉय अथवा नॉन एलॉय स्टील का होलो ड्रिल बार्स और रॉड्स	7228	35%
27	लौह अथवा इस्पात की शीट पाइलिंग, चाहे ड्रिल किया हुआ हो अथवा नहीं, चाहे पंच किया हुआ हो अथवा नहीं, चाहे असेम्बल किये हुए तत्वों से बना हुआ हो अथवा नहीं; लौह अथवा इस्पात का वेल्ड किया हुआ एंगल, शेप और सेक्शन्स	7301	20%
28	स्ट्रक्चर्स (9406 के शीर्ष का प्रीफेब्रिकेटिड भवनों को छोड़कर) और स्ट्रक्चर्स का हिस्सा	7308	20%
29	300 से अधिक क्षमता का लौह अथवा इस्पात का किसी सामग्री (कम्प्रेस किए हुए अथवा सरलीकृत गैस को छोड़कर) के लिए भंडार, टैंक, वैट और समान कन्टेनर चाहे उसे लाइन किया गया हो अथवा नहीं या उसे हीट से इन्सुलेट किया गया हो अथवा नहीं लेकिन यांत्रिक अथवा तापीय उपक्रम से युक्त न हो	7309	20%
30	अधिकतम 300 लीटर की क्षमता का लौह अथवा इस्पात का किसी सामग्री (कम्प्रेस किए हुए अथवा सरलीकृत गैस को छोड़कर) के लिए टैंक, कास्ट, ड्रम, केन, बॉक्स और समान कन्टेनर चाहे उसे लाइन किया गया हो अथवा नहीं या उसे हीट से इन्सुलेट किया गया हो अथवा नहीं लेकिन यांत्रिक अथवा तापीय उपक्रम से युक्त न हो	7310	20%
31	लौह अथवा इस्पात का कम्प्रेस किया हुआ अथवा सरलीकृत गैस के लिए कन्टेनर	7311	20%

32	लौह अथवा इस्पात का स्टैंडिड वायर, रोप, केबल, प्लेटिड बैंड, स्लिंग और उसके समान वस्तु जिसे विद्युतीय रूप से इन्सुलेट न किया गया	7312	20%
33	लौह अथवा इस्पात का फेनसिंग के लिए उपयोग किये जाने वाला बार किया हुआ वायर; ट्विस्ट किया हुआ हूप अथवा सिंगल फ्लेट वायर, बार्स किया हुआ अथवा नहीं और लूज तरीके से ट्विस्ट किया हुआ डबल वायर	7313	20%
34	लौह अथवा इस्पात तार का ड्रील, नेटिंग और फेनसिंग; लौह अथवा इस्पात का विस्तार किया हुआ धातु	7314	20%
35	लौह अथवा इस्पात का चैन और उसका हिस्सा	7315	20%
36	लौह अथवा इस्पात का टैंकर, ग्रेपनेल्स और उसका हिस्सा	7316	20%
37	लौह एवं इस्पात की वस्तुएं	7317	20%
38	लौह एवं इस्पात की वस्तुएं	7318	20%
39	लौह एवं इस्पात की वस्तुएं	7319	20%
40	लौह अथवा इस्पात का स्प्रिंग और स्प्रिंग के लिए लीव्स	7320	20%
41	लौह अथवा इस्पात का स्टोव्स, रेंज, ग्रेड, कूकर (केंद्रीय हिटिंग के लिए सहायक बायलरों के साथ उन वस्तुओं सहित), बारबेक्यूज, ब्रेजियर्स, गैस रिंग, प्लेट वामर्स और समान गैर-विद्युतीय घरेलू उपकरण और उसका हिस्सा	7321	20%
42	लौह अथवा इस्पात का केंद्रीय हिटिंग के लिए रेडियेटर जिसे विद्युतीय रूप से हीट न किया गया हो और उसका हिस्सा; लौह अथवा इस्पात का हेयर हीटर और हॉट एयर वितरक जिसे विद्युतीय रूप से हीट न किया गया हो, फेन अथवा ब्लोअर जो मोटर से चलती हो और उसके हिस्से को शामिल करते हुए	7322	20%
43	लौह अथवा इस्पात का टेबल और समान घरेलू वस्तुएं और उसका हिस्सा	7323	20%
44	लौह अथवा इस्पात का सेनेटरी वेयर और उसकेपार्ट्स	7324	20%
45	लौह अथवा इस्पात का अन्य कास्ट सामान	7325	20%
46	लौह अथवा इस्पात का विद्युतीय इस्पात और अन्य वस्तु	7326	20%
47	रेलवे अथवा ट्रामवे पेसेंजर कोच जो स्वयं आगे नहीं बढ़ता हो	8605	50%
48	रेलवे अथवा ट्रामवे माल वेन और वेगेन जो स्वयं आगे नहीं बढ़ता हो	8606	50%
49	रेलवे अथवा ट्रामवे लोकोमोटिव का हिस्सा अथवा रोलिंग स्टॉक जैसे बोगिज, बिसल बोगिज, एक्सेल और फोज्ड किया हुआ पहिया और उसका हिस्सा	8607	50%

विवरणों में शामिल किए गए उत्पाद सांकेतिक हैं; विनिर्दिष्ट एच एस कोड के अंतर्गत सभी उत्पादों को परिशिष्ट के भाग के रूप में शामिल किया गया है।"

[फा. सं. एस-13026/1/2020-आईडीडी]

रसिका चौबे, अपर सचिव

MINISTRY OF STEEL
NOTIFICATION

New Delhi, the 31st December, 2020

G.S.R. 1(E).—The amendments in the Policy for providing preference to domestically manufactured Iron & Steel products in Government procurement (DMI&SP Policy)—Revised, 2019 is hereby published for general information.

"No. S-13026/1/2020- IDD

Ministry of Steel

ID Division

Udyog Bhawan,

New Delhi 31st December, 2020

Sub.: Amendments / additions to the Policy for Providing Preference to Domestically Manufactured Iron & Steel Products in Government Procurement - revised, 2019

The following amendments / additions to the Policy for Providing Preference to Domestically Manufactured Iron & Steel Products in Government Procurement - revised, 2019 (DMI&SP revised, 2019) are applicable with immediate effect. These amendments / additions shall not apply to any tender or procurement for which notice inviting tender or other form of procurement solicitation has been issued before the issue of this notification.

I - Amendments: Table 1

Sl. No.	Existing Clause in DMI&SP revised, 2019	Amended Clause in DMI&SP revised, 2019
1	<p>Clause 1.3: The policy is applicable to every Ministry or Department of Government and all agencies/entities under their administrative control and to projects funded by these agencies for purchase of iron & steel products for government projects. However, this policy shall not apply for purchase of iron & steel products with a view to commercial resale or with a view to use in the production of goods for commercial sale.</p>	<p>Clause 1.3: The policy is applicable to every Ministry or Department of Government and all agencies/entities under their administrative control and to projects funded by these agencies for purchase of iron & steel products for government projects. <u>All Central Sector Schemes (CS)/Centrally Sponsored Schemes (CSS) for which procurement is made by States and Local Bodies, would come within the purview of this Policy, if that project / scheme is fully / partly funded by Government of India.</u> However, this policy shall not apply for purchase of iron & steel products with a view to commercial resale or with a view to use in the production of goods for commercial sale.</p>
2	<p>Clause 2.13: Domestic value addition shall be the net selling price (invoiced price excluding net domestic taxes and duties) minus the landed cost of imported input materials at the manufacturing plant in India (including all customs duties) as a proportion of the net selling price, in percent. The 'domestic value addition' definition shall be in line with the DPIIT (formerly DIPP) guidelines, and shall be suitably amended in case of any changes by DPIIT in the future. For the purpose of this policy document, domestic value addition and local content have been used interchangeably.</p>	<p>Clause 2.13: Domestic value addition means - <u>amount of value added in India which shall be the total value of the item to be procured / sold (excluding net domestic indirect taxes) minus the value of imported content in the item (including all customs duties) as a proportion of the total value of the item to be procured / sold, in percent.</u> The 'domestic value addition' definition shall be in line with the DPIIT (formerly DIPP) guidelines, and shall be suitably amended in case of any changes by DPIIT in the future. For the purpose of this policy document, domestic value addition and local content have been used interchangeably.</p>

3	<p>Clause 5.1.5 The policy is applicable to all projects funded by Ministry or Department of Government and all agencies/ entities under their administrative control for purchase of iron & steel products.</p>	<p>Clause 5.1.5: The policy is applicable to all projects funded by Ministry or Department of Government and all agencies/ entities under their administrative control for purchase of iron & steel products. <u>All Central Sector Schemes (CS)/Centrally Sponsored Schemes (CSS) for which procurement is made by States and Local Bodies, would come within the purview of this Policy, if that project / scheme is fully / partly funded by Government of India.</u></p>
4	<p>Clause 5.1.6: The policy shall be applicable to projects where the procurement value of iron and steel products is greater than Rs. 25 crores. The policy shall also be applicable for other procurement (non-project), where annual procurement value of iron and steel products for that Government organization is greater than Rs. 25 crores.</p>	<p>Clause 5.1.6 The policy shall be applicable to projects where the procurement value of iron and steel products (Appendix - A of the DMI&SP Policy) is greater than Rs. 5 lakhs. The policy shall also be applicable for other procurements (non-project), where annual procurement value of iron and steel products for that Government organization is greater than Rs. 5 lakhs. However, it shall be ensured by procuring entities that procurement is not split for the purpose of avoiding the provisions of this policy.</p>
5	<p>Clause 7.2: Domestic value addition shall be the net selling price (invoiced price excluding net domestic taxes and duties) minus the landed cost of imported input materials at the manufacturing plant in India (including all customs duties) as a proportion of the net selling price, in per cent.</p>	<p>Clause 7.2: Domestic value addition means - amount of value added in India which shall be the total value of the item to be procured / sold (excluding net domestic indirect taxes) minus the value of imported content in the item (including all customs duties) as a proportion of the total value of the item to be procured / sold, in percent.</p>
6	<p>Clause 7.3: It is recommended that each bidder participating in the tender process should calculate the domestic value addition using the below formula below so as to ensure the domestic value addition claimed is consistent with the minimum stipulated domestic value addition requirement of the policy.</p> <p>For iron and steel products</p> <p>% domestic value addition</p> <p><i>Net selling price of final product - landed cost of imported iron or steel at the plant-----</i> <i>----- X 100 %</i></p> <p><i>Net selling price of final product</i></p> <p>For capital goods</p> <p>% domestic value addition</p> <p><i>Net selling price of final product - landed cost of imported iron or steel at the plant</i> <i>----- X 100 %</i></p> <p><i>Net selling price of final product</i></p>	<p>Clause 7.3: It is recommended that procuring Government agency / bidder participating in the tender process should calculate the domestic value addition using the below formula so as to ensure that the domestic value addition claimed is consistent with the minimum stipulated domestic value addition requirement of the policy.</p> <p>For iron and steel products & capital goods</p> <p>% domestic value addition</p> <p><i>Total value of the item to be procured / sold (excluding net domestic indirect taxes) - the value of imported content in the item (including all customs duties)</i> <i>----- X 100 %</i></p> <p><i>Total value of the item to be procured / sold</i></p>

II - Following amendment is made to the Appendix A of the DMI&SP revised, 2019 :- Wherever minimum domestic value addition of **15%** is specified in the Appendix - A of the DMI&SP revised, 2019 under the column Minimum domestic value addition requirement, same shall be replaced with **20%** minimum domestic value addition). (Revised Appendix - A is attached)

III - Additions / Insertions: Table 2

Sl. No.	Added / Inserted Clause in DMI&SP revised, 2019
1	<p>Clause 5.1.13 is inserted below Clause 5.1.12 as:</p> <p>Clause 5.1.13: No Global Tender Enquiry (GTE) shall be invited for tenders related to procurement of iron and steel products (Appendix-A of the DMI&SP Policy). No Global Tender Enquiry (GTE) shall be invited for tenders related to procurement of Capital Goods for manufacturing iron & steel products (Appendix- B of the DMI&SP Policy) having estimated value upto Rs. 200 Crore except with the approval of competent authority as designated by Department of Expenditure.</p>
2	<p>Clause 6.9 is inserted below Clause 6.8 as:</p> <p>Clause 6.9: Specifications in Tenders and other procurement solicitations:</p> <p>6.9.1 Every procuring entity shall ensure that the eligibility conditions in respect of previous experience fixed in any tender or solicitation do not require proof of supply in other countries or proof of exports.</p> <p>6.9.2 Procuring entities shall endeavour to see that eligibility conditions, including on matters like turnover, production capability and financial strength do not result in unreasonable exclusion of local supplier' who would otherwise be eligible, beyond what is essential for ensuring quality or creditworthiness of the supplier.</p> <p>6.9.3 Procuring entities shall, within 2 months of the issue of this policy review all existing eligibility norms and conditions with reference to sub-paragraphs 6.9.1 and 6.9.2 above.</p> <p>6.9.4 If Ministry of Steel is satisfied that Indian suppliers of iron and steel products are not allowed to participate and/ or compete in procurement by any foreign government due to restrictive tender conditions which have direct or indirect effect of barring Indian companies such as registration in the procuring country, execution of project of specific value in the procuring country etc., it may, if deemed appropriate, restrict or exclude bidders from that country from eligibility for procurement of that item and/ or other items relating to Ministry of Steel.</p> <p>6.9.5 For the purpose of sub-paragraph 6.9.4 above, a supplier or bidder shall be considered to be from a country if (i) the entity is incorporated in that country, or (ii) a majority of its shareholding or effective control of the entity is exercised from that country; or (iii) more than 50% of the value of the item being supplied has been added in that country. Indian suppliers shall mean those entities which meet any of these tests with respect to India. The term 'entity' of a country shall have the same meaning as under the FDI Policy of DPIIT as amended from time to time.</p>
3	<p>Clause 6.10 is inserted below Clause 6.9 as:</p> <p>Clause 6.10: In case restrictive or discriminatory conditions against domestic suppliers are included in bid documents, an inquiry shall be conducted by the Administrative Department undertaking the procurement (including procurement by any entity under its administrative control) to fix responsibility for same. Thereafter, appropriate action, administrative or otherwise, shall be taken against erring officials of procurement entities under relevant provisions. Intimation on all such action shall be sent to the Standing Committee under the DMI&SP Policy.</p>

IV - Revised Appendix A - Exclusive for domestically manufactured products

Sl. No	Indicative list of Iron & Steel Products	Applicable HS code	Minimum domestic value addition requirement
1	Flat-rolled products of iron or non alloy steel, of a width of 600 mm or more, hot rolled, not clad, plated or coated	7208	50%
2	Flat-rolled products of iron or non alloy steel, of a width of 600	7209	50%

	mm or more, cold rolled (cold-reduced), not clad, plated or coated		
3	Flat-rolled products of iron or non alloy steel, of a width of 600 mm or more, clad, plated or coated	7210	50%
4	Flat-rolled products of iron or non alloy steel, of a width of less than 600 mm, not clad, plated or coated	7211	35%
5	Flat-rolled products of iron or non alloy steel, of a width of less than 600 mm, clad, plated or coated	7212	35%
6	Bars and rods, hot-rolled, in irregularly wound coils, of iron or non-alloy steel	7213	35%
7	Other bars and rods of iron or non alloy steel, not further worked than forged, hot rolled, hot-drawn or hot-extruded, but including those twisted after rolling	7214	35%
8	Other bars and rods of iron or non alloy steel	7215	35%
9	Angles, shapes and sections of iron or non-alloy steel	7216	35%
10	Wire of iron or non-alloy steel	7217	50%
11	Flat-rolled products of stainless steel, of a width of 600 mm or more	7219	50%
12	Flat-rolled products of stainless steel, of a width of less than 600 mm	7220	50%
13	Other bars and rods of stainless steel; angles, shapes and sections of stainless steel	7222	50%
14	Wire of other alloy steel	7229	35%
15	Rails, railway or tramway track construction material of iron or steel	7302	50%
16	Tubes, pipes and hollow profiles, of cast iron	7303	35%
17	Tubes, pipes and hollow profiles, seamless, of iron (other than cast iron) or steel	7304	35%
18	Other tubes and pipes (for example, welded, riveted or similarly closed), having circular cross-sections, the external diameter of which exceeds 406.4 mm, of iron or steel	7305	35%
19	Other tubes, pipes and hollow profiles (for example, open seam or welded, riveted or similarly closed), of iron or steel	7306	35%
20	Tube or pipe fittings (for example, connectors/couplings, elbow sleeves), of iron or steel	7307	35%
21	Bars and rods, hot-rolled, in irregularly wound coils, of stainless steel	7221	35%
22	Wire of stainless steel	7223	35%
23	Flat-rolled products of other alloy steel, of a width of 600 mm or more, including electrical steel	7225	35%
24	Flat-rolled products of other alloy steel, of a width of less than 600 mm, including electrical steel	7226	35%
25	Bars and rods, hot-rolled, in irregularly wound coils, of other alloy steel	7227	20%

26	Other bars and rods of other alloy steel; angles, shapes and sections, of other alloy steel; hollow drill bars and rods, of alloy or nonalloy steel	7228	35%
27	Sheet piling of iron or steel, whether or not drilled, punched or made from assembled elements; welded angles, shapes and sections, of iron or steel	7301	20%
28	Structures (excluding prefabricated buildings of heading 9406) and parts of structures	7308	20%
29	Reservoirs, tanks, vats and similar containers for any material (other than compressed or liquefied gas), of iron or steel, of a capacity exceeding 300 whether or not lined or heatinsulated, but not fitted with mechanical or Thermal equipment	7309	20%
30	Tanks, casks, drums, cans, boxes and similar containers, for any material (other than compressed or liquefied gas), of iron or steel, of a capacity not exceeding 300 L, whether or not lined or heat-insulated, but not fitted with mechanical or thermal equipment	7310	20%
31	Containers for compressed or liquefied gas, of iron or steel	7311	20%
32	Stranded wire, ropes, cables, plaited bands, slings and the like, of iron or steel, not electrically insulated	7312	20%
33	Barbed wire of iron or steel; twisted hoop or single flat wire, barbed or not, and loosely twisted double wire, of a kind used for fencing, of iron or steel	7313	20%
34	Grill, netting and fencing, of iron or steel wire; expanded metal of iron or steel	7314	20%
35	Chain and parts thereof, of iron or steel	7315	20%
36	Anchors, grapnels and parts thereof, of iron or steel	7316	20%
37	Articles of iron and steel	7317	20%
38	Articles of iron and steel	7318	20%
39	Articles of iron and steel	7319	20%
40	Springs and leaves for springs, of iron or steel	7320	20%
41	Stoves, ranges, grates, cookers (including those with subsidiary boilers for central heating), barbecues, braziers, gas-rings, plate warmers and similar non-electric domestic appliances, and parts thereof, of iron or steel	7321	20%
42	Radiators for central heating, not electrically heated, and parts thereof, of iron or steel; air heaters and hot air distributors, not electrically heated, incorporating a motor-driven fan or blower, and parts thereof, of iron or steel	7322	20%
43	Tables and similar household articles and parts thereof, of iron or steel	7323	20%
44	Sanitary ware and parts thereof, of iron or steel	7324	20%
45	Other cast articles of iron or steel	7325	20%

46	Electrical steel and other articles of iron or steel	7326	20%
47	Railway or tramway passenger coaches, not self-propelled	8605	50%
48	Railway or tramway goods vans and wagons, not self-propelled	8606	50%
49	Parts of railway or tramway locomotives or rolling-stock, such as bogies, bissel-bogies, axles and forged wheels, and parts thereof	8607	50%

Products included in descriptions are indicative; all products under the specified HS codes are included as part of the appendix."

[F. No. S-13026/1/2020-IDD]
RASIKA CHAUBE, Addl. Secy.

**POLICY FOR PROVIDING PREFERENCE TO DOMESTICALLY MANUFACTURED IRON
& STEEL PRODUCTS IN GOVERNMENT PROCUREMENT (TO BE SUBMITTED ON BIDDER'S
LETTERHEAD) SELF-CERTIFICATE**

To,
M/s Talcher Fertilizers Limited

SUB:
TENDER NO:

Dear Sir,

This has reference to "Policy for providing Preference to Domestically Manufactured Iron & Steel Products in Government Procurement" issued by Ministry of Steel, Govt. of India, vide their revised notification "The Gazette of India, Notification No. 385 (E) dated 29.05.2019".

We confirm that we will obtain Affidavit of Self Certification of Domestic value addition in Iron & Steel Products from manufacturer before supply of iron and steel products required under the tender/bidding document.

Sign & Stamp of bidder

SECTION-III

INSTRUCTION TO BIDDERS

**[TO BE READ IN CONJUNCTION WITH BIDDING DATA
SHEET (BDS)]**

SECTION-III

INSTRUCTION TO BIDDERS

INDEX

[A] GENERAL:

1. SCOPE OF BID
2. ELIGIBLE BIDDERS
3. BIDS FROM CONSORTIUM
4. ONE BID PER BIDDER
5. COST OF BIDDING
6. SITE-VISIT

[B] BIDDING DOCUMENTS:

7. CONTENTS OF BIDDING DOCUMENTS
8. CLARIFICATION OF TENDER DOCUMENTS
9. AMENDMENT OF BIDDING DOCUMENTS

[C] PREPARATION OF BIDS:

10. LANGUAGE OF BID
11. DOCUMENTS COMPRISING THE BID
12. BID PRICES
13. GST (CGST & SGST/ UTGST or IGST)
14. BID CURRENCIES
15. BID VALIDITY
16. EARNEST MONEY DEPOSIT/BID SECURITY
17. PRE-BID MEETING
18. FORMAT AND SIGNING OF BID
19. ZERO DEVIATION & REJECTION CRITERIA
20. E-PAYMENT

[D] SUBMISSION OF BIDS:

21. SUBMISSION, SEALING AND MARKING OF BIDS
22. DEADLINE FOR SUBMISSION OF BIDS
23. LATE BIDS
24. MODIFICATION AND WITHDRAWAL OF BIDS

[E] BID OPENING AND EVALUATION:

25. EMPLOYER'S RIGHT TO ACCEPT ANY BID AND TO REJECT ANY OR ALL BIDS
26. BID OPENING
27. CONFIDENTIALITY
28. CONTACTING THE EMPLOYER
29. EXAMINATION OF BIDS AND DETERMINATION OF RESPONSIVENESS
30. CORRECTION OF ERRORS
31. CONVERSION TO SINGLE CURRENCY FOR COMPARISON OF BIDS
32. EVALUATION AND COMPARISON OF BIDS
33. COMPENSATION FOR EXTENDED STAY
34. PURCHASE PREFERENCE

[F] AWARD OF CONTRACT:

35. AWARD
36. NOTIFICATION OF AWARD / FAX OF ACCEPTANCE [FOA]
37. SIGNING OF AGREEMENT
38. CONTRACT PERFORMANCE SECURITY / SECURITY DEPOSIT
39. PROCEDURE FOR ACTION IN CASE CORRUPT/FRAUDULENT/COLLUSIVE/COERCIVE PRACTICES
40. PUBLIC PROCUREMENT POLICY FOR MICRO AND SMALLENTERPRISE
41. AHR ITEMS
42. VENDOR EVALUATION PROCEDURE
43. INCOME TAX & CORPORATE TAX
44. DISPUTE RESOLUTION MECHANISM
45. DISPUTES BETWEEN CPSE'S/GOVERNMENT DEPARTMENT'S/ ORGANIZATIONS
46. INAM-PRO (PLATFORM FOR INFRASTRUCTURE AND MATERIALS PROVIDERS)
47. PROMOTION OF PAYMENT THROUGH CARDS AND DIGITALMEANS
48. CONTRACTOR TO ENGAGE CONTRACT MANPOWER BELONGING TO SCHEDULED CASTES AND WEAKER SECTIONS OF THE SOCIETY
49. PROVISIONS FOR STARTUPS (AS DEFINED IN GAZETTENOTIFICATION NO. D.L-33004/99 DATED 18.02.2016 AND 23.05.2017 OF MINISTRY OF COMMERCE AND INDUSTRY AND AS AMENDED FROM TIME TO TIME)
50. PROVISION REGARDING INVOICE FOR REDUCED VALUE OR CREDIT NOTE TOWARDS PRS
51. UNIQUE DOCUMENT IDENTIFICATION NUMBER BY PRACTICINGCHARTERED ACCOUNTANTS POLICY
52. PROVISION FOR PROCUREMENT FROM A BIDDER WHICH SHARES A LAND BORDER WITH INDIA.
53. ANJANI PORTAL
54. DOCUMENTS FOR PAYMENT
55. ORDER TRANSMITTAL SYSTEM
56. SUBLETTING AND ASSIGNMENT

[G] ANNEXURES:

1. Annexure-I : PROCEDURE FOR ACTION IN CASE CORRUPT/FRAUDULENT/ COLLUSIVE/ COERCIVE PRACTICES
2. Annexure-II : VENDOR PERFORMANCE EVALUATION PROCEDURE:
 - : ANNEXURE-1: Performance Rating Data Sheet
 - : ANNEXURE-2: Performance Rating Data Sheet
3. Annexure-III : INSTRUCTION FOR SUBMISSION OF BID ONLINE THROUGH CPP PORTAL
4. Annexure-IV : BIDDING DATA SHEET (BDS)
5. Annexure-V : PUBLIC PROCUREMENT (PREFERENCE TO MAKE IN INDIA), ORDER 2017
 - : **FORM-I OF ANNEXURE-V** : Certificate from Statutory Auditor or Cost Auditor of the company (in the case of companies) or from a Practicing Cost Accountant or Practicing Chartered Accountant (in respect of suppliers other than companies)
 - : **FORM-II OF ANNEXURE-V**: Salient points of Public Procurement (Preference to Make in India) Policy.
6. Annexure-VI : PREAMBLE TO SCHEDULE OF RATES

7. Annexure-VII: PROVISION FOR PROCUREMENT FROM A BIDDER WHICH
SHARES A LAND BORDER WITH INDIA
: **Form-I & Form- II to Annexure-VII:** Undertaking on Letter Head

INSTRUCTION TO BIDDERS [ITB]

(TO BE READ IN CONJUNCTION WITH BIDDING DATA SHEET (BDS))

[A] – GENERAL

1 SCOPE OF BID

- 1.1 The Employer as defined in the "General Conditions of Contract [GCC]", wishes to receive Bids as described in the Invitation For Bid (the “**Tender Document /Bid Document**”) issued by Employer. Employer/Owner/TFL occurring herein under shall be considered synonymous.
- 1.2 SCOPE OF BID: The scope of work/ Services shall be as defined in Section-VI of the Tender documents.
- 1.3 The successful bidder will be expected to complete the scope of Bid within the period stated in Special Conditions of Contract.
- 1.4 Throughout the Tender Documents, the terms 'Bid', 'Tender' & 'Offer' and their derivatives [Bidder/Tenderer, Bid/Tender/Offer etc.] are synonymous. Further, 'Day' means 'Calendar Day' and 'Singular' also means 'Plural'.

2 ELIGIBLE BIDDERS

- 2.1 Provision for procurement from a bidder which shares a land border with India has been attached as **Annexure-VII** herewith.
- 2.2 The Bidder shall not be under a declaration of ineligibility by Employer for Corrupt/ Fraudulent/ Collusive/ Coercive practices, as defined in "Instructions to Bidders [ITB], Clause No. 39" (Action in case Corrupt/ Fraudulent/ Collusive/ Coercive Practices).
- 2.3 The Bidder is not put on 'Holiday' by TFL or any of the JV partner of OWNER (viz. GAIL, RCF, CIL) or Public-Sector Project Management Consultant (like PDIL,EIL, MECON only due to “poor performance” or “corrupt and fraudulent practices”) or banned/blacklisted by Government department/ Public Sector on due date of submission of bid. Further, neither bidder nor their allied agency/(ies) (as defined in the Procedure for Action in case of Corrupt/Fraudulent/Collusive/ Coercive Practices)are on banning list of TFL or any of the JV partner of OWNER viz. GAIL, RCF, CIL.

If the Bidding documents were issued inadvertently/ downloaded from website, offers submitted by such bidders shall not be considered for opening/ evaluation/Award and will be returned immediately to such bidders.

In case there is any change in status of the declaration prior to award of contract, the same has to be promptly informed to TFL/PDIL by the bidder.

It shall be the sole responsibility of the bidder to inform about their status regarding para 1 of clause 2.2 herein above on due date of submission of bid and during the course of finalization of the tender. Concealment of the facts shall tantamount to misrepresentation of facts and shall lead to action against such Bidders as per clause 39 of ITB.

2.4 The Bidder should not be under any liquidation court receivership or similar proceedings on due date of submission of bid. In case there is any change in status of the declaration prior to award of contract, the same has to be promptly informed to TFL/PDIL by the bidder.

It shall be the sole responsibility of the bidder to inform TFL there status on above on due date of submission of bid and during the course of finalization of the tender. Concealment of the facts shall tantamount to misrepresentation of facts and shall lead to action against such Bidders as per clause no. 39 of ITB.

2.5 Bidder shall not be affiliated with a firm or entity:

- (i) that has provided consulting services related to the work to the Employer during the preparatory stages of the work or of the project of which the works/services forms a part of or
- (ii) that has been hired (proposed to be hired) by the Employer as an Engineer/ Consultant for the contract.

2.6 Neither the firm/entity appointed as the Project Management Consultant (PMC) for a contract nor its affiliates/ JV'S/ Subsidiaries shall be allowed to participate in the tendering process unless it is the sole Licensor/Licensor nominated agent/ vendor.

2.7 Pursuant to qualification criteria set forth in the bidding document, the Bidder shall furnish all necessary supporting documentary evidence to establish Bidder's claim of meeting qualification criteria.

2.8 **Power of Attorney:**

Power of Attorney (PoA) to be issued by the bidder in favour of the authorised employee(s), in respect of the particular tender, for purpose of signing the documents including bid, all subsequent communications, agreements, documents etc. pertaining to the tender and act and take any and all decision on behalf of the bidder (including Consortium). Any consequence resulting due to such signing shall be binding on the Bidder (including Consortium).

(I) In case of a Single Bidder, the Power of Attorney shall be issued as per the constitution of the bidder as below:

- a) **In case of Proprietorship:** By Proprietor
- b) **In case of Partnership:** by all Partners or Managing Partner.
- c) **In case of Limited Liability Partnership:** by any bidder's employee authorized in terms of Deed of LLP.
- d) **In case of Public /Limited Company:** PoA in favour of authorized employee(s) by Board of Directors through Board Resolution or by the designated officer authorized by Board to do so. Such Board Resolution should be duly countersigned by Company Secretary / MD / CMD / CEO.

The Power of Attorney should be valid till award of contract/order to successful bidder.

(II) In case of a Consortium, Power of Attorney shall be issued both by Leader as well as Consortium Member(s) of the Consortium as per procedure defined herein above in favour of employee of Leader of Consortium.

3 BIDS FROM "CONSORTIUM"/"JOINT VENTURES"

Not Applicable for this tender.

4 ONE BID PER BIDDER

- 4.1 A Bidder shall submit only 'one [01] Bid' in the same Bidding Process either as single entity or as a member of any consortium (wherever consortium bid is allowed). A Bidder who submits or participates in more than 'one [01] Bid' will cause all the proposals in which the Bidder has participated to be disqualified.
- 4.2 A bidder shall not have conflict of interest with other bidders. Such conflict of interest can lead to anti-competitive practices. The bidder found to have a conflict of interest shall be disqualified. A bidder shall be considered to have a conflict of interest with one or more bidders in this bidding process, if:
- a) they have controlling partner (s) in common; or
 - b) they receive or have received any direct or indirect subsidy/ financial stake from any of them; or
 - c) they have the same legal representative/authorized signatory/agent for purposes of this bid; or
 - d) they have relationship with each other, directly or through common third parties, that puts them in a position to have access to information about or influence on the bid of another Bidder; or
 - e) Bidder participates in more than one bid in bidding process. Participation by a Bidder in more than one Bid will result in the disqualification of all bids in which the parties are involved. However, this does not limit the inclusion of the components/ sub-assembly/ Assemblies from one bidding manufacturer in more than one bid.
 - f) a Bidder or any of its affiliates participated as a consultant in the preparation of the design or technical specifications of the contract that is the subject of the Bid;
 - g) In case of a holding company having more than one independently manufacturing units, or more than one unit having common business ownership/management, only one unit should quote. Similar restrictions would apply to closely related sister companies. Bidders must proactively declare such sister/ common business/ management units in same/ similar line of business.

Failure to comply this clause during tendering process will disqualify all such bidders from process of evaluation of bids.

- 4.3 Alternative Bids shall not be considered.
- 4.4 The provisions mentioned at sl. no. 4.1 and 4.2 shall not be applicable wherein bidders are quoting for different Items / Sections / Parts / Groups/ SOR items of the same tender which specifies evaluation on Items / Sections / Parts / Groups/ SOR items basis.

5 COST OF BIDDING

The Bidder shall bear all costs associated with the preparation and submission of the Bid including but not limited to Documentation Charges, Bank charges all courier charges translation charges, authentication charges and any associated charges including taxes & duties thereon. Further, TFL/PDIL will in no case, be responsible or liable for these costs, regardless of the outcome of the bidding process.

6 SITE VISIT

- 6.1 The Bidder is advised to visit and examine the site of works and its surroundings and obtain for itself on its own responsibility all information that may be necessary for preparing the Bid and entering into a Contract for the required job. The costs of visiting the site shall be borne by the Bidder.
- 6.2 The Bidder or any of its personnel or agents shall be granted permission by the Employer to enter upon its premises and land for the purpose of such visits, but only upon the express conditions that the Bidder, its personnel and agents will release and indemnify the Employer and its personnel, agents from and against all liabilities in respect thereof, and will be responsible for death or injury, loss or damage to property, and any other loss, damage, costs, and expenses incurred as a result of inspection.
- 6.3 The Bidder shall not be entitled to hold any claim against TALCHER FERTILIZERS LIMITED for non-compliance due to lack of any kind of pre-requisite information as it is the sole responsibility of the Bidder to obtain all the necessary information with regard to site, surrounding, working conditions, weather etc. on its own before submission of the bid.

[B] –BIDDING DOCUMENTS

7 CONTENTS OF BIDDING DOCUMENTS

- 7.1 The contents of Bidding Documents /Tender documents are those stated below, and should be read in conjunction with any 'Addendum / Corrigendum and Clarification(s)' issued in accordance with "ITB: Clause-8 & 9":

- Section-I : Invitation for Bid [IFB]
- Section-II : BID EVALUATION CRITERIA [BEC] & Evaluation methodology
- Section-III : Instructions to Bidders [ITB], Annexure, Forms & Formats
- Section-IV : General Conditions of Contract [GCC]
- Section-V : Special Conditions of Contract [SCC]
- Section-VI : Scope of Work & Technical Specifications
- Section-VII : Price Schedule/ Schedule of Rates

*'Request for Quotation', wherever applicable, shall also form part of the Bidding document.

For participation in e-tender, instructions are mentioned at Annexure-III to Section-III of tender.

- 7.2 The Bidder is expected to examine all instructions, forms, terms & conditions in the Bidding Documents. The "Request for Quotation [RFQ] & Invitation for Bid (IFB)" together with all its attachments thereto, shall be considered to be read, understood and accepted by the Bidders. Failure to furnish all information required by the Bidding Documents or submission of a Bid not substantially responsive to the Bidding Documents in every respect will be at Bidder's risk and may result in the rejection of his Bid.

8 CLARIFICATION OF TENDER DOCUMENTS

- 8.1 A prospective Bidder requiring any clarification(s) of the Bidding Documents may notify TFL in writing or through CPP Portal (<https://eprocure.gov.in/eprocure/app>) or email at PDIL's mailing address indicated in the BDS no later than 02 (two) days prior to pre-bid meeting (in cases where pre-bid meeting is scheduled) or 05 (five) days prior to the due date of submission of bid in cases where pre-bid meeting is not scheduled. TFL/PDIL reserves the right to ignore the bidders request for clarification if received after the aforesaid period. TFL/PDIL may respond in writing to the request for clarification. TFL/PDIL's response including an explanation of the query, but without identifying the source of the query will be uploaded on the websites mentioned at Clause No. 2.0 (G) of IFB. Hence, bidders are requested to regularly visit the said websites for updates.
- 8.2 Any clarification or information required by the Bidder but same not received by the Employer at clause 8.1 (refer BDS for address) above is liable to be considered as "no clarification / information required".

9 AMENDMENT OF BIDDING DOCUMENTS

- 9.1 At any time prior to the 'Bid Due Date', Employer for any reason, whether at its own initiative or in response to a clarification requested by a prospective Bidder, modify the Bidding Documents by addenda / corrigendum.
- 9.2 Any corrigendum thus issued shall be integral part of the Tender Document and shall be hosted only on the websites as provided at clause no. 2.0 (G) of IFB. Bidders, in their own interest, are advised to regularly check the websites for any amendment/Corrigendum/Addendum. Bidders have to take into account all such amendment / corrigendum before submitting their Bid. TFL/PDIL will not take any responsibility or entertain any representation whatsoever, in case bidders have not checked/seen/downloaded such amendment/Corrigendum/Addendum or reply to pre-bid queries uploaded on the said websites.
- 9.3 The Employer, if it considers necessary, may extend the Bid Due Date in order to allow the Bidders a reasonable time to furnish their most competitive bid taking into account the addenda / corrigendum issued thereof.
-

[C] – PREPARATION OF BIDS

10 LANGUAGE OF BID:

The bid prepared by the Bidder and all correspondence, drawing(s), document(s), certificate(s) etc. relating to the Bid exchanged by Bidder and TFL shall be written in English language only. In case a document, certificate, printed literature etc. furnished by the Bidder in a language other than English, the same should be accompanied by an English translation duly authenticated by the Indian Chamber of Commerce, in which case, for the purpose of interpretation of the Bid, the English translation shall govern.

11. DOCUMENTS COMPRISING THE BID

11.1 Bidders are requested to refer instructions for participating in e-Tendering (Annexure-I to Section III of tender), Ready Reckoner for Bidders and FAQs available in e-portal and bids submitted manually shall be rejected. All pages of the Bid must be digitally signed by the "authorized signatory" of the Bidder holding Power of Attorney. The bids must be submitted on e-tendering website of CPP portal (<https://eprocure.gov.in/eprocure/app>) comprising following documents:-

11.1.1 **PART-I: "TECHNO-COMMERCIAL / UN-PRICED BID"** shall contain the following:

- (a) 'Covering Letter' on Bidder's 'Letterhead' clearly specifying the enclosed Contents with index
- (b) 'Bidder's General Information', as per 'Form F-1'.
- (c) Copies of documents, as specified in tender document
- (d) Copy of Schedule of Rates (SOR) with prices blanked out mentioning quoted / not quoted (as applicable) written against each item as a confirmation that the prices are quoted in requisite format .
- (e) 'Letter of Authority' on the Letter Head, as per 'Form F-3'
- (f) 'Agreed Terms and Conditions', as per 'Form F-5'
- (g) 'ACKNOWLEDGEMENT CUM CONSENT LETTER', as per 'Form F-6'
- (h) Duly attested documents in accordance with the "BID EVALUATION CRITERIA [BEC]" establishing the qualification.
- (i) Copy of Power of Attorney as per 'F-20'/copy of Board Resolution, in favour of the authorized signatory of the Bid, as per clause no. 2.8 of ITB (Original to be submitted physically).
- (j) Copy of EMD / Declaration for Bid Security in original as per Clause 16 of ITB (Original to be submitted physically)
- (k) Undertaking as per Form-I to Annexure-V to Section-III and Certification from the statutory auditor or cost auditor of the company (in the case of companies) or from a practicing cost accountant or practicing chartered accountant (in respect of other than companies) as per Form-II to Annexure-V to Section-III (Applicable for all bidders irrespective of seeking purchase preference or not).
- (l) Undertaking as per Form-I to Annexure VII regarding Provisions for Procurement from a bidder which shares a land border with India.
- (m) All forms and Formats including Annexures
- (n) 'Integrity Pact' as per 'Form F-14'
- (o) 'Indemnity Bond' as per 'Form F-15'
- (p) Checklist for Bid Evaluation Criteria (BEC) qualifying documents for bidder as per 'Form F-8A & F-8B

- (q) Tender Document, its Corrigendum/Amendment/Clarification(s) duly signed on each page (in case of manual tendering)/ digitally signed (in case of e-Tender) by the Authorized Signatory holding POA.
- (r) Additional document specified in BDS, SCC, Scope of Supply or mentioned elsewhere in the Tender Document, its Corrigendum/Amendment/Clarification(s).
- (s) Any other information/details required as per Tender Document

Note:

1. All the pages of the Bid must be signed/ digitally signed by the "Authorized Signatory" of the Bidder holding POA.

11.1.2 PART-II: Price Bid

The Prices are to be filled strictly in the Schedule of Rate of the bidding documents and provision mentioned at para 11.1.2 hereinabove and to uploaded in SOR attachment/Conditions of CPP portal.

- 11.2 "TECHNO-COMMERCIAL/UN-PRICED BID" comprising all the above documents mentioned at 11.1.1 along with copy of EMD/Bid Security, copy of Power of Attorney and copy of integrity pact should be uploaded in the CPP portal. Further, Bidders must submit the original " EMD, Power of Attorney, Integrity Pact (wherever applicable) and any other documents specified in the Tender Document to the address mentioned in IFB, in a sealed envelope, superscribing the details of Tender Document (i.e. tender number & tender for) within 7 days from the date of un-priced bid opening.

Bidders are required to submit the EMD in original by Due Date and Time of Bid Submission or upload a scanned copy of the same in the Part-I of the Bid. If the Bidder is unable to submit EMD in original by Due Date and Time of Bid Submission, the Bidder is required to upload a scanned copy of the EMD in Part-I of Bid, provided the original EMD, copy of which has been uploaded, is received within 7 days from the Due Date of Bid Opening, failing which the Bid will be rejected irrespective of their status/ranking in tendering process and notwithstanding the fact that a copy of EMD was earlier uploaded by the Bidder.

- 11.3 In case of bids invited under *single bid system*, a single envelope containing all documents specified at Clause 11.1.1 & 11.1.2 of ITB above form the BID. All corresponding conditions specified at Clause 11.1.1 & 11.1.2 of ITB shall become applicable in such a case.

12 BID PRICES

- 12.1 Unless stated otherwise in the Bidding Documents, the Contract shall be for the whole works as described in Bidding Documents, based on the rates and prices submitted by the Bidder and accepted by the Employer. The prices quoted by the Bidders will be inclusive of all taxes except **GST (CGST & SGST/UTGST or IGST)**. Applicable rate of **GST (CGST & SGST/ UTGST or IGST)** on the contract value shall be indicated in SOR under column for GST.
- 12.2 Prices must be filled in format for "Schedule of Rates [SOR] " enclosed as part of Tender document. If quoted in separate typed sheets and any variation in item description, unit or quantity is noticed; the Bid is liable to be rejected.

- 12.3 Bidder shall quote for all the items of "SOR" after careful analysis of cost involved for the performance of the completed item considering all parts of the Bidding Document. In case any activity though specifically not covered in description of item under "SOR" but is required to complete the works as per Specifications, Scope of Work / Service, Standards, General Conditions of Contract ("GCC"), Special Conditions of Contract ("SCC") or any other part of Bidding Document, the prices quoted shall be deemed to be inclusive of cost incurred for such activity.
- 12.4 All duties, taxes and other levies [if any] payable by the Contractor under the Contract, or for any other cause except final **GST (CGST & SGST/ UTGST or IGST)** shall be included in the rates / prices and the total bid-price submitted by the Bidder.
- 12.5 Prices quoted by the Bidder, shall remain firm and fixed and valid till completion of the Contract and will not be subject to variation on any account unless any price escalation/variation is allowed elsewhere in Tender Document.
- 12.6 Bidder shall also mention the **Service Accounting Codes (SAC) / Harmonized System of Nomenclature (HSN)** at the designated place in Techno-Commercial / Un-Priced bid.

13 GST (CGST & SGST/ UTGST or IGST)

- 13.1 Bidders are required to submit a copy of the GST Registration Certificate, while submitting the bids wherever **GST(CGST & SGST/UTGST or IGST)** is applicable
- 13.2 Quoted prices should be inclusive of all taxes and duties, except **GST (CGST & SGST or IGST or UTGST)**. Please note that the responsibility of payment of **GST (CGST & SGST or IGST or UTGST)** lies with the Contractor only. Contractor providing taxable service shall issue an e- Invoice/ Invoice / Bill, as the case may be as per rules/ regulation of GST. Further, returns and details required to be filled under GST laws & rules should be timely filed by Contractor with requisite details.
- Payments to Contractor for claiming **GST (CGST & SGST/UTGST or IGST)** amount will be made provided the above formalities are fulfilled. Further, TFL may seek copies of challan and certificate from Chartered Accountant for deposit of **GST (CGST & SGST/UTGST or IGST)** collected from Owner.
- 13.3 In case CBIC (Central Board of Indirect Taxes and Customs)/ any tax authority / any equivalent Government agency brings to the notice of TFL that the Contractor has not remitted the amount towards **GST (CGST & SGST/UTGST or IGST)** collected from TFL to the government exchequer, then, that Contractor shall be put under Holiday list of TFL for period of six months after following the due procedure. This action will be in addition to the right of recovery of financial implication arising on TFL.
- 13.4 For statutory variation in **GST (CGST & SGST/UTGST or IGST)**, please refer clause no. **13.0 of SCC (Section V of NIT)**
- 13.5 Where TFL is entitled to avail the input tax credit of **GST (CGST & SGST/UTGST or IGST)**:-

13.5.1 Owner/TFL will reimburse the **GST (CGST & SGST/UTGST or IGST)** to the Contractor at actuals against submission of E-Invoices/Invoices as per format specified in rules/regulation of GST, to enable Owner/TFL to claim input tax credit of **GST (CGST & SGST/UTGST or IGST)** paid. In case of any variation in the executed quantities, the amount on which the **GST (CGST & SGST/UTGST or IGST)** is applicable shall be modified in same proportion. Returns and details required to be filled under GST laws & rules should be timely filed by supplier with requisite details.

13.6 Where TFL is not entitled to avail/take the full input tax credit of **GST (CGST & SGST/UTGST or IGST)**:

13.6.1 Owner/TFL will reimburse **GST (CGST & SGST/UTGST or IGST)** to the Contractor at actuals against submission of E-Invoices/Invoices as per format specified in rules/regulation of GST subject to the ceiling amount of **GST (CGST & SGST/UTGST or IGST)** as quoted by the bidder, subject to any statutory variations, except variations arising due to change in turnover. In case of any variation in the executed quantities (If directed and/or certified by the Engineer-In-Charge) the ceiling amount on which **GST (CGST & SGST/UTGST or IGST)** is applicable will be modified on pro-rata basis.

13.7 TFL will prefer to deal with registered supplier of goods/ services under GST. Therefore, bidders are requested to get themselves registered under GST, if not registered yet.

However, in case any unregistered bidder is submitting their bid, Bids will be evaluated as per quoted prices without loading of **GST (CGST & SGST/UTGST or IGST)**, if not quoted. their prices will be loaded with applicable GST (CGST & SGST/UTGST or IGST) while evaluation of bid (if applicable as per Govt. Act/ Law in vogue). Where TFL is entitled for input credit of **GST (CGST & SGST/UTGST or IGST)**, the same will be considered for evaluation of bid as per evaluation methodology of tender document. Further, an unregistered bidder is required to mention its Income Tax PAN in bid document.

13.8 In case TFL is required to pay entire/certain portion of applicable **GST (CGST & SGST/UTGST or IGST)** and remaining portion, if any, is to be deposited by Bidder directly as per **GST (CGST & SGST/UTGST or IGST)** laws, entire applicable rate/amount of **GST (CGST & SGST/UTGST or IGST)** to be indicated by bidder in the SOR.

Where TFL has the obligation to discharge **GST (CGST & SGST/UTGST or IGST)** liability under reverse charge mechanism and TFL has paid or is /liable to pay **GST (CGST & SGST/UTGST or IGST)** to the Government on which interest or penalties becomes payable as per GST laws for any reason which is not attributable to TFL or ITC with respect to such payments is not available to TFL for any reason which is not attributable to TFL, then TFL shall be entitled to deduct/ setoff / recover such amounts against any amounts paid or payable by TFL to Contractor /Supplier.

- 13.9 Contractor shall ensure timely submission of correct invoice(s)/e-invoice(s), as per GST rules/ regulation, with all required supporting document(s) within a period specified in Contract to enable TFL to avail input credit of GST (CGST & SGST/UTGST or IGST). Further, returns and details required to be filled under GST laws & rules should be timely filed by Contractor with requisite details.

If input tax credit is not available to TFL for any reason not attributable to TFL, then TFL shall not be obligated or liable to pay or reimburse GST (CGST & SGST/UTGST or IGST) claimed in the invoice(s) and shall be entitled to deduct/ setoff/ recover such GST amount (CGST & SGST/UTGST or IGST) or Input Tax Credit amount together with penalties and interest, if any, against any amounts paid or becomes payable by TFL in future to the Contractor under this contract or under any other contract

13.10 Anti-profiteering clause

As per Clause 171 of GST Act it is mandatory to pass on the benefit due to reduction in rate of tax or from input tax credit to the consumer by way of commensurate reduction in prices. The Contractor may note the above and quote their prices accordingly.

- 13.11 In case the GST rating of Contractor on the GST portal / Govt. official website is negative / black listed, then the bids may be rejected by TFL. Further, in case rating of bidder is negative / black listed after award of work, then TFL shall not be obligated or liable to pay or reimburse GST to such Contractor and shall also be entitled to deduct / recover such GST along with all penalties / interest, if any, incurred by TFL.

- 13.12 GST (CGST & SGST/UTGST or IGST) is implemented w.e.f. 01.07.2017 which subsumed various indirect taxes and duties applicable before 01.07.2017. Accordingly, the provisions of General Condition of Contract relating to taxes and duties which are subsumed in GST are modified to aforesaid provisions mentioned in clause no. 12 and 13 of ITB.

- 13.13 GST, as quoted by the bidder in Schedule of Rates, shall be deemed as final and binding for the purpose of bid evaluation (applicable for tenders where bidder quotes the GST rates). In case a bidder enters "zero/blank" GST or an erroneous GST, the bid evaluation for finalizing the L1 bidder will be done considering the "Zero" or quoted GST rate GST rate, as the case may be. No request for change in GST will be entertained after submission of bids. In case GST column is left blank in the SOR, the quoted prices shall be considered as "Inclusive of GST" and evaluation shall be done accordingly.

In cases where the successful bidder quotes a wrong GST rate, for releasing the order, the following methodology will be followed:

- In case the actual GST rate applicable is lower than the quoted GST rate, the actual GST rate will be added to the quoted basic prices. The final cash outflow will be based on actual GST rate.
- In case the actual GST rate applicable is more than the quoted GST rate, the basic prices quoted will be reduced proportionately, keeping the final cash outflow the same as the overall quoted amount.

Based on the Total Cash Outflow calculated as above, TFL shall place orders.

13.14 Wherever TDS under GST Laws has been deducted from the invoices raised / payments made to the Contractors, as per the provisions of the GST law / Rules, Contractors should accept the corresponding GST-TDS amount populated in the relevant screen on GST common portal (www.gst.gov.in). Further, Vendors should also download the GST TDS certificate from GST common portal (reference path: Services>User Services> View/Download Certificates option).

13.15 **Provision w.r.t. E- Invoicing requirement as per GST laws:** Supplier who is required to comply with the requirements of E-invoice for B2B transactions as per the requirement of GST Law will ensure the compliance of requirement of E Invoicing under GST law. If the invoice issued without following this process, such invoice can-not be processed for payment by TFL as no ITC is allowed on such invoices.

Therefore, all the payments to such supplier who is liable to comply with e-invoice as per GST Laws shall be made against the proper e-invoice(s) only. Further, returns and details required to be filled under GST laws & rules against such e-invoices should be timely filed by Supplier of Goods with requisite details.

If input tax credit is not available to TFL for any reason attributable to supplier (both for E-invoicing cases and non-E-invoicing cases), then TFL shall not be obligated or liable to pay or reimburse GST (CGST & SGST/UTGST or IGST) claimed in the invoice(s) and shall be entitled to deduct / setoff / recover such GST amount (CGST & SGST/UTGST or IGST) or Input Tax Credit amount together with penalties and interest, if any, by adjusting against any amounts paid or becomes payable in future to the contractor under this contract or under any other supplier .

To ensure compliance, undertaking in requisite format is to be submitted by supplier as per format enclosed at Form F-21 along with documents for release of payment.

13.16 **New Taxes & duties:** Any new taxes & duties, if imposed by the State/ Central Govt. of India after the due date of bid submission but before the Contractual Completion Date, shall be reimbursed to the Service Provider on submission of copy of notification(s) issued from State/ Central Govt. Authorities along with documentary evidence for proof of payment of such taxes & duties, but only after ascertaining it's applicability with respect to the Contract.

13.17 Full payment including GST will be released at the time of processing of invoice for payment, where the GST amount reflects in Form GSTR-2A of TFL. However, in case where the GST amount doesn't reflect in Form GSTR-2A of TFL, the amount of GST will be released after reflection of GST amount of corresponding invoice in Form GSTR-2A of TFL.

14 BID CURRENCIES:

Bidders must submit bid in Indian Rupees only.

15 BID VALIDITY

15.1 Bids shall be kept valid for period specified in BDS from the final Due date of submission of bid'. A Bid valid for a shorter period may be rejected by TFL as 'non-responsive'.

- 15.2 In exceptional circumstances, prior to expiry of the original 'Bid Validity Period', the Employer may request the Bidders to extend the 'Period of Bid Validity' for a specified additional period. The request and the responses thereto shall be made in writing or by email. A Bidder may refuse the request without forfeiture of his EMD / Bid Security.

A Bidder agreeing to the request will not be required or permitted to modify his Bid, but will be required to extend the validity of its EMD for the period of the extension and in accordance with "ITB: Clause-16" in all respects.

16 EARNEST MONEY DEPOSIT

- 16.1 Bid must be accompanied with earnest money (i.e. Earnest Money Deposit (EMD) also known as Bid Security) in the form of '**Demand Draft**' / '**Banker's Cheque**' / '**Insurance Surety Bond**' / '**Fixed Deposit Receipt**' [in favour of **Talcher Fertilizers Limited** payable at place mentioned in BDS] or 'Bank Guarantee' strictly as per the format given in form F-2A (as the case may be) of the Tender Document. Bidder shall ensure that EMD submitted in the form of 'Bank Guarantee' should have a validity of at least "two [02] months" beyond the validity of the Bid. EMD submitted in the form of 'Demand Draft' or 'Banker's Cheque' should be valid for three months.

Bid not accompanied with EMD, or EMD not in requisite format shall be liable for rejection. The EMD shall be submitted in Indian Rupees only.

- 16.2 The bidder can also submit the EMD through online banking transaction i.e. IMPS/NEFT/RTGS etc. For this purpose, the details of TFL's Bank Account are mentioned under BDS. While remitting, the bidder must indicate EMD and tender/E-tender no. under remarks. Bidders shall be required to submit/ upload the successful transaction details along-with their bid/e-bid in addition to forwarding the details to dealing officer through email/letter with tender reference number immediately after remittance of EMD. In absence of submitting/ uploading the remittance details, the bid is likely to be considered as bid not accompanied with EMD. Further, in case of the online transaction, submission of EMD in original is not applicable.
- 16.3 OWNER shall not be liable to pay any documentation charges, Bank charges, commission, interest etc. on the amount of EMD. In case EMD is in the form of a "Bank Guarantee", the same shall be from any Indian scheduled Bank (excluding Co-operative banks and Regional Rural bank) or a branch of an International Bank situated in India and registered with "Reserve Bank of India" as Scheduled Foreign Bank. However, in case of „Bank Guarantee" from Banks other than the Nationalized Indian Banks, the Bank must be commercial Bank having networth in excess of Rs. 100 Crores [Rupees One Hundred Crores] and a declaration to this effect should be made by such commercial Bank either in the "Bank Guarantee" itself or separately on its letterhead. Purchaser will verify the BG from issuing bank.
- 16.4 Any Bid not secured in accordance with "ITB: Clause-16.1 & Clause-16.3" may be rejected by TFL as non-responsive.
- 16.5 Unsuccessful Bidder's EMD will be discharged/ returned as promptly as possible, but not later than "thirty [30] days" after finalization of tendering process.
- 16.6 The successful Bidder's EMD will be discharged upon the Bidder's acknowledging the "Award" and signing the "Agreement" (if applicable) and furnishing the Contract Performance Security (CPS)/ Security Deposit" pursuant to clause no. 38 of ITB.

- 16.7 Notwithstanding anything contained herein, the EMD may also be forfeited in any of the following cases:
- (a) If a Bidder withdraws his Bid during the "Period of Bid Validity"
 - (b) If a Bidder has indulged in corrupt/fraudulent /collusive/coercive practice
 - (c) If the Bidder modifies Bid during the period of bid validity (after Due Date and Time for Bid Submission).
 - (d) Violates any other condition, mentioned elsewhere in the Tender Document, which may lead to forfeiture of EMD.
 - (e) In case of Cartelization of bid.
 - (f) In the case of a successful Bidder, if the Bidder fails to:
 - (i) to acknowledge receipt of the "Notification of Award" / Fax of Acceptance[FOA] / Detailed Letter of Acceptance [DLOA]",
 - (ii) to furnish "Contract Performance Security / Security Deposit", in accordance with "ITB: Clause-38".

16.8 In case EMD is in the form of „Bank Guarantee“, the same must indicate the Tender Document No. and the name of Tender Document for which the Bidder is quoting. This is essential to have proper correlation at a later date.

16.9 MSEs (Micro & Small Enterprises) are exempted from submission of EMD in accordance with the provisions of PPP-2012 and Clause 40 of ITB. However, Traders/Dealers/ Distributors /Stockiest /Wholesaler are not entitled for exemption of EMD. The Government Departments/PSUs are also exempted from the payment of EMD. Further, Startups are also exempted from the payment of EMD.

16.10 In case of forfeiture of EMD/ Bid Security, the forfeited amount will be considered inclusive of tax and tax invoice will be issued by TFL. The forfeiture amount will be subject to final decision of TFL based on other terms and conditions of order/contract.

16.11 EMD/Bid Bond will not be accepted in case the same has reference of 'remitter'/'financer' other than bidder on the aforementioned financial instrument of EMD/ Bid Bond submitted by the bidder and bid of such bidder will be summarily rejected.

16.A DECLARATION FOR BID SECURITY

MSEs (Micro & Small Enterprises), Start-ups and CPSEs (to whom exemption is allowed as per extant guidelines in vogue) are required to submit, "DECLARATION FOR BID SECURITY" as per prescribed format (F-2B).

17 PRE-BID MEETING (IF APPLICABLE)

17.1 The Bidder(s) or his designated representative are invited to attend a "Pre-Bid Meeting" which will be held at address specified in IFB. It is expected that a bidder shall not depute more than 02 representatives for the meeting.

17.2 Purpose of the meeting will be to clarify issues and to answer questions on any matter that may be raised at that stage and give hands-on e-tendering.

17.3 Text of the questions raised and the responses given, together with any responses prepared after the meeting, will be uploaded on Central Public Procurement (CPP) Portal (<https://eprocure.gov.in/eprocure/app>) websites. Any modification of the Contents of Bidding Documents listed in "ITB: Clause-7.1", that may become necessary as a result of the Pre-Bid Meeting shall be made by the Employer exclusively through the issue of an Corrigendum pursuant to "ITB: Clause-9", and not through the minutes of the Pre-Bid Meeting.

17.4 Non-attendance of the Pre-Bid Meeting will not be a cause for disqualification of Bidder.

18 FORMAT AND SIGNING OF BID

18.1 The original and all copies of the Bid shall be typed or written in indelible ink [in the case of copies, photocopies are also acceptable] and shall be signed by a person or persons duly authorized to sign on behalf of the Bidder (as per POA). The name and position held by each person signing, must be typed or printed below the signature. All pages of the Bid except for unamendable printed literature where entry(s) or amendment(s) have been made shall be initialed by the person or persons signing the Bid.

18.2 The Bid shall contain no alterations, omissions, or additions, unless such corrections are initialed by the person or persons signing the Bid.

18.3 In case of e-tendering, digitally Digitally signed documents to be uploaded as detailed in addendum to ITB (Annexure-III of Section –III).

19 ZERO DEVIATION AND REJECTION CRITERIA

19.1 ZERO DEVIATION: Deviation to terms and conditions of "Bidding Documents" may lead to rejection of bid. TFL will accept bids based on terms & conditions of "Bidding Documents" only. Bidder may note TFL will determine the substantial responsiveness of each bid to the Tender documents pursuant to provision contained in clause 29 of ITB. For purpose of this, a substantially responsive bid is one which conforms to all terms and conditions of the Bidding documents without deviations or reservations. TFL's determination of a bid's responsiveness is based on the content of the bid itself without recourse to extrinsic evidence.

Bidder is requested not to take any deviation(s)/exception(s) to the terms & conditions of Tender Document, and submit all requisite documents as mentioned in this Tender Document, failing which their Bid will be liable for rejection. If a Bidder does not reply to the queries in the permitted time frame then its Bid shall be evaluated based on the documents available in the Bid.

As a principle, clarifications from bidders after opening of tenders will not be sought. However, where clarifications / documents from the bidders on important aspects are absolutely necessary for finalization of tender, clarifications from bidder can be asked. The request for clarification shall be given in email/portal, asking the bidder to respond by a specified date, and also mentioning therein that, if the bidder does not comply or respond by the date, his tender will be liable to be rejected. Depending on the outcome, such tenders are to be ignored or considered further. No change in prices or substance of the bid including specifications, shall be offered or permitted. No post-bid clarification at the initiative of the bidder shall be entertained. The shortfall information/ documents should be sought only in case of historical documents which pre-existed bids and which have not undergone change since then.

19.2 **REJECTION CRITERIA:** Notwithstanding the above, deviation to the following clauses of Tender document shall lead to summarily rejection of Bid:

- a) Bidder not meeting Bid Evaluation Criteria as per Tender Document
- b) Firm Price
- c) EMD / Declaration for Bid Security (as applicable)
- d) Specifications & Scope of Work
- e) Schedule of Rates / Price Schedule / Price Basis
- f) Duration / Period of Contract/ Completion Period
- g) Payment Terms
- h) Period of Validity of Bid
- i) Integrity Pact
- j) Mutually Agreed Damages
- k) Overall ceiling on total liability
- l) Contract Performance Security
- m) Guarantee / Defect Liability Period
- n) Arbitration / Settlement of Dispute
- o) Governing laws, language & measures
- p) Force Majeure
- q) Undertaking forms, Form I of Annexure VII for provision for procurement from a bidder which shares a land border with India
- r) Bidder quoting less than 20% as minimum Local content (as per make in India PPLC policy)
- s) Any other condition specifically mentioned in the tender document elsewhere that non-compliance of the clause lead to rejection of bid

Note: Further, it is once again reminded not to mention any condition in the Bid which is contradictory to the terms and conditions of Tender document.

20 **E-PAYMENT**

OWNER has initiated payments to Contractors electronically, and to facilitate the payments electronically through 'e-banking'.

[D] – SUBMISSION OF BIDS

21 **SUBMISSION, SEALING AND MARKING OF BIDS**

21.1 In case of e-tendering, bids shall be submitted through e-tender in the manner specified elsewhere in tender document. No Manual/ Hard Copy (Original) offer shall be acceptable. Physical documents shall be addressed to the owner at address specified in IFB.

21.2 Deleted

21.3 Bids submitted under the name of AGENT/ REPRESENTATIVE /RETAINER/ ASSOCIATE etc. on behalf of a bidder/affiliate shall not be accepted.

22 DEADLINE FOR SUBMISSION OF BIDS

22.1 In case of e-bidding, the bids must be submitted through e-tender mode not later than the date and time specified in the tender document/BDS (Bidding Data Sheet).

22.2 Deleted.

22.3 TFL may, in exceptional circumstances and at its discretion, extend the deadline for submission of Bids (clause 8 and/or 9 of ITB refers). In which case all rights and obligations of TFL and the Bidders, previously subject to the original deadline will thereafter be subject to the deadline as extended Notice for extension of due date of submission of bid will be uploaded on website only as mentioned in Clause No. 2.0(G) of IFB.

23 LATE BIDS

23.1 Any bids received after the notified date and time of closing of tenders will be treated as late bids.

23.2 In case of e-tendering, e-tendering system of CPP Portal (eprocure.gov.in) shall close immediately after the due date for submission of bid and no bids can be submitted thereafter.

23.3 Physical documents received to address other than one specifically stipulated in the Tender Document will not be considered for evaluation/opening/award if not received to the specified destination within stipulated date & time.

23.4 Unsolicited Bids or Bids received to address other than one specifically stipulated in the tender document will not be considered for evaluation/opening/award if not received to the specified destination within stipulated date & time.

24 MODIFICATION AND WITHDRAWAL OF BIDS

24.1 Modification and withdrawal of bids shall be as follows:-

24.1.1 IN CASE OF E- TENDERING

The bidder may withdraw or modify its bid after bid submission but before the due date and time for submission as per tender document.

24.1.2 IN CASE OF MANUAL BIDDING

Deleted.

[E] – BID OPENING AND EVALUATION

25 EMPLOYER'S RIGHT TO ACCEPT ANY BID AND TO REJECT ANY OR ALL BIDS

- 25.1 TFL reserves the right to accept or reject any Bid, and to annul the Bidding process and reject all Bids, at any time prior to award of Contract, without thereby incurring any liability to the affected Bidder(s) or any obligations to inform the affected Bidder(s) of the ground for TFL's action. However, Bidder if so desire may seek the reason (in writing) for rejection of their Bid to which TFL shall respond quickly.
- 25.2 A bidder is to be permitted to send his representation in writing to dealing officer specified in tender for rejection of bid. But, such representation has to be sent upto 10(ten) days from the date of Notification of Award/FOA. A decision on representation will be taken by TFL within 15 (fifteen) days of the receipt of the representation. Only a directly affected bidder can represent in this regard:
- i) Only a bidder who has participated in tender can make such representation
 - ii) In case technical bid has been evaluated before the opening of the financial bid, an application for review in relation to the financial bid may be filed only by a bidder whose technical bid is found to be acceptable
- 25.3 However, following decisions of TFL shall not be subject to review:
- a) Determination of the need for procurement;
 - b) Selection of the mode of procurement or bidding system;
 - c) Choice of selection procedure;
 - d) Provisions limiting participation of bidders in the procurement process;
 - e) The decision to enter into negotiations with the L1 bidder;
 - f) Cancellation of the procurement process except where it is intended to subsequently re-tender the same requirements;
 - g) Issues related to ambiguity in contract terms may not be taken up after a contract has been signed, all such issues should be highlighted before consummation of the contract by the vendor/ contractor; and
 - h) Complaints against specifications except under the premise that they are either vague or too specific so as to limit competition may be permissible.

26 BID OPENING

26.1 Unpriced Bid Opening:

TFL/PDIL will open the price bids of those Bidders who meet the qualification requirement and whose bid is determined to be technically and commercially responsive. Techno-commercial bid evaluation status will be are to be informed to all bidders (including informing the techno-commercially not qualified Bidders). Price bids are to be opened in the presence of only techno-commercially acceptable bidders, who are willing to attend the bid opening, at a pre-publicised date, time and place or on the portal in case of e-procurement. The bidder's name, bid price, discount (if any) and any such details considered appropriate shall be read out during the price bid opening. Offers should not, repeat not, be circulated amongst the bidder's representative. Bidders selected for opening of their price bid shall be informed about the date & time of price bid opening. Bidders may depute their authorized representative to witness the price bid opening. The Bidders' representatives, who are present shall sign a Price Bid Opening Register evidencing their attendance and may be required to be present even on a short notice.

26.2 **Priced Bid Opening:**

26.2.1 TFL will open the price bids of those bidders who meet the qualification requirement and whose bids is determined to be technically and commercially responsive. Bidders selected for opening of their price bids shall be informed about the date of price bid opening.

Bidders may depute their authorized representative to attend the bid opening. The bidders' representatives, who are present shall sign a register evidencing their attendance and may be required to be present even on a short notice.

26.2.2 The price bids of those Bidders who were not found to be techno-commercially responsive shall not be opened.

In case of bids invited under the single bid system, bid shall be opened on the specified date & time.

26.3 **Reverse Auction**

NOT APPLICABLE

27 **CONFIDENTIALITY**

Information relating to the examination, clarification, evaluation and comparison of bids, and recommendations for the award of a contract, shall not be disclosed to bidders or any other person not officially concerned with such a process until the award to the successful bidder.

28 **CONTACTING THE EMPLOYER**

28.1 From the time of bid opening to the time of contract award, no bidder shall contact TFL on any matter related to the bid, except on request and prior written permission.

28.2 Any effort by the bidder to influence TFL in bid evaluation, bid comparison or contract award decisions will vitiate the process and will result in the rejection of the bidder's bid and action shall be initiated as per the TFL's procedure for action in case Corrupt / Fraudulent / Collusive / Coercive practices in this regard apart from forfeiture of EMD/ Bid Security, if any.

29 **EXAMINATION OF BIDS AND DETERMINATION OF RESPONSIVENESS**

29.1 The employer's determination of a bid's responsiveness is based on the content of the bid only. Prior to the detailed evaluation of Bids, the Employer will determine whether each Bid:

- (a) Meets the "Bid Evaluation Criteria" of the Bidding Documents ;
- (b) Has been properly signed;
- (c) Is accompanied by the required 'Earnest Money / Bid Security / Bid Security Declaration'
- (d) Is substantially responsive to the requirements of the Bidding Documents ; and
- (d) Provides any clarification and/or substantiation that the Employer may require to determine responsiveness pursuant to "ITB: Clause-29.2"

- 29.2 A substantially responsive Bid is one which conforms to all the terms, conditions and specifications of the Bidding Documents without material deviations or reservations or omissions for this purpose employer defines the foregoing terms below:
- a) "Deviation" is departure from the requirement specified in the tender documents.
 - b) "Reservation" is the setting of limiting conditions or withholding from complete acceptance of the requirement in the tender documents.
 - c) "Omission" is the failure to submit part or all of the information or documentation required in the tender document for evaluation of bid.
- 29.3 A material deviation, reservation or omission is one that,
- a) If accepted would,
 - i) Affect in any substantial way the scope, quality, or performance of the job as specified in tender documents.
 - ii) Limit, in any substantial way, inconsistent with the Tender Document, the Employer's rights or the tenderer's obligations under the proposed Contract.
 - b) If rectified, would unfairly affect the competitive position of other bidders presenting substantially responsive bids.
- 29.4 The employer shall examine all aspects of the bid to confirm that all requirements have been met without any material deviation, reservation or omission.
- 29.5 Tenders that do not meet the basic requirements specified in the bid documents are to be treated as unresponsive (both during Techno-commercial evaluation and Financial Evaluation in case of Two Bid System) and will be ignored. All tenders received will first be scrutinized to see whether the tenders meet the basic requirements as incorporated in the Bid document and to identify unresponsive tenders, if any. Unresponsive offers may not subsequently be made responsive by correction or withdrawal of the non- conforming stipulation. Some important points on the basis of which a tender may be declared as unresponsive and be ignored during the initial scrutiny are :
- i) The tender is not in the prescribed format or is unsigned or not signed as per the stipulations in the bid document;
 - ii) The required EMD has not been provided or exemption from EMD is claimed without acceptable proof of exemption;
 - iii) The bidder is not eligible to participate in the bid as per laid down eligibility criteria
 - iv) The bid departs from the essential requirements specified in the bidding document (for example, the tenderer has not agreed to give the required contract performance security); or
 - v) Against a schedule in the list of requirements in the tender enquiry, the tenderer has not quoted for the entire requirement as specified in that schedule (example: in a schedule, it has been stipulated that the tenderer will supply the equipment, install and commission it and also train the TFL's personnel for operating the equipment. The tenderer has, however, quoted only for supply of the equipment).

30 CORRECTION OF ERRORS-

Not Applicable.

31 CONVERSION TO SINGLE CURRENCY FOR COMPARISON OF BIDS

Not Applicable. All bids submitted must be in the currency specified at clause 14 of ITB.

32 EVALUATION AND COMPARISON OF BIDS

Bid shall be evaluated as per evaluation criteria mentioned in Section-II of bidding documents on lowest bid basis.

In case of a tie at the lowest bid (L1) position between two or more bidders, the order/LoA will be placed on the bidder who has higher/ highest turnover in last audited financial year.

In case there is a tie at the lowest bid (L1) position between only startup bidders and none of them has past turnover, the order/FOA will be placed on the startup who is registered earlier with Department for Promotion of Industry and Internal Trade (wherever applicable).

33 COMPENSATION FOR EXTENDED STAY [FOR APPLICABILITY OF THIS CLAUSE REFER BDS]:

Not Applicable

34 PURCHASE PREFERENCE

Purchase Preference as per Policy to Provide Purchase Preference as per Public Procurement (Preference to Make in India), Order 2017 Domestically Manufactured Telecom Products (DMTP) shall be allowed as per Government instructions in vogue, as applicable from time to time.

The Policy to Provide Purchase Preference as per Public Procurement (Preference to Make in India), Order is enclosed as Annexure V to ITB herewith.

Bidders are required to select the applicable purchase preference (i.e. preference category) option while submitting the bid on GePNIC portal. However, evaluation and applicability of purchase preference policy will be based on the confirmations & documents submitted by the bidder in the their bid irrespective of selection made on GePNIC portal.

[F] – AWARD OF CONTRACT

35 AWARD

Subject to "ITB: Clause-29", Owner will award the Contract to the successful Bidder whose Bid has been determined to be substantially responsive and has been determined as the lowest provided that bidder, is determined to be qualified to satisfactorily perform the Contract.

“TFL intends to place the contract directly on the address from where Goods are produced / dispatched or Services are rendered. In case, bidder wants contract at some other address or supply of Goods/ Services from multiple locations, bidder is required to provide in their bid address on which order is to be placed.”

TFL will place the Contract directly on the successful bidder from whom the bid has been received & evaluated and will not place order on other entities such as subsidiary, business associate or partner, dealer/distributor etc. of the Bidder.

36 NOTIFICATION OF AWARD / FAX OF ACCEPTANCE

- 36.1 Prior to the expiry of 'Period of Bid Validity', Notification of Award for acceptance of the Bid will be intimated to the successful Bidder by TFL either by E-mail /Letter or like means defined as the "Fax of Acceptance (FOA)". The Contract shall enter into force on the date of FOA and the same shall be binding on TFL and successful Bidder (i.e. Contractor). The Notification of Award/FOA will constitute the formation of a Contract. The detailed Letter of Acceptance shall be issued thereafter incorporating terms & conditions of Tender Document, Corrigendum, Clarification(s), Bid and agreed variation(s)/acceptable deviation(s), if any. TFL may choose to issue Notification of Award in form of detailed Letter of Acceptance without issuing FOA and in such case the Contract shall enter into force on the date of Detailed Letter of Acceptance only.
- 36.2 Contract period shall commence from the date of "Notification of Award" or as mentioned in the Notification of Award. The "Notification of Award" will constitute the formation of a Contract, until the Contract has been effected pursuant to signing of Contract as per "ITB: Clause-37".
- 36.3 Upon the successful Bidder's / Contractor's furnishing of 'Contract Performance Security / Security Deposit', pursuant to "ITB: Clause-38", TFL will promptly discharge his 'Earnest Money Deposit / Bid Security (if applicable)', pursuant to "ITB: Clause-16".
- 36.4 The Order/ contract value mentioned above is subject to Mutually Agreed Damages clause.
- 36.5 TFL will award the Contract to the successful Bidder, who, within 'fifteen [15] days' of receipt of the same, shall sign and return the acknowledged copy to TFL.

37 SIGNING OF AGREEMENT

The successful Bidder/Contractor shall be required to execute an 'Agreement' in the proforma given in this Bidding Document) on a 'non-judicial stamp paper' of appropriate value [cost of the 'stamp-paper' shall be borne by the successful Bidder/Contractor] and of 'state of India' specified in Bidding Data Sheet (BDS) only, within 'fifteen [15] days' of receipt of the "Fax of Acceptance (FOA)" by the successful Bidder/Contractor failure on the part of the successful Bidder/Contractor to sign the 'Agreement' within the above stipulated period, shall constitute sufficient grounds for forfeiture of EMD / Security Deposit / Action as per Bid Security declaration.

38 CONTRACT PERFORMANCE SECURITY / SECURITY DEPOSIT(CPS/SD)

- 38.1 Within 30 days of the receipt of the notification of Award/ Fax of Acceptance (FOA) by from TFL, the successful bidder shall furnish the Contract Performance Security (CPS) in accordance with of General Conditions of the Contract. The CPS shall be in the form of either Banker's Cheque or Demand Draft or Bank Guarantee or Letter of Credit and shall be in the currency of the Contract. However, CPS shall not be applicable in cases wherein the individual contract value as specified in Notification of Award is less than INR 5 Lakh (exclusive of GST).
- 38.2 The CONTRACT PERFORMANCE SECURITY shall be for an amount equal specified in Bidding Data Sheet (BDS) towards faithful performance of the contractual obligations and performance of equipment. For the purpose of CPS, Contract/order value shall be exclusive of **GST (CGST & SGST/UTGST or IGST)** .

Bank Guarantee towards CPS shall be from any Indian scheduled bank or a branch of an International bank situated in India and registered with Reserve Bank of India as scheduled foreign bank . However, in case of bank guarantees from banks other than the Nationalized Indian banks, the bank must be a commercial bank having net worth in excess of Rs 100 crores and a declaration to this effect should be made by such commercial bank either in the Bank Guarantee itself or separately on its letterhead.

38.3 Failure of the successful bidder to comply with the requirements of this article shall constitute sufficient grounds for consideration of the annulment of the award and Forfeiture of EMD/action as per declaration of Bid Security.

38.4 The CPS has to cover the entire contract value including extra works/services also. As long as the CPS submitted at the time of award take cares the extra works/services executed and total executed value are within the awarded contract price, there is no need for additional CPS. As soon as the total executed value is likely to burst the ceiling of awarded contract price, the contractor should furnish additional CPS.

38.5 DELETED

38.6 In addition to existing specified form (i.e. Demand Draft (DD)/ Banker's Cheque/ Bank Guarantee) mentioned in tender documents for submission of Security Deposit/ Contract Performance Security, the successful bidder can also submit the Security Deposit/ Contract Performance Security through online banking transaction i.e. IMPS/NEFT/RTGS/SWIFT etc. For this purpose, the details of TFL's Bank Account is mentioned in BDS. Further, in case a successful Bidder is willing to furnish CPS through SWIFT, the details may be obtained from Purchase Officer immediately after receipt of FOA.

While remitting such online transaction, the bidder must indicate "**Security Deposit/ Contract Performance Security against FOA/DLOA no. _____(contractor to specify the FOA/DLOA No.)**" under remarks column of such transaction of respective bank portal. The contractor/vendor shall be required to submit the successful transaction details to the dealing officer immediately through email/letter and necessarily within 30 days from the date of Fax of Acceptance.

38.7 In case of forfeiture of Contract Performance Security/ Security Deposit in terms of GCC, the forfeited amount will be considered inclusive of tax and tax invoice will be issued by TFL. The forfeiture amount will be subject to final decision of TFL based on other terms and conditions of order/ contract.

38.8 The Contractor will also submit covering letter along with CPS as per format at F-4.

38.9 CPBG/Security Deposit will not be accepted in case the same has reference of 'remitter'/financer' other than bidder on the aforementioned financial instrument of CPBG/ Security Deposit submitted by the Contractor.

38.10 The first payment to vendor is to be released only after submission of CPS / Security Deposit (SD).

38.11 Before the CPS / Security Deposit (SD) is released a "No Claim Certificate" is to be submitted by the supplier/vendor.

38.12 In case, TFL allows additional time for submission of CPBG/SD beyond 30 days, a penal interest of Marginal Cost of Fund based Lending Rate (MCLR) for one year charged by SBI (applicable on due date of submission of CPBG/SD i.e. 30th day after issuance of FOA/Notification of award) plus 4.0% p.a (on CPBG/SD amount) shall be charged for delay beyond 30 days i.e. from 31st days after issuance of FOA.

39 PROCEDURE FOR ACTION IN CASE CORRUPT/FRAUDULENT/COLLUSIVE/COERCIVE PRACTICES

39.1 Procedure for action in case Corrupt/ Fraudulent/Collusive/Coercive Practices is enclosed at Annexure-I.

39.2 Name and contact details of nodal officer:

Shri S K Hota
Tel: +916760-261260
Email: skhota@rcfltd.com

39.4 NON-APPLICABILITY OF ARBITRATION CLAUSE IN CASE OF BANNING OF VENDORS/ SUPPLIERS / CONTRACTORS/ BIDDERS/ CONSULTANTS INDULGED IN FRAUDULENT/ COERCIVE PRACTICES

Notwithstanding anything contained contrary in GCC and other "CONTRACT DOCUMENTS", in case it is found that the Contractors/Bidders indulged in fraudulent/coercive practices at the time of bidding, during execution of the contract etc. and/or on other grounds as mentioned in OWNER's "Procedure for action in case Corrupt/Fraudulent/Collusive/Coercive Practices" (Annexure-I to Section-III of tender), the contractor/bidder shall be banned (in terms of aforesaid procedure) from the date of issuance of such order by TFL, to such Contractors/Bidders.

The Contractor/ Bidder understands and agrees that in such cases where Contractor/ Bidder has been banned (in terms of aforesaid procedure) from the date of issuance of such order by TFL, such decision of TFL shall be final and binding on such Contractor/ Bidder and the 'Arbitration clause' in the GCC and other "CONTRACT DOCUMENTS" shall not be applicable for any consequential issue /dispute arising in the matter.

40 PUBLIC PROCUREMENT POLICY FOR MICRO AND SMALL ENTERPRISES

40.1 Government of India, vide Gazette of India No. 503 dated 26.03.2012 proclaimed the Public Procurement Policy for Micro and Small Enterprises (MSEs). The following benefit is available in case of work contract also:

- i) Issue of tender document to MSEs free of cost.
- ii) Exemption to MSEs from payment of EMD/Bid Security .

40.2 **In case Bidder is a Micro or Small Enterprise, the Bidder shall submit Udyam Registration Certificate for availing benefit under Public Procurement Policy for MSEs-2012.**

Vide Gazette notification dated 18.10.2022 of Ministry of MSME, the following is notified:

"In case of an upward change in terms of investment in plant and machinery or equipment or turnover or both, and consequent re-classification, an enterprise shall continue to avail of

all nontax benefits of the category (micro or small or medium) it was in before the re-classification, for a period of three years from the date of such upward change”

Accordingly, in case of upward change in status, MSE bidder is required to submit the previous certificate also to get the MSE benefit.

The above documents submitted by the bidder shall be duly certified by the Chartered Accountant (not being an employee or a Director or not having any interest in the bidder's company/firm) and notary public with legible stamp.

If the bidder does not provide the above confirmation or appropriate document or any evidence, then it will be presumed that they do not qualify for any preference admissible in the Public Procurement Policy (PPP) 2012.

Further, MSEs who are availing the benefits of the Public Procurement Policy (PPP) 2012 get themselves registered with MSME Data Bank being operated by NSIC, under SME Division, M/o MSME, in order to create proper data base of MSEs which are making supplies to CPSUs.

41.3 If against an order placed by TFL, successful bidder(s) (other than Micro/Small Enterprise) is procuring material/services from their sub-vendor who is a Micro or Small Enterprise as per provision mentioned at clause no.40.2 with prior consent in writing of the purchasing authority/Engineer-in-charge, the details like Name, Registration No., Address, Contact No. details of material & value of procurement made, etc. of such Enterprises shall be furnished by the successful bidder at the time of submission of invoice/Bill.

41.4 The benefit of policy are not extended to the traders/dealers/ Distributors /Stockiest/Wholesalers.

41.5 NSIC has initiated a scheme of “Consortia and Tender Marketing Scheme” under which they are assisting the Micro & Small enterprises to market their products and services through tender participation on behalf of the individual unit or through consortia. Accordingly, if the MSEs or the consortia, on whose behalf the bid is submitted by NSIC, is meeting the BEC and other terms and conditions of tender their bid will be considered for further evaluation.

Further, in such cases a declaration is to be submitted by MSE/ consortia on their letter head (s) that all the terms and conditions of tender document shall be acceptable to them.

40.6 It may be noted that Government of India has implemented Trade Receivable Discounting System (TReDS) to address challenges faced by MSMEs in delayed payments (after receipt/acceptance of Material/Services) from Government buyers leading to shortfall of Working Capital. TReDS is an online electronic institutional mechanism for facilitating the financing of trade receivables of MSMEs through multiple financiers. TFL is already registered on the following TReDS platform:

- M/s Receivable Exchange of India (RXIL), Mumbai
- M/s Mynd Solutions Private Limited (Mynd), New Delhi
- M/s A. TREDS (Invoicemart), Mumbai

MSME Bidders are required to register on the TReDS platform. The MSME vendors can avail the TReDS facility, if they want to.

40.7 Interest payment on delayed payments to MSME is payable in line with Micro, Small and Medium Enterprises Development Act, 2006

42 AHR ITEMS

Not applicable.

42 VENDOR PERFORMANCE EVALUATION

Shall be as stipulated Annexure II to ITB herewith.

43 INCOME TAX & CORPORATE TAX

43.1 Income tax deduction shall be made from all payments made to the contractor as per the rules and regulations in force and in accordance with the Income Tax Act prevailing from time to time.

43.2 Corporate Tax liability, if any, shall be to the contractor's account.

43.3 TDS

(i) TDS, wherever applicable, shall be deducted as per applicable act/law/rule.

(ii) **Higher rate of TDS for non-filers of ITR**

As per Section 206AB of Income Tax Act, 1961, in case of any vendor/customer who does not filed their Income Tax Return for both of the two previous years preceding to current year and aggregate amount of TDS is more than or equal to 50,000/- in each of those previous two years (or limit defined by Govt. from time to time), then TDS will be deducted at the higher of following rates:

(I) Twice the rate mentioned in relevant TDS section.

(II) Twice the rate or rates in force

(III) 5%

43.4 MENTIONING OF PAN NO. IN INVOICE/BILL

As per CBDT Notification No. 95/2015 dated 30.12.2015, mentioning of PAN no. is mandatory for procurement of goods / services/works/consultancy services exceeding Rs. 2 Lacs per transaction or as amended from time to time.

Accordingly, contractor should mention their PAN no. in their invoice/ bill for any transaction exceeding Rs. 2 lakhs or as amended from time to time. As provided in the notification, in case contractor do not have PAN no., they have to submit declaration in Form 60 along with invoice/ bill for each transaction.

Payment of contractor shall be processed only after fulfilment of above requirement.

44. DISPUTE RESOLUTION MECHANISM

44.1 QUARTERLY CLOSURE OF THE CONTRACT

During execution of orders, various issues may arise. In order to timely detect and to address the contractual issue(s) during the execution of contracts, TFL has introduced a mechanism of Quarterly Closure of the contract, under which all the related issues /disputes will be monitored and addressed on quarterly basis for resolution. Vendor (hereinafter referred 'Vendor') should first refer any issues/disputes to Engineer-in-Charge(EIC) for LOA/contracts/ Dealing C&P Executive for Purchase Orders and cooperate them for smooth execution of the contract and to timely address the issues, if any. For applicability of 'Quarterly Closure', please refer BDS.

44.2 ARBITRATION

All issue(s)/dispute(s) excluding the matters that have been specified as excepted matters and listed at clause no. 2.6 and which cannot be resolved through Conciliation, such issue(s)/dispute(s) shall be referred to arbitration for adjudication by Sole Arbitrator.

The party invoking the Arbitration shall have the option to either opt for Ad-hoc Arbitration as provided at Clause 2.1 below or Institutionalized Arbitration as provided at Clause 2.2 below, the remaining clauses from 2.3 to 2.7 shall apply to both Ad-hoc and Institutional Arbitration:-

2.1 On invocation of the Arbitration clause by either party, TFL shall suggest a panel of three independent and distinguished persons (Retd Supreme Court & High Court Judges only) to the other party from the Panel of Arbitrators maintained by 'Delhi International Arbitration Centre (DIAC) to select any one among them to act as the Sole Arbitrator. In the event of failure of the other party to select the Sole Arbitrator within 30 days from the receipt of the communication from TFL suggesting the panel of arbitrators, the right of selection of the sole arbitrator by the other party shall stand forfeited and TFL shall appoint the Sole Arbitrator from the suggested panel of three Arbitrators for adjudication of dispute(s). The decision of TFL on the appointment of the sole arbitrator shall be final and binding on the other party. The fees payable to Sole Arbitrator shall be governed by the fee Schedule of "Delhi International Arbitration Centre".

OR

2.2 If a dispute arises out of or in connection with this contract, the party invoking the Arbitration shall submit that dispute to any one of the Arbitral Institutions i.e ICADR/ICA/DIAC/SFCA and that dispute shall be adjudicated in accordance with their respective Arbitration Rules. The matter shall be adjudicated by a Sole Arbitrator who shall necessarily be a Retd. Supreme Court/High Court Judge to be appointed/nominated by the respective institution. The cost/expenses pertaining to the said Arbitration shall also be governed in accordance with the Rules of the respective Arbitral Institution. The decision of the party invoking the Arbitration for reference of dispute to a specific Arbitral institution for adjudication of that dispute shall be final and binding on both the parties and shall not be subject to any change thereafter. The institution once selected at the time of invocation of dispute shall remain unchanged.

2.3 The cost of arbitration proceedings shall be shared equally by the parties.

- 2.4 The Arbitration proceedings shall be in English language and the seat, venue and place of Arbitration shall be New Delhi, India only.
- 2.5 Subject to the above, the provisions of Arbitration & Conciliation Act 1996 and any amendment thereof shall be applicable. All matter relating to this Contract and arising out of invocation of Arbitration clause are subject to the exclusive jurisdiction of the Court(s) situated at New Delhi.
- 2.6 List of Excepted matters:
- a) Dispute(s)/issue(s) involving claims below Rs 25 lakhs and above Rs 25 crores.
 - b) Dispute(s)/issue(s) relating to indulgence of Contractor/Vendor/Bidder in corrupt/fraudulent/collusive/coercive practices and/or the same is under investigation by CBI or Vigilance or any other investigating agency or Government.
 - c) Dispute(s)/issue(s) wherein the decision of Engineer-In-Charge/owner/TFL has been made final and binding in terms of the Contract.
- 2.7. Disputes involving claims below Rs 25 Lakhs and above Rs. 25 crores:- Parties mutually agree that dispute(s)/issue(s) involving claims below Rs 25 Lakhs and above Rs 25 crores shall not be subject matter of Arbitration and are subject to the exclusive jurisdiction of the Court(s) situated at New Delhi.

44.3 GOVERNING LAW AND JURISDICTION:

The Contract shall be governed by and construed in accordance with the laws in force in India. The Parties hereby submit to the exclusive jurisdiction of the Courts situated at New Delhi for adjudication of disputes, injunctive reliefs, actions and proceedings, if any, arising out of this Contract.

45. DISPUTES BETWEEN CPSE'S/ GOVERNMENT DEPARTMENT'S / ORGANIZATIONS

Subject to conciliation as provided above, in the event of any dispute (other than those related to taxation matters) or difference relating to the interpretation and application of the provisions of commercial contract(s) between Central Public Sector Enterprises (CPSEs)/ Port Trusts inter se and also between CPSEs and Government Departments /Organizations , such dispute or difference shall be taken up by either party for resolution only through AMRCD as mentioned in OPE OM No. 4(1)/2013-DPE(GM)/FTS-1835 dated 22-05-2018.

Any party aggrieved with the decision of the Committee at the First level (tier) may prefer an appeal before the Cabinet Secretary at the Second level (tier) within 15 days from the date of receipt of decision of the Committee at First level, through it's administrative Ministry/Department, whose decision will be final and binding on all concerned.

The above provisions mentioned at clause no. 44 & 45 shall supersede provisions relating to Conciliation, Arbitration, Governing Law & Jurisdiction and Disputes between CPSE's/ Government Department's/ Organizations mentioned in General Conditions of Contract (GCC) and elsewhere in tender document.

46 **INAM-PRO (PLATFORM FOR INFRASTRUCTURE AND MATERIALS PROVIDERS)**

INAM-Pro (Platform for infrastructure and materials providers) is a web based platform for infrastructure provides and materials suppliers and was developed by Ministry of Road Transport and Highways (MoRT&H) with a view to reduce project execution delays on account of supply shortages and inspire greater confidence in contractors to procure cement to start with directly from the manufacturers. Presently, numerous cement companies are registered in the portal and offering cement for sale on the portal with a commitment period of 3 years. These companies have bound themselves by ceiling rates for the entire commitment period, wherein they are allowed to reduce or increase their cement rates any number of times within the ceiling rate, but are not permitted to exceed the said ceiling rate.

MoRT&H is expanding the reach of this web-portal by increasing both the product width as well as the product depth. They are working on incorporating 60 plus product categories. The product range will span from large machineries like Earth Movers and Concrete Mixers, to even the smallest items like road studs. MoRT&H intend to turn it into a portal which services every infrastructure development related need of a modern contractor.

TFL's contractors may use this innovative platform, wherever applicable. The usage of web – Portal is a completely voluntary exercise. The platform, however, can serve as a benchmark for comparison of offered prices and products.

47 **PROMOTION OF PAYMENT THROUGH CARDS AND DIGITAL MEANS**

To promote cashless transactions, the onward payments by Contractors to their employees, service providers, sub-contractors and suppliers may be made through Cards and Digital means to the extent possible

48 **CONTRACTOR TO ENGAGE CONTRACT MANPOWER BELONGING TO SCHEDULED CASTES AND WEAKER SECTIONS OF THE SOCIETY**

While engaging the contractual manpower, Contractors are required to make efforts to provide opportunity of employment to the people belonging to Scheduled Castes and weaker sections of the society also in order to have a fair representation of these sections.

49 **PROVISIONS FOR STARTUPS (AS DEFINED IN GAZETTE NOTIFICATION NO. D.L-33004/99 DATED 18.02.2016 AND 23.05.2017 OF MINISTRY OF COMMERCE AND INDUSTRY AND AS AMENDED FROM TIME TO TIME) [FOR APPLICABILITY REFER BDS]**

As mentioned in Section-II, Technical and Financial BEC shall be applicable for all Startups [whether Micro & Small Enterprises (MSEs) or otherwise].

Further, the Startups are also exempted from submission of EMDs (if applicable).

If a Startup emerge lowest bidder, the LoA on such Startup shall be placed for entire tendered quantity/group/item/part (as the case may be). However, during the Kick of Meeting monthly milestones/ check points would be drawn. Further, the performance of such contractor/ service provider will be reviewed more carefully and action to be taken as per provision of contract in case of failure/ poor performance.

50. PROVISION REGARDING INVOICE FOR REDUCED VALUE OR CREDIT NOTE TOWARDS MAD

MAD is the reduction in the consideration / contract value for the / services covered under this contract. In case of delay in execution of service provider should raise invoice for reduced value as per MAD) clause. If service provider has raised the invoice for full value, then service provider should issue Credit Note towards the applicable MAD amount with applicable taxes.

In such cases if service provider fails to submit the invoice with reduced value or does not issue credit note as mentioned above, TFL will release the payment to service provider after giving effect of the MAD clause with corresponding reduction of taxes charged on service provider's invoice, to avoid delay in payment.

In case any financial implication arises on TFL due to issuance of invoice without reduction in price or non-issuance of Credit Note, the same shall be to the account of service provider. TFL shall be entitled to deduct / setoff / recover such GST amount (CGST & SGST/UTGST or IGST) together with penalties and interest, if any, against any amounts paid or becomes payable by OWNER in future to the service provider's under this contract or under any other contract.

51. UNIQUE DOCUMENT IDENTIFICATION NUMBER BY PRACTICING CHARTERED ACCOUNTANTS

Practicing Chartered Accountants shall generate Unique Document Identification Number (UDIN) for all certificates issued by them as per provisions of Tender Document.

However, UDIN may not be required for documents being attested by Chartered Accountants in terms of provisions of Tender Document.

52. PROVISION FOR PROCUREMENT FROM A BIDDER WHICH SHARES A LANDBORDER WITH INDIA.

The clause regarding provision for procurement from a bidder which shares a land with India is enclosed as Annexure-VII to ITB herewith.

53. ANJANI PORTAL

TFL has implemented "Anjani" e-Measurement Book & e-Billing Portal for ease in submission of measurement book/bill and reduction in paper transaction.

Accordingly, TFL will process the Bill with Measurement Book through "Anjani" e-Measurement Book & e-Billing Portal (link: <https://gailebank.gail.co.in/MBAutomation/frmllogin.aspx>). Accordingly, Contractor/ Service Provider/ Consultant is requested to forward the RA Bill on "Anjani" e-Measurement Book & e-Billing Portal through concerned EIC/CIC/SIC, whichever is applicable. Further, User Manual is also available on aforesaid portal.

54. DOCUMENTS FOR PAYMENT:

Payment terms shall be as mentioned in GCC-Works/SCC.

However, for release of payment, Contractor is required to submit invoice along with other documents as mentioned in SCC. The final bill is to be submitted within one month after completion.

Further, TFL is in process of implementing Vendor Invoice Management (VIM). After implementation of same (to be communicated separately), Contractor/ Vendor to forward the invoice on VIM Collection Center or upload digital invoice on Portal (details of same will be provided separately). The copy of invoice and all other document mentioned above or in order/ contract is to be forwarded to address provided in order/contract.

55. ORDER TRANSMITTAL SYSTEM:

The complete PO/LOA along with all annexures including tender document shall be shared through order/contract transmittal system after intimation through email.

Supplier/Contractor is requested to visit <https://gailonline.com/home.html> and click on link order/contract transmittal system (It can be found under Vendor Zone (Portal For Suppliers)) or https://gailebank.gail.co.in/GOGA_AUDIT/frmUserLogin.aspx.

Therein, in order to access the detailed order/contract, supplier/contractor shall be prompted to enter your email id. Further an OTP shall be sent on your registered mobile number. After entering OTP, supplier/contractor shall be allowed to download complete PO/LOA along with all annexures including tender document. After downloading the documents, the supplier/contractor shall be required to digitally sign the document (by authorized signatory) for uploading the documents on order/contract transmittal system towards acknowledgement of the same.

~~55. SUB-LETTING OF WORKS~~

~~The following is added to the Clause no. 37 of General Conditions of Contract (GCC)-Works:~~

- ~~(i) Procurement of material, hire of equipment or engagement of labour will not mean sub-contracting.~~
- ~~(ii) Sub-contracting by the contractor without the approval of TFL shall be a breach of contract, unless explicitly permitted in the contract.~~
- ~~(iii) However, If specified in SCC Sub-contracting for Specialized Items of Work is allowed upto certain percentage of work~~

PROCEDURE FOR ACTION IN CASE CORRUPT/FRAUDULENT/COLLUSIVE/COERCIVE PRACTICES

Annexure-I

A Definitions:

- A.1 “Corrupt Practice” means the offering, giving, receiving or soliciting, directly or indirectly, anything of value to improperly influence the actions in selection process or in contract execution.
- “Corrupt Practice” also includes any omission for misrepresentation that may mislead or attempt to mislead so that financial or other benefit may be obtained or an obligation avoided.
- A.2 “Fraudulent Practice” means and include any act or omission committed by a agency or with his connivance or by his agent by misrepresenting/ submitting false documents and/ or false information or concealment of facts or to deceive in order to influence a selection process or during execution of contract/ order.
- A.3 “Collusive Practice amongst bidders (prior to or after bid submission)” means a scheme or arrangement designed to establish bid prices at artificial non-competitive levels and to deprive the Employer of the benefits of free and open competition.
- A.4 “Coercive practice” means impairing or harming or threatening to impair or harm directly or indirectly, any agency or its property to influence the improperly actions of an agency, obstruction of any investigation or auditing of a procurement process.
- A.5 “Vendor/Supplier/Contractor/Consultant/Bidder” is herein after referred as “Agency”
- A.6 “Appellate Authority” shall mean Committee of Directors consisting of Director (Finance) and Director (BD) for works centers under Director (Projects). For all other cases committee of Directors shall consist of Director (Finance) & Director (Projects).
- A.7 “Competent Authority” shall mean the authority, who is competent to take final decision for Suspension of business dealing with an Agency/ (ies) and Banning of business dealings with Agency/ (ies) and shall be the “Director” concerned.
- A.8 “Allied Agency” shall mean all concerns which come within the sphere of effective influence of the banned/suspended agency shall be treated as allied agency. In determining this, the following factors may be taken into consideration:
- a) Whether the management is common;
 - b) Majority interest in the management is held by the partners or directors of banned/ suspended agency;
 - c) Substantial or majority shares are owned by the banned/ suspended agency and by virtue of this it has a controlling voice.
 - d) Directly or indirectly controls, or is controlled by or is under common control with another bidder.

e) All successor agency will also be considered as allied agency.
A.9 "Investigating Agency" shall mean any department or unit of TFL investigating into the conduct of Agency/ party and shall include the Vigilance Department of the TFL, Central Bureau of Investigation, State Police or any other agency set up by the Central or state government having power to investigate.

A.10 "Obstructive practice": materially impede the procuring entity's investigation into allegations of one or more of the above mentioned practices either by deliberately destroying, falsifying, altering; or by concealing of evidence material to the investigation; or by making false statements to investigators and/ or by threatening, harassing or intimidating any party to prevent it from disclosing its knowledge of matters relevant to the investigation or from pursuing the investigation; or by impeding TFL's rights of audit or access to information.

B Actions against bidder(s) indulging in corrupt /fraudulent/ collusive/ coercive practice

B.1 Irregularities noticed during the evaluation of the bids :

If it is observed during bidding process/ bids evaluation stage that a bidder has indulged in corrupt/fraudulent /collusive/coercive practice, the bid of such Bidder (s) shall be rejected and its Earnest Money Deposit (EMD) shall be forfeited.

Further, such agency shall be banned for future business with TFL for a period specified in para B 2.2 below from the date of issue of banning order.

B.2 Irregularities noticed after award of contract

(i) During execution of contract:

If an agency, is found to have indulged in corrupt/fraudulent/ collusive/coercive practices, action shall be initiated for putting the agency on banning list.

After conclusion of process and issuance of Speaking order for putting party on banning list, the order (s)/ contract (s) where it is concluded that such irregularities have been committed shall be terminated and Contract cum Performance Bank Guarantee (CPBG) submitted by agency against such order (s)/ contract (s) shall also be forfeited. Further such order/ contract will be closed following the due procedure in this regard.

The amount that may have become due to the contractor on account of work already executed by him shall be payable to the contractor and this amount shall be subject to adjustment against any amounts due from the contractor under the terms of the contract. No risk and cost provision will be enforced in such cases.

Suspension of order/ contract:

Further, only in the following situations, the concerned order (s)/ contract(s) (where Corrupt/Fraudulent/ Collusive/ Coercive Practices are observed) and payment shall be suspended after issuance of Suspension cum Show Cause Notice:

(i) Head of Corporate Vigilance Department/CVO based on the investigation by them, recommend for specific immediate action against the agency.

- (ii) Head of Corporate Vigilance Department/CVO based on the input from investigating agency, forward for specific immediate action against the agency.

Suspension cum Show Cause Notice being issued in above cases after approval of the competent authority (as per provisions mentioned under Clause no. D) shall also include the provision for suspension of Order (s)/ Contract (s) and payment. Accordingly, after issuance of Suspension cum Show Cause Notice, the formal communication for suspension of Order (s)/ Contract (s) and payment with immediate effect will be issued by the concerned person of TFL.

During suspension, Contractor/ Service Providers will be allowed to visit the plant/ site for upkeep of their items/ equipment, TFL's issued materials (in case custody of same is not taken over), demobilizing the site on confirmation of EIC, etc.

In addition to above, Recovery of payments (other than due payments) including balance advance payments, if any, made by along with interest thereon at the prevailing rate shall be recovered.

(ii) After execution of contract and during Defect liability period (DLP)/ Warranty/Guarantee Period:

If an agency is found to have indulged in corrupt/fraudulent/ collusive/coercive practices, after execution of contract and during DLP/ Warranty/Guarantee Period, the agency shall be banned for future business with TFL for a period specified in para B 2.2 below from the date of issue of banning order.

Further, the Contract cum Performance Bank Guarantee (CPBG)/Contract Performance Security (CPS) submitted by agency against such order (s)/ contract (s) shall be forfeited.

(iii) After expiry of Defect liability period (DLP)/ Warranty/Guarantee Period

If an agency is found to have indulged in corrupt/fraudulent/ collusive/coercive practices, after expiry of Defect liability period (DLP)/ Warranty/Guarantee Period, the agency shall be banned for future business with TFL for a period specified in para B 2.2 below from the date of issue of banning order.

B.2.2 Period of Banning

The period of banning of agencies indulged in Corrupt/Fraudulent/Collusive/Coercive Practices shall be as under and to be reckoned from the date of banning order:

S. No.	Description	Period of banning from the date of issuance of Banning order
1	Misrepresentation/False information other than pertaining to BEC of tender but having impact on the selection process. For example, if an agency confirms not being in	06 months

	holiday in TFL/PSU's PMC or banned by PSUs/ Govt. Dept., liquidation, bankruptcy & etc. and subsequently it is found otherwise, such acts shall be considered in this category.	
2	Corrupt/Fraudulent (except mentioned sl. no. 1 above) /Collusive/Coercive Practices If an agency again commits Corrupt/Fraudulent (except mentioned sl. no. 1 above) /Collusive/ Coercive Practices in subsequent cases after their banning, such situation of repeated offense to be dealt with more severity	2 years (in addition to the period already served)
2.1		
3	Indulged in unauthorized disposal of materials provided by TFL	2 years
4	If act of vendor/ contractor is a threat to the National Security	2 years

C Effect of banning on other ongoing contracts/ tenders

- C.1 If an agency is put on Banning, such agency should not be considered in ongoing tenders/future tenders.
- C.2 However, if such an agency is already executing other order (s)/ contract (s) where no corrupt/fraudulent/ collusive/coercive practice is found, the agency should be allowed to continue till its completion without any further increase in scope except those incidental to original scope mentioned in the contract.
- C.3 If an agency is put on the Banning List during tendering and no irregularity is found in the case under process:
 - C.3.1 after issue of the enquiry /bid/tender but before opening of Technical bid, the bid submitted by the agency shall be ignored.
 - C.3.2 after opening Technical bid but before opening the Price bid, the Price bid of the agency shall not be opened and BG/EMD submitted by the agency shall be returned to the agency.
 - C.3.3 after opening of price, BG/EMD made by the agency shall be returned; the offer of the agency shall be ignored & will not be further evaluated. . In case such agency is lowest (L-1), next lowest bidder shall be considered as L-1

D. Procedure for Suspension of Bidder

D.1 Initiation of Suspension

Action for suspension business dealing with any agency/(ies) shall be initiated by Corporate C&P Department when

- (i) Corporate Vigilance Department based on the fact of the case gathered during investigation by them recommend for specific immediate action against the agency.

- (ii) Corporate Vigilance Department based on the input from Investigating agency, forward for specific immediate action against the agency.
- (iii) Non performance of Vendor/Supplier/Contractor/Consultant leading to termination of Contract/ Order.

D.2 Suspension Procedure:

- D.2.1 The order of suspension would operate initially for a period not more than six months and is to be communicated to the agency and also to Corporate Vigilance Department. Period of suspension can be extended with the approval of the Competent Authority by one month at a time with a ceiling of six months pending a conclusive decision to put the agency on banning list.
- D.2.2 During the period of suspension, no new business dealing may be held with the agency.
- D.2.3 Period of suspension shall be accounted for in the final order passed for banning of business with the agency.
- D.2.4 The decision regarding suspension of business dealings should also be communicated to the agency.
- D.2.5 If a prima-facie, case is made out that the agency is guilty on the grounds which can result in banning of business dealings, proposal for issuance of suspension order and show cause notice shall be put up to the Competent Authority. The suspension order and show cause notice must include that (i) the agency is put on suspension list and (ii) why action should not be taken for banning the agency for future business from TFL. The competent authority to approve the suspension will be same as that for according approval for banning.

D 3 Effect of Suspension of business:

Effect of suspension on other on-going/future tenders will be as under:

- D.3.1 No enquiry/bid/tender shall be entertained from an agency as long as the name of agency appears in the Suspension List.
- D.3.2 If an agency is put on the Suspension List during tendering:
 - D.3.2.1 after issue of the enquiry /bid/tender but before opening of Technical bid, the bid submitted by the agency shall be ignored.
 - D.3.2.2 after opening Technical bid but before opening the Price bid, the Price bid of the agency shall not be opened and BG/EMD submitted by the agency shall be returned to the agency.
 - D.3.2.3 after opening of price, BG/EMD made by the agency shall be returned; the offer of the agency shall be ignored & will not be further evaluated. . In case such agency is lowest (L-1), next lowest bidder shall be considered as L-1D.3.3 The existing contract (s)/ order (s) under execution shall continue.
- D.3.4 Tenders invited for procurement of goods, works and services shall have provision that the bidder shall submit a undertaking to the effect that (i) neither the bidder themselves nor their allied agency/(ies) are on banning list of TFL and(ii) bidder is not banned by any Government department/ Public Sector.

F. Appeal against the Decision of the Competent Authority:

- F.1 The agency may file an appeal against the order of the Competent Authority for putting the agency on banning list. The appeal shall be filed to Appellate Authority. Such an appeal shall be preferred within one month from the of receipt of banning order.
- F.2 Appellate Authority would consider the appeal and pass appropriate order which shall be communicated to the party as well as the Competent Authority.

- F.3 Appeal process may be completed within 45 days of filing of appeal with the Appellate Authority.
- G. Wherever there is contradiction with respect to terms of 'Integrity pact' , GCC and 'Procedure for action in case of Corrupt/Fraudulent/ Collusive/Coercive Practice', the provisions of 'Procedure for action in case of Corrupt/Fraudulent/ Collusive/Coercive Practice' shall prevail.

**PROCEDURE FOR EVALUATION OF PERFORMANCE OF VENDORS/ SUPPLIERS/
CONTRACTORS/ CONSULTANTS**

1.0 **GENERAL**

A system for evaluation of Vendors/ Suppliers/Contractors/ Consultants and their performance is a key process and important to support an effective purchasing & contracting function of an organization.

Performance of all participating Vendors/ Suppliers/Contractors/ Consultants need to be closely monitored to ensure timely receipt of supplies from a Vendor, completion of an assignment by a Consultant or complete execution of order by a contractor within scheduled completion period. For timely execution of projects and meeting the operation & maintenance requirement of operating plants, it is necessary to monitor the execution of order or contracts right from the award stage to completion stage and take corrective measures in time.

2.0 **OBJECTIVE**

The objective of Evaluation of Performance aims to recognize, and develop reliable Vendors/ Suppliers/Contractors/ Consultants so that they consistently meet or exceed expectations and requirements.

The purpose of this procedure is to put in place a system to monitor performance of Vendors/ Suppliers/Contractors/ Consultants associated with TFL so as to ensure timely completion of various projects, timely receipt of supplies including completion of works & services for operation and maintenance of operating plants and quality standards in all respects.

3.0 **METHODOLOGY**

- i) **Preparation of Performance Rating Data Sheet**
Performance rating data Sheet for each and every Vendor/ Supplier/Contractor/Consultant for all orders/Contracts with a value of Rs. 50 Lakhs and above is recommended to be drawn up. Further, Performance rating data Sheet for orders/contracts of Vendor/Supplier/Contractor/ Consultant who are on watch list/holiday list/ banning list shall be prepared irrespective of order/ contract value. These data sheets are to be separately prepared for orders/ contracts related to Projects and O&M. Format, Parameters, Process, responsibility for preparation of Performance Rating Data Sheet are separately mentioned.
- ii) **Measurement of Performance**
Based on the parameters defined in Data Sheet, Performance of concerned Vendor/ Supplier/Contractor/ Consultant would be computed and graded accordingly. The measurement of the performance of the Party would be its ability to achieve the minimum scoring of 60% points in the given parameters.
- iii) **Initiation of Measures:**
Depending upon the Grading of Performance, corrective measures would be initiated by taking up the matter with concerned Vendor/ Supplier/Contractor/ Consultant. Response of Vendor/ Supplier/Contractor/ Consultant would be considered before deciding further course of action.

- iv) Implementation of Corrective Measures:
Based on the response of Vendor/ Supplier/Contractor/ Consultant, concerned Engineer-in-Charge for the Projects and/or OIC in case of O&M would recommend for continuation or discontinuation of such party from the business of TFL.
- v) Orders/contracts placed on Proprietary/OEM basis for O&M will be evaluated and, if required, corrective action will be taken for improvement in future.

4.0 **EXCLUSIONS:**

The following would be excluded from the scope of evaluation of performance of Vendors/ Suppliers/Contractors/ Consultants :

- i) Orders/Contracts below the value of Rs. 50 Lakhs if Vendor/ Supplier/Contractor/ Consultant is not on watch list/ holiday list/ banning list.
- ii) Orders for Misc./Administrative items/ Non stock Non valued items (PO with material code ending with 9).

However, concerned Engineer-in-Charge /OICs will continue to monitor such cases so as to minimize the impact on Projects/O&M plants due to non performance of Vendors/ Suppliers/Contractors/ Consultants in all such cases.

5.0 **PROCESS OF EVALUATION OF PERFORMANCE OF VENDORS/ SUPPLIERS/ CONTRACTORS/ CONSULTANTS**

5.1 FOR PROJECTS

- i) Evaluation of performance of Vendors/ Suppliers/Contractors/ Consultants in case of PROJECTS shall be done immediately with commissioning of any Project.
- ii) On commissioning of any Project, EIC (Engineer-in-charge)/ Project-in-charge shall prepare a Performance Rating Data Sheet (Format at Annexure-1) for all Orders and Contracts.
- iii) Depending upon the Performance Rating, following action shall be initiated by Engineer-in-charge/Project-in-charge:

Sl.No.	Performance Rating	Action
1	POOR	Seek explanation for Poor performance
2	FAIR	Seek explanation for Fair performance
3	GOOD	Letter to the concerned for improving performance in future
4	VERY GOOD	No further action

- iv) Reply from concerned Vendor/ Supplier/Contractor/ Consultant shall be examined. In case of satisfactory reply, Performance Rating data Sheet to be closed with a letter to the concerned for improving performance in future.
- v) When no reply is received or reasons indicated are unsatisfactory, the following actions need to be taken:

- A) Where performance rating is "POOR" (as per Performance Rating carried out after execution of Order/ Contract and where no reply/ unsatisfactory reply is received from party against the letter seeking the explanation from Vendor/Supplier/Contractor/ Consultant along with sharing the performance rating)

Recommend such defaulting Vendor / Supplier / Contractor / Consultant for the following action:

1. Poor Performance on account of Quality (if marks obtained against Quality parameter is less than 20):
 - (a) **First Instance: Holiday (Red Card) for one Years**
 - (b) **Subsequent instance (s) in other ongoing order (s)/ contract (s) or new order (s) /contact (s) on such Vendor/ Supplier/ Contractor/ Consultant: Holiday (Red Card) for two Years**
2. Poor Performance on account of other than Quality (if marks obtained against Quality parameter is more than 20):
 - (a) **First such instance: Advisory notice (Yellow Card)** shall be issued and Vendor/Supplier/Contractor/ Consultant shall be put on watch list for a period of Two (2) Years.
 - (b) **Second such instance in other ongoing order (s)/ contract (s) or new order (s) /contact (s) on such Vendor/ Supplier/ Contractor/ Consultant: Putting on Holiday (Red Card) for a period of One Year**
 - (c) **Subsequent instances (more than two) in other ongoing order (s)/ contract (s) or new order (s) /contact (s) on such Vendor/ Supplier/ Contractor/ Consultant: Putting on Holiday (Red Card) for a period of Two Years.**

- B) Where Poor/Non-Performance leading to termination of contract or Offloading of contract due to poor performance attributable to Vendor/Supplier/ Contractor/Consultant (under clause no. 34.2.3 of GCC)

- (a) **First instance: Advisory notice (Yellow Card)** shall be issued and Vendor/Supplier/Contractor /Consultant shall be put on watch list for a period of Two (2) Years.
Further such vendor will not be allowed to participate in the re-tender of the same supply/work/services of that location which has terminated / offloaded. Moreover, it will be ensured that all other action as per provision of contract including forfeiture of Contract Performance Security (CPS) etc. are undertaken.
However, such vendor will be allowed to participate in all other tenders and to execute other ongoing order/ contract (s) or new contract/ order (s).

The Yellow card will be automatically revoked after a period of two years unless the same is converted into Red Card due to subsequent instances of poor/ non-performance in other ongoing order (s)/ contract (s) or new order (s) /contact (s) on such Vendor/ Supplier/ Contractor/ Consultant.

- (b) **Second instances** in other ongoing order (s)/ contract (s) or new order (s) /contact (s) on such Vendor/ Supplier/ Contractor/ Consultant: **Holiday (Red Card)** for period of One Year and they shall also to be considered for Suspension.
- (c) **Subsequent instances (more than two)** in other ongoing order (s)/ contract (s) or new order (s) /contact (s) on such Vendor/ Supplier/ Contractor/ Consultant: **Holiday (Red Card) for period of Two Years and they shall also to be considered for Suspension.**

(C) Where Performance rating is “FAIR”:

Issuance of warning to such defaulting Vendor/ Supplier/Contractor/ Consultant to improve their performance.

5.2 FOR CONSULTANCY JOBS

Monitoring and Evaluation of consultancy jobs will be carried out in the same way as described in para 5.1 for Projects.

5.3 FOR OPERATION & MAINTENANCE

- i) Evaluation of performance of Vendors/ Suppliers/Contractors/ Consultants in case of Operation and Maintenance shall be done immediately after execution of order/ contract.
- ii) After execution of orders a Performance Rating Data Sheet (Format at Annexure-2) shall be prepared for Orders by Site C&P and for Contracts/Services by respective Engineer-In-Charge.
- iii) Depending upon Performance Rating, following action shall be initiated by EIC:

Sl. No.	Performance Rating	Action
1	POOR	Seek explanation for Poor performance
2.	FAIR	Seek explanation for Fair performance
3	GOOD	Letter to the concerned for improving performance in future.
4	VERY GOOD	No further action

- iv) Reply from concerned Vendor/ Supplier/Contractor/ Consultant shall be examined. In case of satisfactory reply, Performance Rating data Sheet to be closed with a letter to the concerned for improving performance in future.
- v) When no reply is received or reasons indicated are unsatisfactory, the following actions need to be taken:

- A) Where performance rating is "POOR" (as per Performance Rating carried out after execution of Order/ Contract and where no reply/ unsatisfactory reply is received from party against the letter seeking the explanation from Vendor/Supplier/Contractor/ Consultant along with sharing the performance rating)

Recommend such defaulting Vendor / Supplier / Contractor / Consultant for the following action:

1. Poor Performance on account of Quality (if marks obtained against Quality parameter is less than 20):
 - (a) **First Instance: Holiday (Red Card) for one Year**
 - (b) **Subsequent instance (s) in other ongoing order (s)/ contract (s) or new order (s) /contact (s) on such Vendor/ Supplier/ Contractor/ Consultant: Holiday (Red Card) for Two Years**
 2. Poor Performance on account of other than Quality (if marks obtained against Quality parameter is more than 20):
 - (a) **First such instance: Advisory notice (Yellow Card)** shall be issued and Vendor/Supplier/Contractor/ Consultant shall be put on watch list for a period of Two (2) Years.
 - (b) **Second such instance in other ongoing order (s)/ contract (s) or new order (s) /contact (s) on such Vendor/ Supplier/ Contractor/ Consultant: Putting on Holiday (Red Card) for a period of One Year**
 - (c) **Subsequent instances (more than two) in other ongoing order (s)/ contract (s) or new order (s) /contact (s) on such Vendor/ Supplier/ Contractor/ Consultant: Putting on Holiday (Red Card) for a period of Two Years.**
- B) Where Poor/Non-Performance leading to termination of contract or Offloading of contract due to poor performance attributable to Vendor/Supplier/ Contractor/Consultant (under clause no. 34.2.3 of GCC)
- (a) **First instance: Advisory notice (Yellow Card)** shall be issued and Vendor/Supplier/Contractor /Consultant shall be put on watch list for a period of two (2) Years.

Further such vendor will not be allowed to participate in the re-tender of the same supply/work/services of that location which has terminated / offloaded. Moreover, it will be ensured that all other action as per provision of contract including forfeiture of Contract Performance Security (CPS) etc. are undertaken. However, such vendor will be allowed to participate in all other tenders and to execute other ongoing order/ contract (s) or new contract/ order (s).

The Yellow card will be automatically revoked after a period of two years unless the same is converted into Red Card due to subsequence instances of poor/ non-performance in other ongoing order (s)/ contract (s) or new order (s) /contact (s) on such Vendor/ Supplier/ Contractor/ Consultant.

- (b) **Second instances** in other ongoing order (s)/ contract (s) or new order (s) /contact (s) on such Vendor/ Supplier/ Contractor/ Consultant: **Holiday (Red Card)** for period of One Year and they shall also to be considered for Suspension.
 - (c) **Subsequent instances (more than two)** in other ongoing order (s)/ contract (s) or new order (s) /contact (s) on such Vendor/ Supplier/ Contractor/ Consultant: **Holiday (Red Card) for period of Two Years and they shall also to be considered for Suspension.**
- (C) Where Performance rating is "FAIR"
 Issuance of warning to such defaulting Vendors/Contractors/Consultants to improve their performance.

6.0 **REVIEW & RESTORATION OF PARITES PUT ON HOLIDAY**

- 6.1 An order for Holiday passed for a certain specified period shall deemed to have been automatically revoked on the expiry of that specified period and it will not be necessary to issue a specific formal order of revocation.

Further, in case Vendor/ Supplier/Contractor/ Consultant is put on holiday due to quality, and new order is placed on bidder after restoration of Vendor/ Supplier/Contractor/ Consultant, such order will be properly monitored during execution stage by the concerned site.

7.0 **EFFECT OF HOLIDAY**

- 7.1 If a Vendor/ Supplier/Contractor/ Consultant is put on Holiday, such Vendor/ Supplier/Contractor/ Consultant shall not be considered in ongoing tenders/future tenders.
- 7.2 However, if such Vendor/ Supplier/Contractor/ Consultant is already executing any other order/ contract and their performance is satisfactory in terms of the relevant contract, should be allowed to continue till its completion without any further increase in scope except those incidental to original scope mentioned in the contract. In such a case CPBG will not be forfeited and payment will be made as per provisions of concerned contract. However, this would be without prejudice to other terms and conditions of the contract.
- 7.3. Effect on other ongoing tendering:
- 7.3.1 after issue of the enquiry /bid/tender but before opening of Technical bid, the bid submitted by the party shall be ignored.
- 7.3.2 after opening of price, BG/EMD made by the party shall be returned; the offer of the party shall be ignored & will not be further evaluated. In case such agency is lowest (L-1), next lowest bidder shall be considered as L-1.
- 7.3.3 after opening of price, BG/EMD made by the party shall be returned; the offer of the party shall be ignored & will not be further evaluated. If errant party emerges as the lowest (L1), then such tender shall also be cancelled and re-invited.
- 8.0 While putting the Vendor/ Supplier/Contractor/ Consultant on holiday as per the procedure, the holding company, subsidiary, joint venture, sister concerns, group division of the errant Vendor/ Supplier/Contractor/ Consultant shall not be considered for putting on holiday list. Any bidder, put on holiday, will not be allowed to bid through consortium route also in new tender during the period of holiday.

9.0 If an unsuccessful bidder makes any vexatious, frivolous or malicious complaint against the tender process with the intention of delaying or defeating any procurement or causing loss to TFL or any other bidder, such bidder will be put on holiday for a period of six months, if such complaint is proved to be vexatious, frivolous or malicious, after following the due procedure.

10. APPEAL AGAINST THE DECISION OF THE COMPETENT AUTHORITY:

- (a) The party may file an appeal against the order of the Competent Authority for putting the party on Holiday list. The appeal shall be filed to Appellate Authority. Such an appeal shall be preferred within one month from the of receipt of Holiday order.
- (b) Appellate Authority would consider the appeal and pass appropriate order which shall be communicated to the party as well as the Competent Authority.
- (c) Appeal process may be completed within 45 days of filing of appeal with the Appellate Authority.
- (d) "Appellate Authority" shall mean Committee of Directors consisting of Director (Finance) and Director (BD) for works centers under Director (Projects). For all other cases committee of Directors shall consist of Director (Finance) & Director (Projects).

11. ERRANT BIDDER

In case after price bid opening the lowest evaluated bidder (L1) is not awarded the job for any mistake committed by him in bidding or withdrawal of bid or modification of bid or varying any term in regard thereof leading to re-tendering, TFL shall forfeit EMD if paid by the bidder and such bidders shall be debarred from participation in retendering of the same job(s)/item(s).

Further, such bidder will be put on Watch List (Yellow Card) for a period of two years after following the due procedure. However, during the period in watch list such vendor will be allowed to participate in all other tenders and to execute other ongoing order/ contract (s) or new contract/ order (s).

In case of subsequent instances of default in other tender(s) during aforesaid watch list period, the action shall be initiated as per provision of sl. no. 2 of para A of Clause no. 5.1 (v) and 5.3 (v).

The Yellow card will be automatically revoked after specified period unless the same is converted into Red Card

12. In case CBIC (Central Board of Indirect Taxes and Customs)/ any tax authority / any equivalent government agency brings to the notice of TFL that the Supplier has not remitted the amount towards GST (CGST & SGST/UTGST or IGST) collected from TFL to the government exchequer, then, that Supplier shall be put under Holiday list of TFL for period of six months after following the due procedure. This action will be in addition to the right of recovery of financial implication arising on TFL.

**TALCHER FERTILIZERS LIMITED
PERFORMANCE RATING DATA SHEET
(FOR PROJECTS/ CONSULTANCY JOBS)**

- i) Project/Work Centre :
 ii) Order/ Contract No. & date :
 iii) Brief description of Items :
 Works/Assignment
 iv) Order/Contract value (Rs.) :
 v) Name of Vendor/Supplier/ :
 Contractor/ Consultant
 vi) Contracted delivery/ :
 Completion Schedule
 vii) Actual delivery/ :
 Completion date

Performance Parameter	Delivery/ Completion Performance	Quality Performance	Reliability Performance#	Total
Maximum Marks	40	40	20	100
Marks Allotted				

Note:

Remarks (if any)

PERFORMANCE RATING (**)

Note :

(#) Vendor/Supplier/Contractor/Consultant who seek repeated financial assistance or deviation beyond contract payment term or seeking direct payment to the sub-vendor/sub-contractor due to financial constraints, then '0' marks should be allotted against Reliability Performance.

(*) Allocation of marks should be as per enclosed instructions

(**) Performance rating shall be classified as under :

Sl. No.	Range (Marks)	Rating	Signature of Authorised Signatory:
1	60 & below	POOR	Name: Designation:
2	61-75	FAIR	
3	76-90	GOOD	
4	More than 90	VERY GOOD	

Instructions for allocation of marks

1. Marks are to be allocated as under :

1.1	DELIVERY/ COMPLETION PERFORMANCE	40 Marks
	<div style="width: 45%;">Delivery Period/ Completion Schedule</div> <div style="width: 45%;">Delay in Weeks</div>	Marks

a) Upto 3 months	Before CDD	40
	Delay upto 4 weeks	35
	" 8 weeks	30
	" 10 weeks	25
	" 12 weeks	20
	" 16 weeks	15
	More than 16 weeks	0
b) Above 3 months	Before CDD	40
	Delay upto 4 weeks	35
	" 8 weeks	30
	" 10 weeks	25
	" 16 weeks	20
	" 20 weeks	15
	" 24 weeks	10
	More than 24 weeks	0

1.2 QUALITY PERFORMANCE 40 Marks

For Normal Cases : No Defects/ No Deviation/ No failure:		40 marks
i) Rejection/Defects	Marks to be allocated on prorata basis for acceptable quantity as compared to total quantity for normal cases	10 marks
ii) When quality failure endanger system integration and safety of the system	Failure of severe nature - Moderate nature - low severe nature	0 marks 5 marks 10-25 marks
iii) Number of deviations	1. No deviation 2. No. of deviations \leq 2 3. No. of deviations $>$ 2	5 marks 2 marks 0 marks

1.3 RELIABILITY PERFORMANCE 20 Marks

A.	FOR WORKS/CONTRACTS	
i)	Submission of order acceptance, agreement, PBG, Drawings and other documents within time	4 marks
ii)	Mobilization of resources as per Contract and in time	4 marks
iii)	Liquidation of Check-list points	4 marks
iv)	Compliance to statutory and HS&E requirements or Reliability of Estimates/Design/Drawing etc. in case of Consultancy jobs	4 marks

v)	Timely submission of estimates and other documents for Extra, Substituted & AHR items	4 marks
B.	FOR SUPPLIES	
i)	Submission of order acceptance, PBG, Drawings and other documents within time	5 marks
ii)	Attending complaints and requests for after sales service/ warranty repairs and/ or query/ advice (upto the evaluation period).	5 marks
iii)	Response to various correspondence and conformance to standards like ISO	5 marks
iv)	Submission of all required documents including Test Certificates at the time of supply	5 marks

**TALCHER FERTILIZERS LIMITED
PERFORMANCE RATING DATA SHEET
(FOR O&M)**

- i) Location :
- ii) Order/ Contract No. & date :
- iii) Brief description of Items :
Works/Assignment
- iv) Order/Contract value (Rs.) :
- v) Name of Vendor/Supplier/
Contractor/ Consultant :
- vi) Contracted delivery/
Completion Schedule :
- vii) Actual delivery/
Completion date :

Performance Parameter	Delivery Performance	Quality Performance	Reliability Performance#	Total
Maximum Marks	40	40	20	100
Marks Allocated (*)				

Remarks (if any)

PERFORMANCE RATING ()**

Note :

(#) Vendor/Supplier/Contractor/Consultant who seek repeated financial assistance or deviation beyond contract payment term or seeking direct payment to the sub-vendor/sub-contractor due to financial constraints, then '0' marks should be allotted against Reliability Performance

(*) Allocation of marks should be as per enclosed instructions

(**) Performance rating shall be classified as under :

Sl. No.	Range (Marks)	Rating
1	60 & below	POOR
2	61-75	FAIR
3	76-90	GOOD
4	More than 90	VERY GOOD

Signature of
Authorised Signatory:

Name:

Designation:

Instructions for allocation of marks (For O&M)

1. Marks are to be allocated as under :

1.1 DELIVERY/ COMPLETION PERFORMANCE 40 Marks

Marks	Delivery Period/ Completion Schedule	Delay in Weeks	Marks
-------	---	----------------	-------

	a) Upto 3 months	Before CDD	40
		Delay upto 4 weeks	35
		" 8 weeks	30

" 10 weeks	25
" 12 weeks	20
" 16 weeks	15
More than 16 weeks	0

b) Above 3 months	Before CDD	40
	Delay upto 4 weeks	35
	" 8 weeks	30
	" 10 weeks	25
	" 16 weeks	20
	" 20 weeks	15
	" 24 weeks	10
	More than 24 weeks	0

1.2 QUALITY PERFORMANCE

40 Marks

For Normal Cases : No Defects/ No Deviation/ No failure:		40 marks
i) Rejection/Defects	Marks to be allocated on prorata basis for acceptable quantity as compared to total quantity for normal cases	10 marks
ii) When quality failure endanger system integration and safety of the system	Failure of severe nature - Moderate nature - low severe nature	0 marks 5 marks 10-25 marks
iii) Number of deviations	1. No deviation 2. No. of deviations ≤ 2 3. No. of deviations > 2	5 marks 2 marks 0 marks

1.3 RELIABILITY PERFORMANCE

20 Marks

A.	FOR WORKS/CONTRACTS	
i)	Submission of order acceptance, agreement, PBG, Drawings and other documents within time	4 marks
ii)	Mobilization of resources as per Contract and in time	4 marks
iii)	Liquidation of Check-list points	4 marks
iv)	Compliance to statutory and HS&E requirements or Reliability of Estimates/Design/Drawing etc. in case of Consultancy jobs	4 marks
v)	Timely submission of estimates and other documents for Extra, Substituted & AHR items	4 marks

B.	FOR SUPPLIES	
i)	Submission of order acceptance, PBG, Drawings and other documents within time	5 marks
ii)	Attending complaints and requests for after sales service/ warranty repairs and/ or query/ advice (upto the evaluation period).	5 marks
iii)	Response to various correspondence and conformance to standards like ISO	5 marks
iv)	Submission of all required documents including Test Certificates at the time of supply	5 marks

INSTRUCTIONS FOR SUBMISSION OF BID ONLINE THROUGH CPP PORTAL

1. The bidders are required to submit soft copies of their bids electronically on the CPP Portal, using valid Digital Signature Certificates. The instructions given below are meant to assist the bidders in registering on the CPP Portal, prepare their bids in accordance with the requirements and submitting their bids online on the CPP Portal.
More information useful for submitting online bids on the CPP Portal may be obtained at: <https://eprocure.gov.in/eprocure/app>.

2. **REGISTRATION**

- i. Bidders are required to enroll on the e-Procurement module of the Central Public Procurement Portal (URL: <https://eprocure.gov.in/eprocure/app>) by clicking on the link "Online bidder Enrollment" on the CPP Portal which is free of charge.
- ii. As part of the enrollment process, the bidders will be required to choose a unique username and assign a password for their accounts.
- iii. Bidders are advised to register their valid email address and mobile numbers as part of the registration process. These would be used for any communication from the CPP Portal.
- iv. Bidders are advised to make ensure the accessibility & availability of java software in their system (PC) either download & install the latest version of java software or click on the below link to install the java in their system prior to proceed further.
<https://www.oracle.com/technetwork/java/javase/downloads/index.html>
- v. Upon enrollment, the bidders will be required to register their valid Digital Signature Certificate (Class III Certificates with signing key usage) issued by any Certifying Authority recognized by CCA India (e.g. Sify / nCode / eMudhra etc.), with their profile.
- vi. Only one valid DSC should be registered by a bidder. Please note that the bidders are responsible to ensure that they do not lend their DSC's to others which may lead to misuse.
- vii. Bidder then logs in to the site through the secured log-in by entering their user ID / password and the password of the DSC / e-Token.

3. **SEARCHING FOR TENDER DOCUMENTS**

- i. There are various search options built in the CPP Portal, to facilitate bidders to search active tenders by several parameters. These parameters could include Tender ID, Organization Name, Location, Date, Value, etc. There is also an option of advanced search for tenders, wherein the bidders may combine a number of search parameters such as Organization Name, Form of Contract, Location, Date, Other keywords etc. to search for a tender published on the CPP Portal.

- ii. Once the bidders have selected the tenders they are interested in, they may download the required documents / tender schedules. These tenders can be moved to the respective 'My Tenders' folder. This would enable the CPP Portal to intimate the bidders through SMS / email in case there is any corrigendum issued to the tender document.
- iii. The bidder should make a note of the unique Tender ID assigned to each tender, in case they want to obtain any clarification / help from the Helpdesk.

4. PREPARATION OF BIDS

- i. Bidder should take into account any corrigendum published on the tender document before submitting their bids.
- ii. Please go through the tender advertisement and the tender document carefully to understand the documents required to be submitted as part of the bid. Please note the number of covers in which the bid documents have to be submitted, the number of documents - including the names and content of each of the document that need to be submitted. Any deviations from these may lead to rejection of the bid.
- iii. Bidder, in advance, should get ready the bid documents to be submitted as indicated in the tender document / schedule and generally, they can be in PDF / XLS / RAR / DWF/JPG formats. Bid documents may be scanned with 100 dpi with black and white option which helps in reducing size of the scanned document.
- iv. To avoid the time and effort required in uploading the same set of standard documents which are required to be submitted as a part of every bid, a provision of uploading such standard documents (e.g. PAN card copy, annual reports, auditor certificates etc.) has been provided to the bidders. Bidders can use "My Space" or "Other Important Documents" area available to them to upload such documents. These documents may be directly submitted from the "My Space" area while submitting a bid, and need not be uploaded again and again. This will lead to a reduction in the time required for bid submission process.

Note: My Documents space is only a repository given to the Bidders to ease the uploading process. If Bidder has uploaded his Documents in My Documents space, this does not automatically ensure these Documents being part of Technical Bid.

5. SUBMISSION OF BIDS

- i. Bidder should log into the site well in advance for bid submission so that they can upload the bid in time i.e. on or before the bid submission time. Bidder will be responsible for any delay due to other issues.
- ii. The bidder has to digitally sign and upload the required bid documents one by one as indicated in the tender document.
- iii. Bidder should submit EMD / Declaration for Bid security (as applicable) strictly as per format Form F-2B provided in the NIT. Otherwise the uploaded bid will be rejected.

- iv. Bidders are requested to note that they should necessarily submit their financial bids in the format provided and no other format is acceptable. If the price bid has been given as a standard SOR format with the tender document, then the same is to be downloaded and to be filled by all the bidders. Bidders are required to download the SOR file, open it and complete the white coloured (unprotected) cells with their respective financial quotes and other details (such as name of the bidder). No other cells should be changed. Once the details have been completed, the bidder should save it and submit it online, without changing the filename. If the SOR file is found to be modified by the bidder, the bid will be rejected.
- v. The server time (which is displayed on the bidders' dashboard) will be considered as the standard time for referencing the deadlines for submission of the bids by the bidders, opening of bids etc. The bidders should follow this time during bid submission.
- vi. All the documents being submitted by the bidders would be encrypted using PKI encryption techniques to ensure the secrecy of the data. The data entered cannot be viewed by unauthorized persons until the time of bid opening. The confidentiality of the bids is maintained using the secured Socket Layer 128 bit encryption technology. Data storage encryption of sensitive fields is done. Any bid document that is uploaded to the server is subjected to symmetric encryption using a system generated symmetric key. Further this key is subjected to asymmetric encryption using buyers/bid opener's public keys. Overall, the uploaded tender documents become readable only after the tender opening by the authorized bid openers.
- vii. The uploaded tender documents become readable only after the tender opening by the authorized bid openers.
- viii. Upon the successful and timely submission of bids (i.e. after Clicking "Freeze Bid Submission" in the portal), the portal will give a successful bid submission message & a bid summary will be displayed with the bid no. and the date & time of submission of the bid with all other relevant details.
- ix. The bid summary has to be printed and kept as an acknowledgement of the submission of the bid. This acknowledgement may be used as an entry pass for any bid opening meetings.

6. ASSISTANCE TO BIDDERS

- i. Any queries relating to the tender document and the terms and conditions contained therein should be addressed to the Tender Inviting Authority for a tender or the relevant contact person indicated in the tender.
- ii. Any queries relating to the process of online bid submission or queries relating to CPP Portal in general may be directed to the 24x7 CPP Portal Helpdesk.

-----X-----

BIDDING DATA SHEET (BDS)

ITB TO BE READ IN CONJUNCTION WITH THE FOLLOWING:

A. GENERAL					
ITB clause	Description				
1.1	The Employer/Owner is: The Employer/Owner is: Talcher Fertilizers Limited				
1.2	The name of the Works/Services to be performed is: “Emergency Diesel Generator Package at Talcher Fertilizers Limited, Odisha (India)” .				
3	BIDS FROM CONSORTIUM/ JOINT VENTURE: <table border="1" data-bbox="479 688 1026 835"> <tr> <td>APPLICABLE</td> <td>✓</td> </tr> <tr> <td>NOT APPLICABLE</td> <td>✗</td> </tr> </table>	APPLICABLE	✓	NOT APPLICABLE	✗
APPLICABLE	✓				
NOT APPLICABLE	✗				
B. BIDDING DOCUMENT					
ITB clause	Description				
8.1	For clarification purposes only, the communication address is: M/s Projects & Development India Limited, P.D.I.L Bhawan, A-14, Sector-1, Noida, (PIN 201301) Dist. GautamBudh Nagar (UP). (India) Kind Attention: Mr. Anjali Thakur, Dy. General Manager (M.M) Fax no. : +91-120-2529801 Tel no. : +91-120-2544063 E-mail : anjali@pdilin.com alam@pdilin.com				
C. PREPARATION OF BIDS					
ITB clause	Description				
11.1.1 (r)	Additional documents to be submitted by the Bidder with its Part-I (Techno-commercial/ Unpriced bid) :As per SCC/Scope of Work.				
13	Details of Buyer: <table border="1" data-bbox="441 1646 1299 1932"> <tr> <td>Services to be rendered at</td> <td>M/s Talcher Fertilizers Ltd. (TFL), Administrative Building, Talcher, Post: Vikrampur, Dist: Angul, Pincode-759106, Odisha</td> </tr> <tr> <td>PAN No.</td> <td>AAFCT8667A</td> </tr> </table>	Services to be rendered at	M/s Talcher Fertilizers Ltd. (TFL), Administrative Building, Talcher, Post: Vikrampur, Dist: Angul, Pincode-759106, Odisha	PAN No.	AAFCT8667A
Services to be rendered at	M/s Talcher Fertilizers Ltd. (TFL), Administrative Building, Talcher, Post: Vikrampur, Dist: Angul, Pincode-759106, Odisha				
PAN No.	AAFCT8667A				

	GST no.	21AAFCT8667A1ZH	
14	The currency of the Bid shall be INR		
15	The bid validity period shall be 90 days from final 'Bid Due Date'.		
16.1, 16.10 and 38.6	<p>In case 'Earnest Money / Bid Security' or "Contract Performance Security" is in the form of 'Demand Draft' or 'Banker's Cheque', the same should be favour of "Talcher Fertilizers Limited", payable at New Delhi.</p> <p>In case of submission through online banking transaction i.e. IMPS / NEFT / RTGS / SWIFT, etc, the details of TFL's Bank account are as under:</p> <p>Account Holder's Name: Talcher Fertilizers Limited Bank Name: State Bank of India Branch: CAG II, New Delhi Account number: 41256023769 Type (Current/Saving): Current Branch Code-17313</p> <p>Bidder to mention reference no. "EMD/....." in narration while remitting the EMD / Bid Security amount and to mention reference no. "CPS/....." in narration while remitting the CPS amount in TFL's Bank Account</p>		
D. SUBMISSION AND OPENING OF BIDS			
ITB clause	Description		
18	In addition to the original of the Bid, the number of copies required is one. Not applicable in case of e-tendering.		
4.0 of IFB	<p>The submission of physical document as per clause no. 4.0 of IFB shall at following address:</p> <p>M/s Projects & Development India Limited, P.D.I.L Bhawan, A-14, Sector-1, Noida, (PIN 201301) Dist. Gautam Budh Nagar (UP). (India)</p> <p>Kind Attention: Mr. P.R.Sahu, Addl. General Manager (M.M) Fax no. : +91-120-2529801 Tel no. : +91-120-2544063</p>		
E. EVALUATION, AND COMPARISON OF BIDS			
ITB clause	Description		
32	Evaluation Methodology is mentioned in Section-II of tender.		

33	Compensation for Extended Stay: APPLICABLE	<input checked="" type="checkbox"/>
	NOT APPLICABLE	<input checked="" type="checkbox"/>
F. AWARD OF CONTRACT		
ITB clause	Description	
37	State of India of which stamp paper is required for Contract Agreement: Uttar Pradesh/ State where Bidder's Registered or Corporate Office is located.	
38	Contract Performance Security/ Security Deposit	
	APPLICABLE	<input checked="" type="checkbox"/>
	NOT APPLICABLE	<input checked="" type="checkbox"/>
	<u>The value/ amount of Contract Performance Security/ Security Deposit:</u> CPS/SD @ 10% of Total Order / Contract value (excluding GST)	
41	Provision of AHR Item :	
	APPLICABLE	<input checked="" type="checkbox"/>
	NOT APPLICABLE	<input checked="" type="checkbox"/>
44.1	Quarterly Closure of Contract:	
	APPLICABLE	<input checked="" type="checkbox"/>
	NOT APPLICABLE	<input checked="" type="checkbox"/>
49	Applicability of BEC relaxation relating to Startups:	
	APPLICABLE	<input checked="" type="checkbox"/>
	NOT APPLICABLE	<input checked="" type="checkbox"/>

**PUBLIC PROCUREMENT
(PREFERENCE TO MAKE IN INDIA), ORDER 2017**

No. P-45021/2/2017-PP (BE-II)
Government of India
Ministry of Commerce and Industry
Department for Promotion of Industry and Internal Trade
(Public Procurement Section)

Udyog Bhawan, New Delhi
Dated: 16th September, 2020

To

All Central Ministries/Departments/CPSUs/All concerned

ORDER

Subject: Public Procurement (Preference to Make in India), Order 2017– Revision; regarding.

Department for Promotion of Industry and Internal Trade, in partial modification [Paras 2, 3, 5, 10 & 13] of Order No.P-45021/2/2017-B.E.-II dated 15.6.2017 as amended by Order No.P-45021/2/2017-B.E.-II dated 28.05.2018, Order No.P-45021/2/2017-B.E.-II dated 29.05.2019 and Order No.P-45021/2/2017-B.E.-II dated 04.06.2020, hereby issues the revised 'Public Procurement (Preference to Make in India), Order 2017' dated 16.09.2020 effective with immediate effect.

Whereas it is the policy of the Government of India to encourage 'Make in India' and promote manufacturing and production of goods and services in India with a view to enhancing income and employment, and

Whereas procurement by the Government is substantial in amount and can contribute towards this policy objective, and

Whereas local content can be increased through partnerships, cooperation with local companies, establishing production units in India or Joint Ventures (JV) with Indian suppliers, increasing the participation of local employees in services and training them,

Now therefore the following Order is issued:

1. This Order is issued pursuant to Rule 153 (iii) of the General Financial Rules 2017.
2. **Definitions:** For the purposes of this Order:

'Local content' means the amount of value added in India which shall, unless otherwise prescribed by the Nodal Ministry, be the total value of the item procured (excluding net domestic indirect taxes) minus the value of imported content in the item (including all customs duties) as a proportion of the total value, in percent.

'Class-I local supplier' means a supplier or service provider, whose goods, services or works offered for procurement, meets the minimum local content as prescribed for 'Class-I local supplier' under this Order.

..... Contd. p/2

'Class-II local supplier' means a supplier or service provider, whose goods, services or works offered for procurement, meets the minimum local content as prescribed for 'Class-II local supplier' but less than that prescribed for 'Class-I local supplier' under this Order.

'Non - Local supplier' means a supplier or service provider, whose goods, services or works offered for procurement, has local content less than that prescribed for 'Class-II local supplier' under this Order.

'L1' means the lowest tender or lowest bid or the lowest quotation received in a tender, bidding process or other procurement solicitation as adjudged in the evaluation process as per the tender or other procurement solicitation.

'Margin of purchase preference' means the maximum extent to which the price quoted by a "Class-I local supplier" may be above the L1 for the purpose of purchase preference.

'Nodal Ministry' means the Ministry or Department identified pursuant to this order in respect of a particular item of goods or services or works.

'Procuring entity' means a Ministry or department or attached or subordinate office of, or autonomous body controlled by, the Government of India and includes Government companies as defined in the Companies Act.

'Works' means all works as per Rule 130 of GFR- 2017, and will also include 'turnkey works'.

3. Eligibility of 'Class-I local supplier'/ 'Class-II local supplier'/ 'Non-local suppliers' for different types of procurement

(a) In procurement of all goods, services or works in respect of which the Nodal Ministry / Department has communicated that there is sufficient local capacity and local competition, only 'Class-I local supplier', as defined under the Order, shall be eligible to bid irrespective of purchase value.

(b) Only 'Class-I local supplier' and 'Class-II local supplier', as defined under the Order, shall be eligible to bid in procurements undertaken by procuring entities, except when Global tender enquiry has been issued. In global tender enquiries, 'Non-local suppliers' shall also be eligible to bid along with 'Class-I local suppliers' and 'Class-II local suppliers'. In procurement of all goods, services or works, not covered by sub-para 3(a) above, and with estimated value of purchases less than Rs. 200 Crore, in accordance with Rule 161(iv) of GFR, 2017, Global tender enquiry shall not be issued except with the approval of competent authority as designated by Department of Expenditure.

(c) For the purpose of this Order, works includes Engineering, Procurement and Construction (EPC) contracts and services include System Integrator (SI) contracts.

.....Contd. p/3

3A. Purchase Preference

(a) Subject to the provisions of this Order and to any specific instructions issued by the Nodal Ministry or in pursuance of this Order, purchase preference shall be given to 'Class-I local supplier' in procurements undertaken by procuring entities in the manner specified here under.

(b) In the procurements of goods or works, which are covered by para 3(b) above and which are divisible in nature, the 'Class-I local supplier' shall get purchase preference over 'Class-II local supplier' as well as 'Non-local supplier', as per following procedure:

- i. Among all qualified bids, the lowest bid will be termed as L1. If L1 is 'Class-I local supplier', the contract for full quantity will be awarded to L1.
- ii. If L1 bid is not a 'Class-I local supplier', 50% of the order quantity shall be awarded to L1. Thereafter, the lowest bidder among the 'Class-I local supplier' will be invited to match the L1 price for the remaining 50% quantity subject to the Class-I local supplier's quoted price falling within the margin of purchase preference, and contract for that quantity shall be awarded to such 'Class-I local supplier' subject to matching the L1 price. In case such lowest eligible 'Class-I local supplier' fails to match the L1 price or accepts less than the offered quantity, the next higher 'Class-I local supplier' within the margin of purchase preference shall be invited to match the L1 price for remaining quantity and so on, and contract shall be awarded accordingly. In case some quantity is still left uncovered on Class-I local suppliers, then such balance quantity may also be ordered on the L1 bidder.

(c) In the procurements of goods or works, which are covered by para 3(b) above and which are not divisible in nature, and in procurement of services where the bid is evaluated on price alone, the 'Class-I local supplier' shall get purchase preference over 'Class-II local supplier' as well as 'Non-local supplier', as per following procedure:

- i. Among all qualified bids, the lowest bid will be termed as L1. If L1 is 'Class-I local supplier', the contract will be awarded to L1.
- ii. If L1 is not 'Class-I local supplier', the lowest bidder among the 'Class-I local supplier', will be invited to match the L1 price subject to Class-I local supplier's quoted price falling within the margin of purchase preference, and the contract shall be awarded to such 'Class-I local supplier' subject to matching the L1 price.
- iii. In case such lowest eligible 'Class-I local supplier' fails to match the L1 price, the 'Class-I local supplier' with the next higher bid within the margin of purchase preference shall be invited to match the L1 price and so on and contract shall be awarded accordingly. In case none of the 'Class-I local supplier' within the margin of purchase preference matches the L1 price, the contract may be awarded to the L1 bidder.

.....Contd. p/4

(d) "Class-II local supplier" will not get purchase preference in any procurement, undertaken by procuring entities.

3B. Applicability in tenders where contract is to be awarded to multiple bidders - In tenders where contract is awarded to multiple bidders subject to matching of L1 rates or otherwise, the 'Class-I local supplier' shall get purchase preference over 'Class-II local supplier' as well as 'Non-local supplier', as per following procedure:

a) In case there is sufficient local capacity and competition for the item to be procured, as notified by the nodal Ministry, only Class I local suppliers shall be eligible to bid. As such, the multiple suppliers, who would be awarded the contract, should be all and only 'Class I Local suppliers'.

b) In other cases, 'Class II local suppliers' and 'Non local suppliers' may also participate in the bidding process along with 'Class I Local suppliers' as per provisions of this Order.

c) If 'Class I Local suppliers' qualify for award of contract for at least 50% of the tendered quantity in any tender, the contract may be awarded to all the qualified bidders as per award criteria stipulated in the bid documents. However, in case 'Class I Local suppliers' do not qualify for award of contract for at least 50% of the tendered quantity, purchase preference should be given to the 'Class I local supplier' over 'Class II local suppliers' / 'Non local suppliers' provided that their quoted rate falls within 20% margin of purchase preference of the highest quoted bidder considered for award of contract so as to ensure that the 'Class I Local suppliers' taken in totality are considered for award of contract for at least 50% of the tendered quantity.

d) First purchase preference has to be given to the lowest quoting 'Class-I local supplier', whose quoted rates fall within 20% margin of purchase preference, subject to its meeting the prescribed criteria for award of contract as also the constraint of maximum quantity that can be sourced from any single supplier. If the lowest quoting 'Class-I local supplier', does not qualify for purchase preference because of aforesaid constraints or does not accept the offered quantity, an opportunity may be given to next higher 'Class-I local supplier', falling within 20% margin of purchase preference, and so on.

e) To avoid any ambiguity during bid evaluation process, the procuring entities may stipulate its own tender specific criteria for award of contract amongst different bidders including the procedure for purchase preference to 'Class-I local supplier' within the broad policy guidelines stipulated in sub-paras above.

4. Exemption of small purchases: Notwithstanding anything contained in paragraph 3, procurements where the estimated value to be procured is less than Rs. 5 lakhs shall be exempt from this Order. However, it shall be ensured by procuring entities that procurement is not split for the purpose of avoiding the provisions of this Order.

5. Minimum local content: The 'local content' requirement to categorize a supplier as 'Class-I local supplier' is minimum 50%. For 'Class-II local supplier', the 'local content' requirement is minimum 20%. Nodal Ministry/ Department may prescribe only a higher

.....Contd. p/5

percentage of minimum local content requirement to categorize a supplier as 'Class-I local supplier'/ 'Class-II local supplier'. For the items, for which Nodal Ministry/ Department has not prescribed higher minimum local content notification under the Order, it shall be 50% and 20% for 'Class-I local supplier'/ 'Class-II local supplier' respectively.

6. **Margin of Purchase Preference:** The margin of purchase preference shall be 20%.
7. **Requirement for specification in advance:** The minimum local content, the margin of purchase preference and the procedure for preference to Make in India shall be specified in the notice inviting tenders or other form of procurement solicitation and shall not be varied during a particular procurement transaction.
8. **Government E-marketplace:** In respect of procurement through the Government E-marketplace (GeM) shall, as far as possible, specifically mark the items which meet the minimum local content while registering the item for display, and shall, wherever feasible, make provision for automated comparison with purchase preference and without purchase preference and for obtaining consent of the local supplier in those cases where purchase preference is to be exercised.
9. **Verification of local content:**
 - a. The 'Class-I local supplier'/ 'Class-II local supplier' at the time of tender, bidding or solicitation shall be required to indicate percentage of local content and provide self-certification that the item offered meets the local content requirement for 'Class-I local supplier'/ 'Class-II local supplier', as the case may be. They shall also give details of the location(s) at which the local value addition is made.
 - b. In cases of procurement for a value in excess of Rs. 10 crores, the 'Class-I local supplier'/ 'Class-II local supplier' shall be required to provide a certificate from the statutory auditor or cost auditor of the company (in the case of companies) or from a practicing cost accountant or practicing chartered accountant (in respect of suppliers other than companies) giving the percentage of local content.
 - c. Decisions on complaints relating to implementation of this Order shall be taken by the competent authority which is empowered to look into procurement-related complaints relating to the procuring entity.
 - d. Nodal Ministries may constitute committees with internal and external experts for independent verification of self-declarations and auditor's/ accountant's certificates on random basis and in the case of complaints.
 - e. Nodal Ministries and procuring entities may prescribe fees for such complaints.
 - f. False declarations will be in breach of the Code of Integrity under Rule 175(1)(i)(h) of the General Financial Rules for which a bidder or its successors can be debarred for up to two years as per Rule 151 (iii) of the General Financial Rules along with such other actions as may be permissible under law.

- g. A supplier who has been debarred by any procuring entity for violation of this Order shall not be eligible for preference under this Order for procurement by any other procuring entity for the duration of the debarment. The debarment for such other procuring entities shall take effect prospectively from the date on which it comes to the notice of other procurement entities, in the manner prescribed under paragraph 9h below.
- h. The Department of Expenditure shall issue suitable instructions for the effective and smooth operation of this process, so that:
 - i. The fact and duration of debarment for violation of this Order by any procuring entity are promptly brought to the notice of the Member-Convenor of the Standing Committee and the Department of Expenditure through the concerned Ministry /Department or in some other manner;
 - ii. on a periodical basis such cases are consolidated and a centralized list or decentralized lists of such suppliers with the period of debarment is maintained and displayed on website(s);
 - iii. in respect of procuring entities other than the one which has carried out the debarment, the debarment takes effect prospectively from the date of uploading on the website(s) in the such a manner that ongoing procurements are not disrupted.

10. Specifications in Tenders and other procurement solicitations:

- a. Every procuring entity shall ensure that the eligibility conditions in respect of previous experience fixed in any tender or solicitation do not require proof of supply in other countries or proof of exports.
- b. Procuring entities shall endeavour to see that eligibility conditions, including on matters like turnover, production capability and financial strength do not result in unreasonable exclusion of 'Class-I local supplier'/ 'Class-II local supplier' who would otherwise be eligible, beyond what is essential for ensuring quality or creditworthiness of the supplier.
- c. Procuring entities shall, within 2 months of the issue of this Order review all existing eligibility norms and conditions with reference to sub-paragraphs 'a' and 'b' above.

d. Reciprocity Clause

- i. When a Nodal Ministry/Department identifies that Indian suppliers of an item are not allowed to participate and/ or compete in procurement by any foreign government, due to restrictive tender conditions which have direct or indirect effect of barring Indian companies such as registration in the procuring country, execution of projects of specific value in the procuring country etc., it shall provide such details to all its procuring entities including CMDs/CEOs of PSEs/PSUs, State Governments and other procurement agencies under their administrative control and GeM for appropriate reciprocal action.

.....Contd. p/7

- ii. Entities of countries which have been identified by the nodal Ministry/Department as not allowing Indian companies to participate in their Government procurement for any item related to that nodal Ministry shall not be allowed to participate in Government procurement in India for all items related to that nodal Ministry/ Department, except for the list of items published by the Ministry/ Department permitting their participation.
 - iii. The stipulation in (ii) above shall be part of all tenders invited by the Central Government procuring entities stated in (i) above. All purchases on GeM shall also necessarily have the above provisions for items identified by nodal Ministry/ Department.
 - iv. State Governments should be encouraged to incorporate similar provisions in their respective tenders.
 - v. The term 'entity' of a country shall have the same meaning as under the FDI Policy of DPIIT as amended from time to time.
- e. Specifying foreign certifications/ unreasonable technical specifications/ brands/ models in the bid document is restrictive and discriminatory practice against local suppliers. If foreign certification is required to be stipulated because of non-availability of Indian Standards and/or for any other reason, the same shall be done only after written approval of Secretary of the Department concerned or any other Authority having been designated such power by the Secretary of the Department concerned.
- f. "All administrative Ministries/Departments whose procurement exceeds Rs. 1000 Crore per annum shall notify/ update their procurement projections every year, including those of the PSEs/PSUs, for the next 5 years on their respective website."

10A. Action for non-compliance of the Provisions of the Order: In case restrictive or discriminatory conditions against domestic suppliers are included in bid documents, an inquiry shall be conducted by the Administrative Department undertaking the procurement (including procurement by any entity under its administrative control) to fix responsibility for the same. Thereafter, appropriate action, administrative or otherwise, shall be taken against erring officials of procurement entities under relevant provisions. Intimation on all such actions shall be sent to the Standing Committee.

11. Assessment of supply base by Nodal Ministries: The Nodal Ministry shall keep in view the domestic manufacturing / supply base and assess the available capacity and the extent of local competition while identifying items and prescribing the higher minimum local content or the manner of its calculation, with a view to avoiding cost increase from the operation of this Order.

12. Increase in minimum local content: The Nodal Ministry may annually review the local content requirements with a view to increasing them, subject to availability of sufficient local competition with adequate quality.

13. Manufacture under license/ technology collaboration agreements with phased indigenization: While notifying the minimum local content, Nodal Ministries may make special provisions for exempting suppliers from meeting the stipulated local content if the product is being manufactured in India under a license from a foreign manufacturer who holds intellectual property rights and where there is a technology collaboration agreement / transfer of technology agreement for indigenous manufacture of a product developed abroad with clear phasing of increase in local content.

13A. In procurement of all goods, services or works in respect of which there is substantial quantity of public procurement and for which the nodal ministry has not notified that there is sufficient local capacity and local competition, the concerned nodal ministry shall notify an upper threshold value of procurement beyond which foreign companies shall enter into a joint venture with an Indian company to participate in the tender. Procuring entities, while procuring such items beyond the notified threshold value, shall prescribe in their respective tenders that foreign companies may enter into a joint venture with an Indian company to participate in the tender. The procuring Ministries/Departments shall also make special provisions for exempting such joint ventures from meeting the stipulated minimum local content requirement, which shall be increased in a phased manner.

14. Powers to grant exemption and to reduce minimum local content: The administrative Department undertaking the procurement (including procurement by any entity under its administrative control), with the approval of their Minister-in-charge, may by written order, for reasons to be recorded in writing,

- a. reduce the minimum local content below the prescribed level; or
- b. reduce the margin of purchase preference below 20%; or
- c. exempt any particular item or supplying entities from the operation of this Order or any part of the Order.

A copy of every such order shall be provided to the Standing Committee and concerned Nodal Ministry / Department. The Nodal Ministry / Department concerned will continue to have the power to vary its notification on Minimum Local Content.

15. Directions to Government companies: In respect of Government companies and other procuring entities not governed by the General Financial Rules, the administrative Ministry or Department shall issue policy directions requiring compliance with this Order.

16. Standing Committee: A standing committee is hereby constituted with the following membership:

Secretary, Department for Promotion of Industry and Internal Trade—Chairman
Secretary, Commerce—Member
Secretary, Ministry of Electronics and Information Technology—Member
Joint Secretary (Public Procurement), Department of Expenditure—Member
Joint Secretary (DPIIT)—Member-Convenor

.....Contd. p/9

The Secretary of the Department concerned with a particular item shall be a member in respect of issues relating to such item. The Chairman of the Committee may co-opt technical experts as relevant to any issue or class of issues under its consideration.

17. **Functions of the Standing Committee:** The Standing Committee shall meet as often as necessary, but not less than once in six months. The Committee
- a. shall oversee the implementation of this order and issues arising therefrom, and make recommendations to Nodal Ministries and procuring entities.
 - b. shall annually assess and periodically monitor compliance with this Order
 - c. shall identify Nodal Ministries and the allocation of items among them for issue of notifications on minimum local content
 - d. may require furnishing of details or returns regarding compliance with this Order and related matters
 - e. may, during the annual review or otherwise, assess issues, if any, where it is felt that the manner of implementation of the order results in any restrictive practices, cartelization or increase in public expenditure and suggest remedial measures
 - f. may examine cases covered by paragraph 13 above relating to manufacture under license/ technology transfer agreements with a view to satisfying itself that adequate mechanisms exist for enforcement of such agreements and for attaining the underlying objective of progressive indigenization
 - g. may consider any other issue relating to this Order which may arise.
18. **Removal of difficulties:** Ministries /Departments and the Boards of Directors of Government companies may issue such clarifications and instructions as may be necessary for the removal of any difficulties arising in the implementation of this Order.
19. **Ministries having existing policies:** Where any Ministry or Department has its own policy for preference to local content approved by the Cabinet after 1st January 2015, such policies will prevail over the provisions of this Order. All other existing orders on preference to local content shall be reviewed by the Nodal Ministries and revised as needed to conform to this Order, within two months of the issue of this Order.
20. **Transitional provision:** This Order shall not apply to any tender or procurement for which notice inviting tender or other form of procurement solicitation has been issued before the issue of this Order.

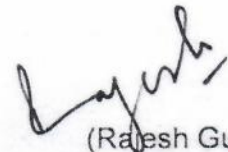

(Rajesh Gupta)
Director

Tel: 23063211

rajesh.gupta66@gov.in

FORM – I of ANNEXURE V

CERTIFICATE FROM STATUTORY AUDITOR OR COST AUDITOR OF THE COMPANY (IN THE CASE OF COMPANIES) OR FROM A PRACTICING COST ACCOUNTANT OR PRACTICING CHARTERED ACCOUNTANT (IN RESPECT OF SUPPLIERS OTHER THAN COMPANIES) TOWARDS MINIMUM LOCAL CONTENT

(FOR SUPPLY OF GOODS/ SERVICES / WORKS / EPC / LSTK)

To,
M/s Talcher Fertilizers Limited

SUB:

TENDER NO:

Dear Sir

- A. We..... the Statutory Auditor / Cost Auditor / Practicing Cost Accountant / Practicing Chartered Accountant) have verified relevant records of M/s **(Name of the bidder)** and certify that M/s **(Name of the bidder)** meets the following:

Sl. No.	Description	Confirmation
a	Bidder meets the mandatory minimum Local content requirement of 20% for participating in the Bidding process under Public Procurement (Preference to Make in India) Policy. (In case bidder does not meet the minimum Local content requirement of 20%, such bidders are not allowed to participate in the Bidding process)	Confirmed.
b	The bidder meets mandatory minimum Local content requirement of 50% for claiming purchase preference under Public Procurement (Preference to Make in India) Policy	Confirmed / Not Confirmed

- B. The **details of the location** at which the local value addition is made as follows:

Sl. No.	Item Description	Details of the Location(s) where the local value addition is made
1.		
2.		
3.		

Name of Audit Firm / Chartered Accountant: [Signature of Authorized Signatory]

Name:

Date:

Designation:

Seal:

Membership No.:

UDIN:

FORM-II of ANNEXURE-V

Salient Points of Public Procurement (Preference to Make in India) Policy

Sr. No.	Description	Parameter / Document
1	Minimum Local Content (LC) for Availing Preference under this Policy	50%
2	Margin of Purchase Preference	20%
3	Local Content (LC) % declared by bidder (Documents to be submitted as per Sr. No. 4 below)	[Tick (✓) whichever is applicable] a) LC Equal to or more than 50% <input type="checkbox"/> b) LC More than 20% but less than 50% <input type="checkbox"/>
4	Documents to be submitted by bidder under this Policy	Certificate from the statutory auditor or cost auditor of the company (in case of companies) or from a practicing cost accountant or practicing chartered accountant as per <u>Form-I</u> to be submitted by bidder.
5	Whether tender is divisible or not divisible	Not Divisible; Clause No. 3A (c) of revised Policy dated 16.09.2020 shall be applicable

PREAMBLE TO SCHEDULE OF RATES

1. The "Schedule of Rates (SOR)" will be in Excel format (password protected) and will be uploaded during tender creation. This will be downloaded by the bidder and bidder will quote price on this Excel file for entire scope of work as per NIT. Thereafter, the bidder will upload the same Excel file during bid submission.
2. The SOR format is provided in a spread sheet file (BoQ_xxxx.xls). The rates offered should be entered in the allotted space only and uploaded after filling the relevant columns. The SOR template must not be modified / replaced by the bidder; else the bid submitted shall be rejected.
3. Bidder shall quote all Prices in INR only.
4. Schedule of Rates containing Total Lumpsum Turnkey Price/ TOTALCONTRACT PRICE & GST
5. It is mandatory to quote prices in SOR. It will be the responsibility of the contractor to quote for all Materials/ Equipments /Services/Civil & Structural Works etc. as per scope of work and terms and conditions defined in NIT.
6. CONTRACTOR shall be responsible for payment of all taxes, duties and levies as applicable on performance of WORK under CONTRACT and shall be included in the quoted TOTAL LSTK PRICE /TOTAL CONTRACT PRICE.
7. A copy of SOR, with prices/figures completely blanked out but with the word "QUOTED" in all columns is to be uploaded along with the unpriced bid, as a confirmation of price/data quoted against each head.

**CLAUSE REGARDING PROVISION FOR PROCUREMENT FROM A BIDDER WHICH SHARES
A LAND BORDER WITH INDIA**

1. OM no. 7/10/2021-PPD(1) dated 23.02.2023, Department of Expenditure, Ministry of Finance, Govt. of India refers. The same are available at website <https://doe.gov.in/procurement-policy-divisions>.
2. Any bidder from a country which shares a land border with India will be eligible to bid in this tender only if the bidder is registered with the Competent Authority. For details of competent authority refer to Annexure I of Order (Public Procurement no. 4) dated 23.02.2023.

Further, any bidder (including bidder from India) having specified Transfer of Technology (ToT) arrangement with an entity from a country which shares a land border with India, shall also require to be registered with the same competent authority.

Further the above will not apply to bidders from those countries (even if sharing a land border with India) to which the Government of India has extended lines of credit or in which the Government of India is engaged in development projects. Updated lists of countries to which lines of credit have been extended or in which development projects are undertaken are given in the website of the Ministry of External Affairs, Govt. of India

3. **"Bidder"** (including the term 'tenderer', 'consultant' 'vendor' or 'service provider' in certain contexts) **for purpose of this provision** means any person or firm or company, including any member of a consortium or joint venture (that is an association of several persons, or firms or companies), every artificial juridical person not falling in any of the descriptions of bidders stated hereinbefore, including any agency, branch or office controlled by such person, participating in a procurement process.
4. **"Bidder from a country which shares a land border with India"** for the purpose of this:
 - a. An entity incorporated, established or registered in such a country; or
 - b. A subsidiary of an entity incorporated, established or registered in such a country; or
 - c. An entity substantially controlled through entities incorporated, established or registered in such a country; or
 - d. An entity whose beneficial owner is situated in such a country; or
 - e. An Indian (or other) agent of such an entity; or
 - f. A natural person who is a citizen of such a country; or
 - g. A consortium or joint venture where any member of the consortium or joint venture falls under any of the above
5. **"Beneficial owner"** for the purpose of above (4) will be as under:
 - i. In case of a company or Limited Liability Partnership, the beneficial owner is the natural person(s), who, whether acting alone or together, or through one or more

juridical person(s), has a controlling ownership interest or who exercises control through other means.

Explanation—

- a) "Controlling ownership interest" means ownership of, or entitlement to, more than twenty-five per cent of shares or capital or profits of the company;
 - b) "Control" shall include the right to appoint the majority of the directors or to control the management or policy decisions, including by virtue of their shareholding or management rights or shareholders agreements or voting agreements;
- ii) In case of a partnership firm, the beneficial owner is the natural person(s) who, whether acting alone or together, or through one or more juridical person, has ownership of entitlement to more than fifteen percent of capital or profits of the partnership;
 - iii) In case of an unincorporated association or body of individuals, the beneficial owner is the natural person(s), who, whether acting alone or together, or through one or more juridical person, has ownership of or entitlement to more than fifteen percent of the property or capital or profits of such association or body of individuals;
 - iv) Where no natural person is identified under (i) or (ii) or (iii) above, the beneficial owner is the relevant natural person who holds the position of senior managing official;
 - v) In case of a trust, the identification of beneficial owner(s) shall include identification of the author of the trust, the trustee, the beneficiaries with fifteen percent or more interest in the trust and any other natural person exercising ultimate effective control over the trust through a chain of control or ownership.
6. **"Agent"** for the purpose of this Order is a person employed to do any act for another, or to represent another in dealings with third persons

Note :

- (i) A person who procures and supplies finished goods from an entity from a country which shares a land border with India will, regardless of the nature of his legal or commercial relationship with the producer of the goods, be deemed to be an Agent for the purpose of this Order.
 - (ii) However, a bidder who only procures raw material, components etc. from an entity from a country which shares a land border with India and then manufactures or converts them into other goods will not be treated as an Agent.]
7. **"Transfer of Technology"** means dissemination and transfer of all forms of commercially usable knowledge such as transfer of know-how, skills, technical expertise, designs, processes and procedures, trade secrets, which enables the acquirer of such technology to perform activities using the transferred technology independently. (Matters of interpretation of this term shall be referred to the Registration Committee constituted by the Department

for Promotion of Industry and Internal Trade, and the interpretation of the Committee shall be final.)

8. **"Specified Transfer of Technology"** means a transfer of technology in the sectors and/ or technologies, specified at Schedule-I, II & 3 of this order.

9. **SUBMISSION OF CERTIFICATE IN BIDS:**

Bidder shall submit a certificate in this regard as Form-I.

For cases falling under the category of Transfer of Technology, Bidder shall submit a certificate in this regard as Form-II.

If such certificate given by a bidder whose bid is accepted is found to be false, this would be a ground for immediate rejection of the bid/termination and further action as per "Procedure for Action in case of Corrupt/Fraudulent/ Collusive / Coercive Practices" of tender document.

10. The registration, wherever applicable, should be valid at the time of submission of bids and at the time of acceptance of bids. In respect of supply otherwise than by tender, registration should be valid at the time of placement of order. If the bidder was validly registered at the time of acceptance / placement of order, registration shall not be a relevant consideration during contract execution.

11. **PROVISION TO BE IN WORKS CONTRACTS, INCLUDING TURNKEY CONTRACTS:**

The successful bidder shall not be allowed to sub-contract works to any contractor from a country which shares a land border with India unless such contractor is registered with the Competent Authority. The definition of "contractor from a country which shares a land border with India" shall be as in Para 4 herein above. A Certificate to this regard is to be submitted by bidder is placed at Form-I.

[Note: Procurement of raw material, components, etc. does not constitute sub-contracting]

UNDERTAKING ON LETTERHEAD

To,

M/s Talcher Fertilizers Limited

SUB:

TENDER NO:

Dear Sir

We have read the clause regarding Provisions for Procurement from a Bidder of a country which shares a land border with India and on sub-contracting to contractors from such countries; we certify that, bidder M/s _____ (***Name of Bidder***) is:

- (i) not from such a country []
- (ii) if from such a country, has been registered with the Competent Authority. []

(Evidence of valid registration by the Competent Authority shall be attached)

(Bidder is to tick appropriate option (✓ or X) above).

We further certify that bidder **M/s** _____ (***Name of Bidder***) will not sub-contract any work to a contractor from such countries unless such contractor is registered with the Competent Authority.

We hereby certify that bidder **M/s** _____ (***Name of Bidder***) fulfills all requirements in this regard and is eligible to be considered.

Place: [Signature of Authorized Signatory of Bidder]

Date: Name:

Designation:

Seal:

UNDERTAKING ON LETTERHEAD

(Applicable in case of Transfer of Technology cases only)

To,

M/s TALCHER FERTILIZERS LIMITED

SUB:

TENDER NO:

Dear Sir

We have read the clause regarding Provisions for Procurement from a Bidder having Transfer of Technology (ToT) arrangement which shares a land border with India, we certify that, bidder M/s _____ (***Name of Bidder***) is :

- (i) Does not have ToT with such a country []
- (ii) If having ToT from such a country, has been registered []
with the Competent Authority.

(Evidence of valid registration by the Competent Authority shall be attached)

(Bidder is to tick appropriate option (✓) above).

We hereby certify that bidder M/s _____ (***Name of Bidder***) fulfills all requirements in this regard and is eligible to be considered against the tender.

Place: [Signature of Authorized Signatory of Bidder]

Date: Name:

Designation:

Seal:

Schedule I

List of Category-I Sensitive sectors:

Sr. No.	Sector
(i)	Atomic Energy
(ii)	Brocasting/ Print and Digital Media
(iii)	Defense
(iv)	Space
(v)	Telecommunications

Schedule II

List of Category-II Sensitive sectors:

Sr.No.	Sector
(i)	Power and Energy (including exploration/ generation/transmission/ distribution/ pipeline)
(ii)	Banking and Finance including Insurance
(iii)	Civil Aviation
(iv)	Construction of ports and dams & river valley projects
(v)	Electronics and Microelectronics
(vi)	Meteorology and Ocean Observation
(vii)	Mining and extraction (including deep sea projects)
(viii)	Railways
(ix)	Pharmaceuticals & Medical Devices
(x)	Agriculture
(xi)	Health
(xii)	Urban Transportation

Schedule III

List of Sensitive Technologies:

Sr.No.	Sensitive Technologies
(i)	Additive Manufacturing (e.g. 3D Printing)
(ii)	Any equipment having electronic programmable components or autonomous systems (e.g. SCADA systems)
(iii)	Any technology used for uploading and streaming of data including broadcasting, satellite communication etc.
(iv)	Chemical Technologies
(v)	Biotechnologies including Genetic Engineering and Biological Technologies
(vi)	Information and Communication Technologies
(vii)	Software

FORMS & FORMATS

LIST OF FORMS & FORMATS

Form No.	Description
F-1	BIDDER'S GENERAL INFORMATION
F-2A	PROFORMA OF "BANK GUARANTEE"FOR "EARNEST MONEY / BID SECURITY"
F-2B	FORMAT OF " DECLARATION FOR BID SECURITY "
F-3	LETTER OF AUTHORITY
F-4	PROFORMA OF "BANK GUARANTEE" FOR "CONTRACT PERFORMANCE SECURITY / SECURITY DEPOSIT"
F-4(a)	MATTER TO BE MENTIONED IN COVERING LETTER TO BE SUBMITTED BY VENDOR ALONG WITH BANK GUARANTEE (BG)
F-5	AGREED TERMS & CONDITIONS
F-6	ACKNOWLEDGEMENT CUM CONSENT LETTER
F-7	BIDDER'S EXPERIENCE
F-8(A)	CHECKLIST
F-8(B)	CHECKLIST FOR BID EVALUATION CRITERIA (BEC) QUALIFYING DOCUMENTS
F-9	FORMAT FOR CERTIFICATE FROM BANKIF BIDDER'S WORKING CAPITAL IS INADEQUATE
F-10	FORMAT FOR CHARTERED ACCOUNTANT CERTIFICATE FOR FINANCIAL CAPABILITY OF THE BIDDER
F-11	DELETED
F-12	BIDDER'S QUERIES FOR PRE BID MEETING
F-13	E-BANKING FORMAT
F-14	INTEGRITY PACT
F-15	INDEMNITY BOND
F-16	FREQUENTLY ASKED QUESTIONS (FAQS)
F-17	PROFORMA OF BANK GUARANTEE FOR MOBILISATIONS ADVANCE PAYMENT
F-17 (a)	MATTER TO BE MENTIONED IN COVERING LETTER TO BE SUBMITTED BY VENDOR ALONG WITH BANK GUARANTEE (BG)
F-18	PROFORMA OF BANK GUARANTEE FOR PAYMENTS TOWARDS PLACEMENT OF ALL PURCHASE ORDERS OF MAJOR TAGGED ITEMS
F-19	FORMAT OF LETTER OF NO DEVIATIONS
F-20	FORMAT FOR POWER OF ATTORNEY
F-21	UNDERTAKING REGARDING SUBMISSION OF ELECTRONIC INVOICE(E-INVOICE AS PER GST LAW)
F-22	UNDERTAKING REGARDING SUBMISSION CONTRACT PERFORMANCE SECURITY (CPS) / SECURITY DEPOSIT (SD) WITHIN STIPULATED TIME LINE

F-23	PROFORMA FOR CONTRACT AGREEMENT
F-24	NO CLAIM CERTIFICATE

F-1

BIDDER'S GENERAL INFORMATION

To,
M/s Talcher Fertilizers Limited

TENDER NO:

1	Bidder Name:	M/s.....
2	Status of Firm	Proprietorship Firm/Partnership firm/ Public Limited/ Pvt. Limited/ Govt. Dept. / PSU/ Others If Others Specify:_____
		[Enclose relevant certificates / partnership deed/certificate of Registration, as applicable]
3	Name of Proprietor/ Partners/ Directors of the firm/company	1. 2. 3.
4	Name of Power of Attorney holders of bidder	
5	Number of Years in Operation	
6	Address of Registered Office	_____ City: _____ District: _____ State: _____ PIN/ZIP : _____
7	Bidder's address where order/contract is to be placed	_____ City: _____ District: _____ State: _____ PIN/ZIP : _____
8	Office responsible for executing the contract with GST no.(In case supply of works are from multiple locations, addresses and GST no. of all such locations are to be provided)	City: District: State: PIN/ZIP: GST No.:
9	Telephone Number & Contact Information of address where order is to be placed	_____ (Country Code) (Area Code) (Telephone Number) FAX No. : e-mail ID:
10	E-mail Address	

11	ISO Certification, if any {If yes, please furnish details}	
12	PAN No	[Enclose copy of relevant document]
13	GST No. (refer sl. no. 8 above)	[Enclose copy of relevant document]
14	EPF Registration No.	[Enclose copy of relevant document]
15	ESI code No.	[Enclose copy of relevant document]
16	Whether Micro or Small Enterprise	Yes / No (If Yes, Bidder to submit requisite documents as specified in ITB: Clause No. 40)
	Whether MSE is owned by SC/ST Entrepreneur(s)	Yes / No (If Yes, Bidder to submit requisite documents as specified in ITB: Clause No. 40)
	Whether MSE is owned by Women	Yes / No (If Yes, Bidder to submit requisite documents as specified in ITB: Clause No. 40)
17	Whether Bidder is Startups or not	Yes / No (If Yes, Bidder to submit requisite documents as specified in ITB: Clause No. 49)
18	In case of Start-up confirm the following: (i) Date of its incorporation/ registration (ii) Whether turnover for any financial years since incorporation/ registration has exceeded Rs.100 Crores.	

Note: * TFL intent to place the contract directly on the address from where Works are to be supplied. In case, bidder wants contract at some other address or Works are to be supplied from multiple locations, bidder is required to provide in their bid, the address on which contract is to be placed.

Place:

[Signature of Authorized Signatory of Bidder]

Date:

Name:

Designation:

Seal:

FORMAT F-2A

PROFORMA OF "BANK GUARANTEE"
FOR "EARNEST MONEY / BID SECURITY"

(To be stamped in accordance with the Stamp Act)

To, Talcher Fertilizers Limited (TFL) _____	Bank Guarantee No.	
	Date of BG	
	BG Valid up to (Expiry date)	
	Claim period up to (indicate date of expiry of claim period which includes minimum three months from the expiry date)	
	Stamp Sl. No./e-Stamp Certificate No.	

Dear Sir(s),

In accordance with Letter Inviting Tender under your reference No _____ M/s. _____ having their Registered / Head Office at _____ (hereinafter called the Tenderer), wish to participate in the said tender for _____

As an irrevocable Bank Guarantee against Earnest Money for the amount of _____ is required to be submitted by the Tenderer as a condition precedent for participation in the said tender which amount is liable to be forfeited on the happening of any contingencies mentioned in the Tender Document.

We, the _____ Bank at _____ having our Head Office _____ (Local Address) guarantee and undertake to pay immediately on demand without any recourse to the tenderers by Talcher Fertilizers Limited, the amount _____ without any reservation, protest, demur and recourse. Any such demand made by TFL, shall be conclusive and binding on us irrespective of any dispute or difference raised by the Tenderer.

This guarantee shall be irrevocable and shall remain valid up to _____ [this date should be two (02) months beyond the validity of the bid]. If any further extension of this guarantee is required, the same shall be extended to such required period on receiving instructions from M/s. _____ whose behalf this guarantee is issued.

Notwithstanding anything contained herein:

- a) The Bank's liability under this Guarantee shall not exceed (currency in figures) (currency in words only)
- b) This Guarantee shall remain in force upto _____ (this expiry date of BG should be two months beyond the validity of bid) and any extension(s) thereof; and
- c) The Bank shall be released and discharged from all liability under this Guarantee unless a written claim or demand is issued to the Bank on or before the midnight of(indicate date of expiry of claim period which includes minimum three months from the expiry of this Bank Guarantee) and if extended, the date of expiry of the last extension of this Guarantee. If a claim has been received by us within the said date, all the rights of TFL under this Guarantee shall be valid and shall not cease until we have satisfied that claim.

In witness whereof the Bank, through its authorized officer, has set its hand and stamp on this _____ day of _____ 20__ at _____.

WITNESS:

(SIGNATURE)
(NAME)

(OFFICIAL ADDRESS)

(SIGNATURE)
(NAME)

Designation with Bank Stamp

Attorney as per
Power of Attorney No. _____

Date: _____

**INSTRUCTIONS FOR FURNISHING "BID SECURITY / EARNEST MONEY" BY "BANK
GUARANTEE"**

1. The Bank Guarantee by Bidders will be given on non-judicial stamp paper as per "Stamp Duty" applicable. The non-judicial stamp paper should be in the name of the issuing Bank.
2. The expiry date should be arrived at in accordance with "ITB: Clause-16.1".
3. The Bank Guarantee by bidders will be given from Bank as specified in "ITB Clause-16.2".
4. A letter from the issuing Bank of the requisite Bank Guarantee confirming that said Bank Guarantee / all future communication relating to the Bank Guarantee shall be forwarded to the Employer at its address as mentioned at "ITB".
5. Bidders must indicate the full postal address of the Bank along with the Bank's E-mail / Fax / Phone from where the Earnest Money Bond has been issued as per proforma provided below.
6. If a Bank Guarantee is issued by a commercial Bank, then a letter to Employer confirming its net worth is more than Rs. 1,000,000,000.00 [Rupees One Hundred Crores] or equivalent along with documentary evidence in the Bank Guarantee itself.

FORMAT F-2B

DECLARATION FOR BID SECURITY
(To be submitted on Letter head of Bidder)

To,

M/s TALCHER FERTILIZERS LIMITED

SUB:

TENDER NO:

Dear Sir,

After examining / reviewing provisions of above referred tender documents (including all corrigendum/ Addenda), we M/s _____ (Name of Bidder) have submitted our offer/ bid no. _____.

We, M/s _____ (Name of Bidder) hereby understand that, according to your conditions, we are submitting this Declaration for Bid Security.

We understand that we will be put on watch list/holiday/ banning list (as per policies of TALCHER FERTILIZERS LIMITED in this regard), if we are in breach of our obligation(s) as per following:

- (a) have withdrawn/modified/amended, impairs or derogates from the tender, my/our Bid during the period of bid validity specified in the form of Bid; or
- (b) having been notified of the acceptance of our Bid by the TALCHER FERTILIZERS LIMITED during the period of bid validity:
 - (i) fail or refuse to execute the Contract, if required, or
 - (ii) fail or refuse to furnish the Contract Performance Security, in accordance provisions of tender document.
 - (iii) fail or refuse to accept 'arithmetical corrections' as per provision of tender document.
- (c) having indulged in corrupt/fraudulent /collusive/coercive practice as per procedure.

Place:
Date:

[Signature of Authorized Signatory of Bidder]
Name:
Designation:

Seal

F-3

LETTER OF AUTHORITY

[Pro forma for Letter of Authority for Attending 'Pre-Bid Meetings' /'Un-priced Bid Opening' / 'Price Bid Opening']

Ref:

Date:

To,
M/s TALCHER FERTILIZERS LIMITED,

SUB:
TENDER NO:

Dear Sir,

I/We, _____ hereby authorize the following representative(s) for attending any 'Meetings [Pre-Bid Meeting]', 'Un-priced Bid Opening' and 'Price Bid Opening' against the above Tender Documents:

[1] Name & Designation _____ Signature _____
Phone/Cell:

E-mail: @

[2] Name & Designation _____ Signature _____
Phone/Cell:

E-mail: @

We confirm that we shall be bound by all commitments made by aforementioned authorised representative(s).

Place: [Signature of Authorized Signatory of Bidder]
Date: Name:
Designation:
Seal:

- (i) Note: This "Letter of Authority" should be on the "**letter head**" of the Bidder and should be signed by a person competent and having the 'Power of Attorney' to bind the Bidder. Not more than 'two [02] persons per Bidder' are permitted to attend 'Pre-Bid Meetings' /'Un-priced Bid Opening' / 'Price Bid Opening'..
- (ii) Bidder's authorized representative is required to carry a copy of this authority letter while attending the 'Pre-Bid Meetings' /'Un-priced Bid Opening' .

F-4

PROFORMA OF "BANK GUARANTEE" FOR "CONTRACT PERFORMANCE SECURITY / SECURITY DEPOSIT"
(ON NON-JUDICIAL STAMP PAPER OF APPROPRIATE VALUE)

To, M/s Talcher Fertilizers Limited, Noida	Bank Guarantee No.	
	Date of BG	
	BG Valid up to	
	Claim period up to (There should be three months gap between expiry date of BG & Claim period)	
	Stamp Sl. No./e-Stamp Certificate No.	

Dear Sir(s),

M/s. _____ having registered office at _____ (herein after called the "contractor" which expression shall wherever the context so require include its successors and assignees) have been placed/ awarded the job/work of _____ vide LOA /FOA No. _____ dated _____ for Talcher Fertilizers Limited having registered office at Plot 2/H, Kalpana Area, BJB Nagar, Khorda, Bhubaneswar-751014, Odisha (herein after called the "TFL" which expression shall wherever the context so require include its successors and assignees).

The Contract conditions provide that the CONTRACTOR shall pay a sum of Rs. _____ (Rupees _____) as full Contract Performance Guarantee in the form therein mentioned. The form of payment of Contract Performance Guarantee includes guarantee executed by Nationalized Bank/Scheduled Commercial Bank, undertaking full responsibility to indemnify Talcher Fertilizers Limited, in case of default.

The said M/s. _____ has approached us and at their request and in consideration of the premises we having our office at _____ have agreed to give such guarantee as hereinafter mentioned.

1. We _____ hereby undertake to give the irrevocable & unconditional guarantee to you that if default shall be made by M/s. _____ in performing any of the terms and conditions of the tender/order/contract or in payment of any money payable to Talcher Fertilizers Limited we shall on first demand pay without demur, contest, protest and/ or without any recourse to the contractor to TFL in such manner as TFL may direct the said amount of Rupees _____ only or such portion thereof not exceeding the said sum as you may require from time to time.

2. You will have the full liberty without reference to us and without affecting this guarantee, postpone for any time or from time to time the exercise of any of the powers and rights conferred on you under the order/contract with the said _____ M/s. _____ and to enforce or to forbear from endorsing any powers or rights or by reason of time being given to the said M/s. _____ and such postponement forbearance would not have the effect of releasing the bank from its obligation under this debt.
3. Your right to recover the said sum of Rs. _____ (Rupees _____) from us in manner aforesaid is absolute & unequivocal and will not be affected or suspended by reason of the fact that any dispute or disputes have been raised by the said M/s. _____ and/or that any dispute or disputes are pending before any officer, tribunal or court or arbitrator or any other authority/forum and any demand made by you in the bank shall be conclusive and binding. The bank shall not be released of its obligations under these presents by any exercise by you of its liberty with reference to matter aforesaid or any of their or by reason or any other act of omission or commission on your part or any other indulgence shown by you or by any other matter or changed what so ever which under law would, but for this provision, have the effect of releasing the bank.
4. The guarantee herein contained shall not be determined or affected by the liquidation or winding up dissolution or changes of constitution or insolvency of the said contractor but shall in all respects and for all purposes be binding and operative until payment of all money due to you in respect of such liabilities is paid.
5. The bank undertakes not to revoke this guarantee during its currency without your previous consent and further agrees that the guarantee shall continue to be enforceable until it is discharged by TFL in writing. However, if for any reason, the contractor is unable to complete the work within the period stipulated in the order/contract and in case of extension of the date of delivery/completion resulting extension of defect liability period/guarantee period of the contractor fails to perform the work fully, the bank hereby agrees to further extend this guarantee at the instance of the contractor till such time as may be determined by TFL. If any further extension of this guarantee is required, the same shall be extended to such required period on receiving instruction from M/s. _____ (contractor) on whose behalf this guarantee is issued.
6. Bank also agrees that TFL at its option shall be entitled to enforce this Guarantee against the bank (as principal debtor) in the first instant, without proceeding against the contractor and notwithstanding any security or other guarantee that TFL may have in relation to the /contractor's liabilities.
7. The amount under the Bank Guarantee is payable forthwith without any delay by Bank upon the written demand raised by TFL. Any dispute arising out of or in relation to the said Bank Guarantee shall be subject to the exclusive jurisdiction of courts at New Delhi.
8. Therefore, we hereby affirm that we are guarantors and responsible to you on behalf of the Contractor up to a total amount of _____ (amount of guarantees in words and figures) and we undertake to pay you, upon your first written demand declaring the Contractor to be in default under the order/contract and without caveat or argument, any sum or sums within the limits of (amounts of guarantee) as aforesaid, without your needing to prove or show grounds or reasons for your demand or the sum specified therein.

9. We have power to issue this guarantee in your favor under Memorandum and Articles of Association and the undersigned has full power to do under the Power of Attorney, dated _____ granted to him by the Bank.

10. Notwithstanding anything contained herein:

11.

- a) The Bank's liability under this Guarantee shall not exceed (currency in figures) _____ (currency in words only) _____
- b) This Guarantee shall remain in force upto _____ (this date should be expiry date of defect liability period of the Contract) and any extension(s) thereof; and
- c) The Bank shall be released and discharged from all liability under this Guarantee unless a written claim or demand is issued to the Bank on or before the midnight of _____ (indicate date of expiry of claim period which includes minimum three months from the expiry of this Bank Guarantee) and if extended, the date of expiry of the last extension of this Guarantee. If a claim has been received by us within the said date, all the rights of TFL under this Guarantee shall be valid and shall not cease until we have satisfied that claim.

Yours faithfully,

Bank by its Constituted Attorney

Signature of a person duly
Authorized to sign on behalf of the Bank

INSTRUCTIONS FOR FURNISHING
"CONTRACT PERFORMANCE SECURITY / SECURITY DEPOSIT" BY "BANK GUARANTEE"

1. The Bank Guarantee by successful Bidder(s) will be given on non-judicial stamp paper as per 'stamp duty' applicable. The non-judicial stamp paper should be in name of the issuing bank..
2. The Bank Guarantee by Bidders will be given from bank as specified in Cl no. 38.3 of ITB [Section-III] of Tender Document .
3. A letter from the issuing bank of the requisite Bank Guarantee confirming that said Bank Guarantee and all future communication relating to the Bank Guarantee shall be forwarded to Employer.
4. If a Bank Guarantee is issued by a commercial bank, then a letter to Employer and copy to Consultant (if applicable) confirming its net worth is more than Rs. 100,00,00,000.00 [Rupees One Hundred Crores] or its equivalent in foreign currency alongwith documentary evidence OR in the Bank Guarantee itself.
5. Contractor shall submit attached cover letter (Annexure) while submitting Contract Performance Security.

Form-4 (a)

**MATTER TO BE MENTIONED IN COVERING LETTER TO BE SUBMITTED BY VENDOR
ALONG WITH BANK GUARANTEE (BG)**

1. Bank Guarantee No.				
2. Vendor Name/ VENDOR CODE	NAME			
	VENDOR CODE			
BANK GUARANTEE AMOUNT				
PURCHASE ORDER/LOA				
1. Nature of Bank Guarantee [Please Tick (<input type="checkbox"/>) whichever is applicable]	Performance Security (CPS)	SECURITY DEPOSIT	ADVANCE	EMD
2. BG ISSUING Bank DETAILS:				
(A) E-MAIL ID				
(B) ADDRESS				
(C) Phone No. / Mobile No.				

F-5

AGREED TERMS & CONDITIONS

To,
M/s TALCHER FERTILIZERS LIMITED

SUB:
TENDER NO:

This Questionnaire duly filled in, signed & stamped must form part of Bidder's Bid and should be returned along with Un-priced Bid. Clauses confirmed hereunder need not be repeated in the Bid.

SI.	DESCRIPTION	BIDDER'S CONFIRMATION
1.	Bidder's name, Vendor Code of TFL (If any) and address	Bidder's Name: TFL's Vendor Code: Address:
2.	Bidder confirms the currency of quoted prices is in Indian Rupees	
3.	Bidder confirms quoted prices will remain firm and fixed till complete execution of the order (except where price escalation/variation is allowed in the Tender).	
4.	Bidder confirms that they have quoted GST (CGST & SGST/ UTGST or IGST) in Price Schedule / Schedule of Rates (SOR) of Price bid.	Confirmed
4.1	Whether in the instant tender services/works are covered in reverse charge rule of GST (CGST & SGST/UTGST or IGST) If yes, Bidder confirms that they have quoted rate of applicable GST (CGST & SGST/ UTGST or IGST) in Price Schedule / Schedule of Rates of Price Bid	
4.2	Indicate Harmonized System of Nomenclature (HSN)/Service Accounting Codes (SAC).	HSN/SAC Code (as applicable): <hr/>
4.3	Bidder hereby confirms that the quoted prices are in compliance with the Section 171 of CGST Act/ SGST Act as mentioned as clause no. 13.10 of ITB (Anti-profiteering clause).	
4.4	a. Whether bidder is liable to raise E-Invoice as per GST Act. b. If yes, bidder will raise E-Invoice and confirm compliance to provision of tender in this regard.	a. _____ b. _____
4.5	Whether bidder is liable to raise E-Invoice as per GST Act. If yes, bidder will raise E-Invoice and confirm compliance to provision of tender in this regard.	
5.	Bidder confirms acceptance of relevant Terms of Payment specified in the Bid Document.	
6.	Bidder confirms that Contract Performance Security will be furnished as per Bid Document within 30 days of FOA in case of successful bidder.	

SI.	DESCRIPTION	BIDDER'S CONFIRMATION				
7.	Bidder confirms that Contract Performance Security shall be from any Indian scheduled bank or a branch of an International bank situated in India and registered with Reserve bank of India as scheduled foreign bank. However, in case of bank guarantees from banks other than the Nationalised Indian banks, the bank must be a commercial bank having net worth in excess of Rs 100 crores and a declaration to this effect shall be made by such commercial bank either in the Bank Guarantee itself or separately on its letterhead.					
8.	Bidder confirms compliance to Completion Schedule as specified in Bid document and the same shall be reckoned from the date of Fax of Acceptance.					
9.	(i) Bidder confirms acceptance of Mutually Agreed Damages for delay in completion schedule specified in Bid document. (ii) In case of delay, the bills/invoices shall be submitted after reducing the price reduction due to delay (refer MAD Clause).					
10.	a) Bidder confirms acceptance of all terms and conditions of Bid Document (all sections). b) Bidder confirms that printed terms and conditions of bidder are not applicable.					
11.	Bidder confirms that their offer is valid for period specified in BDS from Final/Extended due date of opening of Techno-commercial Bids.					
12.	Bidder have furnished EMD/Bid Security details as under: a) EMD/ Bid Security No. & date b) Value c) Validity d) Bank Address/e-mail ID/Mobile no. [in case of BG] OR Bidder furnishes bid security declaration [applicable for MSEs, Start-Ups and CPSEs (to whom exemption is allowed as per extant guidelines in vogue)]					
13.	As per requirement of tender, bidder (having status as Pvt. Ltd. or Limited company) must upload bid duly digitally signed on e-portal through class-3B digital signature (DS). In case, class of DS or name of employee or name of employer is not visible in the digitally signed documents, the bid digitally signed as submitted by the person shall be binding on the bidder.					
14.	Bidder confirms that (i) none of Directors (in Board of Director) of bidder is a relative of any Director (in Board of Director) of TFL or (ii) the bidder is not a firm in which any Director (in Board of Director) of TFL or their relative is a partner.	<table border="1"> <tr> <td data-bbox="1105 1545 1312 1614">Confirmed</td> <td data-bbox="1312 1545 1458 1614"></td> </tr> <tr> <td data-bbox="1105 1614 1312 1684">Not confirmed</td> <td data-bbox="1312 1614 1458 1684"></td> </tr> </table>	Confirmed		Not confirmed	
Confirmed						
Not confirmed						
15.	All correspondence must be in ENGLISH language only					
16.	Bidder confirms the contents of this Tender Document have not been modified or altered by them. In case, it is found that the tender document has been modified / altered by the bidder, the bid submitted by them shall be liable for rejection.					

SI.	DESCRIPTION	BIDDER'S CONFIRMATION
17.	Bidder confirms that all Bank charges associated with Bidder's Bank regarding release of payment etc. shall be borne by Bidder.	
18.	<p><u>No Deviation Confirmation:</u> It may be note that any 'deviation / exception' in any form may result in rejection of Bid. Therefore, Bidder confirms that they have not taken any 'exception / deviation' anywhere in the Bid. In case any 'deviation / exception' is mentioned or noticed, Bidder's Bid may be rejected.</p>	
19.	<p>If Bidder becomes a successful Bidder pursuant to the provisions of the Tender Document, the following Confirmation shall be automatically become enforceable:</p> <p>"We agree and acknowledge that the Employer is entering into the Contract/Agreement solely on its own behalf and not on behalf of any other person or entity. In particular, it is expressly understood & agreed that the Government of India is not a party to the Contract/Agreement and has no liabilities, obligations or rights thereunder. It is expressly understood and agreed that the Purchaser is authorized to enter into Contract/Agreement, solely on its own behalf under the applicable laws of India. We expressly agree, acknowledge and understand that the Purchaser is not an agent, representative or delegate of the Government of India. It is further understood and agreed that the Government of India is not and shall not be liable for any acts, omissions, commissions, breaches or other wrongs arising out of the Agreement. Accordingly, we hereby expressly waive, release and forego any and all actions or claims, including cross claims, VIP claims or counter claims against the Government of India arising out of the Agreement and covenants not to sue to Government of India as to any manner, claim, cause of action or things whatsoever arising of or under the Agreement."</p>	
20.	Bidder to ensure all documents as per tender including clause 11 of Section III of tender and all Formats are included in their bid.	
21.	Bidder understands that Tender Document is not exhaustive. In case any activity though specifically not covered in description of 'Schedule of Rates' but is required to complete the work as per Scope of Work, Conditions of Contract, or any other part of Bidding document, the quoted rates will deemed to be inclusive of cost incurred for such activities unless otherwise specifically excluded. Bidder confirms to perform for fulfilment of the contract and completeness of the supplies in all respect within the scheduled time frame and quoted price.	
22.	<p>Bidder hereby confirms that they are not on 'Holiday' by OWNER or any of the JV partners of TFL (viz. GAIL, RCF, CIL, FCIL) or Public Sector Project Management Consultant (like PDIL, EIL, Mecon only due to "poor performance" or "corrupt and fraudulent practices") or banned by Government department/ Public Sector on due date of submission of bid.</p> <p>Further, Bidder confirms that neither they nor their allied agency/(ies) (as defined in the Procedure for Action in case of</p>	

SI.	DESCRIPTION	BIDDER'S CONFIRMATION
	<p>Corrupt/Fraudulent/Collusive/ Coercive Practices) are on banning list of TFL or any of the JV partner of TFL viz. GAIL, RCF, CIL, FCIL.</p> <p>Bidder also confirms that they are not under any liquidation, court receivership or similar proceedings or 'bankruptcy'.</p> <p>In case it comes to the notice of TFL/PDIL that the bidder has given wrong declaration in this regard, the same shall be dealt as 'fraudulent practices' and action shall be initiated as per the Procedure for action in case of Corrupt/Fraudulent/Collusive/Coercive Practices.</p> <p>Further, Bidder also confirms that in case there is any change in status of the declaration prior to award of contract, the same will be promptly informed to TFL/PDIL by them.</p>	
23	<p>Bidder confirms that (i) any variation in GST at the time of supplies for any reasons, other than statutory, including variations due to turnover, shall be borne by them and (ii) any error of interpretation of applicability of rate of GST (CGST & SGST/ UTGST or IGST) on components of an item and/or various items of tender by them shall be dealt as per clause no. 13.13 of Section-III of tender.</p>	
24	<p>Bidder certifies that they would adhere to the Fraud Prevention Policy of GAIL [available on GAIL's website (www.gailonline.com)] and shall not indulge themselves or allow others (working in GAIL) to indulge in fraudulent activities and that they would immediately apprise GAIL of the fraud/suspected fraud as soon as it comes to their notice.</p> <p>Concealment of facts regarding their involvement in fraudulent activities in connection with the business transaction(s) of GAIL is liable to be treated as crime and dealt with by the procedures of GAIL as applicable from time to time.</p>	
25.	<p>Bidders confirm to submit signed copy of Integrity Pact (wherever included in tender).</p> <p>If Bidder is a partnership concern or a consortium, this agreement must be signed by all partners or consortium members.</p>	
26.	<p>Bidder's offer No. & Date</p>	
27	<p>Bidder confirms that there is no conflict of interest with other bidders, as per clause no.4.2 of Section-III (ITB) of Tender Document.</p>	
28	<p>Bidder confirms that, in case of contradiction between the confirmations provided in this format and to the terms & conditions mentioned elsewhere in the offer, the confirmations given in this format shall prevail.</p>	

Place:

[Signature of Authorized Signatory of Bidder]

Date:

Name:

Designation:

Seal:

ACKNOWLEDGEMENT CUM CONSENT LETTER

(On receipt of tender document/information regarding the tender, Bidder shall acknowledge the receipt and confirm his intention to bid or reason for non-participation against the enquiry /tender through e-mail to concerned executive in TFL/PDIL issued the tender, by filling up the Format)

To,
**M/s TALCHER FERTILIZERS LIMITED
NOIDA**

SUB:
TENDER NO:

Dear Sir,

We hereby acknowledge receipt of a complete set of bidding documents along with enclosures for subject item/job and/or the information regarding the subject tender.

- We intend to bid as requested for the subject item/job and furnish following details with respect to our quoting office:

Postal Address with Pin Code :
Telephone Number :
Contact Person :
E-mail Address :
Mobile No. :
Date :
Seal/Stamp :

- We are unable to bid for the reason given below:

Reasons for non-submission of bid:

Agency's Name :
Signature :
Name :
Designation :
Date :
Seal/Stamp :

F-7
BIDDER'S EXPERIENCE

To,

**M/s TALCHER FERTILIZERS LIMITED
NOIDA**

SUB:
TENDER NO:

Sl. No	Detailed Description of Job	LOA/WO No. and date	Full Postal Address & phone nos. of Client. <i>Name, designation and address of Engineer/ Officer-in-Charge</i>	Capacity	Value of Contract/ Order (<i>Specify Currency Amount</i>)	Date of Commencement	Scheduled Completion Time (Months)	Date of Actual Completion	Reasons for delay in execution, if any	Details of satisfactory operation from the date of Acceptance
(1)	(2)	(3)	(4)	(5)	(6)	(7)	(8)	(9)	(10)	(11)

Place:
Date:

[Signature of Authorized Signatory of Bidder]

Name:
Designation:

Seal:

Note:As per Note III of Clause No. A.1 of Section-II, only documents (Work Order, Completion certificate, Execution Certificate etc.) which have been referred/ specified in the bid shall be considered in reply to queries during evaluation of Bids.

F-8(A)
CHECK LIST

Bidders are requested to duly fill in the checklist. This checklist gives only certain important items to facilitate the bidder to make sure that the necessary data/information as called for in the bid document has been submitted by them along with their offer. This, however, does not relieve the bidder of his responsibilities to make sure that his offer is otherwise complete in all respects.

Please ensure compliance and tick (√) against following points:

S. No.	DESCRIPTION	CHECK BOX
1.0	Digitally Signing (in case of e-bidding)/ Signing and Stamping (in case of manual bidding) on each sheet of offer, original bidding document including SCC, ITB,GCC, SOR DRAWINGS Corrigendum (if any)	
2.0	Confirm that the following details have been submitted in the Un-priced part of the bid	
i	Covering Letter, Letter of Submission	
ii	EMD / Declaration for Bid Security as per provisions of Tender (as applicable)	
iii.	Digitally signed (in case of e-tendering) or 'signed & stamped (in case of Manual tender) tender document along with drawings and addendum (if any)	
iv	Power of Attorney in the name of person signing the bid.	
v	Confirm submission of document alongwith unpriced bid as per bid requirement (including cl.no.11.1.1 of Section-III of tender).	
3.0	Confirm that all format duly filled in are enclosed with the bid duly Digitally Signed (in case of e-bidding)/ / Signed and Stamped (in case of manual bidding) by authorised person(s)	
4.0	Confirm that the price part as per Price Schedule format submitted with Bidding Document/uploaded in case of e-bid.	
5.0	Confirm that Undertaking as per <i>Form-I to Annexure-V to Section-III of tender</i> and Certification from the statutory auditor or cost auditor of the company (in the case of companies) or from a practicing cost accountant or practicing chartered accountant (in respect of other than companies) as per <i>Form-II to Annexure-V of Section-II of tender</i> are submitted.	
6.0	Confirm that Undertaking as per Form-1to Annexure-VII have been submitted by the bidder (Guidelines from Procurement from a Country sharing a Land Border with India)	
7.0	Confirm submission of Checklist against Bid Evaluation Criteria as per format F-8(B)	

Place:

[Signature of Authorized Signatory of Bidder]

Date:

Name:

Designation:

F-8(B)
CHECKLIST FOR BID EVALUATION CRITERIA (BEC) QUALIFYING DOCUMENTS
(refer Section II of Tender document)

Sl. No.	Description	Documents required for qualification	Documents Submitted by Bidder	Documents attested as per Section-II of Tender	Reference Page No. of the Bid submitted
Technical BEC					
1.	Experience	<p>(a) Copy of Detailed Letter of Acceptance (DLOA) / Work Order /relevant extract of work Order/ Contract Agreement along with detailed scope of work and Completion / Acceptance Certificate. Such certificate shall be issued by order issuing authority/ Owner/End user.</p> <p>(b) The Detailed Letter of Acceptance (DLOA) / Work Order / Contract Agreement must inter alia include Scope of work, completion time, contract value, etc. Similarly, the Completion Certificate/ Acceptance Certificate must clearly indicate reference of relevant work order/DLOA/Contract Agreement, Name of Work, Completed order value and date of completion</p> <p>(c) Certificate in respect of minimum one year successful operation of the Plant/System from the date of acceptance/Commissioning of work issued by the Owner/End user shall be submitted.</p> <p>(d) Any other documents as per BEC requirement.</p>		Yes/No	
2.	Experience of bidder acquired as a subcontractor	certificate from end user		Yes/No	
3.	Job executed for Subsidiary / Fellow subsidiary/ Holding company.	Tax paid invoice(s) duly certified by statutory auditor of the bidder towards payment of statutory tax in support of the job executed for Subsidiary / Fellow subsidiary/ Holding company.		Yes/No	

4.	Any other technical criteria in BEC	Bidder shall submit affidavit from the domestic manufacturers of such Iron & steel products as per the Form-I enclosed with the policy documents. A bidder who is not manufacturer of Iron & Steel product and is unable to submit the Affidavit from domestic manufacturers at bidding stage, such bidder can submit the Affidavit issued by domestic manufacturers after placement of order. In this case bidder along with his bid shall submit an undertaking as per prescribed format. Any other documents as per BEC requirement		Yes/No	
Financial BEC					
1.	Annual Turn Over	Audited Financial Statements [including Auditor's Report, Balance sheet, Profit & Loss Accounts statements, Notes & schedules etc.] for last Audited Financial Year. [In case the Annual Turnover criteria is not met in last Audited Financial Year, then the Audited Financial Statements for previous two years of last Audited Financial Year is to be submitted]	Submitted <i>(Mention specific year..... ...)</i>	Yes/No	
2.	Net Worth	Audited Financial Statements [including Auditor's Report, Balance sheet, Profit & Loss Accounts statements, Notes & schedules etc.] for last Audited Financial Year.	Submitted <i>(Mention specific year.....)</i>	Yes/No	
3.	Working Capital	Audited Financial Statements [including Auditor's Report, Balance sheet, Profit & Loss Accounts statements, Notes & schedules etc.] for last Audited Financial Year. If the bidder's working capital is negative or inadequate, the bidder shall submit a letter (in prescribed format) from their bank having net worth not less than Rs.100 Crores, confirming the availability of line of credit for at least working capital requirement as stated above.	Submitted <i>(Mention specific year..... ...)</i> Submitted/ Not Applicable <i>(Bidder to tick appropriate option)</i>	Yes/No	

4.	Format Details financial capability of Bidder	for of of Bidder shall submit "Details of financial capability of Bidder" in prescribed format duly signed and stamped by a chartered accountant / Certified Public Accountant (CPA).	Submitted		
----	--	--	-----------	--	--

Place:
Date:

[Signature of Authorized Signatory of Bidder]
Name:
Designation:
Seal :

F-9

**FORMAT FOR CERTIFICATE FROM BANK
IF BIDDER'S WORKING CAPITAL IS INADEQUATE/NEGATIVE**

(To be provided on Bank's letter head)

Date:

To,
**M/s. TALCHER FERTILIZERS LIMITED
NOIDA**

Dear Sir,

This is to certify that M/s (name of the Bidder with address)
(hereinafter referred to as Customer) is an existing Customer of our Bank.

The Customer has informed that they wish to bid for TFL's Tender / NIT no.
..... dated for(Name of the
supply/work/services/consultancy) and as per the terms of the said Tender/NIT Document they have
to furnish a certificate from their Bank confirming the availability of line of credit.

Accordingly M/s (name of the Bank with address) confirms availability of
line of credit to M/s (name of the Bidder) for at least an amount of Rs.

It is also confirmed that the net worth of the Bank is more than Rs. 100 Crores (or Equivalent USD)
and the undersigned is authorized to issue this certificate.

Yours truly

for (Name & address of Bank)

(Authorized signatory)

Name of the signatory:

Designation :

Email Id :

Contact No. :

Stamp

Note:

**This Declaration/Letter for line of credit shall be from single bank only. Letters from multiple
banks shall not be applicable. However, banking syndicate will be acceptable wherein a
group of banks can jointly provide line of credit to the bidder.**

F-10

**FORMAT FOR CHARTERED ACCOUNTANT CERTIFICATE/ CERTIFIED PUBLIC
ACCOUNTANT (CPA) FOR FINANCIAL CAPABILITY OF THE BIDDER**

We have verified the Audited Financial Statements and other relevant records of M/s..... (Name of the bidder) and certify the following:

A. AUDITED ANNUAL TURNOVER* OF PRECEDING THREE FINANCIAL YEARS:

Year	Amount (Currency)
Year 1:	
Year 2:	
Year 3:	

B. NETWORTH* AS PER AUDITED FINANCIAL STATEMENT OF PRECEDING FINANCIAL YEAR:

Description	Year _____
	Amount (Currency)
1. Net Worth	

C. WORKING CAPITAL* AS PER AUDITED FINANCIAL STATEMENT OF PRECEDING FINANCIAL YEAR:

Description	Year _____
	Amount (Currency)
1. Current Assets	
2. Current Liabilities	
3. Working Capital (Current Assets-Current liabilities)	

****Refer Instructions***

Notes:

- (i) It is further certified that the above mentioned applicable figures are matching with the returns filed with Registrar of Companies (ROC) [Applicable only in case of Indian Companies]
- (ii) We confirm the above figures after referring instructions at page 2 of 2 of Format F-10.
- (iii) Practicing Chartered Accountants shall generate Unique Document Identification Number (UDIN) for all certificates issued by them.

Name of Audit Firm:
Chartered Accountant/CPA
Date:

[Signature of Authorized Signatory]

Name:
Designation:
Seal:
UDIN:

Membership No.:

Instructions for Format F-10:

1. The Separate Pro-forma shall be used for each member in case of JV/ Consortium (If applicable).
2. The financial year would be the same as one normally followed by the bidder for its Annual Report.
3. The bidder shall provide the audited annual financial statements as required for this Tender document. Failure to do so would result in the Proposal being considered as non- responsive.
4. For the purpose of this Tender document:
 - (i) **Annual Turnover** shall be “Revenue from Operations” as per Profit & Loss account of audited annual financial statements
 - (ii) **Working Capital** shall be “Current Assets less Current liabilities” and
 - (iii) **Net Worth** shall be Aggregate value of the paid-up share capital and all reserves created out of the profits and securities premium account, after deducting the aggregate value of the accumulated losses, deferred expenditure and miscellaneous expenditure not written off, if any, but does not include reserves created out of revaluation of assets, write back of depreciation and amalgamation.
5. **Above figures shall be calculated after considering the qualification, if any, made by the statutory auditor on the audited financial statements of the bidder including quantified financial implication.**
6. This certificate is to be submitted on the letter head of Chartered Accountant/CPA.

F-11

DELETED

F-12

BIDDER'S QUERIES FOR PRE BID MEETING

To,

M/s TALCHER FERTILIZERS LIMITED
NOIDA

SUB:

TENDER NO:

SI. NO.	REFERENCE OF TENDER DOCUMENT				BIDDER'S QUERY	OWNER'S REPLY
	SEC. NO.	Page No.	Clause No	Subject		

NOTE: The Pre-Bid Queries may be sent by e-mail before due date for receipt of Bidder's queries.

SIGNATURE OF BIDDER: _____

NAME OF BIDDER: _____

F-13
E-Banking Mandate Form
(To be issued on vendors letter head)

1. Vendor/customer Name :
2. Vendor/customer Code:
3. Vendor /customer Address:
4. Vendor/customer e-mail id:
5. Particulars of bank account
 - a) Name of Bank
 - b) Name of branch
 - c) Branch code:
 - d) Address:
 - e) Telephone number:
 - f) Type of account (current/saving etc.)
 - g) Account Number:
 - h) RTGS IFSC code of the bank branch
 - i) NEFT IFSC code of the bank branch
 - j) 9 digit MICR code

I/We hereby authorize TFL to release any amount due to me/us in the bank account as mentioned above. I/We hereby declare that the particulars given above are correct and complete. If the transaction is delayed or lost because of incomplete or incorrect information, we would not hold the TFL responsible.

(Signature of vendor/customer)

BANK CERTIFICATE

We certify that ----- has an Account no. ----- with us and we confirm that the details given above are correct as per our records.

Bank stamp

Date

(Signature of authorized officer of bank)

F-14

INTEGRITY PACT

INTEGRITY PACT

INTEGRITY PACT

INTRODUCTION:

TFL as one of its endeavour to maintain and foster most ethical and corruption free business environment, have decided to adopt the Integrity Pact, a tool developed by the Transparency International, to ensure that all activities and transactions between the Company (TFL) and its Counterparties (Bidders, Contractors, Vendors, Suppliers, Service Providers/Consultants etc.) are handled in a fair and transparent manner, completely free of corruption.

Considering the above, the details mentioned at attached Annexure-1 are applicable as stated in Instruction to Bidders of Bid Document in addition to the existing stipulation regarding Corrupt and Fraudulent Practices.

The attached copy of the Integrity Pact at Annexure - 2 shall be included in the Bid submitted by the bidder (to be executed by the bidder for all tenders of value Rs. 1 (One) crore and above). In case a bidder does not sign the Integrity Pact, his bid shall be liable for rejection.

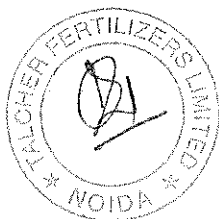

ANNEXURE-1

Bidder is required to sign the Integrity Pact with TFL as per format & terms and conditions enclosed with tender. In case a bidder does not sign the Integrity Pact, his bid shall be liable for rejection.

I COMMITMENTS AND OBLIGATIONS OF THE "COUNTERPARTY"

- a) The Counterparty, directly or indirectly (through agent, consultant, advisor, etc.), shall not pay any bribe/ influence or give undue/ unlawful benefit to anyone to gain undue advantage in dealing with TFL.
- b) The Counterparty will not engage in collusion of any kind including price fixation etc. with other Counterparts.
- c) The counterparty will not pass TFL's confidential information to any third party unless specifically authorized by TFL in writing.
- d) The Counterparties shall promote and observe best ethical practices within their respective organizations.
- e) The Counterparty shall inform the Independent External Monitor.
 - i) If it received any demand, directly or indirectly, for a bribe/ favour or any illegal gratification/ payment / benefit;
 - ii) If it comes to know of any unethical or illegal payment / benefit;
 - iii) If it makes any payment to any TFL associate.
- f) The Counterparty shall not make any false or misleading allegations against TFL or its associates.

II VIOLATIONS & CONSEQUENCES:

- a) If a Counterparty commits a violation of its Commitments and Obligations under the Integrity Pact Programme during bidding process, their entire Earnest Money Deposit/ Bid Security, would be forfeited and in addition, action shall be taken as per "Procedure for action in case Corrupt /Fraudulent/ Collusive/Coercive Practices"
- b) In case of violation of the Integrity pact by Counterparty after award of the Contract, TFL shall be entitled to terminate the Contract. Further, TFL would forfeit the security deposits/ Contract Performance Bank Guarantee and in addition, action shall be taken as per "Procedure for action in case Corrupt /Fraudulent/ Collusive/Coercive Practices"



INDEPENDENT EXTERNAL MONITORS (IEMS)

Presently the panel consisting of the following Independent External Monitors (IEMs) have been appointed by TFL, in terms of Integrity Pact (IP) which forms part of TFL Tenders / Contracts.

- i) Shri Sanjeev Prasad Narain Singh (Email ID: spns108@gmail.com)
- ii) Shri Anil Kumar Sharma (Email ID: aksharma1512@gmail.com)

This panel is authorised to examine / consider all references made to it under this tender/ contract. "The bidder(s), in case of any dispute(s) / complaint(s) pertaining to this tender falling under provisions of Integrity Pact may raise the same either directly with the IEMs on the panel viz Shri Sanjeev Prasad Narain Singh (Email ID: spns108@gmail.com) & Shri Anil Kumar Sharma (Email ID: aksharma1512@gmail.com) or with CC to them through their Nodal Officer - Sh. Manna Paul, DGM (C&P) – Email: mannapaul@gail.co.in, Address: Talcher Fertilizers Limited, C/o GAIL Training Institute, PARC Building, Plot No. 24, Sector-16A, Film City, Noida (U.P.) - 201301. On receipt of such complaints/representations, Nodal Officer shall coordinate with IEM Panel and TFL authorities concerned for their disposal as per extant guidelines."

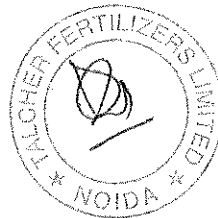

INTEGRITY PACT

(To be executed on plain paper)

Between Talcher Fertilizers Limited (TFL) [here-in-after referred to as "Principal"].

AND

_____ (here-in-after referred to as "The Bidder/ Contractor").

(Principal and the Bidder / Contractor are here-in-after are referred to individually as "Party" or collectively as "Parties").

PREAMBLE

The Principal intends to award under laid down organizational procedures, contract/s for _____. The Principal values full compliance with all relevant laws of land rules, regulations, and economic use of resources and of fairness /transparency in its relations with its Bidder (s) and/or Contractor (s).

In order to achieve these goals, the Principal will appoint Independent External Monitors (IEMs) who will monitor the tender process and the execution of the contract for compliance with the principles mentioned above.

Section 1 – Commitments of the Principal

1. The Principal commits itself to take all measures necessary to prevent corruption and to observe the following Principles:-
 - i) No employee of the Principal, personally or through family members, will in connection with the tender for, or the execution of a contract, demand, take a promise for or accept, for self or for a third person, any material or immaterial benefit which the person is not legally entitled to.
 - ii) The Principal will, during the tender process treat all Bidder(s) with equity and reasons. The Principal will in particular, before and during the tender process, provide to all Bidder(s) the same information and will not provide to any Bidder(s) confidential / additional information through which the Bidder(s) could obtain an advantage in relation to the tender process or the contract execution.

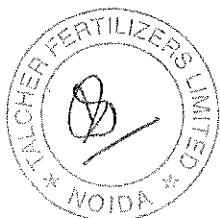

- iii) The Principal will exclude from the process all known prejudiced persons.
2. If the Principal obtains information on the conduct of any of its employees which is a criminal offence under the Indian Penal Code (IPC) / Prevention of Corruption Act (PC Act), or if there be a substantive suspicion in this regard, the Principal will inform the Chief Vigilance Officers and in addition can initiate disciplinary actions.

Section 2 – Commitments of the Bidder (s)/Contractor (s)

1. The Bidder(s) / Contractor(s) commits themselves to take all measures necessary to prevent corruption. The Bidder(s) / Contractor(s) commits themselves to observe the following principles during participation in the tender process and during the contract execution:
- i) The Bidder (s) / Contractor (s) will not, directly or through any other person or firm, offer, promise or give to any of the Principal's employees involved in the tender process or the execution of the contract or to any third person any material or other benefit which he / she is not legally entitled to, in order to obtain in exchange any advantage of any kind whatsoever during the tender process or during the execution of the contract.
 - ii) The Bidder (s) / Contractor (s) will not enter with other Bidders into any undisclosed agreement or understanding, whether formal or informal. This applies in particular to prices, specifications, certifications, subsidiary contracts, submission or non-submission of bids or any other action to restrict competitiveness or to introduce cartelisation in the bidding process.
 - iii) The Bidder (s) / Contractor (s) will not commit any offence under the relevant IPC/PC Act; further, the Bidder (s) / Contractor (s) will not use improperly, for purposes of competition or personal gain, or pass on to others, any information or document provided by the Principal as part of the business relationship, regarding plans, technical proposals and business details, including information contained or transmitted electronically.
 - iv) The Bidder (s)/ Contractor (s) of foreign origin shall disclose the name and address of the Agents/ representatives in India, if any. Similarly, the Bidder (s)/ Contractor (s) of Indian Nationality shall furnish the name and address of the foreign principals, if any. Further, all the payments made to the Indian agent/ representative have to be in India Rupees only.
 - v) The Bidder (s) / Contractor (s) will, when presenting their bid, disclose any and all payments made, is committed to or intends to make to agents,

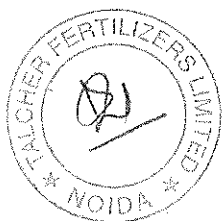

brokers or any other intermediaries in connection with the award of the contract.

- vi) Bidder(s) / Contractor(s) who have signed the Integrity Pact shall not approach the Courts while representing the matter to IEMs and shall wait for their decision in the matter.
2. The Bidder(s)/ Contractor(s) shall not instigate third person to commit offences outlined above or be an accessory to such offences.

Section 3 – Disqualification from tender process and exclusion from future contracts

If the Bidder (s) / Contractor (s), before award or during execution has committed a transgression through a violation of Section 2, above or in any other form such as to put their reliability or credibility in question, the Principal is entitled to disqualify the Bidder (s) / Contractor (s) from the tender process or take action as per provisions of "Procedure for action in case Corrupt /Fraudulent/ Collusive/Coercive Practices".

Section 4 – Compensation for Damages

1. If the Principal has disqualified the Bidder (s) from the tender process prior to the award according to Section 3, the Principal is entitled to demand and recover the damages equivalent to Earnest Money Deposit / Bid Security.
2. If the Principal has terminated the contract according to Section 3, or if the Principal is entitled to terminate the contract according to Section 3, the Principal shall be entitled to demand and recover from the Contractor liquidated damages equal to the Contract Value or the amount equivalent to Performance Bank Guarantee.

Section 5 – Previous transgression

1. The Bidder declares that no previous transgression occurred in the last three years, with any other Company in any country conforming to the anti-corruption approach or with any Public Sector Enterprise in India that could justify his exclusion from the tender process.
2. If the Bidder makes incorrect statement on this subject, he can be disqualified from the tender process or actions can be taken as per provisions of "Procedure for action in case Corrupt /Fraudulent/ Collusive/Coercive Practices"



Section 6 – Equal treatment to all Bidders / Contractors / Subcontractors

1. In case of sub-contracting, the Principal contractor shall take the responsibility of the adoption of IP by the sub-contractor. It is to be ensured by him that all sub-contractors also sign the IP.
2. The Principal will enter into agreements with identical conditions as this one with all Bidders and Contractors.
3. The Principal will disqualify from the tender process all bidders who do not sign this Pact or violate its provisions.

Section 7 – Criminal charges against violating Bidder (s) / Contractor (s) / Sub-contractor (s)

If the Principal obtains knowledge of conduct of a Bidder, Contractor or Subcontractor, or of an employee or a representative or an associate of a Bidder, Contractor or Subcontractor which constitutes corruption, or if the Principal has substantive suspicion in this regard, the Principal will inform the same to the Chief Vigilance Officer.

Section 8 –Independent External Monitor / Monitors

1. The Principal appoints competent and credible Independent External Monitor for this Pact after approval by Central Vigilance Commission. The task of the Monitor is to review independently and objectively, whether and to what extent the parties comply with the obligations under this agreement.
2. The Monitor is not subject to instructions by the representatives of the parties and performs his/her functions neutrally and independently. The Monitor would have access to all documents / records pertaining to the contract for which a complaint or issue is raised before them, as and when warranted. However, the documents / records / information having National Security implications and those documents which have been classified as Secret/Top Secret are not to be disclosed. It will be obligatory for him/her to treat the information and documents of the Bidders / Contractors as confidential. He / she reports to MD, TFL.
3. The Bidder (s)/ Contractor (s) accepts that the Monitor has the right to access without restriction to all Project documentation of the Principal including that provided by the Contractor. The Contractor will also grant the Monitor, upon his/her request and demonstration of a valid interest, unrestricted and unconditional access to their project documentation. The same is applicable to Sub-contractors.
4. The Principal will provide to the Monitor sufficient information about all meetings among the parties related to the Project provided such meetings could have an

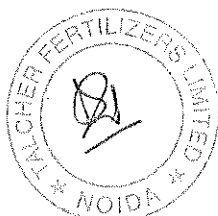

impact on the contractual relations between the Principal and the Contractor. The parties offer to the Monitor the option to participate in such meetings.

5. As soon as the Monitor notices, or believes to notice, a violation of this agreement, he/she will so inform the Management of the Principal and request the Management to discontinue or to take corrective action, or to take other relevant action. The monitor can in this regard submit non-binding recommendations. Beyond this, the Monitor has no right to demand from the parties that they act in a specific manner, refrain from action or tolerate action.
6. The Monitor will submit a written report to MD, TFL within 30 days from the date of reference or intimation to him by the 'Principal' and, should the occasion arise, submit proposals for correcting problematic situations.
7. If the Monitor has reported to MD, TFL, a substantiated suspicion of an offence under relevant IPC/PC Act, and MD, TFL has not, within reasonable time, taken visible action to proceed against such offence or reported it to the Chief Vigilance Officer, then, only in case of very serious issue having a specific verifiable Vigilance angle, the matter should be reported directly to the Central Vigilance Commission.
8. The word 'Monitor' would include both singular and plural.
9. In case of any complaints referred under IP Program, the role of IEMs is advisory and would not be legally binding and it is restricted to resolving the issues raised by an intending bidder regarding any aspect of the tender which allegedly restricts competition or bias towards some bidder.
10. After award of contract, the IEMs shall look into any issue relating to execution of contract, if specifically raised before them. As an illustrative example, if a contractor who has been awarded the contract, during the execution of contract, raises issue of delayed payment etc. before the IEMs, the same shall be examined by the panel of IEMs.

Section 9 – Pact Duration

This Pact begins when both parties have legally signed it. It expires for the Contractor 12 months after the last payment under the respective contract, and for all other Bidders 6 months after the contract has been awarded. Any violation to the same would entail disqualification of the bidders and exclusion from future business dealing.

If any claim is made / lodged during this time, the same shall be binding and continue to be valid despite the lapse of this pact as specified above, unless it is discharged/determined by MD, TFL.

Section 10 – Miscellaneous provisions



1. This agreement is subject to Indian Law. Place of performance and exclusive jurisdiction is the Registered Office of the Principal, i.e. New Delhi.
2. Changes and supplements as well as termination notices, if any, need to be made in writing. Side agreements have not been made.
3. If the Contractor/Bidder is a Joint Venture or a partnership concern or a consortium, this agreement must be signed by all partners or consortium members.
4. Should one or several of the provisions of this agreement turn out to be invalid, the remainder of this agreement shall remain valid. In this case, the parties will strive to come to an agreement to their original intentions in such a case.
5. Issues like warranty / guarantee, etc. shall be outside the purview of IEMs.
6. In the event of any contradiction between the Integrity Pact and its Annexure, the Clause in Integrity Pact will prevail.



मानना पॉल/MANNA PAUL
 (For & on Behalf of Principal)
 जेटी पार्क/टीएफएल लिमिटेड/JTI PARC Building
 जीटीपार्क इन्डस्ट्रियल इरिडिग/GTI PARC Building
 प्लॉट नं.- 24, सेक्टर-16ए, नोएडा-201 301 (उ.प्र.)
 Plot No. 24, Sec.-16A, Noida-201 301 (U.P.)
 (Office Seal)

 (For & on Behalf of
 Bidder/Contractor)

(Office Seal)

Place -----

Date -----

Witness 1:
 (Sign, Name & Address)
 [FOR PRINCIPAL]

Geogam [SORA DEOYAM, DM (CLP)]
 TALMER FERTILIZERS LIMITED (TFL)
 PLOT NO. 24, SECTOR-16A, NOIDA,
 U.P. - 201301

Witness 2:
 (Sign, Name & Address)
 [FOR BIDDER / CONTRACTOR]

.....

INDEMNITY BOND

WHEREAS TALCHER FERTILIZERS LIMITED (hereinafter referred to as “**TFL**”) which expression shall, unless repugnant to the context include its successors and assigns, having its registered office at Plot 2/H, Kalpana Area, BJB Nagar, Khorda, Bhubaneswar – 751014 has entered into a contract with M/s*..... (hereinafter referred to as the “**Contractor**”) which expression shall unless repugnant to the context include its representatives, successors and assigns, having its registered office at *..... and on the terms and conditions as set out, inter-alia in the **[mention the work order/FOA/Tender No.]** and various documents forming part thereof, hereinafter collectively referred to as the ‘**CONTRACT**’ which expression shall include all amendments, modifications and / or variations thereto.

TFL has also advised the Contractor to execute an Indemnity Bond in general in favour of TFL indemnifying TFL and its employees and Directors including Independent Directors from all consequences which may arise out of any prospective litigation or proceedings filed or may be initiated by any third party, including any Banker / financial institution / worker(s) /vendor(s)/ subcontractor(s) etc. who may have been associated or engaged by the Contractor directly or indirectly with or without consent of TFL for above works.

NOW, THEREFORE, in consideration of the promises aforesaid, the Contractor hereby irrevocably and unconditionally undertakes to indemnify and keep indemnified TFL and all its employees, Directors, including Independent Directors, from and against all/any claim(s), damages, loss, which may arise out of any litigations/ liabilities that may be raised by the Contractor or any third party against TFL under or in relation to this contract. The Contractor undertakes to compensate and pay to TFL and/or any of its employees, Directors including Independent Directors, forth with on demand without any protest the amount claimed by TFL for itself and for and on behalf of its employees, Directors including Independent Directors together with direct/indirect expenses including all legal expenses incurred by them or any of them on account of such litigation or proceedings.

AND THE CONTRACTOR hereby further agrees with TFL that:

- (i) This Indemnity shall remain valid and irrevocable for all claims of TFL and/or any of its employees and Directors including Independent Directors arising out of said contract with respect to any such litigation / court case for which TFL and/or its employees and Directors including Independent Directors has been made party until now or here-in-after.
- (ii) This Indemnity shall not be discharged/ revoked by any change/ modification/ amendment/ assignment of the contract or any merger of the Contractor with other entity or any change in the constitution/structure of the Contractor’s firm/ Company or any conditions thereof including insolvency etc. of the Contractor, but shall be in all respects and for all purposes binding and operative until any/ all claims for payment of TFL are settled by the Contractor and/or TFL discharges the Contractor in writing from this Indemnity.

The undersigned has full power to execute this Indemnity Bond for and on behalf of the Contractor and the same stands valid.

SIGNED BY :
For [Contractor]

Authorised Representative

Place:

Dated:

Witnesses:1.

F-16

FREQUENTLY ASKED QUESTIONS (FAQs)

SL.NO.	QUESTION	ANSWER
1.0	Can any vendor quote for subject Tender?	Yes. A Vendor has to meet Bid Evaluation Criteria given under Section II of Tender document in addition to other requirements.
2.0	Should the Bid Evaluation Criteria documents be attested?	Yes. Please refer Section II of Tender document
3.0	Is attending Pre Bid Meeting mandatory.	No. Refer Clause No. 17 of Instruction to Bidders of Tender Document. However attending Pre Bid Meeting is recommended to sort out any issue before submission of bid by a Bidder.
4.0	Can a vendor submit more than 1 offer?	No. Please refer Clause No. 4 of Instruction to Bidders of Tender Document.
5.0	Is there any Help document available for e-Tender.	Refer FAQs as available on CPP Portal e-Procurement).
6.0	Are there are any MSE (Micro & Small Enterprises) benefits available?	Refer Clause No. 40 of Instructions to Bidders of Tender Document.
7.0	Are there are any benefits available to Startups?	Refer Clause No. 49 of Instructions to Bidders of Tender Document.

All the terms and conditions of Tender remain unaltered.

Form F-17

**PROFORMA OF BANK GUARANTEE FOR MOBILISATION ADVANCE
(ON NON-JUDICIAL PAPER OF APPROPRIATE VALUE)**

To, M/s Talcher Fertilizers Limited, Noida	Bank Guarantee No.	
	Date of BG	
	BG Valid up to	
	Claim period up to (There should be three months gap between expiry date of BG & Claim period)	
	Stamp Sl. No. / e-Stamp Certificate No.	

Dear Sir(s),

In consideration of the Talcher Fertilizers Limited, hereinafter called the "Owner" which expression shall unless repugnant to the context or meaning thereof include its successors, executors, administrators and assignees, having awarded to M/s..... having its registered office at hereinafter referred as the 'CONTRACTOR', which expression shall unless repugnant to the context or meaning thereof, include its successors, administrators, executors and assignees, a contract hereinafter referred to as the 'Contract' for related works..... referred to as the 'WORK' on terms and conditions set out, inter-alia in the Owner's Contract / DLOA / FOA No.....dated..... valued at..... (in words & figures) and as the Owner having agreed to make an advance payment (herein after referred as Mobilization advance) for the performance of the above contract to the CONTRACTOR amounting to.....(in words & figures) as an advance against Bank Guarantee to be furnished by the CONTRACTOR.

We..... hereinafter referred to as the BANK which expression shall, unless repugnant to the context or meaning thereof, include its successors, administrators, executors and assignees having our office at..... do hereby undertake to give the irrevocable and unconditional guarantee and do hereby undertake to pay the OWNER on first demand without any demur, reservation, contest, recourse, protest and without reference to the CONTRACTOR any and all monies payable by the CONTRACTOR by reason of any breach by the said CONTRACTOR of any of the terms and conditions of the said Contract to the extent of..... till the said advance is adjusted as aforesaid at any time upto..... We agree that the guarantee herein contained shall continue to be enforceable till the sum due to the Owner on account of the said advance is adjusted/ recovered in full as aforesaid or till the Owner discharges this guarantee **in writing.**

The OWNER shall have the fullest liberty without affecting in any way the liability of the BANK under this guarantee, from time to time to vary the advance or to extend the time for performance of the works by the CONTRACTOR. The BANK shall not be released from its liability under these presents by any exercise of the Owner of the liberty with reference to the matter aforesaid.

The Owner shall have the fullest liberty, without reference to CONTRACTOR and without affecting this guarantee to postpone for any time or from time to time the exercise of any powers vested in them or of any right which they might have against the CONTRACTOR, and to exercise the same at any time in any manner, and either to enforce or to forebear to enforce any power, covenants contained or implied in the Contract between the OWNER and the CONTRACTOR or any other course or remedy or security available to the OWNER and the BANK shall not be released of its obligations under these presents by any exercise by the OWNER of its liberty with reference to matters aforesaid or other acts of omission or commission on the part of the OWNER or any other law would, but for this provision, have the effect of releasing the BANK.

The right of the OWNER to recover the outstanding sum of advance upto Rs.....from the BANK in the manner aforesaid **is absolute and unequivocal and** will not be affected or suspended by reason of the fact that any dispute or disputes has or have been raised by the CONTRACTOR and/or that any dispute or disputes is or are pending before any officer, tribunal or court **or arbitrator or any other authority/forum** and any demand made by OWNER on the BANK shall be conclusive and binding.

The BANK further undertakes not to revoke this guarantee during its currency without previous consent of the OWNER and further agrees that the guarantee contained shall continue to be enforceable **until it is discharged by TFL in writing.**

The BANK also agrees that the OWNER shall at its option be entitled to enforce this guarantee against the BANK as a principal debtor, in the first instance, notwithstanding any other security or guarantee that OWNER may have in relation to the CONTRACTOR's liabilities towards the said advance.

The amount under the Bank Guarantee is payable forthwith without any delay by Bank upon the written demand raised by TFL. Any dispute arising out of or in relation to the said Bank Guarantee shall be subject to the exclusive jurisdiction of courts at New Delhi.

Therefore, we hereby affirm that we are guarantors and responsible to you on behalf of the Contractor up to a total amount of _____(amount of guarantees in words and figures) and we undertake to pay you, upon your first written demand declaring the Contractor to be in default under the contract and without caveat or argument, any sum or sums within the limits of _____(amount of guarantee) as aforesaid, without your needing to prove or show grounds or reasons for your demand or the sum specified therein.

We have power to issue this guarantee in your favour under Memorandum and Articles of Association and the undersigned has full power to do so under the Power of Attorney/ resolution of the Board of Directors dated..... accorded to him by the BANK.

Notwithstanding anything contained herein:

- a) The Bank's liability under this Guarantee shall not exceed (currency in figures) _____ (currency in words only) _____
- b) This Guarantee shall remain in force upto _____ (three months beyond Completion Period) and any extension(s) thereof; and
- c) The Bank shall be released and discharged from all liability under this Guarantee unless a written claim or demand is issued to the Bank on or before the midnight of _____ (indicate date of expiry of claim period which includes minimum three months from the expiry of this Bank Guarantee) and if extended, the date of expiry of the last extension of this Guarantee. If a claim has been received by us within the said date, all the rights of TFL under this Guarantee shall be valid and shall not cease until we have satisfied that claim.

Dated.....this.....day of.....20

Signed by

(Person duly authorised by Bank)

Place:

WITNESS :

1..... (Signature)

..... (Printed Name)

..... (Designation)

2..... (Signature)

..... (Printed Name)

..... (Designation)

(Common Seal)

F-17 (A)
MATTER TO BE MENTIONED IN COVERING LETTER TO BE SUBMITTED BY
VENDOR ALONG WITH BANK GUARANTEE (BG)

1. Bank Guarantee No.		
2. Vendor Name		
3. Nature of Bank Guarantee [Please Tick (☐) whichever is applicable]	Contract Performance	
	Security (CPS)	
Purchase Order (PO) / Fax of Acceptance (FOA) / Detailed Letter of Acceptance (DLOA) No.		
Details of Bank issuing Bank Guarantee (BG)		
A. Name		
B. E-mail ID		
C. Address		
D. Phone No. / Mobile No.		

**PROFORMA FOR BANK GUARANTEE FOR PAYMENTS TOWARDS PLACEMENT OF ALL
PURCHASE ORDERS OF MAJOR TAGGED ITEMS.**

(To be submitted on Rs. 500/-(five hundred) non judicial stamp paper)

Ref.....

Bank Guarantee No.-----

Date.....

To,

M/s Talcher Fertilizers Limited

Dear Sir(s),

In consideration of the Talcher Fertilizers Limited, hereinafter called the "Owner" which expression shall unless repugnant to the context or meaning thereof include its successors, executors, administrators and assignees, having awarded to M/s..... having its registered office at hereinafter referred as the 'CONTRACTOR', which expression shall unless repugnant to the context or meaning thereof, include its successors, administrators, executors and assignees, a contract hereinafter referred to as the 'Contract' for related works..... referred to as the 'WORK' on terms and conditions set out, inter-alia in the Owner's Contract / DLOA / FOA No.....dated..... valued at..... (in words & figures) and as the Owner having agreed to make milestone payments (for the performance of the above contract to the CONTRACTOR amounting to.....(in words & figures) against Bank Guarantee to be furnished by the CONTRACTOR.

We..... hereinafter referred to as the BANK which expression shall, unless repugnant to the context or meaning thereof, include its successors, administrators, executors and assignees having our office at..... do hereby undertake to give the irrevocable and unconditional guarantee and do hereby undertake to pay the OWNER on first demand without any demur, reservation, contest, recourse, protest and without reference to the CONTRACTOR any and all monies payable by the CONTRACTOR by reason of any breach by the said CONTRACTOR of any of the terms and conditions of the said Contract to the extent of.....We agree that the guarantee herein contained shall continue to be enforceable till the Owner discharges this guarantee **in writing.**

The OWNER shall have the fullest liberty without affecting in any way the liability of the BANK under this guarantee, from time to time to vary the amount or to extend the time for performance of the works by the CONTRACTOR. The BANK shall not be released from its liability under these presents by any exercise of the Owner of the liberty with reference to the matter aforesaid.

The Owner shall have the fullest liberty, without reference to CONTRACTOR and without affecting this guarantee to postpone for any time or from time to time the exercise of any powers vested in them or of any right which they might have against the CONTRACTOR, and to exercise the same at any time in any manner, and either to enforce or to forebear to enforce any power, covenants contained or implied in the Contract between the OWNER and the CONTRACTOR or any other course or remedy or security available to the OWNER and the BANK shall not be released of its obligations under these presents by any exercise by the OWNER of its liberty with reference to matters aforesaid or other acts of omission or commission on the part of the OWNER or any other law would, but for this provision, have the effect of releasing the BANK.

The right of the OWNER to recover the outstanding sum upto Rs..... from the BANK in the manner aforesaid **is absolute and unequivocal and** will not be affected or suspended by reason of the fact that any dispute or disputes has or have been raised by the CONTRACTOR and/or that any dispute or disputes is or are pending before any officer, tribunal or court **or arbitrator or any other authority/forum** and any demand made by OWNER on the BANK shall be conclusive and binding.

The BANK further undertakes not to revoke this guarantee during its currency without previous consent of the OWNER and further agrees that the guarantee contained shall continue to be enforceable **until it is discharged by TFL in writing.**

The BANK also agrees that the OWNER shall at its option be entitled to enforce this guarantee against the BANK as a principal debtor, in the first instance, notwithstanding any other security or guarantee that OWNER may have in relation to the CONTRACTOR's liabilities towards the said milestone payment .

The amount under the Bank Guarantee is payable forthwith without any delay by Bank upon the written demand raised by TFL. Any dispute arising out of or in relation to the said Bank Guarantee shall be subject to the exclusive jurisdiction of courts at New Delhi.

Therefore, we hereby affirm that we are guarantors and responsible to you on behalf of the Contractor up to a total amount of _____(amount of guarantees in words and figures) and we undertake to pay you, upon your first written demand declaring the Contractor to be in default under the contract and without caveat or argument, any sum or sums within the limits of _____(amount of guarantee) as aforesaid, without your needing to prove or show grounds or reasons for your demand or the sum specified therein.

Notwithstanding anything contained hereinabove, our liability under this guarantee is restricted to _____ and it will remain in force upto and including _____ (this date shall be initially 15 months from date of FOA) and shall be extended from time to time for such periods as may be advised by M/s_____ on whose behalf this guarantee has been given.

We have power to issue this guarantee in your favour under Memorandum and Articles of Association and the undersigned has full power to do so under the Power of Attorney/ resolution of the Board of Directors dated..... accorded to him by the BANK.

Notwithstanding anything contained herein:
9.

- a) The Bank's liability under this Guarantee shall not exceed (currency in figures) _____ (currency in words only) _____
- b) This Guarantee shall remain in force upto _____ (this date shall be initially 15 months from date of FOA) and any extension(s) thereof; and
- c) The Bank shall be released and discharged from all liability under this Guarantee unless a written claim or demand is issued to the Bank on or before the midnight of _____ (indicate date of expiry of claim period which includes minimum three months from the expiry of this Bank Guarantee) and if extended, the date of expiry of the last extension of this Guarantee. If a claim has been received by us within the said date, all the rights of TFL under this Guarantee shall be valid and shall not cease until we have satisfied that claim.

Dated.....this.....day of.....20

Signed by

(Person duly authorised by Bank)

Place:

WITNESS :

1..... (Signature)
..... (Printed Name)
..... (Designation)

2..... (Signature)
..... (Printed Name)
..... (Designation)

(Common Seal)

F-19

FORMAT OF LETTER OF NO DEVIATIONS
(ON BIDDER'S LETTERHEAD)

(NIT NO :)

We * hereby agree to fully comply with, abide by and accept without variation, deviation or reservation all technical, commercial and other condition whatsoever of the Bidding Documents and all Addenda / Corrigenda / Amendment/ Clarifications issued by OWNER.

We further hereby confirm that the bid is submitted in accordance of Tender Document and contains no deviation and the price bid submitted may be treated to conform to, in all respects, with the terms and conditions of the said tender documents including all Addenda / Corrigenda/ Amendment /Clarifications.

For and on behalf of* :

Stamp & Signature** :

Name :

Designation :

Date :

***Here fill in the name of bidder.**

****The Letter of *No Deviation* must be signed by the person (s) authorized to sign as per POA.**

F-20
POWER OF ATTORNEY (POA)
(To be submitted on the Non-Judicial stamp paper / Company's Letter Head)

TENDER NO:

Description of work:

Name of Bidder: _____

"The undersigned _____ (Name of LEGAL PERSON, i.e. CEO/C&MD/Company Secretary/Partners) is lawfully authorized to issue this POA* on behalf of the company M/s _____ (Name of bidder) whose registered address is _____ and does hereby appoint Mr./Ms _____ (name of authorized person signing the bid document) _____ (Designation) of M/s _____ (Name of bidder) whose signature appears below to be the true and lawful attorney/(s) and authorize him/her to sign the bid (both physically & digitally on CPP Portal), conduct negotiation, sign contracts and execute all the necessary matter related thereto, in the name and on behalf of the company in connection with the tender no. _____.

The signature of the authorized person/(s) herein constitutes unconditional obligations of M/s _____ (Name of bidder).

This Power of Attorney (POA) shall remain valid and in full force and effect before we withdraw it in writing (by fax, or mail or post). All the documents signed (within the period of validity of the Power of Attorney) by the authorized person herein shall not be invalid because of such withdrawal.

(*) In case of a single Bidder, the Power of Attorney shall be issued as per the constitution of the bidder as below.

- a) **In case of Proprietorship:** By Proprietor
- b) **In case of Partnership:** by all Partners or Managing Partner.
- c) **In case of Limited Liability Partnership:** by any bidder's employee authorized in terms of Deed of LLP.
- d) **In case of Public /Limited Company:** POA in favour of authorized employee(s) by Board of Directors through Board Resolution or by the designated officer authorized by Board to do so. Such Board Resolution should be duly countersigned by Company Secretary / MD / CMD / CEO.

SIGNATURE OF THE LEGAL PERSON

(Name of person with Company seal)

SIGNATURE OF THE AUTHORIZED PERSON
(FOR SIGNING THE BID)

(Signature)
Name of person: _____
E-mail id: _____
DSC (Digital Signature Certificate) No.: _____

F-21

UNDERTAKING REGARDING SUBMISSION OF ELECTRONIC INVOICE (E-INVOICE AS PER GST LAWS)

(to be submitted on letter head along with documents for release of payment)

To,
M/s TALCHER FERTILIZERS LIMITED

SUB:

LOA NO:

Dear Sir,

We _____ (Name of the Supplier/Contractor/Service Provider/ Consultant) hereby confirm that E-Invoice provision as per the GST Law is

- (i) Applicable to us []]
- (ii) Not Applicable to us []]

(Supplier/Contractor/Service Provider/ Consultant is to tick appropriate option (✓ or X) above).

In case, same is applicable to us, we confirm that we will submit E-Invoice after complying with all the requirements of GST Laws. If the invoice issued without following this process, such invoice can-not be processed for payment by TFL as no ITC is allowed on such invoices. We also confirm that If input tax credit is not available to TFL for any reason attributable to Supplier/Contractor/Service Provider/ Consultant (both for E-invoicing cases and non-E-invoicing cases), then TFL shall not be obligated or liable to pay or reimburse GST (CGST & SGST/UTGST or IGST) claimed in the invoice(s) and shall be entitled to deduct / setoff / recover such GST amount (CGST & SGST/UTGST or IGST) or Input Tax Credit amount together with penalties and interest, if any, by adjusting against any amounts paid or becomes payable in future to the Supplier/Contractor/Service Provider/ Consultant under this contract or under any other contract.

Place: [Signature of Authorized Signatory of Bidder]

Date: Name:
Designation:
Bidder Name:
Seal:

Form F-22

**UNDERTAKING REGARDING SUBMISSION OF CONTRACT PERFORMANCE SECURITY
(CPS)/ SECURITY DEPOSIT (SD) WITHIN STIPULATED TIME LINE**

(to be submitted on letter head of bidder)

To,

M/s Talcher Fertilizers Limited

SUB:

TENDER NO:

Dear Sir,

We hereby confirm that we have clearly understood the requirement of Contract Performance Security (CPS) / Security Deposit (SD) specified in the tender document.

We also hereby confirm that in case of award of contract / order, we will submit Contract Performance Security (CPS) / Security Deposit (SD) within 30 days from the date of issuance of Fax of Acceptance.

Place: [Signature of Authorized Signatory of Bidder]

Date: Name:

Designation:

Bidder Name:

Seal:

F-23
PROFORMA FOR CONTRACT AGREEMENT
(To be executed on non-judicial stamp paper of appropriate value)

DLOA No. dated

TFL's PAN No.

Contract Agreement for the work of ----- of TALCHER FERTILIZERS LIMITED made on ---
----- between (Name and Address)-----, hereinafter called the "CONTRACTOR" (which term shall unless excluded by or repugnant to the subject or context include its successors and permitted assignees) of the one part and TALCHER FERTILIZERS LIMITED hereinafter called the "EMPLOYER" (which term shall, unless excluded by or repugnant to the subject or context include its successors and assignees) of the other part.

WHEREAS

- A. The EMPLOYER being desirous of having provided and executed certain work mentioned, enumerated or referred to in the Tender Documents including Letter Inviting Tender, General Tender Notice, General Conditions of Contract, Special Conditions of Contract, Specifications, Drawings, Plans, Time Schedule of completion of jobs, Schedule of Rates, Agreed Variations, other documents has called for Tender.
- B. The CONTRACTOR has inspected the SITE and surroundings of WORK specified in the Tender Documents and has satisfied himself by careful examination before submitting his tender as to the nature of the surface, strata, soil, sub-soil and ground, the form and nature of site and local conditions, the quantities, nature and magnitude of the work, the availability of labour and materials necessary for the execution of work, the means of access to SITE, the supply of power and water thereto and the accommodation he may require and has made local and independent enquiries and obtained complete information as to the matters and thing referred to, or implied in the tender documents or having any connection therewith and has considered the nature and extent of all probable and possible situations, delays, hindrances or interferences to or with the execution and completion of the work to be carried out under the CONTRACT, and has examined and considered all other matters, conditions and things and probable and possible contingencies, and generally all matters incidental thereto and ancillary thereof affecting the execution and completion of the WORK and which might have influenced him in making his tender.
- C. The Tender Documents including the Notice Letter Inviting Tender, General Conditions of Contract, Special Conditions of Contract, Schedule of Rates, General Obligations, SPECIFICATIONS, DRAWINGS, PLANS, Time Schedule for completion of Jobs, Letter of Acceptance of Tender and any statement of agreed variations with its enclosures copies of which are hereto annexed form part of this CONTRACT though separately set out herein and are included in the expression "CONTRACT" wherever herein used.

AND WHEREAS

The EMPLOYER accepted the Tender of the CONTRACTOR for the provision and the execution of the said WORK at the rates stated in the schedule of quantities of the work and finally approved by EMPLOYER (hereinafter called the "Schedule of Rates") upon the terms and subject to the conditions of CONTRACT.

NOW THIS AGREEMENT WITNESSETH AND IT IS HEREBY AGREED AND DECLARED AS FOLLOWS:-

1. In consideration of the payment to be made to the CONTRACTOR for the WORK to be executed by him, the CONTRACTOR hereby covenants with EMPLOYER that the CONTRACTOR shall and will duly provide, execute and complete the said work and shall do and perform all other acts and things in the CONTRACT mentioned or described or which are to be implied there from or may be reasonably necessary for the completion of the said WORK and at the said times and in the manner and subject to the terms and conditions or stipulations mentioned in the contract.
2. In consideration of the due provision execution and completion of the said WORK, EMPLOYER does hereby agree with the CONTRACTOR that the EMPLOYER will pay to the CONTRACTOR the respective amounts for the WORK actually done by him and approved by the EMPLOYER at the Schedule of Rates and such other sum payable to the CONTRACTOR under provision of CONTRACT, such payment to be made at such time in such manner as provided for in the CONTRACT.

A N D

3. In consideration of the due provision, execution and completion of the said WORK the CONTRACTOR does hereby agree to pay such sums as may be due to the EMPLOYER for the services rendered by the EMPLOYER to the CONTRACTOR, such as power supply, water supply and others as set for in the said CONTRACT and such other sums as may become payable to the EMPLOYER towards the controlled items of consumable materials or towards loss, damage to the EMPLOYER'S equipment, materials construction plant and machinery, such payments to be made at such time and in such manner as is provided in the CONTRACT.

It is specifically and distinctly understood and agreed between the EMPLOYER and the CONTRACTOR that the CONTRACTOR shall have no right, title or interest in the SITE made available by the EMPLOYER for execution of the works or in the building, structures or work executed on the said SITE by the CONTRACTOR or in the goods, articles, materials etc., brought on the said SITE (unless the same specifically belongs to the CONTRACTOR) and the CONTRACTOR shall not have or deemed to have any lien whatsoever charge for unpaid bills will not be entitled to assume or retain possession or control of the SITE or structures and the EMPLOYER shall have an absolute and unfettered right to take full possession of SITE and to remove the CONTRACTOR, their servants, agents and materials belonging to the CONTRACTOR and lying on the SITE.

The CONTRACTOR shall be allowed to enter upon the SITE for execution of the WORK only as a licensee simpliciter and shall not have any claim, right, title or interest in the SITE or the structures erected thereon and the EMPLOYER shall be entitled to terminate such license at any time without assigning any reason.

The materials including sand, gravel, stone, loose, earth, rock etc., dug up or excavated from the said SITE shall, unless otherwise expressly agreed under this CONTRACT, exclusively belong to the EMPLOYER and the CONTRACTOR shall have no right to claim over the same and such excavation and materials should be disposed off on account of the EMPLOYER according to the instruction in writing issued from time to time by the ENGINEER-IN-CHARGE.

In Witness whereof the parties have executed these presents in the day and the year first above written.

Signed and Delivered for and on behalf of EMPLOYER

TALCHER FERTILIZERS LIMITED

Signed and Delivered for and on behalf of the CONTRACTOR.

NAME OF CONTRACTOR

Date : _____

Place: _____

IN PRESENCE OF TWO WITNESSES

1. _____

2. _____

Date : _____

Place: _____

1. _____

2. _____

**NO CLAIM CERTIFICATE
(TO BE SUBMITTED BEFORE RELEASE OF CPS/SECURITY DEPOSIT)**

[On the Letter-head of Supplier/Vendor]

We, _____, a company incorporated under the laws of India/ a Consortium between *___ and *___ (*name of Consortium partners to be inserted*)/ a Partnership Firm consisting of *___ and *___ (*name of Partners to be inserted*)/ a Sole Proprietorship (as the case may be), having its registered office at _____ and carrying on business under the name and style M/s. _____ were awarded the contract by TFL. in reference to Tender No. _____ dated _____ (“Order/Contract”).



After completion of the above-said items/job under the Order/Contract, we have scrutinized all our claims, contentions, disputes, issues and we hereby confirm that after adjusting all payments received by us against our R.A. Bills and final bill, we have no claims, dues, issues and contentions from TFL.

We further absolve TFL. from all liabilities present or future arising directly or indirectly out of the Contract.

There is no economic duress or any other compulsion on us for submission of this no claim certificate.



Signature with Seal of Supplier/Vendor

Dated:

	EMERGENCY DIESEL GENERATOR PACKAGE TALCHER FERTILIZERS LIMITED, ODISHA (INDIA) GENERAL CONDITIONS OF CONTRACT (GCC)	PC-183/E-4022/P-I/S-IV	0	
		DOC. NO.	REV	
		SHEET 1 OF 75		



SECTION – IV

GENERAL CONDITIONS OF CONTRACT



	EMERGENCY DIESEL GENERATOR PACKAGE TALCHER FERTILIZERS LIMITED, ODISHA (INDIA) GENERAL CONDITIONS OF CONTRACT (GCC)	PC-183/E-4022/P-I/S-IV	0	
		DOC. NO.	REV	
		SHEET 2 OF 75		

CONTENT



SL. NO.	DESCRIPTION
1.0	DEFINITION OF TERMS
2.0	CONTRACT CONFIRMATION
3.0	MODIFICATIONS IN CONTRACT
4.0	USE OF CONTRACT DOCUMENTS AND INFORMATION
5.0	PRICES, TAXES & DUTIES AND OTHER LEVIES
6.0	INCOME TAX
7.0	PATENT INFRINGEMENT AND INDEMNIFICATION
8.0	CONTRACT PERFORMANCE SECURITY (CPS)
9.0	DELETED
10.0	SIGNING OF CONTRACT
11.0	DELETED
12.0	ASSIGNMENT OR SUBLETTING OF CONTRACT AND SUB-CONTRACTING
13.0	STANDARDS
14.0	INSTRUCTIONS, DIRECTIONS
15.0	DELETED
16.0	TIME SCHEDULE, AND PROGRESS REPORTING
17.0	CONTRACTOR TO INFORM HIMSELF FULLY
18.0	SUITABILITY OF PLANT FOR INTENDED PURPOSES
19.0	FEES FOR ROYALTIES AND PATENT RIGHTS
20.0	ACTS OF PARLIAMENT, LOCAL AND OTHER AUTHORITIES REGULATIONS AND BYELAWS
21.0	TIME - PROJECT SCHEDULE
22.0	CONTRACT PRICE
23.0	DEDUCTIONS FROM CONTRACT PRICE
24.0	DELETED
25.0	DELETED
26.0	TAXES APPLICABLE TO CONTRACTOR'S MANPOWER, TURNOVER, EQUIPMENT, ETC
27.0	PACKING, FORWARDING AND SHIPMENT
28.0	INSURANCE
29.0	DELETED
30.0	LIABILITY FOR ACCIDENTS AND DAMAGES
31.0	DELETED
32.0	DELETED
33.0	TIME EXTENSION OF CONTRACT
34.0	TERMINATION OF CONTRACT
35.0	FORCE MAJEURE
36.0	NO WAIVER OF RIGHTS
37.0	BANKRUPTCY AND LIQUIDATION OF CONTRACTOR OR BUSINESS UNDER RECEIVERSHIP
38.0	CERTIFICATE NOT TO AFFECT RIGHT OF OWNER AND LIABILITY OF CONTRACTOR
39.0	SETTLEMENT OF DISPUTES
40.0	ARBITRATION
41.0	GOVERNING LAWS , LANGUAGE AND MEASURES

	EMERGENCY DIESEL GENERATOR PACKAGE TALCHER FERTILIZERS LIMITED, ODISHA (INDIA) GENERAL CONDITIONS OF CONTRACT (GCC)	PC-183/E-4022/P-I/S-IV	0	
		DOC. NO.	REV	
		SHEET 3 OF 75		

SL. NO.	DESCRIPTION
42.0	RELEASE OF INFORMATION
43.0	COMPLETION OF CONTRACT
44.0	ENFORCEMENT OF TERMS
45.0	OWNER'S DECISION
46.0	CO-OPERATION
47.0	SUSPENSION OF WORK.
48.0	REPLACEMENT OF PARTS AND MATERIALS (DEFECTIVE/ DAMAGED/ LOST DURING TRANSIT/ERECTION AND COMMISSIONING)
49.0	DEFENCE OF SUITS
50.0	CONTRACTOR'S RESPONSIBILITIES
51.0	PROGRESS REPORTS AND PHOTOGRAPHS
52.0	DELETED
53.0	SECRECY
54.0	CORRESPONDENCE
55.0	MATERIALS AND EQUIPMENTS
56.0	MEASUREMENT, CERTIFYING INSPECTION & PAYMENTS
57.0	UNDER GROUND OBSTRUCTIONS
58.0	REGISTRATION TO THE CONTRACTOR WITH STATUARY AUTHORITIES
59.0	STATUARY OBLIGATIONS
60.0	UTILISATION OF LOCAL RESOURCES
61.0	FUEL REQUIREMENT OF WORKERS
62.0	SURPLUS MATERIAL
63.0	CO-ORDINATION WITH OTHER AGENCIES
64.0	ERECTION OF EQUIPMENT
65.0	ELECTRICAL CONTRACTOR LICENCE
66.0	RENT & ROYALTIES
67.0	GOVT. OF INDIA NOT LIABLE
68.0	SITE CLEANING
69.0	ACCESS TO SITE
70.0	INDEPENDENT CONTRACTOR
71.0	PAYMENT TO THE SUB – CONTRACTOR
72.0	ORDER OF WORKS / PERMISSION / RIGHT OF ENTRY / CARE OF EXISTING SERVICES
73.0	GIFTS, COMMISSIONS,ETC
74.0	LABOUR LAWS-PF, EPF AND ESI
75.0	GENERAL PROVISIONS
76.0	IMPLEMENTATION OF APPRENTICES ACT 1961
77.0	CHANGE IN CONSTITUTION
78.0	ACCESS BY ROAD
79.0	MEMBERS OF THE OWNER NOT INDIVIDUALLY LIABLE
80.0	OWNER NOT BOUND BY PERSONAL REPRESENTATIONS
81.0	LAND FOR CONTRACTOR'S FIELD OFFICE, GODOWN AND WORKSHOP
82.0	ROUNDING-OFF OF AMOUNTS
83.0	DELETED

 पी डी आई एल PDIL	EMERGENCY DIESEL GENERATOR PACKAGE TALCHER FERTILIZERS LIMITED, ODISHA (INDIA) GENERAL CONDITIONS OF CONTRACT (GCC)	PC-183/E-4022/P-I/S-IV	0	 Talcher Fertilizers
		DOC. NO.	REV	
		SHEET 4 OF 75		

SL. NO.	DESCRIPTION
84.0	WORK IN MONSOON AND DEWATERING
85.0	GENERAL CONDITIONS FOR CONSTRUCTION AND ERECTION WORK
86.0	ACTION WHERE NO SPECIFICATION IS ISSUED
87.0	DELETED
88.0	DELETED
89.0	CARE OF WORKS
90.0	FIELD MANAGEMENT & CONTROLLING/COORDINATING AUTHORITY
91.0	LOCAL CONDITIONS
92.0	SPECIAL CONDITIONS OF CONTRACT
93.0	POWER OF ENTRY
94.0	LIENS

	EMERGENCY DIESEL GENERATOR PACKAGE	PC-183/E-4022/P-I/S-IV	0	
	TALCHER FERTILIZERS LIMITED, ODISHA (INDIA)	DOC. NO.	REV	
	GENERAL CONDITIONS OF CONTRACT (GCC)	SHEET 5 OF 75		

1.0 DEFINITION OF TERMS AND INTERPRETATION



In the **CONTRACT**, unless the context otherwise requires, the following expressions shall have the following meanings. The singular shall include the plural and the plural include the singular except where the context otherwise requires and the words 'he', 'him', and 'his' shall be taken to mean 'she', 'her' and 'hers' where appropriate.

1. 'APPROVAL' shall mean and include the written approval by the OWNER of documents, drawing or other particulars in relation to this CONTRACT.
2. 'BATTERY LIMIT' shall mean the outer limits of boundaries of the areas within which the Plants and associated facilities shall be located.
3. 'BID' shall mean the proposal/document that the BIDDER submits in the requested and specified form in response to this NIT.
4. 'BIDDER' shall mean the Sole Bidder who shall submit or who have submitted the Bid.
5. 'CHANGE ORDER / AMENDMENT TO ORDER' means an order given in writing by the OWNER to effect additions to or deletion or alteration to the original CONTRACT.
6. 'CODES' shall mean the following, including the latest amendments, and/or replacements, if any:
 - a) All relevant Indian Acts, and Rules and Regulations made there under;
 - b) ASME Codes
 - c) IBR Codes
 - d) AIEE Codes
 - e) American Society of Testing of Materials (ASTM) Codes
 - f) Other internationally applicable standards and/or Regulations the subject matter of the CONTRACT.
 - g) Indian Employees Provident Fund Act,
 - h) Pollution Control norms of INDIA
 - i) Contract Labour
 - j) Minimum Wages Act
 - k) Any other labour laws of INDIA applicable during execution of contract.
 - l) Any other codes/standards specified in the contract documents.
7. 'COMMERCIAL USE' shall mean that use of the PLANT which the CONTRACT contemplates or of which it is commercially capable.
8. 'COMMISSIONING' shall be as defined in Section-VI of Technical Part.
9. 'CONSULTANT/PROJECT MANAGEMENT CONSULTANT (PMC)' shall mean PROJECTS & DEVELOPMENT INDIA LIMITED, who are the consulting engineer to the OWNER for this project and having registered office at PDIL Bhawan, A-14, Sector-1, Noida – 201301, Uttar Pradesh.



	EMERGENCY DIESEL GENERATOR PACKAGE TALCHER FERTILIZERS LIMITED, ODISHA (INDIA) GENERAL CONDITIONS OF CONTRACT (GCC)	PC-183/E-4022/P-I/S-IV	0	
		DOC. NO.	REV	
		SHEET 6 OF 75		

10. 'CONTRACT' shall mean the Agreement between the OWNER and the CONTRACTOR for the execution of the works including therein all contract documents.
11. 'CONTRACTOR' shall mean the successful Bidder whose bid has been accepted by the OWNER and who has been selected by the OWNER for the award of Works and shall include his heirs, legal representatives, successors and permitted assigns.
12. 'SCHEDULED/CONTRACTUAL COMPLETION PERIOD' shall mean the time period mentioned in the tender document by which CONTRACT shall be completed, including any time extension granted in writing by OWNER through a CHANGE ORDER/AMENDMENT. Time extensions, if any, shall be without prejudice to other terms and conditions of tender, unless as otherwise stated in CHANGE ORDER/AMENDMENT.
13. 'CONTRACTOR'S EQUIPMENT' means all equipment, construction plant, vehicles, temporary facilities, material, tools or things brought on to the Site by or on behalf of the Contractor for carrying out the Works but not for permanent incorporation in the Plant.
14. 'CONTRACTOR'S SOFTWARE' means standard Software owned by the CONTRACTOR.
15. 'CONTRACTOR'S WORKS' OR 'MANUFACTURER'S WORKS' shall mean the place or places of work used by the CONTRACTOR/SUB-CONTRACTOR/SUB-VENDOR or their collaborator(s) for the manufacture of EQUIPMENT or performance of WORKS.
16. 'COST' means the cost incurred by the Contractor in carrying out any of his obligations under the Contract, and 'Costs' shall be construed accordingly.
17. 'DAY' shall mean a day of 24 hours from midnight to midnight irrespective of the number of hours worked in that day.

"WORKING DAY" means any day which is not declared to be holiday or rest day by the OWNER.
18. 'DEEMED ACCEPTANCE' shall be as defined in SPECIAL CONDITIONS OF CONTRACT.
19. 'DEFECT' means any work done or any Material or the Plant or any part of it which does not comply with the CONTRACT.
20. 'DEFECT LIABILITY PERIOD' shall be as defined in SPECIAL CONDITIONS OF CONTRACT.
21. 'DOCUMENT(S)/DOCUMENTATION' means any relevant documents in paper or electronic form, including drawings, technical software, images, designs, manuals or records.

	EMERGENCY DIESEL GENERATOR PACKAGE	PC-183/E-4022/P-I/S-IV	0	
	TALCHER FERTILIZERS LIMITED, ODISHA (INDIA)	DOC. NO.	REV	
	GENERAL CONDITIONS OF CONTRACT (GCC)	SHEET 7 OF 75		

22. 'DRAWINGS' or 'PLAN' shall mean all
- a) Drawings furnished by the OWNER as a basis for proposals;
 - b) Supplementary drawings furnished by the OWNER to clarify and to define in greater detail the intent of the CONTRACT;
 - c) DRAWINGS submitted by the CONTRACTOR with his proposal provided such drawings are acceptable to the OWNER.
 - d) DRAWING furnished by the OWNER to the CONTRACTOR during the progress of the works; and
 - e) Engineering data and DRAWINGS submitted by the CONTRACTOR during the progress of the work provided such drawings are acceptable to the OWNER.
23. DLOA shall mean DETAILED LETTER OF ACCEPTANCE which shall be issued to successful bidder.
24. 'ENGINEER'S INSTRUCTIONS' shall mean any drawings and/or instructions in writing, details, directions and explanations issued by the OWNER from time to time to the CONTRACTOR/ SUB-CONTRACTOR for carrying out the WORK during the COMPLETION PERIOD
25. ENGINEER IN CHARGE" shall mean the person designated from time to time by the OWNER and shall include those who are expressly authorized by him to act for and on his behalf for operation of this CONTRACT.
26. 'EQUIPMENT' OR 'STORES' shall mean the equipment, machinery and structure of any kind which the CONTRACTOR is obliged to design, supply, deliver, unload, store at site, erect, set to work and test under the CONTRACT.
27. 'FINAL ACCEPTANCE' shall mean that date when all of the conditions set forth in Clause 19 of SPECIAL CONDITIONS OF CONTRACT have been satisfied, all liabilities and obligations under this CONTRACT have been discharged, except those specially to be continued or performed after FINAL ACCEPTANCE. .
28. 'FINAL ACCEPTANCE CERTIFICATE' shall mean that certificate issued by the ENGINEER-IN-CHARGE or OWNER to the CONTRACTOR subject to clause 19 of SPECIAL CONDITIONS OF CONTRACT at the end of the DEFECTS LIABILITY PERIOD.
29. 'FINAL COMPLETION' shall mean the completion of guarantee tests and handing over of the PLANTS and facilities to OWNER.
30. FINAL PROPOSAL means the Offer/Bid submitted by the Bidder against this tender including it's Amendments/Corrigendum/Addendum/etc.
31. 'FORCE MAJEURE' has the meaning stated in Sub-clause 35.0 of GCC.
32. 'FOA' means FAX OF ACCEPTANCE, which shall be issued to successful bidder.
33. GCC' or GENERAL CONDITIONS OF THE CONTRACT shall mean all the



	EMERGENCY DIESEL GENERATOR PACKAGE	PC-183/E-4022/P-I/S-IV	0	
	TALCHER FERTILIZERS LIMITED, ODISHA (INDIA)	DOC. NO.	REV	
	GENERAL CONDITIONS OF CONTRACT (GCC)	SHEET 8 OF 75		

terms and conditions forming part of this agreement as defined in this Section.

34. 'INSPECTOR' shall mean the duly authorised representative of the OWNER for stage wise or final inspection of WORKS or of EQUIPMENT or MATERIALS to be supplied under the CONTRACT.
35. 'LEGISLATION' means all applicable laws, directives, codes, statutes, rules, ordinances, approvals, licences, decrees, authorizations, by-laws, regulations, standards and any other requirement of any governmental authority or agency whether international national, state, municipal, local or other government subdivision, having the force of law in any place where the WORKS or any part of the WORKS are being carried out.
36. 'MANUFACTURER' shall mean a person or firm who is the producer and supplier of material and/ or designer and/or fabricator of equipment to either the OWNER, the CONTRACTOR or both under the CONTRACT.
37. 'MATERIALS' means machinery, plant and other items of equipment and materials intended to form part of the PLANT and other things needed for its operation, to be supplied by the CONTRACTOR.
38. "MECHANICAL COMPLETION" shall be as defined in SPECIAL CONDITIONS OF CONTRACT.
39. 'MONTH' shall mean the calendar month.
40. 'NOTICE IN WRITING', 'WRITTEN NOTICE' shall mean a notice in written, typed or printed characters sent (unless delivered personally or otherwise proved to have been received) by registered post/ Speed Post to the last known private or business address or registered office of the addressee and shall be deemed to have been received when in the ordinary course of post it would have been delivered. Fax with Post copy confirmation.
41. 'OTHER CONTRACTOR/OTHERS' shall mean any person(s) having a contract with the OWNER to design, supply, erect, set to work, or do any other thing to or in connection with any other plant and shall include their, heirs, legal representatives, successors and permitted assigns.
42. 'OWNER' shall mean M/s TALCHER FERTILIZERS LIMITED having its registered office at Plot 2/H, Kalpana Area Nagar, Khordha, Bhubaneshwar and Project office at GAIL Training Institute, PARC Building, Sector 16A, Film City, Noida – 201301 Uttar Pradesh and shall include their, heirs, legal representatives, successors and permitted assigns.
43. 'PERFORMANCE & GUARANTEE TESTS RUN (PGTR)' shall be as defined in SPECIAL CONDITIONS OF CONTRACT.
44. 'PLANT' shall be as defined in the SPECIAL CONDITIONS OF CONTRACT.
45. 'PRELIMINARY ACCEPTANCE' shall be as defined in the SPECIAL CONDITIONS OF CONTRACT.

	EMERGENCY DIESEL GENERATOR PACKAGE		PC-183/E-4022/P-I/S-IV	0	
	TALCHER FERTILIZERS LIMITED, ODISHA (INDIA)		DOC. NO.	REV	
	GENERAL CONDITIONS OF CONTRACT (GCC)		SHEET 9 OF 75		

46. 'PRELIMINARY ACCEPTANCE CERTIFICATE' shall be as defined in the SPECIAL CONDITIONS OF CONTRACT.
47. "PRE-COMMISSIONING" shall be as defined in the SPECIAL CONDITIONS OF CONTRACT.
48. 'PROJECT' shall mean the Project specified in the Technical specification.
49. 'SCC' or SPECIAL CONDITIONS OF THE CONTRACT shall mean all the terms and conditions forming part of the CONTRACT as stipulated elsewhere in the tender document.
50. 'SITE' shall mean and include the land and other places on, into or through which the EQUIPMENT and related facilities shall be erected and any adjacent land, paths, streets or reservoirs which may be allocated or used by the OWNER or CONTRACTOR in the performance of the CONTRACT.
51. 'SOFTWARE' means all forms of software and firmware and their documentation.
52. 'SPECIFICATION' shall mean collectively all the terms and stipulations in the Technical Specifications, schedules, detailed descriptions, statement of Technical Data, performance characteristics, standards & codes etc., and subsequent addenda issued thereto before the date of closing of bid and all written agreements made or to be made pertaining to the method and manner of performing the Work or to the quantities and the qualities of the materials to be furnished under this CONTRACT.
53. 'SUB-CONTRACTOR/SUB-VENDOR' shall mean any person or persons, or firm(s) including his/their, heirs, legal representatives, successors and permitted assigns selected by the CONTRACTOR with prior written approval of the OWNER for undertaking any part of the Works under the CONTRACT or to whom any part of the CONTRACT is sublet by the CONTRACTOR with the consent in writing of the OWNER.
54. 'TAKING OVER' AND 'TAKEN OVER' shall mean OWNER taking possession of and use of the PLANT.
55. 'TEMPORARY WORKS' means all temporary works and structures of every kind constructed at the Site and required for the provision and construction of the PLANT.
56. 'THIRD PARTY SOFTWARE' means standard Software which is owned by a third party.
57. 'TOTAL LSTK PRICE/TOTAL CONTRACT PRICE" shall mean the sum accepted or the sum calculated in accordance with the prices accepted in tender and/or the CONTRACT rates as payable to the CONTRACTOR for the entire execution and full completion of the work, including CHANGE ORDER, if any.
58. 'WEEK' shall mean continuous period of 7 (Seven) DAYS.
59. 'WORK' OR 'WORKS' means the design, engineering and other services to be

	EMERGENCY DIESEL GENERATOR PACKAGE		PC-183/E-4022/P-I/S-IV	0	
	TALCHER FERTILIZERS LIMITED, ODISHA (INDIA)		DOC. NO.	REV	
	GENERAL CONDITIONS OF CONTRACT (GCC)		SHEET 10 OF 75		

provided by the Contractor including, but not limited to, the provision and construction of the PLANT and any Temporary Works and the subsequent dismantling or removal of the Temporary Works when no longer required, and any other works to be carried out by the CONTRACTOR in accordance with the CONTRACT.

60. 'WRITING' shall include any manuscript, typewritten or printed statement, under or over signature and/or seal as the case may be.
61. 'NOTICE INVITING TENDER (NIT)/ BIDDING DOCUMENT' means Complete Bidding Document as originally issued and any Addendum /Corrigendum/ Amendment(s) issued thereafter.
62. 'MUTUALLY AGREED DAMAGES' (MAD) shall be as defined in SPECIAL CONDITIONS OF CONTRACT.

2.0 CONTRACT DOCUMENTS

The term 'Contract Documents' shall mean and include the following documents which shall constitute the Contract and shall be deemed to form an integral part of the Contract:



- a) Contract Agreement
- b) Detailed Letter of Acceptance (DLOA) and all Annexures
- c) FAX of Acceptance (FOA)
- d) Agreed variations , if any
- e) Schedule of Rates
- f) Corrigendum/Addendum/Amendment to tender
- g) Complete Original Tender Document with all enclosures
- h) Integrity Pact (IP) signed between the Owner and the Bidder/Contractor

The above documents are intended to be correlative, complementary and mutually explanatory. The Contract shall be read as a whole.

2.1 INTERPRETATION OF CONTRACT DOCUMENTS

2.1.1 Notwithstanding the sub-division of the CONTRACT document into these separate documents and/or volumes and/or heads, every part of each separate section/volume/head shall be deemed to be supplementary of every other part and shall be read with and into the CONTRACT so far as it may be practicable to do so.

2.1.2 If in respect of any commercial term or condition, if any provision in the GENERAL CONDITIONS OF CONTRACT is repugnant to or at variance with any provision(s) of the SPECIAL CONDITIONS OF CONTRACT, the provision(s) of the SPECIAL CONDITIONS OF CONTRACT shall be deemed to override the provision(s) of GENERAL CONDITIONS OF CONTRACT, but only to the extent that such repugnancy in the GENERAL CONDITIONS OF CONTRACT cannot be reconciled with the SPECIAL CONDITIONS OF CONTRACT.



	EMERGENCY DIESEL GENERATOR PACKAGE TALCHER FERTILIZERS LIMITED, ODISHA (INDIA) GENERAL CONDITIONS OF CONTRACT (GCC)	PC-183/E-4022/P-I/S-IV	0	
		DOC. NO.	REV	
		SHEET 11 OF 75		

- 2.1.3 Without prejudice to the provisions of the GENERAL CONDITIONS OF CONTRACT, whenever in the Bidding documents it is mentioned or stated that the CONTRACTOR shall perform certain work or provide certain facilities, it is understood that the CONTRACTOR shall do so at his own cost and the TOTAL CONTRACT PRICE shall be deemed to have included the cost of such performance and/or provision, as the case may be.
- 2.1.4 The MATERIALS, design and workmanship shall satisfy the applicable relevant Indian standards, the job specifications contained herein and the codes referred to by expression or implication. Where the job specifications stipulate requirements in addition to those contained in the standard codes and specifications, these additional requirements shall also be satisfied. In the absence of any standard/specification/code of practice for detailed specifications covering any part of the work covered in this tender, the instructions/directions agreed between OWNER and CONTRACTOR based on good international engineering practice shall be binding on the CONTRACTOR.
- 2.1.5 The documents forming the Contract are to be read together and interpreted as mutually explanatory of one another. If there is a direct inconsistency in specific obligation(s), then for the purposes of interpretation, and unless otherwise provided in the Contract, the priority of the Contract Documents shall be in accordance with following sequence:
- i. The Contract Agreement
 - ii. Detailed Letter of Acceptance (DLOA) along with its enclosures
 - iii. Fax of Acceptance (FOA)
 - iv. Schedule of Rates (SOR)
 - v. Scope of Works/ Job Specifications (specific to particular job only, wherever provided)
 - vi. Drawings
 - vii. Special Conditions of Contract (SCC)
 - viii. Technical Specifications (wherever applicable)
 - ix. Instructions to Bidders (ITB)
 - x. General Conditions of Contract (GCC)
 - xi. Other Documents

Any amendment / Corrigendum / Addendum to tender issued by PMC/Owner shall take precedence over respective clauses of the original tender document and its annexures.



Similarly, any amendment / change order issued by Owner upon signing of formal Contract shall take precedence over respective clauses of the formal Contract and its annexures

- 2.1.6 Should there be any doubt or ambiguity in the interpretation of the CONTRACT documents or contradiction therein or should there be any discernable error or omission in any CONTRACT document, the CONTRACTOR shall, prior to commencing the relative work or supply, as the case may be, apply in writing to the Engineer-In-Charge for his decision for resolution of the doubt, ambiguity or contradiction or correction of the error or making good the omission, as the case may be. Should the CONTRACTOR fail to apply to the ENGINEER-IN-CHARGE for his decision as aforesaid prior to commencing the relative work or supply, the CONTRACTOR shall perform the said work or make the said

	EMERGENCY DIESEL GENERATOR PACKAGE	PC-183/E-4022/P-I/S-IV	0	
	TALCHER FERTILIZERS LIMITED, ODISHA (INDIA)	DOC. NO.	REV	
	GENERAL CONDITIONS OF CONTRACT (GCC)	SHEET 12 OF 75		

supply, as the case may be, at his own risk, and the provisions of NIT shall apply to any such work performed or supply made by the CONTRACTOR.

- 2.1.7 Notwithstanding anything provided in Clause 2.1.6 hereof above, either the CONTRACTOR or any representative of the OWNER or CONSULTANT may, at any time prior to or during the execution of the work or supply of any material or any part thereof (if the CONTRACTOR has failed to make an application as provided for in Clause 2.1.6), apply to the ENGINEER-IN-CHARGE in writing for his decision in resolution of any doubt, ambiguity or contradiction or for the correction of any error or for making good the omission as the case may be.
- 2.1.8 The decision of the ENGINEER-IN-CHARGE on any application under Clause 2.1.6 or Clause 2.1.7 hereof shall be in writing and shall be final and binding upon the CONTRACTOR and shall form part of the CONTRACT documents, with the intent that the CONTRACT documents shall be read as though the said decision is and was at all times incorporated therein. It is clarified that in case the Contractor disagrees with the decision of the ENGINEER-IN-CHARGE, the dispute shall be settled as per the provisions of Clause 39.0 of GCC.
- 2.2 Any work or supply shown, indicated or included in any description of the work, plans, drawings, Specifications and/or Price Schedule or other Contract or Bid documents shall be deemed to form part of the WORK and/or supply contracted for, as the case may be, notwithstanding failure to show, indicate or include such work or supply in any other or others among the documents aforesaid with the intent that the indication or inclusion of the work or supply within any one of the said documents shall be deemed to be a sufficient indication or inclusion of the work or supply, as the case may be, within the work and supply covered by the CONTRACT.
- 2.3 No verbal agreement, assurance, representation or understanding given by any employee or officer of the OWNER or so understood by the CONTRACTOR, whether given or understood before or after the execution of the contract, shall any-wise bind the OWNER or alter the CONTRACT documents unless specifically given in writing and signed by the OWNER or by the ENGINEER-IN-CHARGE on behalf of the OWNER and issue the amendment of the relative term(s).
- 2.4 Clause headings given in this or any other contract documents are intended only as a general guide for convenience in reading and segregating the general subject of the various Clauses, but do not form part of the contract documents, with the intent that the Clause headings shall not govern the meaning or import of the Clauses there under appearing or confine or otherwise affect the interpretation thereof.
- 3.0 MODIFICATIONS IN CONTRACT**
- 3.1 All modifications leading to changes in the CONTRACT with respect to technical or commercial aspects including terms of completion period shall be considered valid only when accepted in writing by OWNER and CONTRACTOR by issuing amendment to the CONTRACT. Issuance of acceptance or otherwise in such cases shall not be any ground for extension of agreed completion date (except in cases where completion period itself is revised by OWNER) and also shall not affect the performance of CONTRACT in any manner except to the extent mutually agreed to, through a modification to CONTRACT. The PARTIES shall have the right to modify or amend the CONTRACT subject to an

	EMERGENCY DIESEL GENERATOR PACKAGE	PC-183/E-4022/P-I/S-IV	0	
	TALCHER FERTILIZERS LIMITED, ODISHA (INDIA)	DOC. NO.	REV	
	GENERAL CONDITIONS OF CONTRACT (GCC)	SHEET 13 OF 75		

adjustment in the CONTRACT PRICE and/ or COMPLETION DATE in accordance with the applicable provision of the CONTRACT, if any, and subject to mutual agreement.

- 3.2 OWNER shall not be bound by any printed conditions or provisions in the CONTRACT-OR's bid forms or acknowledgement of CONTRACT, packing list and other documents which support to impose any condition at variance with or supplemental to CONTRACT

4.0 USE OF CONTRACT DOCUMENTS AND INFORMATION

- 4.1 The CONTRACTOR shall not, without the OWNER's prior written consent, disclose the CONTRACT or any provision thereof, or any specification, plan, drawing, pattern, sample or information furnished by or on behalf of the OWNER in connection therewith, to any person other than a person employed by the CONTRACTOR in the performance of the CONTRACT. Disclosure to any such employed person shall be made in confidence and shall extend only so far as may be necessary for purpose of such performance.

- 4.2 The CONTRACTOR shall not without the OWNER's prior written consent, make use of any document or information enumerated in Clause 6.1 except for purpose of performing the CONTRACT.

- 4.3 Any document other than CONTRACT, itself, enumerated in Clause 6.1 shall remain the property of the OWNER and shall be returned (all copies) to the OWNER on completion of the CONTRACTOR's performance under the CONTRACT if so required by the OWNER.

5.0 PRICES, TAXES AND DUTIES AND OTHER LEVIES

The following provisions are in addition to Clause 13 of "Instruction to Bidders" (Section-III)



The prices shall include all duties, taxes and levies etc. including but not limited to customs duty, GST on imports, any tax / duty/ levy as per applicable GST laws, personnel and corporate tax as applicable.

The Bidders are to quote firm prices. In respect of both direct transaction between OWNER and the Bidder and Bought Out Items to be dispatched directly from the sub-vendor's works to Owner's site, the payment towards all applicable Indian Taxes and duties like Custom Duty, GST and other tax/duty/levy, will be made by OWNER in Indian rupees at actuals limited to the amount indicated in the Bid.

In case of Bought out items to be dispatched directly from sub-vendor's works to Owner's site, the CONTRACTOR shall ensure that his sub-vendors raise tax invoice under the provisions of GST Law, billed to the CONTRACTOR and shipped to Owner's site. The CONTRACTOR shall further ensure that he raises his corresponding tax invoices under the provision of GST Law in the name of OWNER during transit of the Material before the delivery of Material is taken by OWNER.

- 5.1 Except as specifically provided to the contrary in the SPECIAL CONDITIONS OF CONTRACT:

- (i) The CONTRACTOR shall, within the price of materials and scope of supply, be liable to pay and bear any and all duties, taxes, levies and cesses lawfully

	EMERGENCY DIESEL GENERATOR PACKAGE	PC-183/E-4022/P-I/S-IV	0	
	TALCHER FERTILIZERS LIMITED, ODISHA (INDIA)	DOC. NO.	REV	
	GENERAL CONDITIONS OF CONTRACT (GCC)	SHEET 14 OF 75		



payable on any goods, equipment or materials imported into India or within any local limits for permanent incorporation in the work(s), and on materials sold and supplied to the OWNER pursuant to the CONTRACT.

- (ii) The CONTRACTOR shall within the price of services and scope of services be responsible to pay on behalf of the OWNER any and all duties, taxes, levies and cesses including education cess etc. lawfully payable on any goods or equipment imported into India or within any local limits for use in the performance of the work(s), and on services performed pursuant to the CONTRACT.
- (iii) The CONTRACTOR shall be liable for and shall pay any and all Indian fees, taxes, duties, levies and cesses including education cess etc., assessable against CONTRACTOR in respect of or pursuant to the CONTRACT. However, GST payment by the CONTRACTOR to the Tax Authority shall be made by the Owner to the CONTRACTOR at actual limited to the Amount indicated in the Bid.
- (iii) In addition, the CONTRACTOR shall be responsible for payment of all Indian duties, levies, and taxes etc., assessable against the CONTRACTOR or CONTRACTOR's employees or SUB-CONTRACTOR'S whether corporate or personal or applicable in respect of property.
- (iv) CONTRACTOR should comply with the provisions of e-way bill notified by appropriate authorities from time to time. The existing provisions of road permit will continue till such time if applicable.
- (v) There will be no materials under the scope of Contract which will be consigned to Owner, unless otherwise specifically mentioned elsewhere in the tender. The Owner will not issue / provide Road permits/e-way bill to the Contractor except in respect of material directly purchased by the Owner.

5.2 TAX INDEMNITY

It will be the duty of the CONTRACTOR to duly observe and perform all laws, rules, regulations, orders and formalities applicable under GST and Customs Duty on the manufacture, sale, import and/or supply of any material to OWNER and/or applicable on the services performed by the CONTRACTOR pursuant hereto. The CONTRACTOR shall keep the OWNER indemnified for and against any and all claims, demands, prosecutions, penalties, damages, demurrages and/or other levies whatsoever made or levied by the Court or Customs Authorities with respect to any alleged breach, evasion or infraction of such duties, taxes, charges or levies or any breach or infraction of such laws, rules, regulations, orders or formalities concerning the same and from the consequence thereof.

- 5.3 The CONTRACTOR confirms that, it has included all taxes, duties, levies etc., as applicable at prevailing rates, in its TOTAL CONTRACT PRICE as quoted in Schedule of Rate. In case, CONTRACTOR has not included any such taxes, duties, levies etc., at all and/or at prevailing rates and CONTRACTOR has to pay such taxes, duties, levies etc., OWNER shall not be liable for payment of such liabilities and/or OWNER shall not reimburse such taxes, duties, levies etc. to CONTRACTOR.

	EMERGENCY DIESEL GENERATOR PACKAGE TALCHER FERTILIZERS LIMITED, ODISHA (INDIA) GENERAL CONDITIONS OF CONTRACT (GCC)	PC-183/E-4022/P-I/S-IV	0	
		DOC. NO.	REV	
		SHEET 15 OF 75		

5.4 The award of work shall be on 'Work Contract Service' basis.

The contractor shall be responsible for payment of any tax levied on the transfer of property and goods involved with relevant GST act and rules made there under including amendments, if any. The contractor shall be liable to ensure to have registered with the respective tax authorities and to submit self-attested copy of such registration certificate(s) and any taxes/ duties/ levies being charged by the Contractor would be claimed by issuing proper tax invoice/challan indicating details/ elements of all taxes charged and necessary requirements as prescribed under the respective tax laws and also to mention correct and valid registration number(s) on all tax invoices raised to TFL.

5.5 Any other taxes / duties in relation to this CONTRACT, which in terms of relevant legislation is the liability of CONTRACTOR, is discharged by OWNER, would be recovered from the CONTRACTOR from any subsequent payment due to the CONTRACTOR.

5.6 Applicable BOCW shall be included in the quoted TOTAL CONTRACT PRICE. The contractor shall pay the cess under BOCW Act for subject works and submit proof of submission of cess to owner before submitting the next R.A. bill. In case, contractor does not submit the said proof, applicable BOCW shall be deducted at source by the OWNER from the contractor's invoice and deposit the deducted amount to the concerned authority. OWNER does not undertake any further responsibility in this regard.

6.0 INCOME TAX



6.1 CONTRACT PRICE shall be inclusive of any and all Indian Income Tax payable in India. OWNER shall deduct Indian Income Tax as per rates prescribed for such contracts from time to time, from the payments due to CONTRACTOR and issue Tax Deducted at Source (TDS) certificate to CONTRACTOR. It will be the responsibility of the CONTRACTOR to file proper income tax return and pay taxes thereon if any, or claim refund thereof if any. The CONTRACTOR shall give OWNER all necessary documents relating to its income tax assessments and to keep the OWNER informed about their assessments.

6.2 Personal income tax payable, if any, in respect of salary and perquisites of CONTRACTOR's personnel / SUB-CONTRACTOR's personnel in India shall be payable by the individual so deputed by CONTRACTOR or SUB-CONTRACTOR. It is the responsibility of the individual or CONTRACTOR to file proper income tax return and pay taxes thereon if any, or claim refund thereof if any. The CONTRACTOR shall give OWNER all necessary documents relating to income tax assessments of its personnel and to keep the OWNER informed about their assessments.

7.0 PATENT INFRINGEMENT AND INDEMNIFICATION (WHEREVER APPLICABLE)

7.1 PATENT INFRINGEMENT

7.1.1 CONTRACTOR shall at all times, indemnify and keep indemnified OWNER against all claims or suits and defend, at its own cost, any suit or action brought against OWNER and hold OWNER free and harmless against all costs of such claims or suits which may be made against OWNER in respect of any infringement of any rights protected by patent, copyright, trademarks, and trade secrets to the extent that such claim, suit, or action is a result of the use of CONTRACTOR's Technical Information for the construction, maintenance, and operation of PLANT and the use of CONTRACTOR's

	EMERGENCY DIESEL GENERATOR PACKAGE	PC-183/E-4022/P-I/S-IV	0	
	TALCHER FERTILIZERS LIMITED, ODISHA (INDIA)	DOC. NO.	REV	
	GENERAL CONDITIONS OF CONTRACT (GCC)	SHEET 16 OF 75		

and/or any other process licensor's processes used in PLANT. OWNER shall pass on all claims made against it to CONTRACTOR for settlement.

7.1.2 CONTRACTOR declares that to the best of its knowledge and belief the use of CONTRACTOR's Technical Information for the construction, maintenance, and operation of PLANT and the use of CONTRACTOR's processes used in PLANT will not infringe any valid patent rights of a third party. However, if at any time such infringement arises, CONTRACTOR agrees to keep OWNER indemnified and harmless against such claims and costs thereof and make arrangements that will allow OWNER to continue the operation of PLANT.

7.1.3 OWNER shall promptly advise CONTRACTOR in writing of any claim of infringement or any action for infringement of patents brought against it by a third party and based upon the use of CONTRACTOR's Technical Information. If such use is in accordance with instructions given in writing by CONTRACTOR, CONTRACTOR shall undertake the defence, or assist OWNER in the defence, of the claim or suit up to final judgment or settlement.

7.1.4 CONTRACTOR shall undertake the defence on behalf of OWNER and shall have sole charge and direction of the defence, and shall bear all costs related thereto. CONTRACTOR shall further hold OWNER harmless from any damages or other sums that may become payable by OWNER under a final judgment or settlement. However, OWNER shall render to CONTRACTOR all reasonable assistance that may be required by CONTRACTOR in the defence, and shall have the right to be represented therein by advisory counsel of its own selection and at its own expense.

7.1.5 In addition to the measures specified in Clause 7.1.4, CONTRACTOR may further, at its option, however, in reasonable consultation with OWNER, seek to abate the alleged infringement by modification of PLANT or its operation without adversely affecting the performance and/or secure for OWNER immunity from suit for infringement. In such case, CONTRACTOR shall bear/ reimburse OWNER for all costs related to said modification and to said immunity.

7.1.6 In the event that OWNER is legally restrained from operating PLANT on account of any infringement action or suit, CONTRACTOR shall take all possible actions to allow OWNER to operate and use PLANT.



7.1.7 Neither CONTRACTOR nor OWNER shall settle or compromise any suit or action without the written consent of the other if settlement or compromise obliges the other to make any payment or part with any property or assume any obligations or surrender any rights or to be subjected to any injunction by reason of such settlement or compromise.

7.2 INDEMNITIES

7.2.1 INDEMNIFICATION FOR LIABILITIES

7.2.1.1 CONTRACTOR Indemnification for Liabilities

To the fullest extent permitted by Law, CONTRACTOR assumes liability for and agrees to indemnify, protect, save and hold harmless OWNER from and against any and all Liabilities (including, any strict liability), arising out of acts or omissions of CONTRACTOR

	EMERGENCY DIESEL GENERATOR PACKAGE		PC-183/E-4022/P-I/S-IV	0	
	TALCHER FERTILIZERS LIMITED, ODISHA (INDIA)		DOC. NO.	REV	
	GENERAL CONDITIONS OF CONTRACT (GCC)		SHEET 17 OF 75		

or its personnel or its agents in the performance of its obligations under the CONTRACT causing bodily injury, sickness, disease or death, damage to or loss of any property, and whether or not involving damage to WORKS or SITE that may be imposed on, suffered or incurred by or asserted against OWNER and in any way relating to or arising out of (i) WORK, any EQUIPMENT (ii) the presence, discharge, treatment, storage, transportation, disposal, escape or release of any Hazardous Substance, or the threat thereof, at, to or from SITE after commencement of work (any hazardous substance already existing at SITE before commencement of WORK excluded)(iii) The performance of WORK, or as a result of personal injuries (including wrongful death); (iv) the violation by CONTRACTOR or any SUB-CONTRACTOR/VENDOR of any Government Approval or applicable Law relating to WORK (v) any breach of CONTRACT with any SUB-CONTRACTOR/VENDOR, provided, however, that CONTRACTOR shall not be required under this Clause to indemnify OWNER for any liability arising out of or resulting from events or circumstances occurring or existing after PRELIMINARY ACCEPTANCE OF PLANT except where the liability arises from an act or omission of CONTRACTOR or any SUB-CONTRACTOR/VENDOR or any other Person directly or indirectly employed by either of them or anyone for whose acts either of them may be liable that was a contributory cause of such liability.

7.2.2 **CONTRACTOR Indemnification for Taxes**

It is specifically understood that CONTRACTOR hereby accepts and assumes exclusive liability for and save and hold OWNER harmless from and against of all Taxes arising from the performance of WORK, and all such Taxes shall be deemed to be included in CONTRACT PRICE.

7.2.3 **Indemnification by SUB-CONTRACTOR/VENDOR**



CONTRACTOR shall obtain from each SUB-CONTRACTOR/VENDOR, which is an affiliate, and shall use all reasonable efforts to obtain from each SUB-CONTRACTOR/VENDOR, an indemnification materially similar in form and substance to Clause-7.1 and Clause-7.2.2 of which the OWNER shall be named as beneficiary.

7.2.4 **Payment of Amounts under this Clause**

Except to the extent covered by insurance, all amounts payable and due by CONTRACTOR to OWNER under this Clause shall be deducted from CONTRACT PRICE or any other amounts owed by OWNER to CONTRACTOR here under. If such amounts payable by OWNER to CONTRACTOR are less than the amounts payable and due by CONTRACTOR under this Clause, CONTRACTOR shall be liable to OWNER for such excess and shall pay such amount to OWNER immediately upon demand.

7.2.5 **Permits and Certificates**

CONTRACTOR shall procure, at its expense, all necessary permits, certificates and licences required by virtue of all applicable laws, regulations, ordinances and other rules in force at the place where any of the works is to be performed, and CONTRACTOR further agrees to hold OWNER harmless from liability or penalty which might be imposed by reason of any asserted or established violation of such laws, regulations, ordinances or other rule. OWNER shall provide the necessary permits for CONTRACTOR's personnel to undertake any work in India in connection with CONTRACT.

	EMERGENCY DIESEL GENERATOR PACKAGE	PC-183/E-4022/P-I/S-IV	0	
	TALCHER FERTILIZERS LIMITED, ODISHA (INDIA)	DOC. NO.	REV	
	GENERAL CONDITIONS OF CONTRACT (GCC)	SHEET 18 OF 75		

7.2.6 **Mechanics Lien**

CONTRACTOR agrees to indemnify and hold harmless OWNER against all labourer's material, man's and/or mechanic's liens arising from its work, and shall keep the premises of OWNER free from all such claims, liens and encumbrances.

8.0 **CONTRACT PERFORMANCE SECURITY (CPS)**



8.1 The proceeds of **CPS** shall be appropriated by the OWNER as compensation for any loss resulting from the CONTRACTOR's failure to complete their obligations under the CONTRACT without prejudice to any of the rights or remedies the OWNER may be entitled to as per terms and conditions of the CONTRACT.

8.2 The CONTRACTOR shall extend the validity of the **CPS** suitably if it is required due to delay in COMPLETION of the PLANT at it's own cost. The CPS shall be suitably extended in event of repair/replacement of equipment or any part thereof during DEFECT LIABILITY PERIOD to take care of extended warranty period of repair/replacement. The CPS will be discharged by the OWNER after the CONTRACTOR's performance obligation including any warranty obligation under the CONTRACT. For any component replaced during DEFECT LIABILITY PERIOD, the component should work satisfactorily for a period of 12 months from the date of replacement

The CPS shall be retained by OWNER during the currency of CONTRACT as indicated above or till settlement of all the accounts thereof, whichever is later. In case of any dispute or differences not settled within the validity of CPS, contractor shall arrange to get the CPS extended for the period asked for by OWNER. In case CPS is not extended as asked, OWNER shall have the sole discretion to 'call in' the bank to pay the whole or part of the amount of bank guarantee/CPS. The above deposit shall be deemed to be security for the faithful performance of the CONTRACT and for the purpose of section 74 of the Indian Contract Act, 1872 and for the extension of that section, the CPS shall be deemed to be the bond given by the CONTRACTOR for the performance of essential duty. In the event of breach of any of the terms and conditions of the contract, OWNER shall have the right to draw from the CPS whole or part of the value of CPS. The amount so drawn shall not in any way affect any remedy to which OWNER may otherwise be entitled or any liability incurred by contractor under the contract or any law for the time being in force relating thereto or bearing here upon. This CPS shall be refunded 3 months after expiry of Defect Liability Period. It shall be lawful for OWNER if any differences or dispute is likely to arise to defer payment of the CPS or any portion thereof which may be due for release until such differences and dispute has been finally settled or adjusted. CPS amount shall not bear any interest.

NOTE:

In case CPS is submitted by way of Bank Guarantee, the non-judicial Stamp paper of appropriate value only or equivalent document value shall have to be purchased in the name of the bank executing the bank guarantee and not in the name of the CONTRACTOR.

	EMERGENCY DIESEL GENERATOR PACKAGE TALCHER FERTILIZERS LIMITED, ODISHA (INDIA) GENERAL CONDITIONS OF CONTRACT (GCC)	PC-183/E-4022/P-I/S-IV	0	
		DOC. NO.	REV	
		SHEET 19 OF 75		

8.3 Rights of the OWNER to forfeit CPS:

- i) Whenever any claim against the CONTRACTOR for the payment of a sum of money arises out or under the CONTRACT, the OWNER shall be entitled to recover such sum by appropriating in part or whole the CPS of the CONTRACTOR. In the event of the security being insufficient or if no security has been taken from the CONTRACTOR, then the balance or the total sum recoverable, as the case may be shall be deducted from any sum then due or which at any time thereafter may become due to the CONTRACTOR. The CONTRACTOR shall pay to the OWNER on demand any balance remaining due.
- ii) All compensation or other sums of money payable by the CONTRACTOR to the OWNER under terms of this CONTRACT may be deducted from or paid by the encashment or sale of a sufficient part of his CPS or from any sums which may be due or may become due to the CONTRACTOR by the OWNER of any account whatsoever and in the event of his Rights of the OWNER to forfeit CPS.

9.0 DELETED

10.0 SIGNING OF CONTRACT

- 10.1 All documents as per Clause 2.0 of GCC shall be included in the DLOA.
- 10.2 Every page of the DLOA & CONTRACT agreement shall be initialled by the authorised representatives of OWNER and CONTRACTOR under the Seal of their respective Companies.
- 10.3 The CONTRACTOR shall present the above CONTRACT AGREEMENT so prepared in two Sets alongwith proper Power of Attorney and other requisite material on the day of signing the agreement.
- 10.4 Notwithstanding anything mentioned in any other clause, any conditions imposed from time to time by Government of India shall be followed by the CONTRACTOR.



11.0 Deleted

12.0 ASSIGNMENT OR SUBLETTING OF CONTRACT AND SUB-CONTRACTING

- 12.1 No part of the CONTRACT nor any share or interest therein shall in any manner or degree be transferred, assigned or sublet by the CONTRACTOR directly or indirectly to any person, firm or corporation whatsoever without the consent in writing, of the ENGINEER/EMPLOYER except as provided for in the succeeding sub-clause.

i. SUB-CONTRACTS FOR TEMPORARY WORKS ETC.:

The EMPLOYER may give written consent to Sub- contract for the execution of any part of the WORK at the site, being entered in to by CONTRACTOR provided each individual Sub- contract is submitted to the ENGINEER-IN-CHARGE before being entered into and is approved by him.

	EMERGENCY DIESEL GENERATOR PACKAGE	PC-183/E-4022/P-I/S-IV	0	
	TALCHER FERTILIZERS LIMITED, ODISHA (INDIA)	DOC. NO.	REV	
	GENERAL CONDITIONS OF CONTRACT (GCC)	SHEET 20 OF 75		

ii. LIST OF SUB-CONTRACTORS TO BE SUPPLIED

At the commencement of every month the CONTRACTOR shall furnish to the ENGINEER-IN-CHARGE list of all SUB-CONTRACTORS or other persons or firms engaged by the CONTRACTOR and working at the SITE during the previous month with particulars of the general nature of the Sub-contract or works done by them

iii. CONTRACTOR'S LIABILITY NOT LIMITED BY SUB- CONTRACTORS

Notwithstanding any sub-letting with such approval as aforesaid and notwithstanding that the ENGINEER-IN-CHARGE shall have received copies of any Sub-contracts, the contractor shall be and shall remain solely responsible for the quality, proper and expeditious execution of the Contract in all respects as if such sub-letting or Subcontracting had not taken place, and as if such work had been done directly by the CONTRACTOR. The CONTRACTOR shall bear all responsibility for any act or omission on the part of sub-contractors in regard to work to be performed under the CONTRACT.

iv. EMPLOYER MAY TERMINATE SUB-CONTRACTS

If any SUB-CONTRACTOR engaged upon the works at the site executes any works which in the opinion of the ENGINEER-IN-CHARGE is not in accordance with the CONTRACT documents, the EMPLOYER may by written notice to the CONTRACTOR request him to terminate such subcontract and the CONTRACTOR upon the receipt of such notice shall terminate such Subcontract and dismiss the SUB-CONTRACTOR(S) and the later shall forthwith leave the works, failing which the EMPLOYER shall have the right to remove such SUB- CONTRACTOR(S) from the site.

v. NO REMEDY FOR ACTION TAKEN UNDER THIS CLAUSE



No action taken by the EMPLOYER under the clause shall relieve the CONTRACTOR of any of his liabilities under the CONTRACT or give rise to any right or compensation, extension of time or otherwise failing which the EMPLOYER shall have the right to remove such SUB-CONTRACTOR(S) from the site

12.2 DELETED

12.3 **Sub-Contracting for WORKS (to be read in conjunction with clause regarding sub-contractors/Sub-vendors sharing land border with India as per Annexure-VII of tender document).**

12.3.1 **General**

All vendors, suppliers, consultants and SUB-CONTRACTORS/SUB-VENDORS providing equipment, materials, construction equipment, or services to CONTRACTOR under a SUBCONTRACT, purchase order or similar purchase form or arrangement with CONTRACTOR for the performance of the WORK under this CONTRACT are herein referred as "SUB-CONTRACTORS"/ "SUB-VENDORS", and any such SUB-CONTRACTS, purchase orders or similar purchase forms or arrangement entered into by or on behalf of CONTRACTOR with SUB CONTRACTORS/SUB-VENDORS are herein

	EMERGENCY DIESEL GENERATOR PACKAGE	PC-183/E-4022/P-I/S-IV	0	
	TALCHER FERTILIZERS LIMITED, ODISHA (INDIA)	DOC. NO.	REV	
	GENERAL CONDITIONS OF CONTRACT (GCC)	SHEET 21 OF 75		

referred to as "SUB-CONTRACTS" provided that none of OWNER's CONTRACTOR'S or SUB-CONTRACTOR'S/ SUB-VENDOR'S shall be deemed to be a SUB-CONTRACTOR/ SUB-VENDOR under the CONTRACTOR. The CONTRACTOR shall be obligated to select SUB-CONTRACTORS/ SUB-VENDORS it retains in connection with the performance by CONTRACTOR of the WORK from the SUB-CONTRACTOR'S/ SUB-VENDOR'S list which would be finalised and approved by the OWNER. OWNER and CONTRACTOR may by mutual agreement add to or delete from such list from time to time and approve any successor or replacement of any person listed on such list or any other vendor, supplier, material-man, consultant or SUB-CONTRACTOR/SUB-VENDOR.

12.3.2 **Approval of SUB-CONTRACTOR/SUB-VENDOR**

12.3.2.1 The vendor list for procurement of EQUIPMENT and the list of SUB-CONTRACTOR/SUB-VENDOR shall be as attached in the Section VI of NIT. Any changes to such list of SUB-CONTRACTOR/SUB-VENDOR shall require the prior approval of OWNER. CONTRACTOR shall provide name, address, fax number and name of contact person of major SUB-CONTRACTORS/SUB-VENDORS for use in future, to OWNER. SUB-CONTRACTOR/SUB-VENDOR as per agreed Vendor list are not subject to approval.



12.3.2.1.1 Under normal circumstance a CONTRACTOR shall not be allowed to source any equipment/machinery from the vendors other than the Owner's approved vendor list. However, in exceptional circumstance the CONTRACTOR may suggest additional vendors meeting the following requirement for the approval of Owner.

- a. The CONTRACTOR should specify, while pre-qualifying the Vendors, that during the past 7 years the Vendor should have supplied at least two similar plant equipments or machinery. The CONTRACTOR should satisfy themselves that sufficient documentary proof is submitted by the Vendors in support of this criterion. However, in case of critical equipment, in addition to above criterion, the Vendor should also be prequalified by Process Licensor.
- b. The CONTRACTOR would be ultimately responsible for verifying the credentials, the quality of the equipment, machinery and timely supply.

12.3.2.2 The review, approval and consent by OWNER as to the agreed SUB-CONTRACTOR's/VENDOR List or as to CONTRACTOR's entering into any SUB-CONTRACT / PURCHASE ORDER shall not relieve CONTRACTOR of any of its duties, liabilities or obligations under this CONTRACT and CONTRACTOR shall be liable hereunder to the same extent as if any such Subcontract had not been entered into.

12.3.2.3 (a) CONTRACTOR shall provide to OWNER such information concerning the SUB-CONTRACTORS as OWNER may from time to time reasonably request and shall ensure that each SUB-CONTRACT contains provisions in all material respects not less stringent than the provisions of the CONTRACT and shall include terms and provisions required to be included pursuant to the CONTRACT. In the event of termination of the CONTRACT under Clause 34.0 herein, CONTRACTOR shall forthwith deliver to OWNER a copy of each SUBCONTRACT.

(b) CONTRACTOR shall supervise and direct the work of all SUB-CONTRACTORS/SUB-VENDORS and shall be responsible for all design,



	EMERGENCY DIESEL GENERATOR PACKAGE	PC-183/E-4022/P-I/S-IV	0	
	TALCHER FERTILIZERS LIMITED, ODISHA (INDIA)	DOC. NO.	REV	
	GENERAL CONDITIONS OF CONTRACT (GCC)	SHEET 22 OF 75		

engineering, procurement, manufacturing, transportation, delivery, fabrication, construction, commissioning, start-up and testing means, erection, operation, maintenance, repair, methods, techniques, sequences and procedures of, and for co-coordinating the work of SUB-CONTRACTORS/ SUB-VENDORS.

- (c) If CONTRACTOR fails to correct, or commence to correct and execute the correction with due diligence of deficient or defective work performed by any SUB-CONTRACTOR/SUB-VENDORS within reasonable time (provided it doesn't materially impact safe operation of plant), after receipt by CONTRACTOR of a notice from OWNER with respect thereto, OWNER may (but shall not be obligated to), after seven days following receipt by CONTRACTOR of an additional notice, and without prejudice to any other right or remedy take all reasonable steps to remedy such defective or deficient work at risk and cost of CONTRACTOR.
- (d) CONTRACTOR shall require all SUB-CONTRACTORS/SUB-VENDORS to perform the SUB-CONTRACTS in accordance with the relevant requirements of the CONTRACT, all APPLICABLE LAWS and APPLICABLE PERMITS, Prudent Utility Practice, Good Engineering Practices, the requirements of the NIT, and all Warranties of SUB-CONTRACTORS/SUB-VENDORS and Manufacturers and all insurance policies relating to the PLANT or the WORK.
- (e) CONTRACTOR shall be solely responsible for paying each SUB-CONTRACTOR/SUB-VENDOR and any other person to whom any amount is due from CONTRACTOR for services, equipment, construction equipment, materials or supplies otherwise related to the PLANT or the WORK. CONTRACTOR shall take all reasonable steps and actions to ensure that such services, equipment, construction equipment materials and supplies and the like have been or will be received, inspected and approved and that such services have been or will be properly performed.
- (f) In performing the duties incidental to its responsibilities hereunder, CONTRACTOR shall issue to the SUB-CONTRACTORS/SUB-VENDORS such directives and impose such restrictions as may be required to obtain such compliance herewith and with the terms of the SUB-CONTRACTS.

12.3.2.4 **SUB-CONTRACTOR/VENDOR AND MANUFACTURER WARRANTIES**



- (a) CONTRACTOR shall ensure that all equipment and other items used in connection with the performance of the WORK or incorporated in the PLANT (other than minor items) will be purchased in compliance with CONTRACT Technical Specifications and requirements in order to allow the Plant to achieve the Guarantee and Warranty as provided for in the CONTRACT, unless otherwise agreed with OWNER. Any residual warranty from sub-contractor/vendor shall be passed to the OWNER after expiry of DEFECT LIABILITY PERIOD.
- (b) Neither CONTRACTOR nor its SUB-CONTRACTORS/SUB-VENDORS nor any person under the control of either thereof, shall take any action which could release, void, impair or waive any Guarantee or Warranty on EQUIPMENT or services relating to the PROJECT or the WORK. Any residual warranty from sub-contractor/sub-vendor shall be passed to the OWNER after expiry of DEFECT LIABILITY PERIOD.

	EMERGENCY DIESEL GENERATOR PACKAGE	PC-183/E-4022/P-I/S-IV	0	
	TALCHER FERTILIZERS LIMITED, ODISHA (INDIA)	DOC. NO.	REV	
	GENERAL CONDITIONS OF CONTRACT (GCC)	SHEET 23 OF 75		

- (c) Nothing in this clause shall derogate from the obligations of CONTRACTOR to provide the Guarantees and Warranties described in and to comply with the provisions hereinabove.
- (d) CONTRACTOR shall, based on its past professional judgement enforce all guarantees and warranties provided hereunder to the fullest extent thereof till such time they are transferred to the OWNER pursuant to sub-clause (g) below.
- (e) Upon the expiration or termination of any of the guarantees or warranties provided by CONTRACTOR pursuant to the CONTRACT, the CONTRACTOR shall assign, and hereby assigns, effective as of such date, or otherwise make available, to OWNER all of CONTRACTOR's rights under all such SUBCONTRACTOR's residual Guarantees and warranty as per 12.3.2.4(a) & (b)(except to the extent CONTRACTOR has thereof provided warranty services to OWNER and is enforcing CONTRACTOR's rights with respect to such services under the applicable guarantee or warranty) and shall deliver to OWNER copies of all contracts providing for such guarantees and warranties.
- (f) CONTRACTOR, in accordance with the CONTRACT, shall require all SUB-CONTRACTORS/SUB-VENDORS to be covered by the insurance covers specified in the CONTRACT, during the time in which they are engaged in performing WORK.
- (g) CONTRACTOR shall require all SUB-CONTRACTORS/SUB-VENDORS to release and waive any and all rights of recovery against OWNER including its affiliates, subsidiaries, employees, successors, permitted assigns, insurers and underwriters) and against CONTRACTOR and all other SUB-CONTRACTORS/VENDORS which the releasing SUB-CONTRACTOR/VENDOR may otherwise have or acquire, in or from or in any way connected with any loss covered by policies of insurance maintained or required to be maintained pursuant to this the CONTRACT (other than third party liability insurance policies) or because of deductible clauses in or inadequacy of limits of any such policies of insurance. CONTRACTOR shall further require all SUB-CONTRACTORS/VENDORS to include in all policies of insurance maintained by the SUB-CONTRACTORS/VENDORS clauses providing that each underwriter shall release and waive all of its rights of recovery, under subrogation or otherwise, against OWNER, its promoters, affiliates, subsidiaries, employees, successors, permitted assigns, insurers and underwriters, and against CONTRACTOR and all other SUB-CONTRACTORS/VENDORS.
- (h) OWNER shall not be deemed by virtue of the CONTRACT to have any contractual obligation to or relationship with any SUB-CONTRACTOR/VENDOR.

12.3.2.5 **CONTRACTOR's LIABILITY FOR APPROVED SUB CONTRACTOR :**

The review by and approval and consent of OWNER as to the approved SUB-CONTRACTORS list or as to CONTRACTOR entering into any SUB-CONTRACT with any approved SUB-CONTRACTOR or as to any WORK done or supply made or services provided by any such approved SUB-CONTRACTOR/SUB-VENDOR shall not relieve CONTRACTOR of any of his duties, liabilities or obligations under this CONTRACT, and CONTRACTOR shall be liable hereunder to the same extent as if any such SUB-CONTRACT had not been entered into. Any inspection review or approval by OWNER permitted under this CONTRACT of any portion of the work or of any work in progress by CONTRACTOR or SUB-CONTRACTORS/SUB-VENDORS shall not relieve CONTRACTOR of any duties, liabilities or obligations under this CONTRACT.

	EMERGENCY DIESEL GENERATOR PACKAGE	PC-183/E-4022/P-I/S-IV	0	
	TALCHER FERTILIZERS LIMITED, ODISHA (INDIA)	DOC. NO.	REV	
	GENERAL CONDITIONS OF CONTRACT (GCC)	SHEET 24 OF 75		

12.3.3 All WORK performed or EQUIPMENT supplied by SUB-CONTRACTOR/ SUB-VENDOR shall be pursuant to an appropriate SUB-CONTRACT, PURCHASE ORDER or similar agreement which shall, as appropriate, contain provisions that:

12.3.3.1 Preserve and protect all the rights of OWNER here under for WORK to be performed or EQUIPMENT to be supplied under PURCHASE ORDER or SUB-CONTRACT.

12.3.3.2 Require that such WORK be performed or EQUIPMENT be fabricated, supplied and installed in strict accordance with the applicable requirements of this CONTRACT.

12.3.3.3 Obligate such SUB-CONTRACTOR/SUB-VENDOR to consent to and be bound by those obligations under this CONTRACT which by their terms are intended to also obligate such SUB-CONTRACTOR/VENDOR, including the provisions of this Clause.

12.3.3.4 Require such SUB-CONTRACTOR/SUB-VENDOR to provide and maintain adequate insurance consistent with requirements for companies of similar size and performing similar services. Permit the assignment of such SUB-CONTRACT/PURCHASE ORDER by CONTRACTOR to OWNER.

12.3.3 **CONTRACTOR RESPONSIBLE FOR WORK**

12.3.4.1 CONTRACTOR is responsible for WORK, and that the performance thereof conforms in all respects to the requirements of this CONTRACT, regardless of any failure of any SUB-CONTRACTOR/VENDOR to perform or any disagreement between any SUB-CONTRACTOR/VENDOR or between any SUB-CONTRACTOR/VENDOR and CONTRACTOR. CONTRACTOR shall furnish such information relative to its SUB-CONTRACTOR/VENDOR (including copies of unpaid SUB-CONTRACT or PURCHASE ORDER) as OWNER may request.

12.3.5 **DAMAGES**

It is within the discretion of Contractor, that CONTRACTOR shall agree to hold all SUB-CONTRACTOR/VENDOR, including all persons directly or indirectly employed by them, responsible for any damages due to breach of CONTRACT caused by them or any negligent act and to diligently endeavour to effect recoveries in such damages..



13.0 **STANDARDS**

The goods and services supplied under this CONTRACT shall conform to the standards mentioned in the technical specifications and when no applicable standard is mentioned, CONTRACTOR to follow best engineering practices.

14.0 **INSTRUCTIONS, DIRECTIONS**

14.1 The materials described in CONTRACT are to be supplied according to the standards, data sheets, tables, specifications and drawings attached hereto and/or enclosed with the CONTRACT itself and according to all conditions both general and specific enclosed with the CONTRACT, unless any or all of them shall have been modified or cancelled in writing as a whole or in part.

A) All instructions and orders to CONTRACTOR shall, except what is herein provided, be given by OWNER/ CONSULTANT.

	EMERGENCY DIESEL GENERATOR PACKAGE	PC-183/E-4022/P-I/S-IV	0	
	TALCHER FERTILIZERS LIMITED, ODISHA (INDIA)	DOC. NO.	REV	
	GENERAL CONDITIONS OF CONTRACT (GCC)	SHEET 25 OF 75		

- B) All the work shall be carried out under the direction of OWNER and according to the CONTRACT requirements.
- C) All communications including technical/ commercial clarifications and/ or comments shall bear reference to the CONTRACT.
- D) Invoice for payment against CONTRACT shall be addressed to OWNER.
- E) The CONTRACT/DLOA number shall be shown on all invoices, communications, packing lists, containers and bills of lading etc.

15.0 DELETED



16.0 TIME SCHEDULE AND PROGRESS REPORTING

16.1 Time Schedule Network/Bar Chart

- 16.1.1 Together with the CONTRACT confirmation, CONTRACTOR shall submit to OWNER, his time schedule regarding the documentation, supply and manufacture of equipment and materials as well as information of his SUBCONTRACTS to be placed with third parties, including the dates on which CONTRACTOR intends to issue such SUB CONTRACTS. A complete activity-wise time schedule shall be furnished by the CONTRACTOR within 30 days from the date of issuance of FOA.
- 16.1.2 The time schedule will be in the form of a network or a bar chart clearly indicating all main or key events regarding documentation, supply of raw materials, manufacturing, testing, delivery, erection & commissioning.
- 16.1.3 The original issue and subsequent revisions of CONTRACTOR's time schedule and/or SUB-CONTRACTORS' time schedules shall be sent in two copies to OWNER.
- 16.1.4 The time schedule network/bar chart shall be updated at least every month using the latest 'Project Management software', i.e. Primavera (latest version), acceptable to the OWNER.

16.2 PROGRESS TREND CHART/MONTHLY REPORT

- 16.2.1 CONTRACTOR shall report monthly to OWNER of the execution of CONTRACT and achievement of targets set out in time bar chart, in a monthly progress report on 7th working day of every Month.
- 16.2.2 The progress will be expressed in percentages shown in the progress trend chart.
- 16.2.3 The first issue of the progress trend chart will be forwarded together with the time bar chart along with CONTRACT confirmation.
- 16.2.4 The monthly reporting will bear the updating of the progress trend chart.
- 16.2.5 OWNER or his representatives shall have the right to inspect CONTRACTOR's premises to evaluate the actual progress of work on the basis of CONTRACTOR's time schedule documentation.
- 16.2.6 Irrespective of such inspection, CONTRACTOR shall advise OWNER at the earliest possible date of any anticipated delay in the programme indicating the reasons thereof and corrective measures proposed thereto.
- 16.2.7 The time for completion and phased time schedule shall be subject to and in accordance with the provision of Sub-Clauses 16.2.8 and 16.2.9 below.
- 16.2.8 Neither OWNER nor CONTRACTOR shall be considered in default in performance of their obligations if such performance is prevented or delayed by FORCE MAJEURE conditions as stated in Clause 35.0.

	EMERGENCY DIESEL GENERATOR PACKAGE	PC-183/E-4022/P-I/S-IV	0	
	TALCHER FERTILIZERS LIMITED, ODISHA (INDIA)	DOC. NO.	REV	
	GENERAL CONDITIONS OF CONTRACT (GCC)	SHEET 26 OF 75		

16.2.9 Should the CONTRACTOR's preparation for the commencement of the work or any portion of it or its subsequent rate of progress be from any cause whatsoever, so slow and reasons for delay solely attributed to the contractor, the CONTRACTOR will not be able to complete the work or any portion thereof within the stipulated time for completion, the provisions of Clause 34 of GCC shall apply.

16.2.10 In the event that the delay is caused by a delay in the delivery of a sub-contracted EQUIPMENT, CONTRACTOR shall be responsible for such delay and submit details together with copies of the appropriate orders and agreements with SUB-CONTRACTOR/vendor.



17.0 CONTRACTOR TO INFORM HIMSELF FULLY

The CONTRACTOR in fixing his rate shall for all purpose whatsoever reason may be, deemed to have himself independently obtained all necessary information for the purpose of preparing his offer and his offer as accepted shall be deemed to have taken into account all contingencies as may arise due to such information or lack of same. The correctness of the details, given in the Tender Document to help the CONTRACTOR to make up the tender is not guaranteed.

The CONTRACTOR shall be deemed to have examined the CONTRACT DOCUMENTS, to have generally obtained his own information in all matters whatsoever that might affect the carrying out of the works at the scheduled rates and to have satisfied himself to the sufficiency of his offer. Any error in description of quantity or omission there from shall not vitiate the CONTRACT or release the CONTRACTOR from executing the work comprised in the CONTRACT according to DRAWINGS and SPECIFICATIONS at the scheduled rates. CONTRACTOR is deemed to have known the scope, nature and magnitude of the WORKS and the requirements of materials and labour involved etc., and as to what all works he has to complete in accordance with the CONTRACT documents whatever be the defects, omissions or errors that may be found in the DOCUMENTS. The CONTRACTOR shall be deemed to have visited surroundings, to have satisfied himself to the nature of all existing structures, if any, and also as to the nature and the conditions of the Railways, Roads, Bridges and Culverts, means of transport and communication, whether by land, water or air, and as to possible interruptions thereto and the access and egress from the site, to have made enquiries, examined and satisfied himself as to the sites for obtaining sand, stones, bricks and other materials, the sites for disposal of surplus materials, the available accommodation as to whatever required, depots and such other buildings as may be necessary for executing and completing the works, to have made local independent enquiries as to the sub-soil, subsoil water and variations thereof, storms, prevailing winds, climatic conditions and all other similar matters effecting these works. He is deemed to have acquainted himself as to his liability of payment of Government Taxes, Customs duty and other charges, levies etc.

Any neglect or omission or failure on the part of the CONTRACTOR in obtaining necessary and reliable information upon the foregoing or any other matters affecting the CONTRACT shall not relieve him from any risks or liabilities or the entire responsibility from completion of the works at the scheduled rates and times in strict accordance with the CONTRACT.

It is, therefore, expected that should the CONTRACTOR have any doubt as to the meaning of any portion of the CONTRACT DOCUMENT he shall set forth the particulars thereof in writing to OWNER in duplicate, before submission of tender. The

	EMERGENCY DIESEL GENERATOR PACKAGE		PC-183/E-4022/P-I/S-IV	0	
	TALCHER FERTILIZERS LIMITED, ODISHA (INDIA)		DOC. NO.	REV	
	GENERAL CONDITIONS OF CONTRACT (GCC)		SHEET 27 OF 75		

OWNER may provide such clarification as may be necessary in writing to CONTRACT, such clarifications as provided by OWNER shall form part of CONTRACT DOCUMENTS.

No verbal agreement or inference from conversation with any effect or employee of the OWNER before, during or after the execution of the CONTRACT agreement shall in any way affect or modify and of the terms or obligations herein contained.

Any change in layout due to site conditions or technological requirement shall be binding on the CONTRACTOR and no extra claim on this account shall be entertained

18.0 SUITABILITY OF PLANT FOR INTENDED PURPOSE

18.1 The CONTRACTOR warrants that the PLANT will be suitable in all respects for the purpose mentioned or inherent in the specification and as defined in the CONTRACT.

18.2 Without limiting the generality of the foregoing clause, the CONTRACTOR shall ensure before complying with any direction, that compliance by the CONTRACTOR with that direction will not render the plant unsuitable in any respect for the aforesaid purposes or otherwise prevent the CONTRACTOR from carrying out the CONTRACT in accordance with the terms thereof.



18.3 The CONTRACTOR shall give notice to the OWNER within Twenty one (21) days after receipt of any requirement or direction which he considers will render the plant unsuitable in any respect or is not in accordance with the meaning and intent of the CONTRACT OR otherwise prevent the CONTRACTOR from carrying out the CONTRACT or as aforesaid and submit to the OWNER a proposal or proposals for modifying the requirement or direction. Failure to file an objection within the allotted time will be considered as acceptance of the OWNER's decision and the decision shall become final and binding.

19.0 FEES FOR ROYALTIES AND PATENT RIGHTS (WHEREVER APPLICABLE)

19.1 Payment Due to be Included in CONTRACT PRICE

19.1.1 All payments for royalties, patent rights and fees due to or payable for or in connection with any matter or thing used or required to be used in performance of the CONTRACT or to be supplied under the CONTRACT, whether payable in one sum or by instalments or otherwise, shall be included by the CONTRACTOR in the prices named in the CONTRACT and shall be paid by CONTRACTOR to whom such payments may be due or payable.

19.1.2 The CONTRACTOR, if licensed under any patent covering equipment, machinery, materials or compositions of matter to be used or supplied or methods and process to be practiced or employed in the performance of this CONTRACT, agrees to pay all royalties and license fees which may be due with respect thereto. If any equipment, machinery, materials, composition of matters, be used or supplied or methods and processes to be practiced or employed in the performance of this CONTRACT, is covered by a patent under which the CONTRACTOR is not licensed then the CONTRACTOR before supplying or using the equipment, machinery materials,

	EMERGENCY DIESEL GENERATOR PACKAGE	PC-183/E-4022/P-I/S-IV	0	
	TALCHER FERTILIZERS LIMITED, ODISHA (INDIA)	DOC. NO.	REV	
	GENERAL CONDITIONS OF CONTRACT (GCC)	SHEET 28 OF 75		

composition method or processes shall obtain such licenses and pay such royalties and license fees as may be necessary for performance of this CONTRACT. In the event the CONTRACTOR fails to pay any such royalty or obtain any such license, any suit for infringement of such patents which is brought against the CONTRACTOR or the OWNER as a result such failure will be defended by the CONTRACTOR at his own expense and the CONTRACTOR will pay any damages and costs awarded in such suit. The CONTRACTOR shall promptly notify the OWNER if the CONTRACTOR has acquired the knowledge of any plant under which a suit for infringement could be reasonably brought because of the use by the OWNER of any equipment, machinery, materials, process, methods to be supplied hereunder. The CONTRACTOR agrees to and does hereby grant to OWNER, together with the right to extend the same to any of the subsidiaries of the OWNER as irrevocable, royalty free license to use in any country, any invention made by the CONTRACTOR or his employee in or as result of the performance of the WORK under the CONTRACT.

19.2 **Payment to the CONTRACTOR by OWNER**

19.2.1 Final payment to the CONTRACTOR by the OWNER will not be made while any such suit or claim remains unsettled. In the event any apparatus or equipment or any part thereof furnished by the CONTRACTOR is in such suit or proceedings, held to constitute infringement, and its use is enjoined, the CONTRACTOR shall, at his option, and at his own expense, either procure for the OWNER the right to continue use of the said apparatus, equipment or part thereof, replace it with non-infringing apparatus or equipment or modify it, so that it becomes non-infringing.

20.0 **ACTS OF PARLIAMENT, LOCAL AND OTHER AUTHORITIES REGULATIONS AND BYE-LAWS**

20.1 **Complying With Regulations**



20.1.1 Throughout the execution of the WORK, the CONTRACTOR shall comply with the requirements of all applicable laws and regulations, bye-laws or orders made there under and to the requirements of public, municipal and other authorities in any way affecting or applicable to the work. The OWNER shall, when requested by the CONTRACTOR, give all reasonable assistance to the CONTRACTOR in obtaining information concerning local conditions.

20.1.2 Before making any departure from the specification or drawings which may be necessary to conform to such requirements, the CONTRACTOR shall give the OWNER written notice specifying the departure proposed to be made and the reason for making it and applying for instructions thereon. If the CONTRACTOR does not receive such instructions within thirty (30) days, he shall conform to those requirements and inform the OWNER accordingly.

20.2 **Notices and Fees**

The CONTRACTOR shall give all notices required to be given by the Acts, regulations, bye-laws, orders and requirements referred to in sub-clause 20.1 of this clause and shall pay all fees payable in connection herewith.

Any additional fee becoming applicable due to any change of Acts, regulations, bye-laws, orders and requirements after date of submission of FINAL PROPOSAL shall be borne by OWNER in accordance with SCC clause 3.0.

	EMERGENCY DIESEL GENERATOR PACKAGE	PC-183/E-4022/P-I/S-IV	0	
	TALCHER FERTILIZERS LIMITED, ODISHA (INDIA)	DOC. NO.	REV	
	GENERAL CONDITIONS OF CONTRACT (GCC)	SHEET 29 OF 75		

21.0 TIME- PROJECT SCHEDULE

21.1 Without prejudice to anything contained in the CONTRACT, the time and the date of completion of the works as stipulated in the CONTRACT shall be deemed to be of the utmost importance. The CONTRACTOR shall so organise his resources and perform his work so as to complete it within the completion period.

21.2 The contractor shall submit the Primavera Level 4 schedule within thirty (30) days from date of issuance of FOA.

The Primavera Level 4 schedule shall be for OWNER's review and be based on a level 2 schedule as attachment to the CONTRACT. Such level 2 schedule shall show the execution periods for (i) engineering, (ii) procurement & delivery of equipment and materials, (iii) & erection (iv) Mechanical Completion and (v) commissioning, testing.



CONTRACTOR shall be contractually obliged to issue a Primavera Level 4 schedule provided that such schedule shall not (i) accelerate the OWNER obligations (to be agreed upon prior to Contract award) (ii) change the GUARANTEED COMPLETION DATE.

21.3 The above Primavera Level 4 schedule shall be periodically reviewed and reports shall be submitted by the CONTRACTOR as directed by the OWNER.

22.0 CONTRACT PRICE

22.1 CONTRACT PRICE is inclusive of the cost/fees of CONTRACTOR's obligations as given below briefly but not limited to the following:

- a. Detailed Engineering
- b. Basic Engineering
- c. Supply of all, Equipment, Bulk Materials, Chemicals & Lubricants and consumables
- d. 2 months vendor supervision assistance.
- e. Supply of spares
- f. All applicable taxes and duties including GST, Indian Income Tax, etc.
- g. Forwarding charges, if applicable
- h. Freight up to SITE including taxes
- i. Unloading, storage at Site, Site Assembly, Erection, Pre-Commissioning and Commissioning until Preliminary Acceptance of Plant.
- j. Insurance
- k. Inspection and expediting charges
- l. Project management and overheads,
- m. Guarantee test runs and handing over of PLANT to OWNER.
- n. All other costs, expenses and outgoings of the CONTRACTOR not otherwise expressly set forth herein necessary, required or incidental to the full, complete and proper performance and discharge of the CONTRACTOR's obligations under and in accordance with the CONTRACT including completion of the PLANT in all respects and overheads of the CONTRACTOR.

	EMERGENCY DIESEL GENERATOR PACKAGE	PC-183/E-4022/P-I/S-IV	0	
	TALCHER FERTILIZERS LIMITED, ODISHA (INDIA)	DOC. NO.	REV	
	GENERAL CONDITIONS OF CONTRACT (GCC)	SHEET 30 OF 75		

22.2 OWNER shall pay to CONTRACTOR a lump-sum fixed CONTRACT PRICE for the due and faithful performance of CONTRACTOR's obligations under the CONTRACT. CONTRACT PRICE provided for in this Clause covers entire consideration payable to CONTRACTOR for all obligations of CONTRACTOR.

22.3 CONTRACT PRICE is inclusive of cost of all travel, accommodation, living costs and all other expenses of management and personnel of CONTRACTOR, SUB-CONTRACTOR, VENDOR for travelling to and from plant SITE and other places/countries as may be necessary for the proper performance of CONTRACTOR's responsibilities under CONTRACT and shall also include all costs and expenses incurred in attending such meetings in connection with CONTRACT as OWNER may reasonably require.

22.4 CONTRACT PRICE is inclusive of cost of all CONTRACTOR's EQUIPMENT, materials, services, etc. required to complete WORK under CONTRACT.

22.5 All taxes, duties, licence fees and other such levies as may be applied to the CONTRACT, including Custom Duty, all applicable taxes & duties under GST, Corporate income tax in respect of the performance of the CONTRACT as well as income tax on the personnel deputed by the CONTRACTOR to India in connection with the CONTRACT shall be to the account of the CONTRACTOR.

23.0 DEDUCTIONS FROM CONTRACT PRICE

All costs, damages or expenses which the OWNER may have paid for which, under the CONTRACT, the CONTRACTOR is liable, will be claimed by the OWNER. All such claims shall be billed by the OWNER to the CONTRACTOR regularly as and when they fall due. Such claims shall be paid by the CONTRACTOR within fifteen days of the receipt of the corresponding bills and if not paid by the CONTRACTOR within the said period, the OWNER may then deduct the amount from any bill due or becoming due by him to the CONTRACTOR under the CONTRACT or may be recovered by action of law or otherwise, if the CONTRACTOR fails to satisfy the OWNER of such claims.



24.0 Deleted

25.0 Deleted

26.0 TAXES APPLICABLE TO CONTRACTOR'S MANPOWER, TURNOVER, EQUIPMENT, ETC.

26.1 The CONTRACTOR shall be liable and pay all taxes, duties, levies, lawfully assessed against the OWNER or the CONTRACTOR in pursuance of the CONTRACT. The CONTRACTOR shall be solely responsible for all taxes that may be levied on the CONTRACTOR's turnover & profit or on the earnings of any of his employees or personnel engaged by him and shall hold the OWNER indemnified and harmless against any claims that may be made against the OWNER in this behalf. The OWNER does not undertake any responsibility whatsoever regarding any taxes levied on CONTRACTOR and/or his personnel by Centre/State/Local Authorities. The Taxes shall be deducted where the said provisions shall be applicable and/or obligatory on the part of the OWNER.

26.2 For CONTRACTORS who have to bring equipment and material from outside Odisha, will have to obtain necessary registrations and take appropriate steps as required under Odisha State Laws. Further, form 38 / E-Waybill / Road Permit shall be issued by the

	EMERGENCY DIESEL GENERATOR PACKAGE	PC-183/E-4022/P-I/S-IV	0	
	TALCHER FERTILIZERS LIMITED, ODISHA (INDIA)	DOC. NO.	REV	
	GENERAL CONDITIONS OF CONTRACT (GCC)	SHEET 31 OF 75		

CONTRACTOR in such cases, wherever applicable. Necessary statutory registrations as required shall be done by CONTRACTOR in this regard.



- 26.3 CONTRACTOR is responsible for obtaining Customs clearance permit for temporary importation on re-export basis of CONTRACTOR'S EQUIPMENT, tools and tackles etc. If any duties, taxes and expenses are payable on this, the same will be to CONTRACTOR'S account.

27.0 PACKING, FORWARDING AND SHIPMENT

- 27.1 The CONTRACTOR shall give complete despatch information concerning the weight, size, content of each package including any other information the OWNER may require.
- 27.2 The CONTRACTOR, wherever applicable shall after proper painting, pack and crate all equipment in such a manner as to protect it from deterioration and damage during rail and road transportation to the site and storage at the site till the time of erection. The CONTRACTOR shall be held responsible for all damages due to improper packing.
- 27.3 The CONTRACTOR shall notify the OWNER of the date of each shipment from his works, and the expected date for arrival at the site for the information of the OWNER. The CONTRACTOR will be responsible for arranging any requirement of over-dimensional, special rail/road wagon/trailer for transporting.
- 27.4 The CONTRACTOR shall also give all shipping information concerning the weight, size and content of each package including any other information the OWNER may require. The size of the largest packages being considered as over dimensional consignments shall be as per the latest guidelines.
- 27.5 The CONTRACTOR shall prepare detailed packing lists of all packages and containers, bundles and loose materials forming each and every consignment despatched to the site. The CONTRACTOR shall further be responsible for making all necessary arrangements for loading, unloading and other handling, right from works till the SITE and also till the EQUIPMENT is erected, tested and commissioned. The CONTRACTOR shall be solely responsible for proper storage and preservation of all equipments & machineries etc.

28.0 INSURANCE

- 28.1 CONTRACTOR shall take in the joint name of CONTRACTOR and OWNER comprehensive transit insurance for imported and indigenous goods. Transit-cum-Storage-Erection insurance or its equivalents and third party liability insurance policies shall be taken with reputed underwriters to cover ALL RISK whatsoever during the whole period starting with dispatch of GOODS from CONTRACTOR'S warehouses/ Exworks in foreign country to CIF port of shipment for imported GOODS and EXW at Contractor's works for indigenous GOODS and shall further cover for performing services in India for transportation, loading, unloading, assembly, erection, testing COMMISSIONING of PLANT till care and custody is transferred to OWNER.
- 28.1.1 Contractor shall take Public Liability (Third Party) Insurance cover of 10% of TOTAL CONTRACT PRICE.
- 28.1.2 Contractor shall ensure that in addition to "Erection All risk policy", the coverage in respect of workmen compensation, ESI/Health Insurance, Professional Indemnity (with the amount of minimum excess) has been appropriately taken.

	EMERGENCY DIESEL GENERATOR PACKAGE	PC-183/E-4022/P-I/S-IV	0	
	TALCHER FERTILIZERS LIMITED, ODISHA (INDIA)	DOC. NO.	REV	
	GENERAL CONDITIONS OF CONTRACT (GCC)	SHEET 32 OF 75		

28.2 CONTRACTOR shall be fully responsible for pursuing and settling all claims under the underwriters. In the event of accident, injury, damage or loss likely to form a claim under the above insurance policies, CONTRACTOR shall, as quickly as possible submit the insurance claims by underwriters under intimation to OWNER. CONTRACTOR shall also keep OWNER fully informed about progress of each such case. CONTRACTOR shall undertake immediate repair and replacement of the equipment lost in transit, storage, assembly, erection and COMMISSIONING of PLANT pending settlement of claim thereafter by the underwriters.

28.3 The CONTRACTOR at his cost shall arrange, secure and maintain all insurance as may be pertinent to the works and obligatory in terms of law to protect his interest and interest of OWNER in the project, against all perils detailed herein. The Form and the limit of such insurance as defined herein together with the under-writer in each case shall be acceptable to the OWNER and OWNER's acceptance shall not be unreasonably withheld. However, irrespective of such acceptance, the responsibility to maintain adequate insurance coverage at all times including third party liability during the period of contract shall be as of CONTRACTOR alone. The contractor's failure in this regard shall not relieve him of any of his contractual responsibilities and obligations. The insurance covers to be taken by the CONTRACTOR shall be in the joint names of OWNER and the CONTRACTOR. The CONTRACTOR shall, however, be authorised to deal directly with insurance company or companies and shall be responsible in regard to maintenance of all insurance covers.

28.4 All insurance other than marine insurance for transportation outside India is to be covered from IRDA approved insurance company registered in India. There should be a single cover for marine cum inland transit, storage and erection upto PRELIMINARY ACCEPTANCE OF PLANT.

However adequacy, credibility and maintenance of Insurance policies is sole responsibility of CONTRACTOR and CONTRACTOR shall keep the OWNER indemnified against any such failure.



All insurance covers shall be taken by CONTRACTOR in joint name of CONTRACTOR and OWNER.

Alternatively, the CONTRACTOR has the option to take separate Insurances as

1. Marine Cargo Insurance for transit of all imported and indigenous goods from Ex -Works at CONTRACTOR'S/SUB-CONTRACTOR's works to Site.
2. Erection and All Risk (EAR) Insurance
3. Third Party Liability Insurance

Marine Cargo Insurance and Third Party Liability Insurance can be a part of Global Policy of the CONTRACTOR. However certificate of endorsement in favour of OWNER shall be provided by the CONTRACTOR from the insurance company. These two global policies of Marine Cargo Insurance and Third Party Liability Insurance shall be counter guaranteed by Indian Insurance Company. However, Erection and All Risk (EAR) is to be covered from Insurance Company registered in India and shall be separate dedicated policies for OWNER.

28.5 Any loss or damage to the equipment during handling, transportation, storage, erection, putting the equipment into satisfactory operation and all activities to be performed till the successful completion of trial operation of the plant shall be to the account of the CONTRACTOR. The CONTRACTOR shall be responsible for reference of all claims and

	EMERGENCY DIESEL GENERATOR PACKAGE	PC-183/E-4022/P-I/S-IV	0	
	TALCHER FERTILIZERS LIMITED, ODISHA (INDIA)	DOC. NO.	REV	
	GENERAL CONDITIONS OF CONTRACT (GCC)	SHEET 33 OF 75		

make good the damages or loss by way of repairs and/or replacement of the equipment, damaged or lost. The CONTRACTOR shall provide the OWNER with copies of all insurance policies and documents taken out by him in pursuance of the CONTRACT. Such copies of documents shall be submitted to the OWNER immediately after such insurance coverage. However, if Marine cargo insurance or Third party liability Insurance is a part of their global policies; insurer certificate (including the main terms of policy) shall be submitted by CONTRACTOR. The CONTRACTOR shall also inform the OWNER in the writing at least thirty (30) days in advance regarding the expiry/ cancellation and/or change in any of such documents and ensure revalidation, renewal etc. as may be necessary well in time. However adequacy, credibility and maintenance of Insurance policies is the sole responsibility of CONTRACTOR and CONTRACTOR shall keep the OWNER indemnified against any such failure.

28.6 The perils required to be covered under the insurance shall include, but not be limited to fire and allied risks, miscellaneous accidents (erection risks) workman compensation risks, loss or damage in transit, theft, pilferage, riot and strikes and malicious damages, civil commotion, weather conditions, accidents of all kinds, war risks (during ocean transportation only) etc. The scope of such insurance shall be adequate to cover the replacement/reinstatement cost of the equipment for all risks till the equipment is taken over by the OWNER. The insurance policies to be taken should be on replacement value basis and/or incorporating escalation clause. Notwithstanding the extent of insurance cover and the amount of claim available from the underwriters, the CONTRACTOR shall be liable to make good the full replacement/rectification of all equipment/materials and to ensure their availability as per project requirements without additional financial liability to the OWNER.



The workman compensation policy taken by the SUB-CONTRACTOR of the CONTRACTOR shall be passed on to the OWNER.

28.7 CONTRACTOR shall at its own cost and initiative at all times upto the successful completion of PRELIMINARY ACCEPTANCE, take out and maintain all insurable liability, including but not limited to third Party insurance and liabilities under the Motor Vehicles Act, Worker's Compensation Act, Fatal Accidents Act, Personal Injuries Insurance Act, Emergency Risk Insurance Act and/or other Industrial Legislation from time to time in force in India with Insurance Company(ies), such policy(ies) shall not be of lesser limits hereunder specified with reference to the matters hereunder specified, namely:

- Workmen's Compensation Insurance to the limit to which compensation may be payable under Indian laws.

28.8 All cost on account of insurance liabilities covered under the CONTRACT will be to the CONTRACTOR'S account and will be included in the CONTRACT PRICE. The CONTRACTOR, while arranging the insurance, shall ensure to obtain all discounts on premium, which may be available for higher volume or for reason of financing arrangement of the project.

28.9 Irrespective of single or separate insurances, the CONTRACTOR shall take the same in the joint name of OWNER and CONTRACTOR, with OWNER as Primary Beneficiary and CONTRACTOR as Joint Beneficiary, to cover all risk including marine cum erection insurance (MCE), workmen compensation / Employees State Insurance (ESI) under ESI Act 1948 for Contractor's personnel, fire risk policy etc. till handing over of PLANT to OWNER duly commissioned and tested. However, for CONTRACTOR's EQUIPMENT, CONTRACTOR can be the sole beneficiary.

	EMERGENCY DIESEL GENERATOR PACKAGE	PC-183/E-4022/P-I/S-IV	0	
	TALCHER FERTILIZERS LIMITED, ODISHA (INDIA)	DOC. NO.	REV	
	GENERAL CONDITIONS OF CONTRACT (GCC)	SHEET 34 OF 75		

Further, OWNER shall have the first right over the claim amount for all insurance claims, where owner has made part or full payment to the contractor.

However, OWNER should have first right over the claim amount in case payment for the "equipment damaged" has already been paid to the CONTRACTOR

28.10 The CONTRACTOR shall be fully responsible for pursuing and settling all claims with the underwriters within stipulated timelines. In the event of accident, injury, damage or loss likely to form a claim under the above insurance policies, the CONTRACTOR shall as quickly as possible but not later than the claim period submit such details as are necessary for settling such claims by underwriters and shall also provide information and assistance necessary to settle the claim. The CONTRACTOR shall also keep OWNER fully informed about progress of each such case.

28.11 All charges on account of insurance shall be included in TOTAL LSTK PRICE/TOTAL CONTRACT PRICE.

29.0 Deleted

30.0 LIABILITY FOR ACCIDENTS AND DAMAGES

30.1 Under the CONTRACT, the CONTRACTOR shall be responsible for loss or damage to the PLANT and provide new equipment and machineries in lieu of equipment/machineries lost/damaged beyond repairs, free of cost until the PLANT is handed over after successful completion of performance guarantee test run.



Notwithstanding the provisions in the CONTRACT, the CONTRACTOR shall not be responsible for any loss or damage to the PLANT or any part thereof if and to the extent that such loss or damage is not covered by insurance coverage such as War risk, provided the same is general exclusion of the policy of the EAR insurance. War Risks shall mean any of the following events occurring within India:

War , hostilities, warlike operations (whether a state of war be declared or not), invasion, act of foreign enemy, civil war, rebellion, terrorism, revolution, insurrection, mutiny, usurpation of civil or military government, conspiracy, riot, civil commotion, mine, bomb, shell, grenade or other projectile, missile, munitions or explosive of war.

30.2 The CONTRACTOR shall indemnify the OWNER in respect of all damage or injury to any person or to any property (other than property forming part of the Work) and against all actions, suits, claims, demands, costs, charges and expenses arising in connection therewith which shall have been occasioned by the negligence of the CONTRACTOR or any SUB-CONTRACTOR, or by defective design (other than a design made, furnished or specified by the OWNER and which the CONTRACTOR has disclaimed responsibility in writing within a reasonable time after receipt of the OWNER's instructions) material or workmanship, any breach of the CONTRACTOR's obligations.

31.0 Deleted

32.0 Deleted

	EMERGENCY DIESEL GENERATOR PACKAGE	PC-183/E-4022/P-I/S-IV	0	
	TALCHER FERTILIZERS LIMITED, ODISHA (INDIA)	DOC. NO.	REV	
	GENERAL CONDITIONS OF CONTRACT (GCC)	SHEET 35 OF 75		

33.0 TIME EXTENSION OF CONTRACT

- 33.1 The CONTRACTOR shall promptly notify the ENGINEER-IN-CHARGE any event or conditions which might delay the completion of erection work in accordance with the approved schedule and the steps being taken to remedy such situation.
- 33.2 If the Work is delayed at any time in the commencement or during the progress of the WORK by any act, delay or neglect solely attributable to OWNER or his employees, or by any other contractor utilised by the OWNER or by FORCE MAJEURE conditions, the time of completion shall be extended by OWNER (without levy of Mutually Agreed Damages) in writing for a reasonable period as may be mutually agreed upon, at the time of closure of contract. The CONTRACTOR shall, immediately on occurrence of such special circumstances but not later than 14 working days, bring to the knowledge of OWNER through written application for any such delay as mentioned above.
- 33.3 OWNER shall have the right to suspend the WORK in whole or in part for such time as may be necessary in order that WORKS shall be well and properly executed. In such events, suitable extension of time shall be granted to CONTRACTOR. However, should the cumulative period of suspension exceed 45 days during the scheduled duration of CONTRACT, the CONTRACTOR shall be compensated as mutually agreed in addition to extension of time, provided the suspension is caused due to reasons not attributable to CONTRACTOR.

34.0 TERMINATION OF CONTRACT

34.1 Termination due to Legal Incapacity

If the CONTRACTOR goes into liquidation or has an administrator order made against him or carries on his business or any part of it under an administrator or receiver or manager for the benefit of the creditors or any of them, without prejudice to any other rights or remedies, the OWNER may forthwith by notice in writing terminate the CONTRACT.

34.2 Termination due to Default by CONTRACTOR



34.2.1 If the CONTRACTOR is in default in that he:

- (a) Neglects to execute the work or part of the work; or
- (b) without reasonable cause, suspends or abandons the carrying out the works, either partly or wholly, before their completion; or
- (c) Fails to proceed regularly and diligently with the works; or
- (d) Defaults in the performance or observance of any conditions or terms of the CONTRACT or neglects to carry out any order, instruction, direction or determination which the OWNER is empowered to give or make under the CONTRACT and which is given or made in writing to the CONTRACTOR,

then, without prejudice to any other rights or remedies which the OWNER may possess, the OWNER may, by notice in writing (which shall specify with reasonable particularity the neglect, default or refusal on the part of the CONTRACTOR) require the CONTRACTOR:

i) to put forward his proposals for

- a) Rectifying such neglect, default or refusal as the case may be and
- b) Commence and diligently pursue the rectification of the default.



	EMERGENCY DIESEL GENERATOR PACKAGE		PC-183/E-4022/P-I/S-IV	0	
	TALCHER FERTILIZERS LIMITED, ODISHA (INDIA)		DOC. NO.	REV	
	GENERAL CONDITIONS OF CONTRACT (GCC)		SHEET 36 OF 75		

34.2.2 If within 30 days after the posting of the notice addressed to the CONTRACTOR, the CONTRACTOR fails to comply with the notice or if in the opinion of the OWNER, the CONTRACTOR's reasons or proposals are not satisfactory, then the OWNER, without prejudice to any other rights that he may have under the CONTRACT against the CONTRACTOR, may either:

- a) DETERMINE THE CONTRACT in which event the CONTRACT shall stand terminated and shall cease to be in force and effect on and from the date appointed by the OWNER on that behalf, whereupon the CONTRACTOR shall stop forthwith any of the CONTRACTOR's work then in progress, except such WORK as the OWNER may, in writing, require to be done to safeguard any property or WORK, or installations from damage, and the OWNER, for its part, may take over the work remaining unfinished by the CONTRACTOR and complete the same through a fresh contractor or by other means, at the risk and cost of the CONTRACTOR, and any of his sureties if any, shall be liable to the OWNER for any excess cost occasioned by such work having to be so taken over and completed by the OWNER over and above the cost at the rates specified in the schedule of quantities and rate/prices.
- b) WITHOUT DETERMINING THE CONTRACT, take over the work of the CONTRACTOR or any part thereof and complete the same through a fresh contractor or by other means at the risk and cost of the CONTRACTOR. The CONTRACTOR and any of his sureties are liable to the OWNER for any excess cost over and above the cost at the rates specified in the Schedule of Quantities/ rates, occasioned by such works having been taken over and completed by the OWNER.

In such events of Clause 34.2.2 (a) or (b) above.

- (i) The whole or part of the Contract Performance Security furnished by the CONTRACTOR is liable to be forfeited without prejudice to the right of the OWNER to recover from the CONTRACTOR the excess cost referred to in the sub-clause aforesaid, the OWNER shall also have the right of taking possession and utilising in completing the works or any part thereof, such as materials equipment and plants available at work site belonging to the CONTRACTOR as may be necessary and the CONTRACTOR shall not be entitled for any compensation for use or damage to such materials, equipment and plant.
- (ii) The amount that may have become due to the CONTRACTOR on account of work already executed by him shall not be payable to him until after the expiry of Six (6) calendar months reckoned from the date of termination of CONTRACT or from the taking over of the WORK or part thereof by the OWNER as the case may be, during which period the responsibility for faulty materials or workmanship in respect of such work shall, under the CONTRACT, rest exclusively with the CONTRACTOR. This amount shall be subject to deduction of any amounts due from the CONTRACT to the OWNER under the terms of the CONTRACT authorised or required to be reserved or retained by the OWNER.
- (iii) Before determining the CONTRACT as per Clause 34.2.2 (a) or (b) provided in the judgement of the OWNER, the default or defaults committed by the CONTRACTOR is/are curable and can be cured by the CONTRACTOR if an opportunity given to him, then the OWNER may issue Notice in writing calling the CONTRACTOR to cure the default within such time specified in the Notice.
- (iv) The OWNER shall also have the right to proceed or take action as per 34.2.2 (a) or (b) above, in the event that the CONTRACTOR becomes bankrupt, insolvent, compounds with his creditors, assigns the CONTRACT in favour of his creditors or any other person or persons, or being a company or a corporation goes into voluntary liquidation, provided that in the said events it shall not be necessary for the OWNER to give any prior notice to the CONTRACTOR.

	EMERGENCY DIESEL GENERATOR PACKAGE	PC-183/E-4022/P-I/S-IV	0	
	TALCHER FERTILIZERS LIMITED, ODISHA (INDIA)	DOC. NO.	REV	
	GENERAL CONDITIONS OF CONTRACT (GCC)	SHEET 37 OF 75		

(v) Termination of the CONTRACT as provided for in sub- clause 34.2.2(a) above shall not prejudice or affect their rights of the OWNER which may have accrued upto the date of such termination.

34.2.3 In case of termination of CONTRACT herein set forth (under clause 34.2) except under conditions of Force Majeure and termination after expiry of contract, the CONTRACTOR shall be put under holiday [i.e. neither any enquiry will be issued to the party by Talcher Fertilizers Limited (TFL) or any of it's JV partners against any type of tender nor their offer will be considered by TFL or any of it's JV partners against any ongoing tender (s) where contract between TFL/it's JV partners and that particular CONTRACTOR (as a bidder) has not been finalized],for a period of three years from the date of termination by TFL to such CONTRACTOR.

34.3 **Duration of suspension of payment due to CONTRACTOR:**

34.3.1 Owner shall have right to suspend making any payments to the contractor for the portion of WORK having a bearing with CONTRACTOR's default during the period of rectification of the defaults.

34.4 **Work taken out of the hands of the CONTRACTOR**

34.4.1 **Employment of other contractors:**



If the OWNER takes action under sub-clause 34.2.2, he may complete the work or any part of it by contracting with or employing any other contractor to execute further and complete work or any part of it and to provide all equipment, materials and labour as may be necessary for such further execution and completion. If practicable the further execution and completion shall be carried out in accordance with the specification and at prices obtained under competitive conditions.

The OWNER may also take possession of and permit such person or persons to use for the purposes of the CONTRACT only such materials, tools and equipment and all other things on or about the SITE which are the property of the CONTRACTOR as are requisite and necessary for such further execution and completion, and the CONTRACTOR shall have no right to any compensation or allowance in respect thereof.

On the completion of such work, all tools and equipment and the surplus of the materials so taken possession of shall be handed over to the CONTRACTOR but without payment or allowance for the fair wear and tear they may have sustained in the meantime, provided that if there by a deficiency as referred to in sub clause 34.4.2 of this clause, and if the CONTRACTOR fails to make good such deficiency such of the tools, equipment and materials as are necessary to make good the deficiency may be sold and a sufficient part of the monies received retained by the OWNER and applied in payment of such deficiency.

In addition the OWNER shall be entitled:

- a) To take possession of and remove from the CONTRACTOR's premises within a reasonable period anything (including but without limiting the generality thereof any design, drawings, specification, material or other goods) the property which is vested in the OWNER pursuant to the CONTRACT;

	EMERGENCY DIESEL GENERATOR PACKAGE		PC-183/E-4022/P-I/S-IV	0	
	TALCHER FERTILIZERS LIMITED, ODISHA (INDIA)		DOC. NO.	REV	
	GENERAL CONDITIONS OF CONTRACT (GCC)		SHEET 38 OF 75		

- b) To full particulars of any sub-contract made by the CONTRACTOR with any person for the execution of any portion of the WORKS and to peruse and copy any instrument (including but without limiting the generality thereof any agreement, letter or other paper) relating to any such SUB-CONTRACT made by the CONTRACTOR with any person for the execution of any portion of the WORKS.
- c) To pursue and copy any standard working drawing or other drawing or data necessary in the opinion of the OWNER for completion of the WORKS and the property which is not vested to the OWNER pursuant to the CONTRACT provided that the OWNER shall in no case make use of any copy made pursuant to sub paragraphs (b) or (c) hereof other than for the purpose of completing the WORKS and that on the fulfilment of the whole of the obligations of the CONTRACTOR under the CONTRACT the OWNER shall return to the CONTRACTOR any such copy.

The CONTRACTOR shall offer to the OWNER all rights of access and all reasonable facilities to enable the OWNER to remove any such thing or pursue or copy any such instrument, drawing or data and shall supply such particulars on request by the OWNER in that behalf.

For the purposes of sub-clause 34.4.2 the cost incurred by the OWNER in and about for such removal, perusal or copying or obtaining such particulars shall be deemed to be part of the cost of carrying out that portion of the work taken out of the CONTRACTOR's hands.



34.4.2 **Extra cost to the OWNER of completing work for deduction:**

On completing the terminated portion of WORK as provided under Article 34.4.1 the OWNER shall ascertain the reasonable and direct costs based on the documentary evidence of the cost incurred but such amount shall not include any extra cost due to departures from the specification unless such departures were necessitated by the CONTRACTOR's default. Should the amount so ascertained be greater than the CONTRACT PRICE which would have been paid to the CONTRACTOR, if the whole of the Work had been carried out by him, the difference between the two amounts shall be deducted from any monies which may then be or thereafter become due to the CONTRACTOR or which may have been deposited by him as security under the CONTRACT, and if such monies be less than the amounts to be deducted the deficiency shall be paid by the CONTRACTOR to the OWNER and which may be recovered as provided in sub clause 34.4.1 of this clause or by way of arbitration, jurisdiction or both, such payment of excess amount shall be independent of penalty for delay if the completion of work is delayed.

34.5 **Preservation of rights of the OWNER**



No action taken by the OWNER under sub clause 34.3 and 34.4 of this clause shall vitiate the CONTRACT or shall operate to the prejudice of the right of the OWNER to recover from the CONTRACTOR or to deduct from any monies which may be or may become due to the CONTRACTOR all sums of money which may be or may become due to the OWNER under the CONTRACT as damages, penalties or otherwise.

- 34.6 Should the OWNER decide to terminate the CONTRACT under sub clause 34.2.2(b) of this clause, he may do so under notice in writing as from the date of such notice, and the termination shall be without prejudice to any right that may have occurred to the OWNER or to the CONTRACTOR under the CONTRACT.

	EMERGENCY DIESEL GENERATOR PACKAGE TALCHER FERTILIZERS LIMITED, ODISHA (INDIA) GENERAL CONDITIONS OF CONTRACT (GCC)	PC-183/E-4022/P-I/S-IV	0	
		DOC. NO.	REV	
		SHEET 39 OF 75		

34.7 Termination of Contract on Account of OWNER's Convenience

- 34.7.1 The OWNER, may, by 30 days written notice send to the CONTRACTOR, terminate the CONTRACT, in whole or in part, at any time for his convenience. The notice of termination shall specify that termination is for the OWNER's convenience, the extent to which performance of work under the CONTRACT is terminated and the date upon which such termination becomes effective.
- 34.7.2. Upon receipt of the notice of termination under GCC Clause 34.7.1, the CONTRACTOR shall either immediately or upon the date specified in the notice of termination.
- (a) cease all further work, except for such work as the OWNER may specify in the notice of termination for the sole purpose of protecting that part of the Facilities already executed, or any work required to leave the Site in a clean and safe condition.
 - (b) terminate all subcontracts, except those to be assigned to the OWNER pursuant to paragraph (d)(ii) below.
 - (c) remove all CONTRACTOR's Equipment from the Site, repatriate the CONTRACTOR's and its SUB-CONTRACTORS' personnel from the Site, remove from the Site any wreckage, rubbish and debris of any kind, and leave the whole of the Site in a clean and safe condition.
 - (d) In addition, the CONTRACTOR, subject to the payment specified in GCC Clause 34.7.2.1, shall
 - (i) deliver to the OWNER the parts of the PLANT executed by the CONTRACTOR up to the date of Termination.
 - (ii) to the extent legally possible, assign to the OWNER all right, title and benefit of the CONTRACTOR to the PLANT and Equipment as at the date of termination, and, as may be required by the OWNER, in any subcontracts concluded between the CONTRACTOR and its SUB-CONTRACTORS.
 - (iii) deliver to the OWNER all non-proprietary drawings, specifications and other documents prepared by the CONTRACTOR or its Sub-CONTRACTORS as at the date of termination in connection with the PLANT.
- 34.7.2.1 In the event of termination of the Contract under GCC Clause 34.7.1, the OWNER shall pay to the CONTRACTOR the following amounts:
- (a) the Contract Price, properly attributable to the parts of the PLANT executed by the CONTRACTOR as of the date of termination
 - (b) the costs reasonably incurred by the CONTRACTOR in the removal of the CONTRACTOR's Equipment from the Site and in the repatriation of the CONTRACTOR's and its SUB-CONTRACTOR's personnel

	EMERGENCY DIESEL GENERATOR PACKAGE	PC-183/E-4022/P-I/S-IV	0	
	TALCHER FERTILIZERS LIMITED, ODISHA (INDIA)	DOC. NO.	REV	
	GENERAL CONDITIONS OF CONTRACT (GCC)	SHEET 40 OF 75		

- (c) any amounts to be paid by the CONTRACTOR to its SUB-CONTRACTORS or Vendors in connection with the termination of any subcontracts or supply agreement, including any cancellation charges
- (d) costs incurred by the CONTRACTOR in protecting the PLANT and leaving the Site in a clean and safe condition pursuant to paragraph (a) of GCC Clause 34.7.2

34.7.3 Termination for Insolvency

OWNER may at any time terminate CONTRACT giving written notice to CONTRACTOR, if CONTRACTOR becomes bankrupt or otherwise insolvent, provided that such termination will not prejudice or affect any right of action or remedy which has occurred or will accrue thereafter to OWNER.

If the Contract is terminated under GCC Sub-Clauses 34.7.3, the OWNER shall pay to the CONTRACTOR all payments specified in GCC Sub-Clause 34.7.2 as reasonable compensation for all loss or damage sustained by the CONTRACTOR arising out of, in connection with or in consequence of such termination.

34.7.4 Termination by CONTRACTOR due to default of OWNER



If the OWNER has failed to pay the CONTRACTOR any sum due under the Contract within the specified period or commits a substantial breach of the CONTRACT, the CONTRACTOR may give a notice to the OWNER that requires payment of such sum or specifies the breach and requires the OWNER to remedy the same, as the case may be. If the OWNER fails to pay such sum or fails to remedy the breach or take steps to remedy the breach within thirty (30) days after receipt of the CONTRACTOR's notice then the CONTRACTOR may give a notice to the OWNER thereof, and if the OWNER has failed to pay the outstanding sum or to remedy the breach within thirty (30) days of such notice, the CONTRACTOR may by a further notice to the OWNER, terminate the CONTRACT.

If the CONTRACT is terminated under GCC Clause 34.7.4, the OWNER shall pay to the CONTRACTOR all payments specified in GCC Clause 34.7.2 as reasonable compensation for all loss or damage sustained by the CONTRACTOR arising out of, in connection with or in consequence of such termination.

34.8 Surviving Obligations

Termination of this CONTRACT (a) shall not relieve CONTRACTOR of its obligations with respect to the confidentiality as set forth in this CONTRACT, (b) shall not relieve CONTRACTOR of any obligation hereunder which expressly or by implication survives termination hereof, and (c) except as otherwise provided in any provision of this CONTRACT expressly limiting the liability of CONTRACTOR, shall not relieve CONTRACTOR of any obligations or liabilities for loss or damage to the other Party arising out of or caused by acts or omissions of CONTRACTOR prior to the effectiveness of such termination or arising out of such termination, and shall not relieve CONTRACTOR of its obligations as to portions of SERVICES already performed or of obligations assumed by CONTRACTOR prior to the date of termination, except as otherwise agreed by OWNER in writing.

- 34.8.1 Termination of this CONTRACT (a) shall not relieve OWNER of its obligations with respect to the confidentiality as set forth in this CONTRACT, (b) shall not relieve OWNER of any obligation hereunder which expressly or by implication survives termination hereof, and (c) shall not relieve OWNER of any obligations or liabilities for loss or damage to the other Party arising out of or caused by acts or omissions of OWNER prior to the effectiveness of such termination or arising out of such termination.

	EMERGENCY DIESEL GENERATOR PACKAGE	PC-183/E-4022/P-I/S-IV	0	
	TALCHER FERTILIZERS LIMITED, ODISHA (INDIA)	DOC. NO.	REV	
	GENERAL CONDITIONS OF CONTRACT (GCC)	SHEET 41 OF 75		

35.0 FORCE MAJEURE



35.1 CONDITIONS FOR FORCE MAJEURE: In the event of either party being rendered unable by Force Majeure to perform any obligations required to be performed by them under the CONTRACT the relative obligation of the party affected by such Force Majeure shall upon notification to the other party be suspended for the period during which Force Majeure conditions lasts. The cost and loss sustained by the either party shall be borne by the respective parties. The term "Force Majeure" as employed herein shall mean acts of God, earthquake, war (declared or undeclared), revolts, riots, fires, floods, rebellions, explosions, hurricane, sabotage, civil commotions and acts and regulations of respective Government of the two parties, namely the OWNER and the CONTRACTOR. Upon the occurrence of such cause(s) and upon its termination, the party alleging that it has been rendered unable as aforesaid thereby, shall notify the other party in writing immediately but not later than 120 (one hundred and twenty) hours of the alleged beginning and ending thereof giving full particulars and satisfactory evidence in support of its claim. Time for performance of the relative obligation suspended by the Force Majeure shall then stand extended by the period for which such conditions lasts..

OUTBREAK OF WAR

- (i) If during the currency of the CONTRACT there shall be an out-break of war whether declared or not, in that part of the World which whether financially or otherwise materially affect the execution of the WORK the CONTRACTOR shall unless and until the CONTRACT is terminated under the provisions in this clause continue to use his best endeavour to complete the execution of the WORK, provided always that the OWNER shall be entitled, at any time after such out-break of war to terminate or re-negotiate the CONTRACT by giving notice in writing to the CONTRACTOR and upon such notice being given the CONTRACT shall, save as to the rights of the parties under this clause and to the operation of the clauses entitled settlement of Disputes and Arbitration hereof, be terminated but without prejudice to the right of either party in respect of any antecedent breach thereof.
- (ii) If the CONTRACT shall be terminated under the provisions of the above clause, the CONTRACTOR shall with all reasonable diligence remove from the SITE all the CONTRACTOR's equipment and shall give similar facilities to his SUB-CONTRACTORS to do so

35.2 If the CONTRACTOR suffers delay in the due execution of the contractual obligations due to delays caused by Force Majeure as defined above, the agreed time of completion of job covered by this CONTRACT or the obligation of the CONTRACTOR shall be extended by a period of time on account of force majeure conditions, provided that on the occurrence of any such contingency, the CONTRACTOR within 120 hours reports to the OWNER in writing, the cause of delay and likely duration of cause of delay with requisite documentary evidence.

35.3 If the works to be executed by the CONTRACTOR are suspended by Force Majeure conditions lasting for more than 2 (two) months, the OWNER shall have the option to terminate the CONTRACT or re-negotiate the contract provisions.

	EMERGENCY DIESEL GENERATOR PACKAGE	PC-183/E-4022/P-I/S-IV	0	
	TALCHER FERTILIZERS LIMITED, ODISHA (INDIA)	DOC. NO.	REV	
	GENERAL CONDITIONS OF CONTRACT (GCC)	SHEET 42 OF 75		

- 35.4 CONTRACTOR and OWNER shall endeavour to prevent, overcome or remove the causes of FORCE MAJEURE.
- 35.5 No ground for exemption can be invoked if CONTRACTOR has failed to give timely notice by registered letter/ Speed-Post/Courier/Email/Hand Delivery and subsequently supported it by documentary evidence.
- 35.6 Delay or non-performance by a party hereto caused by the occurrence of any event of FORCE MAJEURE shall not:

(a) Constitute a default or breach of the CONTRACT,

Or

(b) Give rise to any claim for damages or additional cost or expense occasioned thereby, if such delay or non-performance is caused by the occurrence of any event of FORCE MAJEURE. FORCE MAJEURE conditions are not payable under any circumstances.

- 35.7 Force Majeure is no one's fault, therefore each party should bear its own cost and a provision to terminate the CONTRACT in case of Force Majeure extending beyond six (06) months is provided. Should OWNER wish the CONTRACTOR to continue further, both parties may sit together and mutually agree on the future course failing which Parties will have the right to terminate. Such termination shall not be considered as Termination for Owner's Convenience. However, outstanding invoices, payment for supplies made and payment to the work already performed will be paid by OWNER on such termination.



Contractor shall have the right to take action to mitigate the impact of the prolonged Force Majeure event in mutual consent with Owner. For instance, Contractor shall have the right to demobilize Contractor's equipment and personnel from the Plant.

36.0 NO WAIVER OF RIGHTS

Neither the inspection by the OWNER or any of their officials, employees, or agents nor any order by the OWNER for payment of money or any payment for or acceptance of, the whole or any part of the WORKS by the OWNER nor any extension of time, nor any possession taken by the OWNER shall operate as a waiver of any provision of the CONTRACT, or of any power herein reserved to the owner or any right to damages herein provided, nor shall any waiver of any breach in the CONTRACT be held to be a waiver of any other subsequent breach.

37.0 BANKRUPTCY AND LIQUIDATION OF CONTRACTOR OR BUSINESS UNDER RECEIVERSHIP

If the CONTRACTOR becomes insolvent or bankrupt, or has a receiving order made against him, or compound with his creditors, or being a corporation commence to be wound up not being a member's voluntary winding up for the purpose of reconstruction or carry on his business under a receiver for the benefit of his credit, the CONTRACTOR shall within fourteen (14) days notify the OWNER accordingly. On the occurrence of any of the happenings stated in the first sentence of this clause, the OWNER shall be at liberty to:

	EMERGENCY DIESEL GENERATOR PACKAGE		PC-183/E-4022/P-I/S-IV	0	
	TALCHER FERTILIZERS LIMITED, ODISHA (INDIA)		DOC. NO.	REV	
	GENERAL CONDITIONS OF CONTRACT (GCC)		SHEET 43 OF 75		

- a) Determine the CONTRACT forthwith by notice in writing to the CONTRACTOR or to the receiver or liquidator or to any person in whom the CONTRACT may have become vested, and act in the manner provided in clause 34.1 (proceedings or default) or,
- b) Give to such receiver liquidator or other person in writing the option for a period of one month of carrying out the WORK subject to his providing a guarantee for the due and faithful performance of the CONTRACT upto the CONTRACT value of the work for the time being remaining unexecuted and subject to his taking all reasonable steps to prevent stoppage of the work. In the event of stoppage of the work, the period of the option under this clause shall be fourteen (14) days only.

38.0 CERTIFICATE NOT TO AFFECT RIGHT OF OWNER AND LIABILITY OF CONTRACTOR

No interim payment certificate of the OWNER nor any sum paid on account by the OWNER nor any extension of time for execution of the WORKS granted by the OWNER shall affect or prejudice the rights of the OWNER against the CONTRACTOR or relieve the CONTRACTOR of his obligations for the due performance of the CONTRACT or be interpreted as approval of the WORK done or of the equipment furnished and no certificate shall create liability on the OWNER to pay for alterations, amendments, variations, or additional works not ordered, in writing, by the OWNER or discharge the liability of the CONTRACTOR for the payment of damages whether due certified or not or any sum against the payment of which he is bound to indemnify the OWNER and the Consultant nor shall any such certificate nor the acceptance by him of any sum paid on account or otherwise affect or prejudice the rights of the CONTRACTOR against the OWNER.

39.0 SETTLEMENT OF DISPUTES



- 39.1 Except as otherwise specifically provided in the CONTRACT, all disputes concerning questions of fact arising under the CONTRACT shall be considered by the OWNER subject to a written appeal by CONTRACTOR to the OWNER.
- 39.2 Any disputes or differences including those considered as such by only of the parties arising out of or in connection with the CONTRACT shall be to be extent possible settled amicably between the parties.
- 39.3 If, after 60DAYs from the commencement of such informal negotiations, OWNER and CONTRACTOR are unable to resolve amicably the dispute, either party may require that the dispute be referred for resolution to the arbitration as described under clause 40 below.

40.0 ARBITRATION

- 40.1 Refer clause no. 45 of Section-III of NIT.

40.2 Continuation of Work and payments during Arbitration

WORK shall be continued by CONTRACTOR during the arbitration proceedings unless the matter itself is the subject of Arbitration or unless the matter itself is such that WORK cannot practically be continued until the decision of the arbitrator is obtained and CONTRACTOR shall remain liable and bound in all respects under the Contract. Except as otherwise expressly provided in CONTRACT, no payment due and payable by

	EMERGENCY DIESEL GENERATOR PACKAGE		PC-183/E-4022/P-I/S-IV	0	
	TALCHER FERTILIZERS LIMITED, ODISHA (INDIA)		DOC. NO.	REV	
	GENERAL CONDITIONS OF CONTRACT (GCC)		SHEET 44 OF 75		

OWNER shall be withheld on account of such arbitration proceedings unless it is the subject matter or one of the subject matters.

41.0 GOVERNING LAWS, LANGUAGE AND MEASURES

41.1 CONTRACT shall be governed and construed according to the Indian Law as in force and shall be subject to the jurisdiction of the Court in Delhi. All disputes arising during the execution of the CONTRACT shall be resolved as per Clause no. 39.0 (Settlement of Dispute) & 40.0 (Arbitration) of GCC and thereafter in accordance with said law.

41.2 The governing language for all communication, notices, Technical Information, etc. pertaining to CONTRACT shall be English. Any literature, correspondence, documents, etc., shall be considered only if its accompanied by English translation. For the purpose of interpretation English translation shall govern and be binding on all parties.

41.3 The metric system of measurement shall be used exclusively in the CONTRACT.

42.0 RELEASE OF INFORMATION

The CONTRACTOR shall not communicate or use in advertising, publicity, sales releases or in any other medium, photographs or other reproduction of the WORKS under this CONTRACT or descriptions of the SITE, dimensions, quantity, quality or other information, concerning the work unless prior written permission has been obtained from the OWNER. Notwithstanding the above, CONTRACTOR is entitled, under intimation to OWNER, to make such public Announcements, as it may be bound to in compliance with the Law, the Rules and any Governmental Agency or Stock Exchange Regulation the CONTRACTOR is subjected to.

43.0 COMPLETION OF CONTRACT

Unless otherwise terminated under the provisions of any other relevant clause, this CONTRACT shall be deemed to have been completed at the expiry of the DEFECT LIABILITY PERIOD.



44.0 ENFORCEMENT OF TERMS

The failure of either party to enforce at any time any of the provisions of this CONTRACT or any rights in respect thereto or to exercise any option herein provided, shall in no way be construed to be a waiver of such provisions, rights or options or in any way affect the validity of the CONTRACT. The exercise by either party of any of its rights herein shall not preclude or prejudice either party from exercising the same or any other right provided in the contract.

45.0 OWNER'S DECISION

45.1 In respect of all matters which are left to the decision of the OWNER/ENGINEER-IN-CHARGE including the granting or withholding of the certificates, the OWNER/ENGINEER-IN-CHARGE shall, if required to do so, by the CONTRACTOR, give in writing a decision thereon.

45.2 In each case involving a financial commitment, the written APPROVAL of the owner alone shall be binding.

	EMERGENCY DIESEL GENERATOR PACKAGE TALCHER FERTILIZERS LIMITED, ODISHA (INDIA) GENERAL CONDITIONS OF CONTRACT (GCC)	PC-183/E-4022/P-I/S-IV	0	
		DOC. NO.	REV	
		SHEET 45 OF 75		

45.3 In matters of difference of opinion on a decision passed by the OWNER/ENGINEER-IN-CHARGE to the CONTRACTOR, stipulations of Clause 39.0 of GCC shall govern.

46.0 CO-OPERATION

46.1 CO-OPERATION WITH OWNER

The CONTRACTOR and OWNER shall co-operate with each other in the discharge of their respective obligation under the CONTRACT with the aim of satisfactory completing the PLANT and the WORKS in accordance with the CONTRACT.

46.1.1 The parties shall deal fairly, openly and in good faith with each other. Subject to Clause 53 (Secrecy) of GCC, each party shall disclose information which the other might reasonably need in order to exercise its rights and to perform its obligations under the CONTRACT. In particular, each party shall promptly disclose full information to the other concerning any matter which will or may prevent the Plant and Works being completed in accordance with the CONTRACT. The parties shall work together in a manner consistent with their respective obligations under the CONTRACT to resolve or mitigate any such problem.

46.1.2 OWNER shall be at liberty to object with reasonably valid reasons to employment of any person at SITE and the objection shall be communicated in writing and CONTRACTOR shall make immediate arrangements for removal of such person.



46.2 COOPERATION WITH OTHER CONTRACTORS

The CONTRACTOR shall not object to the execution of the work by other contractors or tradesmen engaged by OWNER and offer them every facility for the execution of their several works simultaneously with CONTRACTOR's work, provided however that CONTRACTOR'S WORK is not hampered by such co-operation. CONTRACTOR shall at all times provide sufficient fencing, notice boards, lighting and watchmen to protect and warn the public and guard the works and in default thereof, OWNER may provide such facilities at CONTRACTOR's cost, if such failure is attributable to CONTRACTOR.

The CONTRACTOR shall agree to cooperate with the OWNER and OTHERCONTRACTORS and exchange with them such technical information, provided that such CONTRACTOR is bound towards CONTRACTOR on confidentiality and limited use obligations not less stringent than those accepted by OWNER under the CONTRACT and shall not be a competitor of CONTRACTOR as is necessary to obtain the most efficient and economical design and to avoid unnecessary duplication of efforts. The OWNER shall be provided with three (3) copies of all correspondence addressed by the CONTRACTOR to other SUB-CONTRACTORS in respect of such exchange of technical information.

47.0 SUSPENSION OF WORKS

(i) Subject to the provisions of sub-para (ii) of this clause, the CONTRACTOR shall, if ordered in writing by the ENGINEER-IN-CHARGE, or his representative, temporarily suspend the WORKS or any part thereof for such written order, proceed with the WORK therein ordered to be suspended until, he shall have received a written order to proceed therewith. The CONTRACTOR shall not be entitled to claim compensation for any loss or damage sustained by him by

	EMERGENCY DIESEL GENERATOR PACKAGE	PC-183/E-4022/P-I/S-IV	0	
	TALCHER FERTILIZERS LIMITED, ODISHA (INDIA)	DOC. NO.	REV	
	GENERAL CONDITIONS OF CONTRACT (GCC)	SHEET 46 OF 75		

reason of temporary suspension of the WORKS aforesaid. An extension of time for completion, corresponding with the delay caused by any such suspension of the WORKS as aforesaid will be granted to the CONTRACTOR should he apply for the same provided that the suspension was not consequent to any default or failure on the part of the CONTRACTOR.

- (ii) In case of suspensions of entire WORK, ordered in writing by ENGINEER-IN-CHARGE, for a period of more than two months, the CONTRACTOR shall have the option to terminate the CONTRACT.

48.0 REPLACEMENT OF PARTS AND MATERIALS (DEFECTIVE/DAMAGED/LOST DURING TRANSIT/ERECTION AND COMMISSIONING)



48.1 If during the progress of the WORK, the OWNER shall decide and inform in writing to the CONTRACTOR that the CONTRACTOR has manufactured any plant or part of the plant in an unsound or imperfect manner or has furnished any plant inferior to the quality specified, the CONTRACTOR on receiving details of such defects or deficiencies shall at his own expense, within seven (7) days of his receiving the notice or otherwise within such time as may be reasonably necessary for making it good, proceed to alter, reconstruct or remove such work and furnish fresh equipment upto the standards of the specifications. In case the CONTRACTOR fails to do so, the OWNER may, on giving the CONTRACTOR seven (7) days notice in writing of his intentions to do so, proceed to remove the portion of the works so complained of and at the risk & cost of the CONTRACTOR, perform all such work or furnish all such equipment provided that nothing in this clause shall be deemed to deprive the OWNER of or affect any rights under the CONTRACT which the OWNER may otherwise have in respect of such defects and deficiencies.

48.2 The CONTRACTOR's full and extreme liability under this clause shall be satisfied by the payments to the OWNER of the extra cost, of such replacement procured including erection as provided for in the CONTRACT, such extra cost being the ascertained difference between the price paid by the OWNER for such replacements and the CONTRACT price portion for such defective plants and repayments of any sum/ paid by the OWNER to the CONTRACTOR in respect of such defective plant.

48.3 If the material/ equipment or any portion thereof is damaged or lost during transit and handling, storage, erection, commissioning at site, the replacements of such material / equipment shall be effected by the CONTRACTOR within a reasonable time to avoid unnecessary delays and without waiting for realisation of cost of damages from the insurance company, appointed by him for this purpose. This will not alter the time schedule in any way.

49.0 DEFENCE OF SUITS

49.1 If any action in Court is brought against the OWNER or an officer or agent of the OWNER for the failure omission or neglect on the part of the CONTRACTOR to perform any acts, matters, covenants or things under the CONTRACT, or for damage or injury caused by the alleged omission or negligence on the part of the CONTRACTOR, his agents representatives or his SUB-CONTRACTORS or in connection with any claim based on lawful demands of SUB-CONTRACTORS, workmen, suppliers or employees, the CONTRACTOR shall in all such cases indemnify and keep the owner and/ or his

	EMERGENCY DIESEL GENERATOR PACKAGE	PC-183/E-4022/P-I/S-IV	0	
	TALCHER FERTILIZERS LIMITED, ODISHA (INDIA)	DOC. NO.	REV	
	GENERAL CONDITIONS OF CONTRACT (GCC)	SHEET 47 OF 75		

representative harmless from all losses damages, expenses or decrees arising out of such action.



- 49.2 If any action in court referred to in Clause 49.1 of GCC above is brought against OWNER or an officer or agent of OWNER, OWNER shall promptly give the CONTRACTOR notice thereof and CONTRACTOR may at its own expense and in OWNER's name, conduct such proceedings or claim for the settlement of any such proceedings or claim. If CONTRACTOR fails to notify OWNER within twenty-eight (28) days after receipt of such notice that it intends to conduct any such proceedings or claim, then the OWNER shall have full power and right at his discretion to defend or comprise any suit or pay claim or demand brought or made against him as aforesaid whether pending or threatened as he may consider necessary or desirable and shall be entitled to recover from the CONTRACTOR all sums of money including the amount of damages and compensation and all legal costs, charges and expenses in connection with any compromise or award which shall not be called into question by the CONTRACTOR and shall be final and binding upon him provided however that, unless CONTRACTOR has so failed to notify OWNER within the twenty-eight (28) days period, OWNER shall make no admission which may be prejudicial to the defence of any such proceedings or claim.

50.0 CONTRACTOR'S RESPONSIBILITIES

- 50.1 In consideration of payment by the OWNER, the CONTRACTOR shall regularly and diligently carry out and complete the WORKS in accordance with the CONTRACT.
- 50.2 All work carried out by the CONTRACTOR shall be carried out with sound workmanship and materials, safety and in accordance with the Contract requirements.
- 50.3 The CONTRACTOR shall set out the PLANT by reference to points, lines and levels of reference as defined in the approved SPECIFICATION.
- 50.4 The PLANT/WORKS as completed by the CONTRACTOR shall in every respect comply with the requirements defined in the Specification or any other provision of the CONTRACT.
- 50.5 If at any time during the performance of the CONTRACT, the CONTRACTOR is of the opinion that a change to the WORKS or the design or method of operation of the PLANT
- a. is necessary to eliminate a potential defect in the PLANT or a specific hazard to any person or party in the performance of the WORKS or in the operation of the PLANT which has occurred or would otherwise occur' or
 - b. would improve operating or life cycle costs of the PLANT; or
 - c. would otherwise be beneficial to the OWNER;

the CONTRACTOR shall bring the matter to the attention of the ENGINEER-IN-CHARGE stating the reasons for his opinion and where appropriate, submit his proposals for a Variation in accordance with Clause 3 of SPECIAL CONDITIONS OF CONTRACT.

- 50.6 The CONTRACTOR shall at all times have and maintain adequate resources available for the proper and timely execution of the WORKS, including financial resources, and

	EMERGENCY DIESEL GENERATOR PACKAGE	PC-183/E-4022/P-I/S-IV	0	
	TALCHER FERTILIZERS LIMITED, ODISHA (INDIA)	DOC. NO.	REV	
	GENERAL CONDITIONS OF CONTRACT (GCC)	SHEET 48 OF 75		

competent, appropriately experienced and physically capable staff and labour whether employed by the CONTRACTOR, any SUB-CONTRACTOR or third parties.

50.7 The CONTRACTOR shall provide and maintain records as specified in the CONTRACT.

Unless otherwise agreed, the CONTRACTOR shall, at intervals of not more than one calendar month, report to the ENGINEER-IN-CHARGE on the progress of the WORKS, supporting his reports with appropriate documentation including any revisions to the approved programme.

50.8 The CONTRACTOR shall maintain and cause SUB-CONTRACTORS to maintain, a quality assurance system as specified in the CONTRACT. The existence of such a quality assurance system shall not relieve the CONTRACTOR from any of his other duties, obligations or liabilities under the CONTRACT. The CONTRACTOR shall also prepare and implement a validation plan, if such a requirement is specified in the CONTRACT.

51.0 PROGRESS REPORTS AND PHOTOGRAPHS



51.1 The CONTRACTOR shall furnish soft copy of progress photographs of the work done in his shop/site. Photographs shall be taken when and where indicated by the ENGINEER-IN-CHARGE. Photographs, if required shall be approximately 8 inches by 10 inches in size, including a margin on one 10 inch side for binding. Each photograph shall contain the date, the name of the CONTRACTOR and the title of the view taken. (technical to check, whether to be shifted to SCC)

51.2 Required number of monthly progress reports, in prescribed proforma, shall be submitted by the CONTRACTOR to the ENGINEER-IN-CHARGE for review. These shall detail the status of design, procurement of raw materials and bought outs, approval of the CONTRACTOR's drawings, manufacture of the equipment, statutory approvals taken, inspection of equipment/material, completed despatches, materials received at site, damages, if any, during transit, actions taken or replacement of damaged equipment, progress of erection work and programme of work for succeeding month and statement showing position of payment.

52.0 **DELETED**

53.0 **SECRECY**

53.1 The technical information, drawings, specifications and other related documents forming part of the NIT or the CONTRACT or such of those materials prepared during the execution of the project including photographs, micro-films, design, calculations etc. are the property of the OWNER and shall not be used for any other purpose, except for execution of contract. All rights, including rights in the event of grant of a patent and registration of designs are reserved. The technical information, drawings, specifications, records and other documents shall not be copied, transcribed, traced or reproduced in any other form or otherwise in whole and/or duplicated, modified, divulged and/or disclosed to a third party nor misused in any other form whatsoever, without the OWNER's previous consent in writing except to the extent required for the execution of this CONTRACT. Such technical information, drawings specifications and other related documents furnished shall be returned to the OWNER with all approved copies and duplicates, if any, immediately after they have been used for the agreed purposes.

	EMERGENCY DIESEL GENERATOR PACKAGE		PC-183/E-4022/P-I/S-IV	0	
	TALCHER FERTILIZERS LIMITED, ODISHA (INDIA)		DOC. NO.	REV	
	GENERAL CONDITIONS OF CONTRACT (GCC)		SHEET 49 OF 75		

For avoidance of any doubt it may be clarified that this clause relate to documents prepared by OWNER or is a property of OWNER.

In the event of any breach of this provision, the CONTRACTOR shall indemnify the OWNER from any loss, cost or damage or any other claim whatsoever from any parties claiming from or through them in respect of such breach.

All intellectual property rights in documents and calculations prepared by CONTRACTOR shall at all times exclusively vest with CONTRACTOR and be used by OWNER in accordance with the CONTRACT.

53.2 Records of Contract Documents

53.2.1 The CONTRACTOR shall at all times make and keep sufficient copies of the DRAWINGS, Specifications and CONTRACT documents for him to fulfil his duties under the CONTRACT.

53.2.2 The CONTRACTOR shall keep at site atleast three copies of each and every Drawing, Specification and CONTRACT document and these copies shall be available at all times for use by the OWNER and EIC and by any other person authorized by the OWNER who needs to know about the PROJECT.

54.0 CORRESPONDENCE

54.1 All correspondences from the CONTRACTOR to the OWNER shall be as per the correspondence distribution schedule. All communications including clarifications and/or comments shall be addressed to OWNER/PMC and shall always bear reference of DLOA No.

54.2 Any notice to the CONTRACTOR under the terms of the CONTRACT shall be served by registered e-mail, Speed Post or courier.

54.3 Any notice to the OWNER shall be served from the CONTRACTOR's Principal office in the same manner.

54.4 Any written order or instruction of OWNER or his duly authorised representative, communicated to authorised representative of the CONTRACTOR at site office shall be deemed to have been communicated to the CONTRACTOR at his legal address.

54.5 A notice shall be effective when delivered or on date of the notice, whichever is later.



55.0 MATERIALS AND EQUIPMENT

55.1 Materials

55.1.1 CONTRACTOR shall supply all materials required for incorporation in the works, within the scope of work, necessary to establish, commission and operate the PLANT.

55.1.2 INVOICES

CONTRACTOR's invoices shall be raised as per approved Billing Schedule.



	EMERGENCY DIESEL GENERATOR PACKAGE	PC-183/E-4022/P-I/S-IV	0	
	TALCHER FERTILIZERS LIMITED, ODISHA (INDIA)	DOC. NO.	REV	
	GENERAL CONDITIONS OF CONTRACT (GCC)	SHEET 50 OF 75		

- (a) The CONTRACTOR's invoice shall be in the format with all the requisite information as prescribed under GST Laws.
- (b) Before raising GST invoices, CONTRACTOR shall coordinate with the OWNER with respect to address and GSTIN number on which such invoices have to be raised

55.1.3 The CONTRACTOR shall be responsible at his own cost and initiative within the scope of WORK, to take delivery of the materials from the port of delivery in India in respect of imported materials and from the factory or ware-house or other place(s) of delivery in respect of indigenous materials and to transport these to the CONTRACTOR's stockpiles, godowns or other places of storage approved by the ENGINEER-IN-CHARGE, and to transport the same from said godowns or place(s) of storage to the work site for installation in the permanent WORKS.

55.1.4 The work of delivery and transportation of materials shall include (but not be limited to) the following:



- i) Clearance of the goods through custom and port clearance including filling and/or filing of all custom manifests, bills of entry, and custom declarations and other documents as may be required for the clearance of the goods from customs or port authorities.
- ii) Stevedoring, clearing, forwarding and handling services as required for clearing, forwarding and handling imported and indigenous materials and consignments including payment at CONTRACTOR's cost of any demurrage, wharfage, port charges, siding charges, retention charges, detention charges or other charges whatsoever and howsoever designated or levied by any railway, air-port, ship and/or other authorities for or in connection with the loading, unloading or detention of any materials or vessels or other means of transport beyond the free period or unloading, clearance, retention or detention or loading, as the case may be, provided by the relevant authority(ies) or carrier(s) in this behalf.
- iii) All works and operations necessary to lift and to remove the material from port, ware-house, railway or other siding, factory or other places of delivery, loading, handling, transporting and unloading and safely stacking, placing or storing the same at approved godowns, yards or other place(s) of storage including lashing or other-wise securing or protecting the same in transit and during and in storage.
- iv) Supply, procurement, mobilization, and deployment of all labour thereof, equipment & machinery necessary for lifting, loading, handling, removing, transporting, unloading, stacking or securing the materials.
- v) Transit and storage insurance of all materials for the full replacement value thereof delivered at site.
- vi) All acts, deeds, matters or things required to fulfil all local, municipal and other statutory authorities with respect to the transportation of any materials through or into any State, municipal, local or other barriers or limits or for the import of the materials or any of them within the limits of such barrier, including payment of octroi or other local toll, terminal and/or entry or other taxes payable on the passage or entry of the materials through or within any local limits, for which purpose the OWNER shall give the CONTRACTOR and/or CONTRACTOR's designate(s) any and all authority(ies) as may be reasonably required in this behalf.
- vii) All other acts, deeds, matters and things whatsoever ancillary, auxiliary or incidental to the above including but not limited to the grading of the site and/or creation of temporary approaches and ramps etc. as may be required.

	EMERGENCY DIESEL GENERATOR PACKAGE	PC-183/E-4022/P-I/S-IV	0	
	TALCHER FERTILIZERS LIMITED, ODISHA (INDIA)	DOC. NO.	REV	
	GENERAL CONDITIONS OF CONTRACT (GCC)	SHEET 51 OF 75		

55.2 GENERAL PROVISION WITH REGARD TO MATERIALS

55.2.1 The CONTRACTOR shall, within the scope of work, undertake the following activities and responsibilities with respect to and in addition and without prejudice to the activities and responsibilities under Clause 55.1 and associated clauses thereunder in respect of materials:

- i) The CONTRACTOR shall be taking delivery, ensure compliance of any condition applicable for delivery from the concerned authority or carrier, and shall be exclusively responsible to pay and bear any detention, demurrage or penalty or other charges payable by virtue of any delay or failure by the CONTRACTOR in lifting the materials or in observing any of the conditions aforesaid, and shall keep the OWNER indemnified from and against all consequences thereof
- ii) The CONTRACTOR shall maintain a day-to-day account of all materials indicating the daily receipt(s), consumption(s) and balance of each material and category thereof. Such account shall be in the format, if any, prescribed by the ENGINEER-IN-CHARGE and shall be supported by all documents necessary to verify the correctness of the entries in the account. Such account shall be maintained at the CONTRACTOR office and site(s) and shall be open for inspection and verification (by verification of documents in support of the entry as also by feasible verification of the stock) at all times by the ENGINEER-IN-CHARGE with authority at all times without obstruction to enter into or upon any godown or other place(s) or premise(s) where the materials or any part of them are lying or stored and to inspect the same himself and or through his representative(s).
- iii) All materials shall be taken delivery of, held, stored and utilised by the CONTRACTOR as Trustee of the OWNER, and delivery of the material to the CONTRACTOR shall constitute an entrustment thereof to the CONTRACTOR, with the intent that any utilization, application or disposal thereof by the CONTRACTOR otherwise than for permanent incorporation in the contractual works in terms of the contract shall constitute a breach of trust by the CONTRACTOR.
- iv) The CONTRACTOR shall at all times be exclusively responsible for any and all losses, damages, deterioration, misuse, wastage, theft, or other application or misapplication or disposal of the materials or any of them contrary to the provisions hereof and shall keep the OWNER indemnified from and against the same and shall forthwith at its own cost and expenses replace any such material, lost, damaged, deteriorated, misused, wasted, stolen, applied, mis-applied and/or disposed as aforesaid with other material of equivalent quality and quantity delivered to site at the CONTRACTOR's risks and costs in all respects.
- v) The CONTRACTOR shall take out, at his own cost and keep in force at all times, during transit, handling, storage and erection, till the period as defined in the SPECIAL CONDITIONS OF CONTRACT (SCC), all the Insurance policy(ies) with Insurance Company(ies) for the full replacement value of the materials at site against the risks specified in the CONTRACT. Such policies shall be in the joint names of the OWNER and the CONTRACTOR, with exclusive right in the OWNER to receive all monies due in respect of such policy(ies) and with right in the OWNER (but without obligation to do so) to take out and pay the premia for any such policy(ies) and deduct the premia and any other costs and expense in this behalf from the monies for the time being due or in future becoming due to the



	EMERGENCY DIESEL GENERATOR PACKAGE	PC-183/E-4022/P-I/S-IV	0	
	TALCHER FERTILIZERS LIMITED, ODISHA (INDIA)	DOC. NO.	REV	
	GENERAL CONDITIONS OF CONTRACT (GCC)	SHEET 52 OF 75		

CONTRACTOR. In case of any Insurance claim, the GST leviable on the transfer of the claim money from OWNER to CONTRACTOR shall be over and above the GST cap indicated in the CONTRACT and shall be borne by OWNER.

- vi) If the CONTRACTOR shall default in replacing any material lost, damaged, deteriorated, misused, wasted, short, stolen, misapplied or disposed of within the provisions hereof above, the CONTRACTOR shall be liable to pay to the OWNER the cost of such materials.
- a) Notwithstanding anything herein provided, the CONTRACTOR shall be and remain solely and exclusively liable to repair, restore or replace, as the case may be, the materials damaged or destroyed as a result of any act or omission, notwithstanding the existence or otherwise of any policy(ies) of insurance aforesaid, with the intent that any policy(ies) of insurance aforesaid taken out by the CONTRACTOR or by the OWNER, on default by the CONTRACTOR, shall not anyway absolve the CONTRACTOR from his full liability up to and until expiry of Defect Liability Period defined in the contract. Further, as provided in respect of the works, the work(s) and all materials incorporated therein shall be and remain at the risk of the CONTRACTOR in all respects, including (but not limited to) accident, lightning, earth-quake, fire, storm, flood, tempest, riot, civil commotion and/or war or otherwise with respect to the materials. The insurance policies for above risks shall constitute merely an additional security and not a substitution of liability.
- b) It shall be the exclusive responsibility of the CONTRACTOR to lodge and pursue any or all claims in respect of the insurance covers as above.
- c) The CONTRACTOR shall, as a condition to the certification of any Running Account Bill, satisfy the OWNER/ Engineer-In-Charge of the existence of one or more policy(ies) of insurance, covering the materials as specified herein. The policy(ies) of insurance aforesaid shall cover all insurable risks, including but not limited to, any loss or damage commencing from the supplier's ware house in handling, transit, storage and during erection, theft, pilferage, riot, civil commotion, force majeure (including earth quake, flood, storm, cyclone, tidal wave, lightening and other adverse weather conditions), accidents of kinds, fire, war risks and explosion.

55.3.0 **BILL OF MATERIALS**

- 55.3.1 The CONTRACTOR shall furnish to the OWNER a detailed "Bill of Materials (BOM)" specifying the materials, which on preliminary determination made by the CONTRACTOR, will be required to be incorporated in the permanent works in order to establish the WORK/ Unit and to operate the PLANT/Unit, including construction materials.
- 55.3.2 Each item entered in the Bill of Materials shall be priced. The Bill of Materials and said price break-up therein are intended only to form a basis for the purpose of calculating on account payments and for calculating payments due to the CONTRACTOR under Clause 34.0 of GCC upon cancellation of contract, and for no other purpose.
- 55.3.3 The OWNER shall review or cause to be reviewed the prima facie adequacy, sufficiency, validity and/or suitability of the materials listed in the Bill of Materials for the works for which they are intended and of the prices indicated in the Bill of Materials in respect thereof. Such review shall be performed in conjunction with the design, engineering, specification and other technical reviews to be done by the OWNER and all provisions applicable thereto with reference to critical drawings shall be applicable to the review of the Bill of Materials.

	EMERGENCY DIESEL GENERATOR PACKAGE	PC-183/E-4022/P-I/S-IV	0	
	TALCHER FERTILIZERS LIMITED, ODISHA (INDIA)	DOC. NO.	REV	
	GENERAL CONDITIONS OF CONTRACT (GCC)	SHEET 53 OF 75		

55.3.4 The priced Bill of Materials shall constitute the Bill of Materials envisaged in the contract documents. However, the CONTRACTOR shall have full responsibility under the CONTRACT to sell and supply to the OWNER all materials required for the permanent incorporation in the works and which are required to establish, commission and operate the PLANT/ Unit in accordance with the CONTRACT and the specifications, complete in all respects including spares, tools, tackles and testing equipment, so far as included within the scope of supply, whether or not any particular material is actually included within or omitted in the Bill of Materials and whether or not the price thereof is included in the price indicated in the Bill of Materials and whether or not the price thereof is in conformity with the price thereof indicated in the Bill of Materials. The review and approval of the Bill of Materials and the prices therein are intended only for the satisfaction of the OWNER that the priced Bill of Materials, prima-facie covers the materials required to be supplied by the CONTRACTOR within the scope of supply.

55.4 **SUPPLY OF MATERIALS**



55.4.1 The CONTRACTOR shall supply the materials required to be supplied within the Contractor's scope of supply for incorporation in the permanent works in accordance with and to meet the requirements in quality, quantity and other particulars of the descriptions, specifications, plans, drawings, designs and other documents applicable thereto, and the CONTRACTOR shall be deemed to have undertaken that all materials selected, procured and supplied by the CONTRACTOR within the scope of supply shall be of the best quality and workmanship and shall be capable of producing the designed desired results and to perform the designed and desired functions to meet the contractual requirements in all respects for the project.

55.4.2 The CONTRACTOR shall undertake and complete the supply of materials within the scope of supply to meet the scheduled progress and requirements of the WORK within the scope of work.

55.4.3 All materials shall be deemed to have been accepted only when the material is received at the project SITE and accepted by the ENGINEER-IN-CHARGE. Such acceptance shall however be subject to the terms and conditions of CONTRACT, including the right of rejection and/or replacement as elsewhere herein specified.

55.4.4 Without prejudice to any other terms of the contract, it is clarified that the mere agreement, acceptance or prescription of a Delivery or other Schedule containing an extended time of commencement or completion in respect of the entire delivery(ies) or any of them shall not anyway constitute an extension of time in a terms of the CONTRACT so as to bind the OWNER or relieve the CONTRACTOR of all or any of his liabilities under CONTRACT, nor shall constitute a promise on behalf of the OWNER or a waiver by the OWNER of any of its rights in terms of the contract relative to the performance of the CONTRACT within the time specified or otherwise, but shall be deemed only (at the most) to be a guidance to the CONTRACTOR for better organising his work on a recognition that the CONTRACTOR has failed to organise his supplies and/or make the same within the time specified in the Delivery Schedule.

55.4.5 If the CONTRACTOR fails to supply the materials in accordance with the dates in this behalf specified in the Delivery Schedule which has an impact on the critical path of the schedule, the CONTRACTOR shall provide the OWNER with a suitable plan to recover the delay, but without prejudice to any other rights, discount or remedy available to the OWNER in respect of such delay or failure.

	EMERGENCY DIESEL GENERATOR PACKAGE	PC-183/E-4022/P-I/S-IV	0	
	TALCHER FERTILIZERS LIMITED, ODISHA (INDIA)	DOC. NO.	REV	
	GENERAL CONDITIONS OF CONTRACT (GCC)	SHEET 54 OF 75		

55.4.6 MAKE OF MATERIALS

- i) All equipment and materials to be supplied under this CONTRACT shall be from approved vendors as indicated in the Bidding Document or as otherwise approved by the ENGINEER-IN-CHARGE / OWNER.
- ii) Where the makes of materials are not indicated in the Bidding document, the CONTRACTOR shall furnish details of proposed makes and supplies and supply the same after obtaining the OWNER's/ ENGINEER-IN-CHARGE's approval.

55.5.0 CERTIFICATE OF VERIFICATION AND GOOD CONDITION



55.5.1 The CONTRACTOR shall, before supply of material covered within the scope of supply, at his own risks, costs and initiative, undertake or cause to be undertaken all tests, analysis and inspections as shall be required to be undertaken with regard to the materials under the specifications and any codes, practices, orders and instructions with respect thereto and shall cause the results thereof to be recorded, reported or certified, as the case may be, and shall not offer for delivery or deliver any material(s) which has/have not passed such tests/analysis or inspection and which are not accompanied by the tests results, reports and/or certificates in this behalf provided in the applicable specifications, code(s) and/or practices.

55.5.2 On arrival of the material at site the CONTRACTOR shall give written notice thereof to the ENGINEER-IN-CHARGE or Inspection Agency notified by the OWNER in this behalf, to inspect the materials, and shall keep in readiness for inspection, the materials and the relevant tests results, reports and certificates hereto.

55.5.3 Notwithstanding any other provisions in the contract documents for analysis or tests of materials and in addition thereto, the CONTRACTOR shall, if so required by the ENGINEER-IN-CHARGE or Inspection Agency in writing at his own risks and costs, analyse, test, prove and weigh all materials (including materials incorporated in the works) required to be analysed, tested, proved and/or weighed by the ENGINEER-IN-CHARGE or Inspection Agency in this behalf and shall have such analysis or tests conducted by the agency(ies), or authority(ies) if any specified by the ENGINEER-IN-CHARGE or Inspection Agency. The CONTRACTOR shall provide all equipment, labour, materials and other things whatsoever required for testing, preparation of the samples, measurement of work and/or proof of weighment of the materials as directed by the ENGINEER-IN-CHARGE or Inspection Agency.

55.5.4 If on Inspection or proof, analysis or tests as aforesaid the ENGINEER-IN-CHARGE or Inspection Agency nominated by the OWNER in this behalf is prima facie satisfied that the material received is in conformity with the material requirements of the Bill of Materials and description given in the shipping documents and in the CONTRACTOR's invoices in this behalf and that the test reports/results/certificates given in respect thereof are prima facie in conformity with the relevant result/reports/certificates required in respect thereof in terms of the specifications and/or relevant codes and practices, and that the material appears to be prima facie in good order and condition, the ENGINEER-IN-CHARGE shall issue to CONTRACTOR, a Certificate of Verification and Good Condition in respect of such material, and this shall constitute the Certificate of Verification and Good Condition elsewhere envisaged in the CONTRACT documents. Should the ENGINEER-IN-CHARGE not issue said Certificate within 5 working days following the conformity of the aforementioned requirements, the Certificate of Verification and Good Condition shall be deemed issued.

55.5.5 Such certificate is only intended to satisfy the OWNER that prima facie the material supplied by the CONTRACTOR is in order and shall not anywise absolve the

	EMERGENCY DIESEL GENERATOR PACKAGE	PC-183/E-4022/P-I/S-IV	0	
	TALCHER FERTILIZERS LIMITED, ODISHA (INDIA)	DOC. NO.	REV	
	GENERAL CONDITIONS OF CONTRACT (GCC)	SHEET 55 OF 75		

CONTRACTOR of his/its full responsibility under the CONTRACT in relation thereto, including in relation to,—fulfilment and/or performance of works or other guarantees envisaged in the CONTRACT.

55.5.6 Notwithstanding that any area(s) or source(s) has/have been suggested by the OWNER to the CONTRACTOR from which any material for incorporation in the WORKS can be obtained, the CONTRACTOR shall independently satisfy himself of the suitability, accessibility and sufficiency of the source(s) of supply suggested by the OWNER and suitability of the material available from such source(s) with the intent that any suggestion as aforesaid shall not anyway relieve the CONTRACTOR of his full liability in respect of the suitability and quality of the material(s) obtained from said source(s) and the CONTRACTOR shall obtain material(s) there from and incorporate the same within the permanent works entirely at his own risks and costs in all respects, with the intent that any such suggestion by the OWNER shall only be by way of assistance to the CONTRACTOR and shall not entail any legal responsibility or liability upon the OWNER.



55.6.0 MATERIALS WITHIN THE CONTRACTOR'S SCOPE OF SUPPLY

The OWNER does not warrant or undertake the provisions of any materials and the CONTRACTOR shall not imply, by conduct, expression or assurance or by any other means, any promise or obligation on the part of the OWNER in his respect understood by the CONTRACTOR.

55.7.0 Deleted

55.8 PACKING AND FORWARDING

- The CONTRACTOR shall, wherever applicable, after proper painting, pack and crate all items in such a manner so as to protect them from deterioration and damage during rail and road transportation to the site and during storage at the site till the time of erection. Without prejudice to any other liabilities or obligations of the CONTRACTOR, the CONTRACTOR shall be responsible for all damage(s) due to improper packing.
- The CONTRACTOR shall notify OWNER/ ENGINEER-IN-CHARGE the expected date of arrival materials at the site for the information of OWNER/ ENGINEER-IN-CHARGE.
- The CONTRACTOR's notification shall also give all shipping information concerning the weight, size and content of each packing and such other information as the OWNER/ ENGINEER-IN-CHARGE EIC may require.
- The following documents shall be sent to the OWNER/ EIC in three copies:
 - a) Signed Invoice(s)
 - b) Delivery Challan
 - c) Packing list.
 - d) Manufacturer's certificate of inspection for shipment duly approved by the CONTRACTOR in one original and one photocopy
 - e) Third Party Inspection Release Note clearly indicating that material has been inspected and accepted as per QAP approved by OWNER or TPI waiver certificate issued by OWNER.
 - f) Railway Receipt/LR
 - g) Intimation to Insurance Company for arranging Transit Insurance
 - h) Guarantee certificate (wherever applicable)

	EMERGENCY DIESEL GENERATOR PACKAGE	PC-183/E-4022/P-I/S-IV	0	
	TALCHER FERTILIZERS LIMITED, ODISHA (INDIA)	DOC. NO.	REV	
	GENERAL CONDITIONS OF CONTRACT (GCC)	SHEET 56 OF 75		

- i) Operation & Maintenance manual (wherever applicable)

55.9 Assembly Marks and Name Plates

- 55.9.1 All component/parts of EQUIPMENT shall be indelibly hard marked with identification marks, comprising EQUIPMENT, part numbers, and CONTRACT number/PO number which shall also be shown on drawing to facilitate speedy identification, assembling or dismantling.
- 55.9.2 On each EQUIPMENT, a nameplate indicating basic details, pressure rating, wherever applicable, code number of EQUIPMENT, electrical characteristics in case of electrical EQUIPMENT, name of instrument with tag no., manufacturer's name shall be fixed at proper place.
- 55.9.3 For packages where marking is not possible at least two metallic nameplates must be affixed. Marking on the plates will be by means of engraving or indelible paint and will include the information listed above.

55.10 Despatch/Shipping notice

CONTRACTOR shall notify OWNER by E-mail for its information the expected date of delivery of a consignment, date of readiness of EQUIPMENT for shipment, total gross weight and total volume with dimensions.

55.11 Heavy Lift Consignment (HLC) or Over Dimensional Consignments (ODC).

- 55.11.1 CONTRACTOR shall follow the guidelines of Ministry of Road transport and Highways (MORTH) India, for the shipping/transportation of all packages/consignments. The CONTRACTOR shall be responsible to comply with rules relating to E-way Bills and other related provisions under the GST laws for movement of packages/consignments.
- 55.11.2 CONTRACTOR shall make his own arrangements for movement of all consignments including ODC/HLC.
- 55.11.3 CONTRACTOR confirms that it has surveyed the route for transportation of ODC/HLC items of EQUIPMENT and CONTRACTOR further confirms that it has included all cost of repairs of road, civil works, strengthening of bridges, culverts, widening of roads, etc. as required for transportation of ODC/HLC items of EQUIPMENT in its CONTRACT PRICE. OWNER shall not be responsible for repairs of road, civil works, strengthening of bridges, culverts, widening of roads, etc. as required for the transportation of ODC/HLC items of EQUIPMENT and shall not be liable to reimburse the cost of such repairs of road, civil works, strengthening of bridges, culverts, widening of roads, etc. to CONTRACTOR.

55.12 Marking

- 55.12.1 CONTRACTOR shall mark the following on packing three sides i.e. two sides faced and cover (Top) EQUIPMENT with indelible paint in conspicuous printed letters not less than 5 cm. in size in English:

- A. For Imported EQUIPMENT

	EMERGENCY DIESEL GENERATOR PACKAGE	PC-183/E-4022/P-I/S-IV	0	
	TALCHER FERTILIZERS LIMITED, ODISHA (INDIA)	DOC. NO.	REV	
	GENERAL CONDITIONS OF CONTRACT (GCC)	SHEET 57 OF 75		

Government of India
A/c TALCHER PROJECT, ODISHA, INDIA.

- a) CONTRACT /PO NO. : _____
- b) Equipment Description and Item Nos.: _____
- c) Package : _____ of _____
- d) Gross / Net Weight (Kgs.) : _____
- e) Dimension L x W x H cms. : _____
- f) WARNING MARKS (FRAGILE, ATTENTION, TOP, KEEP DRY ETC.)
- g) Forwarding No. : _____
- h) Part shipment/full shipment/final shipment : _____
- i) Each package shall bear a symbol contained in the package as follows:

'A' Storage in a closed storehouse.

'B' Storage under a shed.

'C' Storage in the open.

55.12.2 Depending on the characteristics of the contents in the packages, the packages have to be marked with appropriate international marking ("HANDLE WITH CARE"; "THIS SIDE UP"; "SLING MARK"; ETC.) and other indications necessary for correct handling such as Centre of Gravity and points of slinging (in case of heavy loads).

55.12.3 For packages where marking is not possible, at least two metallic nameplates must be affixed. Marking on the plates will be by means of engraving or indelible paint and will include the information listed above.

55.12.4 All corners of the packages shall be painted with indelible 'Blue' paint at least 125 mm in depth for easy identification/location of the packages for clearance and handling at the port.



55.13 Packing List

55.13.1 CONTRACTOR will include in each package an item-wise packing List, Invoice No. and associated drawings.

55.13.2 The packing list and any other documents shall be put in a closed polyethylene envelope and included in each package.

55.13.3 A second copy of the packing list shall be placed in a polyethylene envelope on the outside of the each package by means of metallic plate marked "Documents". As regards columns, exchangers and similar equipment, the envelope shall be placed in a nozzle being identified by an arrow, in indelible paint, followed by the word "Document".

55.13.4 Shipping documents must always be presented in the number of copies indicated in this CONTRACT.

	EMERGENCY DIESEL GENERATOR PACKAGE	PC-183/E-4022/P-I/S-IV	0	
	TALCHER FERTILIZERS LIMITED, ODISHA (INDIA)	DOC. NO.	REV	
	GENERAL CONDITIONS OF CONTRACT (GCC)	SHEET 58 OF 75		

55.14 Shipping Arrangements and Forwarding of Documents

CONTRACTOR shall avoid the use of over aged vessels for the shipment of the imported EQUIPMENT under this CONTRACT and if so used, the cost of additional insurance, if any, shall be borne by CONTRACTOR.

55.15 Despatch/Shipment Notice for Insurance.

55.15.1 CONTRACTOR shall send intimations of despatches indicating items despatched, quantity, value, weight and carrier particulars directly through fax to the insurance company fixed by CONTRACTOR.

55.15.2 Insurance for transit risks and other risks shall be covered by CONTRACTOR.

55.16 UTILITIES AND CONSUMABLES ETC.

Subject to any other provision to the contrary in the CONTRACT, the CONTRACTOR shall be and remain at all times exclusively responsible within the scope of work to provide all utilities, consumables, permits, licenses, easements and facilities and other items and things whatsoever required for or in connection with the WORK, including but not limited to those indicated by expression or implication in the bid documents and/or other CONTRACT documents or howsoever otherwise as shall be or may from time to time be necessary for or in connection with the WORK.

56.0 MEASUREMENTS, CERTIFYING INSPECTIONS AND PAYMENTS

56.1 Final Measurements:



56.1.1 Within 15 (fifteen) days from the date of certification of works completed /milestone achieved in respect of the WORKS or of any portion of the WORKS, section, group or job site, as the case may be, measurements for the works covered by such certification shall be jointly taken by the ENGINEER-IN-CHARGE and the CONTRACTOR as herein provided.

56.1.2 If the CONTRACTOR fails to apply to the ENGINEER-IN-CHARGE for measurements within 15 (fifteen) days from the date of certification of works completed/ milestone achieved as specified in Clause 56.1.1, the ENGINEER-IN-CHARGE shall notify the CONTRACTOR in writing of the date(s) for measurements, and require the CONTRACTOR to be present on date(s) so notified.

56.2 Mode of Measurement

56.2.1 All measurements shall be recorded in the metric system, and shall be taken in accordance with the procedures set forth or provided for in the Schedule of Rates, Specifications and other CONTRACT Documents.

56.2.2 Where the mode of measurement is not provided for in the Contract Documents in respect of any item of work, it shall be measured in accordance with the Indian Standard Specification No. 1200 (latest edition) and in the event of such item not being covered by Indian Standard Specifications, it shall be measured in accordance with the method of measurement in this behalf specified by the ENGINEER-IN-CHARGE, whose decision in this regard shall be final and binding upon the CONTRACTOR. If the Contractor disagrees with the decision of the ENGINEER-IN-CHARGE, the dispute shall be settled as per the provisions of Clause 39.0 of GCC.

	EMERGENCY DIESEL GENERATOR PACKAGE	PC-183/E-4022/P-I/S-IV	0	
	TALCHER FERTILIZERS LIMITED, ODISHA (INDIA)	DOC. NO.	REV	
	GENERAL CONDITIONS OF CONTRACT (GCC)	SHEET 59 OF 75		

- 56.2.3 All measurements shall be taken jointly by the ENGINEER-IN-CHARGE and the CONTRACTOR or their respective representatives. The CONTRACTOR or his authorized representative shall be entitled to remain present at all times when joint measurements are being taken.
- 56.2.4 Despite due intimation, if the CONTRACTOR omits or fails to be present to witness joint measurements, the measurements shall be taken in the presence of the ENGINEER-IN-CHARGE and the measurements so recorded and signed by the ENGINEER-IN-CHARGE as correct, shall be final and binding upon the Parties.
- 56.2.5 Except in cases covered by Clause 56.2.4, in all other cases measurements shall be signed and dated on each page by the CONTRACTOR / CONTRACT MANAGER and ENGINEER-IN-CHARGE or his representative. If the CONTRACTOR objects to any of the measurements recorded, including the mode of measurement, such objection shall be noted in the measurement book against the item objected to and such note shall be dated and authenticated by the CONTRACTOR / CONTRACT MANAGER and ENGINEER-IN-CHARGE or his representative. In the absence of any objection noted as aforesaid, the CONTRACTOR shall be deemed to have accepted the relative measurements as entered in the Measurement Book / Sheets and shall be barred from raising any objection at a later date in respect of any measurements recorded in the Measurement Book.
- 56.2.6 All objections noted in the Measurement Book in terms of Clause 56.2.5 shall be considered and decided within 15 days by the ENGINEER-IN-CHARGE. The decision of the ENGINEER-IN-CHARGE relative thereto (whether on the correct measurement to be adopted or on the mode of measurement to be adopted) shall be final and binding upon the Parties. If the Contractor disagrees with the decision of the ENGINEER-IN-CHARGE, the dispute shall be settled as per the provisions of Clause 39.0 of GCC.
- 56.2.7 The measurement as finally recorded in terms of Clause 56.2.4 or Clause 56.2.5 or 56.2.6, as applicable, shall be the Final Measurement.

56.3 CERTIFYING INSPECTIONS

All provisions referred to in Clauses 56.1 to 56.2, in respect of Mode of Measurement, shall apply to all inspections required to be made in order to qualify the CONTRACTOR for any payment(s) under the CONTRACT and any reference in the said clauses to measurements shall, for the purpose of this clause, be deemed to be a reference to certifying inspections and any reference therein to the measurement book shall, for the purpose of this clause, be deemed to be a reference to the certifying inspection book.

56.4.0 Deleted



56.5.0 PRICE SCHEDULE

- 56.5.1 The remuneration determined due to the CONTRACTOR as provided for in Clause 56.4.1 hereof shall constitute the entirety of the remuneration and entitlement of the CONTRACTOR in respect of the WORK under the CONTRACT, and no further or other payment whatsoever shall be or become due or payable to the CONTRACTOR under the CONTRACT.
- 56.5.2 Without prejudice to the generality of the provisions of Clause 56.5.1 hereof, the TOTAL LSTK PRICE shall be deemed to include and cover (unless otherwise expressly specified to the contrary in any CONTRACT document(s)):
- (i) All costs, expenses, outgoings and liabilities of every nature and description whatsoever and all risks whatsoever (foreseen or unforeseen, including force majeure) to be taken or which may occur in or relative to execution, completion, testing, commissioning and/or handling over the WORKS to the OWNER and/or in or relative to acquisition, loading, unloading, transportation, storing, working

	EMERGENCY DIESEL GENERATOR PACKAGE	PC-183/E-4022/P-I/S-IV	0	
	TALCHER FERTILIZERS LIMITED, ODISHA (INDIA)	DOC. NO.	REV	
	GENERAL CONDITIONS OF CONTRACT (GCC)	SHEET 60 OF 75		

upon, using, converting fabricating, or erecting any item, equipment, system, material or component in or relative to the WORKS, and the CONTRACTOR shall be deemed to have known the nature, scope, magnitude and the extent of the works and items, MATERIALS, EQUIPMENT, and components required for the proper and complete execution of the Works though the CONTRACT documents may not fully and precisely set out, describe or specify them, and the generality hereof shall not be deemed to be anywise limited, restricted or abridged because in certain cases the CONTRACT documents or any of them shall or may and/or in other cases they shall or may not expressly state that the CONTRACTOR shall do or perform any particular labour or service or because in certain cases the CONTRACT documents state that a particular work, operation, supply, labour or service shall be performed/made by the CONTRACTOR at his own cost or without additional payment, compensation or charge or without entitlement of claim against the OWNER or words to similar effect, and in other cases they do not, or because in certain cases it is stated that the same are included in or covered by the Price Schedule and in other cases it is not so stated.

- (ii) The cost of all construction and related vessels, craft, vehicles, movements, plant, equipment, distribution of water and power, construction of temporary roads and access, temporary works, pumps, wiring, pipes, scaffolding, piling, shuttering and other materials, supervision, labour, insurance, fuel, stores, spares, supplies, appliances and materials, items, articles and things whatsoever (foreseen or unforeseen) by expression or implication to be supplied, provided or arranged in or relative to or in connection with the performance and/or execution of the WORKS and/or related or incidental thereto, complete in every respect in accordance with the CONTRACT document, and the plans, drawing, designs, orders and/or instructions;
- (iii) The cost of mobilisation including but not limited to mobilisation of vehicles, movements, machinery, equipment, gear, tools, tackle, consumables and other items and goods and personnel necessary for or to perform the WORKS contemplated under the CONTRACT, preparation and erection of work yards and other work places and facilities necessary for or to perform the WORKS contemplated under the CONTRACT and/or to supply the material included within the scope of supplies including all work, labour, inputs, goods, EQUIPMENT, and other items and things whatsoever necessary for the performance of the WORKS, dismantling and/or removal of the same and restoration of the site, lifting the materials and transporting them to CONTRACTOR'S stock piles/work yard, job sites and loading, stacking and/or storing the same.
- (iv) The costs and risks of all rents, royalties, licenses, permits, permission and other fees, duties, penalties, levies, and damages whatsoever payable for or in respect of any protected or patented goods, materials, equipment or processes employed in or relative to the works and of all rents, royalties, licenses, permits, permissions and any other fee, duty, penalty, levy, loss or damages payable on the excavation, removal or transportation of any material or acquisition or use of any right of way or other right, licenses, permit, privilege, permission or uses required for or relative to the performance of the WORK.
- (v) The cost of all taxes and duties within the scope of work, all customs and import duties, Indian Income Tax, applicable GST, quay, warfare, demurrage, detention and landing charges and all other duties, taxes, fees, charges, levies, and/or cesses whatsoever imposed or to be imposed by the Central Government or State Government or Municipal or Local Bodies or other Authorities whatsoever and payable on any materials supplied and/or on works performed without any

	EMERGENCY DIESEL GENERATOR PACKAGE		PC-183/E-4022/P-I/S-IV	0	
	TALCHER FERTILIZERS LIMITED, ODISHA (INDIA)		DOC. NO.	REV	
	GENERAL CONDITIONS OF CONTRACT (GCC)		SHEET 61 OF 75		

entitlement to the CONTRACTOR for any exemption, remission, refund or reduction thereof



- (vi) The cost of all indemnities under the CONTRACT, and insurance premia on insurance required in terms of the CONTRACT documents or otherwise under any law, rule or regulation, and the cost of all risks whatsoever (foreseen and unforeseen) including but not limited to risks of delay or extension of time or reduction or increase in the work or scope of work and/or cancellation of CONTRACT, and/or accident, strike, civil commotion, war, strike, labour trouble, third party breach, fire, lighting, inclement weather, storm, tempest, flood, earthquake and other acts of God, Government regulation or imposition or restriction, dislocation of road, rail, sea, air and other transport, access or facility, flooding of site and/or access roads and approaches thereto, suspension of work, sabotage and other cause whatsoever.
- (vii) The cost of all inspections, tests and certificates relative thereto including third party tests and/or inspections where necessary, and of items, instruments, plant and/or tools and appliances required to conduct such inspection and tests.
- (viii) The cost of all materials supplied and/or intended for incorporation in the WORKS supplied within the scope of work, delivery thereof to the job site, loading, transportation and unloading thereof, waste on materials, and return of empties and surpluses.
- (ix) The cost of all escalations (foreseen and unforeseen) including but not limited to increase in Government taxes and duties (beyond contractual completion period and any extension hereof due to reasons attributable to CONTRACTOR), labor costs and material costs and other inputs whatsoever..
- (x) All supervision charges, establishment's overheads, finance charges and other costs and expenses and charges to the CONTRACTOR, and the CONTRACTOR's profit of and relative to the WORK and/or supply.
- (xi) The cost of all deductions, reductions, discounts, adjustments and withholdings whatsoever under or in connection with the CONTRACT.
- (xii) The cost shall be deemed to include and cover the risk of all possibilities of delay and interference with the CONTRACTOR's conduct of WORK which occur from any causes including orders of the OWNER in the exercise of his power and on account of extension of time granted due to various reasons and for all other possible or probable causes of delay.

56.6.0 Deleted

56.7.0 Deleted

56.8.0 CLAIMS BY THE CONTRACTOR

56.8.1 No claim(s) shall on any account be made by the CONTRACTOR after submission of the Final Bill, with the intent that the Final Bill prepared by the CONTRACTOR shall reflect any and all claims whatsoever of the CONTRACTOR against the OWNER arising out of or in connection with the CONTRACT or any supply made or work performed by the CONTRACTOR there under or in relation thereto, and notwithstanding any enabling provision in any law or CONTRACT and notwithstanding any claim that the CONTRACTOR could have with respect thereto, the CONTRACTOR hereby waives and relinquishes any and all such claims not included in the Final Bill and absolves and discharges the OWNER from and against the same, even if in not including the same as aforesaid, the CONTRACTOR shall have acted under a mistake of law or of fact, or shall claim to have acted under economic compulsion or necessity.

	EMERGENCY DIESEL GENERATOR PACKAGE	PC-183/E-4022/P-I/S-IV	0	
	TALCHER FERTILIZERS LIMITED, ODISHA (INDIA)	DOC. NO.	REV	
	GENERAL CONDITIONS OF CONTRACT (GCC)	SHEET 62 OF 75		

56.8.2 If required by the OWNER, the ENGINEER-IN-CHARGE shall be authorised to require the CONTRACTOR to furnish, and the CONTRACTOR shall, upon the request of the ENGINEER-IN-CHARGE/OWNER, furnish all invoices, vouchers and accounting records as may be deemed necessary by the ENGINEER-IN-CHARGE/OWNER for the purpose of verifying any CONTRACTOR's claim.

56.9 DISCHARGE OF OWNER'S LIABILITY

56.9.1 The acceptance by the CONTRACTOR of any amount paid by the OWNER to CONTRACTOR in respect of the Final Bill of the CONTRACTOR in settlement of all said dues to the CONTRACTOR under the Final Bill shall, without prejudice to the claims of the CONTRACTOR included in the Final Bill in accordance with the provisions of clause 56.4.2 of GCC, be deemed to be in full and final settlement of all such dues to the CONTRACTOR notwithstanding any qualifying remarks, protest or condition imposed or purported to be imposed by the CONTRACTOR related to the acceptance of such payment, with the intent that upon acceptance by the CONTRACTOR of any payment made as aforesaid, the CONTRACT (including the arbitration clause) shall stand discharged and extinguished insofar as relates to and/or concerns the entitlements of the CONTRACTOR under the CONTRACT except for the CONTRACTOR's right, if any, to receive payment in respect of his notified claims included in his Final Bill and the right to receive payment of the unadjusted balance of the Contract Performance Security in accordance with the provisions of Clause 56.10.3 on successful completion of the DEFECT LIABILITY PERIOD. However, nothing herein stated shall affect the CONTRACTOR's undischarged liabilities and obligations under the CONTRACT.



56.9.2 The acceptance by the CONTRACTOR of any amount paid by the OWNER to the CONTRACTOR in respect of the notified claims of the CONTRACTOR included in the Final Bill, in settlement of the claims of the CONTRACTOR, shall be deemed to be in full and final settlement of all claims of the CONTRACTOR and, the CONTRACT shall stand discharged and extinguished insofar as relates to and/or concerns the claims of the CONTRACTOR except for the CONTRACTOR's rights to receive payments of the unadjusted balance, if any, of the Contract Performance Security in accordance with clause 56.10.3.0 hereof on successful completion of the DEFECT LIABILITY PERIOD. However, nothing herein stated shall affect the CONTRACTOR's undischarged liabilities and obligations under the CONTRACT.

56.9.3 Notwithstanding anything provided in Clause 56.9.1 and/or Clause 56.9.2, the CONTRACTOR shall be and remain liable for defects in terms of DEFECT LIABILITY PERIOD and associated clause thereunder and for any indemnity to the OWNER in terms of Clause 56.10.2 and shall be and remain entitled to receive the unadjusted balance of the Contract Performance Security remaining in the hands of the OWNER in terms of Clause 56.10.3 and associated clauses thereunder.

56.10.0 Deleted

56.11 CLAIMS OF OWNER

56.11.1 The release/payment of any unadjusted balance of the Contract Performance Security (furnished in the form of a Bank Guarantee or otherwise) by the OWNER to the CONTRACTOR as aforesaid or otherwise shall not be deemed or treated as a waiver of any right(s) or claim(s) of the OWNER existing before the issuance of the FINAL ACCEPTANCE CERTIFICATE or shall not stop or prevent the OWNER from thereafter making or enforcing any claim or any rights existing before the issuance of the FINAL

	EMERGENCY DIESEL GENERATOR PACKAGE		PC-183/E-4022/P-I/S-IV	0	
	TALCHER FERTILIZERS LIMITED, ODISHA (INDIA)		DOC. NO.	REV	
	GENERAL CONDITIONS OF CONTRACT (GCC)		SHEET 63 OF 75		

ACCEPTANCE CERTIFICATE against the CONTRACTOR with the intent that the claims of the OWNER, against the CONTRACTOR shall continue to survive and shall not get extinguished notwithstanding the issue of FINAL ACCEPTANCE CERTIFICATE and/or the release of Contract Performance Security to the CONTRACTOR.

57.0 UNDERGROUND OBSTRUCTIONS

The soil investigation report furnished in the NIT is indicative only and is enclosed purely for information/guidance purpose to the bidders. The contractor shall carry out its own detailed soil investigation for the proposed plant. Design of the foundation system of the plant shall be based, only on the site specific report. Nothing extra shall be paid in case of any variation arising out of the soil report conducted by the bidders and the data given in the tender. In the event, CONTRACTOR encounters any underground obstructions, the same shall be removed by CONTRACTOR without any extra cost implications to the OWNER.

In the event, CONTRACTOR encounters any underground obstruction which entails cost implication to the CONTRACTOR, the OWNER shall consider to compensate the CONTRACTOR reasonable cost compensation and/or time extension, depending on merit of the case after mutual discussion. The decision of the ENGINEER-IN-CHARGE in this regard shall be in writing and shall be final and binding upon the CONTRACTOR. It is clarified that in case the CONTRACTOR disagrees with the decision of ENGINEER-IN-CHARGE, the dispute shall be settled as per the provision of clause 39 of GCC.

57.1 ARTICLES OF VALUE FOUND:



All gold, silver and other minerals of any description and all precious stones, coins, treasure relics, antiquities and other similar things which shall be found in, under or upon the SITE, shall be the property of the OWNER and the CONTRACTOR shall duly preserve the same to the satisfaction of the ENGINEER-IN-CHARGE and shall from time to time deliver the same to such person or persons indicated by the OWNER.

58.0 REGISTRATION OF THE CONTRACTOR WITH STATUTORY AUTHORITIES

Within 30 days of execution of the CONTRACT, the CONTRACTOR shall, insofar as necessary, register itself at their own cost with the applicable statutory authorities as required under the rules and regulations governing in India. The CONTRACT PRICE shall be deemed to include all costs towards the same. A copy of all documents related to all such registration shall be submitted to OWNER for record.

59.0 STATUTORY OBLIGATIONS

59.1 CONTRACTOR shall comply with the requirements of statutory provisions and shall be solely responsible for fulfilment of all legal obligations under Contract Labour (Regulation and Abolition) Act, Inter-state Migrant Workmen (Registration of Employment and Condition of Service) Act, Payment of Wages Act, Workmen Compensation Act, Factories Act, Employees Provident Fund and Misc. Provisions Act, Payment of Bonus Act, Payment of Gratuity Act, Industrial Disputes Act and all other applicable Industrial/Labour enactment and Rules made there under as applicable from time to time. In case OWNER incurs any liability towards payment of any kind whatsoever, due to non-fulfilment of statutory provisions under any industrial/labour law by CONTRACTOR, the same shall be made good by CONTRACTOR.

	EMERGENCY DIESEL GENERATOR PACKAGE		PC-183/E-4022/P-I/S-IV	0	
	TALCHER FERTILIZERS LIMITED, ODISHA (INDIA)		DOC. NO.	REV	
	GENERAL CONDITIONS OF CONTRACT (GCC)		SHEET 64 OF 75		

59.2 SUB-CONTRACTOR engaged by CONTRACTOR for performing civil and erection work/other jobs at SITE shall have PF Code No. in its name issued by Regional Provident Fund Commissioner (RPFC).

59.3 The CONTRACTOR shall ensure that the SUB-CONTRACTOR shall comply with the Statutory Requirements, as applicable, for the execution of this CONTRACT.

60.0 UTILISATION OF LOCAL RESOURCES

60.1 The CONTRACTOR shall ascertain the availability of local SUB-CONTRACTORS and skilled/unskilled manpower and engage them to the extent possible for performance of the WORKS.

60.2 The CONTRACTOR shall not recruit personnel of any category from among those who are already employed by the other agencies working at the site, but shall make maximum use of local labour available.

61.0 FUEL REQUIREMENT OF WORKERS

The CONTRACTOR shall be responsible to arrange for the fuel requirement of his workers and staff without resorting to cutting of trees and shrubs. Cutting of trees and shrubs is strictly prohibited for this purpose. The CONTRACTOR shall abide by the conditions put forth by the Environmental Clearance for the SITE as regards to construction workers.

62.0 SURPLUS MATERIAL



Notwithstanding anything provided elsewhere, all surplus materials shall be dealt as follows:

62.1 Any balance Indigenous/imported surplus MATERIALS including scrap shall belong to the CONTRACTOR upon completion of the WORKS and will be allowed to be taken back by CONTRACTOR after compliance of statutory formalities.

62.2 For taking out balance indigenous/imported surplus MATERIALS as mentioned above upon the completion of the project, the CONTRACTOR shall have to furnish proof of entry and ownership of such MATERIALS inside the SITE, certification of ENGINEER-IN-CHARGE and OWNER in this regard.

62.3 Following clause will apply only in case of applicability of concessional custom duty (presently, there is no applicability of concessional custom duty):

All imported surplus materials other than CONSTRUCTION EQUIPMENT which is brought to the SITE shall be the OWNER's property and shall be returned by the CONTRACTOR to the OWNER's designated stores. All such materials shall be subject to reconciliation and a proper accounting procedure shall be developed and strictly followed by the CONTRACTOR recorded in the inspection reports, proforma of which will be approved by the ENGINEER-IN-CHARGE. These reports shall form part of the completion DOCUMENTS. Inspection and acceptance of the WORK shall not relieve the CONTRACTOR from any of his responsibilities under this CONTRACT. However, indigenous Surplus Material as certified by the OWNER will be allowed to be taken back by Contractor after compliance of statutory formalities.

	EMERGENCY DIESEL GENERATOR PACKAGE	PC-183/E-4022/P-I/S-IV	0	
	TALCHER FERTILIZERS LIMITED, ODISHA (INDIA)	DOC. NO.	REV	
	GENERAL CONDITIONS OF CONTRACT (GCC)	SHEET 65 OF 75		

63.0 COORDINATION WITH OTHER AGENCIES

- 63.1 CONTRACTOR shall be responsible for proper coordination with other agencies operating at the site so that WORK may be carried out concurrently, without any hindrance to others. The ENGINEER-IN-CHARGE shall resolve disputes, if any, in this regard, and his decision shall be final and binding on the CONTRACTOR.
- 63.2 If and when required for the coordination of the WORKS with other agencies involved at SITE, the CONTRACTOR shall within the scope of work, re-route and/or prepare approaches and working areas as may be necessary.

64.0 ERECTION OF EQUIPMENT

All erection shall be carried out by deploying a crane(s) of suitable capacity. Erection by derrick shall not be permissible. The CONTRACTOR shall submit erection schemes for erection of critical equipment to ENGINEER-IN-CHARGE for his APPROVAL. No EQUIPMENT shall be erected in the absence of an approved erection scheme for such EQUIPMENT.

The quoted rates of the CONTRACTOR shall be deemed to include load testing of the crane as required to establish the lifting capacity of the crane.

65.0 ELECTRICAL CONTRACTOR'S LICENCE



- 65.1 The CONTRACTOR or its nominated SUB-CONTRACTOR(s), as the case may be, shall have a valid electrical contractor's license for working in the State in which the job site is located. The CONTRACTOR shall furnish a copy of the same to ENGINEER-IN-CHARGE before commencement of any electrical work or work pertaining to Electrical System.
- 65.2 No electrical work or work pertaining to electrical system(s) shall be permitted to be executed without a valid Electrical Contractors License being produced by the CONTRACTOR or SUB-CONTRACTOR, as the case may be, intending to execute the WORK.

66.0 RENTS & ROYALTIES

Unless otherwise specified, the CONTRACTOR shall pay all tonnage and other royalties, rents and other payments or compensation (if any) for getting stone, sand, gravel, clay, bricks or other materials required for the WORKS or any temporary works.

67.0 GOVERNMENT OF INDIA NOT LIABLE

It is expressly understood and agreed by and between the CONTRACTOR and the OWNER that the OWNER is entering into this agreement solely on its own behalf and not on behalf of any other person or entity. In particular, it is expressly understood and agreed that the Government of India is not a party to this agreement and has no liabilities, obligations or rights thereunder. It is expressly understood and agreed that the OWNER is an independent legal entity with power and authority to enter into contracts, solely in its own behalf under the applicable laws of India and general principles of Contract. The CONTRACTOR expressly agrees, acknowledges and understands that the OWNER is not an agent, representative or delegate of the Government of India. It is further understood and agreed that the Government of India is not and shall not be liable for any acts, omissions commissions, breaches or other wrongs arising out of the CONTRACT. Accordingly, CONTRACTOR hereby expressly waives, releases and foregoes any and all actions or claims, including cross claims or counter claims against the Government of India arising out of this CONTRACT and covenants not to sue the Government of India on

	EMERGENCY DIESEL GENERATOR PACKAGE	PC-183/E-4022/P-I/S-IV	0	
	TALCHER FERTILIZERS LIMITED, ODISHA (INDIA)	DOC. NO.	REV	
	GENERAL CONDITIONS OF CONTRACT (GCC)	SHEET 66 OF 75		

any matter, claim, and cause of action or thing whatsoever arising of or under this CONTRACT.

68.0 SITE CLEANING

The CONTRACTOR shall take care to keep clean the job site at all times for easy access to the job site and also from the safety point of view in accordance with the CONTRACT requirements.

69.0 ACCESS TO SITE

69.1 The CONTRACTOR shall at his own cost and initiative arrange for and provide any access to the work area and stringing or other yards for labour, EQUIPMENT and MATERIAL as may be necessary for any cause in addition to the ingress and egress available. Any arrangements in respect thereof as may be entered into by the CONTRACTOR with any person interested in the land through which access is sought, shall be in writing and a copy of the writing (certified by or on behalf of the CONTRACTOR to be true copy thereof) shall forthwith be lodged with the OWNER. Such a writing shall specifically stipulate that the OWNER shall not be responsible for any claims under the CONTRACT or for any damage, loss or injury to the land or any material, item or thing thereon or in, and the CONTRACTOR shall keep the OWNER indemnified from and against any claim, action or proceedings in respect thereof.

69.2 The CONTRACTOR shall at his own cost and initiative arrange for and obtain all necessary permissions, permits, consents and licenses as may be necessary to transport the MATERIALS, tools, EQUIPMENT, machinery and labour along or across any highway, roadway, or other way, or railway, tramway, bridge, dyke, dam or embankment, or lake, pond, canal, river, state terminal toll octroi, or other line, border or barrier. Traffic study if required, shall be carried out by CONTRACTOR independently without any liability on OWNER.

70.0 INDEPENDENT CONTRACTOR

70.1 Neither CONTRACTOR nor any SUB-CONTRACTOR nor the employees, agents or representative of either shall be deemed to be employees, agents or representative of the OWNER in the performance of the CONTRACT.



71.0 PAYEMENT TO THE SUB-CONTRACTOR

CONTRACTOR shall indemnify and hold harmless OWNER for any claim brought by SUBCONTRACTOR against OWNER in relation to CONTRACTOR's payment obligations for the relevant purchase orders and sub-contracts.

71.1 CONTRACTOR agrees that he shall furnish to OWNER, if requested, satisfactory evidence that all SUB-CONTRACTORS, including vendor to CONTRACTOR have been paid on the time and in full for work done or goods supplied, in connection with the performance of the WORK.

71.2 If evidence is not supplied, then the OWNER shall not be bound to make any further payment to CONTRACTOR for that part of work until it is paid by CONTRACTOR.

71.3 CONTRACTOR shall notify OWNER of any dispute of any kind between CONTRACTOR and any of his SUB-CONTRACTOR or vendors stating the nature of dispute, the amount of any payment which is being withheld by CONTRACTOR, the reasons thereof and the CONTRACTOR's plan to settle the dispute.

	EMERGENCY DIESEL GENERATOR PACKAGE	PC-183/E-4022/P-I/S-IV	0	
	TALCHER FERTILIZERS LIMITED, ODISHA (INDIA)	DOC. NO.	REV	
	GENERAL CONDITIONS OF CONTRACT (GCC)	SHEET 67 OF 75		

72.0 ORDER OF WORKS / PERMISSION / RIGHT OF ENTRY / CARE OF EXISTING SERVICES

CONTRACTOR is required to submit to OWNER the various details with respect to their personnel(s) to be deputed for the execution of WORK such as name(s), nationality and passport details in case of Foreign Nationals (Passport No., Date of Issue, Date of Expiry etc.). These details are required for granting permission to enter and work in the existing fertilizer complex. The OWNER reserves the right to declare any person(s) as non grata. No claim whatsoever shall be entertained by OWNER on this account.



OWNER shall have the right to object to any Representative or personnel deputed to India by CONTRACTOR for execution of WORK or in connection with WORK, due to their misconduct or breach of law and regulation or who are found to be incompetent or negligent. CONTRACTOR shall remove such persons from SITE forthwith and take immediate action for replacement at no cost to OWNER.

73.0 GIFTS, COMMISSIONS, ETC.

Any gift, commission or advantage given, promised or offered by or on behalf of the CONTRACTOR or his partner, agent, officers, directors, employee or servant or anyone on his or their behalf in relation to the obtaining or to the execution of this or any other contract with the OWNER, shall in addition to any criminal liability which it may incur, subject the CONTRACTOR to the cancellation of this and all other contracts and also the payment of any loss or damage to the OWNER resulting from any cancellation. The OWNER shall then be entitled to deduct the amounts so payable from any monies otherwise due to the CONTRACTOR under the CONTRACT.

74.0 LABOUR LAWS- PF, EPF AND ESI

- 74.1 The CONTRACTOR shall obtain necessary license from the Licensing Authority under the Contract Labour (Regulation & Abolition) Act 1970 and the Central Rules framed there under and produce the same to the ENGINEER-IN-CHARGE before start of WORK.
- 74.2 The CONTRACTOR shall not undertake or execute or permit any other agency or SUB-CONTRACTOR to undertake or execute any work on the CONTRACTOR'S behalf through contract labour except under and in accordance with the license issued in that behalf by the Licensing Officer or other authority prescribed under the Factories Act or the contract labour (Regulation & Abolition) Act 1970 or their applicable lay, rule or regulation, if applicable.
- 74.3 The provision of EPF & MP Act, 1952 and Rules scheme there under shall be applicable to the CONTRACTOR and the employees engaged by him for the WORK. The CONTRACTOR shall furnish the code number allotted by the RPFC Authority, to the ENGINEER-IN-CHARGE before commencing the WORK.
- 74.4 The CONTRACTOR shall be exclusively responsible for any delay in commencing the work on account of delay in obtaining a license under clause 74.1 above or in obtaining the code number under clause 74.3 above and the same shall not constitute a ground for extension of time for any purpose.
- 74.5 The CONTRACTOR shall enforce the provisions of ESI Act and Scheme framed from time to time there under with regard to all his employees involved in the performance of the CONTRACT and shall deduct employee's contribution from the wages of each of the employees and shall deposit the same together with employer's contribution of such total wages payable to the employees in the appropriate account.
- 74.6 All liabilities like salaries, wages and other statutory obligations in respect of the persons engaged by the CONTRACTOR shall be borne by the CONTRACTOR during the period

	EMERGENCY DIESEL GENERATOR PACKAGE		PC-183/E-4022/P-I/S-IV	0	
	TALCHER FERTILIZERS LIMITED, ODISHA (INDIA)		DOC. NO.	REV	
	GENERAL CONDITIONS OF CONTRACT (GCC)		SHEET 68 OF 75		

of agreement. In view of the provisions of the ESI Act, PF and EPF Act and other Acts, as may be applicable to OWNER, the CONTRACTOR shall take necessary steps to cover its employees under the said enactments and shall submit proof of such compliance to ENGINEER-IN-CHARGE periodically or at any date upon such request, as may be made by ENGINEER-IN-CHARGE to the CONTRACTOR. In the event of non-compliance with the statute or the provisions thereof, referred to above, it shall be open to OWNER to withhold such amount as in its opinion is due and payable by the CONTRACTOR in respect of its employees from and out of dues, payable by OWNER to the CONTRACTOR and such due shall be held by OWNER with it until proof is submitted by the CONTRACTOR to OWNER indicating compliance with such statutes within reasonable time, failing which OWNER shall deposit such amounts with the authorities concerned on behalf of the CONTRACTOR and inform the CONTRACTOR of such deposit or deposits.

75.0 GENERAL PROVISIONS

75.1 Confidential Information

75.1.1 Non-disclosure

Each party agrees to hold in confidence any information imparted to it or in the case of CONTRACTOR, to any of its SUB- CONTRACTOR / VENDOR, by the other Party which pertains to that other party's business activity in any manner, and which is not be subject of general public knowledge, including, without limitation, proprietary processes, technical information and know-how, information concerning other projects, management policies, economic policies, financial and other data and the like. The preceding non-disclosure requirements shall not apply to:



- i) Information furnished without restriction by the other Party prior to the date hereof
- ii) Information in the public domain; or
- iii) Information obtained by a Party from a third Person not under obligation of non-disclosure to the other party.
- (iv) Information required to be disclosed in pursuance of an order, judgement, decree of the Court, Tribunal or Statutory Authority.

75.1.2 Disclosure to Govt. Agency

Either Party may disclose any such information to the extent that such Party is required by any Government Agency to make such disclosure. In addition, OWNER may disclose such information to the extent that such disclosure is required by any Lender / Lender's Representative, etc. provided that such Lenders signed a confidentiality agreement containing confidentiality and limited use obligations not less stringent than those accepted by OWNER under the CONTRACT and License Agreement, if any and such parties are not competitor of CONTRACTOR or its Licensors.

75.1.3

Upon completion of the Works or in the event of termination pursuant to the provisions of the CONTRACT, CONTRACTOR shall immediately return to the OWNER all drawings, plans, specifications and other documents supplied to the CONTRACTOR by or on behalf of the OWNER or prepared by the CONTRACTOR solely for the purpose of the performance of the WORKS, including all copies made thereof by the CONTRACTOR.

	EMERGENCY DIESEL GENERATOR PACKAGE	PC-183/E-4022/P-I/S-IV	0	
	TALCHER FERTILIZERS LIMITED, ODISHA (INDIA)	DOC. NO.	REV	
	GENERAL CONDITIONS OF CONTRACT (GCC)	SHEET 69 OF 75		

75.1.4 This clause shall survive and remain in full force for a period of ten years following the issue of FINAL ACCEPTANCE CERTIFICATE.

75.2 Cut-Off Dates

No claims or correspondence on claims on this CONTRACT shall be entertained by either parties after 6 months after expiry of the Contract Performance Security unless specified otherwise in CONTRACT.

75.3 Recovery of Sums / Dues

75.3.1 All costs, damages or expenses which OWNER may have incurred, for which CONTRACTOR is liable under CONTRACT, shall be notified to CONTRACTOR and shall be recovered by OWNER from any payment due to or becoming due to CONTRACTOR under this CONTRACT or other CONTRACT and/or shall be recovered by action at law or otherwise. If the payment due to CONTRACTOR is not sufficient for recovery of the said sums/dues, CONTRACTOR shall pay immediately to OWNER such sums/dues or the balance sums/dues on demand.

75.3.2 All MUTUALLY AGREED DAMAGES applicable and to be recovered from CONTRACTOR under CONTRACT, shall be recovered by OWNER from any payment due to or becoming due to CONTRACTOR under this CONTRACT or other CONTRACT and/or shall be recovered by action at law or otherwise. If the payment due to CONTRACTOR is not sufficient for recovery of the said MUTUALLY AGREED DAMAGES, CONTRACTOR shall pay immediately to OWNER such MUTUALLY AGREED DAMAGES. or the balance MAD on demand.

75.3.3 For avoidance of doubt all the rights and remedies of OWNER/CONTRACTOR and liabilities of the CONTRACTOR/OWNER as set out in the CONTRACT shall be to the exclusion of any other rights, remedies or liabilities available at law.

75.4 Payments etc. not to affect rights of OWNER

No sum paid on account by OWNER nor any extension of the date for completion granted by OWNER shall affect or prejudice the rights of OWNER against CONTRACTOR or relieve CONTRACTOR of its obligation for the faithful performance of CONTRACT.



75.5 Site Working and Safety Conditions

CONTRACTOR shall follow the SITE working and safety conditions enclosed as Section VI-13.

75.6 Miscellaneous

75.6.1 No CONTRACT or understanding in any way modifying the conditions of CONTRACT shall be binding upon either parties hereto unless made in writing and approved by both parties.

75.6.2 Without prejudice to FORCE MAJEURE, CONTRACTOR shall, during inclement weather, carry out WORK in accordance with CONTRACT and CONTRACTOR shall not be entitled to any additional payment over and above the CONTRACT PRICE payable under CONTRACT by reason of its being unable to carry out WORK owing to inclement weather.

	EMERGENCY DIESEL GENERATOR PACKAGE	PC-183/E-4022/P-I/S-IV	0	
	TALCHER FERTILIZERS LIMITED, ODISHA (INDIA)	DOC. NO.	REV	
	GENERAL CONDITIONS OF CONTRACT (GCC)	SHEET 70 OF 75		

76.0 Implementation of Apprentices act 1961:

The CONTRACTOR shall comply with the provisions of the Apprentices Act, 1961 and the Rules and Orders issued thereunder from time to time. If he fails to do so, his failure will be a breach of the CONTRACT and the ENGINEER-IN-CHARGE may, at his discretion, cancel the CONTRACT. The CONTRACTOR shall also be liable for any pecuniary liability arising on account of any violation by him of the provisions, of the Act.

77.0 Change in constitution

Where the CONTRACTOR is a partnership firm, the prior approval of the OWNER shall be obtained in writing, before any change is made in the constitution of the firm. Where the CONTRACTOR is an individual or a Hindu undivided family business concern, such approval as aforesaid shall, likewise be obtained before such CONTRACTOR enters into any agreement with other parties, where under, the reconstituted firm would have the right to carry out the work hereby undertaken by the CONTRACTOR. In either case if prior approval as aforesaid is not obtained, the CONTRACT shall be deemed to have been allotted in contravention of clause 12 of GCC and the same action may be taken and the same consequence shall ensure as provided in the said clause.

78.0 Access by Road:

CONTRACTOR, if necessary, shall build other temporary access roads to the actual site of construction for his own work at his own cost. The CONTRACTOR shall be required to permit the use of the roads so constructed by him for vehicles of any other parties who may be engaged on the project site. The CONTRACTOR shall also facilitate the construction of the permanent roads should the construction there of start while he is engaged on this work. He shall make allowance in his tender for any inconvenience he anticipates on such account. Non-availability of access roads, railway siding and railway wagons for the use of the CONTRACTOR shall in no case condone any delay in the execution of WORK nor be the cause for any claim for compensation against the OWNER.

79.0 Members of the OWNER not individually liable:



No Director, or official or employee of the OWNER/ PMC shall in any way be personally bound or liable for the acts or obligations of the OWNER under the CONTRACT or answerable for any default or omission in the observance or performance of any of the acts, matters or things which are herein contained.

80.0 OWNER not bound by personal representations:

The CONTRACTOR shall not be entitled to any increase on the scheduled rates or any other right or claim whatsoever by reason of any representation, explanation statement or alleged representation, promise or guarantees given or alleged to have been given to him by any person.

81.0 Land for Contractor's Field Office, Godown and Workshop:

The OWNER will, at his own discretion and convenience and for the duration of the execution of the work make available near the site, land for construction of CONTRACTOR's Temporary Field Office, godowns workshops and assembly yard required for the execution of the CONTRACT. The CONTRACTOR shall at his own cost construct all these temporary buildings and provide suitable water supply and sanitary arrangement and get the same approved by the ENGINEER-IN-CHARGE. On completion of the works undertaken by the CONTRACTOR, he shall remove all temporary works erected by him and have the SITE cleaned as directed by ENGINEER-IN-CHARGE. If the CONTRACTOR shall fail to comply with these requirements, the ENGINEER-IN-

	EMERGENCY DIESEL GENERATOR PACKAGE	PC-183/E-4022/P-I/S-IV	0	
	TALCHER FERTILIZERS LIMITED, ODISHA (INDIA)	DOC. NO.	REV	
	GENERAL CONDITIONS OF CONTRACT (GCC)	SHEET 71 OF 75		

CHARGE may at the expenses of the CONTRACTOR remove such surplus, and rubbish materials and dispose-off the same as he deems fit and get the site cleared as aforesaid; and CONTRACTOR shall forthwith pay the amount of all expenses so incurred and shall have no claim in respect of any such surplus materials disposed off as aforesaid. But the OWNER reserves the right to ask the CONTRACTOR any time during the pendency of the CONTRACT to vacate the land by giving 7 days' notice on security reasons or on national interest or otherwise. Rent may be charged for the land so occupied from contractor by the OWNER. The CONTRACTOR shall put up temporary structures as required by them for their office, fabrication shop and construction stores only in the area allocated to them on the project site by the OWNER or his authorized representative. No tea stalls/canteens should be put up or allowed to be put up by any CONTRACTOR in the allotted land or complex area without written permission of the OWNER. Un-authorized buildings, constructions or structures should not be put up by the CONTRACTOR anywhere on the project site. For uninterrupted fabrication work, the CONTRACTOR shall put up temporary covered structures at his cost within Area in the location allocated to them in the project site by the OWNER or his authorized representative. No person except for authorized watchman shall be allowed to stay in the plant area/CONTRACTOR's area after completion of the day's job without prior written permission from ENGINEER-IN-CHARGE.

82.0 Rounding-Off of Amounts:

In calculating the amount of each item due to the CONTRACTOR in every certificate prepared for payment, sum of less than 50 paise shall be omitted and the total amount on each certificate shall be rounded off to the nearest rupees, i.e., sum of less than 50 paise shall be omitted and sums of 50 paise and more upto one rupee shall be reckoned as one rupee.



83.0 Deleted

84.0 Work In Monsoon and Dewatering

- (i) Unless otherwise specified elsewhere in the tender, the execution of the WORK may entail working in the monsoon also. The CONTRACTOR must maintain a minimum labour force as may be required for the job and plan and execute the construction and erection according to the prescribed schedule. No extra rate will be considered for such work in monsoon.
- (ii) During monsoon and other period, it shall be the responsibility of the CONTRACTOR to keep the construction work site free from water at his own cost.

85.0 General conditions for construction and erection work:

- (i) The working time at the site of work is 48 hours per week. Overtime work is permitted in cases of need and the OWNER will not compensate the same. Shift working at 2 or 3 shifts per day will become necessary and the CONTRACTOR should take this aspect into consideration for formulating his rates for quotation. No extra claims will be entertained by the OWNER on this account. No extra claims will be entertained by the OWNER on this account. For carrying out work beyond working hours the CONTRACTOR will approach the ENGINEER-IN-CHARGE or his authorized representative and obtain his prior written permission.
- (ii) The CONTRACTOR must arrange for the placement of workers in such a way that the delayed completion of the WORK or any part thereof for any reason whatsoever will not affect their proper employment. The OWNER will not entertain any claim for idle time payment whatsoever.

	EMERGENCY DIESEL GENERATOR PACKAGE	PC-183/E-4022/P-I/S-IV	0	
	TALCHER FERTILIZERS LIMITED, ODISHA (INDIA)	DOC. NO.	REV	
	GENERAL CONDITIONS OF CONTRACT (GCC)	SHEET 72 OF 75		



- (iii) The CONTRACTOR shall submit to the OWNER/ENGINEER-IN-CHARGE reports at regular intervals regarding the state and progress of WORK. The details and proforma of the report will mutually be agreed after the award of CONTRACT. The CONTRACTOR shall provide display boards showing progress and labour strengths at worksite, as directed by the ENGINEER-IN-CHARGE.

86.0 Action where no specification is issued:

In case of any class of WORK for which there is no SPECIFICATION supplied by the OWNER as mentioned in the Tender Documents such WORK shall be carried out in accordance with Indian Standard Specifications and if the Indian Standard Specifications do not cover the same, the WORK should be carried out as per standard Engineering Practice subject to the approval of the ENGINEER-IN-CHARGE.

87.0 Care of Works:

- i) From the commencement to completion of the WORK, the CONTRACTOR shall take full responsibility for the care for all works including all temporary works and in case any damages, loss or injury shall happen to the WORK or to any part thereof or to any temporary works from any cause whatsoever, shall at his own cost repair and make good the same so that at completion the WORK shall be in good order and in conformity in every respects with the requirement of the CONTRACT and the ENGINEER-IN-CHARGE's instructions.
- ii) **Defects Prior To Taking Over:** If at any time, before the WORK is taken over, the ENGINEER-IN-CHARGE shall: a) Claim that any works done or materials used by the CONTRACTOR or by any SUB-CONTRACTOR is defective or not in accordance with the CONTRACT, or that the works or any portion thereof are defective, or do not fulfill the requirements of CONTRACT (all such matters being hereinafter, called 'Defects' in this clause), and b) As soon as reasonably practicable, gives to the CONTRACTOR notice in writing of the said decision, specifying particulars of the defects alleged to exist or to have occurred, then the CONTRACTOR shall at his own expenses and with all speed make good the defects so specified. In case CONTRACTOR shall fail to do so, the OWNER may take, at the cost of the CONTRACTOR, such steps as may in all circumstances, be reasonable to make good such defects. The expenditure so incurred by the OWNER will be recovered from the amount due to the CONTRACTOR. The decision of the ENGINEER-IN-CHARGE with regard to the amount to be recovered from the CONTRACTOR will be final and binding on the CONTRACTOR. As soon as the WORK has been completed in accordance with the CONTRACT (except in minor respects that do not affect their use for the purpose for which they are intended and except for maintenance thereof provided in clause 3.0 (22) of General Conditions of Contract) and have passed the tests on completion, the ENGINEER-IN-CHARGE shall issue a certificate (hereinafter called Completion Certificate) in which he shall certify the date on which the WORK have been so completed and have passed the said tests and the OWNER shall be deemed to have taken over the WORK on the date so certified. If the WORK has been divided into various groups in the CONTRACT, the OWNER shall be entitled to take over any group or groups before the other or others and there upon the ENGINEER-IN-CHARGE shall issue a Completion Certificate which will, however, be for such group or groups so taken over only. In such an event if the group /section/ part so taken over is related, to the integrated system of the work, notwithstanding date of grant of Completion Certificate for group/ section/ part.
- iii) **Defects After Taking Over:** In order that the CONTRACTOR could obtain a COMPLETION CERTIFICATE he shall make good, with all possible speed, any

	EMERGENCY DIESEL GENERATOR PACKAGE	PC-183/E-4022/P-I/S-IV	0	
	TALCHER FERTILIZERS LIMITED, ODISHA (INDIA)	DOC. NO.	REV	
	GENERAL CONDITIONS OF CONTRACT (GCC)	SHEET 73 OF 75		

defect arising from the defective materials supplied by the CONTRACTOR or workmanship or any act or omission of the CONTRACT or that may have been noticed or developed, after the works or groups of the works has been taken over, the period allowed for carrying out such WORK will be normally one month. If any defect is not remedied within a reasonable time, the OWNER may proceed to do the WORK at CONTRACTOR's risk and expense and deduct from the final bill such amount as may be decided by the OWNER. If by reason of any default on the part of the CONTRACTOR a COMPLETION CERTIFICATE has not been issued in respect of any portion of the WORK within one month after the date fixed by the CONTRACT for the completion of the WORK, the OWNER shall be at liberty to use the WORK or any portion thereof in respect of which a completion certificate has not been issued, provided that the WORK or the portion thereof so used as aforesaid shall be afforded reasonable opportunity for completing these works for the issue of Completion Certificate.

- iv) COMPLETION CERTIFICATE' where ever mentioned shall be read as 'PRELIMINARY ACCEPTANCE CERTIFICATE'

88.0 Field Management & Controlling / Coordinating Authority:



- i) The field management will be the responsibility of the ENGINEER-IN-CHARGE, who will be nominated by the OWNER. The ENGINEER-IN-CHARGE may also authorize his representatives to assist in performing his duties and functions.
- ii) The ENGINEER-IN-CHARGE shall coordinate the works of various agencies engaged at site to ensure minimum disruption of work carried out by different agencies. It shall be the responsibility of the CONTRACTOR to plan and execute the work strictly in accordance with site instructions to avoid hindrance to the work being executed by other agencies.

89.0 Local Conditions:

- i) It will be imperative on each tenderer to inform himself of all local conditions and factors which may have any effect on the execution of WORK covered under the Tender Document. In their own interest, the tenderer are requested to familiarize themselves with the Indian Income Tax Act 1961, Indian Companies Act 1956/2013, Indian Customs Act 1962 and other related Acts and Laws and Regulations of India with their latest amendments, as applicable. TFL shall not entertain any requests for clarifications from the tenderer regarding such local conditions.
- ii) It must be understood and agreed that such factors have properly been investigated and considered while submitting the tender. No claim for financial or any other adjustments to VALUE OF CONTRACT, on lack of clarity of such factors shall be entertained.

90.0 Special Conditions of Contract:

- i) Special Conditions of Contract (SCC) shall be read in conjunction with the General Conditions of Contract (GCC), specification of Work, Drawings and any other documents forming part of this CONTRACT wherever the context so requires.
- ii) Notwithstanding the sub-division of the documents into these separate sections and volumes every part of each shall be deemed to be supplementary to and complementary of every other part and shall be read with and into the CONTRACT so far as it may be practicable to do so.
- iii) Where any portion of the General Condition of Contract is repugnant to or at variance with any provisions of the Special Conditions of Contract, unless a different intention

	EMERGENCY DIESEL GENERATOR PACKAGE	PC-183/E-4022/P-I/S-IV	0	
	TALCHER FERTILIZERS LIMITED, ODISHA (INDIA)	DOC. NO.	REV	
	GENERAL CONDITIONS OF CONTRACT (GCC)	SHEET 74 OF 75		



appears the provisions of the Special Conditions of Contract shall be deemed to over-ride the provisions of the General Conditions of Contract and shall to the extent of such repugnancy, or variations, prevail.

- iv) Wherever it is mentioned in the specifications that the CONTRACTOR shall perform certain WORK or provide certain facilities, it is understood that the CONTRACTOR shall do so at his cost and the VALUE OF CONTRACT shall be deemed to have included cost of such performance and provisions, so mentioned.
- v) The materials, design and workmanship shall satisfy the relevant INDIAN STANDARDS, the JOB SPECIFICATIONS contained herein and CODES referred to. Where the job specification stipulate requirements in addition to those contained in the standard codes and specifications, these additional requirements shall also be satisfied.

91.0 POWER OF ENTRY:

- 1) If the CONTRACTOR shall not commence the WORK in the manner previously described in the CONTRACT documents or if he shall at any time in the opinion of the ENGINEER-IN-CHARGE -
 - i) fail to carry out the WORK in conformity with the CONTRACT documents, or
 - ii) fail to carry out the WORK in accordance with the Time Schedule, or
 - iii) substantially suspend work or the WORK for a period of fourteen days without authority from the ENGINEER-IN-CHARGE, or
 - iv) fail to carry out and execute the WORK to the satisfaction of the ENGINEER-IN-CHARGE, or
 - v) fail to supply sufficient or suitable construction plant, temporary works, labour, materials or things, or
 - vi) Commit, suffer, or permit any other breach of any of the provisions of the CONTRACT on his part to be performed or observed or persist in any of the above mentioned breaches of the CONTRACT for fourteen days, after notice in writing shall have been given to the CONTRACTOR by the ENGINEER-IN-CHARGE requiring such breach to be remedied, or
 - vii) if the CONTRACTOR shall abandon the WORK , or
 - viii) If the CONTRACTOR during the continuance of the CONTRACT shall become bankrupt, make any arrangement or composition with his creditors, or permit any execution to be levied or go into liquidation whether compulsory or voluntary not being merely a voluntary liquidation for the purpose of amalgamation or reconstruction

then in any such case, the OWNER shall have the power to enter upon the WORK and take possession thereof and of the materials, temporary WORK, construction plant, and stock thereon, and to revoke the CONTRACTOR's license to use the same, and to complete the WORK by his agents, other CONTRACTORS or workmen or to relate the same upon any terms and to such other person, firm or corporation as the OWNER in his absolute discretion may think proper to employ and for the purpose aforesaid to use or authorize the use of any materials, temporary work, CONSTRUCTION PLANT, and stock as aforesaid, without making payment or allowance to the CONTRACTOR for the said materials other than such as may be certified in writing by the ENGINEER-IN-CHARGE to be reasonable, and without making any payment or allowance to the CONTRACTOR for the use of the temporary said works, construction plant and stock or being liable for any loss or damage thereto, and if the OWNER shall by reason of his taking possession of the WORK or of the WORK being completed by other CONTRACTOR (due account being taken of any such extra work or works which may or be omitted) then the amount of such



	EMERGENCY DIESEL GENERATOR PACKAGE		PC-183/E-4022/P-I/S-IV	0	
	TALCHER FERTILIZERS LIMITED, ODISHA (INDIA)		DOC. NO.	REV	
	GENERAL CONDITIONS OF CONTRACT (GCC)		SHEET 75 OF 75		

excess as certified by the ENGINEER-IN-CHARGE shall be deducted from any money which may be due for work done by the CONTRACTOR under the CONTRACT and not paid for. Any deficiency shall forthwith be made good and paid to the OWNER by the CONTRACTOR and the OWNER shall have power to sell in such manner and for such price as he may think fit all or any of the construction plant, materials etc. constructed by or belonging to and to recoup and retain the said deficiency or any part thereof out of proceeds of the sale.

92.0



LIENS:

- 1) If, at any time there should be evidence or any lien or claim for which the OWNER might have become liable and which is chargeable to the CONTRACTOR, the OWNER shall have the right to retain out of any payment then due or thereafter to become due an amount sufficient to completely indemnify the OWNER against such lien or claim and if such lien or claim be valid, the OWNER may pay and discharge the same and deduct the amount so paid from any money which may be or may become due and payable to the CONTRACTOR. If any lien or claim remain unsettled after all payments are made, the CONTRACTOR shall refund or pay to the OWNER all money that the latter may be compelled to pay in discharging such lien or claim including all costs and reasonable expenses. OWNER reserves the right to do the same.
- 2) The OWNER shall have lien on all materials, equipments including those brought by the CONTRACTOR for the purpose of erection, testing and commissioning of the WORK.
- 3) The final payment shall not become due until the CONTRACTOR delivers to the ENGINEER-IN-CHARGE a complete release or waiver of all liens arising or which may arise out of his agreement or receipt in full or certification by the CONTRACTOR in a form approved by ENGINEER-IN-CHARGE that all invoices for labour, materials, services have been paid in lien thereof and if required by the ENGINEER-IN-CHARGE in any case an affidavit that so far as the CONTRACTOR has knowledge or information the releases and receipts include all the labour and material for which a lien could be filled.
- 4) CONTRACTOR will indemnify and hold the OWNER harmless, for a period of two years after the issue of FINAL ACCEPTANCE CERTIFICATE, from all liens and other encumbrances against the OWNER on account of debts or claims alleged to be due from the CONTRACTOR or his SUB-CONTRACTOR to any person including SUB-CONTRACTOR and on behalf of OWNER will defend at his own expense, any claim or litigation brought against the OWNER or the CONTRACTOR in connection therewith. CONTRACTOR shall defend or contest at his own expense any fresh claim or litigation by any person including his SUB-CONTRACTOR, till its satisfactory settlement even after the expiry of two years from the date of issue of FINAL CERTIFICATE.

	EMERGENCY DIESEL GENERATOR PACKAGE TALCHER FERTILIZERS LIMITED, ODISHA (INDIA) SPECIAL CONDITIONS OF CONTRACT	PC183/E-4022/P-I/S-V	0	
		DOC. NO.	REV	
		SHEET 1 OF 45		



SECTION – V

SPECIAL CONDITIONS OF CONTRACT

	EMERGENCY DIESEL GENERATOR PACKAGE TALCHER FERTILIZERS LIMITED, ODISHA (INDIA) SPECIAL CONDITIONS OF CONTRACT	PC183/E-4022/P-I/S-V	0	
		DOC. NO.	REV	
		SHEET 2 OF 45		

CONTENT

SL.NO.	DESCRIPTION
	GENERAL
1.0	CONTRACTOR'S OBLIGATIONS
2.0	OWNER'S OBLIGATIONS
3.0	CHANGE IN WORK/CHANGE ORDER
4.0	ACCEPTANCE OF PLANTS AND FACILITIES
5.0	PLANT ACCEPTANCE CRITERIA
6.0	ISSUANCE OF PRELIMINARY ACCEPTANCE CERTIFICATE
7.0	LABOUR AND STAFF
8.0	TRAINING OF OWNER'S PERSONNEL
9.0	MODE OF CONTRACTING
10.0	FINAL BILL
11.0	DELETED
12.0	DELETED
13.0	STATUTORY VARIATION IN TAXES AND DUTIES
14.0	PAYMENT TERMS
15.0	BILLING SCHEDULE
16.0	DEEMED ACCEPTANCE
17.0	LIABILITY FOR DEFECTS
18.0	PERFORMANCE TESTS
19.0	FINAL ACCEPTANCE CERTIFICATE
20.0	COMPLETION PERIOD
21.0	MUTUALLY AGREED DAMAGES (MAD)
22.0	OVERALL CEILING ON TOTAL LIABILITY
23.0	ASSIGNMENT OF CONTRACT
24.0	PLANNING AND DESIGNING IN PURVIEW OF VULNERABILITY ATLAS OF INDIA
25.0	STANDARD CONDITIONS OF SCC: PART I TO PART III

	EMERGENCY DIESEL GENERATOR PACKAGE	PC183/E-4022/P-I/S-V	0	
	TALCHER FERTILIZERS LIMITED, ODISHA (INDIA)	DOC. NO.	REV	
	SPECIAL CONDITIONS OF CONTRACT	SHEET 3 OF 45		

GENERAL

The SPECIAL CONDITIONS OF CONTRACT shall be read in conjunction with the GENERAL CONDITIONS OF CONTRACT, specifications of work, DRAWINGS and any other document forming part of this CONTRACT wherever the context so requires.

Where any portion of the GENERAL CONDITIONS OF CONTRACT is repugnant to or at variance with any other provisions of the SPECIAL CONDITIONS OF CONTRACT, then unless a different intension appears, the SPECIAL CONDITIONS OF CONTRACT shall be deemed to over-ride the provisions of GENERAL CONDITIONS OF CONTRACT and shall prevail to the extent of such repugnancy or variations.



1.0 CONTRACTOR'S OBLIGATIONS

1.1.0 General Responsibility

1.1.1 The CONTRACTOR acknowledges that this CONTRACT is a Lumpsum turnkey contract and CONTRACTOR'S obligation hereunder, notwithstanding anything to the contrary contained herein, is to provide OWNER with fully operational PLANT, complete in all respects under and in accordance with the provision of CONTRACT, within the stipulated time and for the purpose designated herein by OWNER, and to do, furnish and provide everything necessary in connection therewith.

Without prejudice to the foregoing and except as otherwise expressly set forth in the CONTRACT as within the scope of OWNER'S obligations under the CONTRACT, the CONTRACTOR shall perform or cause to be performed all WORK and services required in connection with the design, engineering, Manufacturing, supply of equipment, procurement (including, without limitation, all transportation services in connection therewith), Third Party Inspection (TPI) as applicable, Expediting, Site Survey and Condition Assessment, Insurance, Construction and Erection of all Civil & structural, Mechanical, Electrical and Instrumentation Works, Assembly and Installation of Equipments, Obtaining all necessary Statutory Approvals, Pre-Commissioning, Commissioning including conducting of Performance Tests and other work and services upto the PRELIMINARY ACCEPTANCE OF PLANT by the OWNER including one (01) months supervisory assistance after successful commissioning and in connection therewith provide all materials, equipment, machinery, tools, labour, transportation, administration and other services and items required to complete the PLANT in all respects upto the PRELIMINARY ACCEPTANCE OF PLANT and having the performance as guaranteed under the CONTRACT by the CONTRACTOR on a total, fixed price basis in accordance with this CONTRACT.

'PLANT' for this NIT shall mean the '11kV, 2000 KVA Diesel Generator (03 Nos.) with Emergency Power and Synchronization Board on package basis" in the Technical Section of NIT.

	EMERGENCY DIESEL GENERATOR PACKAGE	PC183/E-4022/P-I/S-V	0	
	TALCHER FERTILIZERS LIMITED, ODISHA (INDIA)	DOC. NO.	REV	
	SPECIAL CONDITIONS OF CONTRACT	SHEET 4 OF 45		



The WORK shall, without prejudice to the generality of the foregoing or those enumerated in Clause 1.2.0 include but not be limited to the following:

- (a) All engineering and design services including necessary investigation required for a completely engineered PLANT including necessary documentation;
- (b) Provision of all equipment, systems, materials, processes, CONTRACTOR'S EQUIPMENT, temporary works and all other items, whether of a temporary or permanent nature including those required for the design, erection, Pre-commissioning, commissioning, conducting of PERFORMANCE GUARANTEE TEST RUN and remedying of DEFECTS during DEFECT LIABILITY PERIOD.
- (c) Transportation from works, port of entry and import clearance and handling services in and into India and inland transportation from the relevant points of delivery of EQUIPMENT required in connection with the completion of the PLANT, and the performance of the other WORK
- (d) Project management.
- (e) Receipt of EQUIPMENT at SITE including stores management.
- (f) Construction infrastructure services, civil and structural construction; mechanical, electrical and instruments erection and installation services, inspection, testing and commissioning, and PERFORMANCE GUARANTEE TEST RUN before PRELIMINARY ACCEPTANCE of PLANT including all relevant applicable permits, with CONTRACTOR having responsibility for overall co-ordination of permits required by the OWNER and all training activities;
- (g) Provision of all necessary superintendence, labour, construction fuels and construction chemicals, tools, supplies and other consumables and services;



Construction water (at one point within factory premises and CONTRACTOR to arrange the line upto their Battery Limit) and Construction Power (1 No. 11 kV feeder of 2 MVA at Existing Substation Near 132 kV Switchyard and CONTRACTOR to arrange tap off Power from this feeder) shall be provided within 3 months of issuance of FOA on chargeable basis (presently @ of Rs 4.50/m³for Construction Water and Rs 5.915/KWH for Construction Power. In case of any escalation by statutory authorities in the unit rates during execution of Contract, the same shall be borne by Contractor)

Utilities as defined in Technical part of Section VI-2.0 of NIT and shall be made available to the LSTK CONTRACTOR at one point of battery limit 2 months before scheduled Completion Period. However required utilities prior to this will be arranged by LSTK CONTRACTOR.

- (h) Rectification of defects during DEFECT LIABILITY PERIOD.

	EMERGENCY DIESEL GENERATOR PACKAGE	PC183/E-4022/P-I/S-V	0	
	TALCHER FERTILIZERS LIMITED, ODISHA (INDIA)	DOC. NO.	REV	
	SPECIAL CONDITIONS OF CONTRACT	SHEET 5 OF 45		

- 1.1.2 CONTRACTOR shall provide services for PLANT, in accordance with good engineering practice. CONTRACTOR shall provide services of engineers, designers, draftsmen, buyers, inspectors, expeditors and other persons required for the performance of WORK pursuant to CONTRACT.
- 1.1.3 In the event that there is any item of EQUIPMENT or WORK of the type provided for in CONTRACT, which is not specifically mentioned in the specifications or drawings set out in FINAL PROPOSAL, but which is necessary (even though not mentioned in CONTRACT) for normal, safe and continuous operation of PLANT, CONTRACTOR shall include such item of EQUIPMENT in the design and perform such items of WORK, for such EQUIPMENT or WORK free of cost to OWNER as if the same had been originally included in its Scope of Work/FINAL PROPOSAL.
- 1.1.4 Subject to prior consent of OWNER, CONTRACTOR may make use of the services of SUB-CONTRACTOR/ VENDOR (approved in writing by the OWNER) in accordance with the provisions in CONTRACT provided, however, the CONTRACTOR shall remain responsible and liable for the work done by such SUB-CONTRACTOR/vendor.
- 1.1.5 The CONTRACTOR shall be responsible for obtaining necessary approvals which are to be issued in the CONTRACTOR's name from the various statutory authorities. All approvals/permissions other than Environment Clearance and Consent to Establish/Operate shall be obtained by the CONTRACTOR.
- 1.1.6 The CONTRACTOR shall provide necessary full technical assistance to OWNER including follow-up for obtaining the necessary approvals to be issued in the name of OWNER from the various statutory authorities.
- 1.1.7 The CONTRACTOR shall furnish CONTRACT PERFORMANCE SECURITY as per the enclosed format in line with the provisions of bidding document.
- 1.1.8 The enumeration in subsequent Clauses of SPECIAL CONDITIONS OF CONTRACT, in GENERAL CONDITIONS OF CONTRACT and other documents of CONTRACT shall not in any manner limit the general scope of obligations and responsibilities of designing, engineering, procurement, supply, construction, commissioning and proving the performance guarantees of PLANT within the scope of CONTRACT.
- 1.2.0 CONTRACTOR's Scope of Work**
- 1.2.1 CONTRACTOR shall provide and be responsible for the tasks specified in this Clause under the following heads:
- 1.2.2 Deleted
- 1.2.3 Design & Engineering**
- 1.2.3.1 CONTRACTOR shall provide all design and engineering services necessary for completion of the PLANTS in conformity with the CONTRACT and Good Engineering Practices and the NIT including but not limited to:
-

	EMERGENCY DIESEL GENERATOR PACKAGE TALCHER FERTILIZERS LIMITED, ODISHA (INDIA) SPECIAL CONDITIONS OF CONTRACT	PC183/E-4022/P-I/S-V	0	
		DOC. NO.	REV	
		SHEET 6 OF 45		



- (a) Preparation of
- Project design book which shall form the basis of PLANT design;
 - The conceptual design; and
 - The engineering and design necessary to describe and detail the PLANT and the Project.
- (b) Provision of criteria for the detailed design by other suppliers of equipment/system/structures for incorporation into the PLANTS.
- (c) Preparation of design, engineering, drawings, plans, bill of material, schedule and estimates for the PLANT and the project and the performance by CONTRACTOR of its obligations hereunder so that the PLANT constructed and commissioned by the CONTRACTOR is capable of meeting the performance guarantees and will be such as could be legally, safely and reliably placed in commercial operation by the OWNER.
- (d) CONTRACTOR shall perform the design and engineering for PLANT so that when constructed and commissioned, PLANT shall be capable of meeting the guarantees with respect to consumption utilities, and Pollution Level as guaranteed under CONTRACT and shall be reliable and safe and operable in accordance with the sound engineering practice. CONTRACTOR shall ensure design capacity of all sections of PLANT in accordance with CONTRACTOR's experience vis-a-vis as indicated in this NIT and expertise for obtaining a full throughput under varying conditions within the limits specified in CONTRACT. PLANT shall be designed so as to be capable of producing at full plant capacity when operated as specified in CONTRACT. CONTRACTOR shall review the basic design conditions and other conditions furnished by OWNER in NIT. If CONTRACTOR observes any inconsistency or insufficiency in these data, CONTRACTOR shall bring to the notice of OWNER the same, before its use.

1.2.4 Deleted

1.2.5 Codes and Standards

- 1.2.5.1 The engineering shall be performed and EQUIPMENT shall be manufactured and supplied according to acceptable international standards, as specified in the Technical Specification/FINAL PROPOSAL, meeting safety and other requirements of various national/international Codes and Regulations being in force as on submission of the FINAL PROPOSAL. The design of PLANT shall be based on the criteria enumerated in CONTRACT. However, it shall be CONTRACTOR's responsibility to follow all Indian Rules and Regulations as applicable.

CONTRACT shall comply with and shall cause the WORK and all components thereof (including, without limitation, the design and engineering of the PLANT) to comply with

	EMERGENCY DIESEL GENERATOR PACKAGE TALCHER FERTILIZERS LIMITED, ODISHA (INDIA) SPECIAL CONDITIONS OF CONTRACT	PC183/E-4022/P-I/S-V	0	
		DOC. NO.	REV	
		SHEET 7 OF 45		

all APPLICABLE LAWS and APPLICABLE PERMITS as they may be in effect at the time of CONTRACTOR's performance under the CONTRACT.

The CONTRACTOR shall ensure that all actions on its behalf in connection with the WORKS shall be in compliance with applicable laws of India. The CONTRACTOR agrees to take all reasonable steps to ensure that Persons appointed by it in connection with the WORK shall comply with the applicable laws/ regulations/ guidelines and obligations.

1.2.6 Drawings and Documents

1.2.6.1 CONTRACTOR shall prepare or secure and furnish to OWNER all data, specifications, drawings, plans and other documents as required/used for WORK as specified in Technical Specifications.

1.2.7 Owner's/PMC Review



1.2.7.1 ENGINEER-IN-CHARGE shall review all documents and give its comments to CONTRACTOR within 14 (Fourteen) working days from the date of receipt of the same. Review as aforesaid by OWNER/PMC and furnishing of comments by OWNER/PMC or the failure of OWNER/PMC to review or comment as aforesaid shall not relieve CONTRACTOR in any manner of its obligations including performance guarantees under this CONTRACT.

1.2.8 Procurement Services

1.2.8.1.1 As part of the WORK, CONTRACTOR shall procure and pay in CONTRACTOR's name as an independent contractor and not as agent for OWNER, all CONTRACTOR and SUB-CONTRACTOR's labour, materials, equipment, supplies, soil, gravel and similar materials and manufacturing, fabrication and related services (whether on or off the PLANT Site) for construction and incorporation in the PLANT or which are otherwise required for completion of the WORK in accordance with the Specification and the CONTRACT and are not explicitly specified to be furnished by OWNER pursuant to the terms and provisions of the CONTRACT including FINAL PROPOSAL.

1.2.8.1.2 CONTRACTOR shall procure and provide all EQUIPMENT required for PLANT. EQUIPMENT procured shall be according to specifications as set forth in the CONTRACT, proven record of performance and with suitable delivery time to meet the Contractual COMPLETION PERIOD. EQUIPMENT shall be procured from the vendor list agreed between CONTRACTOR and OWNER.



In connection with its procurement work, CONTRACTOR shall be responsible for the shipping, transportation and delivery of all items fabricated, manufactured, constructed or procured as set forth in the FINAL PROPOSAL and the CONTRACT. All such items and equipment, materials and supplies to be provided by the CONTRACTOR pursuant to the CONTRACT shall be new and of required quality, free from improper workmanship or defects and properly warranted or guaranteed in accordance with the CONTRACT. Any apparent omission or error in the equipment specifications will be

	EMERGENCY DIESEL GENERATOR PACKAGE TALCHER FERTILIZERS LIMITED, ODISHA (INDIA) SPECIAL CONDITIONS OF CONTRACT	PC183/E-4022/P-I/S-V	0	
		DOC. NO.	REV	
		SHEET 8 OF 45		

corrected by the CONTRACTOR to the extent required by the CONTRACT.

1.2.8.2 **Equipment**

- 1.2.8.2.1 CONTRACTOR agrees that EQUIPMENT procured shall be strictly in accordance with the specifications as provided, however, that any apparent omission or error in the specifications will be corrected by CONTRACTOR if it is necessary for the functioning of EQUIPMENT. CONTRACTOR shall inform OWNER for such omission or error or ambiguity in the specifications and corrections made for the same.
- 1.2.8.2.2 Completeness of EQUIPMENT/PLANT shall be the responsibility of CONTRACTOR. Any fittings, accessories, etc. which may not be specifically mentioned in Technical Specifications but which is required for the satisfactory functioning of EQUIPMENT and realization of PERFORMANCE GUARANTEES shall be provided by CONTRACTOR without any extra cost.
- 1.2.8.2.3 CONTRACTOR shall ensure that the modern practices in the manufacture of high grade EQUIPMENT are followed notwithstanding any omission in the specifications.
- 1.2.8.2.4 The supplies including fittings, accessories, etc. shall be in strict compliance to the applicable specifications/codes/standards. Components for which no relevant standards exist, the same shall be designed and manufactured as per good engineering practices.
- 1.2.8.2.5 The true intent and meaning of this Clause is that CONTRACTOR shall in all respects design, engineer, ensure quality of manufacture and supply EQUIPMENT in a thorough workman like manner, within prescribed time and in accordance with good engineering practice in order to enable proper operation of EQUIPMENT and PLANT.
- 1.2.8.2.6 CONTRACTOR shall furnish drawings and documents of EQUIPMENT as described in Technical part, Section VI. These documents shall include but not limited to technical documents, final drawings, preservation instructions, operation and maintenance manuals, test certificates, spare parts catalogues, etc. in a bound book for all rotating EQUIPMENT and in a folder for other EQUIPMENT, before despatch of EQUIPMENT under intimation to OWNER.
- 1.2.8.2.7 The documents, required for statutory approvals once submitted during construction period by CONTRACTOR shall be firm and final and not subject to subsequent changes unless such subsequent changes are approved by statutory agencies. CONTRACTOR shall be responsible for any payment of penalty as imposed by the Statutory Agencies consequent to furnishing of any in correct data/drawings.
- 1.2.8.2.8 All dimensions and weights shall be in metric system.
- 1.2.8.2.9 EQUIPMENT to be supplied and WORK to be carried out under CONTRACT shall conform to and comply with the provision of relevant Regulations/Acts (or both) as may be applicable in the State of ODISHA and in India to the type of EQUIPMENT/ WORK carried out and necessary certificates shall be furnished.

	EMERGENCY DIESEL GENERATOR PACKAGE	PC183/E-4022/P-I/S-V	0	
	TALCHER FERTILIZERS LIMITED, ODISHA (INDIA)	DOC. NO.	REV	
	SPECIAL CONDITIONS OF CONTRACT	SHEET 9 OF 45		

1.2.8.2.10 CONTRACTOR shall provide cross sectional drawings wherever applicable to identify the spare part numbers and their location, e.g. the size of bearings/ seals, their make and number shall be furnished.

1.2.8.3 CONTRACTOR shall furnish unpriced copy of Purchase Orders/Work Order/Contract for equipments and major items as per the list to be mutually agreed (including Priced copy of Purchase Orders/Work Order/Contract as required by the statutory authority) together with spares and special maintenance tools covering accurately all terms and conditions such as specifications requirements for quality, inspection, and test, warranties and guarantees, erection and commissioning assistance by vendor, delivery schedule, packing, transportation and insurance, and documentation.



1.2.8.4 CONTRACTOR shall arrange & furnish/provide to OWNER,

- a) Lubrication schedule from VENDOR, if required ,
- b) Mechanical specifications and equipment data sheets for review by OWNER for CRITICAL EQUIPMENT before manufacture is started,
- c) Shop fabrication drawings as made available by vendor,
- d) Characteristic curves for pumps and compressors, etc. as made available by vendor,
- e) Certified drawings including civil scope drawing and loading data, pertinent bulletin, installation, operation and maintenance manuals and test certificates as received from vendor,
- f) Final revised vendor's drawings including one reproducible, as described in Technical Specifications, before PRELIMINARY ACCEPTANCE.
- g) Any other information as may be sought by OWNER.

Any changes necessary during commissioning period can be incorporated in the as- built drawing and will be submitted after PAC as per the mutually agreed schedule.

1.2.8.5 CONTRACTOR shall provide services of vendor's specialist for installation and commissioning of EQUIPMENT whenever necessary.

1.2.8.6 Deleted

	EMERGENCY DIESEL GENERATOR PACKAGE	PC183/E-4022/P-I/S-V	0	
	TALCHER FERTILIZERS LIMITED, ODISHA (INDIA)	DOC. NO.	REV	
	SPECIAL CONDITIONS OF CONTRACT	SHEET 10 OF 45		

1.2.8.7 Inspection, Expediting & Testing

1.2.8.7.1 CONTRACTOR shall establish an inspection and expediting system and use its services for obtaining EQUIPMENT which conforms to the required technical and quality specifications and delivery schedule according to Purchase Order. CONTRACTOR shall send copies of expediting and inspection reports regularly to OWNER. CONTRACTOR shall arrange Third Party Inspection and quality certification of EQUIPMENT, as described in CONTRACT. Copies of all test results/report of the tests shall be furnished promptly by the CONTRACTOR to the OWNER.

Third party Inspection shall be carried by LLyods/BV/TUV/DNV.

1.2.8.7.2 OWNER or its INSPECTOR shall have the right to inspect and/or to test EQUIPMENT to check its conformity to the specifications laid down in the CONTRACT and as per approved QAP (Quality Assurance Plan). CONTRACTOR shall specify the inspections and tests to be carried out giving reference of applicable codes/standards and the location of inspection/test to OWNER. OWNER shall notify CONTRACTOR in writing the name of INSPECTOR retained for this purpose. Expediting by OWNER's representative in no way relieves the CONTRACTOR of his obligation under the terms and conditions of this CONTRACT.



1.2.8.7.3 The inspection and tests may be conducted at the premises of CONTRACTOR or SUB-CONTRACTOR/vendor before delivery and/or at SITE. All reasonable facilities and assistance including access to all drawings and production data shall be furnished to INSPECTOR at no charge to OWNER.

1.2.8.7.4 Should any inspected or tested EQUIPMENT fail to conform to the specifications, OWNER may reject it and CONTRACTOR shall either replace the rejected EQUIPMENT or make all alterations necessary to meet specification requirements free of cost.



1.2.8.7.5 OWNER's right to inspect and wherever necessary, comment about EQUIPMENT after its arrival at SITE or its participation in tests in respect of any EQUIPMENT shall in no way be limited or waived by reason of EQUIPMENT having previously been inspected, tested and passed by OWNER or INSPECTOR/representative prior to its shipment/despatch.

1.2.8.7.6 INSPECTOR shall follow the progress of the manufacture of EQUIPMENT under CONTRACT to ensure that the requirements outlined in CONTRACT are not being deviated from with respect to Schedule and Quality.

1.2.8.7.7 CONTRACTOR shall allow INSPECTOR to visit, during working hours, the workshops relevant to execution of CONTRACT during the contractual period and INSPECTOR will have the right to inspect EQUIPMENT at all stages of manufacture right from identification of material up to its shipment/despatch, to the extent that the delivery schedule shall not be delayed, with prior notice to CONTRACTOR in writing.

	EMERGENCY DIESEL GENERATOR PACKAGE	PC183/E-4022/P-I/S-V	0	
	TALCHER FERTILIZERS LIMITED, ODISHA (INDIA)	DOC. NO.	REV	
	SPECIAL CONDITIONS OF CONTRACT	SHEET 11 OF 45		

- 1.2.8.7.8 In order to enable INSPECTOR to obtain entry visa in time, CONTRACTOR shall notify OWNER two months before assembly, testing and packing of main EQUIPMENT and if requested assist INSPECTOR in getting visa in the shortest possible time.
- 1.2.8.7.9 CONTRACTOR shall place at the disposal of INSPECTOR free of charge all tools, instruments and other apparatus necessary for the inspection and/or testing of EQUIPMENT. INSPECTOR is entitled to prohibit the use and despatch of EQUIPMENT that has failed to comply with the characteristics/specifications of EQUIPMENT during test and inspection.
- 1.2.8.7.10 CONTRACTOR shall ensure that the permission for inspection/test is granted by its SUB-CONTRACTOR/VENDOR.
- 1.2.8.7.11 In respect of the inspection, CONTRACTOR shall advise in writing of any delay in the programme at the earliest possible date, describing in detail what has caused the delay and the proposed corrective action.
- 1.2.8.7.12 All tests and trials in general of EQUIPMENT shall be witnessed by INSPECTOR. Therefore, CONTRACTOR shall confirm to OWNER by E-mail about the exact date of inspection at least 15 DAYS in advance. CONTRACTOR shall specify the items and quantities ready for testing and indicate whether a Preliminary or Final Test is to be carried out. On receipt of this notice, if OWNER decides to waive the right to witness the test, information shall be given to CONTRACTOR within 15 DAYS of receipt of the notice from CONTRACTOR and CONTRACTOR then shall have right to proceed with the inspection
- 1.2.8.7.13 CONTRACTOR shall be held responsible for any possible delay in the approval or testing phase as well as for any possible delay in the remittance of necessary certificates. Delay on the part of the Inspection institutions will not be considered a case of 'Force Majeure'.
- 1.2.8.7.14 Any and all expenses incurred in connection with tests, preparation of reports and analysis made by qualified laboratories, necessary technical documents, testing documents and drawings shall be at CONTRACTOR's cost. Technical documents shall include the references and numbers of the standard used in the fabrication/construction and, wherever deemed practical by INSPECTOR. INSPECTOR shall attach importance to the views given by CONTRACTOR or its SUB-CONTRACTOR/VENDOR. Any and all expenses for boarding, lodging and airfare/rail fare incurred in connection with INSPECTOR shall be borne by OWNER.
- 1.2.8.7.15 Participation or presence of OWNER or their representatives at any tests or their failure to be present at or to witness any tests to be undertaken pursuant here to shall not in any way or manner relieve or release the CONTRACTOR from any of its warranties, guarantees or other obligations under the CONTRACT.

	EMERGENCY DIESEL GENERATOR PACKAGE	PC183/E-4022/P-I/S-V	0	
	TALCHER FERTILIZERS LIMITED, ODISHA (INDIA)	DOC. NO.	REV	
	SPECIAL CONDITIONS OF CONTRACT	SHEET 12 OF 45		

1.2.8.7.16 Nothing in Clause -1.2.8.7.2 to 1.2.8.7.15 shall in any way relieve CONTRACTOR from any warranty or other obligations under this CONTRACT.

Not performing or failing to perform the inspection by OWNER hereunder shall not be a waiver of any of CONTRACTOR's obligations hereunder nor it be construed as an approval or acceptance of any of the WORK hereunder nor it shall absolve the CONTRACTOR in any way or manner of its liabilities, responsibilities and obligations under the CONTRACT.

1.2.8.7.17 Arrangements for all inspections required by Statutory Authorities and as specified in Technical Specifications shall be made by CONTRACTOR. If certain category of EQUIPMENT/piping fall under the jurisdiction of Indian Boiler Regulations (IBR), irrespective of the fact whether these are proprietary in nature or not, certification from an internationally recognised agency approved by IBR is considered necessary to enable local IBR authorities to allow their installation and operation. In such cases, inspection and certification from such authorities will also have to be arranged by CONTRACTOR. CONTRACTOR shall also submit, as may be required by IBR authorities, necessary design calculations from respective fabricators and/or manufacturers of such EQUIPMENT.

1.2.8.7.17 Rejections, Removal of Rejected EQUIPMENT and Replacement

1.2.8.7.17.1 Preliminary inspection at SUB-CONTRACTOR's / vendor's works by INSPECTOR shall not prejudice OWNER for commenting on EQUIPMENT including its specifications on final inspection at SITE or claim under warranty provisions.



1.2.8.7.17.2 If EQUIPMENT is not of specification or fail to perform specified duties, OWNER shall be entitled to reject EQUIPMENT or part thereof and ask for modification, repair or free replacement within reasonable time subject to the relevant provisions in the CONTRACT.

1.2.8.7.17.3 In the event of such rejection, OWNER shall be entitled to use EQUIPMENT in a reasonable and proper manner for a time reasonably sufficient to enable it to obtain replacement, without any liability to CONTRACTOR. After free replacement of such rejected EQUIPMENT, the rejected equipment shall become the property of CONTRACTOR.

1.2.8.7.17.4 Nothing in this Clause shall be deemed to deprive OWNER and/or affect any of its rights under CONTRACT which it may otherwise have in respect of such defects or deficiencies or in any way relieve CONTRACTOR of its obligation under CONTRACT.

1.2.8.7.17.5 EQUIPMENT rejected by OWNER shall be removed by CONTRACTOR, within reasonable time, at its own cost after replacement of the said EQUIPMENT. OWNER shall in no way be responsible for any deterioration or damage to rejected EQUIPMENT under any circumstances whatsoever.

1.2.8.7.17.6 In case, the rejected EQUIPMENT is to be taken out of OWNER's premises for repair, Ownershall have the right to withhold the payment for such cost of equipment to the

	EMERGENCY DIESEL GENERATOR PACKAGE TALCHER FERTILIZERS LIMITED, ODISHA (INDIA) SPECIAL CONDITIONS OF CONTRACT	PC183/E-4022/P-I/S-V	0	
		DOC. NO.	REV	
		SHEET 13 OF 45		

extent of payment made by Owner towards the equipment until the equipment is returned / replaced.

1.2.8.8 Packing

1.2.8.8.1 CONTRACTOR shall ensure that packing of EQUIPMENT is as required to prevent their damage or deterioration during transit to its final destination.

1.2.8.8.2 The packing, markings and documentation within and outside the packages shall comply strictly with the provisions of CONTRACT.

1.2.8.8.3 CONTRACTOR shall be responsible for any eventual consequence occurred to EQUIPMENT due to improper packing of the same.

1.2.8.9 Delivery/Time Schedule and Documents

1.2.8.9.1 Time schedule shall include time for submission of documents/drawings for review/approval, incorporation of comments, if any, and final review of drawings by ENGINEER-IN-CHARGE. Within 14 (Fourteen) working days after receipt by ENGINEER-IN-CHARGE of any document requiring OWNER's review, ENGINEER-IN-CHARGE shall either return one copy thereof to CONTRACTOR as it is, if ENGINEER-IN-CHARGE has no comments or with its comments and reasons thereof.



1.2.8.9.2 Special care shall be taken by CONTRACTOR to furnish Manufacturer's Test Certificates, material of construction, make, type, pressure ratings wherever applicable and included in the scope of supply of EQUIPMENT.

1.2.8.9.3 In case of delay beyond the stipulated COMPLETION PERIOD, for reasons not attributable to OWNER, FORCE MAJEURE and suspension of WORK by OWNER, even though provisional extension of COMPLETION PERIOD time is allowed by OWNER, all extra costs on account of changes of statutory regulations/Acts or increase in price on any other account, shall not apply to CONTRACT PRICE and the same shall be borne by CONTRACTOR.

1.2.8.10 Despatch, Transportation/Shipping

1.2.8.10.1 CONTRACTOR shall be responsible for despatch of EQUIPMENT by sea/ rail/ road/air after proper packing and protection. The consignment shall be despatched after inspection by OWNER unless otherwise agreed to in writing however such inspection shall not constitute waiver of the CONTRACTOR's obligations, responsibilities for the EQUIPMENT including care, safety and preservation in any way and manner and the CONTRACTOR's responsibility and obligation in this behalf shall continue till PRELIMINARY ACCEPTANCE OF PLANT.

1.2.8.10.2 Generally, on-Deck shipment shall not be made without prior permission of OWNER. However, in case of towers, reactors, vessels and other large-sized EQUIPMENT, CONTRACTOR may, at its own discretion, make on-deck shipment, without OWNER's prior permission. In case of damage to such EQUIPMENT, during delivery or at any

	EMERGENCY DIESEL GENERATOR PACKAGE	PC183/E-4022/P-I/S-V	0	
	TALCHER FERTILIZERS LIMITED, ODISHA (INDIA)	DOC. NO.	REV	
	SPECIAL CONDITIONS OF CONTRACT	SHEET 14 OF 45		

stage before PRELIMINARY ACCEPTANCE OF PLANT, CONTRACTOR shall be responsible for repair/replacement of EQUIPMENT.

1.2.8.10.3 Clean onboard bill of lading for all offshore supplies shall be drawn as under:

For CIF/FOB/FAS/FCA shipments

Shipper = CONTRACTOR/Supplier
 Consignee = CONTRACTOR

1.2.8.10.4 **Property in EQUIPMENT**

1.2.8.10.4.1 In case of all EQUIPMENTS/MATERIALS, the title of Ownership shall pass on to OWNER on PRELIMINARY ACCEPTANCE of Plant. However, the OWNER shall have Lien on all EQUIPMENTS/MATERIALS including those brought by the Contractor for the purpose of Erection, testing and commissioning of the WORK. However, in case of Termination of Contract the Transfer of Title shall pass automatically to OWNER.

1.2.8.10.4.2 CONSTRUCTION EQUIPMENT used by the CONTRACTOR and its SUB-CONTRACTORS in connection with the execution of works shall remain the property of CONTRACTOR or its SUB-CONTRACTORS. All duties, levies, taxes etc payable on account of CONSTRUCTION EQUIPMENT shall be borne by the CONTRACTOR. CONTRACTOR shall indemnify the OWNER on this count.



1.2.9 **Spares, Special Maintenance Tools, Lubricants, Chemicals and Consumable**

1.2.9.1 CONTRACTOR shall procure and supply commissioning spares, special maintenance tools and fixtures for EQUIPMENT, lubricants, chemicals and consumable in sufficient quantity for COMMISSIONING and maintenance of PLANT, as described in FINAL PROPOSAL. The commissioning spares, special maintenance tools, lubricants, chemicals and consumable procured and supply shall be optimum, so as not to fall short during COMMISSIONING, and GTR. CONTRACTOR shall obtain for these items the appropriate guarantees and warranties. CONTRACTOR shall also ensure that the commissioning spares and special maintenance tools and fixtures are procured along with the related items of EQUIPMENT and form part of PURCHASE ORDER for the related items of EQUIPMENT.

1.2.9.2 **Lubricants, Chemicals, Consumable etc.**

CONTRACTOR shall supply Consumables, lubricants and chemicals, as required for 100% full load run for 6 months operation after successful commissioning (and include the cost in CONTRACT PRICE). Consumables, lubricants and chemicals to be supplied in phased manner and shall be mutually agreed between OWNER and CONTRACTOR considering the consumption and storage capacity.

1.2.9.3 **Special Maintenance Tools**

	EMERGENCY DIESEL GENERATOR PACKAGE TALCHER FERTILIZERS LIMITED, ODISHA (INDIA) SPECIAL CONDITIONS OF CONTRACT	PC183/E-4022/P-I/S-V	0	
		DOC. NO.	REV	
		SHEET 15 OF 45		

CONTRACTOR shall supply special devices or tools required for normal maintenance, special handling and lifting of EQUIPMENT with main EQUIPMENT. The cost of such special maintenance tools shall be included in CONTRACT PRICE.

1.2.9.4 Bidder's Recommended Operational Spares

CONTRACTOR shall provide Itemised Price List for Bidder's Recommended operational spares 6 months prior to Mechanical Completion with validity of 2 Years. The recommended spares shall be optimum so as not to cause any short fall or excessive inventory. The price of above shall NOT be included in CONTRACT PRICE.

1.2.9.5 Special Tools & Tackles

CONTRACTOR shall supply special tools, tackles and fixture, required during normal operation & maintenance of PLANT. The cost of such special tools & tackles shall be included in CONTRACT PRICE.

1.2.9.6 Chemicals

CONTRACTOR shall supply all chemicals for first filling and make-up, if required as indicated in Technical Section of NIT. The cost of these chemicals shall be included in the CONTRACT PRICE.



1.2.9.7 Lubricants

1.2.9.7.1 CONTRACTOR shall supply lubricants in sufficient quantity for the first filling and make-up required as indicated in Technical Section of NIT. The cost of lubricants shall be included in the CONTRACT PRICE.

1.2.9.7.2 CONTRACTOR shall furnish the name of recommended lubricants indicating their commercial/trade name, quality and grade and equivalent quality lubricants (in case of imported lubricants) available in India to OWNER.

1.2.9.8 Commissioning spares and Consumables

CONTRACTOR shall supply spares and consumables required for construction, PRE COMMISSIONING, COMMISSIONING, start-up and testing of PLANT. The cost of such spares and consumables shall be included in TOTAL CONTRACT PRICE.

	EMERGENCY DIESEL GENERATOR PACKAGE	PC183/E-4022/P-I/S-V	0	
	TALCHER FERTILIZERS LIMITED, ODISHA (INDIA)	DOC. NO.	REV	
	SPECIAL CONDITIONS OF CONTRACT	SHEET 16 OF 45		

1.2.9.9 **Mandatory Spares**

CONTRACTOR shall provide Mandatory Spares as per Section VI-6.0, of Technical Document. Notwithstanding anything contained in this CONTRACT, the Prices for Mandatory Spares/Insurance Spares shall be included in TOTAL CONTRACT PRICE.

The Lumpsum price for “Mandatory Spares/Insurance Spares” shall be as included in the supply portion of TOTAL CONTRACT PRICE. However, details along with breakup for the above shall be submitted by successful bidder during execution.

1.2.9.10 **General**

1.2.9.10.1 CONTRACTOR shall furnish to OWNER, the blue prints, drawings and specifications of the spare parts.

1.2.9.10.2 CONTRACTOR shall provide to OWNER all addresses and particulars of its SUB-CONTRACTOR/VENDOR on whom PURCHASE ORDER for EQUIPMENT covered under CONTRACT has been placed and will further ensure with its SUB-CONTRACTOR/VENDOR that, OWNER if so desires, shall have the right to place order for two years spare parts directly on them on mutually agreed terms based on offers of such SUB-CONTRACTOR/ VENDOR.

1.2.9.10.3 Spare parts shall be new and as per engineering standards/codes, free of any defects (even concealed), deficiency in Design, Materials and Workmanship and also shall be completely interchangeable with the corresponding parts.

1.2.9.10.4 Type and sizes of bearing/seals and bearing number with make shall be clearly indicated.



1.2.9.10.5 Spare parts shall be packed for long storage under tropical climatic conditions in suitable cases, clearly marked as to their intended purpose.

1.2.10 **Warrantees and Guarantees**

1.2.10.1 **Materials and Workmanship Warranty**

1.2.10.1.1 CONTRACTOR warrants that EQUIPMENT supplied under CONTRACT are new, unused, of the recent or current models and incorporate all recent improvements in design and materials unless provided otherwise in CONTRACT. CONTRACTOR further warrants that EQUIPMENT supplied under this CONTRACT shall be according to specifications, have no defect (even concealed) arising from design, materials or workmanship or form any act or omission of CONTRACT that may develop under normal use of the supplied EQUIPMENT in the conditions prevailing in the country of final destination.

1.2.10.1.2 The warranty period for the EQUIPMENT supplied by CONTRACTOR shall be valid for minimum 12 months for all EQUIPMENT from the date of PRELIMINARY

	EMERGENCY DIESEL GENERATOR PACKAGE	PC183/E-4022/P-I/S-V	0	
	TALCHER FERTILIZERS LIMITED, ODISHA (INDIA)	DOC. NO.	REV	
	SPECIAL CONDITIONS OF CONTRACT	SHEET 17 OF 45		

ACCEPTANCE. The warranty period for individual catalyst shall be up to its guaranteed life, as specified in FINAL PROPOSAL, from the date of COMMISSIONING.



- 1.2.10.1.3 The warranty shall be valid for the period as described under Clause -1.2.10.1.2 from the date of PRELIMINARY ACCEPTANCE. and shall be governed by Clause 17 of SPECIAL CONDITIONS OF CONTRACT. Should any DEFECTS be noticed in design, material and/or workmanship within the said warranty period, ENGINEER-IN-CHARGE shall inform CONTRACTOR and CONTRACTOR shall immediately on receipt of such intimation depute their personnel within 10 DAYS to investigate the causes of DEFECTS and arrange rectification / replacement / modification of the defective EQUIPMENT at SITE without any cost to OWNER, within a reasonable period. If CONTRACTOR fails to take proper corrective action to replace/ repair defective Equipment satisfactorily within a reasonable period, OWNER shall be free to take such corrective action as may be deemed necessary at CONTRACTOR's risk and cost, after giving notice to CONTRACTOR. OWNER shall promptly notify CONTRACTOR in writing of any claims arising under this warranty.

The cost of any special or general overhaul rendered necessary during the guarantee period due to defects for which CONTRACTOR is liable under CONTRACT in the PLANT or defective work carried out by the CONTRACTOR shall be borne by the CONTRACTOR.

- 1.2.10.1.4 After the issue of the PRELIMINARY ACCEPTANCE. CERTIFICATE and upto the defect liability period, in the event of an emergency where, in the judgement of the OWNER, delay would cause serious loss or damage, repairs or adjustments may be made by the OWNER or a third party chosen by the OWNER without advance notice to the CONTRACTOR and the documented and direct cost of such work shall be paid by the CONTRACTOR but only to the extent that the repair or adjustment was due a defect attributable to CONTRACTOR.

- 1.2.10.1.5 In case defects are of such nature that EQUIPMENT shall have to be taken to CONTRACTOR's/ SUB-CONTRACTOR's/ vendor's works for rectification etc., CONTRACTOR shall take EQUIPMENT at its cost after giving necessary undertaking or security as may be required by OWNER. OWNER shall, if so required by CONTRACTOR, despatch EQUIPMENT by quickest mode on freight to pay basis to CONTRACTOR's / SUB-CONTRACTOR's / vendor's works. After repairs CONTRACTOR shall deliver EQUIPMENT at SITE on freight paid basis. All transit risks to and from site shall be borne by CONTRACTOR.



- 1.2.10.1.6 EQUIPMENT or part thereof so repaired or replaced shall have further warranty for a period of 12 months from the date of its acceptance after repair/replacement and the Contract Performance Security shall be suitably extended for the same. The value of the Contract Performance Security during the extended warranty period shall be 10 (Ten) percent of the cost of such repaired/replaced EQUIPMENT or its parts for which documentary evidence to be submitted.

	EMERGENCY DIESEL GENERATOR PACKAGE	PC183/E-4022/P-I/S-V	0	
	TALCHER FERTILIZERS LIMITED, ODISHA (INDIA)	DOC. NO.	REV	
	SPECIAL CONDITIONS OF CONTRACT	SHEET 18 OF 45		

However, extended DEFECTS LIABILITY PERIOD shall have an upper limit of 24 months for extended DEFECTS LIABILITY PERIOD, starting from the PRELIMINARY ACCEPTANCE.

At the end of the DEFECT LIABILITY PERIOD or the extended DEFECT LIABILITY PERIOD, the CONTRACTOR's liability ceases. In respect of goods supplied by the SUB-CONTRACTORS to the CONTRACTOR where a long guarantee (more than 12 months) is provided by such SUBCONTRACTORS/SUB- VENDOR(s), the OWNER shall be entitled to the benefit of such longer guarantees.

- 1.2.10.1.7 If the repairs, replacements or modifications referred to above are of such nature which may affect the efficiency of EQUIPMENT, OWNER shall have right to give notice in writing to CONTRACTOR within one month of such repair/ replacement/ modification to carry out tests as may be required for acceptance of EQUIPMENT.
- 1.2.10.1.8 If CONTRACTOR fails to meet its obligation to repair or replace defective EQUIPMENT and make it good within a reasonable period of time and or if CONTRACTOR refuses to carry out WORK under the guarantee clause and implied guarantee conditions and/or in case of severe urgency, OWNER shall be entitled to carry out repair/replacement/WORK or arrange to carry out repair/ replacement/WORK by a third party. The entire cost of such repair/ replacement/WORK including transit insurance, freight, taxes and duties etc. shall be borne by the CONTRACTOR. In case, the cost of such repair/replacement has been incurred by OWNER, CONTRACTOR shall reimburse the same immediately on demand by OWNER with a document substantiating such costs.
- 1.2.10.1.9 Damages to EQUIPMENT deriving from incomplete, erroneous instructions issued by CONTRACTOR will be considered CONTRACTOR's fault and will be treated according to the provision of warranty clause. Normal wear and tear shall not come under purview of this clause.
- 1.2.10.1.10 The acceptance of any equipment by the OWNER shall in no way relieve the CONTRACTOR of his obligation under this clause.
- 1.2.10.1.11 During the GUARANTEE PERIOD, the CONTRACTOR shall provide if required by the OWNER, the services of operation engineers to advise the OWNER for such period and in such number as may be mutually agreed upon. The CONTRACTOR's operation engineers shall also train the OWNER's personnel, act as a liaison between the OWNER and the CONTRACTOR, assist the OWNER in ordering and obtaining spare parts, generally monitoring operation and maintenance and trouble shooting and supervising repair work under guarantee.

	EMERGENCY DIESEL GENERATOR PACKAGE TALCHER FERTILIZERS LIMITED, ODISHA (INDIA) SPECIAL CONDITIONS OF CONTRACT	PC183/E-4022/P-I/S-V	0	
		DOC. NO.	REV	
		SHEET 19 OF 45		

1.2.10.2 **Design and Vendors'/ Sub-Contractors' Guarantees**

1.2.10.2.1 CONTRACTOR shall guarantee the design and engineering work carried out by him against mistakes, errors, defective specifications, inadequacy and other such items which lead to the supply of inadequate PLANTS and Facilities. In case of detection of such mistakes, errors, deficiencies etc. the CONTRACTOR shall redo the design and/or engineering work to overcome all such mistakes, errors, deficiencies etc. at no extra cost to OWNER.

1.2.10.2.2 CONTRACTOR shall be responsible for all the items of the EQUIPMENT procured by him from VENDORS/ SUB-CONTRACTORS. Further, CONTRACTOR shall replace or repair any item of EQUIPMENT which is demonstrated to be defective under normal operating conditions within DEFECT LIABILITY PERIOD.



1.2.11 **Performance Guarantee of PLANT(S)/ EQUIPMENT**

1.2.11.1 CONTRACTOR guarantees that the performance of PLANTS supplied under CONTRACT shall be strictly in conformity with the specifications and shall perform the duties and have consumption, production and other guarantees set forth in CONTRACT.



1.2.11.2 If the performance of PLANTS and/or any of EQUIPMENT fails as guaranteed and set forth in CONTRACT, CONTRACTOR shall investigate the causes and provide free of cost to OWNER, design, engineering, MATERIALS and services and EQUIPMENT within a reasonable period to prove guarantees. CONTRACTOR's liability in this respect shall be limited as per the provisions of 22.0 of SCC except that the Works Cost Guarantee shall be governed by the provisions of Cl.No.21.2. of GCC.

1.2.12 **STATUTORY APPROVALS**

1.2.12.1 Unless otherwise specified in Bidding Documents, it shall be the CONTRACTOR's sole responsibility to obtain all approvals from any authority (except for environment clearance and Consent to Establish/Operate, however the data and information required for the same shall be made available by the LSTK contractor) required under any statute, rule or regulation of the Central or State Government concerned with the performance of the CONTRACT and/or the contractual Work. The application on behalf of the OWNER for submission to relevant authorities alongwith copies of required certificates complete in all respects shall be prepared and submitted by the CONTRACTOR well ahead of time so that the actual execution of the WORKS is not delayed for want of the APPROVAL/inspection by the concerned authorities. The CONTRACTOR shall arrange for the inspection of the works by the authorities and will undertake necessary coordination and liaison required and shall not be entitled to any extension of time for any delay in obtaining such approval. All statutory fees shall be paid by the CONTRACTOR and the same shall be reimbursed by the OWNER upon production of documentary evidence by the CONTRACTOR.

	EMERGENCY DIESEL GENERATOR PACKAGE	PC183/E-4022/P-I/S-V	0	
	TALCHER FERTILIZERS LIMITED, ODISHA (INDIA)	DOC. NO.	REV	
	SPECIAL CONDITIONS OF CONTRACT	SHEET 20 OF 45		

- 1.2.12.2 Any deficiency(ies) as pointed out by any such authority shall be rectified by the CONTRACTOR within the scope of relative supply and/or WORK at no extra cost to the OWNER. The inspection and acceptance of the WORKS by such authorities shall, however, not absolve the CONTRACTOR from any of its responsibilities under this CONTRACT.
- 1.2.12.3 No extension of time shall be granted for meeting the requirement and/or obtaining APPROVAL of statutory authorities.
- 1.2.12.4 **Government Clearances, Permits and Certificates**
- CONTRACTOR shall procure at its expenses, all necessary APPLICABLE PERMITS, certificates and licenses required by virtue of all APPLICABLE LAWS, regulations, ordinances and other rules in effect at the place where any of WORK is to be performed, and CONTRACTOR shall further hold OWNER harmless from liability or penalty which might be imposed by reason of any asserted or established violation of such laws, regulations, ordinances or other rules. OWNER will provide the necessary assistance to CONTRACTOR for obtaining PERMITS for CONTRACTOR's personnel to undertake WORK in India in connection with CONTRACT.
- 1.2.12.5 CONTRACTOR shall furnish necessary technical information, data, drawing, etc. as and when required by OWNER for submission to Government/Statutory Agencies.
- 1.2.13 **Network Schedule**
- 1.2.13.1 OWNER would be using a computerized time and cost monitoring system and CONTRACTOR shall provide necessary input data for the same. CONTRACTOR shall prepare within 30 (thirty) days from date of FOA and provide to OWNER a PROJECT MASTER SCHEDULE indicating the important milestones of activities relating to WORK from date of FOA to the date of PRELIMINARY ACCEPTANCE. This PROJECT MASTER SCHEDULE shall be discussed with and approved by OWNER. Based on the approved PROJECT MASTER SCHEDULE, CONTRACTOR shall also prepare network schedules for activities relating to WORK. CONTRACTOR shall obtain the details of progress of various activities of WORK from SUB-CONTRACTOR and vendor wherever required and update the network schedules and PROJECT MASTER SCHEDULE incorporating the progress achieved by CONTRACTOR, SUB-CONTRACTOR and vendor and submit the same to ENGINEER-IN-CHARGE on monthly basis.
- 1.2.13.2 CONTRACTOR shall clearly indicate any delay in WORK in the above schedules and shall inform ENGINEER-IN-CHARGE the action taken to achieve the COMPLETION PERIOD.

	EMERGENCY DIESEL GENERATOR PACKAGE TALCHER FERTILIZERS LIMITED, ODISHA (INDIA) SPECIAL CONDITIONS OF CONTRACT	PC183/E-4022/P-I/S-V	0	
		DOC. NO.	REV	
		SHEET 21 OF 45		

1.2.14 **Transportation and Storing of EQUIPMENT**

1.2.14.1 CONTRACTOR shall be responsible for proper packing, transportation from vendor's workshop to port or railway station (whether by road, rail, ship or aircraft), handling and clearances at port or railway station including loading and unloading, customs clearance, carriage to SITE, unloading at SITE, warehousing, coding and tagging, storage including proper preservation, etc. of EQUIPMENT. Any special clearance, lifting, handling, loading/unloading, and transport arrangements for over dimensional consignments shall also be done by CONTRACTOR. CONTRACTOR shall ensure timely delivery of EQUIPMENT. CONTRACTOR shall endeavor to have the consignments in the upper part of the hold to enable early discharge at the Port of disembarkment. The above arrangement shall be in accordance with the guidelines set forth in the Co-ordination Procedure which shall be finalised mutually after issuance of FOA. CONTRACTOR shall be responsible for inspection of EQUIPMENT on receipt at SITE and for maintenance and management of stores and warehousing of EQUIPMENT at SITE including all activities connected with the issue of EQUIPMENT, accounting and final reconciliation and handing over of stores to OWNER.

1.2.14.2 OWNER shall provide area at SITE for making shed/covered stores etc. for storing EQUIPMENT. CONTRACTOR shall be responsible for making shed/covered stores etc. for safe storage of EQUIPMENT.



1.2.15 **Construction**

1.2.15.1 CONTRACTOR shall be responsible for all civil and structural work, foundations, insulating & painting works, erection, site fabrication, piping, instrumentation, electrical installation, and other miscellaneous construction jobs of PLANT leading to MECHANICAL COMPLETION and PRELIMINARY ACCEPTANCE of PLANT. CONTRACTOR shall organise these activities in appropriate sequence and use proper methods giving due regard to the requirements of safety, quality, sound engineering practice, compliance with relevant Codes and Regulations, and for achieving COMMISSIONING of PLANT on or before COMPLETION PERIOD.

The CONTRACTOR shall within the scope of work observe in addition to specifications, all national and local laws, ordinances, rules and regulation and requirements pertaining to the WORK.

Various procedures and methods to be adopted by CONTRACTOR during the construction as required in the respective specifications shall be submitted to OWNER in due time and well in advance of the specific work for approval.

The CONTRACTOR shall carry out required supervision as per Quality Assurance Plan and furnish all assistance required by the OWNER in carrying out inspection work. The OWNER will have authorized representatives present who shall have free access to the work at all times. If an OWNER's representative notifies the CONTRACTOR's representative of any deficiency in any work or in the supervision thereof, the CONTRACTOR shall make every effort to carry out such instructions consistent with

	EMERGENCY DIESEL GENERATOR PACKAGE TALCHER FERTILIZERS LIMITED, ODISHA (INDIA) SPECIAL CONDITIONS OF CONTRACT	PC183/E-4022/P-I/S-V	0	
		DOC. NO.	REV	
		SHEET 22 OF 45		

best industry practice.

The CONTRACTOR shall so far as reasonably feasible employ skilled workers who are Certified Tradesmen in the field(s) of their relative activities(s).

1.2.15.2 CONTRACTOR shall submit and adhere to the completion schedule of construction leading to PRELIMINARY ACCEPTANCE.

1.2.15.3 In case of delay in completion beyond the stipulated completion period as specified in Invitation For Bid (IFB) under clause 2 (E) for reasons attributable to Contractor, all extra costs on account of changes of statutory regulations / Acts, shall not apply to Contract price and the same shall be borne by Contractor.

1.2.15.4 **Civil Work Warranty**

1.2.15.4.1 CONTRACTOR shall certify that the all civil works, reinforced concrete, structures, permanent buildings and foundations has been designed in accordance with stipulations of relevant BIS Codes.

1.2.16 **Safety and Plant Security**



1.2.16.1 CONTRACTOR shall observe and also use its best efforts to ensure that all parts of WORK carried out at SITE is being done in a safe and satisfactory manner conforming to the applicable Safety Rules and Regulations. Further, CONTRACTOR shall observe and make provisions in SUB-CONTRACT that employees working for PLANT observe all the Safety Rules as required under the Factories Act and Regulations and other Local Laws and SUB-CONTRACTOR to provide safety apparel and equipment to its employees. OWNER shall have the right to object to any unsafe practice followed by SUB-CONTRACTOR's employees or any CONTRACTOR's personnel and direct them to carry out the job in a manner considered safe by OWNER. CONTRACTOR shall further abide by all the Security Regulations imposed by OWNER.

1.2.16.2 CONTRACTOR shall observe all safety rules so that no harm is done to OWNER's employees or property. If on account of CONTRACTOR, OWNER's property or personnel are likely to suffer any damage, in such cases any directions issued by OWNER shall be carried out by CONTRACTOR.

1.2.17 **PRE-COMMISSIONING**

1.2.17.1 CONTRACTOR shall render and be responsible for pre-commissioning activities leading to MECHANICAL COMPLETION. These activities will include relevant checking, adjustment, testing, calibration, running in and trial runs of individual items of EQUIPMENT, and other similar jobs. OWNER shall provide experienced/trained and suitable operating and maintenance personnel who will perform their tasks under the supervision and direction of CONTRACTOR.

1.2.17.2 CONTRACTOR shall provide experienced personnel as required for carrying out the PRE-COMMISSIONING activities with OWNER's personnel.

	EMERGENCY DIESEL GENERATOR PACKAGE	PC183/E-4022/P-I/S-V	0	
	TALCHER FERTILIZERS LIMITED, ODISHA (INDIA)	DOC. NO.	REV	
	SPECIAL CONDITIONS OF CONTRACT	SHEET 23 OF 45		

1.2.17.3 CONTRACTOR shall provide SUB-CONTRACTOR's/VENDOR's specialists wherever required. Suitable provision for such services shall be made by CONTRACTOR in PURCHASE ORDER/CONTRACT with their Sub-Vendor/Sub-Contractor.



1.2.17.4 "PRE-COMMISSIONING" shall mean preparation of PLANT so that it is capable of operating on a continuous basis at or near rated capacity for carrying out COMMISSIONING activities

1.2.18 **MECHANICAL COMPLETION**

1.2.18.1 CONTRACTOR shall be responsible for completing the design, engineering, procurement, inspection and expediting, arranging for transportation of EQUIPMENT, construction and PRE-COMMISSIONING for making PLANT/Package ready commissioning on declaration of MECHANICAL COMPLETION.



MECHANICAL COMPLETION" shall mean completion of erection and alignment so that PLANT is ready for commissioning. This shall happen (as applicable) when:

- A. The EQUIPMENT capable of producing to rated capacities are installed, aligned and grouted (wherever applicable) in accordance with drawings, specifications as per finally approved P&I Diagrams in accordance with all applicable codes, and laws.
- B. All pressure EQUIPMENT is hydrostatically or pneumatically tested once either in CONTRACTOR'S shop or in the field in accordance with Technical Specifications.
- C. Deleted
- D. Compressor, Pumps, Machinery etc are cold aligned. Couplings are assembled and guards installed as applicable.
- E. Instruments, control system, instrument cable, safety interlock are installed, inspected and such non-operating checks are made as to ensure operability in the manner required for the process application. Instrument air lines are checked for correct hook up. Airlines are leak tested.
- F. Relief valves are installed prior to this, and have been checked by the CONTRACTOR in the CONTRACTOR's shop.
- G. Piping is hydrostatically or pneumatically tested in accordance with the specifications. Special treatment such as chemical cleaning is done as required by drawing or specifications. Suction screens are installed and test blinds are

	EMERGENCY DIESEL GENERATOR PACKAGE TALCHER FERTILIZERS LIMITED, ODISHA (INDIA) SPECIAL CONDITIONS OF CONTRACT	PC183/E-4022/P-I/S-V	0	
		DOC. NO.	REV	
		SHEET 24 OF 45		

removed. Spring support anchors and guide are checked for removal of all shipping locks.

- H. The electric system is installed and tested in accordance with and to the extent required by electrical specifications. All wiring is checked for correct hook up. Motor rotation is checked. All power system protective devices are set.
 - I. Insulation and drying out are completed to the extent necessary to permit start of commissioning.
 - J. Pipe support system installed as per drawings.
 - K. Painting is completed. EQUIPMENT /MACHINERY, piping duly marked and labelled.
 - L. Safety equipments, systems are installed and checked for operations. Effluent management and treatment systems are installed and operational.
 - M. All Emergency & Instrument power system are checked and operating.
 - N. All chemical & lubricants are charged into the system.
 - O. PRECOMMISSIONING has been completed.
 - P. The PLANT is ready to take feed
 - Q. All packing and bed support materials are installed.
 - R. Liquidation of all punch list applicable for achieving MECHANICAL COMPLETION. Balance items of punch list, if any, shall be liquidated as mutually agreed
 - S. Temporary constructions facilities are removed to extent necessary to permit start of commissioning of Plant
-

	EMERGENCY DIESEL GENERATOR PACKAGE TALCHER FERTILIZERS LIMITED, ODISHA (INDIA) SPECIAL CONDITIONS OF CONTRACT	PC183/E-4022/P-I/S-V	0	
		DOC. NO.	REV	
		SHEET 25 OF 45		

1.2.19 **COMMISSIONING**

1.2.19.1 CONTRACTOR shall be responsible for COMMISSIONING after Mechanical Completion have been completed giving due regard to safety of EQUIPMENT in accordance with the procedures as per the requirement of Contract document after successful testing, pre-commissioning & trial run and per sound engineering practices. LSTK CONTRACTOR shall provide operating and maintenance personnel for the same. The COMMISSIONING activities shall be conducted as detailed in Section V-5.0 of NIT)

1.2.19.2 CONTRACTOR shall provide engineers as required to commission the PLANT.

1.2.20 **Performance Guarantee Test Run (PGTR)**

'PERFORMANCE & GUARANTEE TESTS RUN (PGTR)' shall mean all operational checks and tests required to determine and demonstrate capacity, efficiency and operating characteristics and proving guarantees for work cost as specified in the CONTRACT documents.

During the guarantee test, the range of operating conditions shall be within the limits of the design conditions and shall meet the requirements of safety and compliance with relevant Codes and Regulations
CONTRACTOR shall successfully complete PERFORMANCE TEST as specified in Technical Section-VI, 6.0 of NIT.

1.2.21 Deleted



1.2.22 **1 Months Supervisory Assistance- Not Applicable**

1.2.23 **Laws and Regulations**

1.2.23.1 CONTRACTOR shall abide, while fulfilling its obligations, by all applicable codes and APPLICABLE LAWS from time to time in force in the State of ODISHA and in India. FINAL PROPOSAL shall be based on the codes, and regulations applicable on the date of submission of the FINAL PROPOSAL.

In the event of change in any codes, legislation, laws or regulation applicable to PLANT WORK or any part thereof after date of submission of FINAL PROPOSAL, which alters the scope of CONTRACTOR's obligations under CONTRACT, CONTRACTOR shall agree to make the necessary changes in scope of WORK. Such changes shall be governed by CHANGE IN WORK as per the provisions of Clause -3 of SCC. Any additional fee becoming applicable due to any change of Acts, regulations, by-laws, orders and requirements after date of submission of FINAL PROPOSAL shall be borne by OWNER in accordance with SCC clause 3.0.

1.2.24 Deleted

	EMERGENCY DIESEL GENERATOR PACKAGE TALCHER FERTILIZERS LIMITED, ODISHA (INDIA) SPECIAL CONDITIONS OF CONTRACT	PC183/E-4022/P-I/S-V	0	
		DOC. NO.	REV	
		SHEET 26 OF 45		

1.2.25 Progress Monitoring and Reporting



1.2.25.1 CONTRACTOR shall develop a suitable system for monitoring and reporting progress on the various activities up to PRELIMINARY ACCEPTANCE. CONTRACTOR shall submit PROJECT MASTER SCHEDULE and detailed Network Schedule covering the activities and milestones starting from date of FOA until PRELIMINARY ACCEPTANCE, as described under Clause -1.2.13 above. These schedules shall include the activities of CONTRACTOR, SUB-CONTRACTOR/Sub-Vendor. CONTRACTOR shall monitor progress continuously and submit to EIC monthly progress reports giving the status of the activities, indicating those delayed and action being taken, or required to be taken, to bring back those activities on schedule. These reports will also include progress at vendor's workshops and shall be supplemented with photographs, wherever necessary. The Network Schedule shall be updated once in a month. CONTRACTOR shall also furnish information to ENGINEER-IN-CHARGE as may be required by any other Government Authority or any other agency such as Financing Institution etc.

1.2.26 Technical Information

1.2.26.1 CONTRACTOR shall furnish to OWNER, CONTRACTOR's Technical Information and know-how as may be necessary for the operation of PLANT and relating to its process according to the provisions of Article 53 of General Conditions of Contract. CONTRACTOR shall grant or cause to be granted to OWNER an irrevocable right to use all such above technical information for PLANT and shall further advise OWNER for a period of five (5) years from date of COMMISSIONING of any improvements in process, know-how, engineering, operation methods, and other conditions which will result in more efficient operation of PLANT that are developed by CONTRACTOR or process licensor or have come to the knowledge of CONTRACTOR, at no extra cost to OWNER. OWNER shall also grant to CONTRACTOR, at no extra cost to CONTRACTOR, to the benefit of process licensor the same right on OWNER's improvements as per the provisions of this Clause. Notwithstanding the generality of the foregoing, ownership of data, technical information processes, technology or software proprietary to CONTRACTOR and/or SUBCONTRACTORS shall remain with CONTRACTOR and/or SUBCONTRACTOR. CONTRACTOR and/or SUBCONTRACTOR shall ensure that OWNER is legally entitled to use of such data, processes, technology and software in the form of a perpetual, non-terminable, non-exclusive, royalty-free License for the purpose of the operation and maintenance of the PLANT.

1.2.27 Work of SUB-CONTRACTOR and vendor

1.2.27.1 CONTRACTOR shall remain responsible for proper execution of such part of WORK as are carried out by its SUB-CONTRACTOR and vendor and any failure of SUB-CONTRACTOR/vendor shall not relieve CONTRACTOR of its obligations under CONTRACT. Furthermore, in the event of any default by SUB-CONTRACTOR/vendor, CONTRACTOR shall either take over SUB-CONTRACTOR/vendor's part of WORK on mutually agreed terms or take remedial action as may be necessary in order to comply

	EMERGENCY DIESEL GENERATOR PACKAGE TALCHER FERTILIZERS LIMITED, ODISHA (INDIA) SPECIAL CONDITIONS OF CONTRACT	PC183/E-4022/P-I/S-V	0	
		DOC. NO.	REV	
		SHEET 27 OF 45		

with COMPLETION PERIOD and any other activities leading to PRELIMINARY ACCEPTANCE.

1.2.28 Co-ordination

1.2.28.1 CONTRACTOR shall render all necessary assistance to ENGINEER-IN-CHARGE required for overall co-ordination of all activities connected with WORKS. For this purpose, CONTRACTOR and ENGINEER-IN-CHARGE shall agree on a meeting as soon as practicable after issuance of FOA, with SUBCONTRACTOR/vendor's and such other parties as are necessary to settle the following:



- a) Review the basic design conditions set forth in FINAL PROPOSAL and where appropriate, review possibilities of standardisation.
- b) Assess the priorities and key dates required to be included in CONTRACTOR's PROJECT MASTER SCHEDULE.
- c) Make an assessment of all items requiring co-ordination.
- d) Fix up a date and agenda of any subsequent meeting as may be required in association with OWNER.
- e) Discuss with ENGINEER-IN-CHARGE and furnish all technical information.

In the event, ENGINEER-IN-CHARGE pursuant to its responsibilities of overall co-ordination requests CONTRACTOR to make any alteration to the programme, scope of responsibility under CONTRACT, CONTRACTOR shall do the same, subject to the provisions of Clause 3.0.

1.2.29 Notices and Reports

1.2.29.1. CONTRACTOR shall submit the following copies of notices to ENGINEER-IN-CHARGE as part of the Scope of Work:

- a) Immediate notification of safety incidents and accidents, including near misses, of any kind or type followed as soon as possible after such event by a full report.
- b) Notices from any Government / Statutory Agency or any other Person for a violation of any Law or Government Approval, immediately upon receipt by CONTRACTOR and no later than twenty-four (24) hours after its receipt.
- c) Inspection reports by any inspector whether relating to any accident, accepting any test reports or otherwise immediately upon receipt by CONTRACTOR and no later than two (2) working DAYS after its receipt.
- d) Any other matter/issue that involves OWNER's interest.

	EMERGENCY DIESEL GENERATOR PACKAGE	PC183/E-4022/P-I/S-V	0	
	TALCHER FERTILIZERS LIMITED, ODISHA (INDIA)	DOC. NO.	REV	
	SPECIAL CONDITIONS OF CONTRACT	SHEET 28 OF 45		

1.2.30 CONTRACTOR's Representative and Key Personnel



1.2.30.1 CONTRACTOR shall with prior consent of ENGINEER-IN-CHARGE, appoint a CONTRACT MANAGER to manage the execution of WORK and to be nominated as CONTRACTOR's Representative. CONTRACTOR's personnel stationed at SITE for providing services during the execution of WORK shall work under the supervision and guidance of CONTRACT MANAGER. The CONTRACT MANAGER shall have the full authority to make binding and enforceable decisions in the name of CONTRACTOR and shall receive all notices/correspondence that OWNER serves on CONTRACTOR.

1.2.30.2 CONTRACTOR shall be responsible for the work performed by CONTRACT MANAGER and CONTRACTOR's personnel and shall under no circumstances be relieved of its responsibilities and obligations under CONTRACT on account of acts or omissions of CONTRACT MANAGER and personnel.

1.2.30.3 The Key Personnel shall hold the staff positions as indicated in CONTRACT. CONTRACTOR shall use reasonable efforts to ensure that such Key Personnel will be engaged in the execution of WORK continuously until their role is completed unless prior release is approved by OWNER, such approval not to be unreasonably withheld or delayed. Replacement of or addition to Key Personnel shall only be made with persons having qualifications and experience equal to or better than those replaced or added to, and shall be similarly subject to OWNER's prior approval. In the event, any person identified in CONTRACT decides to leave the employment of CONTRACTOR, CONTRACTOR shall use reasonable efforts to retain the services of such person until his portion of WORK is complete. CONTRACTOR further agrees not to remove from WORK Key Personnel, which OWNER considers to be necessary for the proper performance of WORK without the prior written approval of OWNER.

1.2.31 General Warranties

- a) CONTRACTOR shall perform WORK in full compliance with its FINAL PROPOSAL and all other terms and conditions set forth herein.
- b) WORK shall be performed, in a good and workmanlike manner and in accordance with the FINAL PROPOSAL, all other terms and conditions of this CONTRACT, all DOCUMENTS, all Government Approvals, all APPLICABLE LAWS, and Good Industry Practices.
- c) All EQUIPMENT, installed as part of PLANT, (i) shall be free from any encumbrance or lien and shall conform to the specifications and descriptions set forth in CONTRACT and (ii) shall be new and unused, free from DEFECTS and Deficiencies of any kind and shall meet the requirements of the Scope of Work.
- d) The completed PLANT shall be free of DEFECTS and Deficiencies and shall be designed, constructed and engineered, in compliance with the Scope of Work.

	EMERGENCY DIESEL GENERATOR PACKAGE	PC183/E-4022/P-I/S-V	0	
	TALCHER FERTILIZERS LIMITED, ODISHA (INDIA)	DOC. NO.	REV	
	SPECIAL CONDITIONS OF CONTRACT	SHEET 29 OF 45		

- e) PLANT shall be designed, engineered, constructed, tested, completed and delivered based on Good Industry Practices, CONTRACTOR's specifications and guidelines for operation and maintenance in accordance with the Scope of Work, for CONTRACT PRICE and no later than the COMPLETION PERIOD.
- f) All SUB-CONTRACTOR/vendor shall perform their portion of the Scope of Work or supply or install EQUIPMENT in accordance with the applicable terms set forth herein.
- g) Adherence to the Operations Manual shall allow safe start-up, operation, maintenance and shut-downs of the completed PLANT, in accordance with CONTRACTOR's guidelines and will not impair any warranty or guarantee of EQUIPMENT incorporated or to be incorporated into PLANT.

1.2.32 General

- 1.2.32.1 CONTRACTOR shall incorporate during design stage maximum utilization of goods manufactured and/or available in India and also avail shipping, insurance, banking, catering and any other services available from India-owned companies for installation of plant, if quality, delivery and overall cost characteristics are equivalent.
- 1.2.32.2 CONTRACTOR shall arrange insurance pursuant to Clause 28.0 of GCC, at its own cost.
- 1.2.32.3 CONTRACTOR shall provide necessary information, documentation, and assistance for obtaining any approvals from Financial Institutions or any other agencies or authorities.

2.0 OWNER'S OBLIGATIONS



OWNER shall be responsible for fulfilling all obligations as specified under the following heads:

2.1 Deleted



2.2 Overall Co-Ordination

The objective of overall co-ordination is to organise orderly execution of WORK, bring about requisite integration amongst the various project activities of executing agencies, to avoid interference between the various activities of the parties in order to achieve the earliest possible completion of WORK. The aim will be to integrate, have compatibility between plants and uniform standardisation of design, engineering, layout, etc.

2.3.0 Review and Approval of Work

	EMERGENCY DIESEL GENERATOR PACKAGE TALCHER FERTILIZERS LIMITED, ODISHA (INDIA) SPECIAL CONDITIONS OF CONTRACT	PC183/E-4022/P-I/S-V	0	
		DOC. NO.	REV	
		SHEET 30 OF 45		

- 2.3.1 CONTRACTOR shall associate OWNER's representatives with WORK as carried out by CONTRACTOR's personnel. For this purpose, OWNER shall associate with WORK at all stages. Specifically, OWNER shall undertake the following tasks:
- a) Review/APPROVAL of drawings as per Technical Section and other documents connected with basic and detailed engineering.
 - b) Review of specifications for EQUIPMENT, lists of spare parts and special maintenance tools, and lists of special construction aids, tools, tackles, and fixtures.
 - c) Participation in inspection, expediting and testing of EQUIPMENT at SUB-CONTRACTOR's / vendor's works and at SITE, wherever considered necessary by OWNER.
- 2.3.2 For the smooth functioning, OWNER will nominate an individual who will act as EIC under the CONTRACT. The EIC will have full authority to act on behalf of the OWNER in connection with the CONTRACT. Except as otherwise provided in the CONTRACT, all communications between the OWNER and the CONTRACTOR relating to the WORKS shall be between the ENGINEER-IN-CHARGE and the CONTRACT MANAGER.
- 2.4 Deleted**
- 2.5 Facilities for CONTRACTOR's Personnel**
- OWNER shall assist CONTRACTOR in obtaining Visas and other PERMITS from the appropriate authorities for CONTRACTOR's and SUB-CONTRACTOR's / vendor's expatriates to enter and stay in India as necessary for performance of WORK. OWNER shall also provide facilities to CONTRACTOR's expatriates in accordance with the provisions described in Clause-2.8.
- 2.6 Operating and Maintenance Personnel**
- OWNER may associate its personnel with the construction and erection of PLANT to familiarise the personnel with WORK, and generally to prepare for proper operation and maintenance of PLANT.
- 2.7 Feed stock and Utilities**
- OWNER shall make available the utilities as specified in Section VI-2.0 of bid document for commissioning and PGTR.
- 2.8 Site Facilities**
- OWNER shall provide the following SITE facilities:
- a) Land for Construction Activities

	EMERGENCY DIESEL GENERATOR PACKAGE	PC183/E-4022/P-I/S-V	0	
	TALCHER FERTILIZERS LIMITED, ODISHA (INDIA)	DOC. NO.	REV	
	SPECIAL CONDITIONS OF CONTRACT	SHEET 31 OF 45		

- b) General safety and security without prejudice to Contractor's obligations.
- c) Construction Power & Construction Water shall be provided as per clause 1.1.1 (g) above
- d) Free and unrestricted access to SITE for CONTRACTOR's Authorized Personnel
- e) OWNER shall NOT provide any accommodation and facilities for travelling to and from SITE to the place of residence to the personnel of CONTRACTOR/ SUB-CONTRACTOR, deputed at SITE for performing WORK under CONTRACT.
- f) Area for making shed/covered storage for storing EQUIPMENT.

3.0 CHANGES IN WORK/CHANGE ORDER



- 3.1 OWNER may at any time order change in work scope. OWNER shall have the right to request in writing changes in WORK within the scope of CONTRACT. When the request for a change in WORK by OWNER has been agreed and complied by CONTRACTOR, CONTRACTOR's obligations under CONTRACT shall remain unaffected unless otherwise agreed.

Changes may consist of additions, deletions or revisions of the Scope of Work, and may cause the CONTRACT PRICE, the work schedule or the COMPLETION PERIOD or any other CONTRACTOR's WARRANTIES to be adjusted.

CONTRACTOR shall be entitled to an extension of time to COMPLETION PERIOD suffered and/or payment of additional costs incurred as a result of any change in law or legislation, by way of a CHANGE ORDER, in case it is necessitated or if it becomes applicable.



- 3.2 The ENGINEER IN CHARGE shall have the right to make any alterations in, omission from, additions to or substitutions for in the scope of work, the original specifications, drawings, designs and instructions that may appear to him to be necessary or advisable during the progress of the WORK and the CONTRACTOR shall be bound to carry out the such altered/ extra/ new items of WORK in accordance with any instructions which may be given to him in writing signed by the ENGINEER IN CHARGE, and such alterations, omissions, additions or substitutions shall not invalidate the CONTRACT and any altered, additional or substituted work which the CONTRACTOR may be directed to do in the manner above specified as part of the WORK shall be carried out by the CONTRACTOR on the same conditions in all respects on which he agreed to do the main WORK. The time of completion of WORK may be extended for the part of the particular job at the discretion of the ENGINEER IN CHARGE, for only such alterations, additions or substitutions of the WORK, as he may consider as just and reasonable. The rates for such additional, altered or substituted WORK under this clause shall be worked out in accordance with the following:-

CONTRACTOR shall, within 7 days of the date of receipt of order to carry out the WORK, inform the ENGINEER IN CHARGE of the rates which it is his intention to charge for such class of WORK, supported by analysis of the rate or rates claimed,

	EMERGENCY DIESEL GENERATOR PACKAGE	PC183/E-4022/P-I/S-V	0	
	TALCHER FERTILIZERS LIMITED, ODISHA (INDIA)	DOC. NO.	REV	
	SPECIAL CONDITIONS OF CONTRACT	SHEET 32 OF 45		

and the ENGINEER IN CHARGE shall determine the rate or rates on the basis of the prevailing market rates, labour cost at schedule of labour rates plus 10% to cover contractor's supervision, overheads and profit and pay the CONTRACTOR accordingly. The opinion of the ENGINEER IN CHARGE as to current market rates of materials and the quantum of labour involved per unit of measurement will be final and binding on the CONTRACTOR.

- 3.3. If it is established that a request for Change in Work asked by Owner does not fall under original Scope of Contract, then CONTRACTOR shall promptly submit cost estimate, and / or time extension and / or terms of payment (as applicable) for making the requested change in WORK together with the details of any variation required to be made to any of CONTRACTOR's or OWNER's obligations and/or guarantees as per clause 3.2 above.
- 3.4 If in CONTRACTOR's opinion fulfillment of any of its obligations under CONTRACT would be jeopardized by a CHANGE IN WORK requested by OWNER, then CONTRACTOR shall explain in writing to OWNER the reasons for not accepting these changes within fifteen (15) days of receipt of OWNER's written request.
- 3.5 OWNER and CONTRACTOR shall agree upon the basis and terms of the CHANGE IN WORK in writing.
- 3.6 It is understood that no change shall become effective and no change will alter the scope of WORK until all of the matters referred to in this *Clause 3* have been mutually agreed upon in writing by OWNER and CONTRACTOR.
- 3.7 It is agreed by both parties that the following changes shall not be considered a CHANGE IN WORK in the meaning in this Clause:
- a) Minor changes requested by OWNER and accepted by CONTRACTOR which do not involve any substantial additional cost or man-hour effort, and have no effect on contractual completion period, and/or
 - b) Any change necessitated due to requirements of prevalent laws in India upto the time of submission of FINAL PROPOSAL.
- 3.8 This clause is to be read in conjunction with Clause No. 5.0 of GCC.

	EMERGENCY DIESEL GENERATOR PACKAGE TALCHER FERTILIZERS LIMITED, ODISHA (INDIA) SPECIAL CONDITIONS OF CONTRACT	PC183/E-4022/P-I/S-V	0	
		DOC. NO.	REV	
		SHEET 33 OF 45		

4.0 ACCEPTANCE OF PLANTS AND FACILITIES

CONTRACTOR's liabilities for the Performance Guarantees given for the PLANTS and Facilities in respect of capacity, consumption, product quality and pollution level shall be discharged only when the PERFORMANCE AND GUARANTEE TESTS as stipulated in Technical, Section VI-6.0 of NIT have been successfully carried out as per Plant Acceptance criteria specified at Clause 5.0 below and OWNER has issued PRELIMINARY ACCEPTANCE CERTIFICATE.

5.0 PLANT ACCEPTANCE CRITERIA



Subject to fulfilling PERFORMANCE AND GUARANTEE TESTS as per Section VI-6.0 of NIT and Clause 18.0 of SCC, OWNER shall be in readiness to accept the PLANT. CONTRACTOR shall take all steps to fulfil the provisions of the CONTRACT for OWNER to issue PRELIMINARY ACCEPTANCE CERTIFICATE. The care and custody of the PLANT shall be passed on to OWNER on COMMISSIONING of all the PLANT.

6.0 PRELIMINARY ACCEPTANCE

PRELIMINARY ACCEPTANCE shall mean that following milestones have been achieved (i) MECHANICAL COMPLETION has occurred, (ii) PRE-COMMISSIONING and COMMISSIONING of the PLANT have been accomplished, (iii) Deleted (iv) PGTR has been conducted by LSTK Contractor and accepted by OWNER (v) All statutory approvals in the scope of Contractor, required to operate and maintain the PLANT have been obtained (vi) OWNER has received all DOCUMENTS required hereunder to start up, operate and maintain the PLANT (vii) OWNER has received all operations, maintenance, and spare parts manuals and instruction book necessary to operate and maintain the PLANT in a safe, efficient and effective manner (viii) all special tools and spare parts purchased by CONTRACTOR as provided herein have been delivered to OWNER; and (ix) CONTRACTOR has completed the training program of OWNERS personnel as required under this CONTRACT (x) All demonstration runs have successfully completed

6.1 ISSUANCE OF PRELIMINARY ACCEPTANCE CERTIFICATE

Within 30 (thirty) DAYs from completing successfully all activities as defined at clause 6.0 above by the CONTRACTOR and CONTRACTOR fulfilling all the obligations under the provision of the CONTRACT, OWNER shall issue PRELIMINARY ACCEPTANCE CERTIFICATE to CONTRACTOR . On issue of this Certificate by OWNER, CONTRACTOR shall become entitled to receive all associated payment as per provisions of the CONTRACT due to CONTRACTOR subject to CONTRACTOR's fulfilling the obligations stipulated under CONTRACT.

	EMERGENCY DIESEL GENERATOR PACKAGE	PC183/E-4022/P-I/S-V	0	
	TALCHER FERTILIZERS LIMITED, ODISHA (INDIA)	DOC. NO.	REV	
	SPECIAL CONDITIONS OF CONTRACT	SHEET 34 OF 45		

7.0 LABOUR AND STAFF

- 7.1 The CONTRACTOR shall make his own arrangement for labour, erection and COMMISSIONING engineers and all other staff required for carrying out the WORK. The necessary permissions from Government of India regarding work permit and visa requirement shall be obtained by the CONTRACTOR.
- 7.2 The CONTRACTOR shall make his own arrangements for providing canteen service to his labour and staff. Open space for this purpose may be provided by OWNER.
- 7.3 The CONTRACTOR shall at his own cost provide office and other accommodation for his staff and workmen. The CONTRACTOR shall also provide communication, transport and medical facilities to his staff and workmen.
- 7.4 The CONTRACTOR shall be responsible for all statutory obligations and any other laws in this regard in force from time to time regarding the employment or conditions of service of CONTRACTOR's labour, workman or employees.
- 7.5 The CONTRACTOR shall observe all safety rules as required under various rules, regulations and laws in India and shall also strictly adhere to safety regulations of OWNER.



8.0 TRAINING OF OWNER'S PERSONNEL- NOT APPLICABLE

9.0 MODE OF CONTRACTING



- 9.1 Notwithstanding anything stated elsewhere in the CONTRACT documents, the CONTRACT is awarded on Lumpsum turnkey basis with single point responsibility.
- 9.2 The CONTRACT shall be in all respect being construed and governed in accordance with the Indian laws.
- 9.3 The Contract shall be treated as a "WORK CONTRACT SERVICE".

10.0 FINAL BILL

- 10.1 On the basis of the LUMPSUM PRICE provided in the CONTRACT and subsequent Change Order(s)/Amendment(s), if any and the approved billing schedule, the CONTRACTOR shall prepare a Final Bill in the prescribed form. Additions claimed to the LUMPSUM PRICE or reductions thereof on account of CHANGE ORDER(s) shall be separately indicated in the Final Bill with reference to the relative CHANGE ORDERS(s).
- 10.2 The Final Bill shall, in addition to the payment entitlements arrived at according to the provisions of Clause 10.1 hereof shall separately state and include therein all claims of the CONTRACTOR, if any, with full particulars of the nature of such claim and grounds on which it is based and the amount claimed.

	EMERGENCY DIESEL GENERATOR PACKAGE	PC183/E-4022/P-I/S-V	0	
	TALCHER FERTILIZERS LIMITED, ODISHA (INDIA)	DOC. NO.	REV	
	SPECIAL CONDITIONS OF CONTRACT	SHEET 35 OF 45		

- 10.3 The Final Bill drawn in accordance with Clause 10.1 shall be submitted together with the PRELIMINARY ACCEPTANCE CERTIFICATE to the ENGINEER-IN-CHARGE for certification, who shall certify the Final Bill, if drawn in accordance with Clause 10.1 After certification of the ENGINEER-IN-CHARGE, the Final Bill shall be submitted in quadruplicate (or in such other number of copies as the OWNER may prescribe) accompanied by the PRELIMINARY ACCEPTANCE CERTIFICATE to the OWNER for payment.
- 10.4 All monies payable under the CONTRACT for WORKS to be performed and MATERIALS to be supplied up to and including successful completion and final tests and commissioning of the system and performance tests shall become due and payable to the CONTRACTOR only after submission to the OWNER of the Final Bill prepared in accordance with the provisions of Clause 10.1 hereof and associated provisions there under accompanied by the PRELIMINARY ACCEPTANCE CERTIFICATE in respect of the WORKS.
- 10.5 Payments of the amount(s) due on the Final Bill to the extent certified by the ENGINEER-IN-CHARGE, shall be made within 84 (Eighty Four) days from the due date as specified in Clause 10.4 hereof, subject to the deductions provided in Clause 10.6.
- 10.6 All payments due to the CONTRACTOR on the Final Bill shall be subject to, tax deductions as provided for in Clause 11.0 and associated clauses there under and any other deduction provided in the CONTRACT or required to be made under any law, rule or regulation having the force of law for the time being applicable, or elsewhere provided for in the CONTRACT documents.
- 11.0 Deleted
- 12.0 Deleted
- 13.0 **STATUTORY VARIATION IN TAXES AND DUTIES**
- 13.1 No variation on account of taxes and duties, statutory or otherwise, (other than due to change in turnover) shall be payable by OWNER to CONTRACTOR, except for GST. Any statutory variation in GST, shall be payable up to COMPLETION PERIOD against documentary evidence. Any reduction in the amount of GST resulting from a reduction in the rate of GST or remission or exemption from GST with respect to Goods and Services provided to the OWNER shall be refundable to the OWNER at actuals within the COMPLETION PERIOD and also during the delayed contractual Project completion, if any. The CONTRACTOR shall submit a copy of the 'Government Notification' to evidence the rate as applicable on the Bid due date and on the date of revision.
- 13.2 Any new taxes, duties, cess, levies notified or imposed after the submission of Price Bid but before COMPLETION PERIOD shall be to OWNER's Account.
- 13.3 In case of delayed completion beyond the COMPLETION PERIOD for reasons solely attributable to Contractor, even though extension of completion time is allowed by

	EMERGENCY DIESEL GENERATOR PACKAGE	PC183/E-4022/P-I/S-V	0	
	TALCHER FERTILIZERS LIMITED, ODISHA (INDIA)	DOC. NO.	REV	
	SPECIAL CONDITIONS OF CONTRACT	SHEET 36 OF 45		

OWNER, all extra costs on account of changes of statutory regulations/ acts shall not apply to the Contract price and shall be borne by the CONTRACTOR.

However, any decrease in taxes and duties during the delayed period shall be passed on to the OWNER.

In case the COMPLETION PERIOD is extended for reasons solely attributable to OWNER, then any increase on account of statutory changes in GST until the extended period shall be borne by OWNER. Further, any new taxes, duties, cess, levies notified or imposed after the submission of Price Bid during such extended COMPLETION PERIOD shall be to OWNER's Account.

- 13.4 Claim for payment of GST (CGST & SGST/UTGST or IGST)/ Statutory variation, should be raised within two [02] months from the date of issue of 'Government Notification' for payment of differential (in %) GST (CGST & SGST/UTGST or IGST), otherwise claim in respect of above shall not be entertained for payment of arrears.

The base date for the purpose of applying statutory variation shall be the Bid Due Date.



14.0 TERMS OF PAYMENT

- 14.1 Payments shall be made by OWNER to the CONTRACTOR through RTGS / NEFT.

- 14.2 **MOBILISATION ADVANCE – Not applicable.**

- 14.3 Subject to the other provisions of the Contract documents, payments shall be made as follows:

Sl.No.	Stage of Work	Engine-Alternator Set including AMF panel	All other Items.
1.0	Against approval of major drawing in Code 2 viz; GA drawing , Single line drawing(SLD) and QAP	5% (Five Percent) of Total Contract value	5% (Five Percent) of Total Contract value
2.0	Against RECEIPT OF MATERIAL AT SITE	60% (Sixty Percent) of Total Contract value	10% (Ten Percent) of Total Contract value
3.0	10% (Ten percent) of Total Contract value on MECHANICAL COMPLETION.		
4.0	8% (Eight percent) of Total Contract value on successful COMMISSIONING/PGTR and on issue of PRELIMINARY ACCEPTANCE CERTIFICATE		
5.0	2% (Two percent) of Total Contract value on completion of balance jobs, if any, against the CONTRACTOR's Certified Final Bill		

	EMERGENCY DIESEL GENERATOR PACKAGE	PC183/E-4022/P-I/S-V	0	
	TALCHER FERTILIZERS LIMITED, ODISHA (INDIA)	DOC. NO.	REV	
	SPECIAL CONDITIONS OF CONTRACT	SHEET 37 OF 45		

14.4 **Payment shall be released on submission of the following documents with the CONTRACTOR's invoice against SI. No.2.0 above.**

- (a) Signed Invoice(s)
- (b) Delivery Challan
- (c) Packing list.
- (d) Manufacturer's certificate of inspection for shipment duly approved by the CONTRACTOR in one original and one photocopy
- (e) Third Party Inspection Release Note clearly indicating that material has been inspected and accepted as per QAP approved by OWNER/PMC, or waiver certificate issued by OWNER/PMC.
- (f) Railway Receipt/LR
- (g) Certificate of Insurance Policy
- (h) Entry gate pass duly endorsed by OWNER's security for verification of physical entry of material to SITE.

14.5 **PAYMENT METHODOLOGY**

CONTRACTOR shall enclose all documents as per check list issued by PMC/OWNER. After receipt of complete RA Bill as per terms and conditions of the contract and duly certified by Engineer-in-Charge (EIC) / PMC, on-account payment equivalent to seventy percent (70%) of the net payable certified amount of the RA Bill will be released to the Contractor within a period of seven (07) working days from submission of certified bill by PMC to TFL. The balance amount will be released within a period of 15 days from submission of certified bill by PMC to TFL.

14.6 All invoices shall be submitted in quadruplicate to EIC by the Bidder.

15.0 **Deleted**



16.0 **DEEMED ACCEPTANCE- NOT APPLICABLE**

17.0 **DEFECT LIABILITY PERIOD AND LIABILITY FOR DEFECT**

17.1 The DEFECT LIABILITY PERIOD shall be for a period of 12 (Twelve) months from the date of PRELIMINARY ACCEPTANCE/~~DEEMED ACCEPTANCE~~

If at any time before the PRELIMINARY ACCEPTANCE or during the DEFECT LIABILITY PERIOD stated below, the OWNER:

- (a) Claims that any matter is a DEFECT; and
- (b) as soon as reasonably practicable gives to the CONTRACTOR notice of the particulars of the DEFECT; the CONTRACTOR shall as soon as possible make good the DEFECT so notified and the OWNER shall so far as may be necessary place the PLANT at the

	EMERGENCY DIESEL GENERATOR PACKAGE	PC183/E-4022/P-I/S-V	0	
	TALCHER FERTILIZERS LIMITED, ODISHA (INDIA)	DOC. NO.	REV	
	SPECIAL CONDITIONS OF CONTRACT	SHEET 38 OF 45		

CONTRACTOR's disposal for this purpose. The CONTRACTOR shall, if so required by the EIC, submit his proposals for making good any DEFECT to the EIC for his approval.

17.2 If any DEFECT arises from any breach of the CONTRACT by the CONTRACTOR, the CONTRACTOR shall bear his own cost of making good the DEFECT. In the case of any other matter made good by the CONTRACTOR, the work done by the CONTRACTOR shall be the subject of CHANGE ORDER.

17.3 The performance guarantees are demonstrated only through the performance tests carried out before the achievement of the PRELIMINARY ACCEPTANCE CERTIFICATE.

CONTRACTOR shall carry out further test(s) on the repaired/replaced item during the DEFECT LIABILITY PERIOD having the sole purpose to verify that said item is capable of working in compliance with contractual requirements. Such test(s) shall not be intended as a repetition of the performance tests already performed.



If DEFECT is made good after the issue of a PRELIMINARY ACCEPTANCE CERTIFICATE, the EIC may require the CONTRACTOR to repeat any appropriate performance test for the purpose of establishing that the DEFECT has been made good. The CONTRACTOR shall be responsible for the cost of any repeat inspection or test in the event of an inspection or test failure.

17.4 If in the course of making good any DEFECT which arises during the DEFECT LIABILITIES PERIOD and CONTRACTOR repairs, replaces or renew any part of the PLANT, this Clause 17 shall apply to the repair or to that part of the PLANT so replaced or renewed and shall further apply until the expiry of a period of 12 months from the date of such repair, replacement or renewal (the extended DEFECT LIABILITY PERIOD). However, extended DEFECT LIABILITY PERIOD shall have an upper limit of 24 months, starting from the date of Commissioning. .

17.5 If the CONTRACTOR does not make good with a reasonable time any DEFECT which he is liable to make good under Sub-Clause 17.1 then the OWNER may, in addition to any other remedies or relief available to him under the CONTRACT, proceed to do the work, provided that the OWNER gives at least fourteen DAYS notice of his intention.

17.6 If the OWNER reasonably requires that any DEFECT notified to the CONTRACTOR under Sub-clause 17.1 which arises during the DEFECT LIABILITY PERIOD be made good urgently and the CONTRACTOR is unable or refuses to comply within a reasonable time, the OWNER may, in addition to any other remedies or relief available to him under the CONTRACT, proceed to do the work in such a manner as the ENGINEER-IN-CHARGE may decide, including the employment of a third party.

17.7 If the OWNER has made good a DEFECT in accordance with Sub-clause 17.5 or 17.6, the CONTRACTOR shall reimburse the OWNER his reasonable cost of so doing provided that the OWNER gives a notice to the CONTRACTOR of his intention and submits a claim supported by DOCUMENTS. The ENGINEER-IN-CHARGE and the CONTRACTOR may agree the amount to be paid by the CONTRACTOR, or in the absence of agreement the

	EMERGENCY DIESEL GENERATOR PACKAGE	PC183/E-4022/P-I/S-V	0	
	TALCHER FERTILIZERS LIMITED, ODISHA (INDIA)	DOC. NO.	REV	
	SPECIAL CONDITIONS OF CONTRACT	SHEET 39 OF 45		

ENGINEER-IN-CHARGE shall decide such amount as may be reasonable. Such amount shall be:

- a) deducted from any money that would otherwise be payable under the CONTRACT;
or
- b) paid by the CONTRACTOR to the OWNER

17.8 If the PLANT cannot be used because of a DEFECT to which this Clause 17 applies, the DEFECT LIABILITY PERIOD, or if applicable the extended DEFECT LIABILITY PERIOD, shall be extended by a period equal to the period during which it cannot be used. Similarly the DEFECT LIABILITY PERIOD, or if applicable the extended DEFECT LIABILITY PERIOD shall be extended by any period wherein the PLANT cannot be used by reason of the CONTRACTOR putting the PLANT into such condition that it passes any relevant performance test or attempting to do so.

18.0 PERFORMANCE TESTS

18.1 The performance tests to be carried out on the PLANT shall be as specified in Technical, Section VI-8.0 of NIT.

18.2 The performance test shall be carried out by the CONTRACTOR in the presence of OWNER/PMC.

The CONTRACTOR shall give a notice to the EIC/OWNER about his readiness to carry out the performance tests, including a proposal for the time at which the tests would commence. The CONTRACTOR shall then confirm, at least fifteen (15) DAYS before the commencement of the performance tests.



18.3 Every performance test shall be carried out to completion unless the EIC or the CONTRACTOR shall order it to be stopped because its continuance would be unsafe or unacceptable to either party.

18.4 If PGTR fails due to any reason, CONTRACTOR has to make necessary adjustments and modifications and take all remedial measures at his own cost and demonstrate PGTR.

The OWNER shall permit to CONTRACTOR to make adjustments and modifications to any part of the Plant before the repetition of any performance test.

The CONTRACTOR shall submit details of the adjustments and modifications which he proposes to make.

18.5 If any performance test is stopped before its completion, due to reasons attributable to OWNER, such test shall be repeated as soon as practicable thereafter. However, the OWNER shall have the option to operate the plant in accordance with the Operating Manuals provided by CONTRACTOR, whereupon care and custody of the PLANT shall pass on to the OWNER and DEFECT LIABILITY PERIOD shall start. The OWNER shall exercise the option to allow CONTRACTOR to carry out the Performance Tests with grant

	EMERGENCY DIESEL GENERATOR PACKAGE	PC183/E-4022/P-I/S-V	0	
	TALCHER FERTILIZERS LIMITED, ODISHA (INDIA)	DOC. NO.	REV	
	SPECIAL CONDITIONS OF CONTRACT	SHEET 40 OF 45		

of extension of time by such number of days of deferment. Such deferment shall not exceed more than 90 days. In case the deferment exceeds 90 days, the Owner shall reimburse the additional cost of remobilisation incurred due to such deferment. However, the outer limit of such deferment shall be 12 months from COMMISSIONING and the provisions of Clause 16 shall apply thereafter. If the PLANT fails to pass any performance test, such test shall, subject to Sub-clause 18.7, be repeated as soon as practicable thereafter. The OWNER shall permit to CONTRACTOR to make adjustments and modifications to any part of the Plant before the repetition of any performance test and shall, if the CONTRACTOR reasonably requires, shut down any part of the PLANT for such purpose and restart it after completion of the adjustments and modifications, which shall be made by the CONTRACTOR with all reasonable speed.

The timing of such shutdown shall be agreed between the CONTRACTOR and the EIC, provided that if any or both i.e. the timing of shutdown or repetition of Performance Test, is required to be deferred, the agreed period of Performance Test Period shall be accordingly extended.

The CONTRACTOR shall, if so required by the EIC, submit to the EIC for his information details of the adjustments and modifications which he proposes to make.

The CONTRACTOR shall make such adjustment and modifications at his own cost.

18.6 The result of the performance tests shall be compiled by the CONTRACTOR and to be submitted to OWNER/PMC for evaluation.

18.7 If the PLANT passes performance tests towards meeting all Performance Guarantees specified at Section VI-8.0 (TECHNICAL) of NIT, but does not pass the performance test towards meeting Works Guaranteed cost for reasons which are the responsibility of the CONTRACTOR, then



i) If, the results of the performance tests towards meeting Guaranteed Works Cost are within the limits for the application of MUTUALLY AGREED DAMAGES, CONTRACTOR shall at its option either:

(a) may carry out remedial measures necessary to attain the Guaranteed Works Cost and repeat the performance test; or

(b) pay the applicable MUTUALLY AGREED DAMAGES in terms of clause 31 GCC.

Upon payment or allowance of such sum the CONTRACTOR shall become entitled to PRELIMINARY ACCEPTANCE CERTIFICATE which shall inter alia state that applicable MUTUALLY AGREED DAMAGES have been paid in respect of shortfall in performance and CONTRACTOR shall be released from all liability with respect to PGTR.

Further, in case of a) above, the CONTRACTOR will be allowed only one more chance to pass the performance test towards meeting Guarantee Works Cost.

	EMERGENCY DIESEL GENERATOR PACKAGE	PC183/E-4022/P-I/S-V	0	
	TALCHER FERTILIZERS LIMITED, ODISHA (INDIA)	DOC. NO.	REV	
	SPECIAL CONDITIONS OF CONTRACT	SHEET 41 OF 45		

- ii) If the results of the performance tests towards Guaranteed Works Cost are outside the limits for application of MUTUALLY AGREED DAMAGES specified in the CONTRACT, OWNER may at his option:
- a) instruct the CONTRACTOR to investigate or to co-operate with the EIC or others in the investigation of the reasons in its WORK for the shortfall in the performance;
 - b) instruct the CONTRACTOR to propose remedial measure and work necessary to correct the shortfall whether as the result of any such investigation or not;

and/or
 - c) Recommend the CONTRACTOR to carry out, at CONTRACTOR'S option, whatever remedial measures and work within its scope of WORK may be necessary to correct the shortfall.



Thereafter the EIC or CONTRACTOR may require that the PERFORMANCE GUARANTEE TEST RUN be repeated, the result of which shall be subject to this Sub-clause 18.7 (i).

The CONTRACTOR shall bear his own cost of work undertaken in accordance with (a), (b) or (c) above.

- iii. After 3 (three) failed Performance Tests as specified at Technical Section VI-8.0 of NIT for reasons attributable to the CONTRACTOR, the OWNER shall have right to proceed with the encashment of Contract Performance Security and other provisions also take all action as per Clause 34 of GCC shall further apply.



19.0 FINAL ACCEPTANCE CERTIFICATE

- 19.1 As soon as DEFECT LIABILITIES PERIOD for the PLANT has expired or the CONTRACTOR has made good all DEFECTS that have within such period appeared in the PLANT in accordance with Clause 17 (Liability for Defects), whichever is later, the EIC shall issue a FINAL ACCEPTANCE CERTIFICATE to the CONTRACTOR certifying that the CONTRACTOR has performed his obligations in respect of the DEFECT LIABILITY PERIOD and associated clauses thereunder, and until issue of such FINAL ACCEPTANCE CERTIFICATE, the CONTRACTOR shall be deemed not to have performed such liabilities notwithstanding issue of the PRELIMINARY ACCEPTANCE CERTIFICATE or payment of the Final Bill by the OWNER.
- 19.2 The FINAL ACCEPTANCE CERTIFICATE shall constitute conclusive evidence for all purposes and in any proceedings whatsoever between the OWNER and the CONTRACTOR that the CONTRACTOR has completed the PLANT and made good all DEFECTS therein in all respects in accordance with his obligations under the CONTRACT.

	EMERGENCY DIESEL GENERATOR PACKAGE	PC183/E-4022/P-I/S-V	0	
	TALCHER FERTILIZERS LIMITED, ODISHA (INDIA)	DOC. NO.	REV	
	SPECIAL CONDITIONS OF CONTRACT	SHEET 42 OF 45		

No FINAL ACCEPTANCE CERTIFICATE shall be conclusive as stated above if FINAL ACCEPTANCE CERTIFICATE was issued in reliance upon any fraudulent act, misrepresentation or concealment.

- 19.3 In the event that OWNER fails to issue the FINAL ACCEPTANCE CERTIFICATE, or fails to notify CONTRACTOR the reason for not issuing said certificate of acceptance, within a period of 60 days from CONTRACTOR's application, the FINAL ACCEPTANCE CERTIFICATE shall be deemed as issued by OWNER for all contractual purposes.
- 19.4 Upon application for the FINAL ACCEPTANCE CERTIFICATE, the CONTRACTOR shall:
- (i) Be deemed to have warranted that it had been fully paid and satisfied all claims for or arising out of the WORK, labour, MATERIALS, supplies and EQUIPMENT used in or connected with the CONTRACT and all other liabilities whatsoever touching or affecting the CONTRACT, or its performance, including in relation to SUB-CONTRACTORS and suppliers, and
 - (ii) To have undertaken to indemnify and keep indemnified the OWNER from and against all claims, demands, debts, liens, obligations and liabilities whatsoever arising there from or relating thereto.
- 19.5 Upon issue of the FINAL ACCEPTANCE CERTIFICATE, the CONTRACTOR shall be deemed to have released, acquitted and discharged the OWNER from and against all claims (known or unknown), liens, demands or causes of action of any kind whatsoever arising out of or relating to the CONTRACT or otherwise howsoever touching or affecting the same.
- 19.6 Forthwith on application made by the CONTRACTOR in this behalf accompanied by the FINAL ACCEPTANCE CERTIFICATE, or within 84 (Eighty Four) days of the OWNER passing the CONTRACTOR's Final Bill, whichever shall be later, the OWNER shall cancel and return to the CONTRACTOR all previous Bank Guarantees remaining unutilised in the hands of the OWNER, and upon such cancellation and return, the OWNER shall stand discharged of all obligations/ liabilities under the CONTRACT provided that the cancellation and return of any Bank Guarantee(s) furnished by the CONTRACTOR as and by way of Contract Performance Security shall be subject to the CONTRACTOR replacing such Bank Guarantee(s) covering 10% (ten percent) of the value (or as determined by the OWNER) of equipments/works replaced or repaired during the DEFECT LIABILITY PERIOD for the unexpired term of extended defect liability period in respect thereof plus a 6 (six) months period. The claims or demands made during such additional 6 months period shall refer to events which has occurred before the expiry of the DEFECT LIABILITY PERIOD.

	EMERGENCY DIESEL GENERATOR PACKAGE	PC183/E-4022/P-I/S-V	0	
	TALCHER FERTILIZERS LIMITED, ODISHA (INDIA)	DOC. NO.	REV	
	SPECIAL CONDITIONS OF CONTRACT	SHEET 43 OF 45		

20.0 COMPLETION PERIOD:

Completion period for the entire package shall be 10 (Ten) months from the date of FOA.

21.0 MUTUALLY AGREED DAMAGES (MAD)

21.1 For Delay in Completion



21.1.1 The CONTRACTOR agrees that the work shall be commenced and carried on at such points, and in the order of precedence and at such times and seasons as may be directed by the OWNER in accordance with the schedule for the completion of work as outlined in the CONTRACT. The CONTRACTOR declares that he has familiarised himself with the site and rights of way, ground conditions, with all the local conditions, and with all the circumstances which may or are likely to affect the performance and completion of the work and that he has allowed for such conditions in the preparation of this schedule. The progress of work shall be checked at regular monthly intervals and the percentage progress achieved shall be commensurate with the time elapsed after the award of the CONTRACT.

21.1.2 However, it is not incumbent upon the ENGINEER-IN-CHARGE to notify the CONTRACTOR when to begin or to cease or to resume work, nor to give early notice of the rejection of a faulty work, nor in any way to superintend so as to relieve the CONTRACTOR of responsibility of any consequence of neglect or carelessness by him or his subordinates.

21.1.3 The time stipulated in the CONTRACT for the execution and completion of the works is shall be deemed to be of utmost importance of the CONTRACT. In the event the CONTRACTOR fails to attain the PRELIMINARY ACCEPTANCE of PLANT within the CONTRACTUAL COMPLETION SCHEDULE due to the reasons not attributable to OWNER, then the CONTRACTOR shall pay to the OWNER as MAD at the rate of 0.5% of the TOTAL CONTRACT PRICE (excluding taxes) per week of delay or part thereof. The total deductions under this head shall not exceed 5% of the TOTAL CONTRACT PRICE (excluding taxes).

The OWNER may, without prejudice to any method of recovery, deduct the amount for such damages from any amount due or which may become due to the CONTRACTOR. In the event of extension of time being granted by the OWNER in writing for completion of the WORKS without levy of MAD (Mutually Agreed Damages), this clause will be applicable after expiry of such extended period. GST at the prevailing rate, if applicable on "MUTUALLY AGREED DAMAGES" shall be recovered extra from the CONTRACTOR on the amount of such MUTUALLY AGREED DAMAGES levied as per the Contractual terms.

OWNER shall raise separate Tax Invoice for recovery of MAD along with applicable GST.

	EMERGENCY DIESEL GENERATOR PACKAGE	PC183/E-4022/P-I/S-V	0	
	TALCHER FERTILIZERS LIMITED, ODISHA (INDIA)	DOC. NO.	REV	
	SPECIAL CONDITIONS OF CONTRACT	SHEET 44 OF 45		

Mutually Agreed Damages represent, without prejudice to the respect of the contractual obligation under the CONTRACT by CONTRACTOR, the sole and exclusive remedy of OWNER for such delay.

The decision of the OWNER on the applicability of MAD shall be final and binding on the CONTRACTOR.

22.0 **OVERALL CEILING ON TOTAL LIABILITY**

22.1 The Maximum Overall Liability under the CONTRACT on account of (a) Delay in execution of project (b) Contractor failing to meet the Guaranteed Works Cost up to 102.5 % (c) Termination of CONTRACT (d) Carrying out balance work at the risk and cost of the CONTRACTOR, re-engineering, make good, mechanical warranty (e) Patent infringement and (f) any other liabilities (if any) defined in the NIT shall be capped to 100% of the TOTAL CONTRACT PRICE.

22.2 Except for criminal negligence or wilful misconduct, the Contractor shall not be liable to the Owner, whether in contract, tort, or otherwise, or any indirect or consequential loss or damage, loss of use, loss of production, or loss of profit or interest cost, provided that this exclusion shall not apply to any obligation of the Contractor to pay liabilities to the Owner, as defined in clause 22.1 above.

23.0 **ASSIGNMENT OF CONTRACT- NOT APPLICABLE**



24.0 **“PLANNING AND DESIGNING IN PURVIEW OF VULNERABILITY ATLAS OF INDIA:**

Vulnerability Atlas of India (VAI) is a comprehensive document which provides existing hazard scenario for the entire country and presents the digitized State / UT-wise hazard, maps with respect to earthquakes, winds and floods for district-wise identification of vulnerable areas. It also includes additional digitized maps for thunderstorms, cyclones and landslides. The main purpose of this Atlas is its use for disaster preparedness and mitigation at policy planning and project formulation stage.

This atlas is one of its kind single point source for the various stakeholders including policy makers, administrators, municipal commissioners, urban managers, engineers, architects, planners, public etc. to ascertain proneness of any city/location/site to multi-hazard which includes earthquakes, wind, floods thunderstorms, cyclones and landslides. While project formulation, approvals and implementation of various urban housing, buildings and infrastructures schemes, this Atlas provides necessary information for risk analysis and hazard assessment.

The Vulnerability Atlas of India has been prepared by Building Materials and Technology Promotion Council under Ministry of Housing and Urban Affairs, Government of India and available at their website www.bmtpc.org.

It is mandatory for the bidders to refer Vulnerability Atlas of India for multi-hazard risk assessment and include the relevant hazard proneness specific to project location while planning and designing the project in terms of:

	<p align="center">EMERGENCY DIESEL GENERATOR PACKAGE</p> <p align="center">TALCHER FERTILIZERS LIMITED, ODISHA (INDIA)</p> <p align="center">SPECIAL CONDITIONS OF CONTRACT</p>	PC183/E-4022/P-I/S-V	0	
		DOC. NO.	REV	
		SHEET 45 OF 45		

- i) Seismic zone (II to V) for earthquakes,
- ii) Wind velocity (Basic Wind Velocity: 55, 50, 47, 44, 39 & 33 m/s)
- iii) Area liable to floods and Probable max, surge height
- iv) Thunderstorms history
- v) Number of cyclonic storms/severe cyclonic storms and max sustained wind specific to coastal region
- vi) Landslides incidences with Annual rainfall normal
- vii) District wise Probable Max. Precipitation.

25.0 STANDARD CONDITIONS OF SCC: PART I TO PART III

The Contractor has to fully comply with all applicable Labour Laws and Regulations passed, modified and notified from time to time by the Central, State and Local Government agencies/authorities. Brief guidelines and Annexures related to labour laws/Acts for Workmen/labour are enclosed as STANDARD CONDITIONS OF SCC: PART I to PART IV.

STANDARD CONDITIONS OF SCC: PART I

Compliances under various Labour Laws

The Contractor has to fully comply with all applicable Labour Laws and Regulations passed, modified and notified from time to time by the Central, State and Local Government agencies/authorities. Specific attention of the Contractor is drawn to the following obligations amongst others:

1. **The Minimum Wages Act, 1948, Payment of Wages Act, 1936 and Payment of Bonus Act 1965 or The Code on Wages, 2019 (after it comes into force)**

1.1. **Minimum Wages:**

- a. During the tenure of the contract, the Contractor must ensure the payment of minimum wages, as notified by the Central Government or State Government whichever is higher, as per the provisions of the Minimum Wages Act, 1948 / Code on Wages, 2019 (after it comes into force).
- b. **Wage period and monthly wages:** Wage period shall be monthly and wages for a month shall be calculated by multiplying daily rate of Minimum Wages by 26. The monthly wages include the wages of the weekly days of rest as applicable to the office/establishment of TFL. Deduction in case of any days of absence other than weekly days of rest shall be calculated using the following formula:

Deduction for absence = days of absence x (monthly wages / number of days in the relevant month)

However, in case the resource has worked for less than 7 working days in a particular month, the payment of wages is to be made as per the actual number of days worked based on notified wage rate per day.

Illustration I (05 days per week working pattern):

Sl. No.	Month	Nos. of days in the month	Nos. of weekly off	Nos. of days absence	Nos. of days present	Daily wage as notified	Monthly wage	Deduction	Wage to paid
1	Feb.	28	8	2	18	603	15678	1119.86	14558.14
2	March	31	10	5	16	603	15678	2528.71	13149.29
3	April	30	8	10	12	603	15678	5226	10452.00
4	May	31	10	-	4	603	2412	0	2412.00

Illustration II (06 days per week working pattern):

Sl. No.	Month	Nos. of days in the month	Nos. of weekly off	Nos. of days absence	Nos. of days present	Daily wage as notified	Monthly wage	Deduction	Wage to paid
1	Feb.	28	4	2	22	603	15678	1119.86	14558.14
2	March	31	5	5	21	603	15678	2528.71	13149.29
3	April	30	4	10	16	603	15678	5226	10452.00
4	May	31	5	-	4	603	2412	0	2412.00

1.2. Payment of Wages:

The Contractor shall disburse monthly wages **through e-banking / digital mode through cashless transaction only**, and avoid illegitimate deductions and maintain records /returns as prescribed. The Contractor shall be solely responsible for the payment of wages and other dues to the resources, if any, deployed by him latest by 7th day of the subsequent month as per the provisions of the Payment of Wages Act, 1936 / as applicable under Code on Wages, 2019 (after it comes into force) in the presence of Engineer In-charge (EIC) or authorized representative of TFL. After disbursement of wages, the representative of the Contractor and EIC/ authorised representative of TFL have to certify the payment of wages to the resources and sign the Wage Register - Form B (under The Ease of Compliance to Maintain Registers under various Labour Laws Rules, 2017) / FORM-I of Code on Wages, 2019 (after it comes into force) with specific seal detailing name/designation/Company.

1.3. Payment of Bonus:

Contractor shall ensure payment of bonus as per the provisions of the Payment of Bonus Act, 1965 / Code on Wages, 2019 (after it comes into force). Present minimum rate of payment of Bonus as per the Payment of Bonus Act, 1965 is 8.33% of minimum wages per month or 8.33% of Rs.7,000/- per month whichever is higher. The rate shall be subject to amendments made from time to time to the legislation.

Payment of Bonus / ex-gratia (if Bonus is not applicable) shall be made preferably before Deepawali festival falling after the end of relevant financial year(s) and the balance payment at the time of closure of contract.

The amount towards the payment of bonus/ex-gratia shall be released / reimbursed to the contractor, after submission of proof of payment.

2. Leaves/ Leave with wages/ Holiday:

The Contractor shall comply with all the applicable leave Rules including leave with wages in terms of applicable labour legislations i.e. Factories Act, 1948 / Shops & Establishment Act/ Industrial Establishment (national & festival holidays, casual & sick leave) Act, 1965.

The Contractor shall extend the leave with wages and maintain the Register of Leave pertaining to the resource deployed. The payment towards un-availed leave, as per the Factories Act, 1948

/ Shops & Establishment Act, shall be settled with the resource at the time of closure of the contract or separation of resource from the contract by the contractor.

- i. As per the **Factories Act, 1948 (if applicable)**:-Annual Leave with Wages @ 01 day for every 20 days of work performed by him in the previous calendar year becomes due.
- ii. As per the **Shops & Establishment Act (if applicable)** : Privilege Leave not less than 15 days and Sickness/Casual Leave not less than 12 days (this provision may vary from state to state).
- iii. As per the **Industrial Establishment (national & festival holidays, casual & sick leave) Act, 1965 (if applicable)**: (a) three national holidays of one whole day each on the 26th January, 15th August and 2nd October (b) five other holidays on any of the festivals specified in the - Schedule appended to this Act. (c) Every worker shall in each calendar year, be allowed by the employer 07 casual leave and 14 sick leave in such manner and on such conditions as may be prescribed (This provision may vary from state to state).

3. The Employees' Provident Fund & Miscellaneous Provisions Act 1952

- a) The Contractor shall have independent PF code no. with the RPFC as required under the Employees' PF & Misc. Provisions Act, 1952.
- b) The Contractor has to ensure compliance (as per prevailing rates) and extend benefits under the Employees' Provident Fund Scheme 1952, the Employees' Pension Scheme 1995 & the Employees' Deposit Linked Insurance Scheme, 1976 to the resources deployed by him.
- c) The Contractor is required to submit copies of *separate e-Challans / ECR alongwith proof of payment/receipt* in respect of resources engaged through this contract only, on monthly basis. **Common challans would not be acceptable in TFL.** The Contractor should submit copies of previous months EPF e-Challans / ECR alongwith current month's bill. The TRRN. No. of the ECR would be verified online from EPFO portal by the Engineer-in-charge to confirm the status of payment and names of the resources deployed.
- d) **PF is mandatory irrespective of the number of resources deployed** by the Contractor under this contract. **PF membership and deposit of PF contribution is also mandatory even if the wage payment to the resource is exceeding the prescribed monthly wage ceiling (i.e. Rs. 15,000/-) under the Employees' PF & Misc. Provisions Act, 1952 and in such case the liability of the Contractor towards PF contribution shall be limited to the prescribed monthly wage ceiling notified from time to time (i.e. Rs. 15,000/- currently).**
- e) In case, the Contractor deploys any "**International Worker**", the Contractor should also make compliance under para 83 of EPF Scheme, 1952 i.r.o the "International Workers" and must register on the ***International Worker Portal of EPFO.***

4. The Employees' State Insurance Act, 1948 (If applicable and as per prevailing rates)

- a) The Contractor shall have his own ESI code No. allotted by Employees' State Insurance Corporation (ESIC) as required under the Employees' State Insurance Act, 1948.
- b) The Contractor has to arrange **Smart Cards (i.e. ESI Identity Card) /e-Pehchan Card** for the resource(s) engaged by him from the Corporation.

5. The Employees' Compensation Act 1923 (wherever applicable)

In case, the work place is out of the notified coverage area under ESIC i.e. ESIC is not implemented in the area **or** in case of excluded employees under ESIC, the Contractor is required to take Employee Compensation / Workmen Compensation Policy from IRDAI approved Insurance Company taking into consideration the **maximum compensation liability** as per provisions of Employees' Compensation Act, 1923. It must be ensured that the contractor/contracting firm should extend coverage to the contract workers through Employee Compensation Policy, to meet the **Compensation Liability** under **Employee's Compensation Act, 1923** along with **Medi-claim Policy** within the overall premium @ 3.25 % of Minimum wages (i.e. employer contribution towards ESI).

6. Group Personal Accident Insurance Policy

The Contractor is required to take a Group Personal Accident Insurance Policy with coverage of **Rs. 3 Lakhs** per resource for the entire period of contract covering all resources deployed under the contract.

7. The Payment of Gratuity Act, 1972

In case of Death or permanent disablement of a resource during execution of work under the contract, the Contractor has to pay the Gratuity as per the provision under the Payment of Gratuity Act, 1972 to the nominee(s) of the resource as per the details maintained in the duly signed Nomination Form maintained by the Contractor. The proof of disbursement may be submitted to the EIC for claiming reimbursement of amount paid towards death Gratuity from TFL.

8. The Contract Labour (R&A) Act, 1970

- a) The Contractor is required to obtain Labour license under the provisions of the Contract Labour (R&A) Act, 1970 from the office of Licensing Officer, Central Labour Authority, Ministry of Labour and Employment, Govt. of India having jurisdiction of the Region.
- b) The Contractor shall discharge obligations as provided under the Contract Labour (R&A) Act, 1970 rules and regulations framed under the same and enforced from time to time.
- c) The Contractor shall ensure regular and effective supervision and control over the resources deployed for which a supervisor / representative of the Contractor should be available at all the times for giving suitable direction for undertaking the Contractual Obligations.
- d) The Contractor is solely responsible for payment of wages to each resource deployed by him and such wages shall be paid before the expiry of such period as may be prescribed.
- e) It shall be the duty of the Contractor to ensure the disbursement of wages to resource(s) through e-banking/digital mode. In case the resource does not have a bank account, the disbursement of wages may be made in cash in the presence of the Engineer-in-charge /

authorized representative of TFL initially and Contractor shall simultaneously arrange for opening the bank account of each contract labour deployed by him.

- f) In case, the Contractor fails to make payment of wages and deposit of PF contribution within the prescribed period or makes short payment of wages / short deposit of PF contribution, then TFL, as Principal Employer, will make payment of wages in full or the unpaid balance due, as the case may be, to the resource(s) deployed by the Contractor and deposit the PF contribution with PF authorities. Such amounts will be recovered from the Contractor either by deduction from any amount payable to the Contractor under any contract or as a debt payable by the Contractor.
9. The contractor is required to comply with all applicable labour laws and regulations including, but not limited to the following:
- a) The Factories Act, 1948 / The Shops & Establishment Act, 1948 (which ever applicable)
 - b) The Maternity Benefit Act, 1961
 - c) The Building and Other Construction Workers (Regulation of Employment and Conditions of Service) Act 1979 & Building and Other Construction Workers Welfare Cess Act, 1996
 - d) The Inter State Migrant Workmen (RECS) Act 1979 (if applicable)
 - e) Contract Labour (R&A) Act-1970
 - f) Employees' Provident Fund & Misc. Provisions Act- 1952
 - g) Employees' State Insurance Act-1948
 - h) Employees' Compensation Act, 1923
 - i) Payment of Gratuity Act, 1972
 - j) Minimum of Wages Act,1948
 - k) The Payment of Wages Act,1936
 - l) The Payment of Bonus Act,1965

STANDARD CONDITIONS OF SCC: PART II

Responsibilities of the Contractor

1. The Contractor shall be solely responsible and indemnify TFL against all charges, dues, claim etc. arising out of the disputes relating to the dues and employment of resources, if any, deployed by him.
2. The Contractor shall indemnify TFL against all losses or damages, if any, caused to it on account of acts of the resource(s) deployed by him.
3. The Contractor shall indemnify TFL from all claims, demands, actions, cost and charges etc. brought by any court, competent authority / statutory authorities against TFL.
4. The Contractor shall also indemnify TFL for any action brought against him for violation, non-compliance of any act, rules & regulation of center / state / local statutory authorities.
5. All resources deployed by the Contractor are deemed to be on the rolls of the Contractor.
6. **Age:** No resource below the age of **18 years** and above age of **58 years** shall be deployed by the contractor for the execution of the contract.
7. **Appointment/Nomination of supervisor:**
As a part of the contract, the Contractor is required to appoint/nominate a supervisor (s) who will supervise, control and give directions to the resource(s) for discharging the contractual obligations. Accordingly, the Contractor has to give in writing the name and contact details of the supervisor (s) to the EIC. A copy of the same is also to be sent to HR In-charge and Security In-charge for records.
8. A copy of the Letter of Acceptance (LOA) should be submitted to the Security Department by the Contractor / his representative or supervisor for facilitating the movement of resource(s) including machine & materials involved in the contract.
9. The resources to be deputed/ deployed by the Contractor shall observe all security, fire and safety rules of TFL while at the site/work. All existing and amended safety / fire rules of TFL are to be followed at the work site by the Contractor and his deployed resource(s).
10. **Personal Protective Equipment / Safety Kit and Liveries:** Contractor shall ensure adequate supply of personal protective equipment / Safety Kit and Liveries as mentioned in the Scope of Work to all such resources deployed.
11. In case of accident, injury or death caused to the resource(s) while executing the Work under the contract, the Contractor shall be solely responsible for payment of adequate compensation, insurance money etc. to the next kith & kin of injured / diseased. Contractor shall indemnify TFL from such liabilities.
12. The Contractor shall not deploy any resource suffering from any contagious or infectious disease. The Contractor shall get the deployed resource(s) examined from a civil Govt. Doctor / TFL's Doctor.

13. No resource(s) or representatives of Contractor (including Contractor) are allowed to consume alcoholic drinks or any narcotics within the premises of TFL (including Plant, Office and Residential etc.). If found under the influence of above, the Contractor shall immediately replace that resource(s) with intimation to the EIC.
14. While engaging / deploying the resources, the Contractor is required to make efforts to provide opportunity of employment to resources belonging to **Schedule Caste, Schedule Tribe and Other Backward Class** in order to have a fair representation of these sections of the society.
15. While engaging the resources, the Contractor is required to make efforts to provide an **opportunity to** candidates with experience of **apprentice training in TFL** under the provisions of the Apprentices Act, 1961.
16. The Contractor is required to maintain all Registers and other records in an **office** within the premises of TFL or at a place **within a radius of three kilometers**.
17. Contractor shall provide proper **Employment cards (FORM XII)** for the resource to be deployed by him, duly signed by the Contractor or authorized person on behalf of Contractor.
18. **Gate/ Entry Pass or Authorization:**
Entry to the premises of TFL is restricted and is subject to appropriate entry authorization in the prescribed format of a Gate Pass or any other entry authorization w.r.t police verification as per instruction of Security department from time to time. Similarly, entry for material/equipment's/ tools/ tackles etc. is restricted & subject to entry authorization by security department.
19. The Contractor shall issue **Identity cards** in his firm's name to the resource deployed.
20. Discipline of the resource(s) during discharge of duties must be regulated by the Contractor himself or by his representative.
21. **Police verification**
 - a) The Contractor (including his sub-Contractors/Petty Contractors etc, if allowed) will undertake police verification in respect of the resource(s) engaged by him in TFL's premises. Such verification will have to be carried out from concerned police station of their permanent place of residence/present place of residence.
 - b) Further, the Contractor is advised not to deploy any resource having past criminal record in the establishment/premises of TFL under this contract awarded to him.
 - c) In the event of violation of above clauses at (a) and (b), the Contractor will be solely responsible for the same.
 - d) If any such resource(s) having criminal record is deployed by the Contractor in the premises of TFL and has come to the notice of TFL at any point of time, the Contractor shall immediately replace that resource(s), failing which that particular resource(s) of the Contractor will not be allowed to enter into the premises of TFL.
22. While confirming to any of these conditions, the Contractor must ensure that all applicable Laws of State regarding labour, their welfare, conduct etc. are complied.

STANDARD CONDITIONS OF SCC: PART III

Compliance of Government of India Directives

1. Pradhan Mantri Suraksha Bima Yojna (PMSBY) and Pradhan Mantri Jeevan Jyoti Bima Yojna (PMJJBY)

Contractor shall, ensure that all its resources deployed under this contract have obtained additional insurance coverage under the Pradhan Mantri Suraksha Bima Yojana (PMSBY) and Pradhan Mantri Jeevan Jyoti Bima Yojana (PMJJBY) through the participating banks and submit the proof of such insurance coverage to the satisfaction of TFL. The cost has been included in the estimate mentioned in SOR and the Contractor shall submit evidence / proof to TFL in this respect. Both the schemes are to be regulated continuously on yearly basis and the same should be renewed on each successive relevant date in subsequent years during the period of the contract.

2. Labour Identification Number (i.e. LIN) Registration (Mandatory)

The Unified Shram Suvidha Portal, developed by Government of India, facilitates reporting of Inspections & submission of Returns and has also been envisaged as a single point of contact between employer, resources and enforcement agencies bringing in transparency in their day-to-day interactions. For integration of data among various enforcement Agencies, the Contractor, as an inspectable unit, is required to register and obtain Labour Identification Number (i.e. LIN) from Shram Suvidha Portal and submit the same in TFL.

3. Pradhan Mantri Rojgar Protsahan Yojna (PMRPY) – if applicable

In order to support the Govt. of India's Initiative on Employment Generation, the Contractor must register for Pradhan Mantri Rojgar Protsahan Yojna (PMRPY) Scheme. The Contractor shall inform TFL/Engineer in Charge about the benefit availed, if any, against the scheme for adjustment against the invoice(s) / bill(s).

Details in support of RA Bill for the Month of _____, 20__

- (1) Name of the Firm/Agency/Contractor _____
- (2) Nature of Contract: Job/ Service _____
- (3) Period of Contract: From _____ to _____
 - (a) Extension Period of Contract, if any from _____ to _____
 - (b) Place where contract workmen are working _____
- (4) Postal address of the Contractor: _____
- (5) Phone No. of the Contractor: _____
- (6) Fax No. and Email of the Contractor: _____
- (7) Name and Address of PF office from where EPF Code No. has been allotted: _____
- (8) EPF Code No. allotted by PF office: _____
- (9) Name and Address of ESIC office from where ESI Code No. has been allotted: _____
- (10) ESI Code No. allotted by ESIC office: _____
- (11) Labour License No. _____ dated _____
- (12) Validity period of Labour License from _____ to _____
- (13) Detail of Resource engaged by the Contractor:

Category	No. of Resources		Prevailing Minimum Wages
	Male	Female	
Unskilled			
Semi-skilled			
Skilled			
Highly skilled			
Total			

- (14) Copy of Wage Register in FORM – B (to be replaced by FORM-I as per Code on Wages-2019, after it comes into force)
- (15) Details of deposit of contribution towards EPF:
 - a) EPF Challan No. _____ Amount _____ Date _____
- (16) Details of Deposition of contribution towards ESI
 - a) ESI Challan No. _____ Amount _____ Date _____
- (17) Whether any arrangement / agreement has been entered with any resource for extending benefits under Inter-state Migrant Workmen (RE&CS) Act, 1979: ____ (Yes / No)
If Yes, No. of such Inter-state Migrant Workers: _____

SIGNATURE OF CONTRACTOR/AUTHORIZED REPRESENTATIVE

Place:
Date:

UNDERTAKING

(To be submitted along with un-priced bid)

I/We hereby undertake that I/We have completely understood the terms & conditions of the Tender including minimum resources required to be deployed and the cost involved thereof in deployment of resources.

I/We further undertake to ensure all compliances of the tender conditions. Any non-compliance may be construed as deficiency in the performance of the contract. If such non-compliance is noticed TFL/owner is at liberty to take action in line with the tender conditions including termination of the contract.

Signature of Bidder.....

Name of Bidder.....

Summary of Insurance Policies

Contractor is required to cover all resources deployed by him with the following insurances / schemes:

Sl. No.	SCHEME	APPLICABILITY	PREMIUM/ CONTRIBUTION	SUM ASSURED/ BENEFITS	REMARKS
1	The Employees' State Insurance Act, 1948	Applicable to all resources of the Contractor (within ESI wage limit) working in notified area.	3.25% of wages by employer 0.75% of wages by employees	Benefits under the Employees' State Insurance Act, 1948.	
2	The Employees' Compensation Act, 1923 (in lieu of ESI – mentioned at Sl. 1)	Applicable to excluded employees under ESI and those who are working in non-notified area to extend similar benefits as available under ESI Act, 1948	Premium to be calculated considering wage limit under EC Act, 1923 (i.e. Rs. 15,000/- p.m currently)	Maximum Compensation Liability under Employee's Compensation Act, 1923 along with a Mediclaim policy within overall premium @ 3.25 % of Minimum wages (i.e. employer contribution towards ESI)	Provides compensation and medical facility to resources.
3	Group personal Accident Insurance	Applicable to all resources of the Contractor	Based on the coverage	Insured value: Rs. 3 Lakh to cover expenses associated with any accident.	Death, permanent disablement, temporary total disability or any other medical expenses related to accident.
4	Pradhan Matri Suraksha Bima Yojana (PMSBY)	Eligibility – age group 18 to 70 years	Rs. 12/- per annum	Accidental death and permanent disability: (i) Permanent total disability – Rs. 2 lakhs. (ii) Permanent partial disability – Rs. 1 Lakh.	
5	Pradhan Mantri Jeevan Jyoti Bima Yojana (PMJJBY)	Eligibility – age group 18 to 50 years. (can continue upto 55 years)	Rs. 330/- per annum.	Risk coverage – Rs. 2 Lakhs- in case of death due to any reason	

 पी डी आई एल PDIL	PROJECTS & DEVELOPMENT INDIA LIMITED	PC183/E/4022/SecVI-1.0	0	 Talcher Fertilizers
		Document No.	Rev	
		Sheet 1 of 4		

SECTION: VI - 1.0

PROJECT DESCRIPTION

PLANT : EMERGENCY DIESEL GENERATORS PACKAGE

**PROJECT : INTEGRATED COAL BASED FERTILISER
COMPLEX, AT TALCHER, ANGUL DISTRICT,
ODISHA**



0	06.09.2023	06.09.2023	Issued for Tender	DKG	SKB	SKB
REV	REV DATE	EFF DATE	PURPOSE	PREPD	REVWD	APPD

CONTENTS

Section Number	Description	Sheet Number
1.0	Introduction	3
2.0	Plot Area	3
3.0	Emergency Diesel Generators Package	4

LIST OF ATTACHMENTS

Attachment Number	Description	Number of Sheets
Attachment-1	Plot Plan of Proposed Integrated Coal Based Fertilizer and Chemicals Complex (Drg. No: PC183-0000-0001)	1

	EMERGENCY DIESEL GENERATORS PACKAGE TALCHER FERTILIZERS LIMITED PROJECT DESCRIPTION	PC183/E/4022/SecVI-1.0	0	
		Document No.	Rev	
		Sheet 3 of 4		

1.0 INTRODUCTION

Talcher Fertilizers Ltd. (TFL), *hereinafter also referred to as “OWNER”* A joint venture company of four major Public Sector Units – M/s GAIL (India) Limited (GAIL), M/s Rashtriya Chemicals & Fertilisers Ltd. (RCF), M/s Coal India Ltd. (CIL) and M/s Fertilizers Corporation of India Ltd. (FCIL) has decided to build a world class coal based fertilizer complex at **Talcher, Angul District, Odisha (India)** consisting of Coal Gasification Plant, Ammonia and Urea Plant, along with other associated Offsite and Utility Plants. To cater the requirement of Emergency Electrical Power for the Coal Gasification Plant and OSBL Units of fertiliser complex, TFL intends to set up “3 Nos. 2000 KVA (Prime Power Rating) Diesel Generator Sets complete in all respects alongwith 11 kV Emergency Power Distribution Board” on single point responsibility basis. Accordingly, TFL intend to invite quotations from eligible contractors on Single Point Responsibility basis for setting-up Emergency Diesel Generators Package for Fertiliser Complex.

1.1 Projects & Development India Ltd. (PDIL) has been retained by **M/s TFL** as a Project Management Consultant for selection of a suitable Contractor for execution of the project on Single point responsibility basis.

1.2 CONTRACTOR is advised to visit and examine the site conditions and obtain the necessary information/ inputs on its own responsibility that may be necessary for preparing their bid and entering into the Contract. Claims of any kind due to variation or ignorance of site and environmental conditions will not be eligible and entertained by TFL under in any circumstances.

2.0 PLOT AREA



Emergency Diesel Generators Package shall be built in the earmarked area EDG as shown in the Plot Plan for Talcher Project (Refer: Attachment-1, Drawing No.PC183-0000-0001). CONTRACTOR should ensure that the available area should be used in the most optimum way.

2.1 Plant Site

A brief status of infrastructure at Talcher Fertiliser Plant Site is furnished below:

- The proposed project will be located within the existing premises of proposed Coal gasification based Fertilizer Complex, Talcher Fertilizer Limited at Talcher, Angul, Odisha.
- The total land area of the site is 933.60 acres and out of which lease hold land from Government of Odisha is 923.27 acres and land purchased from private parties is 10.33 acres.

The area is not falling under coal bearing zone up to a depth of 200-250 meter. FCIL had a full fledged fertilizer complex of Ammonia-Urea plants at this site which was in operation for over a period of 25 years and closed down since December 2002. The old abandoned plant machinery, building, facilities etc have been demolished and removed from site.

	EMERGENCY DIESEL GENERATORS PACKAGE TALCHER FERTILIZERS LIMITED PROJECT DESCRIPTION	PC183/E/4022/SecVI-1.0	0	
		Document No.	Rev	
		Sheet 4 of 4		

- Talcher site is located at Vikrampur in Angul district of Odisha on the Cuttack – Sambalpur National Highway NH-42. NH-42 is passing at about 8 km from the site. The nearest railway station is Talcher which is at about 7 km from the site. Nearest air port Bhubaneswar is about 150 km, about 3 hours journey by road/ rail. Nearest sea port is Paradip, 200 km by rail/road from the site. Talcher is situated at 21° 10" N Latitude and 82° 5" E LONGITUDE.

3.0 Emergency Diesel Generators Package

The Emergency Diesel Generators Package shall include 3 Nos. 11kV, 2000 KVA (Prime Power Rating), p.f. 0.8, Diesel Generator Sets (hereinafter referred to as DG Sets) along with AMF cum control panel, DG Breaker panel and all required accessories including AVM pads, Acoustic enclosure, NIS and NER panel, 11 kV Emergency Power Board etc. but not limited to, on single point responsibility basis.

The Contractor shall consider for installation of all the relevant facilities of appropriate capacity as necessary for smooth, safe and reliable operation of the Emergency Diesel Generators Package.

b. EOT Crane works

EOT shall be provided. For further details, refer Section-VI-3.1 and 3.2.1.

c. Temporary Construction Facilities

The Contractor shall arrange following facilities at his own cost for Construction/Erection purpose.

1. Tapping of Construction Power (on chargeable basis) from Owner's 415 V Feeder rated for 63 A (including supply & erection of all required materials like structural supports for cable tray, cable trays, power cables, control cables, protection & metering, cable termination etc. as well as underground cabling work) and further distribution shall be in Contractor's scope. This Owner's 415 V, 63 A feeder is located at Existing Substation near 132 KV Switchyard.
2. Construction Water on chargeable basis (at one point within factory premises and CONTRACTOR to arrange the pipeline up to their Battery Limit) shall be made available.
3. Construction sheds
4. Construction offices
5. Temporary Communication facilities
6. Office furniture
7. Temporary stores & security

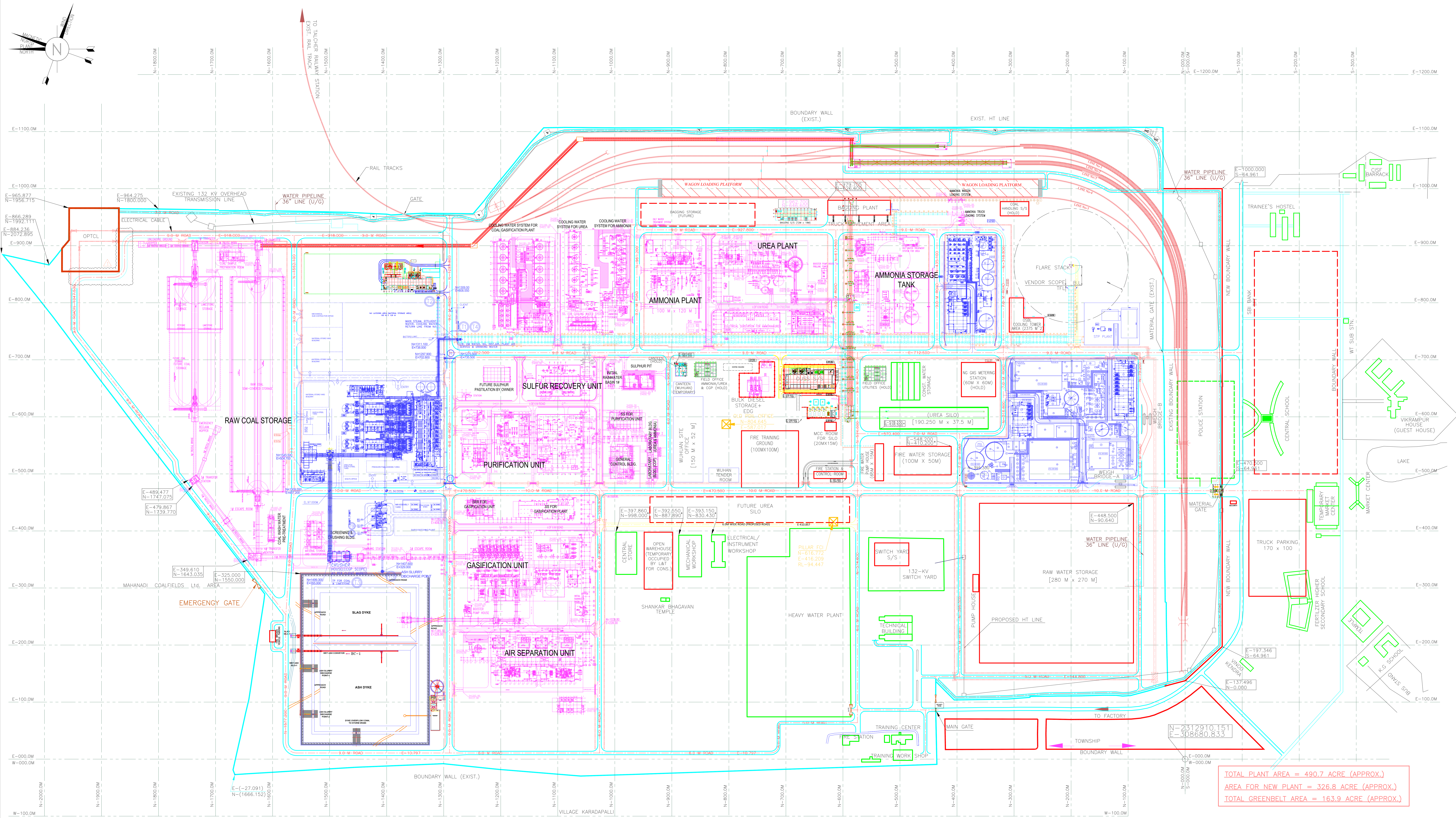

TOTAL PLANT AREA = 490.7 ACRE (APPROX.)
 AREA FOR NEW PLANT = 326.8 ACRE (APPROX.)
 TOTAL GREENBELT AREA = 163.9 ACRE (APPROX.)

TABLE-1 LSTX FACILITIES/UNITS OF CGP

SL.NO.	BLOCK DESCRIPTION	SIZE IN METRE	REMARKS
1.	AIR SEPARATION UNIT	210 M x 101 M	EXISTING
2.	GASIFICATION UNIT	200 M x 115 M	EXISTING
3.	PURIFICATION UNIT	213.7 M x 110 M	EXISTING
4.	SULFUR RECOVERY UNIT	78 M x 50 M	EXISTING
5.	COOLING TOWER FOR GASIFICATION PLANT	161.5 M x 98.0M	EXISTING
6.	INITIAL RAW WATER BASIN-1	38 M x 15 M	EXISTING
7.	INITIAL RAW WATER BASIN-2	23.5 M x 17.8 M	EXISTING
8.	COAL WASH WATER TREATMENT	46.5 M x 12.5 M	EXISTING
9.	SUBSTATION FOR GASIFICATION PLANT	96 M x 24 M	EXISTING
10.	SUBSTATION FOR COOLING TOWER	45 M x 20 M	EXISTING
11.	SUBSTATION FOR PURIFICATION UNIT	55 M x 28 M	EXISTING
12.	SUBSTATION FOR SOLID MATERIAL STORAGE & TRANSPORTING	56 M x 28 M	EXISTING
13.	SUBSTATION FOR ASU	49 M x 26.5 M	EXISTING
14.	GENERAL CONTROL ROOM	55 M x 36 M	EXISTING
15.	RAW COAL STORAGE	375 M x 95 M	EXISTING
16.	PETCOKE/LIMESTONE STORAGE	97 M x 90 M	EXISTING
17.	LABORATORY BUILDING	50.15 M x 21.35M	EXISTING

TABLE-2 LSTX FACILITIES/UNITS OF AMMONIA/UREA PLANT

SL.NO.	BLOCK DESCRIPTION	SIZE IN METRE	REMARKS
1.	AMMONIA UNIT	125 M x 100 M	EXISTING
2.	UREA UNIT	156 M x 93 M	EXISTING
3.	COOLING TOWER FOR AMMONIA PLANT	125 M x 52.5 M	EXISTING
4.	COOLING TOWER FOR UREA PLANT	140 M x 59 M	EXISTING
5.	COOLING TOWER FOR AMMONIA STORAGE	27 M x 22 M	EXISTING
6.	OLY WATER TREATMENT SYSTEM FOR AMMONIA PLANT	24 M x 16 M	EXISTING
7.	OLY WATER TREATMENT SYSTEM FOR UREA PLANT	29 M x 17 M	EXISTING
8.	SUBSTATION FOR AMMONIA & UREA	96.5 M x 33 M	EXISTING
9.	SUBSTATION FOR COOLING TOWER OF AMMONIA & UREA PLANT	38 M x 26 M	EXISTING
10.	SUBSTATION FOR AMMONIA STORAGE TANK	36 M x 25 M	EXISTING
11.	DESIGN GENERATOR ROOM	22 M x 15 M	EXISTING
12.	GENERAL CONTROL ROOM OF AMMONIA/UREA	54.5 M x 38 M	EXISTING
13.	AMMONIA STORAGE TANK	170 M x 100 M	EXISTING
14.	LABORATORY BUILDING	23 M x 20 M	EXISTING

TABLE-3 OSBL FACILITIES/UNITS

SL.NO.	BLOCK DESCRIPTION	SIZE IN METRE	REMARKS
1.	RAW WATER STORAGE	110 M x 24 M	EXISTING
2.	RAW WATER TREATMENT PLANT + ETP + STP	156 M x 93 M	EXISTING
3.	DM WATER PLANT	110 M x 24 M	EXISTING
4.	WATER BAGGING PLANT BUILDING	60 M x 30 M	EXISTING
5.	COAL COOLING TOWER	60 M x 30 M	EXISTING
6.	WAGON LOADING PLATFORM	660 M x 30 M	EXISTING
7.	STEAM GENERATION PLANT	240 M x 70 M	EXISTING
8.	ELECTRICAL DISTRIBUTION SYSTEM	60 M x 10 M	EXISTING
9.	INSTRUMENT AIR/PLANT AIR UNIT	60 M x 10 M	EXISTING
10.	FIRE WATER STORAGE	100 M x 50 M	EXISTING
11.	FIRE WATER PUMP HOUSE	60 M x 15 M	EXISTING
12.	BULK DIESEL STORAGE + EGG	60 M x 52 M	EXISTING
13.	FIRE STATION & CONTROL ROOM	60 M x 25 M	EXISTING
14.	FUTURE UREA SILO	300 M x 45 M	EXISTING
15.	FUTURE UREA SILO	190.250 M x 37.5 M	EXISTING
16.	FIELD OFFICE AMMONIA/AREA & CGP (HOLD)	35 M x 23 M	EXISTING
17.	FIELD OFFICE UTILITIES (HOLD)	35 M x 23 M	EXISTING
18.	TRUCK PARKING AREA	180 M x 100 M	EXISTING
19.	ASH/SLAG POND	300 M x 225 M	EXISTING
20.	CENTRAL STORE	90 M x 45 M	EXISTING
21.	MECHANICAL WORKSHOP	90 M x 45 M	EXISTING
22.	OPEN WAREHOUSE	100 M x 50 M	EXISTING

TABLE-4 OSBL SUBSTATION

SL.NO.	BLOCK DESCRIPTION	SIZE IN METRE	REMARKS
1.	SUB-STATION (DM WATER PLANT)	—	PACKAGE
2.	SUB-STATION (DM WATER TREATMENT PLANT + ETP)	—	PACKAGE
3.	SUB-STATION (BAGGING PLANT BUILDING)	100 M x 30 M	PACKAGE
4.	SUB-STATION (COAL HANDLING)	—	HOLD
5.	SUB-STATION (STEAM GENERATION PLANT)	—	PACKAGE
6.	SUB-STATION (ASH DYKE)	—	PACKAGE
7.	SUB-STATION (COOLING TOWER-MCC ROOM)	—	PACKAGE
8.	SUB-STATION (132-KV SWITCH YARD)	—	EXISTING
9.	SUB-STATION (WPS-EGS)	120 M x 40 M	PACKAGE
10.	SUB-STATION (ASH HANDLING)	—	HOLD
11.	SUB-STATION (EUIS)	90 M x 45 M	PACKAGE
12.	SUB-STATION (EGS-MCC ROOM)	20 M x 15 M	PACKAGE

- NOTES:-**
- ALL DIMENSIONS AND COORDINATES ARE IN METERS UNLESS OTHERWISE SPECIFIED.
 - REFERENCE BENCH MARK (⊕) POINTS IS W.R.T GLOBAL CO-ORDINATES HAVING N-2312910.151 & E-308680.833 (GRID COORDINATES N=000.0M, E=000.0M).
 - BLOCK SIZE OF FACILITIES ARE TO BE FINALIZED AFTER GETTING VENDOR INFO.
 - * INDICATES HOLD.

LEGEND :-

- PLANT BOUNDARY
- PROPOSED NEW FACILITIES (OSBL)
- PROPOSED NEW FACILITIES (ISBL)
- EXISTING FACILITIES TO BE USED AFTER REFURBISHMENT
- RAILWAY LINE
- PROPOSED ROAD
- PROPOSED GREEN BELT
- PIPE RACK

S.NO	REFERENCE DRAWINGS	NUMBERS
05.	TOPOGRAPHICAL & CONTOUR SURVEY DRAWING	SA/RCF/TALCHER/2017/TOPO-DWG
04.	MASTER PLAN OF MINING	FURNISHED BY CLIENT
03.	MASTER PLAN [FCI, TALCHER UNIT].	DRG. NO. 501
02.	INDEX PLAN [FCI, TALCHER UNIT].	DRG. NO. 635
01.	PLANTS LAYOUT [FCI, TALCHER UNIT].	TFU-M-GN-6341

REV.	DATE	DESCRIPTION	PPD.	CHK.	APPD.
3_OP	19.07.2023	UPDATED & ISSUED	ANIL	RKV/NSY	AMAR
2	09.12.2022	UPDATED & ISSUED	ANIL	RKV/NSY	AMAR
1	28.07.2022	ISSUED	ANIL	RKV/NSY	AMAR
0	15.02.2022	ISSUED FOR COMMENT	SAYED	RKV/NSY	AMAR
P	19.01.21	PRELIMINARY ISSUE	AM	DD/NS	AMAR

CLIENT : **M/s. TALCHER FERTILIZER LIMITED**

PROJECT : **INTEGRATED COAL BASED FERTILIZER AND CHEMICAL COMPLEX**

TITLE : **OVERALL PLOT PLAN**

PROJECTS & DEVELOPMENT INDIA LTD. NOIDA

SCALE : 1: 2200
 DRG. No.: PC183-0000-0001
 FILE : PC183-0000-0001_Rev 3.OP

REV. CKD. APPD. SHEET 1 OF 1

 पी डी आई एल PDIL	PROJECTS & DEVELOPMENT INDIA LIMITED	PC183/E/4022/SecVI-2.0	0	 Talcher Fertilizers
		Document No.	Rev	
		Sheet 1 of 8		

SECTION: VI - 2.0

BIDDER'S SCOPE OF WORK



PLANT : EMERGENCY DIESEL GENERATORS PACKAGE

**PROJECT : INTEGRATED COAL BASED FERTILISER
COMPLEX, AT TALCHER, ANGUL DISTRICT,
ODISHA**

REV	REV DATE	EFF DATE	PURPOSE	PREPD	REVWD	APPD
0	06.09.2023	06.09.2023	Issued for Tender	DKG	SKB	SKB

CONTENTS

Section Number	Description	Sheet Number
1.0	GENERAL	
1.1	BIDDER'S SCOPE OF WORK	
1.2	BROAD SCOPE OF WORK/ SERVICES	
2.0	OTHERS REQUIREMENT	
3.0	EXCLUSION	

	EMERGENCY DIESEL GENERATORS PACKAGE TALCHER FERTILIZERS LIMITED BIDDER'S SCOPE OF WORK	PC183/E/4022/SecVI-2.0	0	
		Document No.	Rev	
		Sheet 3 of 8		

1.0 GENERAL

CONTRACTOR shall supply & install 3 Nos. 2000 KVA (Prime Power Rating), 0.8 p.f., Diesel Generator Sets complete in all respects alongwith 11 kV Emergency Power Board on single point responsibility basis at proposed Coal Gasification based Fertilizer complex, Talcher Fertilizers Ltd. (TFL) at Talcher, Angul District, Odisha (India) as per the requirements and specifications.



1.1 BIDDER'S SCOPE OF WORK

Scope of work of the Contractor shall include Detailed Engineering, Procurement, Supply, Fabrication, Testing at works, Inspection by Third Party Inspection Agency (TPI), Expediting, Insurance, Transportation of all equipment / materials to work Site, Storage & Materials Management, mechanical works, electrical works, Assembly and Installation of Equipments, obtaining all necessary statutory approvals, Testing, Commissioning including Total Project Management and handing over of Contractor's scope of work duly completed on single point responsibility basis.

1.2 BROAD SCOPE OF SUPPLY/ WORK/ SERVICES

Bidder's scope of work shall include (but not limited to) following in respect of all equipment, works, systems, facilities & services as required for completeness, satisfactory, easy, safe and reliable operation of '3 Nos. 2000 KVA (Prime Power Rating), 0.8 p.f, Diesel Generator Sets alongwith all necessary auxiliaries and accessories complete in all respects alongwith 11 kV Emergency Power Board' on single-point responsibility basis:

- a) Diesel engine, complete with all the required accessories and components.
- b) Generator set, for operation with the above diesel engine, complete with all the required accessories and components i.e . with terminal arrangement for external cable connections, brushless exciter, automatic voltage regulator, CTs, alarm initiating devices, indicating instruments and other accessories as required
- c) Drive coupling between diesel engine and generator set complete with guard.
- d) Engine flywheel, if required, with starter ring and guard.
- e) Fuel oil system complete with fuel oil day tank, engine driven fuel oil feed pump, supply pump, necessary piping & fittings, duplex strainers, valves, filters, instruments, and control as required between day tank and engine.
- f) Air intake system complete with air blower, air filter, silencer (if required), turbo charger, pipes, fittings supports and other necessary accessories as required.
- g) Lubricating oil system complete with lube oil sump, engine driven lube oil pump, . One AC motor driven pre-lube oil pump, standby pre-lub oil pump (if the pre lube oil pump is required to be operated continuously), lube oil cooler, lube oil pre-heater, necessary piping, fittings, valves, filters, instruments and control hardware as required. One portable pump for transferring lube oil form drum/barrel to diesel engine lube oil sump.
- h) Jacket water system complete with engine driven pump, water circulation pump, Radiator to cool jacket water, jacket water heater; if required, expansion tank, mixing tank and replenishment pump, necessary piping, fittings, valves, strainers, instruments, and control hardware as required, valves and fittings inside DG room including isolating valves.
- i) Starting system complete with battery, battery charger, starter motor, control system etc. to accelerating the engine within 20 seconds
- j) All Piping, fittings and valves, SS braided metallic flexible joints etc. /, to connect the engine to all auxiliary equipment/systems.
- k) Torsional vibration damper at the free end of the crank shaft.

	EMERGENCY DIESEL GENERATORS PACKAGE TALCHER FERTILIZERS LIMITED BIDDER'S SCOPE OF WORK	PC183/E/4022/SecVI-2.0	0	
		Document No.	Rev	
		Sheet 4 of 8		

- l) Speed regulation system.
- m) An acoustic enclosure for DG Set with an "Emergency-off" Push Button provided on the enclosure for control of noise. The acoustic enclosure shall give minimum 25-dB (A) insertion loss.
- n) Platforms, walkways, stairs and handrails etc. , as required to provide adequate access and workspace (if required).
- o) Base frame suitable for assembly of engine, radiator and alternator with their accessories. Anti vibration mounting and foundation bolts shall also be supplied. Base frame shall be designed for transportation of above items duly assembled on it.
- p) Engine exhaust gas system complete with turbocharger, exhaust manifold, silencer, exhaust piping up to discharge, insulation, asbestos lagging, expansion bellows, necessary pipe supports, adopters etc. as required. The exhaust muffler shall provide insertion loss of 25 dB (A). Exhaust chimney as per the requirements of State Pollution Control Board for each DG Set.
- q) All necessary instruments for monitoring and safe starting, running and stopping of the D.G. set their auxiliaries complete with tubing and cabling.
- r) PLC based AMF cum Control panel with each unit, relays, instruments, annunciations and other accessories as required in completely wired and ready to install conditions. Control cabling from instruments terminal block (TB) to DG set junction box (JB) and between DG junction box to L.C.P. . The cabling (including cable trays) from field to control panel shall. Field routing of the control cable shall be done through GI conduit of 16SWG thickness along-with DG breaker panel.
- s) 11 kV Emergency Power Distribution Board
- t) Governing system controls as required for safe and proper operation of DG set.
- u) NIS/ NER panel.
- v) All electrical equipments shall be provided with required number of cable glands, lugs and other accessories for connection of cables.
- w) One separate stand alone PMCC panel to supply power to the auxiliaries of the proposed DG sets for which power can be extended from the DG source after loading of the DGs.
The auxiliaries which are required to operate during DGs standby condition, shall be fed from another MCC panel, for which 415 V supply will be extended from PMCC of OUSS.
Cables between generator neutral to neutral grounding resistors with suitable gland sealing
Power/Control cable from DGs to 11 kV Emergency Power Distribution Board .
Power Cables from PMCC at OUSS to Contractor 415 V PMCC/MCC and Power/Control Cables from Contractor PMCC/MCC to all DGs auxiliaries.
- x) Required structural steel channel sections, properly drilled for mounting various equipments along with necessary mounting hardware.
- y) All safety and protective devices
- z) Self standing data logger to record and monitor all critical operating and control parameters for diagnosis with sufficient number of channels (having 10 spare channels for future use) shall be provided. The number of channel shall be decided mutually at the time of drawing approval. However it should include all critical parameters to be monitored and recorded with fault recording facility for 1 sec pre fault and 3sec post fault time having

	EMERGENCY DIESEL GENERATORS PACKAGE TALCHER FERTILIZERS LIMITED BIDDER'S SCOPE OF WORK	PC183/E/4022/SecVI-2.0	0	
		Document No.	Rev	
		Sheet 5 of 8		

discrimination of 50 milli seconds. The hard ware and software shall be such that it record minimum 500 such events and shall over write subsequently on FIFO basis.



- aa) Supply, installation, testing & commissioning is in the scope of work.
- bb) All other items not specified here but, necessary for safe, satisfactory and uninterrupted operation of DG Set.
- 1.3 The above mentioned systems are only indicative in nature. The complete supply shall include DGs and all the auxiliaries required for successful continuous operation of the set. The final list of materials shall be based upon the approved scheme/drawing.
- 1.4 Paint and painting of the equipment/structures.
- 1.5 All start-up spares as required and all essential spares as specified.
- 1.6 Thermal insulation as required for complete scope of work included in this contract.
- 1.7 Supply of counter flanges and blanking plates with gaskets, nuts and bolts at all flanged terminal points.
- 1.8 Whether called for specifically or not, all accessories required for normal operation of equipment are deemed to be considered as a part of Bidder's scope.
- 1.9 All EOT Crane works within Battery Limit.
- 1.10 Dismantling of temporary construction facilities and cleaning the site by removal & disposal of debris etc. after project completion.
- 1.11 Contractor shall design the Emergency Diesel Generator Package to accommodate within the available area marked in plot plan.
- 1.12 All mandatory approval including liaisoning from various authorities like Electrical Inspectorate, Central Electricity Authority, State Pollution Control Board, Central Pollution Control Board etc. pertaining to execution of Emergency Diesel Generator Package.
- 1.13 **The followings shall also be under the scope of the Contractor for Emergency Diesel Generators Package :**
- a. Detailed engineering
 - b. Compliance of all statutory requirements during complete project execution period.
 - c. Preparation of drawings and Documents with necessary software and hardware including submission of as built drawings.
 - d. Getting the drawings approved by Owner/PMC, making prints available well before those are actually required by manufacturer, inspector, erector, constructor, site engineer
 - e. Procurement and/ or Manufacture and/ or Fabrication,
 - f. Quality assurance & Quality Control
 - g. Inspection, Testing, checking, Expediting at Manufacturer's works including inspection by Owner/ Consultant/ Third party/ Statutory Authorities.
 - h. Supply, Packing, loading, un-loading, Transportation of all equipment & material to site including customs clearance and port charges, port handling & handling at work site.
 - i. Storage, preservation and conservation at site as per manufacturer's recommendation until erection,
 - j. Security, Watch & ward till handing over
 - k. Insurance during transit, storage, erection and commissioning

	EMERGENCY DIESEL GENERATORS PACKAGE TALCHER FERTILIZERS LIMITED BIDDER'S SCOPE OF WORK	PC183/E/4022/SecVI-2.0	0	
		Document No.	Rev	
		Sheet 6 of 8		

- l. Erection of all structural, mechanical and electrical items/ works, assembly, installation including loading of materials at contractors warehouse, transportation of materials to contractor's works/erection site.
- m. Testing/ checking at site by Owner/ Consultant/ Statutory Authorities and obtaining all necessary statutory approvals from concerned government authorities as applicable.
- n. Supply of spares shall be as per Section-VI-8.0 of NIT.
- o. Supply of all equipment, machinery, tools etc required for proper & safe erection/ construction work.
- p. Supply of all special tools & tackles for erection and maintenance tools and tackles as specified
- q. Training of Owner's personnel.
- r. Handing over of 'Emergency Diesel Generators Package' ' with all final/ 'As-built drawings/ documents' and operating manual, drawings, documents & operating manual of bought out items, Test certificates, statutory approvals etc.
- s. Preparation of Network and schedules in latest version of Primavera. Project Planning, Scheduling & monitoring, progress Monitoring and Reporting, Total project management.
- t. Co-ordination with all agencies concerned with implementation of the project.
- u. Safety and Security.
- v. Bidder shall note that any work and/ or services mentioned in other sections of tender document and not mentioned in this section or mentioned in this section and not mentioned in other sections shall be considered as if mentioned in both.
- w. All supervision personnel, skilled/ unskilled labour for completing the job in all respect as per provision of the contract.

2.0 OTHER REQUIREMENTS

- 2.1 Tie-up/ hook-up with designated tie-up points for hooking up to other systems like Pipe Rack/Structure for Cable Trays etc. executed by other agencies. Perform construction management and supervision of all equipments, material and works.
- 2.2 Provide and perform comprehensive quality assurance, quality control and inspection of all equipments, materials works - both in manufacturing shop and at work site.
- 2.3 Provide all manpower, materials, consumables, construction equipment / machines, tools, instruments, storage, fabrication, facility and all other services and inputs etc. necessary to perform the work and complete the plant.
- 2.4 Comply with all Central, State & Local Govt. regulations, laws and requirements applicable to the work and seek & obtain approvals/ clearances from such statutory bodies/ agencies, as required. Scope of Talcher Fertilizers Limited in this regard will be only to provide authorization in favour of CONTRACTOR for which all the necessary paper work will be done by CONTRACTOR.
- 2.5 Provide necessary temporary construction facilities like fabrication, storage, illumination etc. and removal of temporary arrangement to make the space reusable.
- 2.6 Comply with all safety practices for and during work as per applicable standards.
- 2.7 Strictly comply with applicable codes and standards of Engineering, Fabrication, Inspection, Construction etc.
- 2.8 Arrange services of Manufacturer's installation/ commissioning Engineer(s) at Site during Pre-



	EMERGENCY DIESEL GENERATORS PACKAGE TALCHER FERTILIZERS LIMITED BIDDER'S SCOPE OF WORK	PC183/E/4022/SecVI-2.0	0	
		Document No.	Rev	
		Sheet 7 of 8		

commissioning, Commissioning, of the entire major equipment and systems.

- 2.9 Provide all the temporary connections/ supplies required for testing/ pre-commissioning activities.
- 2.10 Provide spare parts including all consumables for commissioning. All such spares are to be available at site prior to commissioning.
- 2.11 Perform testing, commissioning and functional & operational check of entire system.
- 2.12 Submission of final drawings and documents shall be as per Section No VI-7.0 (Drawings and Documents).
- 2.13 Project Management and planning, scheduling and monitoring/ comprehensive reporting services, periodic reviews, meeting notes with Talcher Fertilizers Limited / PMC.
- 2.14 The scope of work as described above shall be supplementary to the scope of work mentioned under various parts of Tender Document. In case of any contradiction between the two, the stipulations mentioned under various disciplines shall be governing. In this regard, Owner's interpretation shall be final and binding to CONTRACTOR.
- 2.15 Transportation of all the materials supplied by Owner , if any, from TFL's store to CONTRACTOR's Store/ work site including loading/ unloading.
- 2.16 Total painting including special paints, color coding, CS / S.S. name plates etc. as per applicable standards.
- 2.17 **All items, equipment, works though not specifically mentioned, but required for completeness of Emergency Diesel Generators Package shall be undertaken by the Contractor without any additional cost and time implication to the Owner.**
- 2.18 CONTRACTOR shall adhere to Design Control exactly as per provisions of latest ISO 9001. CONTRACTOR shall submit required records as evidence for review by Owner/ PMC as and when required, and shall carry out changes based on Owner/ PMC review.
- 2.19 Supervisory assistance from OEM of major equipment for two weeks, after commissioning, during functional & operational check.
- 2.20 Contractor shall arrange requisite manpower for erection, testing & commissioning.
- 2.21 List of equipment & apparatus shall be furnished along with BID by contractor required for erection, testing during the commissioning & subsequent Operation.
- 2.22 During erection contractor shall ensure that construction of other contractor should not hamper.

3.0 Exclusion

- 3.1 All civil Foundation Work, DGs Building / Shed are excluded from scope of the Bidder. However, any structure required for erection shall be in scope of Bidder.
 - a) All civil works such as provision of foundations, plate inserts, wall and floor cut outs, cable trenches as per the drawing to be supplied by the Bidder.
 - b) Cabling between control panel and owner's switch board including their terminations.
- 3.2 First Fill of Diesel
- 3.3 However, to enable the other Bidder/contractor to carry out the above jobs, the Bidder shall supply the following details within 6 weeks from the date of LOI.
 - a) Civil data complete with all the required information for doing the foundation design by purchaser.
 - b) Cable schedule, GA & layout drawings of stacks.

	EMERGENCY DIESEL GENERATORS PACKAGE TALCHER FERTILIZERS LIMITED BIDDER'S SCOPE OF WORK	PC183/E/4022/SecVI-2.0	0	
		Document No.	Rev	
		Sheet 8 of 8		

- c) Auxiliary power requirement.
 - d) Fuel oil and make-up cooling water requirement.
- 3.4 In case the drawings and data for civil works are modified by the Bidder after the execution of the civil works, the same shall have to be carried out by the Bidder in consultation with owner / consultant free of cost.

 पी डी आई एल PDIL	PROJECTS & DEVELOPMENT INDIA LIMITED	PC183/E/4022/SecVI-3.1	0	 Talcher Fertilizers
		Document No.	Rev	
		Sheet 1 of 68		

SECTION: VI - 3.1

DESIGN PHILOSOPHY - ELECTRICAL

PLANT : EMERGENCY DIESEL GENERATORS PACKAGE

**PROJECT : INTEGRATED COAL BASED FERTILISER
COMPLEX, AT TALCHER, ANGUL DISTRICT,
ODISHA (INDIA)**

0	06.09.2023	06.09.2023	Issued for Tender	DKG	SKB	SKB
REV	REV DATE	EFF DATE	PURPOSE	PREPD	REVWD	APPD

	EMERGENCY DIESEL GENERATORS PACKAGE TALCHER FERTILIZERS LIMITED TECHNICAL SPECIFICATION – ELECTRICAL	PC183/E/4022/SecVI-3.1	0	
		Document No.	Rev	
		Sheet 2 of 68		

CONTENTS

SECTION NUMBER	DESCRIPTION
1.0	Scope
2.0	Basis of Design
3.0	Area Classification
4.0	System Details and Utilization Voltages
5.0	Power Supply and Distribution
6.0	Panel Room
7.0	Protection & Metering
8.0	Control and Monitoring
9.0	Equipment Specification
10.0	Cabling
11.0	Illumination System
12.0	Earthing and Lightning Protection
13.0	Structure
14.0	Spares
15.0	Vendor's Services
16.0	Testing & Inspection
17.0	Documentation
18.0	Tools & Tackles
19.0	Review of Drawings & Documents by Owner/ Consultant
20.0	Training
21.0	Vendor List
22.0	Installation, Testing and Commissioning
23.0	Testing of Installation after Erection
24.0	Quality Assurance
25.0	Coordination with Other Contractors

	EMERGENCY DIESEL GENERATORS PACKAGE TALCHER FERTILIZERS LIMITED TECHNICAL SPECIFICATION – ELECTRICAL	PC183/E/4022/SecVI-3.1	0	
		Document No.	Rev	
		Sheet 3 of 68		

LIST OF ATTACHMENTS

Technical Specification No.	Description
PC183-TS-0802	Uninterrupted Power Supply System
PC183-TS-0804	Neutral Earthing Resistor
PC183-TS-0804	Neutral Earthing Resistor
PC183-TS-0805	Medium Voltage Switch Boards
PC183-TS-0806	High Voltage Switch Boards
PC183-TS-0807	Bus Duct
PC183-TS-0808	Sheet Steel Distribution Boards
PC183-TS-0809	Lighting Sub Distribution Boards
PC183-TS-0810	Induction Motors
PC183-TS-0811	Interlocking Sw. Socket and Plug
PC183-TS-0813	Battery Charger
PC183-TS-0814	Battery
PC183-TS-0815	Cables
PC183-TS-0816	Prefabricated Ladder Type Cable Racks
PC183-TS-0817	Local Control Stations
PC183-TS-0818	Junction Box
PC183-TS-0819	Electricals for Over Head Cranes and Hoists
PC183-TS-0839	DG Set
--	Conceptual SLD - 11 kV Emergency Power Distribution Board (Drg. No. PC183-1251)
--	Conceptual SLD - 415V Switchboard (Drg. No. PC183-1233)

	EMERGENCY DIESEL GENERATORS PACKAGE TALCHER FERTILIZERS LIMITED TECHNICAL SPECIFICATION – ELECTRICAL	PC183/E/4022/SecVI-3.1	0	
		Document No.	Rev	
		Sheet 4 of 68		

<u>Electrical Sketches</u>	<u>Description</u>
PC183-PDS:E 119	Typical Foundation Arrangement for Panels in Sub-Station
PC183-PDS:E 120	Typical Foundation Details for HT/LT Circuit Breaker Panels
PC183-PDS:E 207	Details of Bracket Arm for Street Lighting Pole
PC183-PDS:E 208	Installation Arrangement Area Lighting Fixtures
PC183-PDS:E 210	Junction Box for Street Lighting Pole
PC183-PDS:E 213	Typical Street Lighting Pole
PC183-PDS:E 464	Schematic Diagram Panic Light
PC183-PDS:E 510	Details of Concrete Cable Trench
PC183-PDS:E 511	Cable Rack Arrangement in Trenches
PC183-PDS:E 516	Typical Arrangement of Cables buried in slit
PC183-PDS:E 530	Pre-Fabricated Cable Tray Straight Run
PC183-PDS:E 531	Pre-Fabricated Cable Tray Horizontal Tee
PC183-PDS:E 532	Pre-Fabricated Cable Tray Horizontal Cross
PC183-PDS:E 533	Pre-Fabricated Cable Tray 90° Horizontal Bends
PC183-PDS:E 534	Pre-Fabricated Cable Tray 90° Vertical Bend Bending Rad. 1000 mm
PC183-PDS:E 535	Pre-Fabricated Cable Tray 90° Vertical Bend Bending Radius 600 mm
PC183-PDS:E 536	Pre-Fabricated Cable Tray Coupling Arrangement
PC183-PDS:E 537	Pre-Fabricated Cable Tray Fixing Arrangement
PC183-PDS:E 538	Pre-Fabricated Cable Tray Reducing Coupler Plate
PC183-PDS:E 601	General Notes on Earthing and Lightning Protection
PC183-PDS:E 602	Earthing Conductor Details
PC183-PDS:E 603	Arrangement of Connections of Earth Conductors
PC183-PDS:E 604	Typical Details of Connection in Earth Pit
PC183-PDS:E 605	Earth Pit Details
PC183-PDS:E 606	Typical Arrangement of Earthing for Motor and Start Stop Push Button
PC183-PDS:E 611	GI/AI Accessories for Earth Electrode
PC183-PDS:E 613	Earthing of storage tank & vessel
PC183-PDS:E 615	GI Earth Bus
PC183-PDS:E 617	Typical Arrangement for Neutral and Equipment Earthing

	EMERGENCY DIESEL GENERATORS PACKAGE TALCHER FERTILIZERS LIMITED TECHNICAL SPECIFICATION – ELECTRICAL	PC183/E/4022/SecVI-3.1	0	
		Document No.	Rev	
		Sheet 5 of 68		

1.0 SCOPE

1.1 The scope includes work/service for the complete design, engineering, manufacture, testing at works, Third Party Inspection, supply, dispatch, storage, handling, erection, testing at site and commissioning of Diesel Engine Generator (DG) Sets (3 Nos. 2000 KVA Prime Power Rating , 11kV, 0.8 pf, 3 phase, 50 Hz, net output at site condition (50 Degree C) at generator terminal excluding its auxiliary equipment, including all accessories and Emergency Power Distribution Board) for 'Emergency Diesel Generator Package' .

Although every item of supply and/ or installation might not have been described, the Contractor shall supply anything and everything to complete the project.

1.2 This specification shall be read in conjunction with all drawing and documents attached and other relevant reference as specified therein.

1.3 The DGs shall be installed in area available for DGs including its auxiliary shall be including drop off, maintenance & access area. Bidder to confirm the same. Bidder to develop layout for EDG Package indicating location of all auxiliaries / Panels, etc. All electrical and Instrument Panels except skid mounted should be installed in Room, adjacent to DGs.

The DGs including its auxiliary shall be installed indoor in area available (marked as EDG) in Plot Plan including drop off, maintenance & access area.

1.4 Bidder shall provide separate Exhaust Stack for each DG set with common supporting structure for all three DG stack. Bidder shall indicate height of Exhaust Stack as per statutory regulations in their offer. Stack height shall be maximum of the following, in meters as per statutory regulation:

(i) $14 * Q^n$

Where, $n = 0.3$, Q =Total SO₂ emission from the plant in kg/hr.

(ii) Minimum 6m.above the building where generator set is installed.

(iii) Minimum Stack Height 30m.

1.5 Bidder shall provide Sampling port of adequate size & at height as defined by CPCB / State Pollution Control Board, ODISHA. Stack shall be designed to meet 2D / 8D requirement as per CPCB norms.

1.6 The work platform should serve the entire circumference of the stack. The minimum platform width shall be always 1.2 meters regardless of diameter of stack with step type ladder to approach up to the sampling port and no. of sampling ports as per CPCB requirement.

1.7 Bidder to liaise with statutory authorities for obtaining all necessary approvals. Bidder to clearly mention list of approvals required in their offer.

1.8 Fuel to be used for engine shall be High Speed Diesel.

1.9 Design wind velocity for structures shall be 180 Km/hr.

1.10 To control the engine speed, speed governor is provided and engine rpm display is available then tachometer for engine speed is not mandatory.

1.11 Engine speed shall be provided as per the OEM Standard

1.2.1 Design & detailed engineering, Coordination, General Services etc

a. Detailed engineering.

b. Generator sizing calculation shall be submitted for Continuous rating at Ambient temperature 50 Degree Celsius.

c. DG set shall be suitable for starting of the applicable largest emergency motor

i.e. DOL starting of the largest rated motor of 200 kW with starting current limited to 550% without any additional tolerance. Suitable base load shall be considered.

	EMERGENCY DIESEL GENERATORS PACKAGE TALCHER FERTILIZERS LIMITED TECHNICAL SPECIFICATION – ELECTRICAL	PC183/E/4022/SecVI-3.1	0	
		Document No.	Rev	
		Sheet 6 of 68		

- a. Sizing of equipment like Switchgear, CT, PT Cable etc. are in bidders scope.
- b. Preparation of drawings/ document/ to suit Project implementation schedule. Preparation of drawings/ documents/ calculations/ formats/ test reports/ test certificates; Erection, Testing & Commission Manuals/ Operations & maintenance Manuals/ Reports/ QAP etc for approval/ Review/ reference/ record and/ or for any other requirement; submission to Owner/ Consultant in requisite sets, getting approval from Owner/ Consultant, making approved copies available to manufacturers, inspectors, erection & commissioning engineers, supervisors, owner/ Consultant etc as required in requisite sets well before those are actually required by them to fulfil their obligations.
- c. Design, manufacture, testing of equipment/ cables/ cable trays/ earthing and other erection materials etc at manufacturer's works, submission of documents with manufacturer's test reports/ type test reports to Owner/ Consultant prior to inspection call.
- d. Quality Assurance at each stage of manufacture including procurement of raw materials/ bought out items and arranging inspections by Owner/ Consultant/ third party.
- e. Obtaining dispatch clearance from Owner in writing.
- f. Packing, loading, forwarding, delivery at site/ store, loading/ unloading, storage as per manufacturer's recommendation; shifting from stores and handling in store as well as at site for erection.
- g. Arrangement of testing/ checking instruments/ kits/ sets/ apparatus with valid calibration certificates issued by duly accredited laboratories/ institutions, to carry out tests stipulated in specification and documents referred therein/ other applicable standards.
- h. Deputing electrical contractors, supervisors' electricians, cable jointers etc. on full time basis for carrying out electrical work.
- i. Installations of equipment/ cables/ materials.
- j. Conducting pre-energisation tests to ensure that installation is fit to be energized.
- k. Erection shall not be considered complete unless pre-energisation tests are carried out, results are tabulated & submitted to owner/ consultant and results are found satisfactory.
- l. Conducting functional/ pre-commissioning checks/ Cold trial runs; no-load & load tests,
- m. Commissioning the installation.
- n. Conducting Performance Guarantee tests and taking corrective steps (inclusive of replacement of equipment/ materials if required) till results are satisfactory/ acceptable.
- o. Conducting Pre-Acceptance Tests/ checks and tabulating the results/ observations
- p. Liquidations of defects/ discrepancies/ observations noted during erection, pre-energisation tests, commissioning, trial runs, performance guarantee tests, Pre-acceptance tests/ checks etc.
- q. Submissions of all final/ 'As built' drawings/ documents after incorporation of changes made in soft as well as hard copies, duly certified by Contractor to the effect that those are 'Final' and/ or 'As built'
- r. Conducting Final Acceptance Tests/ Checks
- s. Co-ordinate with the Owner/ Consultant, other contractors/ agencies working at site as required for proper, smooth and timely execution of work/ implementation of the project
- t. Preparation of drawings/ documents, applications for getting the installation inspected and approved by Electrical Inspectorate of state and/ or Central Electricity Authority and all coordination for getting the installation approved for energisation & use. Carrying out all modifications/ alterations required by statutory authorities. All expenses on these activities shall be carried out and borne by Contractor. The obligation of owner shall be limited to

	EMERGENCY DIESEL GENERATORS PACKAGE TALCHER FERTILIZERS LIMITED TECHNICAL SPECIFICATION – ELECTRICAL	PC183/E/4022/SecVI-3.1	0	
		Document No.	Rev	
		Sheet 7 of 68		

- Signing of application as owner of installation and
- Payment of fee for inspection of installation.

Approved drawings and certificates shall be submitted to the Owner/Consultants well ahead of schedule so that the actual commissioning of equipment does not get delayed for want of inspection and approval by the Electrical Inspectorate and other statutory bodies. The actual inspection work by the Electrical Inspector shall be arranged by the Contractor and necessary coordination and liaison work in this regard shall be the responsibility of the Contractor.

1.2.2 Manufacture, testing at works, getting inspected by owner and/ or their consultant/ third party, packing, transportation and delivery to site in well packed condition, insurance during transit and till commissioning & handing over, storing at site as per recommendation of manufacturer/ supplier/ direction of supervising engineer of Owner/ Consultant until required for erection, transportation to work place. Erection, testing & commissioning, handing over of complete electrical system of 'DIESEL ENGINE GENERATOR WITH ITS ACCESSORIES' but not limited to :

a. Emergency DG sets including automatic mains failure (AMF) panels and associated Fuel Feeding System and accessories etc. to meet emergency and essential loads of Coal Gasification based Fertilizer complex, Talcher.

Nos. & Rating of DGs shall be 3 Nos. 2000 KVA Prime Power Rating , 11kV, 0.8 pf, 3 phase, 50 Hz (each)

All the DG sets shall run in synchronisation or in Island Mode with Grid, as per Power requirement of the Plant. AMF panel shall have facility for Automatic control load & Voltage control of the DG sets.

b. Synchronization Panel & Emergency Power Distribution Board (11kV) (refer SLD)

c. Switchgears:

- 11 kV Switchgears/ switchboards, MCC/PMCC
- LSDB, PDB, Junction boxes etc as required.

d. Bus Ducts, if required

e. All Cables viz

- Power Cables (11kV, 1.1kV)
- Control Cables,
- Earthing Cable
- Signal cables,
- Optical fibre cables
- Data Cables
- Communication cables

f. Erection/ installation & all sundry materials for installation, testing & commissioning of equipment/ panels/ fittings/ cables (including jointing & termination of cables) comprising (but not limited to) following:

- Brackets, support structures, erection materials & accessories, as required
- Cable trays, racks, pipes, ducts, cable channels etc as required.
- Testing checking kits/ instruments

g. Neutral Grounding, NER.

	EMERGENCY DIESEL GENERATORS PACKAGE TALCHER FERTILIZERS LIMITED TECHNICAL SPECIFICATION – ELECTRICAL	PC183/E/4022/SecVI-3.1	0	
		Document No.	Rev	
		Sheet 8 of 68		

- h. UPS System
- i. Illumination system -Normal, emergency and evacuation lighting.
- j. Earthing and lightning Protection of equipment & structures.
- k. 110V DC & 24V DC Batteries, Battery Charger and DC Distribution Boards.
- l. UPS Distribution Board, as required
- m. Complete Electrics for EOT Crane, Hoists,
- n. Cable trench/Cable tray with supporting structure.
- o. The scope shall also include the erection, testing, commissioning of above equipments.

The contractor shall clear the site after commissioning of the equipments / system and obtain the Site Clearance Certificate from owner's Engineer-in-charge

- p. Any and all other Materials, Equipment and Services so as to make a totally integrated and functional system together with all accessories and associated equipment, ensuring safety, maintainability and reliability in compliance with all applicable codes, standards, guidelines, statutory regulations and safety requirements in force.
- q. Any other equipment, not specified, but required for safe, proper, trouble free and efficient operation of the system
- r. Contractor shall consider any other requirement which is not covered in this NIT, but required for successful operation of the Package.
- s. Spares & consumables for complete electrics as follows:
 - Commissioning Spares (as per Clause No. 14.0 of Design Philosophy - Electrical) and Spares for 2 Years operation (Mandatory) for all equipments (as per Section VI-8.0: Spare Parts) shall be supplied by the Contractor as part of LSTK contract.
 - Contractor shall provide recommended spares (other than mandatory spare) for all the equipment (item-wise) with recommended quantity.
 - Spares and consumables required and first oil fills including short fall during erection, testing, cold trials, commissioning, performance evaluation tests, guarantee tests etc and till handing over of installation shall be supplied by the Contractor as part of LSTK contract.
- t. Tools & Tackles.
- u. Testing Equipments/ instruments
- v. Arranging services of major equipment suppliers during installation and commissioning.
- w. Training of Owner's Personnel for Operation & maintenance of the Package
- x. Any and all other items/ facilities/ services not specifically mentioned but essential/ required for completeness of the systems/ equipments/ facilities.

1.12 This design philosophy contains specifications of the major equipments to indicate the basic requirement and serve as a guideline. However, it shall be the responsibility of the contractor to offer a complete quality electrical system of superior quality, even if the specifications of certain items are not given.. The items for which technical specifications are not indicated herein shall be of IS/IEC standard and specifications of these shall be subject to owner's approval in case of order.

1.13 The bidder shall offer the best and proven most suitable type of energy efficient equipments manufactured by well known reputed manufacturers having proven performance track record of minimum 2 years , as per vendor list appended in this bid package. However for the sake of standardization of the electrical equipment and material used for the electrical installation, the

	EMERGENCY DIESEL GENERATORS PACKAGE TALCHER FERTILIZERS LIMITED TECHNICAL SPECIFICATION – ELECTRICAL	PC183/E/4022/SecVI-3.1	0	
		Document No.	Rev	
		Sheet 9 of 68		

Contractor shall supply all items of a particular type or make for whole Package of the same manufacturing company for ease of maintenance and less spares inventory.

- 1.14 1 No. 415 V Feeder (63 A) at Existing Substation near 132 KV Switchyard shall be made available. Tapping of Construction Power (on chargeable basis) from this feeder (including supply & erection of all required materials like structural supports for cable tray, cable trays, power cables, control cables, protection & metering, cable termination etc. as well as underground cabling work) and further distribution shall be in Contractor's scope.

Bidder shall ensure that the minimum power factor of 0.9 shall be maintained at their end by providing suitable power factor improvement devices.

Contractor shall have to distribute construction power with adequately rated distribution and sub distribution boards/feeder pillars, power supply cables and other associated materials for feeding loads to carry out construction and fabrication activities at his own cost.

However during non availability of construction power, Contractor shall have to arrange emergency power, if required, through DG set at their own cost.

- 1.15 Contractor shall provide adequate area lighting at site of construction, storage yard and office etc. by means of suitable lighting fixture etc. which are to be supplied and maintained by the contractor as per safety aspect.

- 1.16 For control, monitoring, load management, data logging and printing of status of all important electrical equipment and feeders, a Programmable Logic Controller (PLC) based Electrical Control & Monitoring System (ECMS) shall be provided by Electrical Distribution System (EDS) LSTK Contractor. However, Contractor has to provide the required multifunctional dual channel transducers, Digital Multi-function Meters, latest version numerical/Communicable type protective relays with non-volatile memory, comprehensive unit providing protection, metering, control & communication with communication port & interlinked with Online Energy/Load Management System and required microprocessor based devices if any in panels, communicable door mounted Motor Protection Relays in all motor feeders of PMCC & MCC, proper communication facility in supplied UPS, Battery Chargers, VFD, Soft starter, MOV and other critical equipment for proper communication with ECMS / DCS system.

The interface of electrical equipments with ECMS / DCS shall be through IEC 61850 communication protocol for Numerical relays and IEC 61850/Modbus for Multifunction Digital Meters, Motor Protection Relay (MPR) and other equipment. Required number of Ethernet Switches complete with LIU, Patch Chord etc. shall be provided in each section of all Switchboards, as per requirement of Owner's ECMS. 100% redundancy shall be provided for communication i.e. the relay should have minimum 2 Nos. IEC-61850 communication port in addition to Front Port.

- 1.17 The scope shall also include obtaining all required statutory approvals from all statutory bodies. Contractor shall carry out all modifications/alterations required by statutory bodies.

All approvals for permanent installations shall be obtained in the name of Owner. Approval for equipment & installation for Construction Power shall be in Contractor's name.

- 1.18 In case of any discrepancies between Design Philosophy – Electrical and Technical Specification of equipment/item/work in respect of description of equipment/ item/work, the details indicated in the Design Philosophy – Electrical shall prevail.

- 1.19 All electrical equipments installed in the areas classified as hazardous shall be certified for such use by a recognized certifying authority such as CIMFR Dhanbad / PESO, Nagpur etc.

- 1.20 Following Interfaces are envisage presently of Contractor ;

- Protection for Emergency Incoming feeders of 11 kV Switchboard at Offsite & Utilities Substation (OUSS) to Contractor Switchboard (Inter tripping, Cable Protection etc.)

- 1.21 Panel Rooms shall be provided with following equipment :

- CO₂ fire extinguishers (4.5 litre capacity) as per applicable NFPA.

	EMERGENCY DIESEL GENERATORS PACKAGE TALCHER FERTILIZERS LIMITED TECHNICAL SPECIFICATION – ELECTRICAL	PC183/E/4022/SecVI-3.1	0	
		Document No.	Rev	
		Sheet 10 of 68		

- DCP fire extinguishers
- Synthetic insulating mats on front and back side of the switchboards. (LV as well as HV) as per latest IS.
- Framed single line diagram in Aluminum frame with glass,
- Do's & Don't chart as per Indian Electricity Rules in Aluminium frame with glass.
- Shock treatment chart written in English and Local language duly framed and approved by engineer-in-charge.
- Caution boards / dangers boards written in ENGLISH & HINDI for all the voltage levels.
- High Voltage / Low Voltage danger signage (Skull & bones).
- Exit Route / Emergency Exit Route Signage.

Other requirement or any other unforeseen which may arises during detailed engineering shall also be in Contractor 's scope

2.0 BASIS OF DESIGN

2.1 General

2.1.1 The electrical installation shall be designed to provide:

- Necessary amount of power
- Flexibility
- Service reliability
- Ease of expansion
- Ease of operation and maintenance & inter changeability of equipment
- Safety of personnel

The design of electrical installation shall ensure provision of a safe, efficient and reliable supply of electricity at all times including adverse system conditions. Safe conditions shall be ensured under all operating conditions including those associated with start up and shut down of plant as well as those arising out of failure of electrical equipment. The isolation of part of system of electrical equipment due to either maintenance or shut down shall not compromise safety aspects.

2.1.2 The design of electrical installation shall ensure provision of a safe and reliable supply of electricity at all times. Safe conditions shall be ensured under all operating conditions including those associated with start up and shut down of plant as well as those arising out of failure of electrical equipment, climatic conditions like lightning and earthquake etc. The isolation of part of system of electrical equipment due to either maintenance or shut down shall not compromise safety. All electrical equipments shall be of proven design and technology.

System shall be designed considering following aspects in general: -

- To facilitate inspection, cleaning and maintenance with the care to safety in operation and personnel protection.
- To minimize turnaround time.
- To provide safety, reliability and flexibility of service.
- Adequate provision for future extension and modification.
- Maximum interchangeability of equipment.
- Desired level of operator interface to achieve coordinated efficient and fail-safe operation, data logging and maintenance of the equipment.
- To decide redundancy, stand by, spares and overload capacities to achieve desired reliability and flexibility requirement.

	EMERGENCY DIESEL GENERATORS PACKAGE TALCHER FERTILIZERS LIMITED TECHNICAL SPECIFICATION – ELECTRICAL	PC183/E/4022/SecVI-3.1	0	
		Document No.	Rev	
		Sheet 11 of 68		

- To get cost effective and techno commercially proven technology. Economic considerations shall cover capital and running costs and an assessment of the reliability of the system.
- 2.1.3 All the electrical consumers within the battery limit shall be identified and listed to have complete details of rating, efficiency, power factor, operating duty cycle (continuous, intermittent, standby), category of supply required (emergency, normal, critical) etc.
- 2.1.4 Contractor while performing design and engineering activities shall adhere to following guidelines.
- a) If any equipment is not covered in this design philosophy but required for successful operation of the project, Contractor shall prepare additional specifications for equipment or bulk material taking reference of Indian/International Codes and good engineering practices prevalent in fertilizer industry and obtain owner's approval for the same.
 - b) The standard drawings attached with this package define the basic system design and distribution philosophy for the package. This is for guidance purpose only. Contractor shall develop detailed drawings and submit for owner's approval.
 - c) Contractor shall be responsible to verify the rating and consider providing equipment with adequate rating but not less than the specified rating. Compliance should be without any extra cost and time implications.
 - d) Contractor shall consider any other requirement which is not covered in this bid package, but required for successful operation of the plants without any extra cost and time implications.
 - e) Contractor shall obtain approval from all statutory authorities such as Central Electricity Authority (CEA)/Chief Electrical Inspectorate, Chief Controller of Explosives (CCoE), if required, CPCB, State Pollution Control Board, Odisha etc. for all electrical facilities including electrical switchboards & panels supplied and installed by Contractor. All the latest CPCB / State Control Board Odisha norms shall be followed for design of DG Sets.
 - f) Contractor shall assist in Liaison and in all interface coordination with contractors of other units of project at construction, erection, testing & commissioning phase for any common facility and for smooth execution.
 - g) Equipment specification sheet/data sheets for all equipment shall be prepared by the contractor based on relevant codes and Technical specifications/ Data sheets attached as reference. Data sheet shall contain all technical data and information which are essential for review and technical acceptability, detailed engineering, installation, testing, repair and maintenance, replacement etc.
 - h) Contractor shall clearly specify in their purchase specifications the requirement of conducting special tests/type tests, which are envisaged for various electrical equipment which shall have no impact on cost and time.
 - i)
 - j) All the electrical equipments shall be of proven design and technology.
All the electrical equipments shall be designed / sized considering motor input power (i.e. BKW divided by motor efficiency).
Minimum P.F. shall be maintained as 0.95 at every voltage level.
All the electrical equipments like DG Set, Switchboards etc. shall be suitable for starting of the largest motor, while other loads are running, considering peak load condition.
 - k) Electrical equipments i.e. Switchgears, MCCs, PCCs etc. shall have capacity for future requirements. The Margin shall be as follows:
 - i) Switchboards and MCCs fed from other switchboards: Shall be rated for 125% of peak load.
 - l) Prospective touch and step voltages shall not be adverse to the stipulations of relevant publications of Bureau of Indian Standards / IEC/IEEE-80.

	EMERGENCY DIESEL GENERATORS PACKAGE TALCHER FERTILIZERS LIMITED TECHNICAL SPECIFICATION – ELECTRICAL	PC183/E/4022/SecVI-3.1	0	
		Document No.	Rev	
		Sheet 12 of 68		

m) Sizing calculations for all the electrical equipments shall be submitted for review/approval, in case of award of order. Owner/Consultant's Comments, if any on the same shall also be considered and modification in any equipment shall be done accordingly, without any price implication.

n) Seismic zone as applicable shall be considered for design of all electrical equipment.

2.2 Statutory requirement Codes and Standards

2.2.1 The design, installation, testing & commissioning shall conform to compliance of following statutory requirements :

- Indian Electricity Act
- Indian Electricity Rules
- The Indian Factories Act
- The Indian Explosives Act.
- Statutory requirement of Govt of Odisha and Govt. of India.
- Guidelines, instructions, directions issued by Pollution control Boards of state as well as central government. Guidelines, instructions, directions issued by Chief Controller of Explosives (CCoE), CPCB, CMRI, DGMS, CEA etc.
- Guidelines of Tariff Advisory Committee
- Guidelines of Insurance Companies Association.
- Any other applicable Rules/Acts/Regulations.

The design, installation, testing & commissioning shall be in accordance with established codes, good engineering practices and latest versions of following documents valid/ applicable on the date of acceptance of bid. The stipulations in these documents shall be considered as minimum requirements:

- Indian Standard Specification or equivalent IEC Standards
- Publications of IEEE
- API Standards
- National Electrical safety Code(NESC)
- Standards of Underwrites laboratory(UL)
- American Society for Testing Material (ASTM)
- American National Standards Institute (ANSI)
- Other International Standards

Contractor shall be responsible for obtaining necessary statutory approvals from all the statutory bodies/authorities e.g. Electrical Inspectorate, PESO (earlier CCoE) as applicable before commissioning of electrical facilities. The CEA clearance for electrical equipment and components thereof shall be obtained by the contractor.

Contractor shall carry out all modifications / alterations required by all statutory bodies. However, necessary statutory fee shall be deposited by the Owner.

2.3 Some of the bare minimum relevant Indian Standards are as listed below. However, system/equipment design shall be in line with latest edition of all applicable standards.

IS: 325, IEC:60034	Three phase induction motors
IS: 335	New insulating oil for transformers and switchgears
IS: 722	AC electricity meters
IS: 732	Code of practice for electrical wiring installations system voltages not exceeding 650V
IS: 737	Specification for wrought aluminum and aluminum alloys, sheet and strip (for engineering purpose)

	EMERGENCY DIESEL GENERATORS PACKAGE TALCHER FERTILIZERS LIMITED TECHNICAL SPECIFICATION – ELECTRICAL	PC183/E/4022/SecVI-3.1	0	
		Document No.	Rev	
		Sheet 13 of 68		

IS: 996, IEC:60034	Single phase AC motors
IS:1248	Direct acting analogue electrical measuring instruments and their accessories:
IS: 1367 Part-13	Hot dip galvanised coatings on threaded fasteners.
IS: 1646	Code of practice for fire safety of buildings and electrical installations
IS: 1913	General and safety requirements for Luminaries (Tubular fluorescent Lamp)
IS: 2071	Method of high voltage testing
IS: 2099	High voltage porcelain bushings
IEC:62305	Code of practice for the protection of buildings and allied structures against lightning
IS/IEC60079	Electrical apparatus for Explosive gas atmosphere
IS: 2544	Porcelain post Insulators for system with normal voltage greater than 1000 volts
IS: 2633	Methods of testing uniformity of coating on zinc coated articles
IS: 2705	Current Transformers
IS: 3034	Code of practice for fire safety of industrial buildings, electrical generating distributing stations.
IS: 3043	Code of practice for earthing
IEC 61869-1	Instrument transformers — General requirements
IEC 61869-2	Additional requirements for current transformers
IEC 61869-3	Additional requirements for inductive voltage transformers
IS: 3177 IEC60034	Crane duty motors
IS: 3347	Dimensions for porcelain transformer bushings
IS: 3637	Gas operated relays
IS: 3639	Fittings and accessories for power transformers
IS: 3646	Interior illumination: Part I & Part II
IS: 3716	Application guide for insulation co-ordination
IS/IEC:60529	Degree of protection provided by enclosure for rotating electrical machinery
IS: 4722	DC motors
IS: 4759	Hot dip zinc coating on structural steel and allied products
IS: 5082	Specification for wrought Aluminum alloys bars, rods, tubes and sections for electrical purposes
IS: 5561	Electric power connectors
IS: 5571	Guide for selection of electrical equipment for hazardous areas

	EMERGENCY DIESEL GENERATORS PACKAGE TALCHER FERTILIZERS LIMITED TECHNICAL SPECIFICATION – ELECTRICAL	PC183/E/4022/SecVI-3.1	0	
		Document No.	Rev	
		Sheet 14 of 68		

IS: 5572	Hazardous areas other than mines for electrical insulations area having flammable gases and vapours
IS: 5578	Guide for marking of insulated conductors (1st rev)
IS: 6362	Designation of methods of cooling of rotating electrical machines
IS: 6600	Guide for loading of oil immersed transformers
IS: 6665	Code of practice for Industrial lighting
IS: 7689	Guide for control of undesirable static electricity
IS: 8084	Interconnecting Bus bars for AC voltage above 1 KV upto and including 36 KV
IS: 9676	Reference ambient temperature for electrical equipment
IS: 10028	Code of practice for selection, installation and maintenance of transformers
IS: 10322-1	Specification for Luminaries,Part-1,General requirements
IS: 11353	Guide for uniform system of marking & identification of conductor & apparatus terminals
IS: 11448	Application Guide for AC electricity meters
IS: 12360	Voltage bands for electrical installations including preferred voltage and Frequency
IS: 12459	Code of practice for fire protection of cable runs
IS: 12615	Energy efficient motors
IS: 13234	Guide for short circuit calculations
IS: 13346	General requirements for electrical apparatus for explosive gas atmosphere.
IS: 13408	Code of practice for the selection, installation and maintenance of electrical apparatus for use in potentially explosive atmospheres
IEC: 60255	Electrical Relays
IS/IEC: 60947	Low voltage switchgear and control gear
IEC: 60947-7-1	Terminal blocks for copper conductors
IS:10118	Code of Practice for Selection, Installation and Maintenance of Switchgear and Control gear
IS: 60034-5	Degree of protection provided by Integral design of rotating electrical machines
IS: 60079-0	Explosive atmospheres, Equipment General Requirements
IS: 60079-1	Explosive gas atmospheres – Part-1 Equipment protection by Flame proof enclosures “d”.
IS: 60079-7	Equipment protection by increased safety “e”
SP: 30	National Electrical Codes (NEC) - BIS Publication
IS/IEC 62271	HV Switchboard.
IEC 60947	LV switchboard.

	EMERGENCY DIESEL GENERATORS PACKAGE TALCHER FERTILIZERS LIMITED TECHNICAL SPECIFICATION – ELECTRICAL	PC183/E/4022/SecVI-3.1	0	
		Document No.	Rev	
		Sheet 15 of 68		

IEC 61439-1/2	LV switchboard (PCC/PMCC/MCC) for TOTAL TYPE TESTED (TTA). Type Test Certificates for short circuit withstand of 50kA for 1 sec. along with ACB mounted in the Switchboards shall apply.
IEC 61641	Switch Board with INTERNAL ARC CONTAINMENT test.
ANSI C-37:23	Metal enclosed bus
ANSI C-37:24	Effect of Solar radiation on metal enclosed bus.
IEC 60034	Rotating Electrical Machinery
IEC 61131	Programmable controllers
IEC 60871-1 /IS 13925	Shunt Capacitors for AC power Systems Specifications

Any other standard may be followed provided it is equivalent or more stringent than the standards specified above.

2.4 In case of any conflict/deviation amongst various documents the order of precedence shall be as follows:

- Statutory rules/regulation
- Design Philosophy
- Data sheets
- Technical specification/Installation Standards, etc.
- Applicable IS/IES standards

In case of contradiction / conflict among documents and statutory requirement, Contractor shall refer to Owner for clarification. However, most stringent specification shall be followed with Owner's approval. Owner decision shall be considered as final.

2.5 Site Conditions

The equipment shall be designed for the following site conditions:-

- Minimum ambient Temperature 1 deg.C
- Maximum ambient Temperature 46 deg.C
- Design Reference Temperature 50 deg.C
- Relative Humidity 100%
- Altitude above mean sea level Lower than 1000 Mtrs.
- Atmospheric pollution Dusty due to presence of Coal Dust & Urea Dust and corrosive due to presence vapours of Ammonia.

Equipment/ cables selected shall be derated for (a) higher ambient temperature, (b) restriction in temperature rise (c) variation in voltage, (d) variation in frequency (e) installation conditions viz. proximity to heat sources, bunching, layering, separation from others/ laying in conduits etc. with respect to the conditions for which it was designed & manufactured. Various de-rating factors considered shall be informed with supporting documents.

Equipment to be installed in MCC rooms/ Electrical Rooms/ Control rooms shall be designed for + 50° C so that in case of failure of Air-conditioners / ventilation facilities, the operation/ functioning of equipment is not be affected.

3.0 AREA CLASSIFICATION.

	EMERGENCY DIESEL GENERATORS PACKAGE TALCHER FERTILIZERS LIMITED TECHNICAL SPECIFICATION – ELECTRICAL	PC183/E/4022/SecVI-3.1	0	
		Document No.	Rev	
		Sheet 16 of 68		

- 3.1 The hazardous zones within the project area shall be classified according to the requirement of IS/IEC. The bidder shall furnish area classification drawing with Technical part of the Bid.

PESO approved Hazardous Area Classification Drawing shall be submitted during detailed engineering.

- 3.2 All electrical equipments installed in the areas classified as hazardous shall be certified for such use by a recognized international certifying authority such as CIMFR earlier CMRI, Dhanbad. The item shall in addition bear the valid certification from PESO (earlier CCoE) and also the manufacturer shall hold a valid Bureau of Indian Standards (BIS) license.

For those items where overseas OEM vendor will supply the electrical equipment certificate from international authority can be accepted but the certification shall be approved by PESO (earlier CCoE), Nagpur India.

- 3.3 The electrical equipment for hazardous areas shall be selected as per IS-5571 and petroleum rules and Gas group shall be selected based on the approved hazardous area classification drawing . The minimum requirement is summarized below:

Equipment	Zone-1	Zone-2
MV Motors	Ex-de	Ex-n
HV Motors	Ex-de / Ex-p	Ex-n/Ex-de/Ex-p
Push Button Station	Ex-d	Ex-d
Motor Starters	Ex-d	Ex-d
Plug & Socket	Ex-d	Ex-d
Welding Receptacle	Ex-d	Ex-d
Lighting fitting	Ex-d	Ex-nR
Control Gear Box	Ex-d	Ex-nR/Ex-d
Junction Boxes	Ex-d	Ex-d
Transformer Unit	Ex-d	Ex-d
Break Glass Unit (Fire Alarm System)	Ex-d	Ex-d
Lighting Panel/Power Panel	Ex-d	Ex-d
Transformers	Hermetically sealed with surface temperature not exceeding 200° C	

Notes:

The electrical equipment for hazardous areas shall generally be suitable for gas group IIB and temp classification T3 as applicable to the selected type of explosion protection. In case of hydrogen or hydrocarbon mixtures having more than 30% hydrogen, the gas group to be considered shall be IIC.

As additional safety features, the following requirements for electrical equipment shall be followed :

- All electric motors for agitators/mixers and metering pumps handling flammable material shall be flameproof type (Ex-de) irrespective of the area being classified as zone-2 or zone-1.
- All electric motors for vertical sump pumps handling flammable material shall be flameproof type (Exde).
- Irrespective of the area classification (whether zone-1 or zone-2), all lighting fixtures within the storage areas shall be flameproof type (Ex-d).
- Irrespective of the area classification (whether zone-1 or zone-2), all motors and lighting fittings within the pump house near the offsite tank farm and within the loading/unloading gantries shall be of flameproof type (Ex-d).
- All emergency/critical lighting fixtures and associated junction boxes in hazardous areas (whether zone-1 and zone-2) shall be flameproof type (Ex-d).
- Even though fired heaters in process units are not considered for area classification, all electrical equipments associated with fired heaters in process units shall as a minimum be suitable for installation in Zone-2 area.

	EMERGENCY DIESEL GENERATORS PACKAGE TALCHER FERTILIZERS LIMITED TECHNICAL SPECIFICATION – ELECTRICAL	PC183/E/4022/SecVI-3.1	0	
		Document No.	Rev	
		Sheet 17 of 68		

7. Where air conditioning system is designed considering ammonia as refrigerant, the room housing air conditioning equipment shall be adequately ventilated to classify it as safe area. For additional safety the following shall be considered:
 - 100% standby system for ventilation
 - Location of MCC/local panels in adjacent separate room.
 - Instrumentation to be flameproof type or hermetically sealed.
 - AC plant room motors with type 'e' protection.
 - Lighting in AC plant room suitable for zone-2 area.
8. Building such as Compressor sheds inside the process area shall be designed to allow adequate ventilation to allow area classification as Zone-2. Lighting equipment, EOT crane etc. in the shed shall be flameproof type (Ex-d). All other electrical equipment shall be suitable for Zone-1 or Zone-2 area depending on extent of hazard.
9. All HV motors for hazardous area Zone-1 shall preferably be flameproof type (Ex-de). Pressurised motors may be provided in exceptional cases.
10. Ex-n motors without pre-start ventilation as permitted by Indian Standard unless any other type is specified by Process Licensor, shall be provided, except for the following cases as listed below:
 - HV motors for Centrifugal compressors (As Ex-n motors are not recommended for use for such applications as per IS/IEC-60079-15 and therefore Ex-de or Ex-p motors shall be provided for these applications)
 - For motors in Zone-2 areas having frequent start/ stop requirements e.g. EOT cranes/ Elevators, MOV actuators etc., Ex-de motors shall be used.
11. For Zone-2 areas, motors with ratings above 100kW having average starting frequency of more than one per week, Ex-n motors with pre-start ventilation provision or Ex-de or Ex-p motors shall be used.
12. Ex-p motors shall be used for large rating motors where Ex-de or Ex-n motors are not available.

4.0 SYSTEM DETAILS AND UTILIZATION VOLTAGES

4.1 The various voltage levels for in plant power distribution shall be as follows:

A. Normal Power	11KV \pm 10%, 50Hz \pm 5%, 3Ph, 3 W
B. Emergency Power	11KV \pm 5%, 50Hz \pm 3%, 3Ph, 3 W
C. Distribution Equipment	a) 11KV \pm 10%, 50 Hz \pm 5%, 3 Ph, 3 W with resistance earthed neutral b) 3.3KV \pm 10%, 50 Hz \pm 5%, 3 Ph, 3 W with resistance earthed neutral c) 415V \pm 10%, 3 Ph, 4 W/240V \pm 10%, 1 Ph, 2W, 50 Hz \pm 5% solidly grounded neutral.
Combined variation in voltage & frequency	\pm 10%
Control Supply for:	
- 415V motors	AC 240V \pm 10%, 50 Hz \pm 5%, 1Ph (For contactor controlled motors)- Electrical UPS located in Substation. DC 110V \pm 5% (For breaker controlled motors) – Battery Charger
- Switch Gear Breaker controlled feeders:	
a. Closing, tripping & spring charging motor	DC 110V & 24V \pm 5%, 2 W - Battery Charger AC 240V \pm 10%, 50 Hz \pm 5%, 1Ph, 2W

	EMERGENCY DIESEL GENERATORS PACKAGE TALCHER FERTILIZERS LIMITED TECHNICAL SPECIFICATION – ELECTRICAL	PC183/E/4022/SecVI-3.1	0	
		Document No.	Rev	
		Sheet 18 of 68		

b. Auxiliary power	
- Instrumentation and Automation, DCS & Auxiliaries	AC 115 V \pm 10%, 50 Hz \pm 3% 1Ph, 2W – Instrumentation UPS located at Control Room
Voltage Ratings	
- Motors above 150 KW up to 1000 KW.	3.3 KV, 3 Ph AC
-Motors up to150 KW	415 V, 3 Ph AC
- Space heaters	240V, 1 Ph AC
- Lighting	415V/240V AC
- Power Sockets/Receptacle	415V, 3 Ph AC/240V, 1 Ph AC

- 4.2 The actual fault levels shall be arrived at on the basis of incoming power source, transformers, contribution of motors, etc. and shall be indicated in the Bid.

All switch boards of the same voltage shall be rated for identical fault level. Minimum fault level to be considered for design and selection of equipment shall be as follows:

11 kV Switchgear – 40KA for 3 Seconds.

The fault level for 415V switchboards shall be 50KA for 1 sec.

Fault level of DC System shall be decided by the Contractor after substantiating the same by calculation.

4.3 **System Earthing**

The neutral of 11 KV systems shall be non-effectively earthed through resistance. The earth fault current of 11 KV EDG and DG neutral shall be as per OEM recommendation. The neutral of 415V supply system shall be solidly earthed.

The DC system shall have positive pole earthed through high impedance. Prospective touch voltage earthing shall comply with the requirements of relevant Indian/IEC standards.

5.0 **POWER SUPPLY AND DISTRIBUTION.**

- 5.1 In the event of failure of normal power in the plants, the plants shall be brought to safe shut down condition through Emergency power.

- 5.2 The emergency power shall be arranged through 3 Nos. 2000 KVA Prime Power Rating, 11 kV DG Sets. These DG sets shall feed emergency loads of Coal Gasification Plant and other Offsite & Utilities.

There shall be Emergency Power Distribution Board (as per SLD) feeding 11kV Switchboard at OUSS.

After the voltage of the DGs are built up to normal rated values on Emergency Power Distribution Board (after automatically synchronization of all the DGs and closing of Incomer Circuit Breakers), Outgoing feeder of Emergency Power Distribution Board and Emergency Power incomers on 11 kV Switchboard of OUSS shall be closed, so that the essential loads can be switched on in a staggered manner. Provision for No Load Trial & Load testing facility of DG set shall be provided.

All DG Sets shall be operated in Black Start condition.

	EMERGENCY DIESEL GENERATORS PACKAGE TALCHER FERTILIZERS LIMITED TECHNICAL SPECIFICATION – ELECTRICAL	PC183/E/4022/SecVI-3.1	0	
		Document No.	Rev	
		Sheet 19 of 68		

In the event of plant black out and/or sustained under voltage on Emergency Switchboard(s), Diesel Generator set shall be started automatically by AMF after getting signal of outage of Normal Power.

DG set shall be capable for starting synchronizing between all DG Sets and taking full load within 30 Seconds, without undue vibration and overheating of the engine.

All DG Sets shall be synchronized among themselves at Emergency Power Distribution Board.

After restoration of normal power, provision of automatic stopping of DG Sets with time delay shall be provided as well as bypassing of same shall also be provided. In case of bypass, manual control of DG sets shall be from DG Control Room. Restoration of normal power, stopping of DG shall be done from the DG Control Room. The DG sets shall have provision of starting and stopping through ECMS. Restoration of Power will be without Break i.e. after synchronization of Normal & Emergency Power.

Capacity and reactance of DG shall be selected in such a way that following performance requirement are also fulfilled.

1. Auto starting of AC emergency lube oil pumps and seal oil pumps shall be possible.
2. Starting of emergency drives of largest rating shall be possible with the DG operating at its base load ie. with all emergency loads in operation except of largest rating. Largest motor rating from Coal gasification/Off Site utilities shall be 200kW.

DG Sets & Diesel Tanks shall be located at a minimum safe distance from substations as per relevant IS/IEC of hazardous area classification.

- 5.3 Owner shall provide 2 Nos. 3-Ph, 415V±10%, 50Hz±5% Normal Power supply Feeders at OUSS for PMCC/MCC for DGs' Auxiliaries. Contractor shall inform the kW requirement. Further distribution shall be done by Contractor. DC supply shall be arranged by Contractor. Selection of Ni-Cd battery along with battery sizing calculation shall be submitted by Contractor. Any other supply required by Contractor shall be internally derived by Contractor.
- 5.4 Tapping of power supply from PMCC at OUSS (including supply of all required material), structural supports for cable tray, cable trays, cables, cable termination etc. shall be in Contractor's scope. Further distribution to equipment at 415/240 V, 115 V (UPS) AC, 240 V (UPS) AC, 110 V DC etc. through proper type and size of cables, their supply, erection, testing and commissioning etc. shall be in Contractor's scope.
- 5.5 The insulation system of cable, 11 kV equipments shall be based on unearthed system only.
- 5.6 Each incoming feeder shall be sized for 125% load of the switch board. The outgoing feeders shall be sized for the nominal load. The entry of cables in the switchboards shall be from bottom only.
- 5.7 All switchboards shall be provided with minimum two incoming feeders and one bus tie having auto/manual changeover facility.
- 5.8 It shall be possible to have momentary paralleling of power sources at 415V PMCC /PCC/MCC and trip the desired circuit breakers.
- 5.9 The normal operation of the Power & Motor Control Centre (PMCC) / Motor Control Centre (MCC) shall be as under:
 - i. Bus-coupler shall be provided between all the sources. Incomer and Bus-coupler breaker rating shall be same for all the switchboards. Each incoming feeder shall independently feed the loads on respective buses with full rated bus tie breaker open and the load on each bus balanced. In order to ensure maximum degree of reliability and continuity, automatic transfer from one incoming feeder to other shall be possible through auto/manual closing of bus tie breaker in case of sustained loss of power on any bus section.

	EMERGENCY DIESEL GENERATORS PACKAGE TALCHER FERTILIZERS LIMITED TECHNICAL SPECIFICATION – ELECTRICAL	PC183/E/4022/SecVI-3.1	0	
		Document No.	Rev	
		Sheet 20 of 68		

- ii. The bus tie breaker shall be provided with auto/manual selection. The bus tie breaker shall be independent in manual mode. In auto selection mode, the bus tie breaker is electrically interlocked with incoming circuit breakers, so that it cannot be closed unless one of the incoming breakers is open.
- iii. When one of the incoming feeder trips, the bus tie breaker is closed automatically based on the philosophy described and the total load is transferred to other healthy incoming feeder which is capable of carrying the entire load. Sufficient switchgear capacity is to be provided. Time for changeover is suitably selected based on downstream system requirement of reacceleration of motors etc.
- iv. Auto Change Over scheme shall be provided for incomer feeders and bus coupler feeder of 415V Switchboards. Under normal operating conditions, incomer-1 and incomer-2 breakers shall be closed and bus coupler breaker shall remain open with 'Local-Remote-Off' switch in 'Remote' position. The bus coupler breaker shall close automatically under the following conditions being fulfilled:
 - Either of the incoming breaker trips due to under voltage (70% or below).
 - Voltage on the healthy bus is more than 80% for the set period.
 - Residual voltage on the bus with no power supply comes down to 30% or below.
Required nos. of bus PT, line PT and under voltage relays shall be provided to achieve the desired automatic changeover.
- v. Auto transfer shall take place only on sustained loss of power on either of bus sections. Auto transfer shall be blocked in case of fault on either of bus sections or no power on both incomers.
- vi. Paralleling of two incoming feeders is not foreseen. However, facility for momentary paralleling shall be provided for intentional changeover without interruption of supply with synchro check relay in Bus Coupler panel. There shall also be provision of selective tripping of one feeder out of three feeders with a Delay (two incoming feeders and one Bus Coupler).

5.10 Instrumentation Power

5.10.1 Separate 240VAC UPS System shall be provided to feed PMCC/MCC control supply, Control Room (to meet 250 lux in case of UPS Supply only)) & Panel Room lights (30% of total light) , ECMS Equipment, Fire Detection & Alarm System etc. This UPS System along with associated Battery (Ni-Cd) and UPS distribution Board shall be located at Panel Room.

5.11 DC Power

5.11.1 110 V DC system shall be provided for control of circuit breaker feeders and panic lighting. It shall be obtained from Ni-Cd batteries.

5.11.2 The battery shall be provided with SCR controlled automatic rectifier-cum battery chargers and shall consist of Main Float cum Load charger, Standby Float cum Load charger and Boost Charger and 2 Nos. Battery Bank each of 60% capacity (of 5 hours backup at 100% capacity) with isolation facility for ease of operation & maintenance.

5.11.3 Rectifier-cum- battery charger shall have independent power supply to be fed from the emergency Bus of 415 V switchboard.

5.11.4 Battery end cell voltage shall 1.1V. Aging factor shall considered 125% and spare capacity shall have 120%.

5.11.5 For Temperature derating factor shall be based upon Minimum Ambient Temperature i.e. 5⁰C.

5.11.6 Battery Charger shall have at least 20% extra capacity for future load requirement. Battery Charger shall have 110 V DC, 24V DC system.

5.11.7 The battery and charger combinations shall be such as to ensure continuity of D.C. supply at load terminals without even momentary interruption.

	EMERGENCY DIESEL GENERATORS PACKAGE TALCHER FERTILIZERS LIMITED TECHNICAL SPECIFICATION – ELECTRICAL	PC183/E/4022/SecVI-3.1	0	
		Document No.	Rev	
		Sheet 21 of 68		

5.11.8 AC Ammeter and AC Voltmeter on Charger Input; DC Ammeter, DC Voltmeter for charger output/ battery voltage and on demand type Battery Charge / Discharge Ammeter shall be provided.

5.11.9 For all other specifications of Battery Charger , refer PC183-TS-0813.

5.11.10 For all other specifications of Battery Bank, refer PC183-TS-0814.

6.0 PANEL ROOM

6.1 Batteries and control Rooms : Separate room

6.2 Switchgear room : Air-conditioned

6.3 Battery charger in substation : Air conditioned

6.4 Nickel- Cadmium Battery : Separate room (Ventilated)

6.5 Actual size of Panel room shall be based on the final dimensions of equipments.

6.6 The layout of equipment shall be such that it shall have adequate space for installation, operation, maintenance and future expansion. The clearance of equipment from the walls/other equipment shall be adequate to ensure safety of working personnel. Generally the following norms shall be maintained for 11 kV /415 V Switchboards:

- a) The clear space of 2.0 M at rear side of 11kV kV Switchboard.
- b) A clear space of 1.5M behind the double front switchboards (PMCC/EPMCC/MCC) and 1M for single front (Floor Mounted Distribution Board).
- c) A clear space of 2.5M between the two boards facing each other.
- d) A clear space of 2.5M on either side at entrance/exit.
- e) A clear space of 2.0M between two boards in same line after future panel space of switchboard.
- f) A clear space of 1M in switch room from top of equipment.

6.7 The Panel Room, Battery Charger room, ECMS room, shall have air conditioners, however all the equipment shall be suitable for operation under specified ambient condition even on failure of air conditioning system.

7.0 PROTECTION & METERING

7.1 Selection and co-ordination of protection and metering system shall be such as to ensure:

- Selective, sensitive and reliable protection of equipment against damage due to internal or external faults or atmospheric discharge.
- Isolation of fault in the shortest possible time.
- Simplicity of the scheme with maximum protection.
- Uninterrupted operation of healthy system.
- Personnel & plant safety.

7.2 Protective relays shall be of latest version, numerical / communicable type with non-volatile memory, comprehensive unit providing protection, metering, control and communicable with communication port for interlinking with online energy/ECMS. 100% redundancy shall be provided for communication. i.e. the Relay should have minimum 2 Nos. IEC-61850 communication port in addition to Front Port. Numerical Relay shall have communication on IEC-61850 protocol in redundant mode and meters shall have communication on MODBUS protocol. Relay shall have 4 CT input for O/C and E/F protection. There should be option for derivation of E/F internally.

7.3 The relay should have facility to comprehensively monitor the healthiness of its circuits and components by own monitoring system. In case of any problem of hardware and software elements of the relay, the fault diagnosis information shall be displayed on the LCD and an

	EMERGENCY DIESEL GENERATORS PACKAGE TALCHER FERTILIZERS LIMITED TECHNICAL SPECIFICATION – ELECTRICAL	PC183/E/4022/SecVI-3.1	0	
		Document No.	Rev	
		Sheet 22 of 68		

alarm should be generated by one of the output contacts. The alarm as soft signal to be sent to ECMS / SCADA system as well. Necessary support documentation explaining the self-diagnostic feature shall be furnished. Watch dog contact shall be provided

- 7.4 All relay shall be provided with ‘ Relay Failure Annunciation Contact’
- 7.5 The relay setting and programming should be stored in EEPROM so that during auxiliary supply failure the said data is not lost.
- 7.6 The relay should be suitable for operation in ambient temperature of +55 degrees Celsius and relative humidity of 93%.
- 7.7 The relay should conform to the IEC60255-5 or equivalent BS / ANSI for following :
 - Overload withstand test
 - Dielectric withstand: 2kV in common, 1 W in differential mode
 - Impulse Voltage: 5kV in common, 1kV in differential mode
 - Insulation resistance> 100 M-ohm.
 - Vibration: Shock and bump and Seismic
 - Storing and transportation
 - Radio Interference: IEC 61000 for high frequency disturbance, Transient disturbance, Electrostatic discharge
- 7.8 Relay shall meet the requirement for withstanding electromagnetic interference according to relevant parts of IEC 60255 / IEC 61850. Failure of single component within the equipment shall neither cause unwanted operation nor lead to a complete system breakdown.
- 7.9 Numerical relay shall indicate MWH, MVAR, MVA, V, A, Hz, PF. It shall have future provision for connecting with substation HMI. Separate multifunction meter with communication (for centralized energy monitoring) shall be used and shall not be part of protective device.
- 7.10 Relays shall support features like remote relay parameterization, disturbance recorder etc. It shall be possible to set/operate the relay from the front facia. Lock out relay shall be conventional type with hand reset facility.
- 7.11 The relay shall be provided with suitable security (Password protection) against unauthorised WRIRE ACCESS for change in relay setting. However it should be possible to view metering, protection settings, status and event data as READ ONLY without password protection. The security should be available for change in relay settings locally from relay HMI as well as when relay is accessed remotely through manufacturer software / remote HMI.
- 7.12 All PCB used in relays should have harsh environmental coating as per standard IEC 60068 (HEC) to increase the particle repellence and thereby increasing the life of relay or it should be tested as per IEC60068 to operate under extreme harsh environmental conditions given in G3. Test report needs to be submitted on request. IED shall be manufactured using lead-free components.
- 7.13 The relay should support (tested for) IEC 61850 Edition 2 with parallel redundancy protocol as per IEC 62439-3 with two nos. of port and one additional port at front for local communication. Use of any type of converter is not acceptable.
- 7.14 The Numerical relay shall be provided with integral (no separate unit) arc flash protection system based on both current & light detection method. Relay should have provision of 3 nos. arc sensor, each for cable chamber, busbar chamber & circuit breaker chamber. Sensor shall cover any flash over occurring in the respective chambers. Facility should be there to adapt selective logic schemes for tripping only respective breaker or Incomer breaker.
- 7.15 Relay should comply to IEC 61850 protocols without any external protocol converter. The relays shall generate GOOSE messages as per IEC 61850 standards for interlocking and also to ensure interoperability with third party relays. Goose signals shall be freely configurable for any kind of signals using graphic tool/user friendly software. The relay must support IEC 61850 GOOSE messaging with the performance requirements for tripping applications type

	EMERGENCY DIESEL GENERATORS PACKAGE TALCHER FERTILIZERS LIMITED TECHNICAL SPECIFICATION – ELECTRICAL	PC183/E/4022/SecVI-3.1	0	
		Document No.	Rev	
		Sheet 23 of 68		

1A, Class P1 with GOOSE time <10ms as defined by the IEC 61850 standard so that any time critical interlocking can be built over communication.

- 7.16 The relay should have time synchronization through SNTP / IRIG-B
- 7.17 Fault record: The relay shall have the facility to store at least 8 last fault records with information on cause of trip, date, time, trip values of electrical parameters.
- 7.18 Event record: The relay shall have the facility to store at least 250 time stamped event records with 1 ms resolution.
- 7.19 Disturbance records: The relay shall have capacity to store at least 50 disturbance record waveforms. The relay shall have a disturbance recorder supporting a sampling frequency of 32 samples per cycle and featuring up to 12 analog and 50 binary signal channels.
- 7.20 Event log, trip log and disturbance record should go in to history. The relay settings shall be provided with adequate password protection with 4 alternative setting groups.
- 7.21 The numerical relays shall be provided with 1 set of common support software compatible with both Windows 98/ NT 4.0/ 2008/ Windows 7/ Windows 10 or higher, which will allow easy settings of relays in addition to uploading of event, fault, disturbance records, measurements and troubleshooting purposes.
- 7.22 Standard documentation per Relay, according to IEC 61850:
- MICS document (model implementation conformance statement)
 - PICS (protocol implementation conformance statement)
 - Conformance Test certificate from laboratory issuing Level A Certification under accreditation of UCA luG.
 - PIXIT document
 - All the above mentioned certificates shall be submitted.
 - ICD file
 - SCD file
- 7.23 Offered relay shall be type tested as per IEC 60255 standard.
- 7.24 Contractor shall supply licensed (lifetime) software along with required communication cables for Parameterization and viewing of disturbances, events, etc. through Laptop for all Make and models of Numerical relays. 2 Nos. Laptop (Minimum 8GB RAM, Minimum 1 TB hard Disk, latest processor) with all required software and accessories complete in all respect shall also be provided.
- 7.25 Special protection if required for any feeder such as differential, restricted earth fault, directional distance power relays etc. shall also be through numerical relay having serial port for monitoring.
- 7.26 In general all protection shall be through microprocessor based numerical relay. However high speed tripping relay shall be separate.
- 7.27 All Auto-changeover logic to be built in Numerical Relay. Numerical Relays shall have sufficient I/O to cater the same and there should be minimum 10 % spare I/O for future use. External I/O Card/ Module are not acceptable.
- 7.28 All Process Stop and other important Parameters shall be routed through Numerical relays for recording and Time-stamping. Hardware Annunciator is not required. Common Audio Visual Alarm for each Bus section of Switchboard shall be provided through Numerical relays.
- 7.29 Bare minimum protection for power distribution system shall be as indicated below. However, Contractor shall provide any other necessary protection required for complete protection of system:.

Protection devices for power distribution system shall be as indicated below (Figure inside bracket refers to note below) (YES – Applicable)

Sl.No.	Relay	Relay	DG	HV Tr.	HV	HV /LV	O/G	O/G		I/C
--------	-------	-------	----	--------	----	--------	-----	-----	--	-----

	EMERGENCY DIESEL GENERATORS PACKAGE TALCHER FERTILIZERS LIMITED TECHNICAL SPECIFICATION – ELECTRICAL	PC183/E/4022/SecVI-3.1	0	
		Document No.	Rev	
		Sheet 24 of 68		

	Description	No.	Incomer Feeder	Fdr. Sec Wdg. Volt 11 /3.3KV	Tr. Fdr. Sec Wdg. Volt< 3.3 KV	Motor Fdr., HV Breaker controlled contactor controlled	Bkr. HV Plant Fdr.	Bkr. MV PMCC		MV PMCC
1.	IDMTL Over-Current Relay	51	YES	YES	YES	-----	YES	YES		YES
2.	IDMTL Earth-Fault Relay	51N	YES	YES (4)	YES	-----	YES	YES		YES
3.	Standby / Backup Earth Fault Relay (earthed neutral)	51G (11)	YES	YES (22)	YES (22)	-----	-----	-----		-----
4.	Motor Protection Relay with (50, 50N, 46, 49, 50L/R, 95)	99	-----	-----	-----	YES	-----	YES		-----
5.	Instantaneous Restricted Earth Fault Relay (Earthed side)	64R	YES (24)	-----	-----	-----	-----	-----		YES
6.	Instantaneous Over current Relay	50	YES	YES	YES	-----	YES	-----		-----
7.	Instantaneous Earth Fault Relay	50N	YES	YES (5)	YES	-----	YES	-----		-----
8.	Differential Protection Relay	87	YES	YES (6)	-----	YES	YES	-----		-----
9.	High speed tripping relay	86 (20)	YES	YES	YES	YES	YES	YES		YES
10.	Trip Circuit Supervision Relay	95	YES	YES	YES	YES	YES	YES		YES
11.	Transformer Auxiliary Relay	63	----	YES	YES	-----	-----	-----		-----
12.	Under Voltage Relay with timer	27 / 2	YES	-----	-----	YES	YES	-----		YES (9)
13.	Check Synchronisation Relay	25		-----	-----	-----	-----	-----		YES (10)
14.	Busbar Differential	87B & 95B	YES	YES (16)	YES (16)	YES (16)	YES (16)	-----		-----
15.	Directional phase over current	67	-----	-----	-----	-----	-----	-----		-----
16.	Directional earth fault	67N	YES	-----	-----	-----	-----	-----		-----
17.	Circuit Breaker Failure	50	YES	YES	YES	YES	YES	YES		YES

Notes for Relay Protection Philosophy

- All the numerical relays shall be of communicable type and connected to ECMS on IEC 61850 (Ethernet based) communication protocol with time stamping and time synchronization.
- DG set shall be provided with protection but not limited to 51V,40,46,86,49,80,81U,32R,59,81O,87G,59N,78,50BF,24 etc. for generator.

	EMERGENCY DIESEL GENERATORS PACKAGE TALCHER FERTILIZERS LIMITED TECHNICAL SPECIFICATION – ELECTRICAL	PC183/E/4022/SecVI-3.1	0	
		Document No.	Rev	
		Sheet 25 of 68		

3. Synchronization panel shall have but not limited to 86E,64R1, 58,AVR etc.
4. In case of HV switchboards with continuous parallel operation of incomers, following additional relays shall be provided:
 - a. One set of 87B (Bus differential) and 95 B (Bus wire supervision) for each bus section.
 - b. 32 (Directional IDMTL over current and earth fault) relays for the incomers.
5. In generator power supply incomer following additional relays shall also be provided:
 - a. Relay 59 for overvoltage protection with timer, Relay 67 for directional over current protection, Relay 67N for directional earth fault protection, Relay 81 for under frequency / df/dt protection and Relay 98 as dead bus charging relay.
6. Directional IDMTL earth fault (67N) shall be provided for transformer with star primary.
7. Deleted.
8. Deleted.
9. For critical/long feeders and plant feeders connected to main power generation and distribution bus. A plant feeder implies outgoing feeders from one switchboard to another switchboard of same voltage level.
10. Wherever auto-transfer feature is provided.
11. For switchgears where continuous or momentary paralleling of Incomers is envisaged, check synchronizing relay shall be provided.
12. Deleted.
13. The bus tie feeders in HV switchboards shall be provided with 51, 51N, 86 and 95 relays.
14. Deleted.
15. The following feeders shall be provided with timers for delayed tripping on bus under voltage while the under voltage relay shall be common for the bus
 - a. Contactor controlled motor feeders with DC control supply.
 Numerical relays where ever provided for motor and capacitor feeders shall use in built under voltage relay and timer for delayed tripping on bus under voltage.
16. One no. DC supply supervision relay (80) shall be provided for each incoming DC supply to the switchboard.
17. One set of bus differential relays (87B) and bus wire supervision relay (95 B) for each bus section shall be provided for HV switchboards connected directly to generation buses.
18. In case of numerical relays, all relays shall be comprehensive units including all protection, metering and control.
19. Under voltage and over voltage function along with associated timer shall be part of the numerical relays.
20. Auto changeover scheme control & logic between Incomers and bus coupler shall be built in the numerical relay.
21. Tripping relays (86) shall be separate relay. There shall be two nos. high speed tripping relay for motor feeder. One for electrical fault and one for process fault. Electrical fault relay shall be hand reset type and process fault relay shall be self reset.
22. Breaker control switch shall be hardwired type.
23. Stand by earth fault relay 51G shall be provided in the incomer of switchboard fed from transformers where transformer & switchboard both are located remotely from HV substation as well as in same HV substation.
24. Deleted.
25. Deleted.
26. Relay 87 and 64R shall be separate numerical relay. Hence shall not be part of main comprehensive numerical relay. CT for 87 and 64R can be clubbed, as two core of single CT.
27. Accuracy class of the current transformers shall be
 - Class PS for differential and special requirements.
 - Class 0.5 /0.2 S (for Incomers only) for metering purpose.
 - Class 5P20 for protection purpose
 All the CTs shall have rated burden of minimum 15 VA and secondary rated current of 1 A.
28. Accuracy class of the potential / voltage transformers shall be
 - Class 5P for protection purpose.

	EMERGENCY DIESEL GENERATORS PACKAGE TALCHER FERTILIZERS LIMITED TECHNICAL SPECIFICATION – ELECTRICAL	PC183/E/4022/SecVI-3.1	0	
		Document No.	Rev	
		Sheet 26 of 68		

- Class 0.5 / 0.2(for Incomers only) for metering purpose.

All the PTs shall have secondary voltage 110 V or 110 V / sqrt.3 and rated burden of minimum 50 VA per phase for both metering and protection core.

29. All the incoming, outgoing and tie breaker feeders of any HV, MV & LV Switchboard shall be provided with numerical relays only with communication facility as protection devices. Releases shall not be acceptable in any case.
 30. Numerical relays in all HV motor feeders shall be suitable for RTD / BTD inputs.
 31. Each bus section shall be provided with separate under voltage relays.
 32. Multifunction meter shall be provided to keep a record of power consumption and supervision of all concerned parameters like current, voltage, power, frequency, power factor etc. as specified. All the metering instruments shall be flush mounted.
 33. Separate Communicable Digital Multifunctional meters shall be provided in all feeders with Numerical Relays for communication with ECMS system.
 34. Motors shall also be provided with Unbalanced (-Ve) Sequence Protection Relay (46), as required.
 35. Numerical under voltage relays (27) with time delay relay including VT fuse failure relay shall be provided for Bus VTs.
 36. All Motor feeders of PMCC & MCC (irrespective of Rating) shall have door mounted communicable (Modbus) type Motor Protection relay (MPR) with display.
 37. No Meters, transducers or measuring equipments to be installed in the Protection CT circuit.
 38. All required Alarms and Trips shall be incorporated in the Numerical relays. Sufficient LED shall be available in the Relays.
 39. Trip Circuit Supervision relay shall be part of Numerical relay.
 40. Auxiliary Relays shall not be part of Numerical Relay.
- 7.30 Metering instruments shall be provided to keep record of power consumption and supervision of all concerned parameters like current, voltage, power (Active, Apparent and Reactive), frequency, power factor, Energy (Active & Reactive) etc. All the instruments shall be flush mounted. All meters shall be digital multifunctional meters with communication port for Load management at remote location. Additionally digital type ammeter, voltmeter and Hour Meter shall be provided separately for various feeders as indicated below :

The metering devices in HV and MV switchboards shall be as below:

- Type of metering: Analogue/As part of the Numerical relay
(Figure inside bracket refers to note below) (YES - Applicable)

Sl. No.	Feeder type	A	V	Hz	PF	MW	MWH	HM	MVAR	MVAH	MVA
1.	HV Incomer	YES	YES	YES	YES	YES	YES	----	YES	YES	YES (1)
2.	HV Bus Tie	YES	----	----	----	----	----	----	----	----	----
3.	HV Transformer	YES	----	----	----	YES	YES	----	----	----	----
4.	HV Bus PT	----	YES	----	----	----	----	----	----	----	----
5.	HV Plant Feeder	YES	----	----	----	----	YES	----	----	----	----
6.	HV Motor	YES	----	----	----	----	YES (kWh)	YES	----	----	----
7.	HV Capacitor	YES	YES	----	----	----	----	----	YES	----	----
8.	PMCC Incomer	YES	YES	----	YES	----	YES (kWh)	----	----	----	----
9.	PMCC Bus Tie	YES	----	----	----	----	----	----	----	----	----
10.	PMCC Bus PT	----	YES	----	----	----	----	----	----	----	----
11.	ACB Outgoing (Non Motor)	YES	----	----	----	----	YES (kWh)	----	----	----	----
12.	MV Motor (>55 KW)	YES	----	----	----	----	----	----	----	----	----
13.	MCC / ASB Incomer	YES	YES	----	----	----	----	----	----	----	----
14.	MCCB O/G	YES	----	----	----	----	YES	----	----	----	----

	EMERGENCY DIESEL GENERATORS PACKAGE TALCHER FERTILIZERS LIMITED TECHNICAL SPECIFICATION – ELECTRICAL	PC183/E/4022/SecVI-3.1	0	
		Document No.	Rev	
		Sheet 27 of 68		

	(250A and above)						(kWh)				
15.	MLDB Incomer	YES	YES	----	----	----	YES (kWh)	----	----	----	----

Notes for Metering:-

1. MVA meter in external power supply incomers shall include maximum demand indication also.
2. Separate analogue type voltmeters with voltmeter selector switch and analogue type ammeters with ammeter selector switch shall be provided for incomers of all switchboards.
3. Ammeter (size 48mm x 48mm) shall be provided in space heater circuit of breaker fed HV & MV motors.
4. Apart from metering which shall be part of the numerical relays, Communicable digital multi-function meters of Accuracy Class 0.5 with suitable Metering CT shall be provided in all the breaker feeders of HV & MV Switchboard i.e. in incomers, bus coupler, outgoing plant feeders, transformer feeders, motor feeders, capacitor bank feeders, etc.
5. Multi function meters with serial communication over RS-485 or fiber optic cable, preferably with IEC protocol shall be provided in all the breaker feeders.
6. Power factor meter shall be provided for synchronous motors in addition to the metering provided for induction motors.
7. For current feedback to DCS/PLC and VFD feeders motor current transducers shall be provided and mounted in switchgear panel.
8. CT operated Ammeter for all motor feeders above 5.5 KW, all MOV and LOPs shall be provided at both LCS and feeder end of switchboard.
9. All ammeters for LV motors shall be connected through CT. Only HV motors shall have 3 ammeters or ammeter selector switch or Voltmeter and Voltmeter Selector Switch.
10. Hour run meter shall be provided in all breaker controlled motor feeder.

8.0 CONTROL AND MONITORING

The following provision shall be made for control and monitoring of following electrical equipments.

8.1 Medium Voltage Motors Controlled Through Contactors

- Start & Stop Push Button (Mushroom Stay Put Type) with Ammeter, Local/Remote switch on LCS.
- Current monitoring in DCS, where required from process point of view.
- Emergency Trip in PMCC/MCC.
- Process interlock in CCR, where required shall be wired through separate auxiliary relay.
- Indication lamp for 'ON', 'OFF', 'Ready to Start' and 'Fault' in switchgear.
- Control and Feedback for Motor Start & Stop command, Trip Indication, ON Indication, OFF Indication, Local / Remote Indication and Ready to Start Indication in remote (DCS/PLC etc.)
- Motor space heater & Panel board space heater shall be provided with Ammeter & LED in Switchgear.
- All Motor feeders of PMCC & MCC (irrespective of Rating) shall have door mounted communicable (Modbus / Profibus) type Motor Protection relay (MPR) with Earth fault protection and display.

9.0 EQUIPMENT SPECIFICATION

	EMERGENCY DIESEL GENERATORS PACKAGE TALCHER FERTILIZERS LIMITED TECHNICAL SPECIFICATION – ELECTRICAL	PC183/E/4022/SecVI-3.1	0	
		Document No.	Rev	
		Sheet 28 of 68		

9.1 General Features

9.1.1 The equipment shall be suitable for tropical climate conditions and corrosive and saline atmosphere.

All electrical equipment accessories and wiring shall have fungus protection involving special treatment of insulation and metal against fungus, insects and corrosion.

Fine mesh screen of corrosion resistant material shall be furnish on all ventilating openings to prevent entry of insects.

9.1.2 The DG sets shall be procured as a complete package and shall be designed to start automatically on power failure and feed the selected loads. EDG start command shall be issued from Owner's 11kV switchgear in case of power failure. It shall be capable of taking care of the load variations. The unit shall be complete with necessary starting equipment associated control panel (AMF) and shall be suitable for remote starting.

9.1.3 The equipment to be installed in indoor plant area shall be enclosed in dust, damp and vermin proof enclosure equivalent to IP 54 as per relevant Indian Standards/IEC.

9.1.4 4 mm FRP (fire retardant and UV stabilized) canopies shall be provided for all outdoor equipments like motors, starters, LCS, SDBs, sw. sockets etc. PA stations shall have acoustic hood.

9.1.5 The switch boards, to be installed inside the building shall have enclosure IP 4X for HV switchgear, for LV switchgear degree of protection shall be IP 52 up to 1600A rating and IP-4X above 1600A rating. Equipment requiring ventilation opening such as battery charger/UPS etc. located in air conditioning room may have IP 43 enclosure however, opening for the ventilation shall be covered with fine wire mesh.

9.1.6 Creepage distance shall be 31mm/kV (for highest system voltage) for all equipment.

9.1.7 All the electrical equipment shall be provided with rolled aluminium/stainless steel heavy duty double compression type cable glands and crimping lugs for the cable terminations

9.1.8 The outside surface of all equipment shall be painted after suitable pre-treatment by the application of two coats of anti-rust and corrosion resisting epoxy based paints.

9.1.9 All similar equipment (viz. HV Switchboard, LV Switchboard – PCC, PMCC, MCC, EPMCC, ASB, LDB, DCDB, Transformers, Numerical relays, UPS, Battery Chargers, Motors, etc.) supplied against a package should be of single Make only – for ease of O&M and spare management.

9.2 DG SET

9.2.1 In order to meet the requirement of total emergency loads – 3 DGs will be synchronised and run in parallel. There should be a complete system (PLC based or Microprocessor based) to take care of the load sharing and Mode control of the DG sets.

9.2.2 DG Sets, Diesel Day tanks and associated switchgears shall be located at a minimum safe distance from substations and hazardous areas as per relevant IS/IEC of hazardous area classification. Emergency power from DG Set shall cater to:-

- (a) Loads of emergency shut down
- (b) Essential loads
- (c) Loads of emergency and aviation lighting
- (d) UPS Loads
- (e) Battery Charger & DCDB Loads
- (f) Any other load recommended by the Contractor for proper and safe operation & control of the facilities under the package.

	EMERGENCY DIESEL GENERATORS PACKAGE TALCHER FERTILIZERS LIMITED TECHNICAL SPECIFICATION – ELECTRICAL	PC183/E/4022/SecVI-3.1	0	
		Document No.	Rev	
		Sheet 29 of 68		

- 9.2.3 The DG Sets control shall have PLC/microprocessor based latest state of art technology. Brushless excitation system shall be used in generator.
- 9.2.4 The starting of engine of DG Sets shall be electric type. System should be capable of minimum 3 starts.
- 9.2.5 DG sets shall have auto starting arrangement with manual switching off features. Fail to start annunciation shall be provided, in case the engine fails to start.
- 9.2.6 DG Set shall have all its auxiliaries installed and controlled from same place. The control of DG Set shall be based on 110 V DC which shall be supplied from the DC panel. Separate DC battery bank with battery charger shall be provided for control supply. Starting Battery and Battery Charger for DG shall be separate.
- 9.2.7 Separate MCC for auxiliaries of 3 DGs shall be provided.
- 9.2.8 There shall be a separate control panel per DG to control the auxiliaries, and comprehensive alarm and fault indication system shall be provided to indicate the status of auxiliaries as well as Diesel Generator Set, System battery charger etc.
- 9.2.9 The maximum starting and synchronising time of Sets shall be 20 seconds even after 3rd attempt and shall be able to take full load within 30 seconds. The DG power shall be made available within such a period that none of the plant unit is affected due to failure of normal power. Contractor shall submit during detailed engineering, the calculation for 'Time to start' Indicating break up of time for voltage build up 100% loading in steps as required.
- 9.2.10 The auxiliary power supply board to feed the auxiliaries of DG Sets shall have dual power supply, one from the normal power supply source of plant and other from the DG Set itself with the provision of changeover in the incoming supply in auto mode as well as manual mode.
- The incomers and larger rated feeders shall be provided with air circuit breakers and Numerical relays. The feeders of smaller ratings shall be provided using MCCBs. A comprehensive electrical protection system shall be provided to protect the incomer as well as outgoing feeder. The incomer shall have a KWH meter, ammeter, voltmeter etc.
- 9.2.11 The Emergency Power Distribution Board shall be kept in a separate room near to engine room of DG Sets.
- 9.2.12 When only three DG sets shall be in operation and no other source connected in the system, all DGs shall share load among each other. Contractor shall provide necessary control for the same. However, while DG sets shall be in parallel with other sources, the load sharing and control shall be by Synchronisation Panel as well as ECMS.
- 9.2.13 Anti-condensation Space Heater with thermostat shall be provided for Alternator, Exciter, Generator control panel and Battery charger.
- 9.2.14 There shall be a separate control panel to control the auxiliaries, and comprehensive alarm and fault indication system shall be provided to indicate the status of auxiliaries as well as Diesel Generator Sets.
- 9.2.15 DG Set shall be supplied with day oil storage tank, associated piping, valves, accessories, earthing of all equipment and power and control cables as required.
- 9.2.16 Emission from DG Set shall meet the requirement of Latest Local Pollution Norms.
- 9.2.17 DG Set shall be provided with suitable acoustic enclosure to restrict the noise level to 85 dB at 1 metre.
- 9.2.18 Synchronization panel shall be provided for synchronization of all DGs. Also DG shall be synchronized with GRID power to operate in parallel running mode.
- 9.2.19 Complete System shall be separate for each DG Set. Only Emergency Power Distribution Board shall be Common.

	EMERGENCY DIESEL GENERATORS PACKAGE TALCHER FERTILIZERS LIMITED TECHNICAL SPECIFICATION – ELECTRICAL	PC183/E/4022/SecVI-3.1	0	
		Document No.	Rev	
		Sheet 30 of 68		

9.2.20 Following signals for Emergency DG system shall be taken through hard wired/ communication to ECMS in addition to various Electrical parameters viz. KW, KVAR, PF, etc.

- DG Set breaker ON/OFF status
- Auto/Manual switch position status
- DC control supply failure
- Tripped on fault
- Generator voltage & current
- DG set run hours
- Number of starts & number of consecutive starts (i.e. DG set auto start blocked due to exhaustion of consecutive starts)
- Day tank diesel level

9.2.21 The power rating of the DG set / Genset is the net exportable power output available at the alternator terminals, at ambient design conditions, after deducting the electrical power consumed by the essential / independent auxiliaries, losses etc.

9.2.22 PLC based or advanced software based Control Panel

DG Relay & Control Panel shall have following features:-

All Protection, control, monitoring, measurement, annunciation of the Generator. However, the all Alarm & trip indication and monitoring shall be extended to ECMS as well as DCS.

- i. All protection alarms shall also be provided in separate hardwires annunciator in the Panel room.
- ii. This Control Panel shall have the following facility as a minimum :
 - a) Digital Display: Power (MW), Voltage, current, Frequency, Power factor, Field Voltage, Field Current.
 - b) Indication: AVR Position (auto, manual, max position, min position etc.), Excitation status (On, Off, Trip, Ammeter etc.), MVAR / PF control status (On, Off, Trip), Generator Cooling status, Indications for Generator circuit breaker (Close, open, service and auto trip).
 - c) Protection: as mentioned elsewhere, Winding temperature high alarm, Bearing temperature high alarm, Stator over-load alarm, Oil temperature high alarm, oil level low alarm, Auxiliary protection relay.
 - d) Control: Control for AVR (Raise/lower selection switch for voltage), Control for excitation (Raise/lower selection switch for field current), Control for Governor (Raise/lower selection switch for speed), Control for PF/ MVAR (Raise/lower selection switch).
- iii. An electronic trivector meter shall be provided in generator control panel to measure KWH, KVARH, KVAH and maximum demand in KVA of accuracy class 0.2
- iv. All above metering parameters shall be made available in DCS System / ESMS. Necessary transducers shall be provided and mounted in Control panel.
- v. Any other requirement, which felt necessary for Generator protection / monitoring shall also be provided.

The PLC/Microprocessor shall have event logging with 10 ms resolution to diagnose the fault in case of any failure.

9.2.23 For all other specification refer PC183-TS-0839.

9.3 Uninterruptible Power Supply System (UPS)

9.3.1 240 V AC UPS System with UPS Distribution Board shall be provided to feed PMCC & MCC control supply, Control Room & Substation lights, ECMS Equipment, Fire Detection & Alarm System etc. This UPS System along with associated Battery and UPS distribution Board shall be located at Panel Room Block Diagram of UPS System shall be followed. 240 V AC UPS System complete with Battery, UPS Distribution Board etc. shall be separate.

	EMERGENCY DIESEL GENERATORS PACKAGE TALCHER FERTILIZERS LIMITED TECHNICAL SPECIFICATION – ELECTRICAL	PC183/E/4022/SecVI-3.1	0	
		Document No.	Rev	
		Sheet 31 of 68		

- 9.3.2 240 V AC UPS shall have with 20% margin for future use.
- 9.3.3 240 V AC UPS with UPS Distribution Board and Battery Bank shall be provided for Panel Room.
- 9.3.4 The UPS System shall have IGBT type with touch screen LCD display and shall be backed up by nickel cadmium (Ni-Cd) battery rated for 2 hour at rated capacity of the UPS. Battery (100% Capacity) shall be separate for each Inverter.
- 9.3.5 UPS system construction shall be such that each charger, inverter module can be made fully isolated for maintenance. No common devices/wiring shall be installed. Further there shall be no common device between main & redundant units (e.g. master oscillators etc.) in order to ensure that the failure of the same does not cause shutdown of more than one unit.
- 9.3.6 UPS system shall have facility for built in Online battery bank monitoring & testing facility for displaying/calculating expected battery bank back-up time (during testing if battery bank does not have sufficient back up time, test shall be terminated & load shall be shifted to charger automatically).
- 9.3.7 UPS shall be suitable for 100% step load.
- 9.3.8 Battery Load cycle test shall be carried out by the vendor at site .
- 9.3.9 The UPS rating shall be such that in any case the load on the individual UPS shall not exceed 70% (after considering 20% future margin) of the rated capacity.
- 9.3.10 UPS Configuration shall be as per attached Block Diagram.
- 9.3.11 The over load capacity of UPS shall be 200% for 10 cycles, 150% for 60sec & 125% for 10min.
- 9.3.12 All four sections, i.e. Rectifier-I, Rectifier-II, Bypass – I and Bypass - II shall be fed through four separate feeders of emergency bus of PMCC.
- 9.3.13 UPS shall be PWM based using IGBT. Each charger and SCVS shall have isolating transformer at the input.
- 9.3.14 The salient features of the UPS shall be as under:
- a) High Efficiency
 - b) Compatible to feed nonlinear, high crest factor loads
 - c) Microprocessor based monitoring system for UPS status and fault indications
 - d) High transient performance
 - e) Low audible noise
- 9.3.15 Each UPS shall be provided with SNMP software so that all the parameters of UPS and alarms/faults can be viewed into the remote computer. These logs/trends of load can later be printed. Web based parameter and status monitoring shall be used. It shall be hooked to ECMS and DCS System.
- 9.3.16 The transfer time of UPS from inverter to bypass, in case of failure of both inverters, shall be so selected that during this transition period, instrumentation/DCS etc. which leads to tripping of plant shall not fail. Typically, it shall be as below :
- In synchronism : No break transfer i.e. within 6 milliseconds (Maximum)
- In asynchronous mode : Within 16 milliseconds (Maximum).
- 9.3.17 The technical parameters of UPS shall be as under:
- Input**
- a) Rated Voltage 415 V \pm 10%
 - b) Rated Frequency 50 Hz \pm 5%

	EMERGENCY DIESEL GENERATORS PACKAGE TALCHER FERTILIZERS LIMITED TECHNICAL SPECIFICATION – ELECTRICAL	PC183/E/4022/SecVI-3.1	0	
		Document No.	Rev	
		Sheet 32 of 68		

Output

a) Rated Voltage 115 V AC / 240 V AC

Voltage regulation:

Static (0-100% load) $\pm 1\%$

Dynamic for 100% load change: $\pm 5\%$

9.3.18 Following potential free contacts shall be made available on the UPS,

- Rectifier ON
- Inverter ON
- Battery CBB ON
- Load on Inverter
- Inverter fail
- Rectifier Fail
- Inverter O/P undervoltage
- Inverter Sync.
- Load on battery
- Bypass Fail
- Load on bypass
- Load transferred. etc

Note: A separate common potential free contact for all the faults/alarms (in UPS / SCVS) shall be made available

9.3.19 Operation Philosophy of UPS:

- 2 sets of rectifiers and inverter shall be provided. Under normal conditions, when AC mains power is available, both the rectifiers shall operate in parallel and supply DC power for float/rapid charging the 2X50% batteries and simultaneously to inverters. In case of failure in one rectifier, the other rectifier shall feed the complete load and the batteries without any interruption.
- In case of Incoming supply failure or failure of both rectifiers the 2X50% batteries shall feed the inverters without any interruption. Each rectifier shall be designed for simultaneously feeding complete inverter load and float/rapid charging of the 2X50% batteries to its rapid capacity. Each rectifier shall be equipped with “ On Line” automatic as well as manual charging facility.
- Normally both the inverters will be synchronised with each other and with stabilised bypass supply. Both inverters shall operate in parallel and share the load equally.
- The load sharing controls shall not be subject to common mode failure and any failure of the load sharing controls shall not result in the loss of the vital power.
- When a disturbance/fault occurs in any of the inverters, the faulty unit shall automatically get disconnected and the entire load shall be fed from the other inverter without interruption.
- In case both the inverters develop a fault, the complete load shall be transferred to stabilized bypass supply through the static switches and retransfer of the load from the stabilized bypass supply to the inverter shall be possible in auto as well as in manual mode without interruption.

9.3.20 All alarms & status of UPS shall be communicable through Modbus / Ethernet protocol to ECMS.

Following minimum shall be considered:

- Load on Inverter
- Load on Bypass

	EMERGENCY DIESEL GENERATORS PACKAGE TALCHER FERTILIZERS LIMITED TECHNICAL SPECIFICATION – ELECTRICAL	PC183/E/4022/SecVI-3.1	0	
		Document No.	Rev	
		Sheet 33 of 68		

- Load on Battery
- Battery on float/ boost charging mode.
- Charger failure.
- Inverter failure
- AC mains failure
- DC under voltage
- DC Over voltage
- Automatic retransfer of load to inverter inhibited.
- Fan failure
- AC Voltage , current & frequency of each inverter
- AC incoming power supply Voltage & voltage.
- DC current at each rectifier output.

9.3.21 For all other specifications, refer PC183-TS-0802.

9.4 Neutral Earthing Resistor (NER)

9.4.1 The NER shall be provided to earth the neutral of 11 kV. Neutral of 415V supply system shall be solidly earthed.

9.4.2 Neutral earthing resistor shall be outdoor type made of AISI 304/406 punched stainless steel grid element. The earth fault current of 11 kV shall be limited to current rating as per OEM Recommendation, for 30 Seconds.

9.4.3 All NER not requiring operation shall be provided with vacuum Contactor.

9.4.4 For all other specification refer PC183-TS-0804.

9.5 Switchboards

9.5.1 General

9.5.1.1 There shall be three positions for Breaker/Contactor trolley: - Service, Test and Isolate. In service position, the power connections shall be made; but in test and isolate mode, the power connection of bus bars shall be automatically removed.

ACB feeder for PCC, PMCC & MCC shall be single front for ease of operation & maintenance. Non-ACB feeders for motors or power may be double front type.

Breaker duty cycle shall be O-0.3sec-CO-3min-CO.

Separate CT shall be provided for differential/REF protection.

LV circuit breaker shall be 4 Pole type except for outgoing motor feeders which shall be 3 Pole type.

9.5.1.2 Suitable shutter arrangement shall be provided to protect the person from accidental contact with live bus in trolley chamber.

9.5.1.3 The degree of protection shall be IP 4X for HV switchboards and IP 52 for LV Switchboard up to 1600A rating and IP-4X for LV switchboards above 1600A rating.

9.5.1.4 All HV, MV & LV Switchboards shall be LOTO compliance.

9.5.1.5 11 kV Switchboard shall conform to IS/IEC 62271-200, IAC-A FLR-50KA/40KA 1 Sec, PM, LSC 2B which means that the switchgear panels shall be four side internal arc tested, shall have metal partitions and shall confirm to loss of service continuity. LV switchboard shall conform to IEC 60947. All 3 compartments (Busbars, Circuit breaker & Cable compartment) shall be tested for Internal arc for the said rating.

9.5.1.6 LV switchboard (EPMCC/PMCC/MCC) shall be TOTAL TYPE TESTED (TTA) design as per IEC 61439-1/2. Type Test Certificates for short circuit withstand of 50kA for 1 sec along with ACB mounted in the Switchboards shall be provided.

	EMERGENCY DIESEL GENERATORS PACKAGE TALCHER FERTILIZERS LIMITED TECHNICAL SPECIFICATION – ELECTRICAL	PC183/E/4022/SecVI-3.1	0	
		Document No.	Rev	
		Sheet 34 of 68		

- 9.5.1.7 LV switchboard (EPMCC/PMCC/MCC) shall comply with Internal Arc Containment test as per IEC 61641.
- 9.5.1.8 The busbars and connection shall be made of electrolytic grade copper only. Aluminium busbars are not acceptable. All busbars of 11kV switchgear including bus duct shall have Raychem sleeving.
- 9.5.1.9 Tripping and closing coils shall be of continuous rating type.
- 9.5.1.10 Clearance between gland plate to cable termination point in all switchboards shall be adequate but not less than 300mm to ensure proper cable termination.
- 9.5.1.11 FRP supports shall be used for bus bars with adequate clearances and creepage distance to prevent flash over due to effect of dust moisture.
- 9.5.1.12 Protective relays shall be mounted on the front of the switchgear panel.
- 9.5.1.13 All logic like, Auto/Manual changeover etc. shall be build in the Numerical relay. Adequate number of I/Os shall be provided to meet the requirement. 10% spare I/Os shall also be provided. External I/O Card/ Module is not acceptable.
- 9.5.1.14 All relays used for protection shall be microprocessor based numerical type only with latest communication protocol IEC-61850 and shall have large graphical display. All relays shall have coating for protection against harsh environment conditions. All numerical relays shall be of one make only. Selected models of numerical relays shall have metering, control, status and protective functions. It shall be possible to save minimum 5 records of each event.
- 9.5.1.15 Contractor shall supply minimum 1 No. laptops with licensed software for communication & configuration of all make & Type of Numerical Relays.
- 9.5.1.16 GPS system and associated hardware & software shall be provided for synchronisation of clocks of numerical relay and metering LA & ECMS
- 9.5.1.17 All meters shall be digital multifunctional meters with backlight LCD display and communication port. Additionally digital type ammeter, voltmeter and Hour Meter shall be provided separately for various feeders as indicated above.
- 9.5.1.18 All the motor / capacitor feeders controlled through vacuum circuit breakers shall be provided with surge arrestors. Lightning Arrestor (LA) shall be provided on each bus of 11KV Switchboard.
- 9.5.1.19 A continuous ground bus shall be provided at the bottom of the switchgear and in cable connection side for grounding the switchgear, breaker trolley as well as to ground the cable glands.
- One no. breaker handling trolley shall be provided for the switchboards as below:
- a) Each HV switchboard.
 - b) Each LV switchboard.
- 9.5.1.20 11KV Breaker shall be with Integral Earthing switch system with proper interlocks.
- 9.5.1.21 Control supply bus and space heater supply bus-bars (Copper) of adequate rating shall be provided throughout the length of switchboards with as many sections as sections in power bus-bars.
- 9.5.1.22 Control supply shall be tapped from control bus in each cubicle/ panel itself through DP MCB of suitable rating.
- 9.5.1.23 The minimum thickness of sheet steel used in HV and LV switchgear including charger, UPS, ASPB etc. shall be as under:-
- a) Base Channel minimum 3.0 mm
 - b) Load Bearing Members minimum 2.0 mm

	EMERGENCY DIESEL GENERATORS PACKAGE TALCHER FERTILIZERS LIMITED TECHNICAL SPECIFICATION – ELECTRICAL	PC183/E/4022/SecVI-3.1	0	
		Document No.	Rev	
		Sheet 35 of 68		

c) Doors and covers minimum 1.6 mm

- 9.5.1.24 A bottom channel of not less than 100 mm shall be provided.
- 9.5.1.25 The maximum height of the switchboard and other control panels shall be limited to 2200 MM. Maximum height of component requiring operation shall be limited to 1800MM.
- 9.5.1.26 The short time rating of bus bar shall be 3 seconds for HV switch boards and 1 second for other boards.
- 9.5.1.27 For other boards (PMCCs, MCCs, MLDBs, ASPBs, DCDBs etc.) sufficient number of spare feeders to the extent of min. 20% for each type & rating shall be provided.
- 9.5.1.28 The 415V switch boards shall have PVC insulated bus bar system suitable for rated voltage. At joints of these bus bars removable shrouds shall be provided.
- 9.5.1.29 All HV & LV Switchgear, UPS, Battery Charger etc. shall have Network Switches and other communication equipments in each Bus.
- 9.5.1.30 Separate marshalling panels (with 20% spare terminals) shall be provided on each bus section in all HV & MV switchboards in the same panel line-up. The marshalling panels shall be of full height same as that of switchboards. The horizontal bus bar chamber at the top shall be continuous through this marshalling panel also, for future extension of the MV switchboard. All critical control signals for interface shall be hardwired between Panel and ECMS, AMF etc.

Hardwired signals (with minimum requirement specified below) from various Motor feeders of a bus section shall be wired and terminated in the marshalling cabinet :

- Start permissive
 - Start command (Auto)
 - Remote Start command (Manual)
 - Stop command
 - Trip command (for breaker controlled motor feeder)
 - Breaker/Contactor 'ON' indication
 - Breaker/Contactor 'OFF' indication
 - Ready to Start indication
 - Electrical Fault Trip indication
- 9.5.1.31 Following monitoring signals, as a minimum, shall be taken from Panel Room to ECMS / DCS interface, through redundant MODBUS SERIAL LINK communication.
- Load Data viz. KW, PF, A, etc.
 - L/R indication
 - Trip indication
 - Electrical Fault Trip indication
 - Trip Details
 - Ready to Close/Start
- 9.5.1.32 Auto changeover scheme shall be provided for incomers and bus couplers on PMCCs/PCCs/MCCs. Under normal operating conditions, incomer-1 and incomer-2 breakers would be closed and bus coupler breaker would remain open with 'auto-manual' switch in 'auto' position. The bus coupler switch would close automatically under the following condition being fulfilled:-
- i. Either of the incoming breaker trips due to under voltage (70% or below).
 - ii. Voltage on the healthy bus is more than 80% for the set period.
 - iii. Residual voltage on the bus with no power supply comes down to 30%.
 - iv. Auto change over shall be locked on loss of power on both the incomers.
- Auto changeover shall also be provided on switchboards catering to emergency loads.

	EMERGENCY DIESEL GENERATORS PACKAGE TALCHER FERTILIZERS LIMITED TECHNICAL SPECIFICATION – ELECTRICAL	PC183/E/4022/SecVI-3.1	0	
		Document No.	Rev	
		Sheet 36 of 68		

- 9.5.1.33 Paralleling of two incoming feeders is not foreseen. However, facility for momentary paralleling shall be provided for intentional changeover without interruption of supply.
- 9.5.1.34 Every enclosure door that provides access to live parts operating at 240 V AC and above shall be mechanically interlocked with a circuit interrupting device on the supply side such that when the door is open, the equipment is de energised.
- 9.5.1.35 Separate redundant AC and DC control supply shall be provided for each Switchboard.
- 9.5.1.36 Control supply for motor feeders having MCCB in PMCC/MCC/ASB etc. and VFD panels etc. shall be feed from 240V UPS (Electrical) and motor controlled with breaker shall have 110 V DC control supply irrespective of its being HV or LV.
- 9.5.1.37 For motors with auto-starting provision, trip of a running motor shall start standby motor automatically.
- 9.5.1.38 All the HV/LV switchgear shall be fed through two separate transformers, each transformer having capability to take care of 100% load of the associated switchgear and shall have the facility of auto changeover in case of failure of one transformer as well as option of manual changeover for maintenance purpose.
- 9.5.1.39 Max. 3 runs of 400 sq.mm power HV cable shall be terminated in single panel. For more than 3 runs of cable complete dummy/adaptor panel shall be provided.
- 9.5.1.40 The CB ON and OFF lamp shall be provided at rear and front side of 11kV switchboards.
- 9.5.1.41 All breakers service ON/OFF contact multiplier contactors shall be mechanically latched type and independent of control supply. Loss of supply and restoring the supply shall not affect the status of the relay/ contactor.
- 9.5.1.42 All breakers shall be electrically operable and mechanical operation from the breaker shall be possible locally. Manual breakers are not acceptable.
- 9.5.1.43 Separate Ammeter shall be provided for panel and motor feeder Space heater circuit for each panel.
- 9.5.1.44 The terminal strips used shall be of stud and nut type and control wiring shall be done with ring tong lugs only.
- 9.5.1.45 Dual channel output with display type current transducer for all HV and LV switchboard feeder shall be provided requiring Ammeter at control panel.
- 9.5.1.46 All motor (HV/LV) power feeders shall have separate earth fault protection through CBCT and earth fault relay. LV motor (above 5.5. KW) and power feeder above 100A shall have CBCT and Digital earth leakage relay with display.
- 9.5.1.47 All external hardware shall be of stainless steel only.
- 9.5.1.48 The control compartment and power compartment shall be separate.
- 9.5.1.49 All HV and LV breakers shall have remote switching facility as well as ON/OFF/TRIP indication at ECMS.
- 9.5.1.50 Following Set of accessories as detailed below shall be provided for each 11kV Switchboard :
- a) Breaker handling trolley – 2 Nos.

Following Set of accessories as listed below shall be provided for each 415 V Switchboard :

- a) Breaker lifting and handling trolley : Minimum 2 nos.
- b) Test cabinet with coupling cables for testing the breaker in draw out position : Minimum 1 No.
- c) Racking in/out handle for breakers : Minimum 4 nos.
- d) Racking in/out handle for draw out MCC modules : Minimum 2 for each MCC

	EMERGENCY DIESEL GENERATORS PACKAGE TALCHER FERTILIZERS LIMITED TECHNICAL SPECIFICATION – ELECTRICAL	PC183/E/4022/SecVI-3.1	0	
		Document No.	Rev	
		Sheet 38 of 68		

9.5.2.4 Incoming, bus coupler and outgoing feeders shall be provided with ON, OFF, Trip, Trip Circuit Healthy indications. Process trip lamp/annunciator window to be provided wherever applicable.

9.5.2.5 Control supply shall be 110 V DC.

9.5.2.6 Extra anti-condensing space heater shall be provided in Bus –Bar and Cable chamber of 11KV Switchboard.

9.5.3 Low Voltage Switchgears

9.5.3.1 415 V switchboards shall include the following:

- a) Power Control Centres (PCCs)
- b) Power-cum-Motor Control Centres (PMCCs)
- c) Motor Control Centres (MCCs)

9.5.3.2 Low voltage switchboards shall be metal clad, arranged with self supporting units and assembled together in a row. The degree of protection shall be IP 52.

9.5.3.3 Internal physical separation / segregation of 415 V Switchboards shall be 3 B for Non-ACB feeders and 4 B for ACB feeders.

9.5.3.4 The switchboards shall be suitable for extension at both the ends.

9.5.3.5 Bus bars shall be of uniform cross section and supported on non-hydroscopic FRP insulators with adequate clearances and creepage distance to prevent flash over due to effect of dust/moisture.

9.5.3.6 The horizontal busbars as well as vertical droppers of LV switchboards shall have heat shrinkable insulated sleeves.

9.5.3.7 Sufficient bus supports shall be given to give adequate mechanical strength during short circuits.

9.5.3.8 A continuous ground bus shall be provided at the bottom in the PCC/PMCC/MCC for grounding the PCC/PMCC/MCC.

9.5.3.9 Rated short circuit breaking capacity shall be 50 KA for 1 sec.

9.5.3.10 The PMCC/MCC and auxiliary services power board shall be provided with withdraw able air circuit breakers for incoming feeders and bus ties.

9.5.3.11 All ACBs shall be electrically operated- EDO type only. Manual breakers are not acceptable. Each electrically operated breaker shall be provided with antipumping (94), Breaker fail (52BF) and trip free feature, trip annunciation (30) and lockout (86) relays. Lockout relay shall be hand reset type.

9.5.3.12 All ACBs shall be without any internal releases. The required protections shall be wired by means of external numerical relays.

9.5.3.13 Motor feeders below 75 KW rating shall be contactor controlled and 75 KW & above, these shall be ACB controlled with combined motor protection relay. All other feeders of 415 V switchboards shall be provided with MCCB except feeder rated more than 400A, for which ACB shall be provided. All outgoing feeders shall be draw-out type in all the switchboards.

9.5.3.14 Switchboards shall be provided with thermostatically controlled anti-condensation heaters.

9.5.3.15 All units in the MCC shall be completely accessible and removable from front. Both power and control connections shall be stab-in type.

9.5.3.16 Bus bar clearances shall conform to relevant Indian Standard/IEC for equipment voltages up to and including 500 V AC.

9.5.3.17 The switchboards shall be compartmentalized and individual feeder modules shall be draw-out type. Fixed type modules shall not be acceptable.

	EMERGENCY DIESEL GENERATORS PACKAGE TALCHER FERTILIZERS LIMITED TECHNICAL SPECIFICATION – ELECTRICAL	PC183/E/4022/SecVI-3.1	0	
		Document No.	Rev	
		Sheet 39 of 68		

- 9.5.3.18 The draw out modules shall be standardized and it shall be possible to interchange any module with a module of same size. The components to control the equipment like MCCB, starter, auxiliary relay etc. shall be wired as a unit on the individual module. Safety shutter shall be provided to prevent direct access to live parts when the chassis is removed.
- 9.5.3.19 The entire draw out construction should be designed for safe operation during placement or removal of chassis. An earthing arrangement shall be provided which will make contact first before the power contacts are made and break last. Each module shall control one motor in general.
- 9.5.3.20 The door shall be interlocked so that it cannot be opened unless the isolating switch on that module is OFF. However, it shall be provided with a door defect mechanism for intentional opening when on line for testing and inspection purpose.
- 9.5.3.21 Control switches for breaker control shall be provided in each breaker cubicle. Circuit breaker shall be interlocked to prevent withdrawal of a closed breaker or insertion of a closed breaker. Each breaker shall be provided with anti pumping device.
- 9.5.3.22 Provisions shall be made to manually close/trip circuit breakers on loss of control voltage.
- 9.5.3.23 The LV PMCC/MCC/PCC control supply shall be 240VAC, 50Hz UPS supply fed from UPS Distribution Board of Separate 240 V AC UPS System dedicated for MCC control supply; Control Room & Substation lights, ECMS Equipment, Fire Detection & Alarm System etc. Breaker control supply shall be 110V DC.
- 9.5.3.24 All low voltage switchboards shall be provided with 20% spare outgoing feeders or minimum one of each rating (fully wired) and with all the components.
- 9.5.3.25 The timers shall be electronic type only. Pneumatic or synchronous type timers are not acceptable.
- 9.5.3.26 Each outgoing motor feeder shall consist of a number of components mounted in a module duly wired. In general outgoing feeder rated below 75 KW shall consist of:
- a) MCCB.
 - b) Control supply On/Off switch and fuse
 - c) Power Contactor
 - d) Electronic Digital Motor Protection Relay with built-in Earth Fault, Overload, Stalling, Single phase protection, etc. Thermal Overload Relay are not acceptable.
 - e) C.T for metering
 - f) Overload reset button.
 - g) Process Trip / ON / OFF indicating lamp with separate indicator fuse.
 - h) Auxiliary contactors for multiplication / control.
 - i) Test position limit switch and test PB
 - j) CT operated Ammeter for all motor feeders above 1.5 KW, all MOV and LOPs at both LCS and Feeder end.
 - k) Selector switches as per requirement.
- 9.5.3.27 Following potential free contact shall be available for each Motor feeders for indication in ECMS in addition to process requirement:
- Motor ON
 - Motor OFF
 - Motor Process Trip
 - Motor Elect Trip

	EMERGENCY DIESEL GENERATORS PACKAGE TALCHER FERTILIZERS LIMITED TECHNICAL SPECIFICATION – ELECTRICAL	PC183/E/4022/SecVI-3.1	0	
		Document No.	Rev	
		Sheet 40 of 68		

9.5.3.28 Provision for indication of minimum following electrical parameters in 415V PCC / PMCC/ MCC shall be made:

- a) ON OFF, TRIP, TRIP CIRCUIT HEALTHY, TEST, SERVICE Position, indication in ACB feeders.
- b) The KWH meters on incomers shall have provisions for sealing for tariff purpose, as required.
- c) MCC shall conform to the following as a minimum :
 - Motor starters rated for utilisation category AC3 and protection equipment with a minimum of type 2 co-ordination.
 - The number of modules per tier shall not exceed 6.
 - MCC incomer sizes and configurations rationalised to minimise spares holdings.

9.5.4 Auxiliary Supply Power Board

The ASPB shall generally be single front, floor mounted draw out type having essential and non-essential bus. Non-essential bus shall be disconnected in case of failure of normal supply through a contactor. Each Substation station shall have separate ASPB.

9.5.5 Lighting Sub Distribution Boards

The Distribution Boards shall be single front, non-draw out wall mounted type.

9.5.6 UPS Distribution Boards

9.5.6.1 The UPS Distribution Boards shall be single front, floor mounted non-drawout type for supply of 240 V AC.

9.5.7 Direct Current Distribution Boards

9.5.7.1 The Direct Current Distribution Boards (DCDBs) shall be single front, floor mounted non-drawout type for supply of 110 V DC control power to switchgears and panic lighting.

9.6 Motors

9.6.1 The rating of LV and HV motors shall be selected from the sizes as recommended in relevant Indian Standard/IEC.

9.6.2 All electric motors shall meet the standard IEC 60034-30-1.

9.6.3 The margin between the installed power and absorbed power shall be as recommended by the driven machine supplier but shall not be less than the following:-

Motor Rating	Margin above Driven M/C Absorbed Power
Less than 22 KW	25%
22 KW to 55 KW	15%
75 KW and above	10%

9.6.4 Voltage Ratings:

Voltage rating for the motors of different ratings shall be as below:

Upto 150 KW: 415 V, 3-phase, 50 Hz AC

All motors shall be designed for 3-Phase supply only.

9.6.5 The motors shall have maximum continuous rated duty S1 as per relevant Indian Standard/IEC. Rated duty for special duty motors wherever required e.g. cranes etc. Shall be considered as per driven equipment requirement.

	EMERGENCY DIESEL GENERATORS PACKAGE TALCHER FERTILIZERS LIMITED TECHNICAL SPECIFICATION – ELECTRICAL	PC183/E/4022/SecVI-3.1	0	
		Document No.	Rev	
		Sheet 41 of 68		

- 9.6.6 All LV motors shall be TEFC type as per relevant Indian Standards/IEC while HV motors shall be TEFC/CACA type. All motors shall be Class-F insulated with temperature rise limited to that of Class-B.
- 9.6.7 Normally the motors shall be suitable for DOL starting. However, motors started through VFD shall be suitable to run at 30% to 100% of rated speed and compatible with the VFD.
- 9.6.8 All motors 30 KW and above shall have space heater provision.
- 9.6.9 All HV motors shall have winding, hot air and bearing RTDs. All the temperature signals shall be terminated to DCS as well as ECMS.
- 9.6.10 All LV motors shall be of efficiency class 'IE3' as per latest applicable version of IS: 12615. All HV Motors shall be of high efficient and high power factor type.
- 9.6.11 The starting current i.e. breakaway current of 415 V Motors shall not exceed the values indicated in IS: 12615. Also there shall be no further positive tolerance on the values of of starting current.
- 9.6.12 The starting current of 3.3 KV motors shall not exceed 550% of FLC. No positive tolerance is acceptable over 550% FLC.
- 9.6.13 Type test certificate of similar motor for use in specified hazardous area (if applicable) shall be furnished.
- 9.6.14 The duty cycle of the motor shall meet the process and driven machine requirement.
- 9.6.15 In case of 3.3 KV motor, the terminal box shall be suitably designed for proper termination of XLPE insulated Aluminium cables through heat shrink termination kit.
- 9.6.16 The mechanical parameters such as duty, mounting type, shaft extension, direction of rotation, starting torque requirements etc. shall be adequate for the application. Sleeve or anti friction type bearings shall be used. Vertical motors shall have thrust bearings suitable for the load imposed by the driven machinery. Motors with sleeve bearings may require proximity probes to measure shaft vibration adjacent and relative to the bearings.
- 9.6.17 Motor rated above 30 KW shall have on line greasing provision and for motor rated above 45 KW, grease outlet feature shall be provided.
- 9.6.18 All HV motors shall have safety factor not less than 1.1.
- 9.6.19 Motors rated 1000 kW and above shall have suitable measures to prevent flow of shaft currents and shall have 2 sets (i.e. 6 nos.) of PS class CTs for differential protection.
- 9.6.20 The motor shall be capable of withstanding the electro dynamic stress and heating imposed if it is started along with the driven equipment at voltage of 110% of the rated value.
- 9.6.21 During starting of large motor, the voltage may drop to 80% of the rated voltage for a period of 60 seconds. All electrical equipment, while running, shall successfully ride over such period without affecting system performance.
- 9.6.22 D.C. motor provided for emergency service shall be shunt/compound wound type. Motor shall be sized for operation with fixed resistance starter for maximum reliability.
- 9.6.23 DC starters shall be complete with MCCB, contactors, resistors, relays, meters, push-buttons, lamps, etc. DC contactor shall be Class I – Category DC3. Switch Duty shall be DC22. The resistor enclosure shall be provided with ventilating louvers and wire mesh guard and shall have a degree of protection IP-23.
- 9.6.24 The motor may be subjected to sudden application of 150% rated voltage during bus transfer, due to the phase difference between the incoming voltage and motor residual voltage. The motor shall be designed to withstand any torsional and/or high current stresses, which may result, without experiencing any deterioration in the normal life and performance characteristics.
- 9.6.25 Shaft voltage shall be limited to 200 mV.

	EMERGENCY DIESEL GENERATORS PACKAGE TALCHER FERTILIZERS LIMITED TECHNICAL SPECIFICATION – ELECTRICAL	PC183/E/4022/SecVI-3.1	0	
		Document No.	Rev	
		Sheet 42 of 68		

9.6.26 For all other specifications, refer PC183-TS-0810.

9.7 Rectifier-cum-Battery Charger

9.7.1 The Rectifier-Cum-Battery Charger shall be fully automatic using silicon controlled rectifier and shall consist of units as described below:-

- i) Main Float cum Load charger: To supply continuous load and keep the battery in healthy state.
- ii) Standby Float cum Load charger: To supply continuous load & keep the battery in healthy state in case any abnormality in Main charger.
- iii) Boost charger: To charge the battery set initially and recharge (after meeting emergency or sudden application of heavy loads.)

9.7.2 Battery Charger shall have at least 20% extra capacity for future load requirement. Battery Charger shall have 110 V DC system.

9.7.3 Each substation shall be provided with redundant battery charger with 2x100% battery banks and connected to each Charger.

9.7.4 The battery and charger combinations shall be such as to ensure continuity of D.C. supply at load terminals without even momentary interruption.

9.7.5 AC Ammeter and AC Voltmeter on Charger Input; DC Ammeter, DC Voltmeter for charger output/ battery voltage and on demand type Battery Charge / Discharge Ammeter shall be provided.

9.7.6 Following analog signals through suitable transducer shall also be provided for hook-up in ECMS:

- Status of charging current (float & boost charging)
- Battery current
- Incoming voltage

9.7.7 Following potential free contacts shall also be provided for hook-up in ECMS

- DC under voltage
- DC overvoltage
- DC earth leakage
- AC incoming power supply failure
- AC input fuse blown-off
- Thyristor/ diode failure
- DC output fuse blown-off
- DC battery fuse blown-off
- Filter Capacitor fuse blown-off
- Load on Battery (using current direction sensing with time delay)
- Battery undervoltage/ Disconnected during discharge (using zero current sensing)
- Cubicle fan failure/ cubicle temperature high (for chargers with forced cooling).

9.7.8 For all other specifications, refer PC183-TS-0813.

9.8 Battery Sets.

9.8.1 These shall be Ni-Cd Battery Sets shall be rated to meet the total DC power requirement for 5 hour after complete power failure.

9.8.2 Spare capacity of 20% for future use shall be considered.

9.8.3 Battery shall be designed with minimum temperature as 50C.

9.8.4 For all other specifications, refer PC183-TS-0814.

	EMERGENCY DIESEL GENERATORS PACKAGE TALCHER FERTILIZERS LIMITED TECHNICAL SPECIFICATION – ELECTRICAL	PC183/E/4022/SecVI-3.1	0	
		Document No.	Rev	
		Sheet 43 of 68		

9.9 Local Control Stations

- 9.9.1 Local Control Stations shall be provided for all motors for testing and maintenance purpose when the selection is made is "LOCAL MODE" Operation. The essential features of the LCS shall be as given below:
- 9.9.2 LCS shall be die cast aluminium housing (preferably) type, dust & vermin proof, weatherproof, suitable for wall or pedestal mounting with equipment mounted on a base plate inside and behind a front cover (bolted type).
- 9.9.3 LCS Enclosure shall be certified for use in hazardous areas.
- 9.9.4 Provision for pad locking in OFF position shall be provided.
- 9.9.5 Local control stations for breaker controlled HV and LV motors shall be provided with T-N-C switch, Ready to Start Indication, ON indication, Space Heater ON Indication, Trip Indication, Local-OFF-Remote Control switch and ammeter. Moreover, space heater ON indication lamp, trip indication lamp shall also be provided at the switchgear panel.
- 9.9.6 Local control stations for contactor controlled LV motors shall be provided with start/stop push buttons, ammeters and Space Heater ON Indication (for motor rated 30KW and above), ON indication, Local-Remote switch (as required) for the motors having rating 5.5 KW and above. If required from process point of view, ammeter shall be provided for motors below 5.5 KW also.
- 9.9.7 Each element for start and stop shall be provided with 1 NO + 1 NC contact. The push button construction shall be such to avoid mal-operation due to vibrations.
- 9.9.8 All local control stations shall have weather proof IP-65 enclosure and be suitable for installation in relevant hazardous area, gas group and temperature class. Canopies of suitable size shall be provided with all local control stations.
- 9.9.9 All components shall be completely wired up to terminal block and also provided with earthing terminals.
- 9.9.10 Inscriptions on corrosion resistant metal strips giving drive description, mechanism number and functional requirement shall be provided.
- 9.9.11 Two numbers of LCS shall be provided for the motors, which are installed at elevated platforms. One shall be installed at ground level and the other near the motor.
- 9.9.12 The ammeter shall be flush mounting, moving iron spring controlled type, of accuracy class 1.5 as per IS: 1248, with square face of minimum size 72 mm × 72 mm having scale range 0-90 degree. The ammeter shall be provided with uniform scale up to CT primary current and compressed end scale up to the 8 times the C.T. primary current. Adjustable red pointer shall be provided to indicate the full load current of the motors. Zero adjusters shall be provided for operation from the front of the meter. All ammeters shall be operated through 1 Amp. CTs only.
- 9.9.13 Complete Push Button along with its actuator mounted on the cover with wiring done through flexible cables with proper protection.
- 9.9.14 Preferably Ring Type lug and suitable TB to be used for connection, to avoid loose connection.
- 9.9.15 All spare hole to be plugged with suitable metal plugs.
- 9.9.16 For all other specifications, refer PC183-TS-0817.

9.10 Switch Sockets

- 9.10.1 Sufficient number of inter-locked type 125A/63A, 415V, 3 Ph and 16A, 240V, 1 Ph switch sockets shall be provided in various plant locations as per hazardous area classification to facilitate the maintenance work. Supply to switch-sockets shall be taken from ASPB through suitably rated RCCB.

	EMERGENCY DIESEL GENERATORS PACKAGE TALCHER FERTILIZERS LIMITED TECHNICAL SPECIFICATION – ELECTRICAL	PC183/E/4022/SecVI-3.1	0	
		Document No.	Rev	
		Sheet 44 of 68		

9.10.2 Minimum 2 Nos. 24 V 10 A Switch socket shall be provided near all man-hole of vessels for maintenance to which 24 V hand lamps can be connected and carried inside.

9.10.3 Both 3 Phase switch sockets and 1 Phase switch sockets shall be provided at Min. 20 M interval. Maximum 2 Nos. 63A switch sockets and 2 Nos. 16A switch sockets shall be connected in one circuit.

9.10.4 For all Other Specifications, Refer PC183-TS-0811.

9.11 Conduits

9.11.1 Conduits shall be of heavy gauge with minimum wall thickness of 1.4 mm (upto 25 mm dia) and 2 mm (above 25 mm dia) rigid steel, hot-dip galvanized, cut square, reamed, threaded and screwed tight at all joints.

9.11.2 Conduits entrances to pull boxes and switches shall have double lock nuts & insulating bushings. No running thread shall be used.

9.11.3 Flexible metallic conduit shall be used for connection to equipment which are subject to vibration and also for connection to level /limit/pressure switches. Conduit runs shall be supported at an interval of 750 mm for vertical run and 1000 mm for horizontal run.

Conduits shall be sized so that conduit fill (ratio of total cable area to conduit area) shall not exceed the following :

One Cable : 53%

Two Cable : 31%

Three Cables & Up : 40%

9.12 Bus-Duct

9.12.1 The bus bars and connection shall be made of electrolytic grade copper only. Aluminium busbars are not acceptable. All busbars shall be insulated with Raychem sleeving.

9.12.2 It shall be suitably supported at regular intervals and both bus bars and supports shall be adequately sized and clamped to withstand rated short circuit current without permanent deformation.

9.12.3 The bus bar insulators shall be non-hygroscopic, non-inflammable material. Earth bus shall run along the full length of bus duct without any break.

9.12.4 Outdoor bus-duct shall be weatherproof to IP-65 and shall be provided with canopy, silica gel breather. Construction of outdoor Bus duct shall be such that water gets drain off easily. Extra thickness shall be provided at the corners where water accumulation is likely to happen.

9.12.5 Bus duct shall be supplied with bus bar flexible links for connection at both the ends and expansion joints for every 3M of bus-duct and bus duct support materials.

9.12.6 Openings with cover at suitable locations shall be provided on bus duct for accessing the bus bars for maintenance.

9.12.7 Silica-gel breather shall be provided on both indoor and outdoor portions of the busduct. (shall not be required for pressurized busduct).

9.12.8 For all other specifications refer, PC183-TS-0807.

9.13 Electrical Control & Monitoring System

9.13.1 Centralised Electrical Control & Monitoring System (ECMS) shall be provided for Supervision, control, monitoring, data acquisition, data logging & printing of status of all important electrical equipment & feeders and Load Shedding Scheme as per the recommendations of the system study report as per process requirement and in consultation with Owner/Consultant for entire fertilizer complex, by EDS LSTK Contractor.

Data concentrator Panel and other ECMS System Equipments including PC console, chairs, furniture etc. for Emergency Diesel Generator Package shall be in EDS LSTK Contractor's

	EMERGENCY DIESEL GENERATORS PACKAGE TALCHER FERTILIZERS LIMITED TECHNICAL SPECIFICATION – ELECTRICAL	PC183/E/4022/SecVI-3.1	0	
		Document No.	Rev	
		Sheet 45 of 68		

scope. However, Contractor has to consider space for same in separate room in Panel Room, as per NIT.

Contractor shall provide multifunctional dual channel transducers in all the breaker feeders as well as contactor feeders of all important & critical Loads. Also, supply & installation of Network Switches and extend all signals up to Network Switches shall be in the scope of Contractor. Network Switch shall have 20 % spare ports. Specification of Network Switches has to be finalised in co-ordination with EDS LSTK Contractor.

Minimum Inputs and Outputs to be considered for ECMS for proper operation/control, effective monitoring and load management shall be inclusive of but not limited to the following:

a. Incomer /Bus coupler/ Feeder (Power/Motor)

KW, KVA, KVAR, KWh, PF, VOLTAGE, CURRENT

ON, OFF, TEST, SERVICE, TRIP ON FAULT, TRIP CIRCUIT HEALTHY, CONTROL SUPPLY ON, RELAY WATCH DOG, FAULT DETAILS, DISTURBANCES RECORDER.

Remote ON & OFF Control from ECMS.

b. LT motor feeder of breaker controlled motors in PMCC/MCC

KW, KVA, KVAR, KWh, PF, VOLTAGE, CURRENT

ON, OFF, TEST, SERVICE, TRIP ON FAULT, TRIP CIRCUIT HEALTHY, READY TO START, PROCESS TRIP, EMERGENCY STOP, LOCAL/REMOTE selection on LCS, CONTROL SUPPLY ON, RELAY WATCH DOG, FAULT DETAILS, DISTURBANCES RECORDER.

Remote ON & OFF Control from ECMS.

c. LT motor feeder of Contractor controlled motors in EPMC/PMCC/MCC

ON, OFF, TRIP ON FAULT, READY TO START, PROCESS TRIP.

d. Breaker Controlled Power feeder in PCC/MCC/ASPB

KW, KVA, KVAR, KWh, PF, VOLTAGE, CURRENT

ON, OFF, TEST, SERVICE, TRIP ON FAULT, TRIP CIRCUIT HEALTHY, CONTROL SUPPLY ON, RELAY WATCH DOG, FAULT DETAILS, DISTURBANCES RECORDER.

Remote ON & OFF Control from ECMS.

e. Battery & Battery Charger

Status of charging current (float & boost charging) , Battery current ,Incoming voltage, Load Voltage DC, Load current DC, DC under voltage
DC overvoltage , DC earth leakage ,AC incoming power supply failure ,AC input fuse blown-off ,Thyristor/ diode failure ,DC output fuse blown-off ,DC battery fuse blown-off ,Filter Capacitor fuse blown-off ,Load on Battery (using current direction sensing with time delay) ,Battery under voltage/ Disconnected during discharge (using zero current sensing) ,Cubicle fan failure/ cubicle temperature high (for chargers with forced cooling).

f. DG Set

KW, KVA, KVAR, KWh, PF, VOLTAGE, CURRENT

ON, OFF, TEST, SERVICE, TRIP ON FAULT, TRIP CIRCUIT HEALTHY, CONTROL SUPPLY ON, RELAY WATCH DOG, FAULT DETAILS, DISTURBANCES RECORDER. , Auto/manual switch position status , DG set run hours , Number of starts & number of consecutive starts (ie DG set auto start blocked due to exhaustion of consecutive starts) , Day tank diesel level/.

	EMERGENCY DIESEL GENERATORS PACKAGE TALCHER FERTILIZERS LIMITED TECHNICAL SPECIFICATION – ELECTRICAL	PC183/E/4022/SecVI-3.1	0	
		Document No.	Rev	
		Sheet 46 of 68		

9.13.2 All Multi-function Meters of all HT, LT Switchboard , LDB, etc. to be connected with ECMS.

Contractor shall also considered the following interface with ECMS for

- Auto Manual Synchronization
- NGR switching
- Load sharing

All connection/ wiring up to I/O Rack shall be in the scope of Contractor. However, cable tray, support for cable trays etc. for Cables from Network Switch to Data concentrator Panel & Centralized ECMS System (within battery limit of EDG Package') shall be in Contractor's scope.

9.13.3 All relays and energy meters shall have communication facility for serial communication (Relays on IEC-61850 protocol and Meters on MODBUS protocol).

10.0 CABLING

10.1 Cables

10.1.1 All HV & LV power and control cables for HV/LV switchgear shall be supplied and laid by the contractor. Terminations at switchgear end and at the equipment end shall be in contractor's scope. Supporting and laying of these cables shall also be in contractor's scope. Termination of HV/LV cables at HV/LV motor end and HV switch gear end including supply of heat shrink type termination kit for HV cables shall be in contractor's scope. Supply and execution of heat shrink type straight through jointing kits for HV cables shall be in the scope of the Contractor (if required).

10.1.2 Cables shall be sized considering the following factors.

- Maximum continuous load current
- Voltage drop
- System voltage
- Laying conditions
- De rating due to ambient air temperature, ground temperature, grouping and proximity of cables with each other, thermal resistivity of soil etc. shall be taken into account
- Short circuit withstand criteria.

10.1.3 All HV power cables shall be made of stranded aluminium conductor with XLPE insulation, PVC inner sheathed FRLS type, armoured, PVC outer sheathed FRLS type, conductor screen, insulation screen and construction as per IS: 7098 (Part 2). HV cables shall be of unearthed type.

Single core HV Power cable shall be of aluminium conductor. The construction of same shall be as per above.

10.1.4 All LV power cables shall be with stranded aluminium/copper conductor with XLPE insulation, PVC inner sheathed FRLS type , armoured, PVC outer sheathed FRLS type and construction as per IS: 7098 (Part 1). Power cables with conductor size upto and including 16 sq. mm shall be with copper conductor, conductor size 35 sq. mm and above shall be aluminium conductor.

Single core LV Power cable shall be of aluminium conductor. The construction of same shall be as per above

10.1.5 All control cables shall be with 2.5 sq. mm, stranded copper conductor with XLPE insulation, PVC inner sheathed FRLS type, armoured, PVC outer sheathed FRLS type and construction as per IS: 7098 (Part 1). Control cables shall be twisted pair or shielded wherever electro-magnetic/electrostatic interference is anticipated.

	EMERGENCY DIESEL GENERATORS PACKAGE TALCHER FERTILIZERS LIMITED TECHNICAL SPECIFICATION – ELECTRICAL	PC183/E/4022/SecVI-3.1	0	
		Document No.	Rev	
		Sheet 47 of 68		

- 10.1.6 All control cables shall have 20 % spare cores. All cores shall be identified with numerical core numbers printed on core in addition to colour coding.
- 10.1.7 All cables shall be armoured and shall have extruded inner and outer sheath.
- 10.1.8 Cables connected in parallel shall be of the same type, cross section and terminations.
- 10.1.9 All power and control cables shall be in continuous lengths (except for very long feeders) without any joints. The cables used for lighting and wires in conduits shall have appropriate junction boxes with adequately sized terminals. Cable joints in hazardous areas shall not be permitted.
- 10.1.10 The maximum voltage drops in various sections of the electrical system shall be within limits stated in the following table:

Sl.No.	System Element	Maximum Permissible Voltage Drop
a)	High voltage cables for general distribution	1 %
b)	Bus duct / Cable between transformer secondary and Switchboards	0.5%
c)	Cable between PMCC and MCC or auxiliary switchboard i) MCC / Auxiliary Switchboard near PMCC ii) MCC / Auxiliary Switchboard situated remote from PMCC	0.5% Note-3b 2 to 2.5% Note-3a
d)	Cables between HV Switchboard and HV Motor (during running)	3%
e)	Cable between PMCC and motor (during running)	5%
f)	Cable between MCC (situated near PMCC) and motors	5%
g)	Cable between MCC (situated remote from PMCC) and motors	3%
h)	Cable between Auxiliary Switchboard / MLDB and Lighting Panel / Power Panel	1 to 1.5% (Note-2)
i)	Circuit between lighting panels and lighting points	4% (Note-2)
j)	DC Supply Circuit (electrical Controls)	5% and/or as per instrumentation requirement
k)	DCDB to Control Room	2% (Note-1)
l)	UPS outgoing circuit	5% (Note-1)

Note-1

Minimum voltage available across any instrument in the field / control room / satellite rack room shall be as per instrumentation design basis. Distribution system for instrumentation supplies shall be designed accordingly. In case of any conflict between electrical equipment specification sheet and instrumentation design basis report, the latter shall govern regarding instrumentation power supplies.

Note-2

	EMERGENCY DIESEL GENERATORS PACKAGE TALCHER FERTILIZERS LIMITED TECHNICAL SPECIFICATION – ELECTRICAL	PC183/E/4022/SecVI-3.1	0	
		Document No.	Rev	
		Sheet 48 of 68		

In case of difficulty in achieving specified voltage drops in cables up to lighting panel, 5% drop from Auxiliary Switchboard / MLDB up to lighting points may be permitted.

Note-3

- a) Higher voltage drop may be permitted between PMCC and remote mounted MCC / ASB; if overall voltage drop up to motor (from PMCC) is limited within 5.5%.
- b) For large substations 1% drop may be permitted.

The maximum voltage drop at various buses during start-up of large motor and / or motor reacceleration conditions shall be within the limits stated below:-

Sl. No.	System Element	Operating Condition	Maximum Permissible Voltage Drop
a)	At the bus bars of the worst affected Switchboard	Start-up of the large HV motor with other loads on the bus or reacceleration of a group of HV motors (Simultaneous start-up or group reacceleration of HV motors is not envisaged)	10%
b)	At the bus bars of the worst affected LV Switchboard (PMCC / MCC)	Start-up of large LV motor with other loads on the bus, or reacceleration of a group of LV motors.	10%
c)	Cables between HV Switchboard and motor	Motor start-up or reacceleration	5% (Note-a)
d)	Cable between MV Switchboard (PMCC / MCC) and motor	Motor start-up or reacceleration	10% (Note-a)

Notes:

- a) Higher voltage drop in motor cables may be permitted, in case the conditions given in Note b), c) and d) are complied.
- b) The voltage available at the motor terminals during start-up must be sufficient to ensure positive starting or reacceleration of the motor (even with the motor fully loaded, if required), without causing any damage to the motor.
- c) Soft Starter / VFD Starter shall be considered for starting large HV motors if essential / unavoidable as per system design requirement / equipment design limitation. For cases other than starting limitation, requirement of soft starter / VFD for any drive shall be confirmed by Process Department.
- d) Unless otherwise specified as in clause e), all HV motors and MV motors shall be suitable for Direct on Line (DOL) starting.

10.1.11 MINIMUM CABLE SIZES FOR 415V MOTORS

Direct on line (D.O.L) start motors (2/4 pole motors)

MOTOR RATING	CABLE DETAILS			
	NUMBER OF RUNS	NO. OF CORES PER RUN	CONDUCTOR MATERIAL	CONDUCTOR SIZE (MM ²)

	EMERGENCY DIESEL GENERATORS PACKAGE TALCHER FERTILIZERS LIMITED TECHNICAL SPECIFICATION – ELECTRICAL	PC183/E/4022/SecVI-3.1	0	
		Document No.	Rev	
		Sheet 49 of 68		

Below 3.7 KW	1	3	Cu	2.5
3.7 KW	1	3	Cu	4
5.5 KW	1	3	Cu	10
7.5 KW	1	3	Cu	10
9.3 KW	1	3	Cu	16
11 KW	1	3	Cu	16
15 KW	1	3	Cu	16
18.5KW	1	3	Al	35
22 KW	1	3	Al	35
30 KW	1	3	Al	50
37 KW	1	3	Al	70
45 KW	1	3	Al	95
55 KW	1	3	Al	120
75 KW	1	3	Al	185
90 KW	2	3	Al	95
110 KW	2	3	Al	120
125/132 KW	2	3	Al	150
150 KW	2	3	Al	185

- Cables sizes as indicated above are for 2/4 poles motors fed from MCCs located near PCCs and PMCCs.
- Cable sizes for motors not confirming to above table (e.g. for 2/4 poles motors rated up to 150kw & motors with high starting pf), extended distance, reduced voltage starting, low speed motors, VFD driven etc. shall be worked out on case to case basis.
- However cable sizing calculation shall be submitted for approval.

10.1.12 Design Criteria for Cables/Bus Duct & Short Circuit Withstand Time:

a) Design criteria for cables/bus duct

Sr. No.	Design Criteria	3.3 kV / 11 kV	415 V
1.	Loads beyond 1000A rating and located near the transformer	Bus Duct / 1-core cable	Bus Duct / 1-core cable
2.	Loads located up to 200 M	Cable	Cable
3.	Loads located 200 - 1000 M	1-core cable / 3-core cable	1-core cable / 3.5-core cable
4.	Loads located beyond 1 KM	Cable	Cable
5.	Recommended limiting size of multi-core cable (sq.mm) / Single Core (sqmm)	3 Core x 400 / 1 Core x 630	3.5 Core x 300 / 1 Core x 630
6.	Insulation voltage grade	3.3 kV / 11 kV Unearthed	1100 V Earthed
6.	Type of cable insulation	XLPE	Power: XLPE Control: XLPE
7.	Power, Control & Earthing Cables	Armoured	Armoured

For breaker control motor circuits the selection of size will be made ensuring that the cable shall withstand a short circuit fault directly for 0.2 sec.

Suitable derating factors based on the site ambient conditions, method of laying and the no. of cables laid together shall also be applied.

b) Short circuit withstand time (seconds) shall be as follows for Breaker controlled feeders.

Bus duct	1 Sec.
----------	--------

	EMERGENCY DIESEL GENERATORS PACKAGE TALCHER FERTILIZERS LIMITED TECHNICAL SPECIFICATION – ELECTRICAL	PC183/E/4022/SecVI-3.1	0	
		Document No.	Rev	
		Sheet 50 of 68		

Feeders to motors and transformer	0.25 sec
Feeders from PCC/PMCC to MCC	0.6 sec
Main 11 KV primary distribution feeders	0.7 sec
11 KV cable from transformer to switch board	1 sec
Incomer from other switchboard	0.6 sec

10.1.13 The minimum size of power cables shall be 2.5 sq. mm (Cu).

10.1.14 The control cables shall be 2.5 sq. mm (Cu). However, wiring in the panel/switch boards may be by means of 1.5 sq. mm (Cu) cables except for CT wiring which shall be 2.5 sq. mm. All the control and power wiring shall be carried by using FRLS wires only.

10.1.15 For all other specifications, refer PC183-TS-0815.

10.2 Cable Laying

10.2.1 The cables shall generally be laid on overhead racks. Pipe racks where available, shall be used to support the cable racks.

HV power cable shall be laid on cable tray in single layer having 1D spacing between the cables. LV power and control cable shall be laid on cable tray in touching formation in single layer.

HV Power, LV Power and Control shall be on separate trays. Instrument and electrical cable trays shall be separate.

Cables shall be clamped properly on the cable rack in such a way that position and layout of a particular cable shall not change throughout the rack so that it can be easily traced during maintenance jobs.

Walkway to be considered for access to Electrical / Instrument cables on pipe rack.

From substations to various electrical consumers, cable shall be laid overhead. However, wherever overhead cable routing is not feasible Contractor can go for cable trench / slit (Refer PDS attached with the NIT) as per the site requirement.

Wherever, pipe rack is not available and space for overhead cable laying is possible then dedicated structure for cable shall be made for cable laying.

10.2.2 The cable racks shall be ladder type, pre-fabricated from suitable hot dip galvanised steel/heavy duty FRP material. Cable racks around cooling tower areas shall be of heavy duty FRP (fire retardant and UV stabilized) material. Maximum cable tray size shall be 600mm wide. Maximum supporting span shall be 2 Mtrs. as per PDS Doc. No. PDS: E 530 attached with the NIT. Cable trays shall be designed considering 25% margin for future use.

All cable racks must be provided with GI flat strip of size 75mm X12 mm as running earth all along the tray.

10.2.3 FRP Cable Tray shall be as per NEMA FGI-198X. FRP Cable Tray shall be UV exposed as per ASTM G 154 for 1000 Hrs and the mechanical properties shall not be deteriorate more than 5%. Glass content shall be greater than 55%. The run spacing shall be 250mm.

10.2.4 All cables shall be terminated using suitable cable lugs.

10.2.5 All HV terminations and joints shall be of RAYCHEM make only.

10.2.6 Bimetallic lugs shall be provided, as required.

10.2.7 In Control Room (excluding false ceiling) and Substation, lighting cable shall be laid in concealed conduit.

	EMERGENCY DIESEL GENERATORS PACKAGE TALCHER FERTILIZERS LIMITED TECHNICAL SPECIFICATION – ELECTRICAL	PC183/E/4022/SecVI-3.1	0	
		Document No.	Rev	
		Sheet 51 of 68		

11.0 ILLUMINATION SYSTEM

11.1 General

11.1.1 LED type lighting shall be provided. The average illumination levels in the various sections of the plants shall be as indicated in Annexure-I. All the plants and area lighting shall be energy efficient.

11.1.2 LED type lighting shall be provided for all areas. The minimum illumination levels in the various sections of the plants shall be as indicated in Annexure-I.

LED shall conform to the following types and standards:-

Product Type	Safety Standard	Performance Standard
Self ballasted LED lamps for general lighting services > 50 V	IEC 62560 Latest Edition	IEC 62612 / PAS Publicly available specification
Control gear for LED modules	IEC 61347-2-13 Latest Edition	IEC 62384 Latest Edition
LED modules for general lighting	IEC 62031 Latest Edition	IEC / PAS 62717 Latest Edition
LED luminaries	IEC 60598-1 Latest Edition	IEC / PAS 62722-2-1 Latest Edition Luminaries performance – Part 2-1: particular requirements for LED
LEDs and LED modules	IEC TS 62504 Terms and Definitions for LEDs and LED modules in general lighting.	

factor for indoor lighting shall be considered as 0.7 and for Outdoor lighting 0.6.

The colour rendering index shall not be less than 90%.

The LED lights shall work satisfactorily at the design temperature of 50 Degree Celsius.

All the LED fittings shall be selected in accordance with Hazardous Area Classification.

The life assessment of LEDs shall include control gears/ driver as well.

11.1.3 The specified illumination level shall be maintained after considering maintenance factor 0.5 for Coal Dust Area , 0.6 for plant & outdoor areas (other than Coal Dust Area) & 0.7 for indoor areas and utilisation factor as per manufacturer catalogues for size of room & type of fixture.

11.1.4 Separate area wise panic lights, fed from 110 V DCDB, shall be provided at strategic locations for safe evacuation of operation personnel. These shall be switched 'ON' automatically on failure of power supply to main lighting board and shall switch 'OFF' automatically on resumption of mains or after 1 hour of power failure to avoid draining of the battery. Location of these lights shall be judiciously decided from safety considerations. The outdoor lighting shall be photocell/timer controlled.

11.1.5 Voltage drop at the fixture from the MLDB bus shall not exceed 3%.

11.1.6 Aviation lights shall be provided on tall structures and all isolated structures. . Aviation Lighting shall be in accordance with International Civil Aviation Organization (ICAO) Publication Annexure 14 and to Indian Standards, together with the approval of local aviation authority..

LED type Low Intensity Aviation Obstruction Light suitable for 240V, 50 Hz supply. It shall be covered under Indian patent act (Govt of India) No. 188995. Degree of protection shall be IP-65.

The illumination intensity of aviation lights and mounting height shall be considered based on vicinity of civilian air terminal within 1 KM radius. Aviation lights at each location shall be fed

	EMERGENCY DIESEL GENERATORS PACKAGE TALCHER FERTILIZERS LIMITED TECHNICAL SPECIFICATION – ELECTRICAL	PC183/E/4022/SecVI-3.1	0	
		Document No.	Rev	
		Sheet 52 of 68		

from two separate and distinct DBs (one fed from normal bus and another fed from emergency bus of MLDB). In case aviation lights are not switched ON for any reason, whatsoever, a signal shall be sent to control room which will sound buzzer and also result in flashing of red light. On acknowledgement, buzzer shall stop but flasher will continue unless aviation lights are turned ON.

The fixtures shall have body of corrosion resistant aluminium alloy casting and shall be suitable for outdoor use and mounting on 40 mm NB G.I. pipe. Necessary electrical threading shall be tapped in the fixture for mounting.

- 11.1.7 Plant lighting circuits shall be single phase (Phase & Neutral) rated 240 V AC. Each circuit shall be rated to 16A but not loaded more than 8A. A minimum of 25% of MCBs of each board shall be left as spares. The load on one lighting sub-circuit of lighting sub-distribution board and junction box shall be limited to 1000W approx.
- 11.1.8 The lighting sub-distribution board for control of lighting shall be standardized as 12-way, 9-way and 6-way type.
- 11.1.9 In plant office rooms, wall mounting boards shall be installed to control the lighting. These boards shall include switches for lights, fans, 15A/5A plug sockets and fan regulators etc.
- 11.1.10 15A plug sockets shall be fed through separate circuit of lighting sub-distribution boards/junction box having ELCB of 30mA.
- 11.1.11 16A plug sockets shall be fed through separate circuit of lighting sub-distribution boards/junction box.
- 11.1.12 Illuminated exit sign shall be provided in substation / Control Room .
- 11.1.13 Power factor of complete fitting shall be 0.95 min. at 230 V.
- 11.1.14 Lights from LED's shall be soothing to eye and without any bright spots on the floor/objects illuminated by the luminaries.
- 11.1.15 The driver shall be mounted internally and be replaceable with the aid of commonly available hand tools.
- 11.1.16 The LED module or array shall be designed in such a way that the failure of one LED shall not affect additional LED's.
- 11.1.17 Life expectancy of LED Luminaries shall be minimum of 50000 hrs with greater than 70% of rated lumen output.
- 11.1.18 Min. efficiency of LED driver: The minimum efficiency of LED driver shall be 85% for driver power output rating $\leq 40W$ and 87% for driver power output rating $> 40W$.
- 11.1.19 Short circuit protection /Open load protection shall be required for LED fixtures.
- 11.1.20 Surge Protection for minimum 2kV for indoor and minimum 3kV for Outdoor LED systems shall be provided. However, If a site is prone to lightning and surges 10kV surge protection shall be required. In case of outdoor luminaires, the Surge Protection Device (SPD) should be series type with fail safe.
- 11.1.21 Color temperature of LED Luminaries: 5700K
- 11.1.22 Cover type for outdoor type fittings shall be Toughened glass or UV stabilized polycarbonate whereas, whereas, for indoor and non-weather proof items, UV stabilized Poly Carbonate can be used.
- 11.1.23 For more details, refer PDS attached.
- 11.1.24 For lighting fixtures and 16 Amp plug socket circuits, 3 core 2.5 sq. mm (Cu) cable shall be used.
- 11.2 LED Tube Lighting Fixtures (inside Substations)

	EMERGENCY DIESEL GENERATORS PACKAGE TALCHER FERTILIZERS LIMITED TECHNICAL SPECIFICATION – ELECTRICAL	PC183/E/4022/SecVI-3.1	0	
		Document No.	Rev	
		Sheet 53 of 68		

- a) High quality LED fluorescent tube twin batten type complete with 2 X 20W tube eco friendly, no UV radiation as per the specification tabulated below:

Sl. No.	Parameter	Technical Specification
1.	Degree of Protection	IP-20
2.	Lumen output per Lamp	≥ 2000
3.	CCT	6500K
4.	Luminous efficacy	≥ 100 lm/watt
5.	CRI	>80
6.	Guaranteed Life	≥ 50000 burning hours
7.	PF	>0.95
8.	THD	<10%

12.0 EARTHING AND LIGHTNING PROTECTION

12.1 Earthing

- 12.1.1 Complete earthing installation shall be done as per IS: 3043, IEEE-80, IE Rules and IEC recommendations. The earthing system shall be designed to:

- Provide a permanent & continuous path from equipment and conductor enclosures to earth from circuits for flow of fault current.
- Provide sufficient current carrying capacity to conduct safely any current liable to be imposed on it.
- Provide sufficient low resistance to earth to limit the potential between metalwork and earth within safe limits.
- Provide equal distribution of potential and minimum potential difference for safety of personnel.
- Ensure sufficient current in case of fault to facilitate the operation of relays, over current devices, fuses etc. provided in the circuit.

- 12.1.2 Common underground earthing grid shall be provided covering DG area and Panel room which is further connected to overall Earthing Grid. The overall earth resistance (dry) shall be limited to 1 ohm.

- 12.1.3 Earthing rings shall be provided around sub-stations and plants which in turn shall be connected to the common earthing grid. Minimum size of main grid shall be 75mm×12mm.

- 12.1.4 Anti-corrosive bituminous paint shall be provided at each joint of earth flat after necessary finishing and priming treatment .

- 12.1.5 Earthing grid/ring shall comprise of buried GI earth strips and GI pipes/electrodes.

- 12.1.6 Chemical earth pits shall be considered instead of conventional earth pits in view of faster dissipation of lightning surges and fault currents, easy installation and maintenance free feature. Enhanced high quality UL certified 17.2 mm copper bonded (250 micron) earthing electrode/ rod along with 22.6 KG graphite based (non-bentonite) as a ground enhancing material with stainless steel clamp for connecting copper bonded rod with horizontal flat strip shall be used.

- 12.1.7 Backfill shall be permanent and maintenance free. (No re- charging with salts or any other chemicals) and shall maintain its earth resistance with time. Backfill shall conform IEEE 80-2000 Clause No.14.5 (d). Backfill in its set form shall have a resistivity of not more than 0.12 ohm-m. Backfill shall comply the requirements and all applicable tests as per part-7 of IEC 62561.

- 12.1.8 Earthing grid/ring shall comprise of buried GI earth strips and GI pipes/electrodes.

	EMERGENCY DIESEL GENERATORS PACKAGE TALCHER FERTILIZERS LIMITED TECHNICAL SPECIFICATION – ELECTRICAL	PC183/E/4022/SecVI-3.1	0	
		Document No.	Rev	
		Sheet 54 of 68		

- 12.1.9 Separate earth electrodes shall be provided for system neutral earthing. For equipment earthing, minimum two numbers of electrodes shall be provided around each plant/section. However, all these earth electrodes shall be interconnected.
- 12.1.10 Inter-connecting pits having an earth bus in an enclosed brick chamber without earth electrode shall be provided in the common underground earthing grid for convenience of taking earth conductors inside the plants.
- 12.1.11 As far as possible, the reinforcement rods inside concrete column shall be connected to the earthing grid/ring to reduce the overall earth resistance.
- 12.1.12 Individual electrical equipment shall be earthed by GI strip/GI wire/Cu/Al cable. Earth buses shall be provided in plants for earthing groups of electrical/non-electrical equipment to earthing grid/rings.
- 12.1.13 Size of earthing grid/ring and earth conductors of equipment for generating station and sub-stations shall be as per relevant standards. The fault current magnitude shall be decided based on system fault level. The time duration shall be taken as 1 second for voltage level above 66 kV and 3 seconds for voltage upto 66 kV as per IS -3043.
- 12.1.14 All equipment rated above 250 V shall have two external earth connections and those rated up to 250 V shall have one external earth connection. However, for lighting fixtures, earthing shall be done through 3rd core of the cable in safe as well as in hazardous area.
- 12.1.15 Flameproof equipment, in addition, shall have one internal earth connection. This means that 4 core cables to be used for all the flameproof equipments and 3.5 core cables to be used for all flameproof motors located at hazardous area.
- 12.1.16 All steel structures, tanks, vessels, pipes, pipe joints, valves etc. shall be earthed against static charge accumulation by 50x6 mm GI strip. The no. of earth connections shall be as follows:
- | Equipment having diameter | Hazardous area | Non hazardous area |
|---------------------------|----------------|--------------------|
| 30 M | 2 | 2 |
| More than 30 M | 3 | 2 |
- 12.1.17 Wherever process equipments are mounted on steel structures, the structures shall be earthed instead of earthing the individual equipment.
- 12.1.18 The pipe structures shall be earthed at not more than 25M apart.
- 12.1.19 For all equipment in hazardous area, in addition to external earthing one internal earthing shall be provided.
- 12.1.20 Minimum sizes of earth conductors to be used shall be as given below.

Sl.No.	Equipment	GI conductor size	Al conductor Size
1.	HV/LV switch board, transformers, HV motors	50mm×8mm	150 sq. mm
2.	Motors rated 75 KW and above	50mm×6mm	150 sq. mm
3.	Motors rated 30 KW to less than 75 KW and vessel earthing	35mm×6mm	95 sq. mm
4.	Motors rated 5.5 KW to less than 30 KW	25mm×6mm	25 sq. mm
5.	Motors less than 5.5 KW	8 SWG	6 sq. mm
6.	All minor equipment rated 250V & above.	10 SWG	6 sq. mm
7.	Earth Grid	75mm x 12 mm.	-

	EMERGENCY DIESEL GENERATORS PACKAGE TALCHER FERTILIZERS LIMITED TECHNICAL SPECIFICATION – ELECTRICAL	PC183/E/4022/SecVI-3.1	0	
		Document No.	Rev	
		Sheet 55 of 68		

Vendor to calculate the actual size. However, higher size of calculated one or above-mentioned size shall be provided.

All GI conductors shall meet the galvanizing requirement as per IS.

12.1.21 The main ground grid shall be buried in earth at a minimum depth of 1000 mm below finished grade level unless stated otherwise

12.2 Lightning Protection

12.2.1 All structure shall be protected against lightning strokes by suitable lightning protection system to be designed and installed as per IS/IEC-62305.

12.2.2 The number of down conductors shall be minimum two.

12.2.3 Bare metallic structures shall not have any air termination rods at the top. The earth connections shall be welded to the bottom of structure at 300 mm above floor level. However, tall metallic columns with insulation at top shall be provided with air termination rods. Separate earth electrodes shall be provided for each down conductor of lightning protection. However, these shall be inter-connected with the other electrodes in main grid.

12.2.4 Air Terminal

The vertical air terminal rods shall be installed at the roof of buildings to protect from lightning strokes.

The vertical air terminal shall be made of 20 mm dia galvanized steel rod. The projected length of the rod shall be as required to protect the object (on which the rod is fixed) from lightning stroke.

The air terminal rod shall be properly fixed on the top of the building/structure to withstand very high wind pressure. In case the air terminal rod is embedded at the top of roof of building; the portion embedded inside the concrete shall not touch the reinforcement bars and shall be duly insulated from them.

All the vertical air terminal rods shall be electrically connected together by means of horizontal conductors of size 50 x 6 mm galvanized steel flats.

The shielding angle for one vertical air termination shall be 45 degrees. For more than one rod, shielding angle between the rods shall be taken as 60 degrees.

Horizontal air termination (i.e. G.S. Flat conductor) shall be so laid that no part of the rod will be more than nine (9) metres from the nearest roof conductor.

12.2.5 Shielding Masts

The shielding mast for lightning protection shall be installed at the top of steel columns cap plates of power house main building.

The shielding mast shall be made of galvanized steel pipe and the height of the same shall be decided considering the zones to be protected.

Each shielding mast shall be connected to grounding grid by a down conductor 50 x 6 mm. Galvanized steel flat run along the building column. In addition all power house building columns joints shall be electrically bonded.

12.2.6 Down Conductors

The down conductors shall be 50 x 6 mm galvanized steel flats. The connection between each down conductor and earth electrode shall be made via test link located at approximately 1500 mm above ground level.

13.0 MOUNTING STRUCTURES

Switch sockets, cable trays, DBs etc shall be mounted / supported on suitable structure fabricated out of standard sections of mild steel, i.e. channels, angles, flats etc conforming to IS: 2066.

	EMERGENCY DIESEL GENERATORS PACKAGE TALCHER FERTILIZERS LIMITED TECHNICAL SPECIFICATION – ELECTRICAL	PC183/E/4022/SecVI-3.1	0	
		Document No.	Rev	
		Sheet 56 of 68		

14.0 SPARES

14.1 Commissioning Spares

The commissioning spares shall form an integral part of the scope of supply. Contractor shall be responsible for the quantification of the commissioning spares for the smooth commissioning start up of the plant/ package system. Item wise list of commissioning spares with recommended quantity shall be furnished for information. The same shall be Part of LSTK price

14.2 2 years operational spares (Mandatory)

Contractor shall supply Mandatory spares for all equipments as per Section VI-6.0: Spare Parts of NIT. The same shall be Part of LSTK Price.

14.3 Recommended Spares (Other than Mandatory spare)

Contractor shall provide recommended spares (other than mandatory spare) for all the equipment (item-wise) with recommended quantity.

14.4 All spare parts shall be identical to the parts used in the equipments.

Any other spare parts or special tools

15.0 VENDORS' SERVICES

15.1 The Contractor shall consider the services of major equipment suppliers during installation, testing and commissioning in their scope as required.

15.2 The services of engineers of following equipments' (OEM)manufacturers are envisaged and required during installation, Testing and commissioning. Contractor shall arrange for the same without any additional cost implication:

- DC Panels
- Numerical relay
- HV & LV Switchboard
- DG Set

15.3 Site Testing, parameterization and commissioning of the Numerical relays shall be done by OEM expert only.

16.0 TESTING & INSPECTION

16.1 Testing of all electrical equipments shall be done in accordance with relevant IEC/BIS codes in presence of owner's representative at manufacturer's works before despatch / at site before installation. All such tests shall be arranged by the contractor and testing charges, if any, shall be borne by the contractor.

16.2 The Contractor shall submit the certificates of type tests performed on identical equipment as evidence of the compliance of the equipment with the type tests.

16.3 The Contractor shall submit the certificates of routine and acceptance tests conducted on the purchased equipments.

16.4 All the routine/acceptance tests shall be performed at the manufacturer's works in the presence of owner's representative.

16.5 Stage Inspection of Electrical Equipment shall be considered. The owner or their representative shall be allowed to visit the manufacturing works for stage inspection during manufacturing stage.

16.6 The equipment shall be dispatched from works only after receipt of Owner written approval of the test reports.

16.7 The Contractor shall intimate the owner 4 weeks in advance of the tests and submit the detailed schedule of tests.

16.8 In addition, the equipment shall be inspected at site for final acceptance.

	EMERGENCY DIESEL GENERATORS PACKAGE TALCHER FERTILIZERS LIMITED TECHNICAL SPECIFICATION – ELECTRICAL	PC183/E/4022/SecVI-3.1	0	
		Document No.	Rev	
		Sheet 57 of 68		

- 16.9 Certified reports of all the tests carried out at the works shall be furnished in six (6) copies for approval of the Owner.
- 16.10 Electrical installation work shall be subjected to inspection by owner / his authorized representative, statutory bodies like Electrical Inspector, Factory Inspector and where applicable by equipment supplier's engineer. The contractor shall carry out without extra cost to owner rectifications / modifications desired by the above authorities to make the installation conforming to I.E. Rules etc.
- 16.11 The owner may reject any portion of the work considered defective or of poor workmanship and the contractor shall make good these defects without extra cost to owner.
- 17.0 DOCUMENTATION**
- 17.1 The Contractor shall submit the documents for electrical equipments (MS-word, MS-excel and AutoCAD) as per the drawing and documentation schedule as given in this bid package.
- 17.2 Sizing of Electrical system and Equipments shall be submitted during detailed engineering stage.
- 17.3 Contractor shall ensure that following shall be mentioned in each sheet of drawings/ documents in the order mentioned below:
- (a) Logo and Name of the client
 - (b) Logo and Name of the consultant
 - (c) Logo and Name of the contractor (Contractor)
 - (d) Logo and Name of the Manufacturer on the drawings prepared by manufacturer, if applicable
 - (e) Name of the Project for which drawings are applicable
 - (f) Title of the drawing (Title shall indicate the details shown in the drawing)
 - (g) Drawing/ document number with sheet number and number of total sheets in the drawing (Drawings having different title shall be assigned different drawing number)
 - (h) All sheets of each drawing shall bear same title, same document number and same revision number
- 17.4 At the time of handing over of the installation, Contractor shall supply as built drawings taking into consideration the actual execution carried out at site.
- 17.5 Erection, testing/ checking (inclusive of calibration check) prior to energisation/ after energisation and commissioning Manuals shall be in bound book format and shall give step by step procedure for:
- (a) Storage, Handling and Erection
 - (b) Checking/ testing after erection and before energisation.
 - (c) Pre-commissioning tests/ checks and cold trials
 - (d) Commissioning
 - (e) Drawings relevant for erection, operation, maintenance and repair of the equipment.
 - (f) List of instruments/ testing kits/ sets, measuring instruments etc. required for testing/ checking with specification, ratings, ranges etc.
- 17.6 Operation & Maintenance Manuals for each of the equipment/ system being shall be in bound book format and shall be supplied alongwith dispatch of equipment and inclusive of following:
- (a) Log sheets indicating daily/ hourly recordings of parameters to be noted down by customer's operating personnel.
 - (b) Procedure for shut down and energisation.

	EMERGENCY DIESEL GENERATORS PACKAGE TALCHER FERTILIZERS LIMITED TECHNICAL SPECIFICATION – ELECTRICAL	PC183/E/4022/SecVI-3.1	0	
		Document No.	Rev	
		Sheet 58 of 68		

- (c) Preventive maintenance schedule.
 - (d) Safety procedures for safe operation of equipment and complete system.
 - (e) Specification of equipment installed. Manufacturer's catalogues operation and maintenance manuals for all types of relays/components used.
 - (f) Test procedures for site tests/ checks.
 - (g) Spares list for each equipment/ system for 2 years operation and maintenance.
 - (h) Relevant calculations and protection relay setting table for the equipment/ system being supplied by him
 - (i) Instructions for Diagnostic trouble shooting / fault location charts
 - (j) Tests for checking of proper functioning/ Operation.
 - (k) Storage and re-conservation Manual
 - (l) Safety Manual
 - (m) Drawings relevant for operation, maintenance and repair of the equipment
 - (n) Instructions for Maintenance and Repair
 - (o) List of spare parts with ordering specifications and manufacturer's catalogues.
 - (p) List of consumables with specifications, brand names and annual consumption figures.
 - (q) Manufacturer's catalogues with ordering specification for all items
 - (r) List of special tools and tackles
 - (s) QAP, Internal Test Certificates and Inspection Certificates
 - (t) Procedure for ordering spares.
 - (u) All as built drawings.
- 17.7 Drawings/ documents to be submitted with inspection call of equipment:
- (a) Type test certificate for identical equipment
 - (b) Sub-supplier's/ vendor's catalogue/technical literature
 - (c) Test reports for internal inspection
 - (d) Test certificates of components
 - (e) Technical specification & data sheets of equipment
 - (f) All drawings as applicable of category 'Approved', 'Approved with comments' and drawings 'For information/ Reference' including comments thereon
- 17.8 The details of equipment layout and cable routing will be designed by the Contractor during detail engineering stage and these shall be subject to approval by Owner/Consultant. Changes as required to achieve a neat layout with adequate working space all around, for better aesthetics as well as to meet statutory regulation and codes shall be done without any time and cost implication.
- 18.0 **TOOLS & TACKLES**
- The Contractor shall supply at least one set of all special tools for each substation required for maintenance of the equipment supplied by them and price shall be included in the offer. List of tools & tackles with quantities shall be mentioned in the offer.
- 19.0 **REVIEW OF DRAWINGS & DOCUMENTS BY OWNER/ CONSULTANT**
- 19.1 The successful Bidder (herein after referred as contractor), shall submit within one month of placement of LOI; list of drawings/ documents/ Manuals that would be submitted by them. The

	EMERGENCY DIESEL GENERATORS PACKAGE TALCHER FERTILIZERS LIMITED TECHNICAL SPECIFICATION – ELECTRICAL	PC183/E/4022/SecVI-3.1	0	
		Document No.	Rev	
		Sheet 59 of 68		

list shall mention Serial Number, Title of the drawing/ document/ manual, Category (For Approval, For review, For Reference, etc) and tentative date of submission. The list shall be prepared taking in to account into consideration stipulations in respect of submission of drawings/ documents and scheduled date for completion.

- 19.2 Template for name plate of drawings, documents and drawing/ document numbering system shall also be submitted by contractor and approval obtained.
- 19.3 The Contractor shall ensure that all sheets of the drawings/ documents and top sheet of manual prepared by manufacturer/ vendor/ supplier & submitted by him or by his consortium member or by manufacturer or his consultant, are checked by him/ leader of consortium and vetted by Contractor / Leader of consortium before submission with stamp ensuring correctness, completeness, suitability of document for subject work and compliance with stipulations of order
- 19.4 The responsibility for delay in approval/ review of drawings/ documents due to
- Submission of incomplete drawings/ documents not meeting the requirement of project/ stipulations of order
 - Non-compliance of comments made earlier
 - Drawings are not submitted in requisite copies;
and consequent delay in project shall be that of contractor.
- 19.5 The contractor shall ensure that in case any model number is mentioned in the drawing, detailed technical catalogue, literature, explanatory notes to describe the model and its technical details in full are also submitted along with the drawing. Such drawings/ documents should be assigned Drawing/ Document Number, Number of sheets in the drawing, Rev number etc (Unique Identification). Reference of such drawing/ document number should be mentioned in the drawing.
- 19.6 The drawings/ documents shall be prepared in such sizes that those can be read easily. Size of font in print submitted shall not less than size10 Arial or equivalent.
- 19.7 The drawings/ documents shall be submitted in sizes in which those are prepared. Photocopies in reduced sizes shall not be accepted.
- 19.8 The contractor shall leave space on each sheet for stamping the drawing by Owner/ consultant to avoid stamping on contents of drawing making them unreadable. Submission of drawings in A4 size shall be avoided.
- 19.9 All sheets of a drawing shall be assigned same title and drawing number. Drawings having different title shall be assigned different drawing numbers.
- 19.10 GA drawings, schematic diagrams, single line diagrams, bill of material, data sheets, characteristics curves, cable schedules and cable termination diagrams shall be assigned separate drawing numbers.
- 19.11 Revision shall be clearly marked on all subsequent issue of drawings and documents.
- 19.12 Inability to incorporate some of the comments shall be clearly stated by contractor with reasons and without delay. However, to accept or reject the non-compliance based on the reasons indicated by contractor shall be discretion of Owner/ their consultant.
- 19.13 In case alterations are considered necessary by the contractor in the drawings already approved, such drawings shall be resubmitted for approval again stating the considerations necessitating changes/ alterations. In case, alterations/ changes proposed by contractor are approved by the consultant/ Owner; all other drawings and data affected by such alterations/ changes shall be duly revised and re-submitted for the approval as stated above.

	EMERGENCY DIESEL GENERATORS PACKAGE TALCHER FERTILIZERS LIMITED TECHNICAL SPECIFICATION – ELECTRICAL	PC183/E/4022/SecVI-3.1	0	
		Document No.	Rev	
		Sheet 60 of 68		

- 19.14 Contractor shall depute their concerned engineers (with the engineers of suppliers, if required) shall visit consultant after submissions of drawings for discussion, modification of drawings and approval so that project is not delayed for want of approval of drawings.
- 19.15 It will be the responsibility of contractor to submit the drawings and obtain approval to meet the project schedule. Delay in approval of drawings due to following shall be the responsibility of contractor:
- a. non-submission of drawings/ documents/ well before those are actually required and/ or
 - b. delay in incorporation of comments and/ or
 - c. non-incorporation of comments by contractor and/ or
 - d. submission of drawings without checking and ensuring requirement stipulated in contract/ order
- 19.16 Contractor shall note that any approval and/ or clearance accorded by Owner or consultant for manufacture and/ or to proceed further given during discussions or recorded in the minutes of the meetings shall be valid only after the drawings showing relevant details are submitted by contractor and clearance/ approval is accorded by Owner/ Consultant by stamping and signing on the relevant drawings.
- 19.17 Approval of drawings by Owner / his consultant shall not relieve the contractor of his contractual obligations and responsibility for engineering, design, workmanship, materials and performance of the equipment
- 19.18 Contractor shall furnish, if requested, additional drawings, calculations, information to the Owner/ Consultant to enable him to examine/ study the drawings submitted.
- 19.19 Contractor shall note that work shall be carried out exactly as indicated in the approved drawings and no alterations shall be made without the written approval of the Owner/ Consultant.
- 20.0 TRAINING**
- 20.1 Training shall be imparted to owner's personnel at manufacturer's works as under:
- a) Numerical relay: One engineers for one week
 - b) HV & LV Switchboard : One engineers for one week
 - c) DG Sets : Two engineers for one week
- 21.0 VENDOR LIST**
- 21.1 Make of all electrical equipment shall be as per Section 10.0: Vendor List attached with this bid package.
- 21.2 Any other vendor shall be subject to Owner/Consultant's approval.
- 21.3 Bidder shall indicate the make of all the equipments in their offer.
- 21.4 Any other item for which vendors are not mentioned in NIT, Contractor shall furnish list of proven suppliers with PTR subject to Owner's/ Consultant's approval during detailed engineering. Document(PTR) shall be in English language only.
- 22.0 INSTALLATION, TESTING AND COMMISSIONING**
- 22.1 The Contractor shall undertake installation of all electrical equipment in accordance with latest code of practices, in conformity with recommendation of the respective equipment manufacturers, drawings approved by the owner or owner's representative, direction of engineer-in-charge, statutory regulations and to the entire satisfaction of the owner.
- 22.2 The Contractor shall arrange all the necessary erection tools and tackles, testing and measuring instruments and shall supply the required erection materials including structural steel.

	EMERGENCY DIESEL GENERATORS PACKAGE TALCHER FERTILIZERS LIMITED TECHNICAL SPECIFICATION – ELECTRICAL	PC183/E/4022/SecVI-3.1	0	
		Document No.	Rev	
		Sheet 61 of 68		

- 22.3 Contractor shall furnish field inspection and test data sheets for all equipments for owner's approval.
- 22.4 The Contractor shall obtain the necessary certificate of compliance/completion certificate with test results from statutory authorities as required. All necessary drawings and test certificates as required by them shall be furnished by the vendor.
- 22.5 The erection work shall be supervised by competent supervisors holding relevant supervisory license from the Government.
- 22.6 Installation of Equipment
- a. The equipment shall be installed in switchgear rooms, MCC rooms, control rooms and at shop floors.
 - b. The scope of work of Contractor under installation shall be inclusive of but not limited to the following:
 - c. Physical inspection and handling
 - d. Assembly and interconnection of shipping sections, if any, as per manufacturer's instructions. Supply of materials, fabrication and installation of supporting frames/ brackets for proper support of equipment/ panels/ devices/ cable trays etc..
 - e. Installation on foundation/ supports/ brackets.
 - f. Alignment, leveling and clamping/ welding/ fixing/ grouting with supports/ foundation bolts as required.
 - g. Mounting loose supplies and connection of wiring.
 - h. Conducting pre-energisation tests/ checks to ensure that installation is carried out as per manufacturer's instructions/ direction of supervising engineer and is healthy/ fit for energisation.
- 22.7 Cable Installation
- 22.7.1 General
- (a) All Cables to be laid in overhead cable tray only. Cable Tray for HV, LV and Control cable should be separate. Underground cable to be avoided, Cables to be laid on racks in underground concrete cable trenches inside the plant only where overhead structure is not possible. Cables may be laid in ground (slit with HDPE conduit) where number of cables to be laid are less and do not justify use of concrete cable trenches.
 - (b) All the cable tray structures shall be painted with two coats of primer and two coats of final paint after necessary surface preparation.
 - (c) Cable OD 40 MM and above shall be clamped individually.
 - (d) Cables shall be clamped only after the cables are neatly arranged, dressed tailored and kept in position. Support of cables on edges of cable trays/ structural steelwork shall be avoided.
 - (e) Power cables shall be laid in one layer only. Control and other cables may, however, be laid in two layers. More than two layers shall not be permitted.
 - (f) All the cable tray network shall be earthed by a continuous earth strip.
- 22.7.2 Cable laying in Trench/ on Racks/ Trays/ Cleated on Wall/ Structure. For proper support, access and neatness of appearance of installation; cables shall be laid on racks or cable trays or cleated on wall and/ or structure taking following into consideration:
- (a) Cable racks/ trays shall be 250 mm apart.

	EMERGENCY DIESEL GENERATORS PACKAGE TALCHER FERTILIZERS LIMITED TECHNICAL SPECIFICATION – ELECTRICAL	PC183/E/4022/SecVI-3.1	0	
		Document No.	Rev	
		Sheet 62 of 68		

- (b) Ladder type FRP cable trays shall be used for laying power cables.
- (c) Perforated type FRP cable trays shall be used for laying control, signal, and communication etc. cables.
- (d) Coaxial cables for data transfer from/ to microprocessor based equipments shall be laid in HDPE conduits with pull boxes fixed to cable supporting racks.
- (e) Top tray shall be used/ left vacant for communication, signaling and fire alarm cables.
- (f) Cables shall be laid in separate trays according to voltage and noise classification. Fire proof partition shall be provided between HV and LV cables.
- (g) Power, control and lighting cables shall be laid in separate cable trays.
- (h) Large size cables shall be clamped individually. Small size cables may be bunched together provided that in any bunch all cables have sheath of same material.
- (i) Cables in trays shall be clamped at not more than every 1500 mm for horizontal run and 800 mm for vertical run and near bends.
- (j) Cable racks/ trays shall be planned in such a way so that at least 20 % or one rack/ tray (whichever is more) can be added in future and at least 20 % free space shall be left in each cable tray for cable laying in future..
- (k) Support to cable trays shall be provided at intervals as required for proper support but at interval not more than 1000 mm.
- (l) Support to trays shall also be provided at each joint of tray irrespective of it's distance from adjacent support.
- (m) FRP trays shall be fixed using nuts and bolts as welding will not be permitted.

22.7.3 Cable laying in conduits

- (a) Cables shall be laid in GI conduits while laying on or crossing floors/ wall/ railway lines/ roads.
- (b) While laying on floor or wall or crossing roads conduits shall be embedded in concrete/wall.
- (c) When laid on floor the top cover shall be minimum 10 mm.
- (d) At rail/ road crossings, the conduits shall be laid not less than 1 meter below top surface of the road.
- (e) Mechanical protection by G.I. Pipe shall be provided to all cables up to 1200 mm from ground/ floor level.
- (f) Minimum diameter of G.I. pipes used for laying/ protection of cables shall be 1.6 times the cable diameter.
- (g) Only one cable shall be laid in one conduit.
- (h) Conduit shall be sealed after cable laying.
- (i) Standard bends or fabricated bends shall not be used. wherever required, conduits shall be bent using bending machine. Bending radius shall not be less than 10 times the diameter of conduit.
- (j) Jointing of the conduits shall be done using sockets which may be welded from top to avoid ingress of water.
- (k) Ends of conduits shall be made smooth to avoid damage to cables.

22.7.4 Cable Jointing

- (a) Joints in cable length less than standard drum length shall not be allowed.

	EMERGENCY DIESEL GENERATORS PACKAGE TALCHER FERTILIZERS LIMITED TECHNICAL SPECIFICATION – ELECTRICAL	PC183/E/4022/SecVI-3.1	0	
		Document No.	Rev	
		Sheet 63 of 68		

- (b) Joints, if unavoidable, shall be made at most suitable places.
- (c) Joints shall not be made at passageways or under rail/ road crossings and in hazardous area.
- (d) Joints shall be segregated by not less than 2 meters so as to reduce the possibility of one joint failure affecting the other.
- (e) Individual cores in cables shall always be joined number to number or colour to colour of the insulation over the conductors.
- (f) Continuity and current carrying capacity for earth conductor and/ or armour shall be provided.
- (g) Cable jointing shall be done by joiners who possess certificate of competency for carrying out particular joint.
- (h) Minimum 2 meters cable loops shall be kept near each joint.

22.7.5 Cable Termination

- (a) Double compression heavy type glands/ heat shrinkable termination kits and bi-metallic/ copper lugs shall be used for termination of cables.
- (b) Paint of the gland plate at the contact point of gland shall be removed for proper contact.
- (c) Cable glands/ termination kits shall be earthed.
- (d) Cables to individual cubicles shall be neatly laid out and supported.
- (e) Cables shall be clamped at a distance of 400 mm from gland/ termination.
- (f) Conductors of control cables shall be neatly arranged in compact group. The entire group shall be placed and tied with nylon straps.
- (g) Spare cores shall be terminated with sufficient length to permit future connection to the terminal block associated with control cables.

22.7.6 Identification

- (a) Cable tags shall be made of non- corrodible material, preferably SS.
- (b) Voltage, cable number etc shall be engraved on each tag.
- (c) Cable tags shall be tied to each cable at
 - (i) All termination (outside as well inside panel/ box.)
 - (ii) All bends.
 - (iii) All points before and after which their route cannot be easily identified.
 - (iv) Entry and exit from conduits.
 - (v) All joints.
 - (vi) Every 15 meter for straight run.

23.0 TESTING OF INSTALLATION AFTER ERECTION

23.1 The Contractor shall carryout tests/ checks after erection of equipment/ cables to check, ensure and demonstrate the conformity of equipment supplied and installation done with the specification and statutory requirement.

23.2 Prior to starting the test, the Contractor shall satisfy himself and ensure that

	EMERGENCY DIESEL GENERATORS PACKAGE TALCHER FERTILIZERS LIMITED TECHNICAL SPECIFICATION – ELECTRICAL	PC183/E/4022/SecVI-3.1	0	
		Document No.	Rev	
		Sheet 64 of 68		

- a. The installation is strictly in accordance with the specification, drawings and statutory requirement.
 - b. Any automatic controls that might vitiate the tests have been relaxed.
 - c. All instruments to be used for testing are suitable for the purpose and have been calibrated by a recognised laboratory within the last 12 months and copy of the calibration certificates have been submitted to the Owner/ Consultant.
 - d. The testing, commissioning, operation and maintenance manuals are available to the testing engineer and Owner/ Consultant.
 - e. Formats for recording test results have been finalised with the Owner/ Consultant and copies have been distributed to all concerned.
- 23.3 The skilled manpower to test all the equipment, cables, earthing etc deputed by Contractor is well aware of and prepared to perform checks/ tests.
 - 23.4 The tests shall be witnessed by the representatives of Owner/ Consultant.
 - 23.5 The Contractor shall compile and tabulate all the test results in agreed formats and submit to Owner/ Consultant for approval prior to acceptance of installation.
 - 23.6 Testing and checking shall be carried out to demonstrate and record prior to completion, that supply and installation meets the requirement/ performances specified. The installation shall be tested in presence of Owner/ Consultant.
 - 23.7 The Contractor shall give at least 24 hours notice to Owner/ Consultant to enable them to witness the test.
 - 23.8 The Contractor shall submit to Owner/ Consultant test record sheets on daily basis.
 - 23.9 Equipment or any part of the installation shall be energised only after all pre-energisation tests are completed and test results are approved by Owner/ Consultant.
 - 23.10 Failure to submit test results as tests are completed may render the Contractor for carrying repeat tests.
 - 23.11 The Contractor shall supply six (6) bound and indexed copies of all tests in agreed formats prior to preliminary acceptance and handing over of the equipment/ installation, duly signed by representatives of the Owner/ Consultant who have witnessed the tests.
 - 23.12 It will be the responsibility of the Contractor to supply/ arrange at his own cost all necessary testing equipment and measuring equipment required for conducting the tests as per applicable standards.
 - 23.13 Should any of the tests reveal any discrepancy or non-conformity, the same shall be attended to and retested before proceeding with any other tests.
 - 23.14 All tests shall be conducted in accordance with this specification, standard specifications of Bureau of Indian Standards, recommendations of IEC and IE Rules.
 - 23.15 Tests checks to done at site shall be inclusive of but not limited to the following:
 - a. Physical Check & Verification : All Equipment/Cables etc
 - b. Tightness of connections : All Equipment/Cables etc
 - c. Checking for cleanliness : All Equipment/Cables etc
 - d. Size & No. of Earth connection : All Equipment/Cables etc
 - e. Erection, alignment, mounting height and clearances : All Equipment/Cables etc
 - f. Insulation Resistance test : All Equipment/Cables etc

	EMERGENCY DIESEL GENERATORS PACKAGE TALCHER FERTILIZERS LIMITED TECHNICAL SPECIFICATION – ELECTRICAL	PC183/E/4022/SecVI-3.1	0	
		Document No.	Rev	
		Sheet 65 of 68		

<ul style="list-style-type: none"> g. Earth continuity test h. Earth Resistance test i. Earth loop impedance test j. No load & rated load current k. No load & rated load P.F. l. No load & rated load Power m. Functional checks n. Primary injection test o. Secondary injection test p. Ratio and polarity test q. Power frequency HV test r. Phase sequence checks s. Winding resistance test t. Direction of rotation u. Free running for 2 Hrs v. Under voltage tests w. Calibration Checks x. Load and Performance tests y. Checking of Voltage, current z. Checking of specific gravity and acid level aa. Illumination levels 	<ul style="list-style-type: none"> : All Equipment/Cables etc : All Equipment/Cables etc : All Equipment/Cables etc : All Motors/ Loads : All Motors/ Loads : All Motors/ Loads : All Equipment & Controls : All switchgear All protective relays/ devices CTs Power & Control circuit /C & bus couplers Motors & Transformers All motors All motors All U/V Devices All instruments UPS, PLC, & Variable Frequency equipment, Battery Bank UPS, PLC, & Variable Frequency equipment Battery All areas
---	---

23.16 It is anticipated that following equipment will be necessary to perform testing of the installation. The Contractor shall, therefore, arrange these as well as any other equipment for testing of the installation.

- a. HV Testing Set
- b. Primary Injection Set
- c. Secondary Injection Set
- d. IR Testers
- e. Earth Continuity testers
- f. Soil resistivity Testers
- g. Earth resistance Testers
- h. Phase to earth loop impedance testers
- i. Mili volt drop testers
- j. Micro-ohm meter
- k. Phase sequence testers
- l. Clip-on ammeters

	EMERGENCY DIESEL GENERATORS PACKAGE TALCHER FERTILIZERS LIMITED TECHNICAL SPECIFICATION – ELECTRICAL	PC183/E/4022/SecVI-3.1	0	
		Document No.	Rev	
		Sheet 66 of 68		

- m. Voltmeters
- n. Power factor meter
- o. Frequency meter
- p. 3 Ph 4 wire unbalance load kWh meter
- q. Cable fault location equipment
- r. Digital multi-meter suitable for testing IC voltage and current levels
- s. Analogue Multi-meters
- t. Portable multi-range precision ammeters, voltmeters complete with CTs, PTs for AC/ DC circuits.
- u. Protection relay test plugs
- v. Portable earthing equipment
- w. Dual beam oscilloscope with storage facility.
- x. UV recorder
- y. Illumination level meter
- z. Thermometers
- aa. Power Analyser / Portable Power Meter
- bb. Rpm meter
- cc. Noise meter

23.17 At least following tests shall be specifically conducted before commissioning in presence of owner's representative. All the test results shall be recorded and submitted to the owner.

- a) Insulation Test
- b) Continuity Test
- c) High Voltage Test
- d) Simulation Test
- e) Earth Resistance Test

24.0 **QUALITY ASSURANCE**

- 24.1 All equipment, components, materials proposed to be supplied by Contractor shall be procured, manufactured, erected, commissioned and tested as per a comprehensive Quality Assurance Programme (QAP) to be approved by the Owner/ Consultant.
- 24.2 The Successful Bidder shall submit within 1 Month of from order; Quality Assurance Plan (QAP) for all the equipment/ panels/ cables/ motors/ devices etc. under their scope of supply.
- 24.3 All routine and acceptance tests shall be carried out as per relevant IS / IEC/ Other Standards during inspection at manufacturer's works in presence of Owner or his representative.
- 24.4 The Contractor shall submit type test certificates for similar equipment supplied by him elsewhere. In case type test certificates (not more than 5 years old and conducted at duly accredited laboratory) for similar equipment is not available, the type test shall be conducted in presence of Owner or his representative without any financial implications to Owner.
- 24.5 The inspection procedure shall be finalized and approved by Owner and/ or their consultant/ authorized representative.
- 24.6 Inspection will be carried out as per drawings and quality assurance plan approved by the Owner/ Consultant. Inspection shall be carried out either at manufacturer's shop/ works or any other place where facilities for conducting tests/ checks are available.

	EMERGENCY DIESEL GENERATORS PACKAGE TALCHER FERTILIZERS LIMITED TECHNICAL SPECIFICATION – ELECTRICAL	PC183/E/4022/SecVI-3.1	0	
		Document No.	Rev	
		Sheet 67 of 68		

- 24.7 Owner reserves the right to witness any of the tests and verify the documents of the Contractor , his supplier/ vendor/ manufacturer.
- 24.8 Manufacture test certificate for bought out components shall be submitted during inspection.
- 24.9 No equipment or part items shall be dispatched without final acceptance certificate and dispatch instructions in writing issued by Owner and/or their authorized representatives.
- 24.10 The Contractor shall carry out an inspection and testing programme during manufacture in his works and/ or that of his vendor's works to ensure accuracy/ correctness/ completeness of components, compliance with drawings, conformance to functional and / or performance requirements, identify and acceptability of all materials, parts and equipment. The Contractor shall also carry out all tests/ inspections required to establish that the items/ equipment conform to requirements of the specification and the relevant codes/ standards specified in the specification in addition to carrying out tests as per the approved Quality Plan.
- 24.11 Quality audit/ surveillance/ approval of the results of the tests and inspection, approval of drawings will not, however, prejudice the right of the Owner to reject the equipment at any subsequent stage if it does not comply with the specification or does not give complete satisfaction in service and shall in no way limit the liabilities and responsibilities of the Contractor of ensuring complete conformance of the materials/ equipment supplied to relevant specification, standard, data sheets, drawings etc.
- 24.12 The owner or their representative shall be allowed to visit the manufacturing works for stage inspection during manufacturing stage.
- 24.13 The Contractor shall intimate the owner 4 weeks in advance of the tests and submit the detailed schedule of tests.
- 24.14 Contractor s shall supply reports of type tests, acceptance tests, all requisite factory tests and site tests in bound volumes.
- 24.15 All the equipment shall be tested at site to know their condition and to prove suitability for energisation and required performance.
- 25.0 **COORDINATION WITH OTHER CONTRACTORS**
- 25.1 Contractor shall coordinate with Owner's other Contractors and shall freely exchange all technical information required for this purpose.
- 25.2 All civil works connected with electrical installation shall be under the Contractor's scope.

	EMERGENCY DIESEL GENERATORS PACKAGE TALCHER FERTILIZERS LIMITED TECHNICAL SPECIFICATION – ELECTRICAL	PC183/E/4022/SecVI-3.1	0	
		Document No.	Rev	
		Sheet 68 of 68		



ANNEXURE-I

ILLUMINATION LEVELS

Average illumination levels (Mean Lux) for various areas shall be as follows:

Sl. No.	AREA	LUX
1.0	<u>PLANT</u>	
1.1	Operating platforms	100
1.2	Non-operating platform/ general process areas & walk ways	50
1.3	Area near large rotating equipment/plant	200
2.0	<u>SUB-STATION</u>	
2.1	Switch room - Front of panel	250
	- Back of panel	150
	- Battery room	150
3.0	<u>CONTROL ROOMS</u>	
3.1	Front of panel	500
3.2	Back of panel	200
4.0	<u>PANIC LIGHTING</u>	10

Lux level for A.C. Emergency lighting in Control Room shall be 250 lux.



 <p>पी डी आई एल PDIL</p>	<p>TALCHER FERTILIZERS LIMITED TECHNICAL SPECIFICATION - UPS SYSTEM</p>	PC183-TS-0802	0	 <p>Talcher Fertilizers</p>
		Document No.	Rev	
		Sheet 1 of 11		

TECHNICAL SPECIFICATION

UNINTERRUPTED POWER SUPPLY

CONTENTS

SECTION NUMBER	DESCRIPTION
1.0	SCOPE
2.0	STANDARDS TO BE FOLLOWED
3.0	AMBIENT CONDITIONS & ELECTRICAL SYSTEM CHARACTERISTICS
4.0	DESIGN AND OPERATIONAL REQUIREMENTS
5.0	CONSTRUCTIONAL DETAILS
6.0	COMPONENT DETAILS
7.0	OPTIONAL ITEMS
8.0	PAINTING
9.0	TESTS AND INSPECTION
10.0	DRAWINGS AND DOCUMENTS
11.0	SPARES
12.0	PACKING
ANNEXURE - I	DOCUMENTATION FOR UNINTERRUPTED POWER SUPPLY
ANNEXURE - II	METERING INDICATIONS AND ALARM SCHEDULE

	TALCHER FERTILIZERS LIMITED TECHNICAL SPECIFICATION - UPS SYSTEM	PC183-TS-0802	0	
		Document No.	Rev	
		Sheet 3 of 11		

1.0 SCOPE

- 1.1 The specification covers the design, manufacture, testing at works and despatch in well packed condition of Uninterrupted Power Supply System required to supply AC power for non linear loads (i.e. instrumentation loads).
- 1.2 This standard shall be read in conjunction with block diagram & UPS distribution diagram.
- 1.3 The scope shall include the following:
- i) Full wave controlled rectifier
 - ii) Inverter
 - iii) Static switches
 - iv) Storage battery
 - v) Static voltage stabilizer for bypass supply
 - vi) Manual bypass switches
 - vii) Isolation / output transformer to achieve desired output voltage
 - viii) UPS Distribution Boards
 - ix) Interconnecting cabling between various units of UPS
 - x) All other items required, but not specified for safe and reliable operation of UPS system.

2.0 STANDARDS TO BE FOLLOWED



- 2.1 The equipment shall conform to the latest issue of the following and relevant Indian Standard specifications Equipment complying with equivalent IEC standards shall also be acceptable.
- | | |
|----------|--|
| IS-13314 | - Solid state inverters run from storage batteries |
| IS-11260 | - Stabilized power supplies AC output |
| IEC-146 | - Solid state inverters |
- 2.2 The equipment shall also conform to the provision of Indian Electricity Rules, Indian Supply Act and any other statutory regulations in force from time to time.

3.0 AMBIENT CONDITIONS & ELECTRICAL SYSTEM CHARACTERISTICS

These shall be as specified in the enclosed Design Philosophy - Electrical.



4.0 DESIGN AND OPERATIONAL REQUIREMENTS

- 4.1 The UPS unit and its associated equipments shall be suitable for operating at the specified rating continuously with the specified voltage and frequency variations under the ambient conditions without exceeding the temperature rise limits specified in relevant standards and without any detrimental effect on any part.
- 4.2 The UPS system shall be based on latest generation of IGBT based, pulse width modulated (PWM) design with proven performance. The basic scheme required for UPS system shall be as indicated in Block diagram in this specification.
- 4.3 The UPS shall have Redundant Scheme with Bypass. Under normal operating conditions, both inverter units should run in parallel sharing 50% load in synchronism with by-pass power and supply uninterrupted A.C. power to load. On failure of one of these inverters, the faulty inverter should get automatically disconnected from the load and healthy inverter should supply 100% load in synchronism with by pass supply. In

	TALCHER FERTILIZERS LIMITED TECHNICAL SPECIFICATION - UPS SYSTEM	PC183-TS-0802	0	
		Document No.	Rev	
		Sheet 4 of 11		

the event of second inverter also developing a fault, a no-break load transfer to standby power supply should take place through static switch.



- 4.4 Output frequency of the inverters must remain synchronised to one another which in turn shall be synchronised to the standby power supply frequency provided the latter does not vary by more than +3% to -5%. It should be possible to change the setting of frequency range of synchronism between above limits by frequency selector switch. Outside these limits inverter should desynchronise with the bypass and run at its own frequency. When running at its own frequency, frequency variation shall be maintained less than $\pm 1.0\%$. Resynchronisation with bypass power supply must take place automatically with some time delay when frequency comes back to +3% to -5% range. Change-over from inverter to bypass or bypass to inverter shall also be possible in desynchronised mode of operation. Change-over time in both synchronised and desynchronised mode operation shall be indicated.
- 4.5 The UPS unit shall be suitable for 0.7 lagging to unity power factor. The overall power factor may be taken as 0.8 lagging.
- 4.6 The maximum waveform distortion of the output voltage shall not exceed 5% r.m.s. for linear loads and 10% r.m.s for non-linear loads. The UPS unit shall be suitable for operation for non-linear loads having crest factor of 3.
- 4.7 The inverter steady state output voltage and frequency (free running) variation shall not exceed $\pm 1\%$ for specified input power supply condition and no-load to full load condition.
- 4.8 Voltage dip / rise on sudden application / throw of 100% load or on changeover from inverter to bypass or vice versa shall not exceed 15% and shall be recovered within 100 m. sec. to rated voltage.
- 4.9 UPS shall be designed for overload of 125% for 10 min. and 150% for 10 sec. after which drooping characteristic shall come into operation.
- 4.10 On failure of the main supply, inverter unit shall continue to supply rated load from the battery bank for two hours duration.
- 4.11 Charger shall simultaneously supply entire power necessary for inverter and to keep the battery of required capacity in fully charged condition. Provision for automatic charging in both float and boost shall be made.
- 4.12 Battery shall be Nickel-Cadmium or Lead Acid Plate tubular positive plate or VRLA type. The battery capacity shall be decided considering load power factor as 0.8, derating factor for ageing 0.8 and derating for minimum ambient temperature as applicable.
- 4.13 The ventilation fans, if provided shall be fully redundant and connected to the output from the inverter and an audio-visual alarm shall be provided on its failure. It shall be possible to operate inverter for about half an hour even after the failure of the fan without temperature rise inside the inverter cubicle exceeding the safe operating temperature limits.
- 4.14 In case of inverter failure due to any reason or overload, affected unit shall be isolated and changeover to other inverter or to bypass shall take place automatically.
- 4.15 Noise level at a distance of 1m from UPS panels shall not exceed 60 dB.
- 4.16 UPS system shall be provided with necessary control, protection, metering, indication, alarm & annunciation for reliable and safe operation of the system. The suggestive list is indicated in Annexure-II.

	TALCHER FERTILIZERS LIMITED TECHNICAL SPECIFICATION - UPS SYSTEM	PC183-TS-0802	0	
		Document No.	Rev	
		Sheet 5 of 11		

- 4.17 All semi-conducting devices shall be protected by fast acting semi-conducting fuses. These fuses shall be co-ordinated with load side HRC fuses.
- 4.18 The battery may be taken out of service for maintenance during which period it shall be possible for the inverter to continue operation taking power from the rectifier. The input filter of the inverter shall be suitably designed to take care of this operational requirement.
- 4.19 It shall be possible to vary the output voltage steplessly within $\pm 5\%$ of the specified output voltage. This adjustment shall be possible to be made when UPS is in operation.
- 4.20 UPS system shall be suitable for both floating output and earthing of one leg in case of single phase system / star-point in case of three phase system.
- 4.21 The UPS system shall have very high system of reliability having minimum MTBF of 50,000 hrs. Vendor shall furnish the value of MTBF, MTTR & availability factor.

5.0 CONSTRUCTIONAL DETAILS

- 5.1 The equipment shall preferably be supplied in enclosed, dust & vermin proof, floor mounted, sheet steel enclosure. In case, it is necessary to provide opening for ventilation, this should be closed by fine mesh. Minimum degree of protection for enclosure shall be IP-43 as per IS/IEC-60947.
- 5.2 Enclosure shall be fabricated with cold rolled sheet annealed steel of minimum thickness 2.0 mm.
- 5.3 The door hinges shall be concealed type. The doors and the removable covers shall be provided with non-deteriorating neoprene gaskets without any discontinuities. Gaskets shall be held in position in groove in shaped sheet steel work or these shall be of U type.
- 5.4 All external hardware shall be cadmium plated steel. Hardware for fixing the removable parts shall be provided with retaining devices.
- 5.5 Panels shall be liberally designed. All components shall be so mounted that they are easily accessible for inspection and maintenance.
- 5.6 UPS unit shall preferably have separate panels for each rectifier inverter units, bypass supply, distribution boards etc. Various panels of UPS except distribution boards shall be mounted side-by-side & bolted together to form compact assembly.
- 5.7 Distribution boards shall be of fixed type single front execution in fully compartmentalised design and divided into distinct panels each comprising of bus-bar chambers, individual feeder modules and vertical cable alley.
- 5.8 Mounting height of components requiring operation and observations shall not be lower than 300 mm and higher than 1800 mm.
- 5.9 All the live parts which are accessible after opening the front cover / back cover shall be properly insulated or provided with insulating barrier to prevent accidental contact. Bus bars of distribution boards shall be PVC sleeved.
- 5.10 Nameplate consisting of black Perspex with white engraving shall be provided for each panel and for each equipment mounted on the front of the panel. Suitable label identification for each component mounted inside the panel shall also be provided.
- 5.11 All the wirings shall be properly laid and ferruled at both ends. PVC channels may be used for wiring. For control wiring, minimum 1.5 sq. mm copper conductor shall be used.

	TALCHER FERTILIZERS LIMITED TECHNICAL SPECIFICATION - UPS SYSTEM	PC183-TS-0802	0	
		Document No.	Rev	
		Sheet 6 of 11		

- 5.12 The power connections shall be made by PVC insulated flexible copper cables or taped copper / aluminium strip.
- 5.13 All power & control cables shall enter from the bottom.
- 5.14 Removable bolted aluminium gland plate, heavy duty compression type rolled aluminium cable glands, crimping type aluminium cable lugs for Al. cables and copper cable lugs for Cu. cables, pressure clamp / bolted type terminals etc. shall be provided for each incoming and outgoing cable.
- 5.15 Terminal blocks shall be grouped according to circuit functions and suitably numbered. 20% extra terminals shall be provided in the terminal block.
- 5.16 A suitably sized earth bus shall be provided at the bottom of panel with provision for earth connection at both ends to purchaser's earth grid.
- 5.17 All panels shall be of same height so as to form a bank which shall give good aesthetic appearance.

6.0 COMPONENT DETAILS

- 6.1 All components shall conform to relevant IS / IEC standards and shall be of reputed make. Makes of all components shall be subject to owner's / consultant's approval.

6.2 Thyristors, diodes and transistors

The thyristors, diodes and transistors shall have adequate safety margins to withstand specified operating conditions. A factor of safety of minimum 4 shall be taken against voltage surges.

6.3 PCBs

All electronic control & monitoring printed circuit cards shall preferably be modular plug in type. Monitoring points shall be provided in each of the PCB, PCBs shall be firmly clamped in position so that vibration or long usage does not result in loose contacts. Failure of each PCB shall be indicated by visual alarm and indication. The visual fault diagnostic shall preferably indicate fault into various sections of the card.

6.4 Transformers and Chokes

All transformers and chokes shall be of dry type and air cooled. This shall be class 'H' insulated, vacuum impregnated. Class B insulated cast resin transformers and chokes shall be also acceptable.

6.5 Electrolytic Capacitors

These shall be polarised aluminium type I, suitable for long life and category I, as per IS-4317 or equivalent IEC. The capacitor shall preferably be self healing type. These shall be so located in inverter panels that the operating temperature does not exceed 65°C maximum.

6.6 Instruments



Ammeters & voltmeters shall be moving coil type of class 1.5 accuracy as per IS-1248. These shall be flush mounting type of minimum size of 96 mm x 96 mm and shall have taut band scale of 240°. Frequency meter shall be of reed type having range of 45 Hz to 55 Hz.

6.7 Static Switches

Static switches shall be naturally commutated type with parallel inverse connected thyristors. These shall be rated for continuous duty for 100% load. Short time rated static switches are not acceptable.

6.8 Voltage Stabilizer

Voltage stabilizer shall be static type and shall satisfy the following requirements:

	TALCHER FERTILIZERS LIMITED TECHNICAL SPECIFICATION - UPS SYSTEM	PC183-TS-0802	0	
		Document No.	Rev	
		Sheet 7 of 11		

- i) Maximum output voltage variation under steady state condition shall be $\pm 3\%$.
- ii) Maximum harmonic distortion shall be less than 5%.
- iii) The output voltage shall be restored within $\pm 2\%$ of nominal value in less than 2 secs.

6.9 **Battery**

Battery along with accessories shall conform to Engineering Standard ES-0814.

6.10 **Indication Lamps**

All indication lamps shall be of LED type suitable for the specified control voltage, having minimum illumination of 40 milli candela. The colour of the LEDs shall be as follows:

ON	:	Red
OFF	:	Green
FAULT	:	Yellow

6.11 **Moulded Case Circuit Breakers**

For isolating devices of various equipment, moulded case circuit breakers shall be used. These shall be provided with overload and short circuit protective devices and shall conform to IS 2516.

7.0 **OPTIONAL ITEMS**

These shall supplied as per requireemnt.

7.1.1 **Monitoring System** Microprocessor based monitoring system for UPS to supervise the UPS operation and to print out the following data at a preset time automatically by using its own printer shall be provided.



- i) Output voltage of UPS (Common)
- ii) Output current of UPS (Common)
- iii) Input DC voltage of each inverter
- iv) Input voltage of each rectifier (Ph to Ph)
- v) Input current of each rectifier
- vi) Output current of each inverter
- vii) Output voltage of each inverter
- viii) Room temperature
- ix) Input frequency of each inverter
- x) Output frequency of each inverter

7.1.2 In addition to print out once in a preset time, above data shall also be automatically printed for the following conditions:

- i) Power source change over from mains to battery and vice-versa.
- ii) Change over of load from UPS to bypass supply and vice versa.
- iii) On failure of UPS
- iv) On failure of either inverter
- v) Also facility for on demand print out of above data shall be provided.

7.1.3 On failure of UPS, the printer shall print out the waveform of the following:

- i) Output voltage of UPS

	TALCHER FERTILIZERS LIMITED TECHNICAL SPECIFICATION - UPS SYSTEM	PC183-TS-0802	0	
		Document No.	Rev	
		Sheet 8 of 11		

- ii) Output current of UPS
- iii) Output voltage of each UPS
- iv) Output current of each UPS

7.2 **Insulation monitoring & automatic earth fault finding system**

Insulation monitoring and automatic earth fault finding system shall be provided to detect earth fault in unearthed system. The system shall preferably be of the type which injects a low frequency alternating voltage between the earth and the network which is used for determining the insulation resistance and to detect and locate earth faults. There shall be fixed detectors located in incoming feeders of main distribution boards and portable detector for location of fault within a feeder. The fixed detector shall be connected to a central unit which can display a faulty feeder.

7.3 Potential free contact shall be brought to outgoing terminal for remote monitoring system for the following:

- i) UPS-1 fault
- ii) UPS-2 fault
- iii) Load on inverter
- iv) Load on bypass

8.0 **PAINTING**

8.1 The enclosure after suitable pre-treatment shall be painted with two coats of anti-rust paint followed by two coats of anticorrosive paint.

8.2 All paints shall be carefully selected to withstand tropical heat and extremes of weather. The paint shall not scale off, crinkle or be removed by abrasion due to normal handling.



8.3 Unless otherwise specified, the finishing shade shall be light grey shade no.631 as per IS: 5.

8.4 Electrostatic powder paint shall be preferred.

9.0 **TESTS AND INSPECTION**

9.1 The UPS units shall be subjected to tests as per relevant standards. The tests shall include, but not limited to the following:-

- i) Rectifier & inverter soft starting
- ii) Regulation test
- iii) Heat run test for 8 hours
- iv) Overload test
- v) Test for changeover time in synchronised and desynchronised mode.
- vi) Test for dynamic response and transient performance
- vii) Sequence & transfer test
- viii) Noise level measurement
- ix) Test to check the selectivity of protective devices
- x) Alarm test (simulation of various fault conditions)
- xi) Measurement of harmonic distortion
- xii) Ventilation test (operation without fan)

	TALCHER FERTILIZERS LIMITED TECHNICAL SPECIFICATION - UPS SYSTEM	PC183-TS-0802	0	
		Document No.	Rev	
		Sheet 9 of 11		

xiii) Insulation test

xiv) Current division in parallel UPS

9.2 All the above tests shall be carried out in presence of purchaser's representative. In addition, the equipment shall be subjected to stage inspection during process of manufacture at works and site inspection.

9.3 These inspections, shall, however, not absolve the vendor from his responsibility for making good any defects which may be noticed subsequently.

10.0 DRAWINGS AND DOCUMENTS

10.1 Drawings and documents as per Annexure-I shall be supplied, unless otherwise specified.

10.2 All drawings and documents shall have the following description written boldly.

- Name of client
- Name of consultant
- Enquiry / order number with plant / project name
- Equipment Code no. & Description

11.0 SPARES

11.1 Commissioning Spares : Commissioning spares, as required, shall be supplied with the main equipment. Item-wise list of recommended commissioning spares shall be furnished for information.

11.2 Spares for 2 Years Operation (Mandatory), as specified shall be supplied.

11.3 List of Recommend Spares (other than Mandatory Spares) alongwith recommended quantity shall be furnished.

11.4 All spare parts shall be identical to the parts used in the equipment

12.0 PACKING

12.1 The board shall be properly packed before despatch to avoid damage during transport, storage and handling.

12.2 The packing box shall contain a copy of the installation, operation and maintenance manual.

12.3 A sign to indicate the upright position of the panels to be placed during transport and storage shall be clearly marked. Also proper arrangement shall be provided to handle the equipment.

ANNEXURE - I



DOCUMENTATION FOR UNINTERRUPTED POWER SUPPLY

Sl. No.	Description	Documents Required (Y / N)		
		With Bid	For Approval	Final
1.	Specification sheet	N	Y	Y
2.	Technical Particulars	N	Y	Y
3.	Block Diagram	N	Y	Y
4.	General Arrangement drawings and foundation plan	N	Y	Y
5.	Calculation for battery sizing	N	N	N
6.	Feeder Details for Distribution Boards	N	Y	Y
7.	Descriptive literature and catalogues	N	N	Y
8.	Bill of materials	N	Y	Y
9.	Schematic & Wiring Diagram	N	Y	Y
10.	Installation, operation & maintenance manual	N	N	Y
11.	Spare parts list with identification	N	N	Y
12.	Test Certificates	N	N	Y
13.	Guarantee certificates	N	N	Y

Note:

1. 4 hard copies & 1 soft copy shall be supplied for approval after order within 4 weeks from the date of LOI.
2. 8 hard copies & 2 soft copies in CD shall be submitted as final documents prior to despatch of the equipment. These shall be made in sets and supplied in fine plastic coated folder.

Y - Yes, N – No

	TALCHER FERTILIZERS LIMITED TECHNICAL SPECIFICATION - UPS SYSTEM	PC183-TS-0802	0	
		Document No.	Rev	
		Sheet 11 of 11		

ANNEXURE – II

METERING INDICATIONS AND ALARM SCHEDULE

A. METERING

1. Incoming Voltmeter with selector switches for each incomer
2. Ammeter with selector switches for each incomer
3. Ammeter & Voltmeter at each inverter output and bypass output.
4. Frequency meter & power factor meter at one common point of output
5. Ammeter & Voltmeter at incoming of each UPS distribution boards
6. Ammeter at each rectifier output
7. Battery charge / discharge meter

B. LED INDICATION

1. A.C. Mains 'ON'
2. Rectifier output 'ON'
3. Load on inverter
4. Load on bypass
5. Inverter synchronised to mains
6. Battery on float
7. Battery on boost
8. Fault (one lamp for all types of fault)

C. AUDIO-VISUAL ALARM (with Accept, Reset & Test facilities)

1. Mains failure
2. Rectifier failure
3. Inverter output over voltage
4. Inverter output under voltage
5. Inverter fuse failure
6. Rectifier fuse failure
7. Fan failure
8. Inverter temperature high
9. Static switch failure
10. Bypass input failure
11. Inverter desynchronised

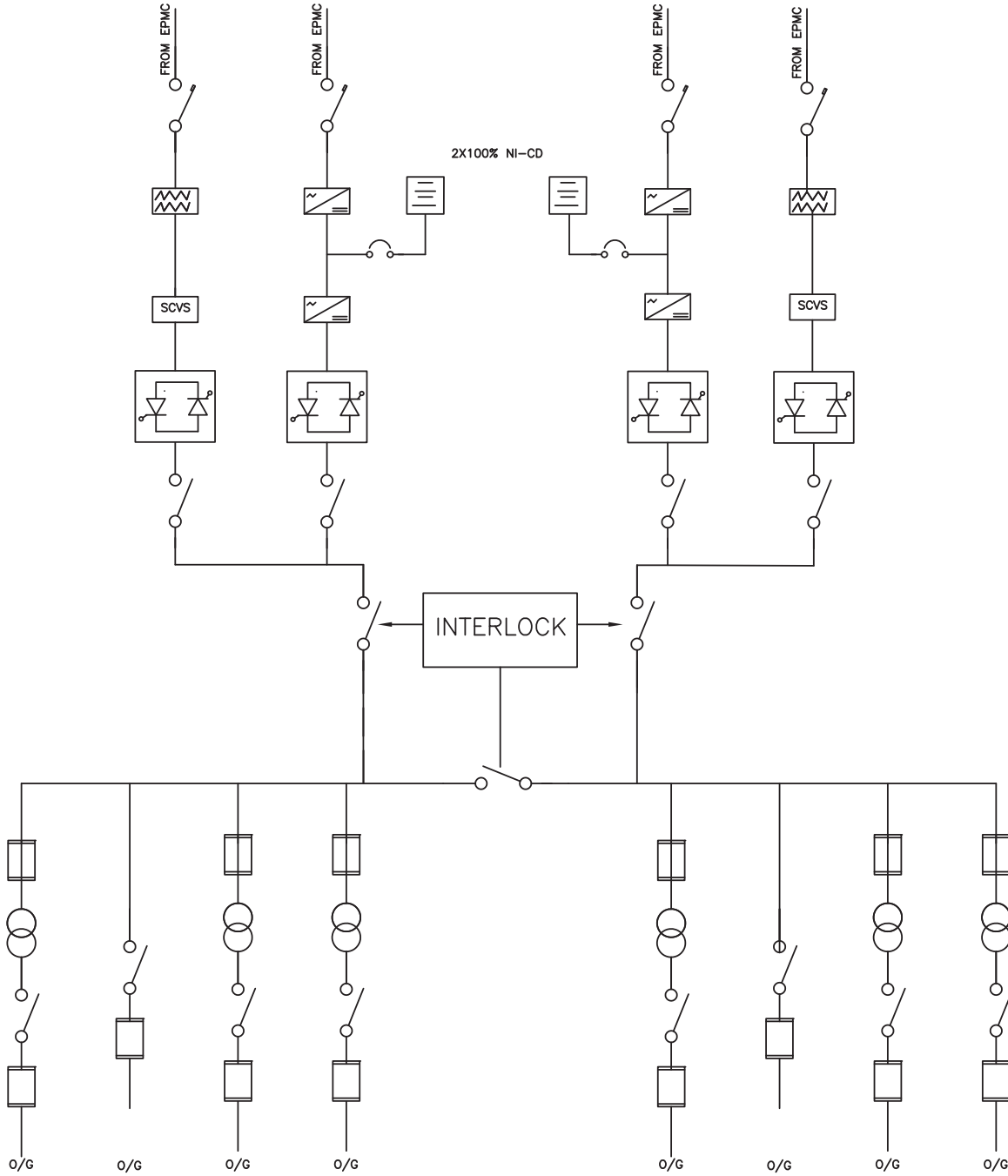

TYPICAL ACDB ARRANGEMENT
UPS SYSTEM

1ACDB SHALL HAVE TWO NO. INCOMER AND ONE NO. BUS COUPLER
2BATTERY CHARGER AND BATTERY FOR UPS SHALL BE AS PER JOB SPECIFICATION.

0	09.06.21	09.06.21	FOR ENQUIRY	AK	RK	SKB
REV	REV.DATE	EFF.DATE	PURPOSE	PREPD	REVWD	APPD



TALCHER FERTILIZERS LIMITED
TECHNICAL SPECIFICATION - NEUTRAL EARTHING
RESISTORS

PC183-TS-0804

0

Document No.

Rev

Sheet 1 of 7



TECHNICAL SPECIFICATION
NEUTRAL EARTHING RESISTOR



CONTENTS

SECTION NUMBER	DESCRIPTION
1.0	SCOPE
2.0	STANDARDS TO BE FOLLOWED
3.0	SERVICE CONDITIONS
4.0	OPERATING REQUIREMENTS
5.0	GENERAL DESIGN AND CONSTRUCTIONAL FEATURES
6.0	ACCESSORIES
7.0	PAINTING
8.0	TESTS AND INSPECTION
9.0	DRAWINGS AND DOCUMENTS
10.0	SPARES
11.0	PACKING
ANNEXURE - I	DOCUMENTATION FOR NEUTRAL EARTHING RESISTORS



TALCHER FERTILIZERS LIMITED
TECHNICAL SPECIFICATION - NEUTRAL EARTHING
RESISTORS

PC183-TS-0804

0

Document No.

Rev

Sheet 3 of 7



1.0 SCOPE

- 1.1 This standard covers the technical requirements of design, manufacture, testing at works and despatch in well packed condition of Neutral Earthing Resistor for earthing the neutral of power transformers / generators for limiting the line to ground fault current.
- 1.2 This standard shall be read in conjunction with the relevant part of Design Philosophy – Electrical.

2.0 STANDARDS TO BE FOLLOWED

- 2.1 The design, manufacture and testing of the equipment covered by this standard shall comply with the latest issue of IS 3043, unless otherwise specified. Equipment complying with equivalent IEC standards shall also be acceptable.
- 2.2 The design and operational features of the equipment shall also comply with the provisions of latest issue of the Indian Electricity Rules and other relevant Statutory Acts and Regulations. The supplier shall, wherever necessary, make suitable modifications in the equipment to comply with the above.
- 2.3 Wherever any requirement, laid down in this standard, differs from that in Indian Standard Specifications, the requirement specified herein shall prevail.

3.0 SERVICE CONDITIONS

3.1 Ambient Conditions

These shall be as indicated in Design Philosophy – Electrical.

3.2 System Details

These shall be as indicated in Design Philosophy – Electrical.

4.0 OPERATING REQUIREMENTS

- 4.1 The neutral earthing resistor shall be suitable for carrying the rated current for duration of 30 seconds under the specified ambient conditions and voltage and frequency variations without the temperature exceeding 350°C.
- 4.2 The resistor shall be designed to carry continuously 20% of the rated short time current without any harmful effect.
- 4.3 The housing shall be sized such that temperature rise of the metal parts through which current is not required to pass, when rated current is passed for the specified period, shall not exceed 40°C.

5.0 GENERAL DESIGN AND CONSTRUCTIONAL FEATURES

5.1 Resistors

- 5.1.1 The resistance bank shall be of heavy duty non-inductive type having high specific resistance and low temperature co-efficient.
- 5.1.2 The resistor elements shall be made of joint-less, non-corroding, sturdy and oxidation resistant AISI 304 / AISI 406 stainless steel of punched / formed construction.
- 5.1.3 The contact between elements shall be made by individually bolting the terminals of two adjacent elements and connecting them in series, parallel or combination of both to achieve the specified resistance. The interconnecting link shall be zinc plated copper of uniform cross section throughout.
- 5.1.4 The resistance grid shall be properly supported so that damage due to vibration and thermal or mechanical stresses is avoided.



TALCHER FERTILIZERS LIMITED
TECHNICAL SPECIFICATION - NEUTRAL EARTHING
RESISTORS

PC183-TS-0804

0

Document No.

Rev

Sheet 4 of 7



5.1.5 Porcelain / Epoxy insulators rated for the highest system voltage shall be used to insulate the resistor elements from the body of the housing.

5.1.6 Insulation level for resistor bank shall be as follows:

Highest system voltage	Power frequency withstand voltage	Impulse withstand Voltage
Up to 3.6 KV peak	10 KV RMS	40 KV
7.2 KV peak	20 KV RMS	60 KV

5.2 Metal clad housing

5.2.1 The housing shall be fabricated out of 3 mm thick sheet steel fitted on a 6 mm thick mild steel frame work. This shall be floor mounting type and rectangular in shape.

5.2.2 It shall be suitable for outdoor installation and shall have minimum degree of protection IP: 43 as per IS 2147. Ventilating louvers, if provided, shall be covered by fine wire mesh from inside and shall be such that the above degree of protection for the enclosure is not altered. Top cover of the housing shall be slopping construction to prevent accumulation of water.

5.2.3 All external hardware below 8 mm size shall be of stainless steel and those of higher size of mild steel cadmium plated or zinc passivated.

5.3 Isolation Arrangement

5.3.1 An isolator shall be provided on the incoming side to isolate the resistors from the main equipment.

5.3.2 The isolating switch shall be single pole knife type having a rating of 1.5 times the rated current of the resistor. The switch shall have four sets of potential free auxiliary contacts, 2 NO and 2 NC for remote indication, wired to a terminal block. An external handle, suitably insulated and lockable both in the ON and OFF positions, shall be provided for the switch. The handle shall preferably be mounted at a height of 1.5 meters from the base of the housing.

5.4 Current Transformers

Epoxy moulded current transformer of accuracy 5P for stand by earth fault protection and PS for restricted earth fault protection shall be provided, as per requirement. The CT connections shall be brought to separate terminal box with shorting arrangement.

5.5 Terminal Arrangement

5.5.1 For incoming connection, either bushing or cable box arrangement shall be provided. In case of bushing connection, the bushing shall be provided on top of the housing. In case of cable box connection, the same shall be mounted on the side of the housing.

5.5.2 For the outgoing connection, cable box arrangement is to be considered in all cases. The cable box shall be mounted on the side of the housing.

5.5.3 Heavy duty double compression type rolled aluminium cable glands shall be provided for all the incoming and outgoing cables.

5.5.4 The equipment terminals shall be anti loosening type and complete with tinned copper cable lugs suitable for cables of specified size. For bushing connections, suitable tinned copper conductor shall be provided as per conductor size specified.



TALCHER FERTILIZERS LIMITED
TECHNICAL SPECIFICATION - NEUTRAL EARTHING
RESISTORS

PC183-TS-0804

0

Document No.

Rev

Sheet 5 of 7



6.0 ACCESSORIES

6.1 The equipment shall be complete with cable glands, cable lugs, drain plug, lifting hook, name plate, foundation bolts and all other accessories required to make the equipment complete in all respects.

6.2 Name Plate

6.2.1 Name plate shall be of stainless steel with letters embossed on them.

6.2.2 The name plate shall contain all the required details and shall include at least the following:

- i) Make
- ii) Description of code no. of equipment
- iii) Short time rating
 - a) Current
 - b) Duration
- iv) Rated voltage
- v) Maximum temperature rise over ambient
- vi) Total resistance at ambient temp.
- vii) Materials of resistors
- viii) Degree of protection of enclosure

7.0 PAINTING

7.1 The enclosure, after suitable pre-treatment shall be painted with two coats of antirust paint followed by two coats of anti-corrosive paints.

7.2 Epoxy based paints shall be used.

7.3 All paints shall be carefully selected to withstand tropical heat and extremes of weather. The paint shall not scale off, crinkle or be removed by abrasion due to normal handling.

7.4 The finishing paint shall be light grey shade no. 631 as per IS 5.

8.0 TESTS AND INSPECTION

8.1 Following tests shall be carried out on the neutral earthing resistors:

8.1.1 Routine Tests

- i) Resistance value measurement at room temperature.
- ii) Power frequency high voltage test for one minute.
- iii) Insulation resistance test.

8.1.2 Type test

- i) Heat run test.

8.2 The above mentioned tests shall be carried out in the presence of purchaser's representative. In addition, the equipment shall be subjected to stage inspection during process of manufacture at works and inspection at site for final acceptance.

8.3 The purchaser's inspection shall, however, not absolve the vendor from his responsibility for making good any defects which may be noticed subsequently.

	TALCHER FERTILIZERS LIMITED TECHNICAL SPECIFICATION - NEUTRAL EARTHING RESISTORS	PC183-TS-0804	0	
		Document No.	Rev	
		Sheet 6 of 7		

9.0 DRAWINGS AND DOCUMENTS

- 9.1 The drawings and documents as per Annexure-I shall be furnished unless otherwise specified.
- 9.2 All drawings and documents shall have following descriptions written boldly.
- Name of the client
 - Name of consultant
 - Enquiry / order number with plant / project name
 - Equipment code no. and Description.

10.0 SPARES

- 10.1 Commissioning Spares : Commissioning spares, as required, shall be supplied with the main equipment. Item-wise list of recommended commissioning spares shall be furnished for information.
- 10.2 Spares for 2 Years Operation (Mandatory), as specified shall be supplied.
- 10.3 Recommend Spares (other than Mandatory Spares) alongwith recommended quantity shall be furnished.
- 10.4 All spare parts shall be identical to the parts used in the equipment.

11.0 PACKING

- 11.1 The neutral earthing resistor shall be properly packed to safeguard against weather conditions and handling. It shall be wrapped in polythene bag with an additional wrapping of bitumen paper to make it completely waterproof before the equipment is packed in wooden crates.
- 11.2 A sign to indicate the upright position of the panel for placing during transport and storage shall be clearly marked.
- 11.3 Packing box shall include one copy of the installation operation and maintenance manual



TALCHER FERTILIZERS LIMITED
TECHNICAL SPECIFICATION - NEUTRAL EARTHING
RESISTORS

PC183-TS-0804

0

Document No.

Rev

Sheet 7 of 7



ANNEXURE - I

DOCUMENTATION FOR NEUTRAL EARTHING RESISTORS

Sl. No.	Description	Documents Required (Y / N)		
		With Bid	For Approval	Final
1.	Specification Sheet	N	Y	Y
2.	Technical Particulars	N	Y	Y
3.	General arrangement drawings	N	Y	Y
4.	Illustrative and descriptive catalogues	N	N	Y
5.	Installation, Operation and maintenance manual	N	N	Y
6.	Test Certificates	N	N	Y
7.	Guarantee Certificates	N	N	Y

Note:

1. 4 hard copies & 1 soft copy shall be supplied for approval after order within 4 weeks from the date of LOI.
2. 8 hard copies & 2 soft copies in CD shall be submitted as final documents prior to despatch of the equipment. These shall be made in sets and supplied in fine plastic coated folder.

Y - Yes, N - No



TALCHER FERTILIZERS LIMITED
TECHNICAL SPECIFICATION - MEDIUM VOLTAGE
SWITCH BOARDS

PC183-TS-0805

0

Document No.

Rev

Sheet 1 of 16



TECHNICAL SPECIFICATION
MEDIUM VOLTAGE SWITCH BOARDS

CONTENTS

SECTION NUMBER	DESCRIPTION
1.0	SCOPE
2.0	STANDARDS TO BE FOLLOWED
3.0	SERVICE CONDITIONS
4.0	OPERATING REQUIREMENTS
5.0	DESIGN AND CONSTRUCTIONAL FEATURES
6.0	COMPONENT DETAILS
7.0	ACCESSORIES
8.0	PAINTING
9.0	TESTS AND INSPECTION
10.0	DRAWINGS AND DOCUMENTS
11.0	SPARES
12.0	PACKING
ANNEXURE - I	DOCUMENTATION FOR MEDIUM VOLTAGE SWITCH BOARDS

1.0 SCOPE

- 1.1 This standard covers the technical requirements of design, manufacture, testing at works and delivery in well-packed condition of Medium Voltage Switchboards.
- 1.2 This standard shall be applicable for the Power Control Centres, Power cum Motor Control Centres and Motor Control Centres.
- 1.3 This standard shall be read in conjunction with relevant part of Design Philosophy – Electrical, Schematic diagrams etc.

2.0 STANDARDS TO BE FOLLOWED

- 2.1 The design, manufacture and testing of the equipment shall comply with the latest issue of the following Indian Standards, unless otherwise Specified. Equipment complying with equivalent IEC standards shall also be acceptable.

- | | |
|--------------|--|
| IS 8623 | - Specification for low voltage switchgear and control gear assemblies |
| IS/IEC 60947 | - Low-voltage switchgear and control gear (General Rules) |
| IS 5578 | - Guide for marking of insulated conductors |
| IS 10118 | - Code of practice for selection, installation and maintenance of switchgear and control gear |
| IS 11353 | - Guide for uniform system of marking and identification of conductors and apparatus terminals |

Various components housed in the switchboards shall conform to the Indian Standard specifications as mentioned against the component details or IEC specifications.

- 2.2 The design and operational features of all the equipment offered shall also comply with the provisions of the latest issue of the Indian Electricity Rules and other Statutory Acts and Regulations, as applicable. The supplier shall, wherever necessary, make suitable modifications in the equipment to comply with the above.
- 2.3 Wherever any requirement, laid down in this standard, differs from that in Indian Standard Specification / IEC Specification, the requirement specified herein shall prevail.

3.0 SERVICE CONDITIONS

3.1 Ambient Conditions

These shall be as indicated in Design Philosophy – Electrical.

3.2 System Details

These shall be as indicated in Design Philosophy – Electrical.

4.0 OPERATING REQUIREMENTS

The Medium Voltage Switchboards shall be suitable for operating at the specified rating continuously, with the specified voltage and frequency variations under the ambient conditions, without exceeding the permissible temperature rise and without any detrimental effect on any part.

5.0 DESIGN AND CONSTRUCTIONAL FEATURES

5.1 General

- 5.1.1 The switchboards shall consist of an assembly of a series of floor mounting, identical, metal clad, dead front type sheet steel panels of unitized design. The panels shall be placed side by side to form a compact assembly and shall be extensible on either side.
- 5.1.2 The complete assembly shall be dust, damp and vermin proof having minimum degree of protection equivalent to IP-52 up to 1600A rating and IP-4X above 1600A rating as per IS/IEC:60947.
- 5.1.3 The frame work of the cubicles shall be of bolted/welded construction. The minimum thickness of sheet steel shall be 2 mm for load bearing members, 1.6 mm for non-load bearing members and 3 mm for base channel. The doors and covers shall be fabricated from cold rolled sheets. Suitable reinforcement, wherever necessary, shall be provided.
- 5.1.4 The door hinges shall be concealed type.
- 5.1.5 All external hardwares shall be cadmium plated. The hardwares for fixing the removable parts shall be provided with retaining devices.
- 5.1.6 The doors and the removable covers shall be provided with non-deteriorating neoprene gaskets. Gaskets without any discontinuity shall be preferred. Gaskets shall be held in position in groove, in shaped sheet steel work or these shall be of U type. Adhesive cement, if used, shall be of good quality so that the gaskets do not come off during service.
- 5.1.7 All the components shall be accessible for inspection and maintenance without the necessity for removal of the adjacent ones.
- 5.1.8 The layout of the component inside the module shall be liberal to facilitate maintenance and interconnecting wiring between the components shall not be subjected to any undue stresses at the bends.
- 5.1.9 Mounting height of components requiring operations and observation shall not be lower than 300 mm and higher than 1800 mm.
- 5.1.10 Inter panel barriers shall be provided.
- 5.1.11 All the live parts which are accessible after opening of front cover/cable alley cover/back cover shall be properly insulated or provided with insulating barrier to prevent accidental contact. Removal facility shall be provided for all such parts.
- 5.1.12 Adequate arrangement for earthing shall be provided to safeguard the operator or other personnel from electric hazards under all conditions of operation.

5.2 Panel Arrangement

The Switchboards shall be in fixed/draw out, single front execution, fully compartmentalised type and divided into distinct panels, each comprising of :

- i) A completely metal enclosed bus-bars compartment running horizontally the top.
- ii) Individual feeder modules.
- iii) Enclosed vertical bus-bars serving all modules, in case of multi-tier panels.
- iv) A vertical cable alley.
- v) Separate horizontal enclosure for all auxiliary power and control buses.

5.3 Circuit Breaker Controlled Feeders

- 5.3.1 The panels housing circuit breaker feeders shall be in single front draw out execution. The incoming and bus coupler circuit breaker feeders shall be in single tier formation while the outgoing circuit breaker feeders may be in double tier formation.

- 5.3.2 A suitable barrier shall be provided between the circuit breaker and the associated control, protective and indication devices including instrument transformers.
- 5.3.3 All the protective relays and meters shall be flush mounted type. The relays and meters pertaining to a particular circuit breaker shall be mounted on the same panel. Where it is not possible to accommodate all the relays and meters in the same panel, one metering panel shall be provided adjacent to the circuit breaker panel exclusively for that feeder. Location of these in the adjacent panel of other feeders shall not be acceptable.
- 5.3.4 A spacious cable chamber suitable for accommodation, support and termination of required number of power cables shall be provided at the back. No bare bus-bars or live connection shall intrude into the cabling space.
- 5.3.5 The switchboard shall be provided with following inter locks and safety features:
- i) It shall not be possible to open the compartment door unless the breaker is drawn to isolated position.
 - ii) The withdrawn and engagement of a circuit breaker shall not be possible unless it is in open position.
 - iii) The operation of a circuit breaker shall not be possible unless it is in fully service, test or isolated position.
 - iv) It shall not be possible to close the circuit breaker in service position unless all auxiliary and control circuits are connected.
 - v) A breaker of the lower rating shall be prevented from engaging with the stationary element of higher rating.
 - vi) Insertion of the manual mechanism shall render the motorised mechanism in operation.
 - vii) Circuit breaker 'ON', 'OFF' indication shall be provided at the back of each panel. Alternatively, alarm shall be provided in case panel back door is opened with breaker "ON".
 - viii) Caution nameplate shall be provided at the back of incomer's panels where terminals are likely to remain live and isolation is possible only from remote end.
 - ix) Automatic safety shutter, with Padlocking facility for locking in closed position, to completely cover the spouts for the bus-bars and cable connection when the breaker is withdrawn.
- 5.4 **Switch/MCCB Controlled Feeders**
- 5.4.1 The panels housing motor starter or other feeders shall be either fixed or draw out type in single front execution.
- 5.4.2 All components of one feeder shall be mounted on a rigid sheet steel chassis.
- 5.4.3 Each panel shall be divided into a number of modules in tier formation placed one above the other. These modules shall be closed on all sides.
- 5.4.4 The modules shall be so placed that largest one is placed at the bottom of the panel. Type modules shall be at least 300 mm from the base channel.
- 5.4.5 The number of modules shall be so decided that the cables in the cable alley are not over crowded. However the number of module in any panel shall not exceed six.
- 5.4.6 The minimum size of module shall be 300 mm and 200 mm for starter and switch fuse feeders respectively.
- 5.4.7 The minimum clear width of cable alley shall be 250 mm.

- 5.4.8 For MCC rated above 630 Amp. The incomer and bus coupler modules shall be located in individual single panel. For MCC rated for 630 Amp. and below the incomer and bus coupler modules shall be half the panel size.
- 5.4.9 The module door shall be so interlocked that it shall not be possible to open the door with switch in closed position and close the door unless the module is fully plugged in. Defeat interlock facility shall be provided.
- 5.5 **Special Features of Draw out Modules**
- 5.5.1 The module shall be fully draw out type with sheet steel chassis moving freely on the guides. Chassis of the same size shall be fully interchangeable.
- 5.5.2 The module shall have the following distinct mechanical positions:
- i) Service -- In which both power and control contacts shall be made.
 - ii) Test -- In which power contacts shall be isolated but control contacts shall be made.
 - iii) Isolated -- In which both power and control contacts shall be Isolated.
- Maintenance position shall be preferred.
- 5.5.3 Each position shall be clearly marked. Padlocking facility shall be provided to padlock the chassis in any of the position.
- 5.5.4 The movement of the chassis from one position to the other shall be controlled by using an appropriate racking mechanism. Stopper shall be provided to prevent over travel of the chassis beyond the isolated position.
- 5.5.5 The guiding system shall permit smooth movement of the module and the power and control contacts shall be self-aligning type so that accurate alignment of the contacts is ensured.
- 5.5.6 No wiring shall be taken to the door. Only the actuators of the push buttons and switches, lenses for the indicating lamps and Perspex cover for meters shall be mounted on the door.
- 5.5.7 The power contacts shall be of plug-in/stab-in type made of silver plated copper, spring loaded and of adequate current carrying capacity. The contacts shall be so designed that contact pressure is maintained both under normal and short circuit conditions.
- 5.5.8 The parting contacts, both on bus-bar side and outgoing cable side, shall always be copper to copper and both sides silver plated. A bimetallic strip shall be used where two dissimilar materials are in contact.
- 5.6 **Bus-Bars and Connections**
- 5.6.1 The bus-bars shall be for three phase and neutral. The main bus-bars and connections shall be made of electrolytic grade copper of rectangular cross-section. Auxiliary bus-bars for control supply, space heater supply etc. shall be made of electrolytic copper.
- 5.6.2 The horizontal bus-bars shall be insulated with heat shrinkable PVC sleeves of reputed make to protect against approach to live parts. The vertical bus-bars shall be sleeved or shrouded by barriers. Removable type insulating shrouds shall be provided for all joints of horizontal bus-bars.
- 5.6.3 The bus-bars shall be amply sized to carry the rated continuous current under the specified ambient temperature without exceeding temperature limits specified in IS: 8084. The thermal rating of the bus-bars shall be designed to withstand the system fault current for 1 second without exceeding the limiting temperature of 200°C for bare Aluminium/Copper. Calculation for bus-bars sizing shall be furnished along with the offer.

- 5.6.4 Horizontal bus-bars shall be of the same cross-section through out. Stepped bus-bars shall not be acceptable.
- 5.6.5 The bus-bars shall be arranged and colour coded according to IS: 5578 / IS: 11353.
- 5.6.6 The bus-bar chamber shall be sufficiently spacious and shall have separate screwed covers for maintenance purpose.
- 5.6.7 The bus-bars shall be rigidly supported at equal intervals to withstand maximum short circuit stresses. The supports shall be of moulded construction with built-in anti-tracking barriers. The support materials shall be of DMC or fibreglass reinforced thermosetting plastic.
- 5.6.8 Bus-bar joints shall be between the two transporting sections only.
- 5.6.9 A minimum of two bolts shall be used in bus-bar joints. Only high tensile electric galvanized bolts, nuts and washers shall be used.
- 5.6.10 In case of Aluminium bus-bars, all joints shall be suitably treated to avoid oxidation of contact surfaces and bimetallic corrosion.

5.7 **Earth Bus**

A continuous earth bus of electrolytic grade copper, running along the entire length of the lower part of the switchboard shall be provided with lugs at two ends for external connections. The minimum size of earth bus shall be suitable for carrying three phase fault current for 1 sec.

5.8 **Bus Duct**

- 5.8.1 Suitable extension of bus-bars in proper phase sequence on the top, with the connecting bolts shall be provided where connection of transformer to switchboard is specified to be through bus duct.
- 5.8.2 Bus duct between two halves of a switchboard, if required, shall be supplied by the switchboard manufacturer. The bus-bars of interconnecting bust duct shall be similar to the main bus-bars of the switchboard and as specified above.
- 5.8.3 Bust duct between transformer and incoming breaker panel, if included in Vendor's scope, shall conform to ES-8062.

5.9 **Clearances and Creepage Distances**

- 5.9.1 The clearances and creepage distances shall not be lower than the values specified below:

- | | | | |
|------|--|----|-------|
| i) | Minimum clearance between two live conductors | -- | 20 mm |
| ii) | Minimum clearance between live parts and accidentally dangerous part | -- | 20 mm |
| iii) | Minimum creepage distance | -- | 28 mm |

- 5.9.2 The clearances and creepage, as specified above, shall definitely be maintained in the bus-bar system. Provision of bus-bar insulation, separators or barriers shall not be considered to reduce the clearance from the values specified above.

- 5.9.3 At the termination points in the equipment e.g. switches, contactors, thermal relays etc. It is realized that above clearances may not always be possible to be maintained. All such points, where above clearances and creepage distances are not possible to be maintained, shall be insulated or taped.

5.10 **Insulation**

- 5.10.1 The insulation used shall be non-hygroscopic and may be of porcelain, epoxy resins or fibreglass moulded with plastic. It shall be of adequate electrical, mechanical and

thermal strength to give trouble free service during normal operation and short circuit conditions.

5.10.2 The insulation shall be treated suitably to withstand the tropical conditions and atmospheric pollution.

5.11 **Power Wiring**

5.11.1 The connections from bus-bar to individual functional unit on the modules shall be of PVC insulated flexible copper cables or taped Copper/Aluminium strip.

5.11.2 The power wiring size shall be decided based on rating of the switch/breaker after using a rating factor of not more than 50% over the current rating in free air.

5.11.3 Power wiring size selected for breaker controlled module shall also be able to withstand full short circuit current for duration of 0.25 sec.

5.11.4 In any case minimum size of power wiring shall not be less than 4 sq. mm copper.

5.11.5 The size of connection from incomer to horizontal bus-bar and from horizontal bus-bar to bus-coupler shall not be less than the size adopted for horizontal bus-bar.

5.12 **Control Wiring**

5.12.1 The switchboard shall be completely factory wired and ready for external connections.

5.12.2 The wiring shall be carried out with flexible stranded PVC insulated copper conductor cables of 1100 Volt grade. The size of wires shall be as follows:

C.T. Circuit -- 2.5 sq. mm

V.T. and Control Circuits -- 1.5 sq. mm

5.12.3 All wiring shall be provided with dependent both ends marking as per IS: 5578. Numbered ferrules, reading from the terminals outwards, shall be provided at both ends of all wiring for easy identification. These shall be interlocking type plastic ferrules.

5.12.4 Control wiring circuits, fed from a supply common to a number of panels, shall be so protected that failure of a circuit in one panel does not effect the operation of the other panels.

5.12.5 The wiring to the equipment mounted on the doors shall be carried out with flexible multi strand copper conductor cable and so supported that on opening of the door there is no undue strain on wire leads.

5.12.6 The control cables shall be neatly arranged and property supported.

5.13 **External Cable Termination**

5.13.1 All power and control cables shall enter the switchboard from the bottom. Sufficient space shall be provided for ease of connection and termination of cables.

5.13.2 The type, number and sizes of cables shall be as indicated in Feeder details.

5.13.3 Compression type cable glands along with the cable lugs as required shall be provided for termination of cables.

5.13.4 The cable glands shall be of rolled Aluminium heavy duty double compression type and shall be mounted on a removable gland plate, provided at a minimum height of 75 mm from the bottom of the switchboard. Two number spare knockouts of size 20 mm shall also be provided on the gland plates for future use. Gland for termination of single core cables shall be nonmagnetic type.

5.13.5 For all power cables, crimped type Aluminium lugs for Aluminium cables and tinned Copper lugs for Copper cables shall be provided.

5.13.6 The terminal blocks shall be pressure clamp type up to 35 sq. mm cable sizes and bolted lug type for higher sizes of cables. These shall be protected type and rated for

1100 Volts service. The minimum current rating of terminal block shall be 16 Amp. The construction shall be such that after the connection of cables by means of lugs, necessary clearance and creepage distance are available.

- 5.13.7 Where more than two cables in parallel are required to be terminated, a system of bus links shall be provided with adequate clearance and spacing.
- 5.13.8 Suitable clamps to support the vertical run of cables shall be provided.
- 5.13.9 The terminal block shall be grouped according to circuit functions and suitably numbered. 20% extra terminals shall be provided in the terminal block.
- 5.13.10 For power connections, suitable marking on the terminals shall be provided to identify the phases.

5.14 Feeder Details

- 5.14.1 The requirements of incomer, bus coupler and outgoing feeders shall be as indicated in the single line diagram, feeder details and corresponding schematic diagrams.
- 5.14.2 Interlocks shall be provided between incomers and bus section panels. The interlocks shall be either electrical or mechanical type. In addition, arrangement for defeating the interlock shall also be provided to facilitate manual changeover.
- 5.14.3 Auto changeover scheme, wherever specified, shall be provided.

5.15 Dummy Panels

Dummy panels complete with bus-bar system in 400 mm width may be required for which unit price shall be indicated.

5.16 Control Power Supply

- 5.16.1 D.C. Power required for closing, tripping and indication of circuit breaker feeders shall be supplied at the bus coupler panel through two completely separate circuits by owner, one for tripping and other for closing and indication.
- 5.16.2 For receiving each external control supply, a double pole miniature circuit breaker shall be provided. This power shall be distributed inside the switchboard for each circuit breaker feeder having its MCB unit.

5.17 Space Heater Power Supply

- 5.17.1 Panel space heater shall be fed from a separate bus common for the whole board. This bus shall be fed from owner's supply for which a double pole MCB shall be provided in bus section panel.
- 5.17.2 Power supply for space heaters of motors shall be tapped from this bus by means of a MCB located in the motor feeder compartment. These MCBs shall be of triple pole and rated for 15 Amp.

6.0 COMPONENT DETAILS

Components of the switchgear shall ensure type of coordination 'C' as per IS:60947 (Part 4/ Section 1). Makes of all components shall be subject to owner's / consultant's approval

6.1 Circuit Breaker

- 6.1.1 The circuit breakers shall comply with the requirement of IS/IEC 60947.
- 6.1.2 All circuit breakers shall be of P2 (0-3 min - CO - 3 min - CO) category, capable of carrying the specified current at the site conditions and making/breaking of the system fault current.

- 6.1.3 Type test certificates from an independent testing authority shall be furnished along with the offer for each circuit breaker rating and type.
- 6.1.4 The circuit breakers controlling motors shall be suitable for DOL starting and stopping of induction motor a number of times.
- 6.1.5 The circuit breakers controlling capacitors shall be suitable for energizing and de-energizing the rated capacitor bank.
- 6.1.6 The circuit breakers shall be of the 3 phase, 4 pole horizontal draw out, horizontal isolation, air break type.
- 6.1.7 The circuit breaker shall be suitable for electrical or manual closing as specified. Manual operated breakers shall have independent manual spring closing mechanism. In case of electrically operated breaker, it shall have motor wound spring mechanism. In all cases tripping shall be by means of shunt trip coil.
- 6.1.8 All circuit breaker units of the same rating shall be physically and electrically interchangeable.
- 6.1.9 The circuit breakers shall be electrically and mechanically trip free and provided with anti-pumping feature.
- 6.1.10 Provision shall be made for slow closing for maintenance purposes. A suitable handle shall be provided one for each board for this purpose.
- 6.1.11 The circuit breakers shall have three positions i.e. service, test and isolated with the cubicle door closed. Necessary stoppers shall be provided to prevent the excessive movement of the breaker cradle than desired for the position. Service and test positions of the breaker shall have monitoring switch having 1NO+1NC contacts.
- 6.1.12 The circuit breaker shall be provided with emergency manual trip device, mechanical 'ON', 'OFF' and 'ISOLATED' position indicators and operation counter.
- 6.1.13 A maintenance truck/device for raising, lowering and withdrawal of the circuit breaker shall be supplied for each switch board.
- 6.1.14 The arc interrupting devices shall be capable of interrupting satisfactorily current from zero to the rated interrupting current when used on predominantly capacitive or inductive circuits, without requiring excessive maintenance of the contacts. The arc shall be restricted within the interrupting chamber and no emission of flame shall be allowed which may cause electrical breakdown or damage to insulation on the apparatus.
- 6.1.15 The main contacts shall be self aligning, adjustable and replaceable type.
- 6.1.16 The arcing contacts shall be easily accessible for maintenance and inspection and shall be easily replaceable type. They shall be provided with, contact face of special arc-resisting and non-pitting metal.
- 6.1.17 Mechanical safety interlock shall be provided for safe operation and movement of the breaker.
- 6.1.18 The circuit breakers shall be provided with minimum of four normally open and four normally closed auxiliary switch contacts, over and above those required for its own control scheme, for Owner's use. The contacts shall be wired separately to the terminal board.
- 6.2 Moulded Case Circuit Breakers**
- 6.2.1 The circuit breaker shall conform to IS/IEC 60947 and shall be of P2 category having rupturing capacity as per system requirement and mounted on a draw out chassis.
- 6.2.2 The circuit breaker shall be provided with spring assisted quick make quick break type manually operated trip free mechanism, mechanical 'ON', 'OFF' position indicators,

thermal tripping devices of inverse characteristics, instantaneous short circuit tripping devices and necessary auxiliary and alarm switches. The MCCB Chassis shall be provided with service, test and isolated position and automatic safety shutter.

- 6.2.3 The thermal and short circuit tripping devices shall be adjustable type.
- 6.2.4 When used for motor circuits, shunt trip device shall be provided and the let through power of controlling MCCB shall be lower than the respective contactor.
- 6.2.5 In addition, under voltage trip shall be provided.

6.3 Switches

- 6.3.1 The switches shall be motor duty type AC 23 Category and shall comply with the requirements laid down in IS/IEC 60947. Switches up to 63 Amps shall be rotary type and those of 100 Amps. & above, link type.
- 6.3.2 'ON' and 'OFF' position of the switches shall be indicated on the module. Provision shall be made to lock the switch in the 'OFF' position.
- 6.3.3 The fixed contacts shall be shrouded type. All contacts shall be silver plated.

6.4 Fuses

- 6.4.1 The fuses shall be of non-deteriorating HRC cartridge link type and shall conform to IS: 13703. They shall be suitable for the load and service required in the circuit.
- 6.4.2 One fuse puller shall be supplied along with each board.

6.5 Air Break Contactors

- 6.5.1 The Air Break Contactors shall be of Category AC3/AC4, unless otherwise specified, conforming to IS: 60947 and flapper type.
- 6.5.2 The dropout voltage shall not exceed 65% of rated voltage.
- 6.5.3 Each contactor shall be provided with auxiliary contacts as required. The rating of the auxiliary contacts shall be 5 Amps. AC or 1 Amp DC at the specified control voltages. The spare auxiliary contacts shall also be wired up to the terminal blocks.

6.6 Bimetal Thermal Overload Relays

- 6.6.1 The contactor shall be provided with three pole bimetal thermal overload relays, unless other-wise specified. The bimetal relays shall be of suitable range, ambient temperature compensated and shall be separate mounting type. They shall be adjustable through graduated scale and shall be provided with changeover contact. Thermal relays having long time/current characteristics, operated through saturated C.T.s shall be supplied, wherever required.
- 6.6.2 Bimetal thermal relays shall conform to IS: 3231 and IS/IEC 60947 and shall have built-in single phasing preventor.
- 6.6.3 The bimetal relays shall be provided with a manual resetting device resettable after opening module door. Auto reset thermal relays are not acceptable.

6.7 Current Transformers

- 6.7.1 The current transformers shall conform to IS: 2705.
- 6.7.2 C.T.s shall be Class F insulated and vacuum impregnated or resin cast. The C.T.s shall be rigidly mounted and shall be easily accessible for maintenance and testing.
- 6.7.3 The short time thermal withstand ratings of C.T.s shall be same as the thermal withstand rating of the breakers.
- 6.7.4 The C.T.s output shall be minimum 15VA for breaker feeders and 7.5 VA for the other feeders per phase and in any case, the output shall be adequate for the protection and

metering duties involved with sufficient margin. The C.T.s shall have the following accuracies for the various applications:

Application	Class of accuracy as per IS: 2705
--------------------	--

- | | |
|--|------|
| i) For metering service | - 1 |
| ii) For use with protective relays | - 5P |
| iii) For use with restricted earth fault and differential relays | - PS |

6.7.5 The C.T. cores for metering and protection shall be separate.

6.7.6 The ratio of C.T.s shall be as specified in Feeder details.

6.7.7 All the C.T.s shall be provided with terminals and shorting links. One of the terminals of the C.T. shall be earthed. The polarity of the C.T.s shall be clearly marked.

6.7.8 Provision of Interposing C.T.s is not acceptable.

6.7.9 The C.T.s shall be capable of withstanding momentary open circuit on the secondary side without injurious effects.

6.8 Voltage Transformers

6.8.1 The V.T.s shall be Class F insulated and vacuum impregnated or resin cast conforming to IS: 3156.

6.8.2 The primary nominal voltage shall be equal to the system nominal voltage. The secondary terminal voltage shall be 110 V.

6.8.3 The primary and secondary winding shall be protected by HRC fuses in each phase except in the ground phase of the secondary side.

6.8.4 The V.T.s shall be mounted on separate withdrawable carriage. The accuracy Class of V.T.s shall be 1.

6.8.5 The rated output of each V.T. shall be adequate for the relays, meters and associated wiring connected to it and shall not be less than 50 VA per phase.

6.9 Control Transformers

These shall be air cooled Class F insulated and vacuum impregnated. The rating of control transformer shall be twice the hold on VA of all contactor/relays or 2.5 KVA whichever is high. It shall be free from hum and rigidly mounted. Epoxy cast transformers shall be preferred.

6.10 Transformers for Kondorffer Starting

These shall be three phase core type, Class F insulated and vacuum impregnated. Tapping at 90%, 80%, 70% & 60% shall be provided and terminals shall be brought out for easy change of tapping at site. The operating temperature shall not exceed 80°C. The transformers shall be suitable for taking 7.5 times the specified full load current of the motor continuously for 120 secs.

6.11 Relays

6.11.1 All protective relays shall be of latest version, microprocessor based numerical type with communication port and interlinked with online energy management system. 100% redundancy shall be provided for communication.

6.12 Timers

The timers shall be electronic pneumatic or synchronous type with manual/auto reset

features as per the functional requirements. The time delay shall be 'ON' delay or 'OFF' delay type as specified. The repeat accuracy shall be 0.5% or better.

6.13 **Single Phasing Preventor**

6.13.1 Single phasing preventor relay shall be of the current operated type, suitable for the system voltage. The relay shall not operate for normal system voltage but operate positively in the event of unbalanced voltage more than the normal. The relay shall not operate in case of total interruption of power.

6.13.2 The relay shall be fail safe, self reset type and provided with flag indication. The relay operation shall be independent of the motor rating, loading and speed.

6.14 **Instruments and Meters**

6.14.1 All instruments shall be flush mounting type with square face of 96 mm x 96 mm. They shall be tropicalized and dust tight.

6.14.2 Meters shall be digital multifunctional meters with communication port for energy management at remote location.

6.14.3 All ammeters and voltmeters, to be provided separately, shall have 0-90° scale and shall be moving iron spring controlled type of class 1.5 accuracy as per IS: 1248. The scale range of the ammeters and voltmeters shall be as indicated in the Feeder details.

6.14.4 In case of motor feeders, the ammeters shall be graduated uniformly upto C.T. primary current and with compressed end scale upto 6 times C.T. primary current. Red pointer shall be provided, which shall be adjusted at site for indicating full load current of the motor.

6.15 **Push Buttons and Control Switches**

6.15.1 The switches and push buttons shall conform to utilization category AC11/DC11 as per IS: 60947. The contact shall be rated to make, break and carry inductive current of 5 Amp at 415 V AC and 1 Amp at 220 V DC.

6.15.2 The control switches shall be spring return rotary type, unless otherwise specified and provided with pistol grip type handle. The control switches for circuit breakers shall be additionally fitted with lost motion devices and sequencing devices.

6.15.3 The selector switches shall be stay put rotary type and provided with oval shape handles.

6.15.4 The push buttons shall be of momentary contact spring loaded type with a set of normally close and open contacts. The push button for 'Start' shall be shrouded type and coloured green, stop push button shall be un-shrouded type and coloured red and other push buttons shall be un-shrouded type coloured black. The fixing ring shall be metallic white.

6.15.5 Emergency stop push buttons, if specified, shall be lockable in pushed position.

6.16 **Miniature Circuit Breakers**

6.16.1 The miniature circuit breakers shall conform to IS: 8828 and shall be of duty category M-9.

6.16.2 It shall be provided with overload and short circuit protective devices in a heat resistant housing.

6.16.3 A certificate for short circuit rating and Current-Time tripping curve shall be furnished along with the offer.

6.17 **Signal Lamps**

6.17.1 Signal lamps shall be provided to indicate the various circuit conditions as shown in scheme drawings. The colour of the lamps for various functions shall be as follows :



TALCHER FERTILIZERS LIMITED
TECHNICAL SPECIFICATION - MEDIUM VOLTAGE
SWITCH BOARDS

PC183-TS-0805

0

Document No.

Rev

Sheet 14 of 16



- Red -- Circuit breaker/switch/contactor closed.
- Green -- Circuit breaker/switch/contactor open.
- White -- Trip circuit healthy.
- Amber -- Alarm and auto trip.
- Blue -- Non-Trip

6.17.2 All lamps shall be of LED type with lumen output of 200 mili candela in axial direction.

7.0 ACCESSORIES

7.1 The supply shall include the following accessories:

- Maintenance truck/device for raising, lowering and withdrawal of circuit breaker, if required.
- Fuse puller.
- Test plug for relays.
- Test plug for kWh meters.

7.2 Space Heater

Each vertical section shall be provided with a thermostatically controlled space heater, rated for 240 V, 50 Hz and controlled through double pole miniature circuit breaker.

7.3 Name Plates

7.3.1 The switchboard shall have large name plate on the top indicating its Name, Designation and Code No.

7.3.2 Each feeder shall be provided with name plate. Each single front panel shall have name plate indicating panel number both in front and back.

7.3.3 All control switches, push buttons, lamps etc. shall have functional identification labels.

7.3.4 Name plate shall be of black Perspex with white engraving and of minimum 3mm thick.

7.4 Any other accessories required, but not specified, shall also be supplied to make the switchboard complete in all respects and ensure safe and proper operation.

8.0 PAINTING

8.1 The enclosure, after degreasing, pickling in acid, cold rinsing, phosphatising, passivating etc. shall be painted with two coats of anti-rust paint followed by two coats of anticorrosive paint.

8.2 Epoxy based paint shall be used.

8.3 All paints shall be carefully selected to withstand tropical heat and extremes of weather. The paint shall not scale off, crinkle or be removed by abrasion due to normal handling.

8.4 Unless otherwise specified, the finishing shade shall be light grey having Shade No.631 as per IS: 5.

8.5 One litre of paint shall be supplied along with each board for touch up at site.

9.0 TESTS AND INSPECTION

9.1 All the switchboards shall be subjected to routine test as per IS: 8623 and their components as per relevant standards.

9.2 Additional tests, wherever specified, shall be carried out.

- 9.3 All the above tests shall be carried out in presence of Purchaser's representative. In addition, the equipment shall be subjected to stage inspection during process of manufacture at works and site inspection.
- 9.4 These inspections shall however, not absolve the vendor from their responsibility for making good any defect which may be noticed subsequently.
- 10.0 DRAWINGS AND DOCUMENTS**
- 10.1 Drawings and documents as per Annexure-I shall be supplied, unless otherwise specified.
- 10.2 All drawings and documents shall have the following description written boldly:
- Name of Client
 - Name of Consultant
 - Enquiry / Order Number with Project / Plant Name
 - Code No. & Description
- 11.0 SPARES**
- 11.1 Commissioning Spares : Commissioning spares, as required, shall be supplied with the main equipment. Item-wise list of recommended commissioning spares shall be furnished for information.
- 11.2 Spares for 2 Years Operation (Mandatory), as specified shall be supplied.
- 11.3 List of Recommend Spares (other than Mandatory Spares) alongwith recommended quantity shall be furnished.
- 11.4 All spare parts shall be identical to the parts used in the equipment
- 12.0 PACKING**
- 12.1 The board shall be properly packed before despatch to avoid damage during transport, storage and handling.
- 12.2 The packing box shall contain a copy of the installation, operation and maintenance manual.
- 12.3 A sign to indicate the upright position of the panels to be placed during transport and storage shall be clearly marked. Also proper arrangement shall be provided to handle the equipment.

ANNEXURE - I

DOCUMENTATION FOR MEDIUM VOLTAGE SWITCHBOARDS

SI.No.	Documentation Description	Documents Required (Y / N)		
		With Bid	For Approval	Final
1.	Specification Sheets	N	Y	Y
2.	Technical Particulars	N	Y	Y
3.	Feeder Details	N	Y	Y
4.	General arrangement and Foundation Drgs.	N	Y	Y
5.	Schematic and Wiring Diagrams	N	Y	Y
6.	Calculation for Bus-bar sizing	N	Y	N
7.	Terminal Arrangement Drgs.	N	Y	Y
8.	Illustrative and Descriptive Literature	N	N	Y
9.	Catalogues for bought out accessories.	N	N	Y
10.	Installation, Operation and maintenance manual.	N	N	Y
11.	Test Certificates			
	i) Type -- Switchboard	N	N	N
	-- Circuit Breaker	N	N	N
	-- MCCB's	N	N	N
	ii) Routine	N	N	Y
12.	Guarantee Certificates	N	N	Y
13.	Spare Parts List	N	N	Y

Note:

1. 4 hard copies & 1 soft copy shall be supplied for approval after order within 4 weeks from the date of LOI.
2. 8 hard copies & 2 soft copies in CD shall be submitted as final documents prior to despatch of the equipment. These shall be made in sets and supplied in fine plastic coated folder.

Y - Yes, N – No



TALCHER FERTILIZERS LIMITED
TECHNICAL SPECIFICATION - HIGH VOLTAGE
SWITCHBOARDS

PC183-TS-0806

0

Document No.

Rev

Sheet 1 of 13



TECHNICAL SPECIFICATION
HIGH VOLTAGE SWITCH BOARDS



TALCHER FERTILIZERS LIMITED
TECHNICAL SPECIFICATION - HIGH VOLTAGE
SWITCHBOARDS

PC183-TS-0806

0

Document No.



Rev

Sheet 2 of 13



CONTENTS

SECTION NUMBER	DESCRIPTION
1.0	SCOPE
2.0	STANDARDS TO BE FOLLOWED
3.0	SERVICE CONDITIONS
4.0	OPERATING REQUIREMENTS
5.0	DESIGN AND CONSTRUCTIONAL FEATURES
6.0	COMPONENT DETAILS
7.0	ACCESSORIES
8.0	PAINTING
9.0	TESTS AND INSPECTION
10.0	DRAWINGS AND DOCUMENTS
11.0	SPARES
12.0	PACKING
ANNEXURE - I	DOCUMENTATION FOR HIGH VOLTAGE SWITCHBOARDS

	TALCHER FERTILIZERS LIMITED TECHNICAL SPECIFICATION - HIGH VOLTAGE SWITCHBOARDS	PC183-TS-0806	0	
		Document No.	Rev	
		Sheet 3 of 13		

1.0 SCOPE

1.1 This standard covers the technical requirements of design, manufacture, testing at works and delivery in well-packed condition of High Voltage Switch Boards.

1.2 This standard shall be read in conjunction with relevant part of Design Philosophy – Electrical , Schematic diagrams etc.

2.0 STANDARDS TO BE FOLLOWED

2.1 The design, manufacture and testing of the equipment shall comply with the latest issues of the following standard, unless otherwise specified. Equipment complying with equivalent IEC standards shall also be acceptable.

IS: 3427 A.C. Metal enclosed switchgear and control gear for rated voltages above 1 kV up to and including 52 kV.

IS: 13118 Specification for high voltage alternating current circuit breakers.

IS: 5578 Guide for marking of insulated conductors.

IS: 11353 Guide for uniform system of marking and identification of conductors and apparatus terminals.

IS: 10118 Code of Practice for selection, installation and maintenance of switchgear and control gear.

Various components housed in the switchboards shall conform to the Indian Standards Specification as mentioned against the component details or IEC Specifications.

2.2 The design and operational features of all the equipment offered shall also comply with the provisions of the latest issue of the Indian Electricity Rules and other Statutory Acts and Regulations. The supplier shall, wherever necessary, make suitable modifications in the equipment to comply with the above.

2.3 Wherever any requirement, laid down in this standard, differs from that in Indian Standard Specifications / IEC Specification, the requirement specified herein shall prevail.

3.0 SERVICE CONDITIONS

3.1 Ambient Conditions

These shall be as indicated in Design Philosophy – Electrical.

3.2 System Details

These shall be as indicated in Design Philosophy – Electrical.

4.0 OPERATING REQUIREMENTS

The switchboards shall be suitable for operating at the specified rating continuously, with the specified voltage and frequency variations under the ambient conditions, without exceeding the permissible temperature rise and without any detrimental effect on any part.

5.0 DESIGN AND CONSTRUCTIONAL FEATURES



TALCHER FERTILIZERS LIMITED
TECHNICAL SPECIFICATION - HIGH VOLTAGE
SWITCHBOARDS

PC183-TS-0806

0

Document No.

Rev

Sheet 4 of 13



5.1 **General**

- 5.1.1 The switchboards shall consist of an assembly of a series of floor mounting, identical, metal clad, cubicle type panels placed side by side to form a compact assembly and shall be extensible on either side.
- 5.1.2 The complete assembly shall be dust, damp and vermin proof having minimum degree of protection equivalent to IP4X as per IS/IEC:60529. However, in case some ventilation openings are to be provided, these may be permitted for equipment located indoors and such openings shall be covered by fine wire mesh ensuring minimum IP3X protection.
- 5.1.3 The framework of the cubicles shall be bolted / welded construction. The minimum thickness of sheet steel shall be 3 mm for base channel and 2 mm for other members. The doors and covers shall be fabricated from cold rolled sheet steel. Suitable reinforcement, wherever necessary, shall be provided.
- 5.1.4 The switchboard shall be mounted on the channel which shall be included in the vendor's scope.
- 5.1.5 Each cubicle shall be provided with front access door with handle lock and key for breaker compartment and a removable back cover. The door hinges shall be concealed type. Front doors of the panels shall mechanically stop in full open position to facilitate removal of breakers and for ease of maintenance.
- 5.1.6 All external hardwares shall be cadmium plated. The hardwares for fixing removable parts shall be provided with retaining devices.
- 5.1.7 The doors and the removable covers shall be provided with non-deteriorating neoprene gaskets. Gaskets without any discontinuity shall be preferred. Gaskets shall be held in position in groove, in shaped sheet steel work or these shall be U-type.
- 5.1.8 Each cubicle shall have separate compartment within the cubicle for circuit breaker, bus-bars, instrument transformers, metering and relaying devices and cable termination.
- 5.1.9 Inter-panel and inter-compartment fire resistant barrier shall be provided. Cast resin seal off bushing shall be provided in the bus compartment, through which connections to breaker compartment/cable compartment/bus compartment of adjacent panel shall be taken. Failure of one of the equipment shall not effect the equipment in the adjacent compartment.
- 5.1.10 All the components shall be accessible for inspection and maintenance without the necessity of removing the adjacent ones. Their mounting shall be accessible and ensure the necessary degree of safety.
- 5.1.11 The layout of the components inside the cubicle shall be liberal to facilitate maintenance and the interconnecting wiring between components shall not be subjected to undue stresses at the bends.
- 5.1.12 Mounting height of components requiring operation and maintenance shall not be lower than 300 mm and higher than 1800 mm.
- 5.1.13 All live parts which are accessible after opening of front and back door/cover shall be properly insulated or provided with insulating barrier to prevent accidental contact. Phase insulating barriers shall be provided between the breaker poles. Removal facility shall be provided for all such barriers.
- 5.1.14 Adequate arrangement for earthing shall be provided to safeguard the operator or other personnel from electric hazards under all conditions of operation.
- 5.1.15 The switchboard shall be provided with following interlocks and safety features:
- i) The withdrawal and engagement of a circuit breaker shall not be possible unless it is in open position.



TALCHER FERTILIZERS LIMITED
TECHNICAL SPECIFICATION - HIGH VOLTAGE
SWITCHBOARDS

PC183-TS-0806

0

Document No.

Rev

Sheet 5 of 13



- ii) The operation of a circuit breaker shall not be possible unless it is in fully service, test or isolated position.
- iii) It shall not be possible to close the circuit breaker in service position unless all auxiliary and control circuits are connected.
- iv) A breaker of the lower rating shall be prevented from engaging with the stationary element of higher rating.
- v) Insertion of the manual mechanism shall render the motorized mechanism inoperable.
- vi) Circuit breaker "ON", "OFF" indication shall be provided at the back of each panel.
- vii) Caution name plate shall be provided at the back of incomer panels where terminals are likely to remain live and isolation is possible only from remote end.
- viii) Automatic safety shutter, with padlocking facility for locking in closed position, to completely cover the spouts for bus-bars and cable connection when the breaker is withdrawn.

5.2 Bus-Bars and Connections

- 5.2.1 The bus-bars shall be for three phases. The bus-bars and connection shall be made of electrolytic grade copper of rectangular cross-section.
- 5.2.2 Bus-bars and connections shall be sleeved to protect against approach to live parts and to eliminate potential arcing points. Sleeving material shall have adequate electrical, thermal and mechanical properties to withstand impulse level, temperature rise during normal and short circuit condition and allow easy bending of bus bars.
- 5.2.3 The bus-bars shall be amply sized to carry the rated continuous current under the specified ambient temperature without exceeding the limits specified in IS: 8084. The thermal rating of the bus-bars shall be designed to withstand the system fault current for 3 seconds without exceeding the limiting temperature of 250°C for bare copper. Calculation for bus-bar sizing shall be furnished along with the offer.
- 5.2.4 Horizontal bus-bars shall run in a separate compartment through the entire length of the board and shall be of same cross-section throughout. Stepped bus-bars shall not be acceptable.
- 5.2.5 The bus-bars shall be arranged and colour coded according to IS: 5578 & IS: 11353.
- 5.2.6 The bus-bars chamber shall be sufficiently spacious and shall have separate screwed covers for maintenance purpose. It shall be adequately ventilated and shall allow the escape of the hot gases.
- 5.2.7 The bus-bars shall be rigidly supported at equal intervals to withstand the stresses due to full short circuit and also to take care of thermal expansion.
- 5.2.8 A minimum of two bolts shall be used per bus-bar joint. Only high tensile electro galvanized cadmium plated bolts, nuts and washers shall be used. The washers shall be spring and plain type. The bus-bar supports shall be of molded construction with built-in anti-tracking barriers. The support materials shall be of DMC or fiber glass reinforced thermosetting plastic.
- 5.2.9 The bus-bars, both horizontal and vertical, shall be PVC sleeved. Insulating shrouds shall be provided for all joints of insulated bus-bars.

5.3 Earth Bus

A continuous earth bus of Aluminium running along the lower part of the switchboard shall be provided with two end terminals with lugs for external connection. The earth bus shall be rated to carry three phase fault current for a period of 3 sec.

5.4 Bus Duct



TALCHER FERTILIZERS LIMITED
TECHNICAL SPECIFICATION - HIGH VOLTAGE
SWITCHBOARDS

PC183-TS-0806

0

Document No.

Rev

Sheet 6 of 13



- 5.4.1 Suitable extension of bus-bars in proper phase sequence on the top, with connecting bolts shall be provided where connections between transformer and switchboard or between two halves of the switchboard is specified to be through bus duct.
- 5.4.2 Bus duct between two halves of the switchboard, if required, shall be supplied by the switchboard manufacturer. The bus-bars of interconnecting bus duct shall be similar to the main bus-bars of switchboard as specified above and shall conform to IS: 8084.
- 5.4.3 Bus duct between transformer and switchboard, if included in vendor's scope shall conform to IS: 8084.
- 5.5 **Clearances and Creepage Distance**
- The clearance and creepage distance shall be adequate to meet the BIL of the equipment.
- 5.6 **Insulation**
- 5.6.1 The insulation used shall be non-hygroscopic and shall be of porcelain, epoxy resins or fiber glass molded with plastic. It shall be of adequate electrical, mechanical and thermal strength to give trouble free service during normal operation and short circuit conditions.
- 5.6.2 The insulation shall be treated suitably to withstand the tropical conditions and atmospheric pollution.
- 5.7 **Control Wiring**
- 5.7.1 The switchboard shall be completely factory wired and ready for external connections.
- 5.7.2 The wiring shall be complete in all respect so as to ensure proper functioning of control, interlocking, protection, metering, indications and annunciations.
- 5.7.3 The wiring shall be carried out with flexible stranded PVC insulated copper conductor cables of 1100 Volt grade. The minimum size of wires shall be as follows:
- | | | |
|---------------------------|----|------------|
| C.T. Circuit | -- | 2.5 Sq. mm |
| V.T. and Control Circuits | -- | 1.5 Sq. mm |
- 5.7.4 All wiring shall be provided with dependent both ends marking as per IS: 5578. Numbered ferrules, reading from the terminal outwards, shall be provided at both ends of all wiring for easy identification. These shall be interlocking type plastic ferrules.
- 5.7.5 Control wiring circuits, fed from a supply common to a number of panels, shall be so protected that failure of a circuit in one panel does not affect the operation of other panels.
- 5.7.6 The wiring to the equipment mounted on the doors shall be carried out with flexible multi-strand copper conductor cable and so supported that on opening of the door, there is no undue strain on wire leads.
- 5.7.7 The control cables shall be neatly arranged and properly supported.
- 5.8 **External Cable Termination**
- 5.8.1 All power and control cables shall enter the switchboard from the bottom on the back of the panel. Sufficient space shall be provided for ease of connection and termination of cables.
- 5.8.2 All power cables and control cables shall be of type, number and size as indicated in Feeder Details.
- 5.8.3 The termination arrangement for single core cables shall be such that so as to minimize flow of eddy current and heating due to eddy currents.
- 5.8.4 Heavy duty double compression type rolled Aluminium cable glands along with the



TALCHER FERTILIZERS LIMITED
TECHNICAL SPECIFICATION - HIGH VOLTAGE
SWITCHBOARDS

PC183-TS-0806

0

Document No.

Rev

Sheet 7 of 13



cable lugs, as required shall be provided for termination of control cables and auxiliary power supply cables.

- 5.8.5 The cable glands shall be mounted on a removable gland plate, provided at a minimum height of 75 mm from the bottom of the switchboard. Two number spare knockouts of size 20 mm shall also be provided on the gland plate for future use.
- 5.8.6 Terminal blocks shall be provided at suitable locations inside the panels for termination of control and auxiliary power supply wiring. These terminal blocks shall be pressure clamp type up to 35 sq. mm cables and bolted lug type for higher sizes of cables. These shall be protected type and rated for 1100 Volt service. The minimum current rating of the terminal block shall be 16 Amp.
- 5.8.7 Where more than two cables in parallel are required to be terminated, a system of bus links shall be provided with adequate clearance and spacing.
- 5.8.8 The terminal block shall be grouped according to circuit functions and numbered suitably. 20% extra terminals shall be provided in the terminal block.
- 5.8.9 Suitable clamps to support the vertical run of cables shall be provided.
- 5.8.10 For power connections, suitable marking on the terminals shall be provided to identify the phases.

5.9 Feeder Details

- 5.9.1 The requirements of incomer, bus coupler and outgoing feeders shall be as indicated in the single line diagram, feeder details and corresponding schematic diagrams.
- 5.9.2 Non-paralleling interlocks shall be provided between incomers and bus section panels. The interlocks shall be either electrical or mechanical type. Arrangement for defeating the interlock shall also be provided.
- 5.9.3 Auto changeover scheme, wherever specified, shall be provided.

5.10 Dummy Panels

Dummy panels complete with bus-bar system in 400 mm width shall be required for which unit price shall be indicated.

5.11 Control Power Supply

- 5.11.1 D.C. power required for closing, tripping and indication shall be supplied at the bus coupler panel through two completely separate circuits by the owner, one for tripping and another for closing and indication for the whole board.
- 5.11.2 For receiving each external control power supply, a double pole miniature circuit breaker shall be provided. This power shall be distributed inside the switchboard for each feeder having its MCB unit.

5.12 Space Heater Power Supply

- 5.12.1 Panel space heaters shall be fed from a separate bus, common for the whole board. This bus shall be fed from owner's supply for which a double pole MCB shall be provided in bus section panel.
- 5.12.2 Power supply for space heaters of motors shall be tapped from this bus by means of miniature circuit breakers located in the motor feeder panels. These MCB's shall be of triple pole and rated for 15 Amp.

6.0 COMPONENT DETAILS

Makes of all components shall be subject to owner's / consultant's approval



TALCHER FERTILIZERS LIMITED
TECHNICAL SPECIFICATION - HIGH VOLTAGE
SWITCHBOARDS

PC183-TS-0806

0

Document No.

Rev

Sheet 8 of 13



6.1 Circuit Breakers

- 6.1.1 The circuit breakers shall comply with the requirements of IS: 13118.
- 6.1.2 All circuit breakers shall be of 0-3 min-CO-3 min-CO rated operating sequence capable of carrying the specified current at the site conditions and making/breaking of the system fault current.
- 6.1.3 Type test certificates from an independent testing authority shall be furnished along with the offer for each circuit breaker rating and type.
- 6.1.4 The circuit breakers controlling motors shall be suitable for DOL starting and stopping induction motor a number of times and shall have provision to limit over voltage to the value safe for motor insulation. Unless otherwise specified this value shall be taken as 2.5 times the rated voltage. The magnitude of the voltage surge produced by the breaker when switching off the smallest motor shall be indicated.
- 6.1.5 The circuit breakers controlling capacitors shall be suitable for energizing and de-energizing the rated capacitor bank.
- 6.1.6 The circuit breakers shall be of the 3 phase, single/double break, horizontal draw-out, vertical/horizontal isolation type. The medium of arc quenching shall be minimum Oil/Bulk oil/vacuum/SF6 as specified elsewhere.
- 6.1.7 The circuit breakers shall be suitable for electrical/manual closing as specified in Feeder details. Electrically operated circuit breakers shall preferably have motor wound spring closing mechanism with provision for manual closing arrangement. Manually operated circuit breakers shall have independent manual spring closing mechanism. In all cases tripping shall be by means of shunt trip coil.
- 6.1.8 All circuit breaker units of the same rating shall be physically and electrically interchangeable.
- 6.1.9 The circuit breakers shall be electrically and mechanically trip free and provided with anti-pumping feature.
- 6.1.10 The circuit breakers shall have three positions, i.e. service, test and isolated with the cubicle door closed. Necessary stoppers shall be provided to prevent the excessive movement of the breaker cradle than desired for the position. Service and test positions of the breaker shall have monitoring switch having 1NO+1NC contacts.
- 6.1.11 The circuit breakers shall be provided with emergency manual trip device, mechanical 'ON', 'OFF', 'ISOLATED' position and spring 'CHARGED', 'DISCHARGED' indicators and operation counter.
- 6.1.12 A maintenance truck/device, if required, for raising, lowering and withdrawals of the circuit breaker shall be supplied for each switchboard.
- 6.1.13 The arc interrupting devices shall be capable of interrupting satisfactorily current from zero to the rated interrupting current when used on predominantly capacitive or inductive circuits, without requiring excessive maintenance of the contacts. The arc shall be restricted within the interrupting chamber and no emission of flame shall be allowed which may cause electrical breakdown or damage to insulation on the apparatus.
- 6.1.14 Mechanical safety interlock shall be provided for safe operating and movement of the breaker.
- 6.1.15 The circuit breakers shall be provided with minimum of four normally open and four normally closed auxiliary switch contacts, over and above those required for its own control scheme, for owner's use. These contacts shall be wired separately to the terminal board.
- 6.1.16 The closing coil and other associated auxiliary relays shall operate satisfactorily at all



TALCHER FERTILIZERS LIMITED
TECHNICAL SPECIFICATION - HIGH VOLTAGE
SWITCHBOARDS

PC183-TS-0806

0

Document No.

Rev

Sheet 9 of 13



voltages between 85% and 110% of the rated control voltage. The tripping coil and other associated relays shall operate satisfactorily at all voltages between 70% and 110% of the rated control voltage.

6.1.17 Cable earthing facility shall be provided in the circuit breaker for discharging of power cable through the circuit breaker contact with circuit breaker in drawn-out position. An integral earthing arrangement shall be preferred. In case the integral earthing arrangement is not feasible due to circuit breaker design, a separate earthing truck, which shall be inserted in place of circuit breaker, shall be provided per board.

6.1.18 Positive earthing of circuit breaker frame shall be maintained at every position of circuit breaker. The earthing contact shall be line/scraping type and not of point type.

6.2 Current Transformers

6.2.1 The current transformers shall conform to IS: 2705.

6.2.2 C.T.s shall be class F insulated and vacuum impregnated or resin cast type. The C.T.s shall be rigidly mounted and shall be easily accessible for maintenance and testing.

6.2.3 The short time thermal withstand ratings of the C.T.s shall be same as the thermal withstand ratings of the breakers.

6.2.4 The C.T.s output shall be minimum 15 VA per phase and in any case, the output shall be adequate for the protection and metering duties involved with sufficient margin. The C.T.s shall have the following accuracies for the various applications:

<u>Application</u>	<u>Class of Accuracy as per IS: 2705</u>
i) For metering service	1
ii) For use with protective relays	5 P
iii) For use with restricted earth fault and differential relays	PS

6.2.5 The C.T. cores for metering and protection shall be separate.

6.2.6 The ratios of the current transformers shall be as indicated in Feeder details.

6.2.7 All the C.T.s shall be provided with terminals and shorting links. One of the terminals of the C.T. shall be earthed. The polarity of the C.T. shall be clearly marked.

6.2.8 Provision of interposing C.T. is not acceptable.

6.2.9 The C.T.s shall be capable of withstanding momentary open-circuit on the secondary side without injurious effects.

6.3 Voltage Transformers

6.3.1 The V.T.s shall be class F insulated and vacuum impregnated or resin cast type conforming to IS: 3156.

6.3.2 The primary nominal voltage shall be equal to the system nominal voltage. The secondary terminal voltage shall be $110 / \sqrt{3}$ V.

6.3.3 The rated output of each VT shall be adequate for the relays, meters and associated wiring connected to it with sufficient margin and shall not be less than 200 VA per phase.

6.3.4 The accuracy class of V.T.s shall be 1 as per IS: 3156.

6.3.5 The primary and secondary winding shall be protected by HRC fuses in each phase except in the grounded phase of the secondary side.

6.3.6 The V.T. shall be mounted on a with-drawable carriage. Shutters with padlocking facility, provided on high voltage sides, shall be so arranged that the live orifices are



TALCHER FERTILIZERS LIMITED
TECHNICAL SPECIFICATION - HIGH VOLTAGE
SWITCHBOARDS

PC183-TS-0806

0

Document No.

Rev

Sheet 10 of 13



automatically closed when the V.T. is withdrawn.

6.3.7 Mechanical interlocking arrangement shall be provided so that the access to the high voltage fuse is possible only when the V.T. is fully withdrawn.

6.4 Relays

6.4.1 All protective relays shall be of latest version, microprocessor based numerical type with communication port and interlinked with online energy management system. 100% redundancy shall be provided for communication.

6.5 Timers

6.5.1 The timers shall be electronic, pneumatic or synchronous type with manual/ auto reset features as per the functional requirements. The timers shall be 'ON' delay or 'OFF' delay type as specified. The repeat accuracy shall be 0.5% or better.

6.6 Instruments and Meters

6.6.1 All instruments shall be flush mounting type with square face of 96 mm x 96 mm. They shall be tropicalized and dust tight.

6.6.2 Meters shall be digital multifunctional meters with communication port for energy management at remote location.

6.6.3 All ammeters and voltmeters, to be provided separately, shall have 0-90° scale and shall be moving iron spring controlled type of class 1.5 accuracy as per IS: 1248. The scale range of the ammeters and voltmeters shall be as indicated in the Feeder details.

6.6.4 In case of motor feeders, the ammeters shall be graduated uniformly upto C.T. primary current and with compressed end scale upto 6 times C.T. primary current. Red pointer shall be provided, which shall be adjusted at site for indicating full load current of the motor.

6.7 Push Buttons and Control Switches

6.7.1 The switches and push buttons shall conform to utilization category AC11/DC11 as per IS/IEC:60947. The contact shall be rated to make, break and carry inductive current of 5 Amps. at 415 V AC and 1 Amp. at 220 V DC.

6.7.2 The control switches shall be spring return rotary type, unless otherwise specified and provided with Pistol grip type handle. The control switches for circuit breakers shall be additionally fitted with lost motion devices and sequencing devices, if required.

6.7.3 The selector switches shall be stay put rotary type and provided with oval shape handles.

6.7.4 The push buttons shall be of momentary contact spring loaded type with a set of normally close and open contacts. The start push button shall be shrouded type and coloured green. The stop push button shall be un-shrouded type and coloured red and other push buttons shall be un-shrouded type and coloured black. The fixing ring shall be metallic white.

6.7.5 Emergency stop push buttons, if specified, shall be lockable in pushed position.

6.8 Control Fuses

6.8.1 The fuses shall be non-deteriorating HRC cartridge link type and shall conform to IS: 13703. They shall be suitable for load and service required in the circuit.

6.8.2 One fuse puller shall be supplied along with each board.

6.9 Miniature Circuit Breakers

6.9.1 The miniature circuit breakers shall conform to IS: 8828 and shall be of duty category M-9.



TALCHER FERTILIZERS LIMITED
TECHNICAL SPECIFICATION - HIGH VOLTAGE
SWITCHBOARDS

PC183-TS-0806

0

Document No.

Rev

Sheet 11 of 13



6.9.2 It shall be provided with overload and short circuit protective devices in a heat resistant housing.

6.9.3 Type test certificate for short circuit rating and current time tripping curve shall be furnished along with the offer.

6.10 Signal Lamps

6.10.1 Signal lamps shall be provided to indicate the various circuit conditions as shown in scheme drawings. The colour of the lamps for various functions shall be as follow:

Red	-	Circuit breaker 'ON'
Green	-	Circuit breaker 'OFF'
White	-	Trip circuit healthy
Amber	-	Alarm and auto trip
Blue	-	Non-Trip

6.10.2 The lamps shall LED type with lumen output of 200 millicandella in axial direction.

7.0 ACCESSORIES

7.1 The supply shall include the following accessories.

- Maintenance truck/device for raising, lowering and withdrawal of circuit breaker, if required.
- Earthing truck, in case the integral earthing arrangement is not feasible in the circuit breaker.
- Fuse puller.
- Test plug for relays.
- Test plug for kWh meters.
- Special tools and tackles, as required.

7.2 Space Heater

7.2.1 Each panel shall be provided with a thermostatically controlled space heater, rated for 240 V, 50 Hz and controlled through double pole miniature circuit breaker.

7.3 Name Plates

7.3.1 The switchboard shall have large name plate on the top to indicate its name and designation.

7.3.2 Each panel shall be provided with name plate both in front and back.

7.3.3 All control switches, push buttons, lamps etc. shall have functional identification labels.

7.3.4 Name plate shall be of black Perspex with white engraving and of minimum 3 mm thick.



7.4 Any other accessories required, but not specified, shall also be supplied to make the switchboard complete in all respects and ensure safe and proper operation.

8.0 PAINTING

8.1 The enclosure, after degreasing, pickling in acid, cold rinsing, phosphatising, passivating etc. shall be painted with two coats of anti-rust paint followed by two coats of anti-corrosive paint.

8.2 Epoxy based paint shall be used.

8.3 All paints shall be carefully selected to withstand tropical heat and extremes of weather. The paint shall not scale off, crinkle or be removed by abrasion due to normal handling.

	TALCHER FERTILIZERS LIMITED TECHNICAL SPECIFICATION - HIGH VOLTAGE SWITCHBOARDS	PC183-TS-0806	0	
		Document No.	Rev	
		Sheet 12 of 13		

8.4 Unless otherwise specified, the finishing shade shall be light grey having shade No.631 as per IS: 5.

8.5 One litre of paint shall be supplied along with each board for touch up at site.

9.0 TESTS AND INSPECTION

9.1 All the switchboards shall be subjected to routine test as per IS: 3427 and their components as per relevant standards.

9.2 Additional tests, wherever specified, shall be carried out.

9.3 All the above tests shall be carried out in presence of purchaser's representative. In addition, the equipment shall be subjected to stage inspection during process of manufacture at works and site inspection.

9.4 These inspection shall, however, not absolve the vendor from his responsibility for making good any defect which shall be noticed subsequently.

10.0 DRAWINGS AND DOCUMENTS

10.1 Drawings and documents as per Annexure-I shall be supplied, unless otherwise specified.

10.2 All drawings and documents shall have the following description written boldly.

- Name of client
- Name of consultant
- Enquiry / Order Number with plant / project name
- Code No. and Description

11.0 SPARES

11.1 Commissioning Spares : Commissioning spares, as required, shall be supplied with the main equipment. Item-wise list of recommended commissioning spares shall be furnished for information.

11.2 Spares for 2 Years Operation (Mandatory), as specified shall be supplied.

11.3 List of Recommend Spares (other than Mandatory Spares) alongwith recommended quantity shall be furnished.

11.4 All spare parts shall be identical to the parts used in the equipment.

12.0 PACKING

12.1 The switchboard shall be properly packed before dispatch to avoid damage during transport, storage and handling.

12.2 The packing box shall contain a copy of the installation, operation and maintenance manual.

12.3 A sign to indicate the upright position of the panels to be placed during transport and storage shall be clearly marked. Also proper arrangement shall be provided to handle the equipment.



ANNEXURE - I
DOCUMENTATION FOR HIGH VOLTAGE SWITCHBOARDS

Sl. No.	Description	Documents Required (Y / N)		
		With Bid	For Approval	Final
1.	Specification Sheets	N	Y	Y
2.	Technical Particulars	N	Y	Y
3.	Feeder Details	N	Y	Y
4.	General arrangement and Foundation Drawings	N	Y	Y
5.	Schematic/Wiring Diagrams	N	Y	Y
6.	Calculation for Bus-bar sizing	N	Y	N
7.	Terminal Arrangement Drawings	N	Y	Y
8.	Illustrative and Descriptive Literature	N	N	Y
9.	Catalogues for bought out accessories	N	N	Y
10.	Installation, Operation and maintenance manual	N	N	Y
11.	Test Certificates			
	i) Type - Switchboard	N	N	N
	- Circuit Breaker	N	N	N
	- MCB	N	N	N
	ii) Routine	N	N	Y
12.	Guarantee Certificates	N	N	Y
13.	Spare Parts List	N	N	Y

Note:

1. 4 hard copies & 1 soft copy shall be supplied for approval after order within 4 weeks from the date of LOI.
 2. 8 hard copies & 2 soft copies in CD shall be submitted as final documents prior to despatch of the equipment. These shall be made in sets and supplied in fine plastic coated folder.
- Y - Yes, N – No



TALCHER FERTILIZERS LIMITED
TECHNICAL SPECIFICATION - BUS DUCT

PC183-TS-0807

0

Document No.

Rev

Sheet 1 of 8



TECHNICAL SPECIFICATION

BUS DUCT

CONTENTS

SECTION NUMBER	DESCRIPTION
1.0	SCOPE
2.0	STANDARDS TO BE FOLLOWED
3.0	SERVICE CONDITIONS
4.0	OPERATING REQUIREMENTS
5.0	GENERAL DESIGN AND CONSTRUCTIONAL FEATURES
6.0	ACCESSORIES
7.0	LAYOUT
8.0	PAINTING
9.0	TESTS AND INSPECTION
10.0	DRAWINGS AND DOCUMENTS
11.0	SPARES
12.0	PACKING
ANNEXURE - I	DOCUMENTATION FOR BUS DUCT

1.0 SCOPE

- 1.1 This standard covers the technical requirements of design, manufacture testing at works and despatch in well packed condition of bus duct.
- 1.2 This standard shall be read in conjunction with relevant part of Design Philosophy - Electrical.

2.0 STANDARDS TO BE FOLLOWED

- 2.1 The design, manufacture and testing of the equipment covered by this standard shall comply with the latest issue of following Indian Standards unless otherwise specified. Equipment complying with equivalent IEC standards shall also be acceptable.

IS: 8084 - Interconnecting bus-bars for A.C. Voltage above 1 KV up to and including 36 KV.

IS: 8623 - Specification for low voltage switchgear and control gear assemblies.

IS: 5578 - Guide for marking of insulated conductors.

IS: 11353 - Guide for uniform system of marking and identification of conductors and apparatus terminals.

- 2.2 The design and operational features of all the equipment offered shall also comply with the provisions of the latest issue of the Indian Electricity Rules and other relevant Statutory Acts and Regulations. The supplier shall wherever necessary, make suitable modifications in the equipment to comply with the above.

- 2.3 Wherever any requirement, laid down in this standard differs from those in Indian Standard Specifications, the requirement specified herein shall prevail.

3.0 SERVICE CONDITIONS

3.1 Ambient conditions

These shall be as indicated in Design Philosophy - Electrical.

3.2 System Details

These shall be as indicated in Design Philosophy - Electrical.

4.0 OPERATING REQUIREMENTS

The bus duct shall be suitable for operating at the rated capacity continuously under the ambient conditions and with the voltage and frequency variations without exceeding the permissible temperature rise and without any detrimental effect on any part.

5.0 GENERAL DESIGN AND CONSTRUCTIONAL FEATURES

5.1 Enclosures

- 5.1.1 The sheet steel enclosure for enclosing and supporting the bus-bars shall be made out of 14 SWG sheet steel, bolted on the angle iron frame work.

- 5.1.2 The enclosure shall completely enclose the bus bars from all sides. It shall have degree of protection IP: 52 for indoor installation and IP: 55 with rain protection canopy for outdoor installation as per IS/IEC:60947. Where part of the bus duct is required for indoor installation and part for outdoor installation, the complete section shall be suitable for outdoor installation. Ventilation louvers, if necessary, shall be provided with fine wire mesh from inside, in that case the degree of protection shall be IP: 42. Neoprene gasket shall be provided on covers at joints.



TALCHER FERTILIZERS LIMITED
TECHNICAL SPECIFICATION - BUS DUCT

PC183-TS-0807

0

Document No.

Rev

Sheet 4 of 8



5.1.3 Whether bus duct (with louvers) is installed outdoor or indoor, suitably rated space heater with thermostat control shall be provided at different locations inside the bus duct to avoid moisture condensation.

5.1.4 All external hardware of diameter less than 8 mm shall be stainless steel and those of diameter 8 mm and above shall be mild steel cadmium plated or zinc passivated.

5.2 Bus Bars and Connections

5.2.1 The bus-bars in LV Bus duct shall be of three phase and neutral, non-segregated and air insulated type.

The bus-bars in HV Bus duct shall be of three phase, phase-segregated with insulating material.

5.2.2 The bus bars shall be amply sized to carry the rated continuous current under the specified ambient temperature without exceeding the temperature limits specified in IS: 8084. The bus bars shall be designed to withstand the system fault current for one second without exceeding the total temperature of 200°C. Type test certificate of similar bus duct shall be furnished.

5.2.3 The bus-bars material shall be high conductivity Aluminium alloy conforming to grade E91E of IS: 5082/electrolytic grade copper.

5.2.4 The bus-bars shall be rectangular in shape and cross-sectional area of neutral bus-bars shall be half of phase bus-bars.

5.2.5 The sizes of bus-bars selected shall be subjected to approval by PDIL. The vendor shall furnish supporting calculations for bus-bars and enclosure sizes both under normal load and short circuit conditions as well as that of temperature rise along with the offer.

5.2.6 All the bus-bars shall be bare and without any painting. The bus-bars shall be arranged and provided with proper phase identification as per IS: 5578/11353.

5.3 Joints and Bends

5.3.1 Only lap joints shall be used for jointing the bus bars. The over lap shall be equal to the width of the bus bars.

5.3.2 The contact surfaces of the overlapping bus-bars shall be thoroughly cleaned followed by application of good quality electrical grease and bolted immediately. In case of Aluminium to copper joints, copper bus-bars in addition shall be preferably tinned.

5.3.3 The bolting schedule adopted shall ensure proper contact pressure. A minimum of two bolts shall be used per joint.

5.3.4 The contact pressure shall be 100-140 kg/cm². Only high tensile, zinc passivated or galvanized steel bolts shall be used along with large diameter flat washers of adequate thickness.

5.3.5 At the bends, the bus-bars shall bend at a radius of 2t where the 't' is the thickness of the bus-bars and the radius is measured to the inside of bus-bars.

5.4 Flexible Joints

Flexible joints and connections shall consist of tinned laminated copper strips or Aluminium strips of required cross sectional area. Precautions as mentioned under 5.3.2 shall also be observed while marking joints with laminated copper plates. Filler plates of Aluminium as required shall be used.

5.5 Expansion Joints

Expansion joints, where necessary, to allow for longitudinal expansion and contraction of bus-bars and bus enclosures caused by temperature variation shall be provided.



5.6 Bus Bar Supports

5.6.1 The bus-bars shall be rigidly supported at equal intervals. The bus-bars supports shall be such that they withstand stresses to which they may be subjected under normal and short circuit conditions.

5.6.2 The supports shall be of moulded construction of fibre glass reinforced with thermosetting plastics or superior materials. The supports, where necessary, shall either have built-in anti-tracking barriers or painted with anti-tracking varnishes.

5.7 Clearances and Creepage Distance

5.7.1 The clearances and creepage distance shall not be lower than the values specified below for any part of the bus duct.

- | | | | |
|------|---|---|-------|
| i) | Minimum clearance between two live parts | - | 25 mm |
| ii) | Minimum clearance between a live part and accidentally dangerous part | - | 25 mm |
| iii) | Creepage distance | - | 30 mm |

5.7.2 The clearances and creepage distance, as specified above, shall definitely be maintained throughout the bus bars system. Provision of bus-bar separators or barriers shall not be considered to reduce the clearances from the values specified above.

5.8 Terminal Chambers at Switchgear and Transformer End

5.8.1 The bus duct shall be suitable for bolting to the flanges provided at the transformer and switchgear end. The exact dimensions and details of these terminal chambers shall be made available at the time of execution.

5.8.2 Phase changeover arrangement wherever required shall be provided in one of the terminal chambers to connect the bus-bars between same phase terminals at switchgear and transformer ends.

6.0 ACCESSORIES

6.1 Earthing

Two continuous earth strips of Aluminium having minimum 300 sq. mm size shall be provided throughout the length of bus duct or shall be suitable for full short circuit fault current for 1 sec. whichever is more.

6.2 Drain Plug

Bus duct shall be provided with drain plug to remove condensed moisture when required.

6.3 Fire Barriers

Two sets of epoxy moulded fire barriers shall be provided on switchgear end as well as transformer end.

6.4 Name Plates

6.4.1 Each bus duct shall be provided with a name plate of stainless steel with letter embossed on them and located at convenient location.

6.4.2 The name plate shall contain all details as per IS: 8084.

6.5 Hardware

Required number of hardwares like bolts, nuts, plain washers, spring washers etc. shall be provided for jointing the bus duct with transformer as well as switchgears.

7.0 LAYOUT

7.1 The proposed bus duct routing between transformer and associated switchgear shall be as shown in the drawing enclosed with NIT. Where no layout drawing is enclosed, the



TALCHER FERTILIZERS LIMITED
TECHNICAL SPECIFICATION - BUS DUCT

PC183-TS-0807

0

Document No.

Rev

Sheet 6 of 8



schedule of quantities shall be followed for bidding. However, the exact routing and details of switchgear and transformer end chambers shall be supplied at the time of order or drawing approval.

7.2 The successful vendor shall prepare final layout drawing for each bus duct with bill of materials and submit the same for PDIL/Purchaser's approval.

8.0 PAINTING

8.1 The enclosure after degreasing, pickling in acid, rinsing, phosphatising, passivating etc. shall be painted with two coats of anti-rust paint followed by two coats of anticorrosive paint.

8.2 Epoxy based paint shall be used.

8.3 All paints shall be carefully selected to withstand tropical heat and extremes of weather. The paint shall not scale off, crinkle or be removed by abrasion due to normal handling.

8.4 Unless otherwise specified, the finishing shade shall be light grey having shade no. 631 as per IS: 5.

9.0 TESTS AND INSPECTION

9.1 The bus duct shall be subjected to routine tests as per relevant standard.

9.2 Wherever specified, temperature rise tests shall be carried out on a minimum 5 metre length bus duct of each rating.

9.3 The test shall be carried out in manufacturer's works in presence of purchaser's representative. In addition, the bus ducts shall be subjected to stage inspection at works and inspection at site for final acceptance.

9.4 These inspections shall, however, not absolve the vendor from his responsibility of making good any defect which may be noticed subsequently.

10.0 DRAWINGS AND DOCUMENTS

10.1 Drawings and documents as per Annexure - I shall be supplied, unless otherwise specified.

10.2 All drawings and documents shall have the following descriptions written boldly

- Name of client
- Name of consultant
- Enquiry / Order Number with plant / project name
- Code No. and Description

11.0 SPARES

11.1 Commissioning Spares : Commissioning spares, as required, shall be supplied with the main equipment. Item-wise list of recommended commissioning spares shall be furnished for information.

11.2 Spares for 2 Years Operation (Mandatory), as specified shall be supplied.

11.3 List of Recommend Spares (other than Mandatory Spares) alongwith recommended quantity shall be furnished.

11.4 All spare parts shall be identical to the parts used in the equipment.

12.0 PACKING

12.1 The bus duct shall be properly packed before despatch to avoid damage during transport, storage and handling. It shall be wrapped in polythene bags to make it



TALCHER FERTILIZERS LIMITED
TECHNICAL SPECIFICATION - BUS DUCT

PC183-TS-0807

0

Document No.

Rev

Sheet 7 of 8



waterproof. An additional wrapping with bitumen paper shall also be provided to make it completely water proof before the equipment is packed in wooden crates.

- 12.2 The packing box shall contain a copy of the installation, operation and maintenance manual.

ANNEXURE - I
DOCUMENTATION FOR BUS DUCT

Sl.No.	Description	Documents Required (Y / N)		
		With Bid	For Approval	Final
1.	General arrangement for each bus duct showing the complete layout.	N	Y	Y
2.	Design calculations	N	Y	N
	a) Bus bars sizing			
	b) Flexible sizing			
	c) Temperature Rise			
	d) Support Span			
3.	Specification sheet & Technical Particulars	N	Y	Y
4.	Switchgear end termination details for each rating of bus duct.	N	Y	Y
5.	Transformer end termination details for each rating of bus duct.	N	Y	Y
6.	Assembly drawing of rigid bends.	N	Y	Y
7.	Assembly drawing of bends with flexible	N	Y	Y
8.	Assembly drawing of straight run	N	Y	Y
9.	Transposition chamber details	N	Y	Y
10.	Installation, operation & maintenance manual	N	Y	Y
11.	Test Certificates			
	i) Type	N	N	N
	ii) Routine & others	N	N	Y
12.	Guarantee Certificates	N	N	Y
13.	List of spare parts	N	N	N

Note:

1. 4 hard copies & 1 soft copy shall be supplied for approval after order within 4 weeks from the date of LOI.
2. 8 hard copies & 2 soft copies in CD shall be submitted as final documents prior to despatch of the equipment. These shall be made in sets and supplied in fine plastic coated folder.

Y - Yes, N - No

	TALCHER FERTILIZERS LIMITED TECHNICAL SPECIFICATION - SHEET STEEL DISTRIBUTION BOARDS	PC183-TS-0808	0	
		Document No.	Rev	
		Sheet 1 of 11		



TECHNICAL SPECIFICATION

SHEET STEEL DISTRIBUTION BOARDS



CONTENTS

SECTION NUMBER	DESCRIPTION
1.0	SCOPE
2.0	STANDARDS TO BE FOLLOWED
3.0	SERVICE CONDITIONS
4.0	OPERATING REQUIREMENTS
5.0	DESIGN AND CONSTRUCTIONAL FEATURES
6.0	COMPONENT DETAILS
7.0	ACCESSORIES
8.0	PAINTING
9.0	TESTS AND INSPECTION
10.0	DRAWINGS AND DOCUMENTS
11.0	SPARES
12.0	PACKING
ANNEXURE - I	DOCUMENTATION FOR SHEET STEEL DISTRIBUTION BOARDS

	TALCHER FERTILIZERS LIMITED TECHNICAL SPECIFICATION - SHEET STEEL DISTRIBUTION BOARDS	PC183-TS-0808	0	
		Document No.	Rev	
		Sheet 3 of 11		

1.0 SCOPE

- 1.1 This standard covers the technical requirements of design, manufacture, testing at works and delivery in well-packed condition of Sheet Steel Distribution Boards.
- 1.2 This standard shall be read in conjunction with relevant part of Design Philosophy – Electrical.

2.0 STANDARDS TO BE FOLLOWED

- 2.1 The design, manufacture and testing of the equipment shall comply with the latest issue of the following Indian Standards, unless otherwise specified. Equipment complying with equivalent IEC standards shall also be acceptable.

- IS: 8623 - Specification for low voltage switchgear and control gear assemblies.
- IS/IEC:60947 - Specification for Low-voltage Switchgear and Control gear
- IS: 5578 - Guide for marking of insulated conductors.
- IS: 11353 - Guide for uniform system of marking and identification of conductors and apparatus terminals.
- IS: 10118 - Code of practice for selection, installation and maintenance of switchgear and control gear.

Various components housed in the distribution board shall conform to the Indian Standard Specification as mentioned against the component details.

- 2.2 The design and operational features of the equipment offered shall also comply with the provisions of the latest issue of the Indian Electricity Rules and other Statutory Acts and Regulations. The supplier shall, wherever necessary, make suitable modifications in the equipment to comply with the above.
- 2.3 Wherever any requirement, laid down in this standard, differs from that in Indian Standard Specification the requirement specified herein shall prevail.

3.0 SERVICE CONDITIONS

3.1 Ambient Conditions

These shall be as indicated in Design Philosophy – Electrical.

3.2 System Details

These shall be as indicated in Design Philosophy – Electrical.



4.0 OPERATING REQUIREMENTS

The distribution board shall be suitable for operating at the specified rating continuously with the specified voltage and frequency variations under the ambient conditions, without exceeding the permissible temperature rise and without any detrimental effect on any part.

5.0 DESIGN AND CONSTRUCTIONAL FEATURES

5.1 General

- 5.1.1 The distribution board shall consist of an assembly of a series of floor mounting, identical, metal clad, dead front type panels of unitized design. The panels shall be placed side by side to form a compact assembly and shall be extensible on either side.
- 5.1.2 The complete assembly shall be dust, damp and vermin proof having minimum degree of protection equivalent to IP-52 as per IS/IEC:60947.
- 5.1.3 The frame work of the cubicles shall be of bolted/welded construction. The minimum thickness of steel shall be 2 mm for load bearing members, 1.6 mm for non-load bearing

	TALCHER FERTILIZERS LIMITED TECHNICAL SPECIFICATION - SHEET STEEL DISTRIBUTION BOARDS	PC183-TS-0808	0	
		Document No.	Rev	
		Sheet 4 of 11		

members and 3 mm for base channel. The doors and covers shall be fabricated from cold rolled sheet steel. Suitable reinforcement, wherever necessary, shall be provided.



- 5.1.4 The door hinges shall be concealed type.
- 5.1.5 All external hardware shall be cadmium plated/zinc passivated. The hardware for fixing the removable parts shall be provided with retaining devices.
- 5.1.6 The doors and the removable covers shall be provided with non-deteriorating neoprene gaskets. Gaskets without any discontinuity shall be preferred. Gaskets shall be held in position in groove of shaped sheet steel work or these shall be of U type. Adhesive cement, if used, shall be of good quality so that the gaskets do not come off during service.
- 5.1.7 All the components shall be accessible for inspection and maintenance without the necessity for removal of the adjacent ones. In case of single front design all components shall be accessible from the front for maintenance and back opening doors/ openable covers for maintenance shall not be acceptable.
- 5.1.8 The layout of the components inside a module shall be liberal to facilitate maintenance and the interconnection of wiring between the components shall not be subjected to any undue stress at the bends.
- 5.1.9 Mounting height of components requiring operation and observation shall not be lower than 300 mm and higher than 1800 mm.
- 5.1.10 Inter panel barriers shall be provided.
- 5.1.11 Adequate arrangement for earthing shall be provided to safeguard the operator or other personnel from electric hazards under all conditions of operation.

5.2 Panel Arrangement

- 5.2.1 The distribution board shall be non-drawout type in single front configuration.
- 5.2.2 Each Panel shall have its horizontal bus-bar chamber running on the top with multi-tier module units in the centre and having vertical bus-bar chamber and cable alley on either side.
- 5.2.3 The modules shall be enclosed on all sides and shall be so arranged that larger ones are placed at the bottom portion of the panel. Fixed type modules shall be at least 300 mm from the base channel.
- 5.2.4 The number of modules in the panel shall not exceed six for motor starter feeders and eight for switch fuse/MCB/MCCB feeders. The minimum size of module shall be 300 mm and 200 mm for starter and switch fuse feeders. The incomer and bus coupler module sizes for ratings up to 400 A shall be half the panel size. For higher ratings they shall be housed in single panel.
- 5.2.5 The module door shall be so interlocked that it shall not be possible to open the door with switch in closed position. Defeat interlock facility shall be provided.
- 5.2.6 The relay, meters, switches and lamps shall be flush mounted. All components of one module shall be mounted on the same module on a rigid sheet steel chassis. A 20 mm dia. rotating knob on the door shall be provided for closing and opening.



5.3 Bus Bars and Connections

- 5.3.1 The bus-bar shall be suitable for the supply system. The bus-bar and connections shall be made of electrolytic copper or high conductivity aluminium alloy conforming to Grade E91E of IS: 5082.
- 5.3.2 The bus-bar shall be amply sized to carry the rated continuous current under the specified ambient temperature without exceeding the temperature of 90°C. The bus-bars shall also be designed to withstand the system fault current for 1 second without



	TALCHER FERTILIZERS LIMITED TECHNICAL SPECIFICATION - SHEET STEEL DISTRIBUTION BOARDS	PC183-TS-0808	0	
		Document No.	Rev	
		Sheet 5 of 11		

exceeding the temperature of 200°C for bare aluminium and 250°C for bare copper. The minimum acceptable size of bus-bars shall be 250 sq. mm (Al). Calculation for the bus-bar sizing shall be furnished along with the offer.

- 5.3.3 In case of double front arrangement of distribution boards, different sets of vertical bus-bars shall be provided. The vertical bus-bars shall be PVC sleeved or shrouded by insulating barriers which shall have cut-outs to permit entry of power wires. It shall be possible to remove the shroud for inspection and maintenance. Neutral-bars shall be provided in this chamber.
- 5.3.4 Horizontal bus-bars shall be of same cross-section through out. Stepped bus-bars shall not be acceptable.
- 5.3.5 All bus-bars shall be arranged and colours coded according to IS: 5578/11353.
- 5.3.6 The horizontal bus-bar shall run in a separate bus chamber located at the top shall have separate screwed cover for inspection purpose.
- 5.3.7 The bus-bars shall be rigidly supported at equal intervals to withstand maximum short circuit stresses. The supports shall be of moulded construction with built in anti tracking barriers. The support material shall be of fibre glass reinforced thermosetting plastic.
- 5.3.8 All joints shall be suitably treated to avoid oxidation of contact surfaces and bimetallic corrosion. A minimum of two bolts with spring washers shall be used for horizontal bus-bar joints.
- 5.3.9 Horizontal bus bars shall be insulated with heat shrinkable PVC sleeves of reputed makes. Insulating shrouds shall be provided for all joints of insulated bus-bars.
- 5.4 Clearance and Creepage Distances**
- 5.4.1 The clearance and creepage distances shall not be lower than the values specified below :
- | | | |
|---|----|-------|
| i) Minimum clearance between two live conductors | -- | 20 mm |
| ii) Minimum clearance between live part and accidentally dangerous part | -- | 20 mm |
| iii) Minimum creepage distance | -- | 28 mm |
- 5.4.2 The clearances and the creepage, as specified above, shall definitely be maintained in the bus-bar system. Provision of bus-bar insulations, separator or barriers shall not be considered to reduce the clearance from the values specified above.
- 5.4.3 At the termination points in the equipment, e.g. switches, contactors, thermal relays, etc. it is realized that above clearance shall not always be possible to be maintained. All such points where above clearance are not possible to be maintained shall, therefore, be insulated or taped.
- 5.5 Insulation**
- 5.5.1 The insulation used shall be non-hygroscopic and shall be of porcelain, Epoxy- resins or fibre glass moulded with plastic. It shall be of adequate electrical and mechanical strength to give trouble free service during normal operation and short circuit conditions.
- 5.5.2 The insulation shall be treated suitably to withstand the tropical conditions and atmospheric pollution.
- 5.6 Power Wiring**
- 5.6.1 The connections from bus-bar including neutral to individual units on the modules shall consist of PVC insulated flexible copper cable or tapped copper strip.

	TALCHER FERTILIZERS LIMITED TECHNICAL SPECIFICATION - SHEET STEEL DISTRIBUTION BOARDS	PC183-TS-0808	0	
		Document No.	Rev	
		Sheet 6 of 11		

- 5.6.2 The power wiring size shall be decided based on the rating of the switch, after using a rating factor of not more than 50% over the current rating in free air. In any case the minimum size of power wiring shall not be less than 4 sq. mm copper.
- 5.6.3 The size of connection from incomer to horizontal bus-bar and from horizontal bus-bar to bus coupler shall not be less than the size adopted for horizontal bus-bar.
- 5.7 Control Wiring**
- 5.7.1 The switch board shall be completely factory wired and ready for external connections.
- 5.7.2 The wiring shall be carried out with flexible stranded PVC insulated copper conductor cables of 1100 Volt grade. The size of wires shall be as follows:
- | | | |
|---------------------------|----|------------|
| C.T. Circuit | -- | 2.5 sq. mm |
| V.T. and Control Circuits | -- | 1.5 sq. mm |
- 5.7.3 All wiring shall be provided with dependent both end marking as per IS: 5578. Numbered ferrules, reading from the terminals outwards, shall be provided at both ends of all wiring for easy identification. These shall be interlocking type plastic ferrules.
- 5.7.4 Control wiring circuits, fed from a supply common to a number of feeders, shall be so protected that failure of a circuit in one feeder does not affect the operation of the other feeders.
- 5.7.5 The wiring to the equipment mounted on the doors shall be carried out with flexible multi strand copper conductor cable and supported so that opening of the door, there is no undue strain on wire leads.
- 5.7.6 The control cables shall be neatly arranged and properly supported.
- 5.8 External Cable Termination**
- 5.8.1 All power and control cables shall enter the distribution board from the bottom. Sufficient space shall be provided for ease of connection and termination of cables.
- 5.8.2 All cables shall be of 1.1 KV grade PVC insulated armoured and PVC sheathed except for single core cable which shall be unarmoured. The number and sizes of cable shall be as indicated in Feeder details.
- 5.8.3 Compression type cable glands along with the cable lugs as required shall be provided for termination of cables.
- 5.8.4 The cable glands shall be of rolled Aluminium heavy duty double compression type and shall be mounted on a removable gland plate, provided at a minimum height of 75 mm from the bottom of the distribution board. Two numbers spare knockouts of size 20 mm shall also be provided on the gland plates for future use.
- 5.8.5 For all power cables crimped type aluminium lugs for aluminium cables and tinned copper lugs for copper cables shall be provided.
- 5.8.6 The terminal blocks shall be pressure clamp type up to 35 sq. mm cable and bolted lug type for higher sizes of cables. These shall be protected type and rated for 1100 Volts service. The minimum current rating of terminal block shall be 16 Amp. The construction shall be such that after the connection of cables by means of lugs, necessary clearance and creepage distance are available.
- 5.8.7 Where more than two cables in parallel are required to be terminated, a system of bus links shall be provided with adequate clearance and spacing.
- 5.8.8 Suitable clamps to support the vertical run of cables shall be provided.
- 5.8.9 The terminal block shall be grouped according to circuit functions and suitably numbered. 20% extra terminals shall be provided in the terminal block.

	TALCHER FERTILIZERS LIMITED TECHNICAL SPECIFICATION - SHEET STEEL DISTRIBUTION BOARDS	PC183-TS-0808	0	
		Document No.	Rev	
		Sheet 7 of 11		

5.8.10 For power connections, suitable marking on the terminals shall be provided to identify the phases.

5.9 Feeder Details

5.9.1 The requirements of incomer, bus coupler and outgoing feeders shall be as indicated in the single line diagram, feeder details and corresponding schematic diagram.

5.9.2 The bus coupler shall be so located that it is possible to maintain half of the bus-bars while the other half is still alive. Complete segregation of bus-bar connections to bus coupler shall be provided.

5.9.3 Castle key type mechanical interlocks shall be provided between incomers and bus section modules to avoid paralleling of incomers. In addition padlocking facilities shall be provided in OFF position.

5.9.4 Single phase loads shall be distributed as far as possible on all the three phases.

6.0 COMPONENT DETAILS

The components shall conform to type of co-ordination C as per IS/IEC:60947. Makes of all components shall be subject to owner's / consultant's approval

6.1 Moulded Case Circuit Breakers

6.1.1 The circuit breaker shall conform to IS/IEC:60947 and shall be of P2 category having rupturing capacity as per system requirement.

6.1.2 The circuit breaker shall be provided with spring assisted quick make quick break type manually operated trip free mechanism, mechanical ON/OFF position indicators, thermal tripping devices of inverse characteristics, instantaneous short circuit tripping devices and necessary auxiliary and alarm switches. The MCCB cubicle shall be provided with service, test and isolated position and automatic safety shutter.

6.1.3 The thermal and short circuit tripping device shall be adjustable type.

6.1.4 When used for motor circuit shunt trip devices shall be provided and the let through power of controlling MCCB shall be lower than the respective contactor.

6.1.5 In addition, under voltage trip shall be provided, if specified.

6.2 Switches

6.2.1 The switches shall be Motor duty type AC23 category and shall comply with the requirements laid down in IS/IEC:60947. Switches up to 63 Amps shall be rotary type and those of 100 Amp and above shall be link type.

6.2.2 'ON' and 'OFF' positions of the switches shall be indicated on the panel. Provision shall be made to lock the switch in the 'OFF' position.

6.2.3 The fixed contacts shall be shrouded and the contacts shall be silver plated.

6.2.4 Two Pole switches shall also isolate the neutral circuit along with phase circuit. 4 Pole / 2 Pole switches shall be used for 3 Phase/1 Phase circuits respectively.



6.3 Fuses

The fuses shall be of non-deteriorating HRC cartridge link type and conform to IS: 13703. They shall be suitable for the load and the service required in the circuit.

6.4 Air Break Contactors

6.4.1 The Air Break Contactor shall be of AC3 category unless otherwise specified, conforming to IS/IEC:60947 and flapper type. Gravity operated contactors are not acceptable.

6.4.2 The dropout voltage shall not exceed 65% of rated voltage.

	TALCHER FERTILIZERS LIMITED TECHNICAL SPECIFICATION - SHEET STEEL DISTRIBUTION BOARDS	PC183-TS-0808	0	
		Document No.	Rev	
		Sheet 8 of 11		

6.4.3 Each contactor shall be provided with auxiliary contacts as required. The rating of the auxiliary contacts shall be 5 Amps. AC or 1 Amp DC at the specified control voltages. The spare auxiliary contacts shall also be wired terminal block.

6.5 **Bimetal Thermal Overload Relays**

6.5.1 The contactor shall be provided with three pole bimetal thermal overload relays unless otherwise specified. The bimetal relays shall be of suitable range, ambient temperature compensated and shall be separate mounting type. They shall be adjustable through graduated scale and shall be provided with changeover contact.

6.5.2 Bimetal relays shall conform to IS: 3231 and shall have built in single phasing preventor.

6.5.3 The bimetal relays shall be provided with a manual reset device resetable after opening the cubicle door. Auto reset thermal relays are not acceptable.

6.6 **Current Transformers**

6.6.1 The current transformers shall conform to IS: 2705.

6.6.2 Current Transformers shall be Class-F insulated and vacuum impregnated. The Current Transformers shall be rigidly mounted and shall be easily accessible for maintenance and testing.

6.6.3 The Current Transformers shall be of 7.5 VA output. The output shall be adequate for the instrument and metering duties involved with sufficient margin. The Current Transformers shall have the accuracy Class-1 for the metering duty.

6.6.4 All the Current Transformers shall be provided with terminals and shorting links. One of the terminals of C.T. shall be earthed. The polarity of the C.T. shall be clearly marked.

6.6.5 The C.T.s shall be capable of withstanding momentary open-circuit on the secondary side without injurious effects.

6.7 **Instruments and Meters**

6.7.1 All instruments shall be flush mounting type with square face and shall be tropicalized and dust tight.

6.7.2 The size of the instruments shall be 96 mm x 96 mm for full and half size modules and 72 mm x 72 mm for lower size modules.

6.7.3 Dials shall be parallax free with scale marked in black on white background and shall be suitable for direct reading.

6.7.4 Zero adjusters shall be provided for operation from the front of the cases.

6.7.5 All ammeters and voltmeters shall have 0 - 240° scale moving iron spring controlled type and of Class 1.5 accuracy as per IS: 1248. The scale range of the ammeter and voltmeter shall be as indicated in the feeder details.



6.7.6 In case of motor feeders, the ammeter shall be graduated uniformly upto C.T. primary current and with a compressed end scale upto 6 times the C.T. primary current. Red pointer shall be provided, which can be adjusted at site for indicating full load current.

6.7.7 KWH meter shall be 3 phase 4 wire type. These shall conform to the requirements of relevant IS and shall be C.T. operated. The current coil shall be rated for 5 Amp.

6.7.8 All kWh meters shall be provided with test blocks for current and voltage coils for testing them at site without interrupting their recording while in service.

6.8 **Push Button and Control Switches**

6.8.1 The switches and push buttons shall conform to utilization category AC 11/DC 11 as per IS/IEC:60947 . The contact shall be rated to make, break and carry inductive current of 5 Amp. at 415 V AC and 1 Amp at 220 V DC.

	TALCHER FERTILIZERS LIMITED TECHNICAL SPECIFICATION - SHEET STEEL DISTRIBUTION BOARDS	PC183-TS-0808	0	
		Document No.	Rev	
		Sheet 9 of 11		

6.8.2 The control switches shall be spring return rotary type unless otherwise specified and provided with pistol grip type handle. The control switches for circuit breakers shall be additionally fitted with lost motion devices and sequencing devices.

6.8.3 The selector switches shall be stay-put rotary type and provided with oval shape handles.

6.8.4 The push buttons shall be of momentary contact spring loaded type with a set of normally close and open contacts. The push button for 'Start' shall be shrouded type and coloured green, stop push button shall be un-shrouded type and coloured red and other push buttons shall be un-shrouded type coloured black. The fixing ring shall be metallic white.

6.8.5 Emergency stop push buttons, if specified, shall be lockable in pushed position.

6.9 **Miniature Circuit Breakers**

6.9.1 The miniature circuit breakers shall conform to IS: 13032 and shall be of duty category M-9.

6.9.2 It shall be provided with overload and short circuit protective devices in a heat resistant housing.

6.9.3 A certificate of short circuit rating and current time tripping curve shall be furnished alongwith the offer.

6.10 **Signal Lamps**

6.10.1 Signal lamps shall be provided to indicate the various circuit conditions as shown in scheme drawings. The colour of the lamps for various functions shall be as follows:

Red	--	Switch/Contactor closed.
Green	--	Switch/Contactor open.

6.10.2 The lamps shall be LED type having lumen output 200 milli candela in axial direction.

6.10.3 It shall be possible to remove the globe from outside for replacement of lamps.

7.0 **ACCESSORIES**

7.1 The supplier shall include the following accessories.

- Fuse Puller.
- Test plug for kWh meters.

7.2 **Space Heater**

Each vertical section shall be provided with a thermostatically controlled space heater, rated for 240 V, 50 Hz and controlled through double pole miniature circuit breaker.

7.3 **Name Plates**

7.3.1 The distribution board shall have large name plate on the top to indicate its name and designation.

7.3.2 Each feeder shall be provided with name plate. Each single front panel shall have name plate both in front and back.



7.3.3 All control switches, push buttons, lamps etc. shall have functional identification labels.

7.3.4 Name plate shall be of black perspex with white engraving and of minimum 3 mm thick.

7.3.5 Any other accessories required, but not specified shall also be supplied to make the distribution board complete in all respects to ensure safe and proper operation.

8.0 **PAINTING**

8.1 The enclosure after degreasing, pickling in acid, cold rinsing phosphatising, passivating etc. shall be painted with two coats of anti-rust paint followed by two coats of anticorrosive paint.

	TALCHER FERTILIZERS LIMITED TECHNICAL SPECIFICATION - SHEET STEEL DISTRIBUTION BOARDS	PC183-TS-0808	0	
		Document No.	Rev	
		Sheet 10 of 11		

- 8.2 Epoxy based paint shall be used.
- 8.3 All paints shall be carefully selected to withstand tropical heat and extremes of weather. The paint shall not scale off, crinkle or be removed by abrasion due to normal handling.
- 8.4 Unless otherwise specified, the finishing shade shall be light grey Shade No.631 as per IS: 5.
- 8.5 One litre of paint shall be supplied along with each board for touch up at site.

9.0 TESTS AND INSPECTION

- 9.1 The distribution boards shall be subjected to routine test as per IS: 8623.
- 9.2 Additional tests, wherever specified, shall be carried out.
- 9.3 All the above tests shall be carried out in presence of purchaser's representative. In addition, the equipment shall be subjected to stage inspection during process of manufacture at works and site inspection.
- 9.4 These inspections shall however, not absolve the vendor from his responsibility for making good any defect which shall be noticed subsequently.

10.0 DRAWINGS AND DOCUMENTS

- 10.1 Drawings and documents as per Annexure-I shall be supplied unless otherwise specified.
- 10.2 All drawings and documents shall have the following description written boldly:
- Name of client
 - Name of consultant
 - Enquiry / Order Number with plant / project name
 - Code No. and Description

11.0 SPARES

- 11.1 Commissioning Spares: Commissioning spares, as required, shall be supplied with the main equipment. Item-wise list of recommended commissioning spares shall be furnished for information.
- 11.2 Spare for 2 Years Operation (Mandatory), as specified shall be supplied.
- 11.3 List of Recommend Spares (other than Mandatory Spares) alongwith recommended quantity and item-wise price shall be furnished.
- 11.4 All spare parts shall be identical to the parts used in the equipment.

12.0 PACKING

- 12.1 The distribution board shall be properly packed before despatch to avoid damage during transport, storage and handling.
- 12.2 The packing box shall contain a copy of the installation, operation and maintenance manual.
- 12.3 A sign to indicate the upright position of the panels to be placed during transport and storage shall be clearly marked. Also proper arrangement shall be provided to handle the equipment.

ANNEXURE - I



DOCUMENTATION FOR SHEET STEEL DISTRIBUTION BOARDS

Sl.No.	Documents	Documents Required (Y / N)		
		With Bid	For Approval	Final
1.	Specification Sheet	N	Y	Y
2.	Technical Particulars	N	Y	Y
3.	Feeder Details	N	Y	Y
4.	General Arrangement and Foundation Drawings	N	Y	Y
5.	Schematic Diagrams with Terminal arrangement drawings	N	Y	Y
6.	Calculation for Bus-bar sizing	N	Y	N
7.	Illustrative and Descriptive literature	N	N	Y
8.	Catalogues for bought out accessories	N	N	Y
9.	Installation, Operation and Maintenance Manual	N	N	Y
10.	Test Certificates			
	-- Type (for MCCB & MCB)	N	N	N
	-- Routine	N	N	Y
11.	Guarantee Certificates	N	N	Y
12.	Spare Parts List	N	N	Y

Note:

- 4 hard copies & 1 soft copy shall be supplied for approval after order within 4 weeks from the date of LOI.
- 8 hard copies & 2 soft copies in CD shall be submitted as final documents prior to despatch of the equipment. These shall be made in sets and supplied in fine plastic coated folder.

Y - Yes, N - No



	TALCHER FERTILIZERS LIMITED TECHNICAL SPECIFICATION - LIGHTING SUB DISTRIBUTION BOARDS	PC183-TS-0809	0	
		Document No.	Rev	
		Sheet 1 of 6		

TECHNICAL SPECIFICATION

LIGHTING SUB DISTRIBUTION BOARDS

CONTENTS

SECTION NUMBER	DESCRIPTION
1.0	SCOPE
2.0	STANDARDS TO BE FOLLOWED
3.0	SERVICE CONDITIONS
4.0	OPERATING REQUIREMENTS
5.0	GENERAL DESIGN AND CONSTRUCTIONAL FEATURES
6.0	SPECIAL FEATURES FOR FLAME PROOF LIGHTING SUB DISTRIBUTION BOARDS
7.0	COMPONENT DETAILS
8.0	PAINTING
9.0	TESTS AND INSPECTION
10.0	DRAWINGS AND DOCUMENTS
11.0	SPARES
12.0	PACKING
ANNEXURE - I	DOCUMENTATION FOR LIGHTING SUB DISTRIBUTION BOARDS

	TALCHER FERTILIZERS LIMITED TECHNICAL SPECIFICATION - LIGHTING SUB DISTRIBUTION BOARDS	PC183-TS-0809	0	
		Document No.	Rev	
		Sheet 3 of 6		

1.0 SCOPE

- 1.1 This standard covers the technical requirements of design, manufacture, testing at works and delivery in well packed condition of lighting sub distribution boards.
- 1.2 This standard shall be read in conjunction with relevant part of Design Philosophy - Electrical.

2.0 STANDARDS TO BE FOLLOWED

- 2.1 The design, manufacture and testing of the equipment covered by this standard shall comply with the latest issue of the following Indian Standards. Equipment complying with equivalent IEC standards shall also be acceptable
- IS/IEC:60947 - Low voltage switchgear and control gear
 - IS: 8623 - Specification for low voltage switchgear and control gear assemblies
- 2.2 The design and operational features of the equipment offered shall also comply with the provisions of latest issue of the Indian Electricity Rules and other relevant statutory acts and regulations. The supplier shall, wherever necessary, make suitable modification in the equipment to comply with the above.
- 2.3 Wherever any requirement, laid down in this standard, differs from that in Indian Standard Specifications, the requirement specified herein shall prevail.

3.0 SERVICE CONDITIONS

3.1 Ambient Conditions

These shall be as indicated in Design Philosophy - Electrical.

3.2 System Details



These shall be as indicated in Design Philosophy - Electrical.

4.0 OPERATING REQUIREMENTS



The lighting sub-distribution boards shall be suitable for operating continuously under the ambient conditions and with the voltage and frequency variations, without exceeding the specified temperature rise and without any detrimental effect on any part.

5.0 GENERAL DESIGN AND CONSTRUCTIONAL FEATURES

- 5.1 The lighting sub distribution boards shall be fabricated out of 2.5 mm thick cold rolled sheet steel and shall be suitable for mounting on wall/structure. These shall have dust and vermin proof construction conforming to IP-65 as per IS/IEC:60947. For outdoor installation, the enclosure shall conform to IPW-55. Suitable canopy made out of 2 mm thick Aluminium sheet shall be supplied along with the board.
- 5.2 The miniature circuit breakers shall be so mounted inside the enclosure that their operating knobs project outside for easy operation. The cut-out for the knobs on the enclosure shall be lined with gasket for dust proofness. For further protection against ingress of dust, the portion where the knobs have protruded out, shall be provided with another external front cover, internally hinged at the top, gravity operated and with a knurled knob at the bottom. The external cover shall be flushed with the main cover. Continuous neoprene gasket shall be provided to make the board completely dust and weather proof.
- 5.3 All external hard ware of diameter less than 8 mm shall be of stainless steel and those of diameter 8 mm and above shall be of mild steel cadmium plated or zinc passivated.

	TALCHER FERTILIZERS LIMITED TECHNICAL SPECIFICATION - LIGHTING SUB DISTRIBUTION BOARDS	PC183-TS-0809	0	
		Document No.	Rev	
		Sheet 4 of 6		

- 5.4 The sub-distribution boards to be located indoors shall have top entry arrangement for outgoing cables and bottom entry for incoming cable. However for outdoor locations, all cable entries shall be from the bottom only.
- 5.5 Three phase and neutral bus bar system of adequate size shall be provided to which all outgoing and incoming MCB's shall be connected.
- 5.6 The internal wiring shall be carried out by means of single core PVC insulated 2.5 sq. mm stranded copper conductor cables.
- 5.7 Two earthing terminals outside the board shall be provided.
- 5.8 Suitable label inscription consisting of black perspex with engraving for the board and circuit nos. of all outgoing feeders shall be provided. The label inscription of the board shall contain description and code no. The circuit nos. of outgoing feeders shall be serially indicated as 1L, 2L.....17L, 18L.
- 5.9 The board shall be complete with terminal block, cable glands, cable lugs and other accessories as specified.
- 6.0 SPECIAL FEATURES FOR FLAME PROOF LIGHTING SUB DISTRIBUTION BOARDS**
- 6.1 The enclosure shall be in addition of flame proof execution as per IS: 2148.
- 6.2 The enclosure group and temperature class shall be as indicated in Design Philosophy – Electrical.
- 6.3 The enclosure shall be of cast iron/cast Aluminium alloy (4600 as per IS: 617).
- 6.4 Cables shall enter the terminal chamber through flame proof compression type cable glands. From terminal chamber to the main enclosure connection shall be made through bushings. Direct entry of external cables into the main enclosure shall not be accepted.
- 6.5 The sub-distribution board shall be of 6 way type.
- 6.6 Individual earth terminals shall be provided for the earth conductor of the outgoing cables beside the phase and neutral terminals.
- 6.7 The sub-distribution board must be certified by Central Mining Research Institute, Dhanbad or other statutory authority for use in specified hazardous area.
- 7.0 COMPONENT DETAILS**
- 7.1 The lighting sub-distribution board shall be wired and have components as per SD-8083 (copy attached).
- 7.2 **Miniature Circuit Breaker (MCB)**
- The MCB shall be of duty category M-9 and shall conform to IS/IEC:60898-1:2002. It shall be provided with overload and short circuit protective devices. MCB shall be of C Curve Type.
- 7.2.1 The incoming MCB's or switches shall be of triple pole and switched neutral type and outgoing MCB's of single pole and switched neutral type, single phase earth leakage protection in each phase of the incomer shall be provided.
- 7.3 **Terminal Block**
- Pressure clamp type terminal blocks shall be provided both for incoming and outgoing cables. The rating of the terminal block shall be at least 1.5 times the rating of the MCB.
- 7.4 **Cable Glands**
- Heavy duty double compression type Aluminium cable glands suitable for PVC insulated, armoured and PVC sheathed 1.1 KV grade incoming and outgoing cables shall be provided.

	TALCHER FERTILIZERS LIMITED TECHNICAL SPECIFICATION - LIGHTING SUB DISTRIBUTION BOARDS	PC183-TS-0809	0	
		Document No.	Rev	
		Sheet 5 of 6		

8.0 PAINTING

- 8.1 The enclosure after suitable pre-treatment shall be painted with two coats of anti rust paint followed by two coats or anticorrosive paint.
- 8.2 Epoxy based paint shall be used.
- 8.3 All paints shall be carefully selected to withstand tropical heat and extremes of weather. The paint shall not scale off, crinkle or be removed by abrasion due to normal handling.
- 8.4 The finishing shade shall be light grey shade no.631 as per IS: 5.

9.0 TESTS AND INSPECTION

- 9.1 All the lighting sub-distribution boards shall be subjected to routine tests as per IS: 8623.
- 9.2 Additional tests, wherever specified, shall be carried out on one lighting sub-distribution board of each type.
- 9.3 The above mentioned tests shall be carried out in the manufacturer's works in the presence of purchaser's representative. In addition, the equipment shall be subjected to stage inspection at works and inspection at site for final acceptance.
- 9.4 The purchaser's inspection shall, however, not absolve the vendor from his responsibility for making good any defects which may be noticed subsequently.

10.0 DRAWINGS AND DOCUMENTS



- 10.1 Drawings and documents as per Annexure-I shall be supplied, unless otherwise specified.
- 10.2 All drawings and documents shall have the following description written boldly.
- Name of client
 - Name of consultant
 - Enquiry / Order Number with plant / project name
 - Code No. and Description

11.0 SPARES

- 11.1 Commissioning Spares: Commissioning spares, as required, shall be supplied with the main equipment. Item-wise list of recommended commissioning spares shall be furnished for information.
- 11.2 Spare for 2 Years Operation (Mandatory), as specified shall be supplied.
- 11.3 List of Recommend Spares (other than Mandatory Spares) alongwith recommended quantity and item-wise price shall be furnished.
- 11.4 All spare parts shall be identical to the parts used in the equipment.

12.0 PACKING

- 12.1 The equipment shall be properly packed to safeguard against weather conditions and handling during transit. It shall be wrapped in polythene bags and an additional wrapping of bitumen paper shall also be provided to make it completely water proof before the equipment is packed in wooden crates.
- 12.2 The packing box shall contain a copy of the installation, operation and maintenance manual.

 पी डी आई एल PDIL	TALCHER FERTILIZERS LIMITED TECHNICAL SPECIFICATION - LIGHTING SUB DISTRIBUTION BOARDS	PC183-TS-0809	0	
		Document No.	Rev	
		Sheet 6 of 6		

ANNEXURE - I

DOCUMENTATION FOR LIGHTING SUB DISTRIBUTION BOARDS

SL.NO.	Description	Documents Required (Y / N)		
		With Bid	For Approval	Final
1.	Specification Sheet	N	Y	Y
2.	Technical particulars	N	Y	Y
3.	General arrangement Drgs.	N	Y	Y
4.	Certificate for flameproofness from statutory testing authority wherever applicable	N	N	Y
5.	Schematic diagram	N	Y	Y
6.	Descriptive literature of Various equipment	N	N	Y
7.	Guarantee certificate	N	N	Y
8.	Test certificate	N	N	Y

Note:

1. 4 hard copies & 1 soft copy shall be supplied for approval after order within 4 weeks from the date of LOI.
2. 8 hard copies & 2 soft copies in CD shall be submitted as final documents prior to despatch of the equipment. These shall be made in sets and supplied in fine plastic coated folder.

Y - Yes, N - No

	TALCHER FERTILIZERS LIMITED TECHNICAL SPECIFICATION - INDUCTION MOTOR	PC183-TS-0810	0	
		Document No.	Rev	
		Sheet 1 of 12		

TECHNICAL SPECIFICATION INDUCTION MOTOR

	TALCHER FERTILIZERS LIMITED TECHNICAL SPECIFICATION - INDUCTION MOTOR	PC183-TS-0810	0	
		Document No.	Rev	
		Sheet 2 of 12		

CONTENTS

SECTION NUMBER	DESCRIPTION
1.0	SCOPE
2.0	STANDARDS TO BE FOLLOWED
3.0	SERVICE CONDITIONS
4.0	GENERAL DESIGN FEATURES
5.0	PERFORMANCE
6.0	COUPLING DETAILS
7.0	ACCESSORIES
8.0	VIBRATIONS
9.0	NOISE LEVEL
10.0	PAINTING
11.0	TESTS AND INSPECTION
12.0	PACKING
13.0	DRAWINGS AND DOCUMENTS
14.0	SPARES
ANNEXURE - I	DOCUMENTATION FOR INDUCTION MOTORS

	TALCHER FERTILIZERS LIMITED TECHNICAL SPECIFICATION - INDUCTION MOTOR	PC183-TS-0810	0	
		Document No.	Rev	
		Sheet 3 of 12		

1.0 SCOPE

- 1.1 This standard covers the technical requirements of design, manufacture, testing at works and delivery in well-packed condition of medium voltage and high voltage induction motors.
- 1.2 This standard shall be read in conjunction with relevant part of Design Philosophy - Electrical.

2.0 STANDARDS TO BE FOLLOWED

- 2.1 The design, manufacture and testing of the equipment covered by this standard shall comply with the latest issue of IS-325 and other relevant Indian Standards, unless otherwise specified. Equipment complying with equivalent IEC standards shall also be acceptable.
- 2.2 The design and operational features of the equipment offered shall also comply with the provisions of latest issue of the Indian Electricity Rules and other relevant Statutory Rules & Regulations. The supplier shall, whenever necessary, make suitable modification in the equipment to comply with the above mentioned rules.
- 2.3 Flame proof motors shall, in addition, comply with the requirements laid down in IS: 2148.
- 2.4 Increased safety motors shall, in addition, comply with the requirements laid down in IS: 6381.
- 2.5 Motors with type of protection “n” shall, in addition, comply with the requirements laid down in IS: 9628.
- 2.6 Wherever any requirement laid down in this standard differs from that in Indian Standard Specifications, the requirement specified herein shall prevail.

3.0 SERVICE CONDITIONS

3.1 Ambient Conditions

The ambient conditions shall be as indicated in the Design Philosophy - Electrical.



3.2 System Details

- 3.2.1 The details of power system to which the motors will be connected shall be as indicated in the Design Philosophy - Electrical.
- 3.2.2 The motors shall be suitable for connection to a power system where transient disturbances are very likely to occur. During the transient disturbances, voltage of the system may completely disappear and return in a short time with the motors still running and connected. Under this condition, the return of voltage may occur at such an instant that the induced e.m.f. in the motor is in phase with the applied voltage giving rise to current surges which may reach a value equal to 1.6 times the starting current and also cause transient torques of large magnitudes.

4.0 GENERAL DESIGN FEATURES

4.1 Enclosure

- 4.1.1 The enclosure of motors for indoor and outdoor services shall be IP-54 and IPW-55 respectively as per IS/IEC:60529, unless otherwise specified.
- 4.1.2 Motors for outdoor service shall be provided with special seals for the enclosure, joints, bearing housing, terminal boxes etc. so that no extra protective covering for ingress of water shall be required.

	TALCHER FERTILIZERS LIMITED TECHNICAL SPECIFICATION - INDUCTION MOTOR	PC183-TS-0810	0	
		Document No.	Rev	
		Sheet 4 of 12		

- 4.1.3 Vertical motors for outdoor installation shall be provided with a rain protective hood.
- 4.1.4 All external hardware shall be zinc passivated or cadmium plated.
- 4.1.5 The enclosure shall be provided with threaded metallic plug to permit drainage of condensed water from the inside.

4.2 **Cooling**

- 4.2.1 All motors shall be totally enclosed fan cooled conforming to IC-0141 as per IS: 6362 unless otherwise specified.
- 4.2.2 In case of CACA construction, the same shall conform to IC-0161 as per IS: 6362.
- 4.2.3 In case of CACW construction, the same shall conform to ICW 37A 91 as per IS: 6362.
- 4.2.4 Wherever service conditions are such that corrosive agents are present in the surroundings, the following materials of construction for cooling tubes shall be adopted, unless otherwise specified.

For CACA motor - Aluminium tubes having minimum thickness of 1.6 mm

For CACW motor - Low carbon alloy steel

- 4.2.5 In case of CACW motors, the cooling tubes and flanges shall also be suitable for the cooling water analysis. Trays shall be provided for collection of leaking water with arrangement for its drainage.
- 4.2.6 The cooling fans shall be suitable for bidirectional rotation of motors. These shall be fastened to the motor shaft by means of compensating rings or will be balanced independent of the motor. Guide key or reference points shall be supplied to prevent wrong assembly. The cooling air shall be sucked from the non-driving end.
- 4.2.7 The cooling fans shall be made of non-sparking materials such as cast Aluminium (LM-6 alloy) / cast iron.

4.3 **Direction of Rotation**

- 4.3.1 Motors shall be suitable for both directions of rotation. In case of any design limitation, the same shall be indicated in the offer.
- 4.3.2 In either case, a plate showing the direction of rotation corresponding to the phase terminal markings shall be fitted at the driving end shield of the motors.

4.4 **Stator**

- 4.4.1 The stator laminations shall be made from suitable magnetic sheet iron varnished on both sides. Where ventilation is required, these shall be arranged in suitable packs, each pack being separated by spacers to form ventilating ducts for circulation of air.
- 4.4.2 The slot shall be open type with coils so arranged that the coils can be easily removed for inspection and repair.

4.5 **Rotor**

- 4.5.1 The rotor shall be of squirrel cage construction, unless otherwise specified.
- 4.5.2 For small motors, the squirrel cage shall preferably be of pressure die-cast construction. For large motors, the rotor bars and the end rings shall be of copper or copper alloy. The bars shall be firmly placed in slots to prevent vibration during start up / locked rotor condition. Conductor ends shall be securely fixed to the end rings using the latest brazing techniques. Retaining rings shall be provided for high speed machines for the end rings. The rotor cage shall be designed for the required starting and duty cycles.

	TALCHER FERTILIZERS LIMITED TECHNICAL SPECIFICATION - INDUCTION MOTOR	PC183-TS-0810	0	
		Document No.	Rev	
		Sheet 5 of 12		

- 4.5.3 Wherever wound rotor is specified, the windings shall have the same features as detailed for the stator windings. The rotor voltage shall not exceed the stator voltage.
- 4.5.4 The rotor shall be dynamically balanced and shall rotate perfectly with no preferential stop points. The rotor shall be constructed such as to allow the removal or addition of material for balancing.
- 4.5.5 The rotor shaft shall be electrically and magnetically so balanced that the induced shaft voltage does not exceed 200 millivolt. Otherwise the bearing housing at non-driving end shall be insulated for 2 KV.
- 4.6 **Windings and Insulation**
- 4.6.1 The motor coils shall be made out of insulated electrolytic grade copper conductor. Successive coils shall be connected by accessible joints, well brazed and finished smooth to prevent damage to insulation.
- 4.6.2 The motors shall be insulated assuming the power system neutral as isolated.
- 4.6.3 All motors shall be insulated with F insulation with tropical and fungicidal treatments.
- 4.6.4 Wherever class F insulation is specified, the windings shall be easily replaceable type and the temperature rise shall not exceed that of class B insulation.
- 4.6.5 The winding coils shall be dried, properly impregnated with suitable varnishes to withstand the site conditions and properly baked. At least two additional impregnations and baking shall be applied to the assembled stator coil, making a total of three impregnations and baking. Finally the windings shall be painted with special anti-acid and anti-alkali paints to withstand the site conditions.
- 4.6.6 The windings shall be well brazed and capable of withstanding thermally and mechanically the transient disturbances specified under clause 3.2.2.
- 4.6.7 Lead-in wire between the windings and the outside terminals shall be made through bushings in H.V. motors. For M.V. motors, heat resistant insulated conductors shall be used as lead-in wire.
- 4.6.8 The windings shall be star connected for high voltage motors and delta connected for medium voltage motors.
- 4.7 **Slip Rings and Brushes**
- 4.7.1 Slip rings shall be located in the non-driving side. The material of construction shall be copper alloy. The slip rings and the brush gear shall be cooled by the motor cooling fan.
- 4.7.2 For explosion proof motors, the slip rings and brush gear shall be housed in a flameproof housing. In case this is not possible, the housing shall be pressurised type with flameproof pressure switch for interlocking with the motor. In either case, glass covers shall be provided for inspection.
- 4.7.3 The starting rheostats shall be designed for intermittent duty and rated for 10 minutes. Where speed regulation is required, the rheostats and the controllers shall be suitable for such duty and be continuously rated. Auxiliary contacts shall be provided on the controllers for connections to the motor supply controls to prevent wrong operations during starting.
- 4.8 **Bearings**
- 4.8.1 All motors shall be provided with bearings suitable for the application. The bearings shall have a smooth operation and a life not shorter than 30,000 hrs.

	TALCHER FERTILIZERS LIMITED TECHNICAL SPECIFICATION - INDUCTION MOTOR	PC183-TS-0810	0	
		Document No.	Rev	
		Sheet 6 of 12		

- 4.8.2 Where external thrusts are specified, the motors shall be fitted with special roller thrust bearings capable of withstanding the specified thrust. In such cases, the life of the bearings shall not be less than 20,000 hours.
- 4.8.3 The bearing housing shall be effectively sealed against ingress of dust and water and creep age of lubricants along the shaft.
- 4.8.4 The bearing shall be suitable for both directions of rotation of the motor.
- 4.8.5 All motors shall be provided with on-line grease lubrication arrangement for both DE and NDE side bearings except for motors of frame size 112 and less and flange mounted M.V. motors. The arrangement shall be complete with grease nipple and drain plug located at convenient locations.
- 4.8.6 All oil lubricated bearings shall be fitted with oil level indicator and resistance temperature detector/dial type thermometer with alarm and trip contacts.
- 4.8.7 Self cooled bearing system shall be preferred.
- 4.8.8 The manufacturer shall specify the type of lubricant and the time interval of lubrication for the bearings of each motor.
- 4.8.9 The bearing temperature shall not exceed 90°C for grease lubricated bearings and 70°C for oil lubricated bearings.
- 4.8.10 Wherever shaft end-play has been specified, the bearings shall be capable of providing the specified end-play.
- 4.9 **Terminal Box**
- 4.9.1 All the terminal boxes shall have identical degree of protection as that of the motor.
- 4.9.2 The power terminal box shall be mounted on the right hand side of the motor as viewed from the coupling end. For M.V. Motors, design of terminal boxes shall be such that it may be possible to arrange top/bottom/side entry of cables at site.
- 4.9.3 The power terminal boxes shall be as follows:
- a) For H.V. motors - Phase segregated type capable of with standing the system fault level for 0.2 Sec. or more.
 - b) For M.V. motors - Manufacturer's standard box with epoxy or SRBF moulded terminal board.
- 4.9.4 The mounting arrangement of power and neutral side terminal boxes for HV motors shall be identical so that it shall be possible to interchange the boxes at site.
- 4.9.5 In case of H.V. motors, all the six leads of the motors shall be taken out, three on one side and three on the other side to separate terminal boxes. However, neutral shorting link shall be provided on the neutral box for star connection.
- 4.9.6 In case of M.V. motors, all the six leads of the motors shall be taken out to a common terminal box. Shorting links for delta connections shall be provided in the terminal box for motors 112 frame and above.
- 4.9.7 For increased safety motors and for motors with type of protection "n", the terminals shall be provided with positive locking device so that they do not become loose during normal operation.
- 4.9.8 The power terminal boxes shall have adequate clearances in between the terminals and also between the terminals and cable gland for proper termination of cables. Where more than one cable is required to be terminated in parallel, the spacing in the box shall be adequate for easy termination.

	TALCHER FERTILIZERS LIMITED TECHNICAL SPECIFICATION - INDUCTION MOTOR	PC183-TS-0810	0	
		Document No.	Rev	
		Sheet 7 of 12		

- 4.9.9 Separate terminal boxes shall be provided for connection of power, control and space heater cables.
- 4.9.10 All terminal boxes shall be complete with heavy duty double compression type cable glands and lugs/connectors to receive the external cables.
- 4.9.11 Where cross linked polyethylene cables are specified, the terminal box shall be suitably designed for proper termination of such cables.
- 4.9.12 The cable lugs shall be of tinned copper and suitable for crimping.

4.10 **Geared Motors**

Where geared motors are specified, the gears shall be oil lubricated, heavy duty as per AGMA class III and capable of transmitting the rated motor power continuously. They shall be capable of withstanding moderate shock loads having a service factor of 2 and the starting duties. They shall be silent and smooth in operation. Inspection glass shall be provided to indicate the oil level in the gear box.

5.0 **PERFORMANCE**

5.1 **Starting**

- 5.1.1 The motors shall be capable of being started direct-on-line, unless otherwise specified.
- 5.1.2 The starting torque of each motor shall be higher than the initial resisting torque of the driven load throughout the starting period even at a feeding voltage of 85% of the rated voltage for normal purpose motor and 80% of the rated voltage for special purpose motor.
- 5.1.3 The starting current of 415 V Motors shall not exceed the values indicated in IS: 12615. Also there shall be no further positive tolerance on the values of starting current.
The starting current of 11 KV & 3.3 KV motors shall not exceed 550% of FLC. No positive tolerance is acceptable over 550% FLC.
- 5.1.4 The motors shall be suitable for the following starting cycle:
- a) With the motor at ambient temperature - 2 successive starts and 3rd start after 5 minutes.
 - b) With the motor at steady state load temperature - 1 immediate start and 2nd start after 5 minutes. This sequence shall be repeated in the next hour.
- 5.1.5 Speed switch shall be provided, wherever required, to fulfil the starting conditions.

5.2 **Locked Rotor Condition**

- 5.2.1 The locked rotor withstand time (t_E), under hot condition at 110% of rated voltage shall be more than the starting time of the motor coupled to the load even at the lowest stipulated starting voltage by 2 secs. for motors, having starting time up to 10 secs. and by 5 secs. for motors, having starting time more than 10 secs.
- 5.2.2 For increased safety motors, t_E under hot condition shall not be less than 10 secs. The value of t_E shall be determined in the presence of purchaser's representative unless test certificate from an independent testing authority is submitted for similar motors. The time t_E and the locked rotor current shall be stamped on the name plate as well as indicated in the test certificates.
- 5.2.3 For deciding the time t_E in all cases, the temperature of the insulated stator and rotor shall not exceed the value stipulated under clause no. 5.4.3.

5.3 **Running**

	TALCHER FERTILIZERS LIMITED TECHNICAL SPECIFICATION - INDUCTION MOTOR	PC183-TS-0810	0	
		Document No.	Rev	
		Sheet 8 of 12		

- 5.3.1 All motors shall be continuous maximum rated (S1 duty as per IS: 325), unless otherwise specified.
- 5.3.2 The motors shall be capable of delivering the rated output without exceeding the specified temperature rise under the system voltage and frequency variation conditions.
- 5.3.3 The motors shall be suitable for running at the rated load for 5 minutes duration at 80% voltage and for 1 Sec. duration at 70% voltage, without exceeding the specified temperature rise.

5.4 **Temperature Rise**

- 5.4.1 The total temperature of the stator winding under full load running condition shall not exceed the values permissible for the specified insulation class. For increased safety motors, the total temperature shall be 10°C less than for normal motors.
- 5.4.2 For explosion proof motors, the maximum surface temperature shall not exceed the values applicable for temperature class of the hazardous gases / vapours present in the surrounding area. However for type 'n' motors, the maximum allowable temperature shall not exceed 200°C.
- 5.4.3 In case of starting and locked rotor conditions stipulated under clause nos. 5.1.4 and 5.2.1 respectively, the maximum temperature in the rotor shall not exceed the following values:
- | | | |
|---------------------------|---|--|
| For squirrel cage rotor | - | 300°C |
| For wound rotor | - | As applicable to the insulation class |
| For explosion proof motor | - | As per temperature class of the hazardous gases / vapours, without exceeding the above temperature as applicable |

6.0 **COUPLING DETAILS**

- 6.1 Unless otherwise specified, all motors shall be coupled to the driven equipment through flexible coupling.
- 6.2 Normally the coupling half for the motor shaft shall be supplied by the driven equipment supplier. The coupling half shall be keyed on the shaft with a tapered joint or shrunk with a straight joint. For this purpose, the motor manufacturer shall coordinate all details of the coupling system with the driven equipment manufacturer, wherever required.
- 6.3 Where rigid coupling is specified, the motor shaft shall have the desired class of accuracy.
- 6.4 For all vertical flange mounted motors, the limitations on shaft extension, run out, perpendicularity and eccentricity, as required by the driven machine supplier shall be complied with by the motor supplier.
- 6.5
- i) If the motor is to be coupled to a reciprocating pump or compressor requiring fluctuating torque, the motor supplier shall ensure that the inertia of the driving and driven machine assembly shall be such that the variation in the armature current shall not exceed $\pm 66\%$ of the rated current while delivering full load.
 - ii) The measurement of armature current shall be done with the oscillograph.
 - iii) The additional fly wheel, if any, shall be assembled at such a distance from the motor so as to allow easy inspection of the windings.
 - iv) All necessary coordination with driven equipment manufacturer shall be carried out by the motor manufacturer.

	TALCHER FERTILIZERS LIMITED TECHNICAL SPECIFICATION - INDUCTION MOTOR	PC183-TS-0810	0	
		Document No.	Rev	
		Sheet 9 of 12		

- 6.6
- i) Wherever belt drive is specified, the motor supplier shall ensure that the shaft extension and the bearings are suitable for the duty specified.
 - ii) Unless otherwise specified, the slide rails for all belt driven motors shall be supplied by the motor manufacturer.

7.0 ACCESSORIES

The motors shall be complete with all the accessories.

7.1 Space Heaters

7.1.1 Space heaters rated for 240 V A.C. shall be provided to keep the winding dry for all high and medium voltage motors, except for motors rated below 30 KW which shall be suitable for space heating by connecting 24 V A.C to any of the two motor winding terminals.

7.1.2 The location of the space heaters shall be such as to allow easy access for inspection, maintenance and replacement.

7.2 Name Plates

7.2.1 The name plates shall be of stainless steel with letters embossed on them.

7.2.2 The name plate shall contain all the relevant details as per IS: 325 and in addition shall indicate the following:

- i) The description and code no. of motor
- ii) Degree of protection of enclosure
- iii) Temperature rise of windings under running condition
- iv) Designation of bearings
- v) Recommended type of lubricant and interval of lubrication
- vi) Direction of rotation
- vii) Mounting Arrangement

7.2.3 Flameproof motors shall have additional name plate containing relevant particulars as per IS: 2148.

7.2.4 Increased safety motors shall have additional name plate containing relevant particulars as per IS: 6381.

7.2.5 Motors with type of protection “n” shall have additional name plate containing relevant particulars as per IS: 9628.

7.3 Embedded Temperature Detectors

7.3.1 All high voltage motors shall be provided with 6 nos. of evenly distributed embedded resistance temperature detectors for measurement of winding temperature. These shall be located in positions at which the highest temperatures are likely to occur.

7.3.2 In addition, the high voltage motors shall be provided with

- i) 1 no. RTD for hot air temperature measurement
- ii) 2 nos. RTDs (1 on each side) for bearing temperature measurement of oil lubricated bearings. For grease lubricated bearings, RTD shall be provided only where specified

	TALCHER FERTILIZERS LIMITED TECHNICAL SPECIFICATION - INDUCTION MOTOR	PC183-TS-0810	0	
		Document No.	Rev	
		Sheet 10 of 12		

7.3.3 These RTDs shall be of platinum having 100 ohm resistance at 0°C and temperature coefficient as 3.850×10^{-3} .

7.3.4 The RTDs shall be 3 lead type having power frequency insulation level of 2KV.

7.3.5 The RTDs shall comply with the requirements laid down in IS: 2848.

7.4 **Dial Type Thermometers**

7.4.1 In high voltage motors, the measurement of hot air and bearing temperature (of oil lubricated bearings) by dial type thermometers shall be provided wherever specified.

7.4.2 The arrangement shall consist of a dial type of mercury-in-steel thermometer so mounted that its stem shall be located in the maximum temperature region.

7.4.3 The thermometer shall have two potential free contacts for alarm and trip.

7.4.4 All contacts shall be rated for 2 Amps. at 110 V D.C.

7.4.5 For bearing temperature measurement, separate thermometers shall be provided for each bearing.

7.4.6 For grease lubricated bearings, temperature measurement arrangement shall be provided only where specified.

7.5 **Oil Supply System**

7.5.1 For large sized motors, where forced oil lubrication system is considered, a common oil supply system for the motor and the driven equipment shall be provided by the driven equipment manufacturer.

7.5.2 However, the motor supplier shall quote separate price for the complete oil system of the motor.

7.5.3 The system shall be suitable for location near the motor.

7.5.4 The oil supply system for each motor shall include:

- i) 2 Nos. 100% rated motor driven pumps with motors
- ii) 1 No. oil tank complete with oil level gauge and thermometer
- iii) 1 No. oil cooler
- iv) 1 No. oil filter
- v) 1 No. differential pressure switch for filter
- vi) 2 Nos. pressure switches
- vii) Necessary piping
- viii) Necessary control and interlocks

8.0 **VIBRATIONS**



The motor vibrations measured at the bearings must not exceed the limits specified in IS: 12075.

9.0 **NOISE LEVEL**

The motor noise level shall not exceed 85 dB measured at a distance of 1 metre from the motor.

10.0 **PAINTING**

10.1 Enclosures of the motor and its accessories shall be painted with two coats of anti-rust paint and two coats of anti-corrosive paint after suitable pre-treatment.

	TALCHER FERTILIZERS LIMITED TECHNICAL SPECIFICATION - INDUCTION MOTOR	PC183-TS-0810	0	
		Document No.	Rev	
		Sheet 11 of 12		

- 10.2 Epoxy paint shall be used.
- 10.3 Unless otherwise specified, the finishing shade shall be light grey having shade No. 631 as per IS: 5.

11.0 TESTS AND INSPECTION

- 11.1 All motors shall be routine tested as per relevant standards.
- 11.2 Additional tests, wherever specified, shall be carried out on one motor of each rating.
- 11.3 For high voltage motors of each rating, polarization index test shall also be carried out.
- 11.4 All the above mentioned tests shall be carried out in the presence of purchaser's representative. In addition, the motor shall be subject to stage inspection at works and inspection at site for final acceptance.
- 11.5 These inspections shall, however, not absolve the vendor from their responsibility for making good any defects which may be noticed subsequently.

12.0 PACKING



- 12.1 The motors shall be properly packed to safeguard against weather conditions and handling during transit.
- 12.2 The shaft shall be properly clamped / supported.
- 12.3 Rust inhibiting agents shall be applied to fittings and sliding surfaces.
- 12.4 All flanges shall be closed with blanking plates to avoid entry of foreign materials.
- 12.5 The loose pieces of the motor / spare parts / Instruments shall be separately wrapped in moisture resistant paper and marked with identification marks and name plate of the corresponding motors.
- 12.6 The packing box / crate shall include a copy of installation, operation and maintenance manual.

13.0 DRAWINGS AND DOCUMENTS

- 13.1 Drawings and documents as per Annexure-I shall be supplied, unless otherwise specified.
- 13.2 All drawings and documents shall have the following descriptions written boldly:
- Name of client
 - Name of consultant
 - Enquiry / order number with plant / project name
 - Motor Code No. and Description

14.0 SPARES

- 14.1 Commissioning Spares : Commissioning spares, as required, shall be supplied with the main equipment. Item-wise list of recommended commissioning spares shall be furnished for information.
- 14.2 Spares for 2 Years Operation (Mandatory), as specified shall be supplied.
- 14.3 List of Recommend Spares (other than Mandatory Spares) alongwith recommended quantity and item-wise price shall be furnished.
- 14.4 All spare parts shall be identical to the parts used in the equipment.

	TALCHER FERTILIZERS LIMITED TECHNICAL SPECIFICATION - INDUCTION MOTOR	PC183-TS-0810	0	
		Document No.	Rev	
		Sheet 12 of 12		

ANNEXURE - I
DOCUMENTATION FOR INDUCTION MOTORS

Sl. No.	Document Description	Documents Required (Y / N)		
		With Bid	For Approval	Final
1.	Specification Sheet and Technical Particulars	N	Y	Y
2.	Dimensional Drawings	N	Y	Y
3.	Drawings and data for air / water heat exchangers, if necessary	N	Y	Y
4.	Drawings and data for oil system, if necessary	N	Y	Y
5.	Characteristic curves			
	a) Thermal withstand curve	N	Y	Y
	b) Load Vs FL current	N	Y	Y
	c) Load Vs Efficiency	N	Y	Y
	d) Load Vs Power factor	N	Y	Y
	e) Load Vs Speed	N	Y	Y
	f) Voltage Vs Thermal Withstand time	N	Y	Y
	g) Starting current Vs Time	N	Y	Y
6.	Connection diagram for RTDs, thermometer etc.	N	Y	Y
7.	Terminal Box drawings	N	Y	Y
8.	Illustrative and Descriptive catalogues	N	N	Y
9.	Catalogues of bought out accessories	N	N	Y
10.	Spare parts list	N	N	Y
11.	Installation, Operation and Maintenance manual	N	N	Y
12.	Test certificates			
	a) Routine	N	N	Y
	b) Type	N	N	Y
	c) For enclosure	N	N	Y
13.	Guarantee Certificates	N	N	Y

Note:

1. 4 hard copies & 1 soft copy shall be supplied for approval after order within 4 weeks from the date of LOI.
2. 8 hard copies & 2 soft copies in CD shall be submitted as final documents prior to despatch of the equipment. These shall be made in sets and supplied in fine plastic coated folder.

Y - Yes, N - No



TALCHER FERTILIZERS LIMITED
TECHNICAL SPECIFICATION - INTERLOCKING SWITCH
SOCKET AND PLUG

PC183-TS-0811

0

Document No.

Rev

Sheet 1 of 7



TECHNICAL SPECIFICATION
INTERLOCKING SWITCH SOCKET AND PLUG



CONTENTS

SECTION NUMBER	DESCRIPTION
1.0	SCOPE
2.0	STANDARDS TO BE FOLLOWED
3.0	SERVICE CONDITIONS
4.0	OPERATING REQUIREMENTS
5.0	GENERAL DESIGN AND CONSTRUCTIONAL FEATURES
6.0	SPECIAL FEATURES FOR FLAME PROOF SWITCH SOCKET AND PLUGS
7.0	COMPONENT DETAILS
8.0	PAINTING
9.0	TESTS AND INSPECTION
10.0	DRAWINGS AND DOCUMENTS
11.0	PACKING
12.0	SPARES
ANNEXURE - I	DOCUMENTATION FOR INTERLOCKING SWITCH SOCKET AND PLUG



TALCHER FERTILIZERS LIMITED
TECHNICAL SPECIFICATION - INTERLOCKING SWITCH
SOCKET AND PLUG

PC183-TS-0811

0

Document No.

Rev

Sheet 3 of 7



1.0 SCOPE

- 1.1 The standard covers the technical requirements of design, manufacture, testing at works and delivery in well packed condition of interlocking switch socket and plug.
- 1.2 The standard shall be read in conjunction with relevant part of Design Philosophy - Electrical.

2.0 STANDARDS TO BE FOLLOWED

- 2.1 The design, manufacture and testing of the equipment covered by this standard shall comply with the latest issue of IS-4160/ IEC-309 and other relevant Indian Standards, unless otherwise specified. Equipment complying with equivalent IEC standards shall also be acceptable.
- 2.2 The design and operational features of the equipment offered shall also comply with the provisions of latest issue of Indian Electricity Rules and other statutory acts and regulations. The supplier shall, wherever necessary, make suitable modifications in the equipment to comply with the above.
- 2.3 Wherever any requirement, laid down in this standard differs from that in Indian Standard Specifications, the requirement specified herein shall prevail.

3.0 SERVICE CONDITIONS

3.1 Ambient conditions

These shall be as indicated in Design Philosophy - Electrical.

3.2 System details

These shall be as indicated in Design Philosophy - Electrical.

4.0 OPERATING REQUIREMENTS

The equipment shall be suitable for operating at the rated capacity continuously without exceeding the specified temperature rise and without any detrimental effect on any part.

5.0 GENERAL DESIGN AND CONSTRUCTIONAL FEATURES

- 5.1 The switch socket shall be heavy duty industrial type. The interlocking arrangement shall be such that it is not possible to insert or withdraw the plug with the switch in 'ON' position.
- 5.2 The switch sockets shall have dust, hose and weather proof construction conforming to IPW55 as per IS/IEC:60947 and shall be suitable for outdoor use without any extra protection. All jointing surfaces shall be smoothly machined and of sufficient width to prevent ingress or dust. Further the covers shall be provided with continuous gaskets made of neoprene to prevent ingress of dust and moisture.
- 5.3 The enclosure of switch sockets and plugs shall be of cast aluminium alloy 4600 and suitable for fixing on wall / structure.
- 5.4 The enclosure shall be largely dimensioned in order to avoid temperature rise inside it which may damage the insulating materials and gaskets employed therein.
- 5.5 The insulating materials used shall be non-hygroscopic, mould proof and treated with suitable varnish to withstand the ambient conditions.
- 5.6 All external hardware of diameter less than 8 mm shall be of stainless steel and those of diameter 8 mm or above shall be of mild steel cadmium plated or zinc passivated.
- 5.7 Suitable arrangement for looping of cables from one switch socket to the other shall be provided. For switch sockets rated above 63A, looping shall be done from busbars and



TALCHER FERTILIZERS LIMITED
TECHNICAL SPECIFICATION - INTERLOCKING SWITCH
SOCKET AND PLUG

PC183-TS-0811

0

Document No.

Rev

Sheet 4 of 7



for switch sockets rated 63A and below, looping may be done from terminal block. Necessary terminals, cable glands and lugs for looping shall be provided. Also one no. The readed plug for each switch socket shall be supplied loose.

5.8 All the relevant information shall be provided on engraved name plate made of aluminium.

5.9 The enclosure shall be provided with two earthing terminals outside the body.

6.0 SPECIAL FEATURES FOR FLAME PROOF SWITCH SOCKET AND PLUGS

6.1 The enclosure shall be in addition of flame proof execution as per IS: 2148.

6.2 The enclosure group and temperature class shall be as indicated in Design Philosophy - Electrical.

6.3 Cable shall enter the terminal chamber through flame proof compression type cable glands. From the terminal to the main enclosure, the connection shall be made through proper bushings. Direct entry of external cables into the main enclosure shall not be accepted.

6.4 An additional earthing terminal inside the terminal chamber shall be provided.

6.5 Switch socket, plug and cable glands must be certified by the Central Mining Research Institute, Dhanbad or any other statutory authority for use in the specified hazardous area.

6.6 Further interlocking shall be provided so that the contacts cannot be energised when the plug and socket are separated.

7.0 COMPONENT DETAILS

Makes of all components shall be subject to owner's / consultant's approval

7.1 Air Break Switches

7.1.1 The switches shall be quick make, quick break rotary type and of utilisation category AC-23 as per IS/IEC:60947.

7.1.2 Switches shall be hand operated from outside the cover. The switch handle shall remain fixed to the front cover while removing the front cover.

7.2 H.R.C. Fuses

7.2.1 The sockets shall be provided with link type HRC fuses.

7.2.2 The fuses shall be capable of withstanding a short circuit current of 50 KA and shall be delayed action type conforming to IS: 13703. These shall be mounted on a shrouded base.

7.3 Socket Outlets

7.3.1 The socket outlet shall be located in the lower part of the enclosure and shall be provided with a threaded aluminium cover attached to the body with G.I. chain, to protect the socket after extraction of the plug. Spring loaded automatic shutter shall not be acceptable.

7.3.2 The socket contacts shall maintain satisfactory spring pressure and contact with the corresponding plug under normal service conditions.

7.3.3 The socket contacts shall be sunk well below the surface of the socket- outlets so as to make it impossible to be touched unintentionally.

7.3.4 An earthing contact shall be provided in the socket outlet which shall ensure making and breaking respectively of its contact with the earthing pin of the plug before and after making and breaking of the corresponding current carrying contacts.



TALCHER FERTILIZERS LIMITED
TECHNICAL SPECIFICATION - INTERLOCKING SWITCH
SOCKET AND PLUG

PC183-TS-0811

0

Document No.

Rev

Sheet 5 of 7



7.4 **Plugs**

- 7.4.1 The plugs shall be so constructed so that these can be easily fitted in to the socket outlets.
- 7.4.2 These shall be provided with knurled knob arrangement for screwing on the body of the socket so that it can be securely fixed on the top.
- 7.4.3 The plug base and cover shall be firmly secured to each other and shall be sufficiently robust in construction to withstand normal usage.
- 7.4.4 The plug pins shall preferably be of single part. The earthing pin shall be slotted with a single slot and shall be larger in dimension than other pins.
- 7.4.5 The plug and socket contacts shall be self aligning type with best electrical continuity.
- 7.4.6 The plug shall be provided with dust proof cable entry suitable for receiving TRS flexible heavy duty copper conductor cable of specified size. The arrangement shall be such that the conductors are relieved from strain including twisting where they are connected to the terminals and that the outer surface of the cable at the place of entry is not damaged.
- 7.4.7 Insulating barriers forming an integral part of the plug shall ensure separation of metals and bare flexible conductors at different potentials.

7.5 **Cable Termination**

- 7.5.1 Switch socket shall have cable termination arrangement on the upper part of the housing and shall be provided with side entries, one on either side, through heavy duty double compression type rolled aluminium cable glands suitable for 1.1 KV grade PVC insulated armoured and PVC sheathed cables of size.
- 7.5.2 The terminal blocks shall be pressure clamp type for switch socket rated up to 63A and bolted lug type for higher ratings. The terminals shall be rated for at least 1.5 times the switch rating.

8.0 **PAINTING**

- 8.1 The enclosure after suitable pre-treatment shall be painted with two coats of anti-rust paint followed by two coats of anti-corrosive paint.
- 8.2 Epoxy based paint shall be used.
- 8.3 All paints shall be carefully selected to withstand tropical heat and extremes of weather. The paint shall not scale off, crinkle or be removed by abrasion due to normal handling.
- 8.4 The finishing shade shall be light grey shade no.631 as per IS: 5, unless specified otherwise.

9.0 **TESTS AND INSPECTION**

- 9.1 The switch sockets and plugs shall be subjected to routine tests as per IS-4160 and other relevant standards.
- 9.2 Wherever specified, additional tests shall be carried out on one switch socket and plug of each rating.
- 9.3 The tests shall be carried out in the manufacturer's works in the presence of purchaser's representative. In addition to the above tests, the equipment shall be subject to stage inspection at works and inspection at site for final acceptance.
- 9.4 These inspections shall, however, not absolve the vendor from their responsibility for making good any defect which may be noticed subsequently.



TALCHER FERTILIZERS LIMITED
TECHNICAL SPECIFICATION - INTERLOCKING SWITCH
SOCKET AND PLUG

PC183-TS-0811

0

Document No.

Rev

Sheet 6 of 7



10.0 DRAWINGS AND DOCUMENTS

10.1 Drawings and documents as per Annexure-I shall be supplied, unless otherwise specified.

10.2 All drawings and documents shall have the following descriptions written boldly.

- Name of client
- Name of consultant
- Enquiry / Order Number with plant / project name
- Code No. and Description

11.0 PACKING

11.1 The switch socket and plug shall be properly packed to safeguard against weather conditions and handling during transit. It shall be wrapped in polythene bags and an additional wrapping of bitumen paper shall also be provided to make it completely water proof before the equipment is packed in wooden crates.

11.2 The packing box shall contain a copy of the installation, operation and maintenance manual.

12.0 SPARES

12.1 Commissioning Spares: Commissioning spares, as required, shall be supplied with the main equipment. Item-wise list of recommended commissioning spares shall be furnished for information.

12.2 Spare for 2 Years Operation (Mandatory), as specified shall be supplied.

12.3 List of Recommend Spares (other than Mandatory Spares) alongwith recommended quantity and item-wise price shall be furnished.

12.4 All spare parts shall be identical to the parts used in the equipment.



ANNEXURE – I

DOCUMENTATION FOR INTERLOCKING SWITCH SOCKET AND PLUG

Sl.No.	Description	Documents Required (Y / N)		
		With Bid	For Approval	Final
1.	Specification Sheet	N	Y	Y
2.	Technical Particulars	N	Y	Y
3.	General arrangement and foundation drawing	N	Y	Y
4.	Schematic / wiring diagram	N	Y	Y
5.	Illustrative and descriptive literature	N	N	Y
6.	Catalogue for bought out accessories	N	N	Y
7.	Installation operation and maintenance manual	N	N	Y
8.	Test Certificates			
	a) Type	N	N	Y
	b) Routine	N	N	Y
9.	Guarantee Certificate	N	N	Y
10.	Certificate of flameproofness from statutory testing authority wherever applicable.	N	N	Y
11.	Spare parts list with identification marks	N	N	Y

Note:

1. 4 hard copies & 1 soft copy shall be supplied for approval after order within 4 weeks from the date of LOI.
2. 8 hard copies & 2 soft copies in CD shall be submitted as final documents prior to despatch of the equipment. These shall be made in sets and supplied in fine plastic coated folder.

Y - Yes, N - No



TALCHER FERTILIZERS LIMITED
TECHNICAL SPECIFICATION - BATTERY CHARGER

PC183-TS-0813

0

Document No.

Rev

Sheet 1 of 12





TECHNICAL SPECIFICATION
BATTERY CHARGER



CONTENTS

SECTION NUMBER	DESCRIPTION
1.0	SCOPE
2.0	STANDARDS TO BE FOLLOWED
3.0	SERVICE CONDITIONS
4.0	DESIGN AND OPERATIONAL REQUIREMENTS
5.0	CONSTRUCTIONAL FEATURES
6.0	COMPONENT DETAILS
7.0	ACCESSORIES
8.0	PAINTING
9.0	TESTS AND INSPECTION
10.0	DRAWINGS AND DOCUMENTS
11.0	SPARES
12.0	PACKING
ANNEXURE - I	REQUIREMENT OF PROTECTIONS, METERING, CONTROL AND INDICATIONS / ANNUNCIATIONS FOR BATTERY CHARGER
ANNEXURE - II	DOCUMENTATION FOR BATTERY CHARGER

	TALCHER FERTILIZERS LIMITED TECHNICAL SPECIFICATION - BATTERY CHARGER	PC183-TS-0813	0	
		Document No.	Rev	
		Sheet 3 of 12		

1.0 SCOPE

- 1.1 This standard covers the technical requirements of design, manufacture, testing at works and delivery in well packed condition of Battery Charger Units.
- 1.2 The standard shall be read in conjunction with relevant part of Design Philosophy - Electrical.

2.0 STANDARDS TO BE FOLLOWED

- 2.1 The design, manufacture and testing of the equipment covered by this specification shall comply with the latest issue of IS: 8623 Specification for low voltage switchgear and control gear assemblies and other relevant Indian Standards, unless otherwise specified. Equipment complying with equivalent IEC standards shall also be acceptable.
- 2.2 The design and operational features of the equipment shall also comply with provisions of the latest issue of the Indian electricity Rules and other relevant Statutory Acts and Regulations. The supplier shall, wherever necessary, make suitable modifications to comply with the above.
- 2.3 Wherever any requirement, laid down in this standard, differs from that in Indian Standard Specifications, the requirement specified herein shall prevail.

3.0 SERVICE CONDITIONS

3.1 Ambient Conditions

These shall be as indicated in Design Philosophy - Electrical.

3.2 System Details

These shall be as indicated in Design Philosophy - Electrical.

4.0 DESIGN AND OPERATIONAL REQUIREMENTS

- 4.1 The Battery Charger Unit and its components shall be suitable for operating at the specified rating continuously with the specified voltage and frequency variations under the ambient conditions without exceeding the temperature rise limits specified in relevant standards and without any detrimental effect on any part.
- 4.2 The battery charger board shall consist of two units as follows:
- (a) Float cum load cum Boost Charger -- To supply continuous load and keep the battery in state in float mode. In Boost mode, for Initial charging of Battery and after power restoration subsequent to failure, to recharge the battery while simultaneously supplying load current.
 - (b) A stand by unit for (a) above.
- 4.3 The rated voltage of the float charger for lead acid battery shall be 2.2 Volt/ Cell and final charging voltage of the boost charger shall be 2.75 Volt/ Cell. The rated voltage of the float charger for Ni-Cd shall be minimum 1.4 Volt/ Cell and final charging voltage of the boost charger shall be minimum 1.7 Volt/ Cell. The rated output voltage of the charger under 4.2 (a) above shall be adjustable by $\pm 5\%$ of the rated value manually.
- 4.4 Charging unit stated under 4.2 (a) above shall be fully automatic using silicon controlled rectifiers (SCR) common for Float and Boost service. Charger D.C. output voltage shall be maintained within $\pm 2\%$ irrespective of the input supply variations and load variation of 0 to 100% by closed loop voltage feed back control system. The charger shall be provided with current limit feature.



TALCHER FERTILIZERS LIMITED
TECHNICAL SPECIFICATION - BATTERY CHARGER

PC183-TS-0813

0

Document No.

Rev

Sheet 4 of 12



- 4.5 The output voltage of the float charger shall be monitored and in case voltage falls below 90% of the rated voltage the stand by charger shall be automatically switched 'ON' with audio-visual alarm and annunciation. Time delay features shall be incorporated to avoid spurious changeover.
- 4.6 Boost charging shall be achieved through the same silicon controlled rectifier (SCR) which shall regulate the charger output automatically by current control closed loop system. Provision for manual adjustment of charger output shall also be made. Charger shall maintain its output current constant at starting rate/ finishing rate of battery charging current irrespective of variation in input supply and battery condition.
- 4.7 Transfer from float charging to boost charging and vice versa shall be automatic as per the battery charge condition.
- 4.8 During boost charging operation, arrangement shall be made so that DC power to load is not interrupted even if AC power fails during this operation. During Boost charge period, battery backup to load shall be arranged by a tapping from suitable point of the battery.
- 4.9 Suitable dropper diodes shall be provided to reduce the voltage across the load to 105% of the rated voltage at rated load current. When power supply to the charger fails, the dropper diodes shall be by-passed automatically through contactor so that full battery output voltage is available to the load.
- 4.10 Provision of suitable filters shall be made so that the ripple in output voltage shall not exceed 3% and 10% for float and boost charger respectively.
- 4.11 It shall be ensured that during boost charging, no over/under charging of cells takes place.
- 4.12 All the automatic features specified above shall also have provision of manual arrangement for control of charging rates and transfer from one charger to others.
- 4.13 Charger unit shall be provided with all required indication, metering, protection, control and alarm annunciation devices for safe and reliable operation and shall include at least as indicated in Annexure-I.
- 5.0 CONSTRUCTIONAL FEATURES**
- 5.1 Each of the charger units shall be housed in separate metal clad cubicles of identical size suitable for floor mounting and arranged to form a compact switchboard.
- 5.2 The complete assembly shall be dust, damp and vermin proof type equivalent to IP-43 as per IS/IEC:60947. In case it is necessary to provide openings for ventilation, these shall be closed from inside by fine wire mesh. Forced ventilated panel shall not be acceptable.
- 5.3 The frame work of cubicles shall be of bolted/welded construction, fabricated out of cold rolled sheet steel of not less than 2 mm thickness. The thickness of base channel shall not be less than 3 mm, suitable reinforcement, wherever necessary, shall be provided.
- 5.4 Hinged doors shall be provided on both the front and back side for easy access. The door hinges shall be concealed type.
- 5.5 The doors and the removable covers shall be provided with non-deteriorating neoprene gaskets. Gaskets without any discontinuity shall be preferred. Gaskets shall be held in position in groove in shaped steel work or these shall be 'U' type. Only one joint per gasket shall be permitted. Adhesive cement, if used, shall be of good quality so that the gaskets do not come off during service.
- 5.6 The mounting of the components shall be such that these are accessible for checking and replacement without the necessity of removing the adjacent ones, at the same time ensuring necessary degree of safety.



TALCHER FERTILIZERS LIMITED
TECHNICAL SPECIFICATION - BATTERY CHARGER

PC183-TS-0813

0



Document No.

Rev



Sheet 5 of 12



- 5.7 It shall be possible to carry out maintenance of one charger when the other is in operation.
- 5.8 The meters, switches and lamps shall be flush mounted type. All components of one unit shall be mounted on the same unit.
- 5.9 All the live parts shall be insulated. Parts which can not be insulated shall be provided with insulating barriers. These barriers shall provide shielding of all live parts to prevent accidental contact when the door is open. However, for the parts requiring handling normally, such as fuses/lamps etc., separate barriers shall be provided. The barriers in all cases shall cover the cable lug portions and shall be firmly secured, stable and durable. It shall, however, be possible to remove such barriers, if required.
- 5.10 At the equipment termination points, insulated phase barriers, PVC bolt caps, PVC hoses or insulating ribs shall be provided.
- 5.11 The outgoing terminal blocks shall be shrouded type or provided with insulating barriers.
- 5.12 Adequate arrangement for earthing shall be provided to safeguard the Operator or other personnel from electric hazards under all conditions of operation.
- 5.13 **Clearances and Creepage**
The clearances and creepage distances shall not be lower than the values specified below:
- | | | | |
|------|---|---|-------|
| i) | Minimum clearance between two live parts | : | 20 mm |
| ii) | Minimum clearance between a live part & earth | : | 20 mm |
| iii) | Minimum creepage distance | : | 28 mm |
- 5.14 **Insulation**
- 5.14.1 The insulation used shall be non-hygroscopic and may be of porcelain, epoxy resin or glass fibre moulded with plastic. It shall be of adequate electrical and mechanical strength to give trouble free service during normal operation and short circuit conditions.
- 5.14.2 The insulation shall be treated suitably to withstand the tropical conditions and atmospheric pollution as specified.
- 5.15 **Wiring**
- 5.15.1 The switch board shall be completely factory wired and ready for external connections.
- 5.15.2 The wiring shall be complete in all respect so as to ensure proper functioning of control, protection, interlocking and measurement.
- 5.15.3 The wiring shall be carried out with flexible stranded PVC insulated copper conductor cables of 1100 V grade of minimum 1.5 Sq.mm size.
- 5.15.4 All wiring shall be marked with dependent both ends marking as per IS: 5578. Numbered ferrules, reading from the terminals outwards, shall be provided at both ends for easy identification. These shall be interlocking type plastic ferrules.
- 5.15.5 The control cables shall be neatly arranged and properly supported on PVC wiring channel.
- 5.16 **Cable Termination**
- 5.16.1 The boards shall be designed for bottom entry of the power and control cables. Sufficient space shall be provided for ease of connection and termination of cable.
- 5.16.2 Provision for receiving one 415 V, 3 phase 4 wire incoming supply lines, one for each charger shall be made. However, DC output for battery and load shall be looped inside the panel and only one outgoing supply each for battery and load shall be provided.

	TALCHER FERTILIZERS LIMITED TECHNICAL SPECIFICATION - BATTERY CHARGER	PC183-TS-0813	0	
		Document No.	Rev	
		Sheet 6 of 12		

- 5.16.3 The termination of cables shall be done through cable glands which shall be suitable for the cables.
- 5.16.4 Heavy duty double compression type rolled Aluminium cable glands shall be provided. The cable glands shall be mounted on a removable gland plate, provided at a minimum height of 75 mm from the bottom of the switchboard. Two spare knockouts of size 20 mm shall also be provided on the gland plate for future addition of control cables.
- 5.16.5 For all power cables, crimped type cable lugs of same material as of conductor shall be provided.
- 5.16.6 The internal power wiring shall be terminated in the terminal blocks for connection to the outgoing cables, These terminal blocks shall be pressure clamp type up to 35 Sq.mm, cable and bolted lug type for higher sizes of cables, These shall be protected type and rated for 1100 V service. The minimum current rating of terminal block shall be 16 Amp. The construction shall be such that after the connection of cables by means of lugs, necessary clearances and creepage distances are available.
- 5.16.7 Not more than two wires shall be connected to any terminal. If necessary a number of terminals shall be jumpered together to provide wiring points.
- 5.16.8 Wherever necessary, suitable clamps to support the vertical run of cables shall be provided.
- 5.16.9 The terminal blocks shall be grouped according to circuit functions and suitably numbered. 20% extra terminals shall be provided in the terminal block.
- 5.16.10 For power connection, suitable marking on the terminals shall be provided to identify the phases.
- 5.17 **Earth Bus**
- 5.17.1 A continuous earth bus of Aluminium of suitable size minimum 32 x 6 mm shall be run all over the length in the lower part of the board with two ends connected to the external earth terminals of the board.
- 6.0 COMPONENT DETAILS**
- 6.1 **Rectifier Transformer**
- This shall be double wound, air cooled, 3 phase type. Class 'F' insulating materials shall be used, with temperature rise limited to Class 'B'. The windings shall be vacuum impregnated.
- 6.2 **Thyristors and Diodes**
- The thyristors and diodes shall be properly selected to have adequate safety margin. A factor of safety of minimum 4 shall be taken for voltage surges and 2 for current ratings. The thyristors and diodes shall be mounted on their respective heat sinks which shall preferably be made of extruded Aluminium properly machined and providing intimate contact with the stud for heat dissipation. Each thyristor/ diode shall be protected with properly designed snubber circuit.
- 6.3 **Air Break Switches**
- The switches shall be heavy duty quick make, quick break type conforming to IS/IEC 60947. Switches shall be snap action rotary type. 'ON'-'OFF' position of the switch shall be boldly indicated. The handle of switches shall remain fastened to the door even when the door is opened after turning the switch 'OFF'. The AC input switch shall not be directly mounted on the door.

	TALCHER FERTILIZERS LIMITED TECHNICAL SPECIFICATION - BATTERY CHARGER	PC183-TS-0813	0	
		Document No.	Rev	
		Sheet 7 of 12		

6.4 **Fuses**

For protection of thyristors/ diodes, semi-conductor fuses shall be provided. All other fuses shall be HRC cartridge link type. They shall be suitable for the load and service required.

6.5 **Contactors**

The contactor shall be air break type of category AC-3/ DC-1 as per IS/IEC 60947. DC contactor shall be provided with arc chutes and magnetic blow out coil. The contactors shall not drop out even when the coil voltage drops to 65% of rated voltage.

6.6 **Thermal Overload Relays**

Adjustable bimetal thermal overload relays shall be provided. The bimetal relays shall be ambient temperature compensated. The thermal relays shall be provided with a manual resetting device on the door.

6.7 All ammeters and voltmeters shall be class 1.5 as per IS 1248 and shall be flush mounted type of minimum size 96 x 96 mm. Ammeters and Voltmeters for A.C. service shall be of moving iron type and that for D.C. service shall be moving iron or moving coil type. Zero adjuster shall be provided for operation from the front of the cases.

6.8 **Printed Circuit Boards (PCBs)**

The PCBs shall conform to IS 7405. These shall be of fibre or epoxy glass moulded of minimum thickness 1.5 mm and shall have gold plated contacts and silver or nickel plated tracks. All PCBs shall be of plug-in type contained in a dust proof box. PCBs shall be self diagnostic type and shall be provided with status indication. Metering points shall be provided on each PCB and the PCBs shall be clamped in position so that vibration or long usage does not result in loose contacts.

6.9 **Timers**

The timers shall be electronic, pneumatic or synchronous type conforming to IS: 5834 with manual/auto reset features as per the functional requirements. The repeat accuracy shall be within 5%.

6.10 **Control and Selector Switches**

6.10.1 All the control and selector switches shall be of rotary type with thermal utilization category of AC 11 or DC 11 as per IS/IEC:60947.

6.10.2 The control switches shall be spring return type and provided with pistol grip type handles.

6.10.3 The selector switches shall be stay-put type and provided with oval handle.

6.11 **Signal Lamps**

6.11.1 Signal lamps shall be provided to indicate the various circuit conditions and these shall be placed at a suitable height. The colour of the lamps for various functions shall be as follows:

- Red -- Circuit 'ON'
- Green -- Circuit 'OFF'
- Amber -- Alarm and auto trip.

6.11.2 The lamps shall be LED type having lumen output of 200 millicandella in axial direction.

6.12 **Audio Visual Alarm Annunciation**

6.12.1 A solid state audio-visual alarm annunciation system shall be provided for the board. Audible annunciation shall be provided by means of hooter with provision of remote alarm and acknowledgment. Visual annunciation shall be provided by flashing of the



respective facia window. The facia window shall have translucent glass or plastic cover with inscription in black letters. Each facia window shall be provided with two lamps connected in parallel. The cover plate of the facia window shall be flush with the panel and shall be capable of easy removal to facilitate replacement of lamps.

- 6.12.2 The following operating sequence shall be adopted for audio visual alarm and indication:

System Condition	Visual Signal	Audible Signal
Normal	OFF	OFF
Abnormal	Flashing	ON
Acknowledge	Steady ON	OFF
Return to normal	OFF	OFF
Test	Steady ON	ON

7.0 ACCESSORIES

The supply shall include the following accessories:

7.1 Space Heater

Each cubicle of the board shall be provided with a thermostatically controlled space heater, rated for 240 V, 50 Hz and controlled through double pole miniature circuit breaker. The space heater supply shall be tapped from incomer power supply.

7.2 Name Plates

7.2.1 The board shall have a large name plate on the top to indicate its name and designation.

7.2.2 Each cubicle shall be provided with a name plate.

7.2.3 All control switches, push buttons, lamps etc. shall have function identification labels.

7.2.4 Name plate shall be of black perspex with white engraving of minimum 3 mm thickness.

7.3 Fuse Puller

7.4 Any other accessories required but not specified shall also be supplied to make the board complete in all respects and ensure its safe and proper operation.

8.0 PAINTING

8.1 The enclosure after suitable pre-treatment shall be painted with two coats of anti-rust paint followed by two coats of anti-corrosive paint.

8.2 Epoxy based paint shall be used.



8.3 All paints shall be carefully selected to withstand tropical heat and extremes of weather. The paint shall not scale off, crinkle or be removed by abrasion due to normal handling.

8.4 Unless otherwise specified the finishing shade shall be light grey having Shade No. 631 as per IS 5.

9.0 TESTS AND INSPECTION

9.1 The board shall be subjected to routine tests as per IS 8623 and other relevant standards. Heat run test, if required, shall be carried out.

9.2 Additional tests, wherever specified shall be carried out on one board of each rating.

	TALCHER FERTILIZERS LIMITED TECHNICAL SPECIFICATION - BATTERY CHARGER	PC183-TS-0813	0	
		Document No.	Rev	
		Sheet 9 of 12		

9.3 All the above tests shall be carried out in presence of purchaser's representative. In addition, the equipment shall be subjected to stage inspection during process of manufacture at works and site inspection.

9.4 These inspections shall however, not absolve the vendor from his responsibility for making good any defects which may be noticed subsequently.

10.0 DRAWINGS AND DOCUMENTS

10.1 Drawings and documents as per Annexure-II shall be supplied unless otherwise specified.

10.2 All drawings and documents shall have the following description written boldly:

- Name of client
- Name of consultant
- Enquiry / Order Number with plant / project name
- Code No. and Description

11.0 SPARES

11.1 Commissioning Spares : Commissioning spares, as required, shall be supplied with the main equipment. Item-wise list of recommended commissioning spares shall be furnished for information.

11.2 Spares for 2 Years Operation (Mandatory), as specified shall be supplied.

11.3 List of Recommend Spares (other than Mandatory Spares) alongwith recommended quantity shall be furnished.

11.4 All spare parts shall be identical to the parts used in the equipment.

12.0 PACKING

12.1 The board shall be properly packed before despatch to avoid damage during transport, storage and handling.

12.2 The packing box shall contain a copy of the installation, operation and maintenance manual along with one set of drawings.

12.3 A sign to indicate the upright position of the panels to be placed during transport and storage shall be clearly marked. Also proper arrangement shall be provided to handle the equipment.



ANNEXURE - I

REQUIREMENT OF PROTECTIONS, METERING, CONTROL AND INDICATIONS /
ANNUNCIATIONS FOR BATTERY CHARGER

Sl. No.	Description	To be mounted on		
		Float cum Load Charger	Standby Float cum Load Charger	Boost Charger
1	2	3	4	5
1.	A.C. Input Side			
	i) ON/OFF Switch	Yes	Yes	Yes
	ii) HRC Fuses	Yes	Yes	Yes
	iii) Contactor	Yes	Yes	Yes
	iv) Thermal O/L Relay	Yes	Yes	Yes
	v) Single phasing and Phase Reversal	Yes	Yes	Yes
	vi) Voltmeter with SS	Yes	Yes	Yes
	vii) Ammeter with SS	Yes	Yes	Yes
	viii) Signal Lamp (ON/OFF)	Yes	Yes	Yes
2.	Rectifiers			
	i) Semiconductor fuses	Yes	Yes	Yes
	ii) Filters with fuses	Yes	Yes	Yes
	iii) Surge Suppressors	Yes	Yes	Yes
3.	DC Output Side			
	i) ON/OFF Switch	Yes	Yes	Yes
	ii) HRC Fuses	Yes	Yes	Yes
	iii) Blocking Diodes	Yes	Yes	Yes
	iv) Voltmeter	Yes	Yes	Yes
	v) Ammeter	Yes	Yes	Yes
	vi) Signal Lamp (ON/OFF)	Yes	Yes	Yes
	viii) Charging Ammeter (on demand type)	Yes	Yes	Yes



TALCHER FERTILIZERS LIMITED
TECHNICAL SPECIFICATION - BATTERY CHARGER

PC183-TS-0813

0

Document No.

Rev

Sheet 11 of 12



Sl. No.	Description	To be mounted on		
		Float cum Load Charger	Standby Float cum Load Charger	Boost Charger
1	2	3	4	5
4.	Common Items i) Droper Diodes ii) Solid State facia annunciator for : -- Automatic changeover from one charger to another -- Rectifier fuse failure in float/standby float/boost -- Incoming supply failure float/standby float/boost -- DC output under voltage -- Earth fault -- Single phasing and phase reversal -- Filter fuse failure float/standby float/boost iii) Battery isolating switch and HRC fuses iv) Battery under voltage relay v) Battery earth fault relay vi) DC Contactor	Yes Yes	Yes	Yes Yes Yes Yes Yes

NOTE: Any other components as required for satisfactory operation of the battery charger shall be provided.



ANNEXURE - II

DOCUMENTATION FOR BATTERY CHARGER

Sl.No.	Description	Documents Required (Y / N)		
		With Bid	For Approval	Final
1.	Specification Sheet	N	Y	Y
2.	Technical Particulars	N	Y	Y
3.	General arrangement drawings showing overall dimensions of the charger board and mounting details of various equipment inside the charger panel	N	Y	Y
4.	Foundation plan indicating certified dimensions, floor openings, weight, clearance etc.	N	Y	Y
5.	Schematic and Wiring Diagrams	N	Y	Y
6.	Descriptive literature of the charger and various components mounted in the panel.	N	N	Y
7.	Characteristics curves for the charger and all other static and control devices, relays etc.	N	N	Y
8.	Installation, Operation and Maintenance manual	N	N	Y
9.	Guarantee Certificates	N	N	Y
10.	Test Certificates	N	N	Y
11.	Spare parts list with identification marks	N	N	Y

Note:

1. 4 hard copies & 1 soft copy shall be supplied for approval after order within 4 weeks from the date of LOI.
2. 8 hard copies & 2 soft copies in CD shall be submitted as final documents prior to despatch of the equipment. These shall be made in sets and supplied in fine plastic coated folder.

Y - Yes, N - No



TALCHER FERTILIZERS LIMITED
TECHNICAL SPECIFICATION – BATTERY

PC183-TS-0814

0

Document No.

Rev

Sheet 1 of 6



TECHNICAL SPECIFICATION
BATTERY



CONTENTS

SECTION NUMBER	DESCRIPTION
1.0	SCOPE
2.0	STANDARDS TO BE FOLLOWED
3.0	SERVICE CONDITIONS
4.0	OPERATING REQUIREMENTS
5.0	GENERAL DESIGN AND CONSTRUCTIONAL FEATURES
6.0	ACCESSORIES
7.0	TESTS AND INSPECTION
8.0	DRAWINGS AND DOCUMENTS
9.0	SPARES
10.0	PACKING
ANNEXURE - I	DOCUMENTATION FOR BATTERY



TALCHER FERTILIZERS LIMITED
TECHNICAL SPECIFICATION – BATTERY

PC183-TS-0814

0

Document No.

Rev

Sheet 3 of 6



1.0 SCOPE

- 1.1 This standard covers the technical requirements of design, manufacture, testing at works and despatch in well packed condition of batteries and accessories.
- 1.2 This standard shall be read in conjunction with the relevant part of Design Philosophy - Electrical.

2.0 STANDARDS TO BE FOLLOWED

- 2.1 The design, manufacture and testing of the battery shall conform to the latest issue of the following standards:

- IS: 1651 -- Stationary cells & batteries, lead-acid type (with tubular positive plate)
- IS: 1652 -- Stationary cells & batteries, lead-acid type with plante positive plates.
- IS: 10918 -- Vented type nickel cadmium batteries

All accessories shall also conform to the relevant Indian Standard. Equipment complying with equivalent IEC standards shall also be acceptable.

- 2.2 The design and operational features of the equipment offered shall comply with the provisions of the latest issue of the Indian Electricity Rules and other Statutory Acts and Regulations. The supplier shall, wherever necessary, make suitable modifications in the equipment to comply with the above.
- 2.3 Wherever any requirement, laid down in this standard, differs from that in Indian Standard specifications, the requirement specified herein shall prevail.

3.0 SERVICE CONDITIONS

3.1 Ambient Conditions

These shall be as indicated in Design Philosophy - Electrical.

3.2 System Details

These shall be as indicated in Design Philosophy - Electrical.

4.0 OPERATING REQUIREMENTS

The battery shall be able to deliver rated ampere hours when discharged at the 10 hours rate of discharge to a final voltage of 1.85 V per cell for Lead Acid and at the 5 hours rate of discharge to a final voltage of 1.1 V per cell for Ni-Cd battery under the ambient conditions indicated in Design Philosophy - Electrical.

5.0 GENERAL DESIGN AND CONSTRUCTIONAL FEATURES

- 5.1 The battery shall be of Ni-Cd type and rated for 110V. Each battery bank shall consist of 90 number of cells.
- 5.2 The battery bank shall be complete with all necessary components such as lids, plugs, separators and buffers, inter-cell connectors, lead coated bolts and nuts, cell insulators etc.
- 5.3 The required quantity of electrolyte plus 10% extra quantity shall be supplied in suitable non-returnable containers along with the battery.

6.0 ACCESSORIES

The following accessories shall be supplied with each battery bank:-

- (a) 1 Set -- Battery Stand constructed out of teak wood without the use of any metal fastenings and coated with 3 coats of anti-acid paint.



TALCHER FERTILIZERS LIMITED
TECHNICAL SPECIFICATION – BATTERY

PC183-TS-0814

0

Document No.

Rev

Sheet 4 of 6



The stand shall be properly designed so that each cell shall be easily accessible for inspection, topping up etc. However, for Ni-Cd battery mild steel stand with alkali resistant paint may also be accepted

- | | | | |
|-----|--------|----|---|
| (b) | 1 Set | -- | Inter-row, inter-tier and inter-stand connectors and takeoffs. These shall be sized suitably to have adequate current carrying capacity and mechanical strength |
| (c) | 1 Set | -- | Cell Insulators |
| (d) | 1 Set | -- | Stand Insulators |
| (e) | 1 No. | -- | Centre zero cell testing voltmeter scaled 3-0-3 volts |
| (f) | 2 Nos. | -- | Syringe type Hydrometers for measuring the specific gravity of the electrolyte |
| (g) | 2 Nos. | -- | Gravity correction thermometers, mercury-in-glass type |
| (h) | 1 Set | -- | Connecting bolt wrenches |
| (i) | 1 No. | -- | Rubber syringe for tapping cells |
| (j) | 1 No. | -- | Wall mounting type teak wood holder for Hydrometer and Thermometer. |
| (k) | 1 No. | -- | Acid/Alkali resisting funnel. |
| (l) | 1 No. | -- | Acid/Alkali resisting jug. |
| (m) | 1 Pair | -- | Rubber gloves. |
| (n) | 1 No. | -- | Rubber Apron. |

All other accessories, not specified above, but required for satisfactory operation and maintenance shall also be supplied.

7.0 TESTS AND INSPECTION

- 7.1 Type tests shall be carried out as per relevant standards on two cells in the presence of Purchaser's representative.
- 7.2 Acceptance tests shall be carried out as per relevant standards on each cell after installation at site.
- 7.3 In addition, the battery shall be subjected to stage inspection at works and inspection at site for final acceptance.
- 7.4 These inspections shall, however, not absolve the vendor from his responsibilities for making good any defect which may be noticed subsequently.

8.0 DRAWINGS AND DOCUMENTS

- 8.1 Drawings and documents as per Annexure-I shall be furnished by the Vendor unless otherwise specified.
- 8.2 All drawings and documents shall have following description written boldly:
- Name of client
 - Name of consultant
 - Enquiry / Order Number with plant / project name
 - Code No. and Description



TALCHER FERTILIZERS LIMITED
TECHNICAL SPECIFICATION – BATTERY

PC183-TS-0814

0

Document No.

Rev

Sheet 5 of 6



9.0

SPARES

- 9.1 Commissioning Spares : Commissioning spares, as required, shall be supplied with the main equipment. Item-wise list of recommended commissioning spares shall be furnished for information.
- 9.2 Spares for 2 Years Operation (Mandatory), as specified shall be supplied.
- 9.3 List of Recommend Spares (other than Mandatory Spares) alongwith recommended quantity shall be furnished.
- 9.4 All spare parts shall be identical to the parts used in the equipment.

10.0

PACKING

The battery cells and accessories shall be properly packed to safeguard against weather conditions and rough handling. It shall be wrapped in polythene bags with an additional wrapping bitumen paper to make it completely water proof before it is packed in crates. The packing box shall contain a copy of the installation operation and maintenance manual.



ANNEXURE – I



DOCUMENTATION FOR BATTERY

Sl. No.	Description	Documents Required (Y / N)		
		With Bid	For Approval	Final
1.	Specification Sheet	N	Y	Y
2.	Technical Particulars	N	Y	Y
3.	Dimensional drawings showing the cell arrangement on stand (Plan, front and side elevation) for each type of battery.	N	Y	Y
4.	Illustrative and descriptive literature giving the complete details of construction of battery	N	N	Y
5.	Operation and maintenance instructions	N	N	Y
6.	Test Certificates			
	-- Type	N	N	N
	-- Acceptance	N	N	Y
7.	Guarantee Certificates	N	N	Y
8.	Spare Parts lists	N	N	Y

Note:

1. 4 hard copies & 1 soft copy shall be supplied for approval after order within 4 weeks from the date of LOI.
2. 8 hard copies & 2 soft copies in CD shall be submitted as final documents prior to despatch of the equipment. These shall be made in sets and supplied in fine plastic coated folder.

Y - Yes, N - No



	TALCHER FERTILIZERS LIMITED TECHNICAL SPECIFICATION - CABLES	PC183-TS-0815	0	
		Document No.	Rev	
		Sheet 1 of 6		

TECHNICAL SPECIFICATION

CABLES

CONTENTS

SECTION NUMBER	DESCRIPTION
1.0	SCOPE
2.0	STANDARDS TO BE FOLLOWED
3.0	SERVICE CONDITIONS
4.0	OPERATING REQUIREMENTS
5.0	GENERAL DESIGN AND CONSTRUCTIONAL FEATURES
6.0	SPECIAL PURPOSE CABLES
7.0	CABLE DRUM
8.0	TESTS AND INSPECTION
9.0	DRAWINGS AND DOCUMENTS
ANNEXURE - I	DOCUMENTATION FOR CABLES

	TALCHER FERTILIZERS LIMITED TECHNICAL SPECIFICATION - CABLES	PC183-TS-0815	0	
		Document No.	Rev	
		Sheet 3 of 6		

1.0 SCOPE

- 1.1 This standard covers the technical requirements of design, manufacture, testing at works and dispatch in well packed condition of power and control cables.
- 1.2 The standard shall be read in conjunction with relevant part of Design Philosophy - Electrical and other relevant references as specified therein.

2.0 STANDARDS TO BE FOLLOWED

- 2.1 The design, manufacture and testing of cables covered by this standard shall comply with the latest issue of following Indian Standards, unless otherwise specified. Equipment complying with equivalent IEC standards shall also be acceptable.

- IS: 1554 Part (I) -- PVC insulated (heavy duty) electric cables for working voltages upto and including 1100 volts.
- IS: 1554 Part (II) -- PVC insulated (heavy duty) electric cables for working voltages from 3.3 KV upto and including 11 KV.
- IS: 7098 Part (I) -- Cross linked polyethylene insulated PVC sheathed cables for working voltages upto and including 1100 volts.
- IS: 7098 Part (II) -- Cross linked polyethylene insulated PVC sheathed cables for working voltages from 3.3 KV upto and including 33 KV
- IS: 694 -- PVC insulated cables for working voltages upto and including 1100 volts
- IS: 5831 -- PVC insulation and sheath of electric cables

- 2.2 The design and operational features of the cables offered shall also comply with the provisions of latest issue of the Indian Electricity Rules and other relevant Statutory Rules & Regulations. The supplier shall, whenever necessary, make suitable modification in the cables to comply with the above mentioned rules.
- 2.3 Wherever any requirement, laid down in this standard, differs from that in Indian Standard Specifications, the requirement specified herein shall prevail.

3.0 SERVICE CONDITIONS

3.1 Ambient Conditions

These shall be as indicated elsewhere in Design Philosophy - Electrical.

3.2 System Details



These shall be as indicated elsewhere in Design Philosophy - Electrical.

4.0 OPERATING REQUIREMENTS

The cables shall be suitable for operating continuously at the rated capacity as specified in relevant I.S. under the ambient conditions without exceeding the permissible temperature rise and without any detrimental effect on any part.

5.0 GENERAL DESIGN AND CONSTRUCTIONAL FEATURES

- 5.1 The design, manufacture and workmanship of cables shall be in accordance with the latest practice.
- 5.2 All materials to be used shall be new, unused and of the best quality.

	TALCHER FERTILIZERS LIMITED TECHNICAL SPECIFICATION - CABLES	PC183-TS-0815	0	
		Document No.	Rev	
		Sheet 4 of 6		

5.3 Conductors

The power cables shall be of stranded Aluminium / copper round or shaped conductors and control cables shall be of annealed high conductivity stranded copper round conductors. The conductors shall comply with the requirements of IS: 8130.

5.4 Insulation

The conductor insulation shall be XLPE and shall comply with relevant IS.

5.5 Fillers

The cables shall have suitable fillers wherever required, laid up with conductors to provide substantially circular cross section before the inner sheath is applied.

5.6 Inner Sheath

Inner sheath, wherever applicable shall be ST1/ ST2 type compound applied by extrusion process except for paper cables for which it shall be of lead or lead alloy.

5.7 Armouring

All power and control cables shall be armoured. The single core cables shall be armoured with hard drawn Aluminium taps/ wires or any other suitable nonmagnetic material. All other cables shall have galvanized steel wire / strip armouring.

5.8 Outer Sheath

The outer sheath shall be ST1/ ST2 type compound applied by extrusion process and suitable to withstand atmospheric pollution, resistance to termites, fire retardant and coloured black.

5.9 Screening

Screening over conductor and insulation shall be provided as per relevant standard unless specified otherwise. The screening for control cables if specified shall be of aluminium, mylor or equivalent and provided with tinned drain wire which shall be continuous and permanently connected to the screen.

5.10 Identification

The individual cores of cables shall be coloured as per relevant IS. Where it is not possible to distinguish the cores by colour, coloured strip shall be applied on the cores or core nos. shall be marked on each core at regular intervals. All cables shall carry the manufacturer's name or trade mark, the cable size, voltage rating and year of manufacture at intervals not exceeding 100 meters. Running meter markings shall also be provided throughout the length of the cable.

5.11 Dimension

The overall dia. and dia. under armour of the cables shall be indicated by the vendor in the technical particulars. These shall be guaranteed with a tolerance of $\pm 5\%$ but not exceeding 2 mm.



5.12 The cut ends of the cables shall be sealed by means of non-hygroscopic materials.

6.0 SPECIAL PURPOSE CABLES

6.1 Flame Retardant Low Smoke Cables

Flame retardant low smoke cables shall have outer sheath of PVC having following values.

- Minimum oxygen index - 29%
- Minimum temperature index - 250°C

	TALCHER FERTILIZERS LIMITED TECHNICAL SPECIFICATION - CABLES	PC183-TS-0815	0	
		Document No.	Rev	
		Sheet 5 of 6		

- Maximum acid gas generation - 20%
- Maximum smoke density rating - 60%

6.2 Heat Resistant Cables

Heat resistant cables shall be of silicon rubber insulated laid circular with asbestos worming and overall glass fibre braided and varnished. Silicon rubber insulating compound shall conform to IS: 6380 and the constructional features shall conform generally to IS: 9968.

7.0 CABLE DRUM



- 7.1 The cables shall be supplied in non-returnable wooden drums (or steel drums if specified) of heavy construction. The wood used for construction of the drums shall be properly seasoned, sound and free from defects.
- 7.2 Cables shall be supplied in specified drum lengths. Where no such indication is given, standard drum lengths may be offered.
- 7.3 The tolerance on each drum of cable shall not exceed $\pm 2.5\%$. However, no negative tolerance on HV cables is acceptable.
- 7.4 All cable drums shall have stencilled data as per relevant IS as well as the purchaser's order no., item no. & drum no.

8.0 TESTS AND INSPECTION

- 8.1 The following tests shall be carried out on the cables as per relevant IS.
- i) Routine Tests - On all cables
 - ii) Acceptance tests - On representative length of each size
 - iii) Type tests - Wherever specified on one cable drum of each size
- 8.2 In addition, the following tests shall be carried out on all fire retardant low smoke cables as per IS or as per the following standards:
- i) Oxygen and temperature index test as per ASTM-D-2863
 - ii) Acid gas emission test as per IEC-754 Part-I
 - iii) Smoke density test as per ASTM-D-2843
 - iv) Flammability test as per IEC-332 Part-I or IS-10810
- 8.3 All the above mentioned tests shall be carried out in the presence of purchaser's representative. In addition, the cables shall be subjected to stage inspection at works and inspection at site for final acceptance.
- 8.4 These tests and inspections shall, however, not absolve the vendor from their responsibility for making good any defect which may be noticed subsequently.

9.0 DRAWINGS AND DOCUMENTS

- 9.1 Drawings and documents as per Annexure-I shall be supplied, unless otherwise specified.
- 9.2 All drawings and documents shall have the following descriptions written boldly.
- Name of client
 - Name of consultant
 - Enquiry / Order Number with plant / project name
 - Code No. and Description

	TALCHER FERTILIZERS LIMITED TECHNICAL SPECIFICATION - CABLES	PC183-TS-0815	0	
		Document No.	Rev	
		Sheet 6 of 6		

ANNEXURE - I
DOCUMENTATION FOR CABLES

Sl. No.	Document Description	Documents Required (Y / N)		
		With Bid	For Approval	Final
1.	Specification Sheet	N	Y	Y
2.	Technical Particulars	N	Y	Y
3.	Illustrative and Descriptive catalogues	N	N	Y
4.	Installation, Termination and Jointing Instructions	N	N	Y
5.	Test certificates			
	a) Routine	N	N	Y
	b) Type	N	N	Y
6.	Guarantee Certificates	N	N	Y

Note:

1. 4 hard copies & 1 soft copy shall be supplied for approval after order within 4 weeks from the date of LOI.
2. 8 hard copies & 2 soft copies in CD shall be submitted as final documents prior to despatch of the equipment. These shall be made in sets and supplied in fine plastic coated folder.

Y - Yes, N - No

	TALCHER FERTILIZERS LIMITED TECHNICAL SPECIFICATION - PREFABRICATED LADDER TYPE CABLE RACKS	PC183-TS-0816	0	
		Document No.	Rev	
		Sheet 1 of 6		

TECHNICAL SPECIFICATION

PREFABRICATED LADDER TYPE CABLE RACKS

	TALCHER FERTILIZERS LIMITED TECHNICAL SPECIFICATION - PREFABRICATED LADDER TYPE CABLE RACKS	PC183-TS-0816	0	
		Document No.	Rev	
		Sheet 2 of 6		

CONTENTS

SECTION NUMBER	DESCRIPTION
1.0	SCOPE
2.0	STANDARDS TO BE FOLLOWED
3.0	GENERAL DESIGN AND CONSTRUCTIONAL FEATURES
4.0	MARKING
5.0	TESTS AND INSPECTION
6.0	DRAWINGS AND DOCUMENTS
ANNEXURE - I	DOCUMENTATION FOR PREFABRICATED LADDER TYPE CABLE RACKS

	TALCHER FERTILIZERS LIMITED TECHNICAL SPECIFICATION - PREFABRICATED LADDER TYPE CABLE RACKS	PC183-TS-0816	0	
		Document No.	Rev	
		Sheet 3 of 6		

1.0 SCOPE

- 1.1 This standard covers the technical requirements of design, fabrication, testing at works and delivery in well-packed condition of prefabricated ladder type cable racks.
- 1.2 The standard shall be read in conjunction with Drawing Nos. PDS: E 530 to 538 (9 Sheets).

2.0 STANDARDS TO BE FOLLOWED

- 2.1 The design, manufacture and testing of the cable racks covered by this standard shall comply with the latest issue of following and other relevant Indian Standards, unless otherwise specified. Equipment complying with equivalent IEC standards shall also be acceptable.
- IS: 733 -- Wrought aluminium and aluminium alloy bars, rods and sections for general engineering purposes
- IS: 2629 -- Recommended practice for hot dip galvanising on iron and steel
- IS: 4759 -- Hot dip zinc coatings on structural steel and other allied products
- 2.2 Wherever any requirement, laid down in this standard, differs from that in Indian Standard Specifications, the requirement specified herein shall prevail.

3.0 GENERAL DESIGN AND CONSTRUCTIONAL FEATURES

- 3.1 Ladder type cable racks shall be fabricated as per attached Drawing Nos. PDS: E 530 to PDS: E 538 (9 Sheets).
- 3.2 Cable racks and accessories such as coupler plate, tees, bend, elbows etc. shall be fabricated from 3 mm thick mild steel galvanised sheet or 4 mm thick aluminium 19000 H2 alloy sheet extrusion conforming to designation No. 64430 and condition WP as per IS: 733.
- 3.3 G.I. racks and accessories shall have zinc coating of 800 gm/sq. metre applied by hot dip galvanising process. Galvanising shall be uniform, adherent, smooth and free from defects.
- 3.4 The finished rack and accessories shall be free from sharp edges and corners, burrs and un-evenness. Stepped arrangement of bending is not acceptable. The channel members in the bending shall have uniform curvature and shall be made out of single piece.
- 3.5 The racks shall be supplied in minimum length of 2.4 metre.
- 3.6 Each straight length and bend shall be supplied with two coupling plates fitted at each side channel at one end. The coupling plates shall be supplied with bolts, nuts and washers fitted at the other four holes for fixing to adjoining member.
- 3.7 Coupling plate shall be designed to permit longitudinal adjustment upto ± 10 mm and skew upto 10° .
- 3.8 Clamping arrangement as per attached drawings shall be provided for fixing the rack with the cross support as required.
- 3.9 All the bends, tees and junctions shall be made sufficiently rigid by providing suitable reinforcement on rungs as required.
- 3.10 The rungs shall be connected to the side channels by continuous welding alongwith three sides of rung. Aluminium rack shall be welded by TIG welding process.
- 3.11 All hard wares such as nuts, bolts, washers and crank bolts shall be cadmium plated.

	TALCHER FERTILIZERS LIMITED TECHNICAL SPECIFICATION - PREFABRICATED LADDER TYPE CABLE RACKS	PC183-TS-0816	0	
		Document No.	Rev	
		Sheet 4 of 6		

3.12 Tolerances in various dimension shall be follows:

Length	--	± 5 mm
Width	--	± 2 mm
Height	--	± 1 mm
Bend	--	± 1 mm
Thickness	--	± 0.2 mm

Positive tolerance on total quantity upto ± 5% is acceptable. However, negative tolerance on total quantity is not acceptable.

4.0 MARKING

The packing shall be clearly marked on the outside (on top side & ends) in indelible ink with the following minimum details:

- Part No.
- Size of Tray (Length x Width x Height)
- No. of Tray / Section, Total Weight
- Material Specification
- Client's Name
- Purchase Order No.
- Manufacturer's Name

5.0 TESTS AND INSPECTION

5.1 Following tests shall be carried out on prefabricated cable racks:

Visual inspection and checking for

- i) Quality and thickness of raw material
- ii) Dimensions as per drawing.
- iii) Quality of welding (before galvanising for G.I. racks)
- iv) Preparation of metal surfaces (for G.I. racks).

5.2 After galvanising, G.I. cable racks shall be subjected to following tests as per IS:4759.

- i) Mass of galvanising coating -- At any location the thickness of zinc coating shall not be less than 90 micron. However, average thickness of zinc coating shall not be less than 113 micron.
- ii) Uniformity of galvanising coating.
- iii) Adhesion of galvanising coating.
- iv) 3 samples from each lot shall be taken for testing.
- v) From each lot and size of rack, measure length of 10 trays and average length to be multiplied by number of trays to arrive for total length.

5.3 All the above tests shall be carried out in the manufacturer's works in the presence of Purchaser's representative. In addition to the above tests, the cable racks and its accessories shall be subjected to stage inspection at works and inspection at site for final acceptance.

	TALCHER FERTILIZERS LIMITED TECHNICAL SPECIFICATION - PREFABRICATED LADDER TYPE CABLE RACKS	PC183-TS-0816	0	
		Document No.	Rev	
		Sheet 5 of 6		

5.4 These tests and the Purchaser's inspection shall, however, not absolve the vendor from their responsibility for making good any defect which may be noticed subsequently.

6.0 DRAWINGS AND DOCUMENTS

6.1 Drawings and documents as per Annexure-I shall be supplied, unless otherwise specified.

6.2 All drawings and documents shall have the following descriptions written boldly.

- Name of client
- Name of consultant
- Enquiry / Order Number with plant / project name
- Code No. and Description

	TALCHER FERTILIZERS LIMITED TECHNICAL SPECIFICATION - PREFABRICATED LADDER TYPE CABLE RACKS	PC183-TS-0816	0	
		Document No.	Rev	
		Sheet 6 of 6		

ANNEXURE - I

DOCUMENTATION FOR PRE-FABRICATED LADDER TYPE CABLE RACKS

Sl. No.	Document Description	Documents Required (Y / N)		
		With Bid	For Approval	Final
1.	Illustrative and Descriptive catalogues	N	N	Y
2.	Installation, Termination and Jointing Instructions	N	N	Y
3.	General Arrangement Drawings, showing details of rack, coupling pieces, fasteners, etc.	N	Y	Y
4.	Test certificates	N	N	Y
5.	Guarantee Certificates	N	N	Y

Note:

1. 4 hard copies & 1 soft copy shall be supplied for approval after order within 4 weeks from the date of LOI.
2. 8 hard copies & 2 soft copies in CD shall be submitted as final documents prior to despatch of the equipment. These shall be made in sets and supplied in fine plastic coated folder.

Y - Yes, N - No



TALCHER FERTILIZERS LIMITED
TECHNICAL SPECIFICATION - LOCAL CONTROL STATION

PC183-TS-0817

0

Document No.

Rev

Sheet 1 of 8



TECHNICAL SPECIFICATION

LOCAL CONTROL STATION



CONTENTS

SECTION NUMBER	DESCRIPTION
1.0	SCOPE
2.0	STANDARDS TO BE FOLLOWED
3.0	SERVICE CONDITIONS
4.0	OPERATIONAL REQUIREMENTS
5.0	GENERAL DESIGN & CONSTRUCTIONAL FEATURES
6.0	SPECIAL FEATURES FOR FLAMEPROOF LOCAL CONTROL STATION
7.0	COMPONENT DETAILS
8.0	PAINTING
9.0	TESTS AND INSPECTION
10.0	DRAWINGS AND DOCUMENTS
11.0	SPARES
12.0	PACKING
ANNEXURE - I	DOCUMENTATION FOR LOCAL CONTROL STATIONS



1.0 SCOPE

1.1 This standard covers the technical requirements of design, manufacture, testing at works and delivery in well-packed condition of Local Control Stations.

1.2 This standard shall be read in conjunction with relevant part of Design Philosophy - Electrical and other relevant references as specified therein.

2.0 STANDARDS TO BE FOLLOWED

2.1 The design, manufacture and testing of the equipment covered by this standard shall comply with the latest issue of IS/IEC:60947 and other relevant Indian Standards, unless otherwise specified. Equipment complying with equivalent IEC standards shall also be acceptable.

2.2 The design and operational features of the equipment offered shall also comply with the provisions of latest issue of the Indian Electricity rules and other relevant statutory Acts and Regulations. The supplier shall, wherever necessary, make suitable modification in the equipment to comply with the above.

2.3 Wherever any requirement, laid down in this standard differs from that in Indian Standard Specifications, the requirement specified herein shall prevail.

3.0 SERVICE CONDITIONS

3.1 Ambient Conditions

These shall be as indicated elsewhere in Design Philosophy - Electrical.

3.2 System Details

These shall be as indicated elsewhere in Design Philosophy - Electrical.

4.0 OPERATIONAL REQUIREMENTS

This equipment and associated components shall be suitable for operating satisfactorily under the specified ambient and system conditions.

5.0 GENERAL DESIGN AND CONSTRUCTIONAL FEATURES

5.1 The Control Stations shall be suitable for control voltage not exceeding 500V, 50 Hz AC or 220V D.C.

5.2 The enclosure shall be of die cast Aluminium alloy LM-6. As an alternative to cast Aluminium, fibre glass enclosure is also acceptable.

5.3 The equipment shall have dust, hose and weather proof construction equivalent to IPW-55 as per IS/IEC:60947. These shall be suitable for outdoor location without any additional protection or cover.

5.4 A rain-hood shall be offered as an additional item. It shall be made of 14 gauge Aluminium sheet bent to shape. In case of fibre glass enclosure, these can be made of fibre glass.

5.5 All external hardware of diameter less than 8 mm shall be of stainless steel and those of diameter 8 mm and above shall be of mild steel cadmium plated or zinc passivated. For fibre glass enclosure Nylon PVC bolts of diameter 8 mm may be used.

5.6 The control station shall preferably be with bolted cover. The bolts for retaining the cover in position shall be provided with 10 mm dia. stainless steel and these shall be so arranged that they do not pierce into the door gasket.

5.7 All the components shall be mounted on a base plate inside the enclosure. Necessary actuating system for control switch, push button, non yellowing acrylic/ glass cover for



ammeter and indication lamps shall be provided on the front cover. No wiring shall be carried out on the front cover.

- 5.8 The layout of components in the control station shall be liberal and standardised.
- 5.9 All mating surfaces shall be smoothly machined and shall be of sufficient width of at least 6 mm. The covers shall be provided with continuous gasket made of neoprene or synthetic rubber to prevent ingress of dust and moisture. The gasket shall be held in position in groove provided in the enclosure and shall be pressed all around uniformly by suitably shaped projection of the door. Gaskets simply glued to the surface are not acceptable.
- 5.10 The enclosure shall be suitable for mounting on wall or on steel structure. 4 Nos. holes suitable for 12 mm bolts shall be provided outside the enclosure for fixing the control stations.
- 5.11 The internal wiring shall be carried by means of single core PVC insulated 1.5 sq. mm stranded copper conductor cable. All termination shall be made with crimping type proper size lugs and shall be properly ferruled.
- 5.12 The control stations shall be completely factory wired and ready for external cable connection.
- 5.13 For easy identification, numbering ferrules shall be provided on all wiring at both ends i.e. equipment end and terminal block end. Terminals for external wiring shall be numbered
- 5.14 The enclosure shall be provided with two earthing terminals with studs of 8 mm. dia. projecting outside the enclosure for connection to earth. These terminals shall not pierce through the enclosure and shall be marked with earthing symbol.
- 5.15 Each control station shall be provided with minimum 2 mm thick stainless steel name plates or consisting of black Perspex with white engraving indicating the code number and description of the equipment controlled by it. Similar labels shall be provided for all indication lamps, push buttons and control switches. The name plate and label shall be fixed with screws only.

6.0 SPECIAL FEATURES FOR FLAME PROOF LOCAL CONTROL STATION

- 6.1 The enclosure shall be in addition, of flameproof execution as per IS: 2148.
- 6.2 The control stations shall be suitable for hazardous area of enclosure group and temperature class as indicated in Design Philosophy - Electrical.
- 6.3 Cables shall enter the terminal box through flame proof cable gland. From the terminal chamber to the main enclosure, the connections shall be made through proper bushings. Direct entry of external cables into the main enclosure shall not be accepted. All entries shall be provided with stainless steel inserts.
- 6.4 An additional earthing terminal inside the terminal chamber shall be provided.
- 6.5 Local control stations and cable gland must be certified by the Central Mining Research Institute, Dhanbad or any other statutory authority for use in the specified hazardous area.

7.0 COMPONENT DETAILS

7.1 Trip-Neutral-Close Switch

TRIP-NEUTRAL-CLOSE switch shall be double pole, 3 position, pistol grip, rotary type having self spring return feature to neutral position. The contacts shall be of phosphor bronze and shall be provided with two breaks in series. Mechanical sequence device to prevent two successive movements to the same position shall be fitted. The switch shall be capable of being padlocked in the 'TRIP' position.

	TALCHER FERTILIZERS LIMITED TECHNICAL SPECIFICATION - LOCAL CONTROL STATION	PC183-TS-0817	0	
		Document No.	Rev	
		Sheet 5 of 8		

- 7.2 **‘Auto-Manual’ Switch**
‘Auto-Manual’ switch shall be single pole stay put type having three positions “AUTO-OFF-MANUAL”. Provision shall be made to padlock the switch in the “OFF” position.
- 7.3 **Selector Switch / Lock Service Switch**
These shall be single pole stay put type having two position with a pistol grip handle and capable of being padlocked in one of the position.
- 7.4 All the switches shall be rotary type with snap or wiping action contact and having a set of normally open and closed contacts in each position. All switches shall be provided with pistol grip handle.
- 7.5 **‘Off-Auto-On’ Switch**
- 7.5.1 ‘OFF-AUTO-ON’ switch shall be in minimum three stack configuration, each stack having three positions with spring return from ‘ON’ to ‘Auto’ position and lockable in ‘OFF’ position by means of padlock.
- 7.5.2 The switch shall have sliding contact between ‘AUTO’ and ‘ON’ position. In ‘OFF’ position the contact shall be completely broken from ‘AUTO’ position.
- 7.6 **Push Buttons**
These shall be spring loaded, with a set of normally closed and open contacts. The push buttons for ‘start’ shall be shrouded type and coloured green while ‘stop’ push buttons shall be un-shrouded type and coloured red. Provision shall be made to padlock the ‘stop’ push button in ‘OFF’ position. The fixing ring shall be metallic white. An oil proof rubber cap shall preferably be provided.
- 7.7 The switches and push buttons shall conform to utilization category AC11/ DC11 as per IS/IEC:60947. The contact shall be rated to make, break and carry inductive current of 5 Amp. at 415 V AC and 1 Amp of 220V DC. The contact arrangement shall be as shown in the terminal drawings. Built in locks instead of padlocking are not acceptable.
- 7.8 **Indication Lamps**
- 7.8.1 LED type indication lamps shall be provided to indicate the various circuit conditions as shown in the terminal drawings.
- 7.8.2 The LEDs shall provide good illumination through a viewing angle of 180°. The LEDs shall have lumen output of 200 milli Candella in the axial direction.
- 7.8.3 The colour of the LED indication for various functions shall be as follows:-
- RED : For ‘ON’ Indication
GREEN : For ‘OFF’ Indication
WHITE : For “Ready for Service” Indication
- 7.9 **A.C. Ammeters**
The ammeter shall be flush mounting, moving iron spring controlled type, of accuracy class 1.5 as per IS:1248, with square face of minimum size 72 mm x 72 mm having scale range 0-240°. The ammeter shall be provided with uniform scale up to CT primary current and compressed end scale up to 6 times the CT primary current. Adjustable red pointer shall be provided to indicate the full load current of the motors. Zero adjusters shall be provided for operation from the front of the meter. All ammeters shall be operated through 1Amp. CTs only.

	TALCHER FERTILIZERS LIMITED TECHNICAL SPECIFICATION - LOCAL CONTROL STATION	PC183-TS-0817	0	
		Document No.	Rev	
		Sheet 6 of 8		

7.10 **D.C. Ammeters**

The D.C. ammeter shall be shunt operated. These shall be moving coil or moving iron type of accuracy class 1.5 as per IS: 1248.

7.11 **Terminal Blocks**

All control stations shall be provided with terminal blocks. Terminal blocks shall be located at a minimum distance of 50 mm from the bottom of the enclosure. The terminal blocks for the control station shall be suitable for conductor sizes of 2.5 mm². These shall be of pressure clamp type design mounted on the base channel. The minimum rating of terminal block shall be 16 Amp.

7.12 **Cable Glands**

The cables for the external connections, shall enter the terminal chamber through heavy duty double compression type rolled Aluminium cable glands suitable for 2.5 sq. mm PVC insulated, armoured, and PVC sheathed copper conductor 1.1 KV grade cables. The number and cores of control cables shall be as per requirement. The cable gland shall be fitted in a threaded hole.

8.0 PAINTING

8.1 The enclosure after suitable pre-treatment shall be painted with two coats of anti-rust paint followed by two coats of anticorrosive paint.

8.2 Epoxy based paint shall be used.

8.3 All paints shall be carefully selected to withstand tropical heat and extremes of weather. The paint shall not scale off, crinkle or be removed by abrasion due to normal handling.

8.4 Unless otherwise specified, the finishing shade shall be of light grey having shade no. 631 as per IS: 5.

9.0 TESTS AND INSPECTION

9.1 All equipment shall be routine tested as per relevant standards.

9.2 Additional tests, wherever specified, shall be carried out.

9.3 All the above mentioned tests shall be carried out in the presence of purchaser's representative. In addition, the equipment shall be subjected to stage inspection at works and inspection at site for final acceptance.

9.4 These inspections shall, however, not absolve the vendor from their responsibility for making good any defect which may be noticed subsequently.

10.0 DRAWINGS AND DOCUMENTS

10.1 Drawings and documents as per Annexure-I shall be supplied, unless otherwise specified.

10.2 All drawings and documents shall have the following descriptions written boldly.

- Name of client
- Name of consultant
- Enquiry / Order Number with plant / project name
- Code No. and Description

11.0 SPARES

11.1 Commissioning Spares : Commissioning spares, as required, shall be supplied with the main equipment. Item-wise list of recommended commissioning spares shall be furnished for information.

	TALCHER FERTILIZERS LIMITED TECHNICAL SPECIFICATION - LOCAL CONTROL STATION	PC183-TS-0817	0	
		Document No.	Rev	
		Sheet 7 of 8		

- 11.2 Spares for 2 Years Operation (Mandatory), as specified shall be supplied.
- 11.3 List of Recommend Spares (other than Mandatory Spares) alongwith recommended quantity and item-wise price shall be furnished.
- 11.4 All spare parts shall be identical to the parts used in the equipment.

12.0 PACKING

- 12.1 The local control stations shall be properly packed to safeguard against weather conditions and handling during transit. It shall be wrapped in polythene bags and an additional wrapping of bitumen paper shall also be provided to make it completely water proof before the equipment is packed in wooden crates.
- 12.2 The packing box shall contain a copy of the installation, operation and maintenance manual.



ANNEXURE - I

DOCUMENTATION FOR LOCAL CONTROL STATIONS

Sl. No.	Document Description	Documents Required (Y / N)		
		With Bid	For Approval	Final
1.	Specification Sheet	N	Y	Y
2.	Technical Particulars	N	Y	Y
3.	General Arrangement Drawings	N	Y	Y
4.	Schematic Diagrams	N	Y	Y
5.	Illustrative and Descriptive catalogues	N	N	Y
6.	Catalogues of bought out accessories	N	N	Y
7.	Spare parts list	N	N	Y
8.	Installation, Operation and Maintenance manual	N	N	Y
9.	Test certificates			
	a) Routine	N	N	Y
	b) Type (only for flameproof equipment)	N	N	Y
	c) For enclosure	N	N	Y
10.	Guarantee Certificates	N	N	Y

Note:

1. 4 hard copies & 1 soft copy shall be supplied for approval after order within 4 weeks from the date of LOI.
2. 8 hard copies & 2 soft copies in CD shall be submitted as final documents prior to despatch of the equipment. These shall be made in sets and supplied in fine plastic coated folder.

Y - Yes, N - No

	TALCHER FERTILIZERS LIMITED TECHNICAL SPECIFICATION - JUNCTION BOX	PC183-TS-0818	0
		Document No.	Rev
		Sheet 1 of 6	



TECHNICAL SPECIFICATION

JUNCTION BOX

CONTENTS

SECTION NUMBER	DESCRIPTION
1.0	SCOPE
2.0	STANDARDS TO BE FOLLOWED
3.0	SERVICE CONDITIONS
4.0	GENERAL DESIGN & CONSTRUCTIONAL FEATURES
5.0	SPECIAL FEATURES FOR JUNCTION BOXES FOR HAZARDOUS AREA
6.0	PAINTING
7.0	TESTS & INSPECTION
8.0	PACKING
9.0	DRAWINGS AND DOCUMENTS
10.0	SPARES
ANNEXURE - I	DOCUMENTATION FOR JUNCTION BOXES

	TALCHER FERTILIZERS LIMITED TECHNICAL SPECIFICATION - JUNCTION BOX	PC183-TS-0818	0	
		Document No.	Rev	
		Sheet 3 of 6		

1.0 SCOPE

- 1.1 This standard covers the technical requirements of design, manufacture, testing and inspection at works and delivery in well packed condition of junction boxes.
- 1.2 This standard shall be read in conjunction with relevant part of Design Philosophy - Electrical and other relevant references as specified their in.

2.0 STANDARDS TO BE FOLLOWED

- 2.1 The design, manufacture and testing of the equipment covered by this standard shall comply with the latest issue of relevant Indian standards unless otherwise specified. Equipment complying with equivalent IEC standards shall also be acceptable.
- 2.2 Flameproof & increased safety junction boxes shall in addition, comply with the requirement as laid down in IS: 2148 & IS: 6381 respectively.
- 2.3 The design and constructional features of the junction boxes offered shall also comply with the provision of latest issue of the Indian Electricity Rules and other relevant Statutory Rules & Regulations. The supplier shall, whenever necessary, make suitable modification in the equipment to comply with the above mentioned rules.
- 2.4 Wherever any requirement laid down in this standard differs from that in Indian Standard specifications, the requirement specified herein shall prevail.

3.0 SERVICE CONDITIONS

3.1 Ambient Conditions

These shall be as indicated in Design Philosophy - Electrical.

3.2 System Details

The details of power supply system shall be as indicated in Design Philosophy – Electrical.

4.0 GENERAL DESIGN & CONSTRUCTIONAL FEATURES

- 4.1 The junction boxes shall be dust and weather proof and suitable for installation outdoors without extra protection. The degree of protection shall be IP-55 as per IS/IEC:60529.
- 4.2 The junction boxes shall be of die cast aluminium alloy LM-6 with domed / suspension covers.
- 4.3 The casting of the junction boxes and their cover shall be pressure die cast. The casting shall be uniform and free from blow holes. All mechanical surfaces shall be free from burrs, dents and internal roughness.
- 4.4 All external hardware of diameter less than 8 mm shall be of stainless steel and those of diameter 8 mm and above shall be of mild steel cadmium plated or zinc passivated. For fibre glass enclosure Nylon PVC bolts of diameter 8 mm may be used.
- 4.5 The clearances and creepage distances shall be maintained inside the junction boxes as per relevant Indian standard.
- 4.6 The junction boxes shall be suitable for wall / structure / ceiling mounting and necessary arrangement for mounting the same shall be provided.
- 4.7 The junction boxes shall be provided with continuous gasket made of neoprene or synthetic rubber to prevent ingress of dust. The gasket shall be held in position in groove provided in the enclosure and shall be pressed all around uniformly by suitably shaped projection of the door. Gaskets simply glued to the surface are not acceptable.
- 4.8 The junction boxes housing terminal block shall be moulded type made of DMC / Fibre glass. Threaded terminals shall be made of brass (nickel plated or tinned) and provided

	TALCHER FERTILIZERS LIMITED TECHNICAL SPECIFICATION - JUNCTION BOX	PC183-TS-0818	0	
		Document No.	Rev	
		Sheet 4 of 6		

with two tightening threaded nuts and four washers all made of brass (nickel plated or tinned). The terminals shall have two shorting links each horizontally placed connecting three terminals.

- 4.9 The terminal block shall be fitted with junction boxes base by means of 2 nos. 1/2" long nickel plated brass screws.
- 4.10 The junction boxes shall be provided with two nos. external earthing terminals and 1 no. internal earthing terminal.
- 4.11 All live parts inside the junction boxes shall be insulated and shall withstand a test voltage of 2.5 KV for 1 minute.
- 4.12 The junction boxes shall be provided with heavy duty double compression type rolled Al cable glands to suit the cable entries.
- 4.13 Threaded blanking plugs shall be provided for junction boxes to plug out the entries not in use as indicated in bill of quantities enclosed.
- 4.14 The junction boxes shall be provided with a blank stainless steel tag plate fastened to the junction box top cover with two stainless steel screws. The plate shall be at least 25 mm wide, 100 mm long and 1 mm thick.
- 4.15 For flameproof / increased safety junction boxes, the manufacturer shall submit copies of test certificates from statutory authorities clearly stating that the junction boxes as well as cable glands / blanking plugs are suitable for hazardous area.
- 4.16 **15 Amp. Junction Box**
- 4.16.1 The junction boxes shall be 4 way dome cover type.
- 4.16.2 The dimensions of the junction boxes with their cover and accessories shall be generally as per PDS: E-547.
- 4.16.3 The junction boxes housing terminal block shall be moulded type made of DMC / Fibre glass as per Drg. no. PDS: E-557.
- 4.17 **63 Amp. Junction Box**
- 4.17.1 The junction boxes shall be 3 / 4 way dome cover type.
- 4.17.2 The minimum internal diameter of the box shall be 240 mm.
- 5.0 **SPECIAL FEATURES FOR JUNCTION BOXES FOR HAZARDOUS AREA**
- 5.1 For increased safety junction boxes, the terminals shall be provided with positive locking device against loosening.
- 5.2 The enclosure shall be in addition, of increased safety execution, Exe, as per relevant standard and shall be suitable for installation in classified hazardous area.
- 5.3 The junction boxes shall be liberally dimensioned in order to avoid temperature rise inside the enclosure which may damage the insulating materials or gaskets employed therein.
- 5.4 Cables shall enter the terminal box through increased safety compression type cable glands. From the terminal chamber to the main enclosure, the connections shall be made through proper bushings.
- 5.5 An additional earthing terminal inside the terminal chamber shall be provided.
- 5.6 The junction boxes shall be provided with Brass-Nickel plated shorted links. The terminal block shall be made of non-hygroscopic compound. Bakelite / Hylam shall not acceptable.
- 5.7 All screws / bolts and nuts shall be of stainless steel.

	TALCHER FERTILIZERS LIMITED TECHNICAL SPECIFICATION - JUNCTION BOX	PC183-TS-0818	0	
		Document No.	Rev	
		Sheet 5 of 6		

5.8 Junction boxes and cable glands must be certified by Statutory Authorities for use in the specified hazardous area. Equipments certified by overseas authorities shall obtain certificate of compliance / letter of opinion from respective statutory authorities.

5.9 Type Test certificates for increased safety type junction boxes and cable glands along with blanking plugs shall be supplied.

6.0 PAINTING

6.1 Epoxy based electrostatic powder coating paint shall be provided on exterior surface while the interior of junction boxes shall be painted with anti-condensate paint. The painting shall be able to withstand corrosive atmosphere.

6.2 Unless otherwise specified, the finishing shade shall be grey having shade no. 632 as per IS-5.

6.3 The terminal block of junction boxes shall be painted with Red, Yellow, Blue & Black colour for phase indication.

7.0 TESTS AND INSPECTION

7.1 The junction boxes shall be routine tested as per relevant standards.

7.2 Additional tests, wherever specified, shall be carried out on one unit of each rating.

7.3 The procedure & extent of the physical checks, routine & type test shall be governed by Quality Assurance Plan mutually agreed and approved by Inspection Authority.

7.4 All the above mentioned tests shall be carried out in the presence of purchaser's representative. In addition, the equipment shall be subjected to stage inspection at works and inspection at site for final acceptance.

7.5 These inspections shall, however, not absolve the vendor from their responsibility for making good any defect which may be noticed subsequently.

8.0 PACKING

Each junction box and cable gland shall be suitably packed and protected from damage due to transportation, loading and unloading. Threaded fittings shall have plastic caps to protect the threading.

9.0 DRAWINGS AND DOCUMENTS

9.1 Drawings and documents as per Annexure-I shall be supplied, unless otherwise specified.

9.2 All drawings and documents shall have the following descriptions written boldly:

- Name of client
- Name of consultant
- Enquiry / order number with plant / project name
- Motor Code No. and Description

10.0 SPARES

10.1 Commissioning Spares : Commissioning spares, as required, shall be supplied with the main equipment. Item-wise list of recommended commissioning spares shall be furnished for information.

10.2 Spares for 2 Years Operation (Mandatory), as specified shall be supplied.

10.3 List of Recommend Spares (other than Mandatory Spares) alongwith recommended quantity and item-wise price shall be furnished.

10.4 All spare parts shall be identical to the parts used in the equipment.

ANNEXURE - I

DOCUMENTATION FOR JUNCTION BOXES

Sl. No.	Document Description	Documents Required (Y / N)		
		With Bid	For Approval	Final
1.	Specification Sheet	N	Y	Y
2.	Technical Particulars	N	Y	Y
3.	Certified dimensional drawing, including mounting details	N	Y	Y
4.	Drawing showing constructional details	N	Y	Y
5.	Illustrative and Descriptive catalogues	N	N	Y
6.	Spare parts list	N	N	Y
7.	FLP/Exe certificates for junction boxes and terminals conforming to IEC/ISS (CMRI, CCE, DGFASLI and BARC for terminals)	N	N	Y
8.	Certificate for weather proof construction for junction boxes as per IPW-55	N	N	Y

Note:

1. 4 hard copies & 1 soft copy shall be supplied for approval after order within 4 weeks from the date of LOI.
2. 8 hard copies & 2 soft copies in CD shall be submitted as final documents prior to despatch of the equipment. These shall be made in sets and supplied in fine plastic coated folder.

Y - Yes, N - No

	TALCHER FERTILIZERS LIMITED TECHNICAL SPECIFICATION - ELECTRICALS FOR OVERHEAD CRANES & HOISTS	PC183-TS-0819	0	
		Document No.	Rev	
		Sheet 1 of 10		

TECHNICAL SPECIFICATION

ELECTRICALS FOR OVERHEAD CRANES & HOISTS

CONTENTS

SECTION NUMBER	DESCRIPTION
1.0	SCOPE
2.0	STANDARDS TO BE FOLLOWED
3.0	SERVICE CONDITIONS
4.0	GENERAL DESIGN AND CONSTRUCTIONAL REQUIREMENTS
5.0	EQUIPMENT SPECIFICATION
6.0	CABLES, CABLE TERMINATION AND CONNECTIONS
7.0	EARTHING
8.0	CONTROL DESK / CONTROL STATION
9.0	PAINTING
10.0	MAKE OF ELECTRICAL ITEMS
11.0	TESTS AND INSPECTION
12.0	INSTALLATION, TESTING AND COMMISSIONING
13.0	DRAWINGS AND DOCUMENTS
ANNEXURE - I	DOCUMENTATION FOR ELECTRICALS FOR OVERHEAD CRANES & HOISTS

	TALCHER FERTILIZERS LIMITED TECHNICAL SPECIFICATION - ELECTRICALS FOR OVERHEAD CRANES & HOISTS	PC183-TS-0819	0	
		Document No.	Rev	
		Sheet 3 of 10		

1.0 SCOPE

- 1.1 This standard covers the technical requirements of design, engineering, manufacture, testing at works, supply at site, erection, site testing and commissioning of the complete electrical equipment and accessories as required for the overhead travelling crane and hoists.
- 1.2 This standard shall be read in conjunction with relevant mechanical specifications, other relevant standards / specifications.
- 1.3 The scope of work shall include but not limited to the following items:
- i) Drive motors
 - ii) Starting resistors (in case of slip ring motors)
 - iii) Power control panel
 - iv) Control stations
 - v) Limit switches
 - vi) Electromagnetic brakes
 - vii) Power and control cables with accessories
 - viii) Earthing of all equipment
 - ix) All other items, not specified but, required for safe and proper operation
- 1.4 The owner shall provide one no. medium voltage feeder for each crane / hoist and terminate the feeder cable in an isolator located at one end of the bay at a height of 1.5 m from the operating floor. The vendor shall indicate the exact power requirement (running and peak) to enable the owner to size and provide the power supply feeder.
- 1.5 Further distribution of power from this isolator onwards shall be in the vendor's scope.

2.0 STANDARDS TO BE FOLLOWED

- 2.1 The design, manufacture, testing and installation of the equipment shall comply with the latest issue of IS-6547, IS-807 and other relevant Indian Standard specifications and codes of practices. Equipment complying with equivalent IEC standards shall also be acceptable.
- 2.2 The equipment and installation shall also comply with the provisions of latest issue of Indian Electricity rules and other statutory acts and regulations.
- 2.3 Wherever any requirement, laid down in this standard, differs from that in Indian Standard Specification, the requirement specified here-in shall prevail.

3.0 SERVICE CONDITIONS

3.1 Ambient Conditions

These shall be as indicated in Design Philosophy - Electrical.

3.2 System Details

These shall be as indicated in Design Philosophy - Electrical.

- 3.3 The owner shall provide only three phase power at the specified medium voltage. For lighting, control and plug supply the vendor shall provide necessary single phase step-down transformers.

	TALCHER FERTILIZERS LIMITED TECHNICAL SPECIFICATION - ELECTRICALS FOR OVERHEAD CRANES & HOISTS	PC183-TS-0819	0	
		Document No.	Rev	
		Sheet 4 of 10		

3.4 All the electrical equipment shall be so designed that enable the crane / hoist to operate at its rated capacity and specified duty cycle with the system variation under the ambient conditions without exceeding the permissible temperature rise and without any detrimental effect on any part.

4.0 GENERAL DESIGN AND CONSTRUCTIONAL REQUIREMENTS

4.1 The electrical system and installation shall be designed as per latest practice to provide maximum reliability, flexibility, safety to personnel and equipment and ease of operation and maintenance.

4.2 All equipment shall have adequate and standard ratings as per ISS.

4.3 All electrical equipment to be located in indoor plant area shall be enclosed in dust, damp and vermin proof enclosure equivalent to IP-54 as per IS/IEC:60529.

4.4 Equipment to be located outdoor shall be weather proof and have IPW-55 protection as per IS/IEC:60529 and shall also be provided with canopy as far as practicable.

4.5 The equipment to be located in hazardous area shall have additional protection as follows:

- a) Zone – I All the equipment shall be in flameproof execution.
- b) Zone – II The equipment producing sparks under normal operation shall be in flameproof execution and others shall be in increased safety execution.

The equipment shall be suitable for the enclosure group and temperature class as indicated in Design Philosophy - Electrical. The equipment selected shall conform to relevant Indian Standard Specification and must be certified by Central Mining Research Institute, Dhanbad or any other statutory authority for use in the specified hazardous area.

4.6 The pendant push button shall be light weight enclosure of aluminium/ polypropylene etc. In case of hazardous areas, the loop between the pendant push button and the crane control panel shall be made intrinsically safe by using suitable isolators. Alternatively certified flame proof components and increased safety terminals can be housed in the hose proof aluminium / polypropylene enclosure.

4.7 Special care shall be taken to ensure that the parts to be opened for inspection and maintenance retain their dust tightness even after repeated opening and closing operations.

4.8 All mating surfaces shall be properly machined. Neoprene gaskets shall be used for dust and weather proofing. The gaskets shall be without any discontinuity.

4.9 Only non-hygroscopic materials shall be used for insulation. All insulation shall be specially impregnated to withstand ambient conditions and atmospheric pollution.

4.10 All live parts shall be adequately protected to prevent inadvertent or accidental contact.

4.11 The minimum clearance and creepage distance of M.V. equipment shall be 20 and 28 mm respectively and shall be positively maintained after connections.

4.12 All external hardware of diameter less than 8 mm shall be of stainless steel and those of diameter 8 mm and above shall be of mild steel cadmium plated or zinc passivated.

4.13 Earthing terminals complete with sockets and identification marks shall be provided on the enclosure of all electrical equipment. The number of terminals shall be two for equipment rated above 240V and one for those rated 240V and below. Additional internal earthing arrangement shall be provided for flameproof equipment.

	TALCHER FERTILIZERS LIMITED TECHNICAL SPECIFICATION - ELECTRICALS FOR OVERHEAD CRANES & HOISTS	PC183-TS-0819	0	
		Document No.	Rev	
		Sheet 5 of 10		

- 4.14 All equipment shall be provided with stainless steel name plates containing the particulars as per relevant IS along with the description and code nos. of equipment
- 4.15 All the electrical equipment shall be provided with separate terminal box, heavy duty double compression type rolled aluminium cable glands, proper crimping lugs and anti-vibration type terminals suitable for the cable sizes required.
- 4.16 Enclosure for limit switches, pendant push button, junction boxes and magnets etc. shall be of cast aluminium. Enclosure for control panel, transformer and resistors may be of sheet steel. The thickness of the sheet steel for the enclosure shall not be less than 2.5 mm. All enclosures shall be suitably painted to withstand atmospheric pollution as mentioned in the Design Philosophy - Electrical.
- 4.17 The doors or inspection covers shall be provided with threaded knobs or butterfly nuts made of plated carbon steel. Copper or copper alloys shall not be used outside the enclosures.
- 4.18 To facilitate maintenance and testing of all electrical equipment:
- a) Disconnecting links shall be provided where necessary.
 - b) All cable lugs and terminals shall be numbered in a permanent form corresponding to the wiring diagram.
 - c) Easy access and adequate working space shall be provided around all motors, panels, limit switches etc. safety railing shall be provided, where necessary.

5.0 EQUIPMENT SPECIFICATION

5.1 Power Connection

- 5.1.1 The main supply shall be obtained by flexible cable or otherwise as per requirement.
- 5.1.2 In case of overhead bare conductors, they shall be of copper and mounted on side of the crane bridge. Four number of gunmetal type current collector with renewable carbon inserts shall be used for power connection. One end of the bare conductor shall be connected to the owner's isolator by means of fixed cable.
- 5.1.3 In case of flexible cable arrangement, the cable shall be connected at one end of the crane and the other end to owner's isolator. The cable shall be hung at intervals by festooned type arrangement.
- 5.1.4 In either case the power fed to the trolley shall be by means of flexible cables fixed and supported by festooned arrangement.
- 5.1.5 The arrangement of fixing and supporting the flexible cables shall be such that the cable is not damaged due to repeated travelling of the crane and trolley. Supporting G.I. wire shall be provided, wherever required.
- 5.1.6 The collector rollers and shoes shall be designed to avoid sparking.

5.2 Power Control Panel

- 5.2.1 The panel shall house all the necessary electrical equipment for distribution of power and control of individual equipment / circuit.
- 5.2.2 The panel shall be totally enclosed, floor mounting, dead front, free standing type in cubicle construction.
- 5.2.3 The panel shall house the following:
- i) For incoming supply
 - Triple pole switch fuse units
 - Supply 'ON' signal lamps (LED Type)

	TALCHER FERTILIZERS LIMITED TECHNICAL SPECIFICATION - ELECTRICALS FOR OVERHEAD CRANES & HOISTS	PC183-TS-0819	0	
		Document No.	Rev	
		Sheet 6 of 10		

The above switch shall cut off all power driven and associated equipment on the crane except lighting and plug supply circuits.

- ii) For motors
 - Reversing type starter with necessary contactors and timers.
 - Other controlling relays and devices.
- iii) For lighting, control and plug supply
 - Single phase transformers
 - Isolating switch fuse units on primary and secondary sides.

5.2.4 All switches shall be motor duty type (AC 23) and rated for 1.5 times of the full load current of the circuit. The incoming switch shall be interlocked with the panel door.

5.2.5 All contactors shall be air break type and of AC4 utilization categories. The thermal rating of the contactor shall be 1.5 times the full load current of the circuit.

5.2.6 The power contactors shall be interlocked electrically and mechanically so that there shall be no possibility of simultaneous operation of two contactors for the same motor.

5.2.7 Electrical interlock shall be provided between main hoist and micro hoist motors.

5.2.8 All thermal overload relays shall have in-built single phasing feature and ambient compensated, separately mounting and hand reset type. The reset push bottom for thermal overload relays shall be provided on the cover of the control panel so that it is possible to reset the relay from outside without opening the cover of the panel. Also indication shall be provided for hoisting/travel motors tripping on overload.

5.2.9 The panel shall be installed on properly levelled base frame fabricated out of channels of suitable size.

5.3 Motors

5.3.1 The design and specification of all motors shall comply with requirements stated elsewhere in the specifications.

5.3.2 The power rating of the motors shall be 25% higher than the design requirement of the driven equipment, under the specified service and duty conditions.

5.3.3 All motors shall preferably be of squirrel cage type and so designed that smooth acceleration or deceleration of the load is possible without any jerks. Further a maximum displacement of 2 mm when starting and stopping the motor in quick succession shall be guaranteed.

5.3.4 The motors for main hoist and micro hoist shall be suitable for intermittent duty type S4 with 60% C.D.E. and 300 starts / stops per hour. The motors for long travel and cross travel shall be suitable for S2 duty for 60 minutes.

5.3.5 The motors shall be so located that all parts are accessible for inspection and maintenance without affecting normal ventilation.

5.4 Brakes

5.4.1 The brakes for each motor shall be suitable for duties as specified below:

- a) Main / Micro hoist S4 duty
- b) Long / cross travel S2 duty

5.4.2 The coil of the brake shall be wound with fibre glass covered annealed copper conductor suitable for class H application. An additional covering with glass taps shall

	TALCHER FERTILIZERS LIMITED TECHNICAL SPECIFICATION - ELECTRICALS FOR OVERHEAD CRANES & HOISTS	PC183-TS-0819	0	
		Document No.	Rev	
		Sheet 7 of 10		

be provided over the coil. The maximum temperature of the coil for continuous operation shall be limited to 140° C. The coil shall be vacuum impregnated.

5.4.3 For other design details refer mechanical engineering standard.

5.5 **Limit Switches**

5.5.1 Limit switches of both shunt and series type shall be used in control and power circuit.

5.5.2 These shall be heavy duty type and of sturdy construction in cast aluminium enclosure.

5.5.3 The mode of operation of these limit switches shall be positive and direct acting type.

5.5.4 The contacts shall be rated 50% more than the required current ratings.

5.5.5 The width of the roller of limit switches shall be sufficient to avoid slippage of contact with the striker.

5.5.6 The striker provided for operating these limit switches shall have rubber padding on surface which will make contact with roller to actuate it. The limit switches and its roller should be designed to withstand the frequent impact pressure.

5.5.7 Switches in which the contacts are operated by spring or gravity or both on the withdrawal of a chain or similar devices, shall not be used.

5.6 **Transformers**

5.6.1 These shall be of dry type, class H insulated, air cooled, double wound and mounted inside the panel.

5.6.2 The transformers shall be provided with switch fuse unit on their primary side of suitable rating. One side of secondary windings of the transformers shall be earthed and other shall be provided with fuse of suitable rating.

5.7 The rating of the transformers shall be at least 2.5 times the continuous load.

5.8 **Junction Box**

5.9 Junction boxes shall be of cast aluminium construction and adequately sized to enable easy termination of cables.

5.10 **Hand Lamps**

5.10.1 Provision shall be made in the crane for use of hand lamps by installing 2 nos. 24 volts, 2 pin metal clad switch sockets. One of the sockets shall be on the bridge (outside the panel) and the other on the trolley.

5.10.2 The transformer primary and secondary voltage shall be 250V and 25V respectively.

6.0 **CABLES, CABLE TERMINATION AND CONNECTIONS**

6.1 The cables used for fixed wiring shall be 1.1 KV grade PVC insulated armoured and PVC sheathed overall, and shall conform to IS: 1554 Part-I.

6.2 The flexible cable used for power supply to crane and also for interconnection of equipment mounted on moving and fixed part of the crane shall be 1.1 KV grade heavy duty type.

6.3 All cables shall be properly laid and supported with adequately sized aluminium clamps at 500 mm interval.

6.4 Cable entry on all electrical equipment e.g. panels, motors, limit switches, brakes, junction boxes etc. shall be through double compression type rolled aluminium cable glands.

6.5 The internal power wiring of panels shall be carried out by PVC insulated stranded copper flexible cable.

	TALCHER FERTILIZERS LIMITED TECHNICAL SPECIFICATION - ELECTRICALS FOR OVERHEAD CRANES & HOISTS	PC183-TS-0819	0	
		Document No.	Rev	
		Sheet 8 of 10		

- 6.6 The wiring shall be arranged in a neat fashion and supported on PVC channel or PVC stand of screw support.
- 6.7 For equipment mounted on the doors, the wiring shall be carried out with flexible stranded copper cables in such a way that no strain is put on the wires and equipment when the door is opened for inspection and maintenance.
- 6.8 External looping of wires shall be done through separate dust tight junction boxes.
- 6.9 The sizes of power cables to be used shall be subject to owner's approval. The minimum size of power and control cables shall be 16 sq. mm (Al) & 2.5 sq. mm (Cu) respectively.

7.0 EARTHING

- 7.1 The earthing of all electrical equipment shall be carried out in accordance with IS: 3043.
- 7.2 The enclosures of electrical equipment shall be connected to an aluminium earth ring on the crane which in turn shall have effective electrical connection with the bridge.
- 7.3 The crane bridge shall be earthed through the bridge travel runway rails on both sides which in turn shall be earthed to owner's earth ring located on the ground floor.
- 7.4 Further the power supply cable for the crane shall have an additional conductor for earth connection. Both sides of this conductor shall be earthed.
- 7.5 All earth conductors shall be of aluminium.
- 7.6 This size of earth conductor shall be equal to half the size of the power conductor subject to a minimum size of 10 sq. mm.

8.0 CONTROL DESK / CONTROL STATION

- 8.1 The crane shall be controlled either from the floor by means of a pendant control station or from bridge mounted control desk as indicated in the mechanical data sheet.
- 8.2 In either case, the units shall have the following control devices:
- Main off push button with padlocking arrangement.
 - Indication lamps for supply 'ON'
 - Control push buttons, as specified in the mechanical data sheet.
 - All other devices required for safe and proper operation of the crane / hoist.
- 8.3 All push buttons shall be momentary contact type, coloured as per IS: 6875 and have 1 NO and 1 NC contacts.
- 8.4 The bridge mounted control desk, where specified, shall be of totally enclosed and dust tight construction. All controlling equipment shall be mounted on the top. It shall be located at most convenient location to allow movement of the operator. The installation shall be equipped with adjustable chair, fan, light and main isolating switch.
- 8.5 The pendant control station, where specified, shall be in a single enclosure and in totally enclosed dust tight execution. The unit shall be suspended and supported from the bridge platform by flexible steel wire rope. The connection shall be made with a multi core flexible copper conductor cable and shall have 20% spare cores. One core shall be provided for earth connection of the circuit.

9.0 PAINTING

Enclosures of all electrical equipment shall be painted with two coats of epoxy based primers after suitable pre-treatment. Two coats epoxy based paint of approved colour shall be provided.

	TALCHER FERTILIZERS LIMITED TECHNICAL SPECIFICATION - ELECTRICALS FOR OVERHEAD CRANES & HOISTS	PC183-TS-0819	0	
		Document No.	Rev	
		Sheet 9 of 10		

10.0 TESTS AND INSPECTION

- 10.1 All equipment shall be routine tested as per relevant Indian Standard Specifications.
- 10.2 Additional tests, wherever specified, shall be carried out on one equipment of each rating.
- 10.3 All the above mentioned tests shall be carried out in presence of owner's representative.
- 10.4 The owner's inspection shall, however, not absolve the vendor from his responsibility for making good any defects which may be noticed subsequently.
- 10.5 Despatch of materials shall be subject to written consent of owner or his representative.

11.0 INSTALLATION, TESTING AND COMMISSIONING

- 11.1 The vendor shall undertake installation of all electrical equipment in accordance with latest code of practices, in conformity with recommendation of the respective equipment manufacturer, drawings approved by the owner or owner's representative, direction of Engineer-in-charge, statutory regulations and to the entire satisfaction of the owner.
- 11.2 The vendor shall arrange all the necessary erection tools and tackles, testing and measuring instruments and shall supply the required erection materials including structural steel.
- 11.3 Following tests shall be specifically conducted before commissioning in presence of owner's representative. All the test results shall be recorded and submitted to the owner.
- i) Insulation test.
 - ii) Continuity test.
 - iii) High voltage test.
 - iv) Simulation test.

12.0 DRAWINGS AND DOCUMENTS

- 12.1 Drawings and documents as per Annexure-I shall be supplied unless otherwise specified.
- 12.2 All drawings and documents shall have the following description written boldly :
- Name of client
 - Name of consultant
 - Enquiry / Order Number with plant / project name
 - Code No. and Description

13.0 SPARES

- 13.1 Commissioning Spares : Commissioning spares, as required, shall be supplied with the main equipment. Item-wise list of recommended commissioning spares shall be furnished for information.
- 13.2 Spares for 2 Years Operation (Mandatory), as specified shall be supplied.
- 13.3 List of Recommend Spares (other than Mandatory Spares) alongwith recommended quantity and item-wise price shall be furnished.
- 13.4 All spare parts shall be identical to the parts used in the equipment.

ANNEXURE - I

DOCUMENTATION FOR ELECTRICALS FOR OVERHEAD CRANES & HOISTS

Sl. No.	Description	Documents Required (Y / N)		
		With Bid	For Approval	Final
1.	Specification sheet and technical particulars	N	Y	Y
2.	Composite schematic diagram	N	Y	Y
3.	Dimensional drawing showing the mounting details and general arrangement for the following equipment			
	a) Motors	N	Y	Y
	b) Power control panel	N	Y	Y
	c) Control station	N	Y	Y
	d) Limit switches etc.	N	Y	Y
4.	Down shop lead and power supply arrangement with civil scope.	N	Y	Y
5.	Inter-connection with terminal diagram and cable details	N	Y	Y
6.	Operating and maintenance instruction manual	N	N	Y
7.	Catalogues of bought out items	N	N	Y
8.	Test certificates	N	N	Y

Note:

- 4 hard copies & 1 soft copy shall be supplied for approval after order within 4 weeks from the date of LOI.
- 8 hard copies & 2 soft copies in CD shall be submitted as final documents prior to despatch of the equipment. These shall be made in sets and supplied in fine plastic coated folder.

Y - Yes, N - No

- The tenderer shall also quote for any other spares as deemed necessary to be kept in stock for stipulated time.

	TECHNICAL SPECIFICATION - DIESEL GENERATOR SET	PC183-TS-0839	0	
		Document No.	Rev	
		Sheet 1 of 45		

TECHNICAL SPECIFICATION

DIESEL GENERATOR SET

 पी डी आई एल PDIL	TECHNICAL SPECIFICATION - DIESEL GENERATOR SET	PC183-TS-0839	0	
		Document No.	Rev	
		Sheet 2 of 45		

CONTENTS

SECTION NUMBER	DESCRIPTION
1.0	SCOPE
2.0	STANDARDS TO BE FOLLOWED
3.0	SERVICE CONDITIONS
4.0	DESIGN & OPERATIONAL REQUIREMENT
5.0	EQUIPMENTS SPECIFICATION
6.0	DIESEL ENGINE
7.0	FUEL OIL SYSTEM
8.0	JACKET COOLING SYSTEM
9.0	LUBE OIL SYSTEM
10.0	STARTING SYSTEM
11.0	AIR INTAKE AND EXHAUST SYSTEM
12.0	GOVERNING SYSTEM
13.0	DG CONTROL PANEL
14.0	GENERATOR
15.0	PERFORMANCE REQUIREMENTS
16.0	EXCITATION SYSTEM AND VOLTAGE REGULATION
17.0	TERMINAL BOXES
18.0	MODES OF OPERATION
19.0	DG AMF Cum Control Panel
20.0	ACCESSORIES
21.0	ACCOUSTIC ENCLOSURE
22.0	DG SETS RUNNING PHILOSOPHY
23.0	BASE FRAME
24.0	AVM PADS
25.0	PIPING WORKS
26.0	PAINTING
27.0	TOOL KIT
28.0	TESTS & INSPECTION
29.0	SPARES
30.0	PACKING
31.0	DRAWING AND DOCUMENTS
ANNEXURE - I	DOCUMENTATION FOR DIESEL GENERATOR SET

	TECHNICAL SPECIFICATION - DIESEL GENERATOR SET	PC183-TS-0839	0	
		Document No.	Rev	
		Sheet 3 of 45		

1.0 SCOPE

1.1 This standard covers the technical requirements of design, engineering, manufacture, assembly, testing at works and delivery in well packed condition of diesel generator set (D.G. Set) complete with all required accessories and control equipment to supply continuous electrical power.

The emergency generator and associated electrics shall be complete with following but not limited to :

- Alternator with brushless excitation system complete with AVR or as per OEM's standard design
- Generator control panel to include AMF System, Auto/Manual control, synchronization panel and auxiliary devices, battery charger.
- Generator breaker and protection relay
- AVM pads, Acoustic enclosure

1.2 This standard is applicable for D.G. set having rating more than 500 KVA.

1.3 The control panel for DG set shall be provided with Auto/manual starting/stopping facilities.

1.4 This specification shall be read in conjunction with all the relevant part of Design Philosophy – Electrical and Datasheet .

1.5 The Diesel Generator Set shall be outdoor type complete with suitable acoustic enclosure, to limit noise level shall be as per CPCB and State pollution control boards norms, whichever is more stringent, manually & automatically operated AMF circuitry and designed for specified Prime Power rating with an overload of 10% of the rated output for 1 hour in 12 hours of running operation. The Diesel Generator Sets shall be placed in a Shed (Shed by Owner). The scope of supply shall include, but not limited to the following:

- a) Diesel engine, complete with all the required accessories and components.
- b) Generator set, for operation with the above diesel engine, complete with all the required accessories and components.
- c) Coupling between diesel engine and generator set complete with guard.
- d) Engine flywheel, if required, with starter ring and guard.
- e) Fuel oil system comprising of fuel oil tank, supply pump, filter, piping, valves, fittings etc.
- f) Air intake system comprising of air blower (as applicable) , air filter, turbo charger etc.
- g) Lubrication oil system comprising of lube oil pump, filter, cooler, piping, valves, fittings etc.
- h) Jacket cooling system comprising of engine mounted radiator, water circulation pump, necessary piping and fittings etc.
- i) Starting system complete with battery, battery charger, starter motor, control system etc.
- j) All inter connecting piping, valves and fittings up to the battery limits.
- k) Torsional vibration damper at the free end of the crank shaft.

	TECHNICAL SPECIFICATION - DIESEL GENERATOR SET	PC183-TS-0839	0	
		Document No.	Rev	
		Sheet 4 of 45		

- l) Speed regulation system.
 - m) Acoustic enclosure for DG Set with an "Emergency-off" Push Button provided on the enclosure.
 - n) Platforms, walkways, stairs and hand racks, as required, for adequate access during operation and maintenance.
 - o) A common base frame suitable for assembly of engine, radiator and alternator with there accessories. Anti vibration mounting pads, foundation bolts (if required) shall also be supplied. Base frame shall be designed for transportation of above items duly assembled on it.
 - p) Exhaust manifold complete with silencers, metallic expansion bellows and piping
 - q) All necessary instruments for monitoring and safe starting, running and stopping of the DG set their auxiliaries complete with tubing and cabling.
 - r) AMF cum Control panel along-with DG breaker panel.
 - s) NIS/ NER panel with vacuum Contactor for each DG Set.
 - t) Cabling material between control panel and all equipment within the battery limit including cables, racks, earthing terminating materials etc.
 - u) All safety and protective devices.
 - v) Electrically operated Turning Gear Motor (DC powered), as required. .
 - w) All other items not specified here but, necessary for safe, satisfactory and uninterrupted operation of DG set.
 - x) Set of special tools and tackles required for installation and maintenance as required and recommended by OEM.
 - y) Spare parts as specified.
 - z) All other services as required.
 - aa) These DGs shall feed to Main DG Power Supply Board. Emergency Power Distribution Switchboard shall have 2 Nos. incomers from Main DG Power Supply Board and shall feed emergency load of Coal Gasification Plant and other Offsite & Utilities of entire fertiliser complex.
- 1.6 Offered DG set shall also comply with CPCB/State Pollution Control Board norms/standards (whichever is more stringent) regarding emission & Noise. Necessary certificate regarding this shall be furnished by Contractor.
- 1.7 DG Set shall be designed to cater the non-linear loads i.e. VFD driven pump therefore effects of harmonics on DGs shall be considered while designing.
- 1.8 Erection, testing and commissioning of the above shall be carried out by Contractor.
- 1.9 Bidder/OEM shall have testing facilities for first stage factory acceptance tests specified in Cl. No. 28.8 i),ii) & iii) which include general visual check. Partial load test (for at least two hours of running for each DG set), functional checks and routine testing of DG set for each one of the assembled DG set.
- 2.0 STANDARDS TO BE FOLLOWED**
- 2.1 The design, manufacture and testing of the equipment covered by this specification shall comply with the latest issue of the following codes and other relevant Indian standard specifications unless otherwise specified. Equipment complying with equivalent IEC standards shall also be acceptable.
- i) BS 649 - Diesel engines for general purpose.

	TECHNICAL SPECIFICATION - DIESEL GENERATOR SET	PC183-TS-0839	0	
		Document No.	Rev	
		Sheet 5 of 45		

- ii) IS:4722 - Rotating electrical machines
- iii) IS:7451 - Reciprocating internal combustion engines
IS: 4691 - Degree of protection provided by enclosures for rotating electrical machines.
- iv) IS: 10002 - Performance requirements for constant speed compression Ignition (diesel) engine for general purpose (above 20KW)
- v) IS-10000 - Methods of test for internal combustion engine.
- vi) IS: 7132 - Guide for testing of Synchronous Machine.
- vii) IS: 1600 - Type testing of constant speed internal combustion engine.
- viii) IS: 1601 - Performance of constant speed internal combustion engine for general purpose.
- ix) IS:12065 - Permissible limits of noise levels for rotating electrical machine
- x) IS:12075 - Mechanical Vibration of rotating electrical machine with shaft heights 56 mm and higher-measurements, evaluation and limits of vibration severity.
- xi) ISO:8528 - Reciprocating IC Engine driven AC generating sets
- xii) ISO: 3046 - Reciprocating internal combustion engines.
- xiii) OISD: 244 - Storage and Handling of Petroleum Products at Depots and Terminals including standalone crude oil storage facility
- xiv) ASME codes.
- xv) IS/IEC:60034 - Rotating Electrical Machines - Specification.
- xvi) Oil coolers as per TEMA class "C" / OEM Standard Design
- xvii) IS:803 Code of practice for design, fabrication and erection of vertical mild steel cylindrical welded oil storage tanks
- xviii) ISO-15550 Internal combustion engines-Determination and method for the measurement of engine power-General requirement
- xix) IS : 7372 - Lead acid storage battery for motor vehicle
- xx) Latest CPCB & State Pollution Control guidelines
- xxi) Any other standards/codes (BS, IS & equivalent International Standards) applicable.

- 2.2 Equipment designed and manufactured to other national standards shall be acceptable provided they are in no way inferior to the above mentioned standards. The Contractor shall supply English version of the relevant standard in such case.
- 2.3 The design and operational features of the equipment offered shall also comply with the provisions of latest issue of the Indian Electricity Rules and other statutory regulations. The Contractor shall, wherever necessary, make suitable modification in the equipment to comply with the above.
- 2.4 Wherever any requirement, laid down in this standard, differs from that in Indian standard / IEC, the requirement specified here in shall prevail.
- 2.5 DG set shall comply with Environment (Protection) Rules, 1986, Environment (Protection) Second Amendment Rules, 2002 & Environment (Protection) Third Amendment Rules, 2013 for mentioned capacity therein. A conformance label as per rules to be affixed on the acoustic enclosure.

	TECHNICAL SPECIFICATION - DIESEL GENERATOR SET	PC183-TS-0839	0	
		Document No.	Rev	
		Sheet 6 of 45		

3.0 SERVICE CONDITIONS

3.1 Ambient Conditions

These shall be as indicated in Design Philosophy – Electrical.

3.2 System Details

These shall be as indicated in Design Philosophy – Electrical.

4.0 DESIGN & OPERATIONAL REQUIREMENT

4.1 The D.G. set shall be suitable for “black start” operation. The equipment offered shall be suitable for operating at their rated capacity under the ambient conditions and voltage & frequency variations indicated in Design Philosophy – Electrical, without exceeding the temperature rise limits specified in relevant standards and without any detrimental effect on any part.

4.2 The D.G. set shall be designed for prime power rating with minimum average loading of 85% of rated prime power as per ISO 8528 and have the capability to run at 110% of the Prime power rating for one hour in every 12 hrs.

4.3 Besides monitoring of parameters of synchronous generator in Distributed Control System, the provision shall be made in generator control panel to monitor the following electrical parameters.

- Power (MW), Voltage, Current, Frequency, Power factor, Field Voltage, Field Current.
- An electronic tri-vector meter with maximum demand indicator shall be provided in generator control panel to measure KWH, KVARH, KVAH and maximum demand in KVA.

4.4 Generator and associated electrics shall be suitable for parallel operation amongst themselves or with other generator sets, or with other source (Grid supply) at operating voltage and under the load conditions upto rated value.

4.5 DG shall be suitable for operating in a tropical climate and under the ambient condition as specified in the Design Philosophy – Electrical.

5.0 EQUIPMENTS SPECIFICATION

5.1 General Constructional Requirements

5.1.1 The electrical system and installation shall be designed as per latest practice to provide maximum reliability, flexibility, safety to personnel and equipment and ease of operation and maintenance.

5.1.2 All equipment shall have adequate and standard ratings. Minimum 10% excess capacity over calculated operational requirement shall be added unless indicated otherwise.

5.1.3 Equipment to be located outdoor shall be weather proof and have IP-55 protection and shall also be provided with canopies as far as practicable. The genset shall be housed in a canopy.

5.1.4 The equipment must be certified by statutory authority for use in the specified hazardous area, if required.

5.1.5 All mating surfaces shall be properly machined. Neoprene gaskets shall be used for dust and weatherproofing. The gaskets shall be without any discontinuity.

5.1.6 Only non-hygroscopic materials shall be used for insulation. All insulation shall be specially impregnated to withstand ambient conditions and atmospheric pollution.

5.1.7 All live parts shall be adequately protected to prevent inadvertent or accidental contact.

	TECHNICAL SPECIFICATION - DIESEL GENERATOR SET	PC183-TS-0839	0	
		Document No.	Rev	
		Sheet 7 of 45		

- 5.1.8 All external hardwares of diameter less than 8 mm shall be of stainless steel and those of diameter 8 mm and above shall be of mild steel zinc passivated.
- 5.1.9 Earthing terminals complete with sockets and identification marks shall be provided on the enclosure of all electrical equipment. The number of terminals shall be two for equipment rated above 230 V and one for those rated 230 V and below. Additional internal earthing arrangement shall be provided for flameproof equipment.
- 5.1.10 All equipment shall be provided with stainless steel name plates containing the particulars as per relevant IS/IEC along with the description and Code no. of the equipment.
- 5.1.11 All the electrical equipment shall be provided with weather proof heavy duty double compression type rolled aluminium/stainless steel cable glands, tinned copper crimping lugs and terminal blocks suitable for the cable sizes required.
- 5.1.12 All detailed drawings, equipment sizing make & type of equipment shall be subject to approval by owner/PMC.

6.0 DIESEL ENGINE

- 6.1 The diesel engine shall be of multistroke, multicylinder with OEM standard design fuel injection arrangement, single acting, and shall be complete with all the required accessories.
- 6.2 The engine shall be suitable for trouble free operation with high speed diesel conforming to IS: 1460.
- 6.3 The unbalance force transmission to the foundation shall be minimum. Critical speed of the assembly shall be sufficiently higher than the rated speed of the engine.
- 6.4 The engine shall be provided with turbo charger, filter and silencer mounted suitably and complete with necessary ducts work for air intake, as required.
- 6.5 The engine shall be provided with exhaust silencer, necessary ducts, minimum 2 nos. expansion bellows and supporting arrangement from ceiling for exhausting the gases to outside.MCR
- 6.6 The diesel engine shall be prime power duty, turbo charged system.
- 6.7 The engine shall be single acting, four stroke cycle, battery start, turbocharged, forced feed lubricated, water cooled fuel efficient engine, suitable for generating set application and fitted with the following standard accessories
- Suitable common base frame (for engine and alternator) of sturdy design made of MS Channel with required anti vibration mounting pads for DG set.
 - Radiator Cooling
 - Radiator fan with guard
 - flywheel to suit coupling
 - Flywheel housing complete with starter gearing
 - Flexible coupling as per manufacturer standard design between engine and alternator to match flywheel with coupling guard.
 - Fuel tank of specified capacity, fitted with drain valve, air vent, inlet & outlet connections, level indicator, float switch and mounting steel channel structures, fuel piping i.e. Wire braided hoses/MS pipe.
 - Electronically controlled Governor
 - Fuel oil system equipments including Fuel Pump/ Fuel Solenoid, filters, integral piping, valves, hoses etc.
 - Corrosion resistor.
 - Residential and straight run type silencer with spark arrestor.

**TECHNICAL SPECIFICATION - DIESEL GENERATOR SET**

PC183-TS-0839

0

Document No.

Rev

Sheet 8 of 45



- Exhaust piping along with support structure.
- Dry type air filter with service indicator.
- Lube Oil Cooler
- Air Filter, dry type
- Flexible pipe for silencer, with necessary flanges.
- Suitable Turbocharger, driven from exhaust gas.
- Speed Governor.
- Automotive type, lead acid battery for engine starting.
- Microprocessor based Engine Mounted Control Panel.
- Engine Gauge panel / Genset Controller HMI
- Radiator mounting brackets.
- By pass filter mounting bracket for Engine.
- Fuel Pump.
- Anti vibration pads.
- All interconnecting fuel piping of complete engine system.
- All necessary instruments to meet specified parameters.
- In built safety controls against following:
 - Over speed shutdown
 - High coolant temperature warning / shutdown
 - Low coolant temperature warning / shutdown, as required
 - Low coolant level warning / shutdown
 - Low battery voltage warning
 - Weak battery warning
 - Over crank shutdown
 - Fail to crank shutdown
 - Over current
 - High voltage
 - Low voltage
 - Under / over frequency
 - Phase sequence
 - Reverse power (kVA & kVA_r)
 - Low Lube Oil Pressure shutdown
 - One No. 2 pole, AC/DC type, on-off switch, mounted on suitable frame, shall be provided and connected between the Battery and Engine (Starter) in order to isolate the battery supply to the engine when required.

6.8 The major subassemblies of the prime mover (engine) shall be as follows:

- Four-stroke diesel oil engine, Battery starting type, Turbocharged, Water-cooled, Forced feed lubricated with its auxiliaries.
- Steel channel fabricated common base plate for engine and alternator alongwith anti-vibration mounting pads.
- Flexible or Hol-set type coupling between engine and alternator with coupling guard.
- Microprocessor based Engine Control system for the Diesel engine.

6.9 The diesel engine offered shall be suitable for operation with high-speed diesel oil, unless otherwise specified.

6.10 Performance requirement of the engine shall meet the requirement of IS-10002/BS ISO-3046 standards (latest editions).

6.11 The specific fuel consumption (S.F.C.) for the Engine shall be indicated in the engine data sheet in (gm/bhp/hr).

	TECHNICAL SPECIFICATION - DIESEL GENERATOR SET	PC183-TS-0839	0	
		Document No.	Rev	
		Sheet 9 of 45		

- 6.12 As a prime parameter of engine performance for Test Bench measurement, the permissible deviation of the above mentioned value of specific fuel consumption will be strictly limited to +3% in line with requirement of ISO-3046 Part-III:2006.
- 6.13 The engine and its components shall be new and of latest design; proven model and shall be designed, manufactured, tested and inspected as per the latest, ASTM, ASME, IS and BS code. Bidder shall clearly specify the compliance codes and standards for designing, manufacturing, inspection and testing of the engine along with the bid.
- 6.14 Cylinder blocks shall be made of single block high-grade modular cast iron with spacer plates.
- 6.15 Cylinder liners shall be of centrifugally cast alloy cast iron replaceable wet type.
- 6.16 Pistons shall be made of aluminium alloy material and shall have steel reinforced grooves for minimum of two compression rings and one groove for oil ring (oil cooled).
- 6.17 Connecting rods shall be made of drop forged, high tensile strength steel.
- 6.18 The crankshaft shall be of high tensile strength steel with forged pins and induction hardened journals.
- 6.19 Cylinder heads will be of alloy cast iron having a high resistance to thermal stress.
- 6.20 The valves shall have replaceable type alloy sheet.
- 6.21 MOC of above as per OEM Standards design may be accepted subject to Owner/PMC Approval.
- 6.22 Materials for other engine parts shall be in accordance with latest ASTM standards unless otherwise stated.
- 6.23 The materials selected for various engine components shall be in accordance with latest British standards and standard manufacturing practices.
- 6.24 The diesel engine shall be provided with all accessories like governor, fuel tank, exhaust piping with exhaust silencers of residential type with spark arrestor etc.
- 6.25 The engine and its component parts shall be manufactured to controlled tolerances to ensure complete inter-changeability of similar parts.
- 6.26 The noise level shall be as per current CPCB/SPCB/MoE&F norms.
- 6.27 The engine shall carry warranty / guarantee of engine manufacturer for the DG set.
- 6.28 Engine shall be fitted with a heavy flywheel with a non-sparking type fabricated fly wheel guard (as per OEM Standard) to ensure smooth operation throughout the speed range at rated power. The effect of this flywheel shall be such that cyclic irregularity of the system comply with (or better than) the limit laid down in BS ISO-3046.
- 7.0 FUEL OIL SYSTEM**
- 7.1 Each engine shall be provided with an engine driven main fuel pump. The pump shall supply fuel at a minimum rate sufficient to provide the amount of fuel required to meet the performance. The fuel flow rate shall be based on meeting the load requirements and all necessary recirculation.
- 7.2 Minimum of one full-flow fuel filter for each engine shall be provided. The filter shall be readily accessible and capable of being changed without disconnecting the piping or disturbing other components.

	TECHNICAL SPECIFICATION - DIESEL GENERATOR SET	PC183-TS-0839	0	
		Document No.	Rev	
		Sheet 10 of 45		

- 7.3 Relief/bypass valve to regulate pressure in the fuel supply line, return excess fuel to a return line and prevent the build-up of excessive pressure in the fuel system shall be provided, if required as per OEM Standard.
- 7.4 Each engine shall be provided with a separate self-supporting 990 litres day tank, engine driven fuel oil pump and interconnecting piping.
- 7.5 Each day tank shall be provided with connections for fuel supply line, fuel return line, fuel overflow line, local fuel fill port, gauge, vent line, drain line, fuel oil level gauge and level switch for Lo/Hi level alarms. A fuel return line cooler shall be provided as recommended by the manufacturer and assembler. The temperature of the fuel returning to the day tank shall be below the flash point of the fuel.. The fuel fill line shall be accessible without opening the enclosure.
- 7.6 The fuel oil circuit shall include:-
- Daily service (Fuel) tank shall be of capacity as mentioned in specific requirements. The fuel tank shall have provision for flanged inlet/outlet connections, level switches, vent, top cover with opening, visual indicator, overflow drain and also necessary level monitoring instrumentation and alarm.
 - Fuel transfer pump for filling of fuel tank.
 - Pipe, flanges, fittings, valves, gaskets and all other material required for the fuel circuit, including interconnecting MS/wire braided fuel pipes of required pressure and rating and isolation valves.
 - Full flow fuel filters.
 - Level indicator.
 - Potential free contacts for fuel level alarm through explosion proof fuel level switches.
 - Bidder to furnish the drawing of fuel tank as well as its foundation details along with the bid.
 - Thickness of plate for fuel tank shall be minimum 3 mm.
- 7.7 The system shall comprise of gravity fed oil tank, unless otherwise specified.
- 7.8 The gravity tank shall be complete with the provision of filling up by Motor driven pump and Hand Pump from the standard drums. The motor driven pump and associated hose pipe shall be provided by the Contractor.
- 7.9 The gravity fed oil tank shall be located at a height from floor and near the wall of the engine room. Suitable brackets / structure shall be provided by the Contractor for this purpose. The tank shall be fabricated out of M.S. plates in cylindrical construction. It shall be complete with valves for filling & draining, vent connection, level gauge glasses, level switches for low level alarm.
- 7.10 The day tank shall be rectangular/cubical in shape.. The tank shall be provided with suitable coatings/paintings for corrosion protection. The paint shall be resistance to HSD. Slope shall be provided at one end of the bottom in case of rectangular tank so that sediments and moisture collected at the bottom can be completely drained
- 8.0 JACKET COOLING SYSTEM**
- 8.1 The engine waste heat shall be dissipated to a closed circuit water system which in turn shall be cooled by radiator cooling system driven by the power from the engine. The proposal shall be complete including the necessary pipe work for radiator, accessories etc., for the cooling system.
- 8.2 The cooling system considered must not be envisaged as a system to be installed away from the engine.

	TECHNICAL SPECIFICATION - DIESEL GENERATOR SET	PC183-TS-0839	0	
		Document No.	Rev	
		Sheet 11 of 45		

- 8.3 Jacket water valve / Thermostatic switches for temperature control and alarm are to be provided as per design and recommendation of the OEM.
- 8.4 All the necessary items for the system such as water pump, radiator, fan, piping and fittings shall be provided to make the system complete in all respects.
- 8.5 Head tanks, if required, shall be included in the scope of supply for make up water as well as taking care of the expansion of the jacket water.

9.0 LUBE OIL SYSTEM

- 9.1 Proper lube oil system shall be provided for all lubricating points of the engine. The system shall be automatic pressure feed type and provided with a gear type pump driven from the crank shaft. The system shall be complete with filter, valves, tank, oil cooler, header and branch piping suitably mounted on bed plate. Necessary accessories like pressure gauge, pressure switches for alarm and controls shall be provided. A relief valve shall be provided to protect the pump from excessive pressure, when starting under cold conditions. A mechanical hand operated lubricator shall also be provided, if required as per OEM standard design.
- 9.2 The lubricating oil sump shall have such capacity so as to ensure continuous operation of 48 hours without make up.
- 9.3 The engine shall be complete with its own self-contained wet sump lubricating oil system in which all the moving parts are lubricated by force feed system and the engine driven lubricating oil pump.
- 9.4 The filter shall be Paper MCE or as per manufacturer standard.
- 9.5 Filter type and capacity shall be as per manufacturer standard.
- 9.6 The Bidder shall indicate the recommended grade of lube oil, the consumption detail of lube oil at rated load and also the schedule / frequency for replacement / testing of the lube oil and the same shall be covered in the instruction manual.

10.0 STARTING SYSTEM

- 10.1 The Electrical starting system shall be provided.
- 10.2 The engine shall start quickly & reliably after long idle periods of non operation. Starting of diesel engine shall be by electrical starting system.
- 10.3 Both manual and automatic starting scheme shall be provided. The manual starting system shall be local while automatic starting system shall be suitable for impulses from owner's remote panel.
- 10.4 The starting system shall be such that the D.G. set shall start & come up to rated speed and be ready to accept full load within the period as indicated in Design Philosophy – Electrical.
- 10.5 Starting time of the DG set should be minimum, but not exceeding 15 seconds, to start, accelerate and build up the desired voltage and frequency. If the first starting operation is not successful, 2 more attempts to start with preset time intervals should be made. If all the three attempts fail, the set shall be locked out, alarm shall be given.
- 10.6 The electric starting system shall comprise of starter motor, battery, battery charger, necessary cabling, required instruments and accessories. The starter motor shall be provided with sealed type bearings.
- 10.7 The Lead Acid Battery (VRLA Type) or Ni-Cd battery shall be heavy duty type and suitable for 6 successive starting attempts of the engine without draining. The charger shall have both float / boost charging facilities. The battery shall be complete with suitable stand and other required accessories.

	TECHNICAL SPECIFICATION - DIESEL GENERATOR SET	PC183-TS-0839	0	
		Document No.	Rev	
		Sheet 12 of 45		

10.8 The charging of starting batteries shall be through engine mounted dynamo during running of DG set. The provision of charging the starting batteries during DG set idling period shall be through a suitable single phase charger mounted in AMF panel.

10.9 Contractor shall provide all necessary devices including solenoid valves so that with an impulse for starting of the engine received from emergency equipment or manual start push button, the entire operation of starting of the diesel set shall take place automatically.

11.0 AIR INTAKE AND EXHAUST SYSTEM

11.1 The DG set in acoustic enclosure will be kept in open. The bidder shall supply exhaust pipe including tail-piece and pipe-fittings, insulation lagging / aluminium cladding upto 4 meters from ground level, supporting structure suitable for 30 meters stack height from the ground. The supply of exhaust system including MS ladder with all required materials such as exhaust pipe, cladding materials, support structure etc. Are deemed to be included as part of DG set.

11.2 The erection of the exhaust piping and its support structure shall be done by Owner in line with drawings and procedures submitted by the Bidder.

11.3 Exhaust piping shall be painted with special heat resistant paint. A condensate drain plug shall be provided in the system. All system exhaust piping, silencer and bellows shall be provided by the bidder with lagging/ cladding materials, so that the cold surface temperature shall not be more than 200 Deg C during engine operation in hazardous area.

11.4 Exhaust silencer, spark arrestor type shall be provided by the bidder in pre-fabricated form with loose flanges, as appropriate, for final site welding and erection. Fittings and gaskets shall be included in the supply, Additionally, steel wire mesh of adequate strength shall be provided at the outlet of exhaust pipe.

11.5 The exhaust system shall be suitably designed for meeting the noise level stipulation at site.

11.6 Suitable structural supports for the exhaust silencer shall be provided.

11.7 Stack including structural work shall be sized as per CPCB / state PCB norms. Approval if required, from state PCB for exhaust gases and noise level shall also be taken by bidder.

11.8 Exhaust silencers (residential type) with spark arrestor shall be supplied with the Genset.

11.9 The silencers shall be straight through type with drain plug at lowest point and one accessible clean port. The silencers shall be finished with rust preventive primer & heat resistant paint. Flexible sections shall be connected between the exhaust pipe and the engine exhaust manifold. The flexible exhaust pipe shall be of carbon or stainless steel, smoke tight and the inner diameter same as of exhaust pipe.

12.0 GOVERNING SYSTEM

12.1 Governor will be provided for keeping constant speed within permissible limits with variable load. The governor shall have the following minimum features and conform to requirement of BS-ISO-3046:

12.2 The speed governing system of the diesel engine shall satisfy the following requirements:

- a) Steady state speed shall be adjustable between 0 to 3% manually.
- b) Steady state speed regulation once fixed, shall not vary beyond + 0.5%.

	TECHNICAL SPECIFICATION - DIESEL GENERATOR SET	PC183-TS-0839	0	
		Document No.	Rev	
		Sheet 13 of 45		

- 12.3 The governor system shall be electronic type microprocessor / PLC based, comprising a magnetic speed pickup, control unit, actuator and speed set point potentiometer or as per manufacturer standard design. It shall be capable of operating on Isochronous & Speed Droop Mode (selectable with a droop adjustment potentiometer) to control the speed in the event of failure of power to the governor.
- 12.4 The governor shall control the engine speed by electronic input from local control panel or as per manufacture standard design.
- 12.5 It shall have external speed trim facility with speed adjustable within +/- 3% of rated speed.
- 12.6 An emergency push button shall be provided to trip the engine in case of emergency.
- 12.7 It shall have a shutdown device set to close the engine fuel racks to 0 on receipt of any trip signal from local / remote control panel or as per manufacturer standard. .
- 12.8 In case of any sensor failure, controller shall give alarm or shutdown. Sensor failure protection may be inbuilt feature of Genset controller.
- 12.9 Necessary controls to effect adjustment of compensation and load limits as required.
- 12.10 It shall have a shutdown device set to close the engine fuel racks to 0 on receipt of any trip signal from local / remote control panel or as per manufacturer standard.
- 12.11 It shall be capable of operating within 20V to 32V DC in an ambient temperature of -5 Deg. C to 55 Deg C. Remote operation of the governor shall be possible.
- 12.12 Flexible coupling with guard shall be provided.

13.0 DG CONTROL PANEL

- 13.1 The enclosure of the Engine mounted control panel shall have minimum ingress protection IP22 .
- 13.2 Suitable facilities shall be provided for operation and monitoring of the Engine which shall include the following:-

Digital (LCD) Indication:

- DC voltage
- Coolant temperature
- Oil pressure
- RPM Hours Run
- Systems diagnostic

Controls:

- Auto Start/Stop
- Emergency Stop
- Voltage Control
- Cycle Crank
- Cool down Timer

LED Indication:

- Low oil pressure
- High coolant temperature

**TECHNICAL SPECIFICATION - DIESEL GENERATOR SET**

PC183-TS-0839

0

Document No.

Rev

Sheet 14 of 45



- Over speed
- Over crank
- Emergency stop
- Fault shutdown
- Fault alarms
- 3 spare indications (Customer programmable)
- 4 spare inputs (Customer programmable)

- 13.3 The engine controller shall enable individual as well as parallel operation of DG sets. It shall enable operation of DG sets in Auto as well as manual modes.
- 13.4 The engine controller shall have auto load management system for appropriate loading of DG sets depending upon the load requirements.
- 13.5 Engine controller is to be mounted inside the acoustic enclosure.

14.0 GENERATOR**14.1 General Design Features**

- 14.1.1 The generator shall be directly coupled to the engine.
- 14.1.2 The generator and its accessories shall be capable of withstanding electrical, mechanical and thermal stresses while meeting the performance requirements.
- 14.1.3 The generator shall be synchronous A.C. Generator; star connected and shall have specified output at 0.8 lag p. f. at 11 kV, 3 Phase, 4 wire system, 50 Hz.
- 14.1.4 The alternator of the DG set shall be driven by Internal Combustion Diesel Engine.
- 14.1.5 The alternator shall be rated for specified output (KVA) as per alternator specification sheet exclusive power requirement of auxiliaries.
- 14.1.6 Generators rated 1000kVA and above shall be provided with a separate neutral terminal box, if required as per manufacturer standard design. Neutral cubicle shall contain various CTs for protection. A suitably rated generator breaker shall be provided, if specified in data sheet.
- 14.1.7 Various generator winding (i.e. stator, rotor, exciter) shall be designed either for insulation Class 'F' with temperature rise up to Class 'B' or with Class 'H' with temperature rise up to Class 'F'. The windings and overhangs shall be braced to withstand the short circuit forces.
- 14.1.8 Machines rated 1000 KVA and above shall have minimum six nos. RTDs (one per phase between the coil sides to measure winding temperature and one per phase at the base of slots to measure core temperature, each placed at 120° apart)
- 14.1.9 Stator winding shall be Star connected and neutral shall be brought out through a separate terminal in the terminal box or as per manufacturer standard design. .
- 14.1.10 The output of the DG set after de-rating (if required for limiting temperature rise to class F/B) shall be as per the full load output given in the alternator specification sheet.

The alternator shall have following minimum features:

- a) Solid state excitation facility, screen protected, revolving field, self excited/separately excited by P.M.G./Auxiliary winding , self regulated through a Genset Controller in excitation circuit shall be suitable for high ambient temperature.

	TECHNICAL SPECIFICATION - DIESEL GENERATOR SET	PC183-TS-0839	0	
		Document No.	Rev	
		Sheet 15 of 45		

- b) The stator and rotor coils shall be made out of electrolytic grade copper conductors. Successive coils shall be connected by accessible and well brazed joints.
- c) The windings shall be dried, properly impregnated with suitable varnish to withstand the site conditions and properly baked. At least two additional impregnations and baking shall be applied to the assembled coil making a total of three impregnations. Finally the windings shall be painted with special anti-acid and anti-alkali paint to withstand the site condition.
- d) IP: 23 enclosure dip proof and screen protected.
- e) Two nos. body earthing terminals which shall be separate from the neutral terminal.
- f) There shall have a facility of adjusting the generator terminal voltage within range of $\pm 5\%$ of the nominal voltage with a continuously variable potentiometer or D to A Converter .
- g) Generator shall be suitable for continuous operation at rated load for a frequency variation of $\pm 3\%$ of rated value.

14.1.11 All the Generator shall be in parallel operation, under all load Conditions.

14.1.12 The windings and overhangs shall be braced to withstand the short circuit forces. Machines rated above 1000 KVA and above shall have minimum six nos. RTDs (one per phase between the coil sides to measure winding temperature and one per phase at the base of slots to measure core temperature, each placed at 120° apart).

14.2 **Winding and Insulation**

14.2.1 The stator and rotor coils shall be made out of electrolytic grade copper conductors. Successive coils shall be connected by accessible and well brazed joints.

14.2.2 The coils shall be class F insulated and treated with tropical and fungicidal treatments.

14.2.3 The windings shall be dried, properly impregnated with suitable varnish to withstand the site conditions and properly baked. At least two additional impregnations and baking shall be applied to the assembled coil making a total of three impregnations and baking. Finally the windings shall be painted with special anti-acid and anti-alkali paint to withstand the site condition.

14.2.4 The leading wire between the windings and the outside terminals shall be through bushings.

14.2.5 The field winding shall be capable of operating at 125% of rated field voltage for at least one minutes starting from hot initial condition i.e stabilized temperature at rated load condition or as per manufacturer standard design.

15.0 **PERFORMANCE REQUIREMENT**

15.1 The generator and the diesel engine shall match properly to deliver the rated load under the specified ambient and system conditions.

15.2 DG set shall be capable of starting from cold condition, taking up full load without undue wear and stress on equipment under the specified ambient and system condition. Also DG set shall be stopped manually using Emergency Stop push button, irrespective of the position of Auto/ manual selector switch located in Generator Control Panel.

15.3 The specified rating of the D.G. set indicated are net electrical power output required for owner's use and does not include the power required by the auxiliaries of the diesel set.

15.4 The generator shall have an overload capacity of 10% for 1 hour in any consecutive period of 12 hours after having attained the thermal equilibrium corresponding to the rated load. The terminal voltage shall be equal to the rated value. At the time of switching



TECHNICAL SPECIFICATION - DIESEL GENERATOR SET

PC183-TS-0839

0

Document No.

Rev

Sheet 16 of 45



'ON' the loads, restarting or re-acceleration of squirrel cage motors may be required, which will be six times the rated load at power factor of 0.25 lagging in addition to switching 'ON' of the lighting loads.. The generator and its accessories shall be capable of supplying this load at the above mentioned low power factor. Limitations, if any, shall be clearly indicated by the Contractor.

15.5 The Generator shall meet required performance as per G3 performance Class as per IS/IEC 60034 Part 22.

15.6 Largest Motor Starting Requirement

The D.G. set shall be designed such that it can start squirrel cage induction motor of specified rating by D.O.L. starting method when already loaded up to 80% of its rated load. The voltage dip at the generator terminal shall not exceed 10% of its rated voltage during the entire starting period which will not exceed 5 seconds.

Limitations of the engine size offered by the bidder, if any, shall be indicated clearly by the bidder.

Supporting calculation shall be supplied by the successful bidder for approval of the owner.

15.7 The short circuit ratio, of the generator at rated KVA and rated voltage shall not be less than 0.5.

15.8 The generator shall withstand 20% over speed for 2 minutes without any damage to any part.

15.9 The generator shall be capable of withstanding the three phase short circuit at its terminals while operating at its voltage without sustaining any damage.

15.10 The temperature rise of stator windings, exciter and other parts shall not exceed the limits specified in relevant IS.

16.0 EXCITATION SYSTEM AND VOLTAGE REGULATION

16.1 An Automatic Voltage Regulator system compatible with excitation system shall be provided so as to attain stated performance under all conditions of load. AVR functionality may be integral part of Genset Controller.

16.2 The generator shall have brushless type solid state self-excitation system (with PMG arrangement/Auxiliary Winding) with Automatic Voltage Regulator, AC exciter and rotary rectifier.

16.3 The armature and field windings shall be class F insulated similar to that of generator.

16.4 The exciter winding shall minimum have 'F' class insulation with temperature rise limited to class 'B'.

16.5 The capacity of the system shall be adequate to meet the performance and largest motor starting requirement of the generator.

16.6 The field of the exciter shall be fed from the stator winding and AVR. The rotor winding of AC exciter, the rectifier assembly, main field winding of the generator and other accessories on the rotor parts shall be rigidly fastened to the shaft and the connection with different items shall be anti-loosening type. The exciter capacity shall be at least 20% more than the maximum requirement at any time.

16.7 Excitation system shall be provided with short circuit support equipment to maintain three times the rated current for 3 sec. In case of short circuit to ensure proper fault clearance in outgoing feeders.

	TECHNICAL SPECIFICATION - DIESEL GENERATOR SET	PC183-TS-0839	0	
		Document No.	Rev	
		Sheet 17 of 45		

16.8 The rectifier in the excitation circuit shall be suitable for specified high ambient temperature.

16.9 AVR shall be Digital-Type (Micro Processor based, digital signal processing based or latest technology based, with proven track record), having Dual Channel for Auto Mode operation. In case of fault in one channel, the other channel shall take over while giving an audio-visual alarm. In case of fault in both channels in Auto mode or if the voltage at generator terminals goes beyond the AVR regulation limits, the regulator shall automatically transfer to Manual channel with alarm indication. The transfer shall be bump less. The excitation system shall be capable of providing rapid changes in generator excitation and shall be designed to minimize the voltage variations during load changes. Automatic solid-state voltage regulator (AVR) shall be provided with the following features as a minimum:

- Short circuit protection
- Auto voltage control
- Manual voltage control. Unless supplier's standard design does not permit it which shall be supported with proper justification.
- Voltage build up circuitry
- Over voltage protection

AVR shall have provision for communication for remote monitoring of machine data.

16.10 **Voltage Regulator**

16.10.1 The generator shall have static type voltage regulators to be mounted on the control panel. The regulator system shall be suitable to meet the following requirements:

- a) Allow the generator to meet the performance requirements.
- b) Both auto and manual control.
- c) Prevent automatic rise of field voltage in the event of excitation supply failure.
- d) Transfer to manual mode in the event of control circuit failure in auto mode.
- e) Operated by the output current and voltage of the generator.

16.10.2 AVR functionality may be integral part of Genset Controller.

16.11 **Space Heater**

16.11.1 Space heaters rated for 240V A.C. shall be provided to keep the winding dry during idle conditions.

16.11.2 The location of the space heaters shall be such as to allow easy access for inspection, maintenance and replacement.

16.12 **Embedded Temperature Detectors**

16.12.1 The generators shall be provided with 6 nos. of embedded resistance temperature detectors for measurement of winding temperature. Three of these shall be provided between the coils, one in each phase and the other three at the base of the slots, one in each phase, placed 120° apart.

16.12.2 The ETDs (Duplex Type) shall be of platinum having 100 ohm resistance at 0°C and temperature coefficient as 3.85×10^{-5} . The ETD's shall be 3 lead type having power frequency insulation level of 2 KV.

16.12.3 The temperature indicator with selector switches shall be provided in the control panel.

	TECHNICAL SPECIFICATION - DIESEL GENERATOR SET	PC183-TS-0839	0	
		Document No.	Rev	
		Sheet 18 of 45		

16.13 Bearings

16.13.1 Bearings shall be grease lubricated ball or roller bearing or of the manufacturer's standard type i.e. sleeve type supported with PTR. In all cases the bearings shall be chosen to give a minimum L-10 rating of 5 years (40,000hrs) at rated operating conditions.

17.0 TERMINAL BOXES

17.1 All the terminal boxes shall have IP-54 degree of protection or as per manufacturer standard design.

17.2 The power and control terminal boxes shall be separate. All the four leads of the generator stator shall be taken out, three to one side and three to the other side to separate power terminal boxes. The star point shall be made inside the terminal box of generator. Alternatively Star Point may be made inside Alternator. Space for mounting a protection current transformer in each phase, 3 phase CT for differential protection in neutral side terminal box & one current transformer in neutral connection to ground shall be provided. The neutral star point of synchronous generator shall be connected to two independent earth electrodes through 1 Number with a low value neutral earthing resistor (NER) made of AISI 304/406 stainless steel of punched / formed construction suitable for 375 deg. C temperature rise over ambient. The NER shall be designed to carry 20 % of rated current continuously and full load current of the generator for 30 secs. Housing of NER shall be fabricated out of 3 mm thick sheet steel fitted on a 6 mm thick mild steel framework.

17.3 Two separate neutral terminals, one for connection to NER and other from NER to earth pit shall also be provided. Gland plate shall be provided for cable sizes & nos. of entry.

17.4 The terminal box design shall be suitable for connection of a bus-duct or for termination & connection of specified number and size of cables. A separate entry shall also be provided for CT secondary wiring if applicable.

17.5 The power terminal box shall be spacious and have adequate clearance between the terminals and the cable gland for proper termination of required nos. of aluminium cables.

17.6 The power terminal boxes shall be provided with tinned copper sockets suitable for crimping.

17.7 The control terminal boxes shall be provided with pressure type terminal blocks.

17.8 All terminal boxes shall be complete with heavy duty double compression type aluminium cable glands suitable for the cable sizes required.

17.9 All terminal boxes shall be complete with heavy duty double compression type Ni-plated brass cable glands suitable for the cable sizes required.

17.10 The alternator output terminals shall be enclosed in the terminal box mounted in an accessible position on the alternator frame.

17.11 CT for over current and short circuit protection with current transformers ratio */1A, CL 5P20, shall be mounted in each phase.

17.12 CT for differential protection with current transformers */1A CLPS class shall be provided on neutral formation point just before the star point.

17.13 CT for restricted earth fault protection in neutral, to be located between star point and the neutral tee off point.

17.14 CT & PT, suitable for current/voltage signal to AVR shall also be mounted in generator terminal box/line cubicle.

	TECHNICAL SPECIFICATION - DIESEL GENERATOR SET	PC183-TS-0839	0	
		Document No.	Rev	
		Sheet 19 of 45		

- 17.15 One current transformer (for SBEF), ratio */1A, CL 5P10 shall also be mounted after neutral tee off point.
- 17.16 It shall be suitable for termination of specified 3 Core cable with sufficient space for trifurcation Inside the box.
- 17.17 The exact size and number of runs of cables shall be confirmed during the drawings approval Stage.
- 17.18 The terminal box shall be include individually removable gland plates, cable end lugs & cable Glands.
- 17.19 Suitable segregation shall be available for other cables such as excitation, control cables etc.
- 17.20 The terminal box shall be suitable for withstanding the mechanical and thermal stresses developed due to any short circuit at the terminals.
- 17.21 Where terminal box does not have sufficient space for accommodating CTs for protection, a separate cubicle shall be provided by bidder, irrespective of the machine rating. In such case all connections shall be brought to the cubicles, using cable/bus duct connection of sufficient rating. Apart from accommodating CTs, formation of start point and neutral tee off point shall be achieved in this cubicle. Outgoing power cable connection to owner's power distribution board shall be done in this cubicle.
- 17.22 Separate terminal box shall be provided for space heater and other devices like RTDs.

18.0 MODES OF OPERATION

DG set and its associated electrics and control shall be suitable for unattended operation and shall include all controls and protection necessary for the safe operation of DG set. The DG shall operate in following modes:

18.1 AUTOMATIC START ON MAINS FAILURE (AMF)

DG Set shall start automatically on failure of normal supply by receiving a starting impulse from owner's remote panel. On receiving this impulse, generator shall start automatically and rated speed and voltage shall be built up.

Once the voltage monitoring relay senses generator healthy voltage, an impulse shall be given for closing of generator breaker.

18.2 MANUAL START

Manual start mode shall be same as of auto mode described above, except that starting command shall be given manually using push button from the local control panel. Manual start shall have service & test selector switch in order to facilitate periodic load test run of DG set if required.

18.3 STOP UPON RESTORATION OF GRID MAINS SUPPLY

Unless specified otherwise in the data sheets, DG set shall be stopped manually using push button. This shall be possible irrespective of the position of Auto/Manual selector switch which is located in generator control panel.

19.0 DG AMF Cum Control Panel

19.1 Requirements

- 19.1.1 The control panel board shall comprise of control & instrument section, power & protection section and distribution section for satisfactory and trouble free operation of the set. Each section shall be a complete panel.

	TECHNICAL SPECIFICATION - DIESEL GENERATOR SET	PC183-TS-0839	0	
		Document No.	Rev	
		Sheet 20 of 45		

- 19.1.2 The AMF panel shall be PLC / Microprocessor based and shall control the starting & stopping of DG set and give commands for closing & tripping of DG incomer breaker (provided by Contractor) and Normal Incomer breaker of Owner's panel through auxiliary potential free contacts.
- 19.1.3 The system shall be modular in construction and expandable in future by adding additional modules which shall be easily accessible for maintenance & repair.
- 19.1.4 DG set shall be with AMF system to generate start up sequence and control operation of DG Set. Control and maintain lube oil pressure etc, provided periodical lube oil circulation. System shall be PLC /microprocessor Controller based with full fledged annunciation.
- 19.1.5 The AMF panel & Engine controller shall have the facility to remotely switch on/off the DG set& DG breaker (by bidder) through auxiliary potential free contacts.
- 19.1.6 The engine control circuit shall provide terminal contacts for permissive signal to run/stop from an external relay contact that will close by shorting the terminals and allow the engine to start/stop on remote mode from Owner's remote control panel.
- 19.1.7 The control panel shall be outdoor type. It will be free standing, floor mounting type, IP-55 protection. The control panel shall have only front access. Cable entry will be from bottom. The panel shall be painted with epoxy paint, shade RAL 7032.
- 19.1.8 The shutdown of DG shall be effected through a Stop solenoid switch mounted on the engine
- 19.1.9 The control and instrument panel shall house the following:
- a) All the required controlling elements for the engine, generator and exciter control, for both manual and automatic operations.
 - b) Panel mounted instrument
 - c) The required protective devices for the engine.
 - d) The audiovisual annunciation system indicating abnormal operating conditions.
 - e) Control switches and indicating lamps.
 - f) Automatic voltage regulator.
 - g) All other items, as required.
- 19.1.10 The DG set shall permit immediate automatic shut-down of the unit due to irregular operation and shall have provision for creating audio-visual signals of shut-down cause at the panel which shall include the following:
- a) Low lube oil pressure (through a pressure switch/transmitter): Trip & Alarm.
 - b) High jacket water temperature (through a temperature switch/transmitter): Trip & Alarm.
 - c) Engine fails to start: Alarm.
 - d) Engine overspeed: Trip & Alarm.
 - e) Low fuel level: Alarm.
 - f) Low-low fuel level: Alarm & Trip.
 - g) High fuel level: Alarm.
 - h) Engine shut down due to High winding/high bearing temperature through RTDs of Alternator. Trip & Alarm

	TECHNICAL SPECIFICATION - DIESEL GENERATOR SET	PC183-TS-0839	0	
		Document No.	Rev	
		Sheet 21 of 45		

- i) Generator circuit breaker trip. trip & Alarm
 - j) PT fuse & control supply failure. trip & Alarm
 - k) Any other critical fault(s) in the engine: trip & Alarm.
 - l) Common engine fault if it is controller inbuilt protection.
- 19.1.11 To facilitate the generation of these fault signals suitable instruments/relays/controllers shall be provided with required potential free contacts.
- 19.1.12 The power and protection panel shall house the following:
- a) Circuit breaker in draw out execution suitable for local/remote operation and provided with protective relays, C.T.s, Ammeters, Voltmeters, KWH meters, Frequency meters, ON/OFF/Trip indicating lamps, control switches etc. for the control of generator.
 - b) V.C.B. in draw-out execution suitable for local remote operation and provided with protective relays, C.T.s, Ammeters, ON/OFF/Trip indicating lamps, control switches etc. for the control of outgoing power feeders, as indicated else where.
- 19.1.13 The distribution panel shall house the following:
- a) Necessary feeder circuit outlets complete with switches, fuses, contactors, overload devices, ON/OFF/Trip indicating lamps, Ammeters etc. for the D.G. set auxiliaries, if required.
 - b) D.C. battery charging equipment required for the start up and control of the D.G. set. The charger shall be complete with float and boost charging arrangement both in auto and manual mode.
- 19.2 General Design Features**
- 19.2.1 The panels shall be free standing, floor mounting, identical, metal clad cubicle type in construction and placed side by side to form a compact assembly in dust/ damp and vermin proof type equivalent to IP-55 for Outdoor application as per IS-13947 Part-1.
- 19.2.2 The thickness of sheet steel members shall not be less than 2 mm for cold rolled steel. Suitable reinforcement, wherever necessary, shall be provided. The base channel shall be more than 3 mm thick.
- 19.2.3 The door hinge shall be concealed type. All threaded screws in the removable parts shall be provided with retaining rings.
- 19.2.4 All the components shall be accessible for checking and taking off without the necessity of removing the adjacent ones. Their mounting shall be accessible and ensure the necessary degree of safety.
- 19.2.5 The relays, meters, switches and lamps shall be flush mounted type. Their minimum mounting height shall be 900 mm from the base of the panel.
- 19.2.6 The bus bars shall be made of electrolytic copper of required cross section and with heat shrinkable sleeve. These shall be amply sized to carry the rated continuous current under the specified ambient temperature without exceeding the total temperature of 90°C. The thermal rating of the bus bars shall be designed to withstand the system fault current for one second without exceeding the temperature of 250°C for bare copper.
- 19.2.7 The clearances and creepage distance shall not be lower the values specified below:
- Minimum clearance between two live conductors - 110 mm.
 - Minimum clearance between live parts and accidentally dangerous part - 90mm.

	TECHNICAL SPECIFICATION - DIESEL GENERATOR SET	PC183-TS-0839	0	
		Document No.	Rev	
		Sheet 22 of 45		

Minimum creepage distance between phase to earth - 90

19.2.8 **Controller**

- i. Controller shall be PLC/microprocessor based system with appropriate I/Os which shall be used for DG set operation and interlocks.
- ii. The system shall be able to operate satisfactory under specified environmental conditions.
- iii. The system shall be modular in construction and expandable in future by adding additional modules which shall be easily accessible for maintenance & repair.
- iv. The System shall have very high noise immunity in order to ensure safe and reliable operation when subjected to electrical radio frequency interference and electromagnetic disturbances expected in a plant.
- v. The system shall be programmed as per the logic / ladder diagram prepared by the vendor.
- vi. The system shall have extensive set of self-diagnostic hardware and software for easy and fast maintenance. Routine checks shall run automatically at frequent intervals for identifying any fault in software or hardware. Diagnostic shall be required at local as well as console level. The system shall be able to store minimum last 10 fault history data and which can be checked by the operator.
- vii. The vendor shall offer panel etc., in utilized condition complete in all respect.
- viii. The power supply required for the operation shall be provided in the panel itself including batteries of suitable capacity and voltage. Alternatively, in place of battery and charger, suitable UPS system and power pack of suitable rating for the AMF PLC system shall also be acceptable.
- ix. All control fuses shall be of link type (HRC) conforming to IS. Re-wirable fuses shall not be accepted. All fuses shall be readily accessible for replacement. Fuses shall have an operating indicator, which will be visible without removal of fuses from the service. It shall not be necessary to remove any piece of equipment or to disconnect any wiring before replacing the fuses.

19.2.9 **AMF**

- i. One no. comprehensive load manager type microprocessor based indicating meterto indicate voltages, currents in all three phases, demand in KW, KVA and KVAR, Frequency, Power Factor, KWH, Hour meter etc.
- ii. One no. Voltage balancing relay.
- iii. One no. voltage sensing relay to sense failure of mains supply along with AMF feature.
- iv. One no. Frequency balancing relay.
- v. Numerical Relay fro Protection, as required
- vi. One no. Lock out relay
- vii. One no. suitably rated control transformer for control supply.
- viii. One no. hooter with reset and acknowledge push button.
- ix. One set solid state alarm annunciator.
- x. Set of indicating lamp, control switches push buttons etc.
- xi. Generator start/stop push buttons.

	TECHNICAL SPECIFICATION - DIESEL GENERATOR SET	PC183-TS-0839	0	
		Document No.	Rev	
		Sheet 23 of 45		

- xii. Set of control fuses, wiring and other accessories like terminal padlock etc.
 - xiii. Auto/OFF/Manual selector switch for Auto/manual operation of DG sets.
 - xiv. Set of "ON" "OFF" push buttons for manual operation of contactor in manual mode.
 - xv. Voltmeter.
 - xvi. Frequency meter
 - xvii. Main isolator with fuses for 24V DC control supply.
 - xviii. Control unit of the engine speed governor with potentiometer for speed set point.
 - xix. Manual voltage trim facility for generator voltage set point.
 - xx. Automatic Voltage regulator (If not mounted on the generator).
 - xxi. Counter indicating No. of attempts to start with manual reset.
 - xxii. Push buttons for manual starting and stopping of Diesel Engine.
 - xxiii. Emergency stop push-button for the Engine and Generator circuit breaker.
 - xxiv. Selector switch - Auto/Test/Manual.
 - xxv. Solid state types Audio-visual annunciator facia with acknowledge, reset and test push buttons.
 - xxvi. LED type indicating lamps for RYB, low lube oil pressure, high coolant water temperature, Start failure, over loaded, running, load on DG set and load on mains etc.
 - xxvii. Suitable arrangements for terminating incoming/outgoing power cables and control cables.
 - xxviii. The control panel shall be provided with battery & battery charger complete with float and boost charging arrangement both in auto and manual mode for the starting batteries of the DG sets.
- 19.3 The PLC / microprocessor based system shall be programmed for the auto-mains failure for starting & running of DG sets with the following operation philosophy:
- 19.4 Mains voltage monitor shall constantly monitor the Grid Power Supply
- 19.5 When the mains (Grid) voltage fail or drops below X% (this X shall be adjustable & selectable by the user) of the rated voltage, the PLC shall give a starting signal to the D.G. set, or alternatively when a potential free NO becomes closed due to command from remote control panel of the Owner or through a Supervisory Control And Data Acquisition (SCADA) System.
- 19.6 Operation of the PLC / microprocessor based system through sensing of mains voltage failure or changeover from NO to closed condition of the potential free contact shall be through an operator selector switch in the Control Panel.
- 19.7 The selector switch shall have MANUAL (through local push buttons)/ AUTO (through Control panel & Owner's remote control panel)/ OFF position. It shall be possible to operate the DG Set manually through local push buttons by passing all the above automation. The logic for all the above positions shall be clearly mentioned. Potential free contacts shall be provided for the status monitoring of the position of selector switch to owner's remote panel.
- 19.8 System shall permit 3 consecutive attempts for starting the DG set failing which the annunciation circuit shall be activated for alarm.

	TECHNICAL SPECIFICATION - DIESEL GENERATOR SET	PC183-TS-0839	0	
		Document No.	Rev	
		Sheet 24 of 45		

- 19.9 If the engine starts during 3 attempts & the engine reaches its operating speed and the alternator its operating voltage, the cranking circuits shall be isolated and the load shall be transferred to the DG set.
- 19.10 Upon return of the normal supply voltage of Y% (this Y shall be adjustable & selectable by the user) of the rated voltage for a minute, the load shall be transferred to the normal source. However the DG set shall continue running for 3 minutes and then stop.
- 19.11 If the DG set fails to start or fails to reach its operating speed in 25 seconds in three attempts the DG set shall automatically be disconnected and locked in isolated position.
- 19.12 The required power supply for the AMF system shall be through separate maintenance free batteries (and not DG starting batteries) of requisite capacity for one hour backup and shall be in the scope of Vendor.
- 19.13 The AMF panel shall include separate battery chargers for charging of DG set batteries & AMF panel batteries. The chargers shall have facility for simultaneous charging of respective batteries. The chargers shall be of approved capacity to cater to the battery requirements.
- 19.14 Audio-Video signal for fault due to protections shall be generated in the AMF panel.
- 19.15 The numerical type relays for over current, Short circuit, Earth fault, Over/under voltage, Over/under frequency, Reverse power, Differential protection, master trip relay and any other relay not specifically mentioned here but required for HT DG set are to be provided in the AMF panel.
- 19.16 Potential free contact shall be provided in the owner panel for DG breaker trip status. These contacts are to be wired to the AMF panel and necessary provision is to be provided in the AMF panel for generating audio-visual signal and tripping the DG set in case of any electrical fault.
- 19.17 AMF panel is to be mounted indoor near the HT/LT room.
- 19.18 Each control panel shall be provided with battery charger complete with float and boost charging arrangement both in auto and manual mode for the starting batteries of the respective DG sets.
- 19.19 **Control Wiring**
- 19.19.1 The panel board shall be completely factory wired and ready for external connections.
- 19.19.2 The wiring shall be carried out with flexible stranded PVC insulated copper conductor cables for 1100 volts grade.
- The size of wires shall be as follows:
- C.T. Circuit - 2.5 sq. mm copper
- V.T. & Control circuits - 1.5 sq. mm copper
- 19.19.3 All wiring shall be marked in accordance with IS-375. Numbered Ferrules reading from the terminals outwards shall be provided at both ends of all wiring for easy identification. These shall be interlocking type plastic ferrules.
- 19.20 **Circuit Breakers**
- 19.20.1 The circuit breakers shall generally comply with the requirements of IEC62271-100 (for VCB) and IEC 60694 (for common clause), having P2 category, capable of carrying the specified current at the site conditions and making/ breaking of the system fault current.

	TECHNICAL SPECIFICATION - DIESEL GENERATOR SET	PC183-TS-0839	0	
		Document No.	Rev	
		Sheet 25 of 45		

- 19.20.2 The circuit breakers shall be of 11KV, 3 phase, single break, single level, horizontal draw-out, horizontal isolation type. The medium of arc quenching shall be vacuum.
- 19.20.3 Type test certificates from an independent testing authority shall be furnished along with the offer, for each circuit breaker rating, which shall clearly prove the capability of circuit breakers and include the short circuit tests, temperature rise test, electrical overload tests and endurance test (both electrical and mechanical).
- 19.20.4 The circuit breakers shall be provided with motor wound spring closing mechanism and electrically and mechanically trip free and have anti pumping features.
- 19.20.5 The circuit breakers shall have three positions for service, test and isolated with the cubicle door closed, and position indicators provided to indicate the positions of the breaker. Stoppers shall be provided to prevent excessive movement of the breaker cradle than desired, for each position. Each position of the breaker shall have monitoring switch having 1 NO + 1 NC contacts.
- 19.20.6 Provision shall be made for testing the circuit breaker in test position.
- 19.20.7 Automatic safety shutters shall be provided to screen the cable and the bus bars spouts when the circuit breaker is withdrawn from the cubicle.
- 19.20.8 The circuit breakers shall be provided with an emergency manual trip device, mechanical 'ON' 'OFF' and 'ISOLATED' position indicators and operation counter.
- 19.20.9 Mechanical safety interlock shall be provided for safe operation movement of the breaker.
- 19.20.10 The closing coil and other associated auxiliary relays shall operate satisfactorily at all voltages between 85 to 110% of the rated control voltage. The tripping coil and other associated relays shall operate satisfactorily at all voltages between 70 to 110% of the rated control voltage.
- 19.20.11 Rated short circuit breaking capacity for HV Switchboard shall be 40 kA for 3 sec.
- 19.20.12 The bus-bars shall be for three phases. The bus-bars and connection shall be made of high conductivity copper of rectangular cross-section.
- 19.20.13 The bus-bars chamber shall be sufficiently spacious and shall have separate screwed covers for maintenance purpose. It shall be adequately ventilated and shall allow the escape of the hot gases.
- 19.20.14 The clearance and creepage distance shall be adequate to meet the BIL of the equipment.
- 19.20.15 Type test certificate from an independent testing authority shall be furnished along with the offer for each rating and type of circuit breaker.
- 19.20.16 Positive earthing of circuit breaker frame shall be maintained at every position of circuit breaker. The earthing contact shall be line/scraping type and not of point type. The circuit breaker shall have unbreakable phase barriers between the poles.
- 19.20.17 Tips of main contacts shall be silver plated and tips of arcing contacts shall have tungsten alloy or superior material fittings.
- 19.20.18 The circuit breaker shall have thermal relay with reset mode for spring charging motor protection.
- 19.20.19 Rack in / out of all the circuit breakers (Service / Test / Isolated Positions) shall be from outside of the panels i.e. without opening the breaker compartment door.

	TECHNICAL SPECIFICATION - DIESEL GENERATOR SET	PC183-TS-0839	0	
		Document No.	Rev	
		Sheet 26 of 45		

19.20.20 Automatic safety shutter, with Padlocking facility for locking in closed position, to completely cover the spouts for the bus-bars and cable connection when the breaker is withdrawn.

19.20.21 LOTO locking system to be provided for safety purpose while taking clearance for maintenance work. For this necessary Hasps and locks shall be provided in the switchboards

19.21 **Control Fuses**

The fuses shall be of non-deteriorating HRC cartridge link type and conform to IS: 2208. They shall be suitable for the load and the service required in the circuit.

19.22 **Current Transformers**

19.22.1 C.T's shall be cast resin emulated, accuracy class as per IS-2705, 1 for metering and SP/PS for protection.

19.22.2 All the C.T's shall be provided with terminals and shorting links. One of the terminals of the C.T.s shall be earthed. The polarity of the C.Ts shall be clearly marked.

19.23 **Voltage Transformer**

The V.T. shall be cast resin insulated having secondary terminal voltage of 110V unless specified otherwise and accuracy class of shall be 1 as per IS: 3155 and provided with primary / secondary fuses.

19.24 **Relays**

All protective relays (Microprocessor based) shall be provided in drawout and dust proof cases and shall be flush mounted type. They shall be fully tropicalised. Relays shall be of make and type as approved.

Microprocessor based relays shall have following protection as a minimum:

- i) IDMTL over current and Residual earth fault.
- ii) IDMTL standby earth fault.
- iii) Over voltage or under voltage
- iv) Loss of excitation.
- v) Over/under Frequency.
- vi) Apparatus thermal device.
- vii) Loss of excitation relay.
- viii) Stator earth fault relay.
- ix) Reverse power
- x) REF relay.
- xi) Differential Protection.
- xii) Lockout Relay*.
- xiii) Syncho check relay*.
- xiv) Negative phase sequence relay.
- xv) PT fuse failure relay.
- xvi) Trip circuit supervision relay* etc
- xvii) Hand reset tripping relay

	TECHNICAL SPECIFICATION - DIESEL GENERATOR SET	PC183-TS-0839	0	
		Document No.	Rev	
		Sheet 27 of 45		

Additionally one tripping relay having facility of Hand reset shall be provided.

All protection relay shall be numerical type and have generator comprehensive protection.

* Separate relay shall be provided and not as a part of Numerical relays.

19.25 **Battery Charger**

19.25.1 The Battery Charger shall be as per Technical Specification – Battery Charger..

19.25.2 Battery shall have adequate AH capacity & terminal voltage for continuous duty application and suitable for 6 Nos. of consecutive starts for the engine. The batteries shall be placed on a suitable battery stand coated with anti-acid paint inside the acoustic enclosure.

19.25.3 The charging of the batteries shall be through engine mounted Dynamo during running of the DG set. The provision of charging the starting batteries during DG set idle period shall also be provided through a suitable battery charger as specified above

19.25.4 The AMF control panel shall be complete with necessary control circuit fuses, nameplates, internal wiring, control terminals and cable glands & lugs.

19.25.5 The AMF control panel shall have provision for receiving starting impulse for the DG set from DG Power Distribution Board as well as to send out tripping impulses from AMF panel to the DG incomer breaker on DG Power Distribution Board.

19.25.6 All cable entries to the AMF panel shall preferably be from the bottom.

19.25.7 Automatic shutdown feature shall be provided for faults such as low lube oil pressure/ over speed/ high water temperature.

19.26 **Instruments and Metering**

19.26.1 All instruments shall be flush mounting type with square face of 96 sq. mm. They shall be tropicalised and dust tight. Make and type of instruments shall be as approved.

19.26.2 Marking of the scale shall be black on white background and suitable for direct reading.

19.26.3 Zero adjusters shall be provided for operation from the front of the cases.

19.26.4 All indicating instruments shall be moving iron spring controlled type of class 1.5 accuracy as per IS: 1248.

19.26.5 The KWH meter shall be as per relevant IS and provided with test blocks for current and voltage coils for testing them at site without interrupting their recording while in service.

19.26.6 The following instruments shall be provided.

- i) Voltmeter with selector switch
- ii) Ammeter with selector switch
- iii) Frequency meter
- iv) KW meter
- v) KWH meter

19.26.7 The instrumentation requirement shall include field / panel mounted instruments, push buttons, lamps, audio-visual alarm system and other accessories as required.

19.26.8 The provision required in the control panel board shall include the followings:

- i. Multipoint electronic self balancing temperature indicator with selector switch for generator winding.

**TECHNICAL SPECIFICATION - DIESEL GENERATOR SET**

PC183-TS-0839

0

Document No.

Rev

Sheet 28 of 45



- ii. Tachometer for engine speed.
- iii. Fuel oil day tank level indicator.
- iv. Audio-visual alarm system for:
 - a) Low lube oil pressure
 - b) Over speed of engine
 - c) High jacket water temperature
 - d) Low jacket water pressure
 - e) Winding temperature high
 - f) All shutdown condition
 - g) Other abnormal conditions, as required
- v. Shutdown system for:
 - a) Maximum jacket water temperature
 - b) Engine over speed
 - c) Minimum lube oil pressure
 - d) High winding temperature
 - e) Generator faults
 - f) Faults in the excitation system
 - g) Failure of engine to start after a preset time
 - h) Other faults, as required
- vi. Excitation control system complete with:
 - a) Rheostat for manual control
 - b) Automatic voltage regulator
 - c) Field discharge resistance
 - d) Diodes / Rectifiers
 - e) All other items, as required
- vii. Engine control system complete with:
 - a) Auto / manual switch
 - b) Control equipment and circuitry for Auto Mains Failure starting other than for type 'C' sets.
 - c) Push buttons and other control equipment for manual start.
 - d) Equipment and circuitry for pre-start priming, if required.
 - e) Equipment and circuitry for repeated attempt to start.
 - f) Indicating lamps for fail to start.
 - g) Audio visual alarm as specified and required.
 - h) Instrumentation as specified and required
 - i) Operation hour counter
 - j) All other items, as required

	TECHNICAL SPECIFICATION - DIESEL GENERATOR SET	PC183-TS-0839	0	
		Document No.	Rev	
		Sheet 29 of 45		

19.26.9 The field mounted Electronic bar type instrument instruments shall include the followings:

- a) Pressure gauge for for the following
 - At the lube oil header in the engine.
 - Discharge of lube oil pumps.
 - Lube oil cooler outlet.
 - At the jacket water inlet to the engine.
- b) Dial type thermometer for various bearings.
- c) Dial type thermometers for the following:
 - Lube oil outlet temperature.
 - Jacket water temperature at cylinder outlet or heat exchanger inlet.
 - Jacket water temperature at jacket water heat exchanger outlet.
- d) Tachometer for engine speed.
- e) Fuel oil day tank level indicator.
- f) Hour meter cum RPM indicator.
- g) Starting key switch.
- h) Other items, as required.

Above shall also give alarm/trip signals.

19.26.10 The supply shall be complete with all instrument erection materials with 10% extra provision.

19.26.11 All instruments, shall be suitable for site maximum ambient temperature, All electrical and electronic instruments shall be tropicalised and fungus proof.

19.27 **Signal Lamps**

LED type signal lamps shall be provided to indicate the various circuit conditions and these shall be placed at suitable height. The colour of the lamps for various functions shall be as follows:

- | | | |
|-------|---|---------------------------|
| Red | - | Circuit breaker 'ON' |
| Green | - | Circuit breaker 'OFF' |
| White | - | Trip circuit healthy |
| Amber | - | Alarm and auto trip fault |
| Blue | - | Non trip fault |

19.28 **Name Plate**

19.28.1 The panel board shall have a large name plate on the top to indicate its name and designation. Each feeder shall be provided with name plates. Each panel shall have name plates both in front and back.

19.28.2 All control switches, push buttons, lamps etc. shall have function identification labels.

19.29 **Cable Termination**

Necessary cable glands and lugs for power and control cables shall be provided.

	TECHNICAL SPECIFICATION - DIESEL GENERATOR SET	PC183-TS-0839	0	
		Document No.	Rev	
		Sheet 30 of 45		

20.0 ACCESSORIES

The D.G. set shall be complete with all required accessories, whether indicated or not, to make the installation complete in all respects and to ensure its safe and proper operation.

21.0 ACCOUSTIC ENCLOSURE

21.1 The acoustic enclosure shall meet the latest guidelines of CPCB/SPCB/MoE&F and its amendments as on date.

21.2 The dimensions of acoustic enclosure shall be sufficient to accommodate DG set, Dg starting batteries, engine controller & distribution board.

21.3 The acoustic enclosure shall be of modular construction, suitable for outdoor installation in the 'Open' and shall be fabricated with 2mm (mini.) thick cold rolled sheet steel. The enclosure shall have minimum two air tight doors on opposite sides (with neoprene rubber gasket/good quality long-life gaskets suitable for outdoor application) , fabricated of same material & thickness as stated above with lockable handles for accessing the DG set assembly.

21.4 Base frame shall be made out of ISMC of suitable sections or made out of sheet steel of 5 mm thickness.

21.5 Sound proofing of the enclosure shall be done with high quality rock / mineral wool / other material (CPCB approved), further covered with fibre glass tissue and perforated sheet.

21.6 The mineral / rock wool material / other approved (CPCB) material insulation of appropriate cube density & thickness shall be provided for CPCB stipulated insertion loss requirement.

21.7 Sound proofing shall be fire resistance and shall conform to applicable IS standards.

21.8 The acoustic enclosure shall be designed to meet the CPCB norms of minimum insertion loss of 25dB (A) at 0.5meter from the enclosure. The measurement for insertion loss shall be done at different points at 0.5m from the acoustic enclosure, and then averaged.

21.9 On outer surface of the enclosure shall be provided with an "Emergency-off" Push Button to trip the DG set in case of Emergency.

21.10 Doors for easy access to the DG Set shall be provided for easy inspection & maintenance. The doors shall be provided with quality EPDM gaskets to prevent leakage of sound.

21.11 Suitable arrangement for fresh air inlet and hot air outlet shall be provided.

21.12 Sufficient fluorescent tube lamp lighting shall be provided inside the enclosure.

21.13 The enclosure, after suitable pre-treatment, shall be painted with two coats of antirust paint followed by two coats of anticorrosive epoxy based paint.

21.14 All external hardware shall be of stainless steel of high tensile strength (i.e.) bolts of 10.9/8.8 grade and shall be passivated.

21.15 The enclosure shall be provided with external drain plug to drain lube oil & fuel.

21.16 Residential silencer shall be provided within the enclosure to reduce exhaust noise& sparks.

21.17 Adequate ventilation is to be provided to meet air requirement for combustion and heat removal.

	TECHNICAL SPECIFICATION - DIESEL GENERATOR SET	PC183-TS-0839	0	
		Document No.	Rev	
		Sheet 31 of 45		

- 21.18 Temperature inside the enclosure shall not exceed beyond 8-10°C above the ambient temperature near air suction point.
- 21.19 The enclosure shall be provided with control panel viewing window.
- 21.20 The enclosure shall have modular construction for easy assembling and dismantling.
- 21.21 Interconnection between silencer and engine shall be through stainless steel flexible hoses/pipe/bellow.
- 21.22 Attenuators shall be accommodated to control sound at air entry& exit in the enclosure.
- 21.23 Batteries shall be accommodated in a separate tray inside the enclosure.
- 21.24 The system shall be engineered to provide air inlet/exhaust with dust & acoustic control louvers for efficient air ventilation.

22.0 DG SETS RUNNING PHILOSOPHY

The diesel generator sets will be normally at rest when the Grid Power Supply is available as normal power source. In case of Grid Power Supply failure, the diesel generator shall be started as follows:

On failure of normal Grid Power Supply, DG sets shall start automatically after receiving signals at AMF. Arrangement for manual starting shall also be provided

As soon as the diesel generator set reaches its rated speed and generates its rated voltage (a period not exceeding 20 seconds), a voltage and frequency sensitive relay in the AMF (Control & Relay panel), shall permit the closing of DG Incomer VCB in Emergency Power Distribution Board.

When DG sets are running & grid power restores, restoration of Power will be without Break i.e. after synchronization of Normal & Emergency Power.

Three attempt starting facility shall be provided for all DG Sets. In case, the diesel engine fails to start and reach rated speed, it shall be disconnected and locked out automatically however Annunciation shall be provided in local DG control panel with a facility for repeat annunciation in Owner's panel if starting time of DG set shall exceed beyond 20 second and DG set not able to start even after 3 attempt.

23.0 BASE FRAME

Skid mounting type base frame, fabricated from suitable size MS channel, of heavy side members and cross members, providing common bed for engine and alternator, directly coupled together. The base frame shall have provision for grouting the Set on grouting bolts as well as fixing on the Anti-Vibration Mounts. Provision shall also be made in the base frame for lifting the Set.

24.0 AVM PADS

Anti-vibration Mounting Pads, as recommended by the set manufacturer shall be supplied with the DG set.

25.0 PIPING WORK

All Pipe work/piping with its fittings & accessories as required for DG set system shall be supplied and installed under the supervision of the bidder.

All interconnecting piping for combustion fuel oil system, cooling water system, lubricating oil system, exhaust system, starting system including pipes, fittings, valves etc. shall be supplied & installed under supervision of the bidder with the engine. All pipe supports, hangers

	TECHNICAL SPECIFICATION - DIESEL GENERATOR SET	PC183-TS-0839	0	
		Document No.	Rev	
		Sheet 32 of 45		

26.0 PAINTING

The enclosures, after suitable pre-treatment, shall be painted with two coats of anti rust paint followed by two coats of anti-corrosive epoxy based paints.

Acoustic enclosure shall be powdered epoxy coated to 80 micron thickness both inside and outside with glossy finish

27.0 TOOL KIT

Special tool kit for the DG Set required for operation & maintenance of DG set shall also be supplied along with DG set.

28.0 TESTS AND INSPECTION

28.1 All routine tests as per relevant standards shall be carried out in the presence of Owner's representative.

28.2 The D.G. set shall be tested for output, general performance, overloads and other tests sufficient to prove the correctness of the design both at works and at site.

28.3 Owner's representative shall be given minimum two weeks advance notice for witnessing the final testing. Type test certificates for machine of identical type/design/rating shall also be submitted for owner's review.

28.4 Manufacturer's internal test certificates for engine(s), alternator(s), NGR(s) & AMF panels etc., shall be furnished for review and vetting during inspection of combined DG assembly (without acoustic enclosure) at plant for partial load trials and functional checks.

28.5 Component of the engine shall be inspected and tested in the respective factory in accordance with the code / sound shop test procedure. MTC (material test certificate) for all major engine components shall be furnished by the vendor. For other remaining components material guarantee certificate shall be furnished.

28.6 Engine shall be performance tested by the Vendor in the respective manufacturer's works in accordance with BS ISO-3046 / ISO 3046/IS 10002 and manufacturer test report to be furnished.

28.7 Engine test power ratings and speed ratings shall be in accordance with BS ISO-3046/ ISO 3046/ IS 10000/ IS 10002 recorded to prove performance as per duty ratings for the following:

- a) Fuel consumption.
- b) Thermal efficiency (based on test data).
- c) Mechanical efficiency (based on test data).
- d) Maximum compression value.
- e) Maximum combustion pressure.
- f) Temperature value.
- g) Power consumption of separately run auxiliaries if any.
- h) Governor test.
- i) Exhaust gas analysis (for one engine only)
- j) Material test certificate of critical components.
- k) Any other test as required.

	TECHNICAL SPECIFICATION - DIESEL GENERATOR SET	PC183-TS-0839	0	
		Document No.	Rev	
		Sheet 33 of 45		

28.8 First stage Factory Acceptance Test of DG Set shall be carried out including but not necessarily limited to the following:

- i) A general visual check shall be carried out. This shall cover measurement of overall dimensions, locations, number and type of devices, name plates, ratings, settings, terminals, location and wiring etc., as per approved drawings of supplier.
- ii) Partial load test (for at least two hours of running for each DG Set) and functional checks shall be conducted for each one of the assembled DG set at OEM/ vendor works.
- iii) During routine & partial load testing of DG set at vendor/ OEM works the following tests shall be done:
 - Functional tests to establish the performance as per specifications
 - Mechanical/electrical operational check
 - Verification of Bill of Materials
 - Dimensional and alignment checking
 - Checking of engine controller
 - 'Checking of AMF Panel
 - Checking of engine safety devices
 - Phase sequence test
 - Insulation resistance test on alternator windings and panels
 - Automatic starting up and interlock checks
 - Checking of control, protection and status contacts of panels
 - Partial load test
- iv) Confirmation regarding supply of licensed copy of Software used for AMF logic and engine controller (if any) in the name of 'Talcher Fertilizer Limited' with required number of user-licenses, deemed as part of supply by vendor.

28.9 For components/equipment bought from other sub-suppliers, certified test reports of routine tests carried out at the respective manufacturer's works shall be submitted.

28.10 The tests to be carried out on various items are given below.

- a) Diesel Engine
 - Routine test as per relevant Indian / British / National standards.
 - Test for speed regulation with a sudden loading of 50% of rated capacity with zero base load.
 - Starting time of the engine from zero to full speed from the instant of start command.
 - Operation check for satisfactory operation.
 - Load test and measurement of fuel consumption.
 - 100% load for 4 hrs.
 - 110% load for 1 hr.
 - 75% load for 1/2 hr.

	TECHNICAL SPECIFICATION - DIESEL GENERATOR SET	PC183-TS-0839	0	
		Document No.	Rev	
		Sheet 34 of 45		

➤ 50% load for 1/2 hr.

All parameters such as jacket water temp., lube oil pressure and temperature will be checked.

b) GENERATOR

- Routine test as per IS 4722.
- Voltage regulation from no load to full load.
- Voltage trimming facility check.

c) Control Panel

- Routine tests as per IS 3623.
- Operation tests for AMF operation, operation of various devices and meters etc.

28.11 Following tests (along with the tests specified above) shall be performed on each unit and results shall be recorded.

a) DG Set load trials at 50%, 75%, 100% & 110% load. Following parameters shall be measured at every 15 minutes interval to work out efficiency, fuel consumption & voltage regulation and to ensure satisfactory working.

- Voltage, current, power factor, engine speed, frequency.
- Excitation voltage & current.
- Fuel readings.
- Lube oil pressure.
- Jacket water temperature & exhaust temperatures before & after turbocharger.
- Noise level as per State PCB prevailing norms

28.12 Bidder shall perform the following tests at site to the satisfaction of owner:

- a) Automatic starting up and interlock.
- b) Governor response.
- c) Voltage regulator response.
- d) Speed/Voltage droop setting for parallel operation.
- e) Noise level as per State PCB prevailing norms
- f)

28.13 In any case the Bidder shall establish the performance of DG set ON LOAD at site upon installation during commissioning for final acceptance by the Owner. Load for ON LOAD testing at site shall be arranged by the Owner. Bidder to provide technical assistance for arranging the load at site.

28.14 First fill of lubricants during trail run of each DG set at site shall be provided by Vendor. Fuel (diesel) for trail run shall be provided by Owner.

28.15 Final acceptance of DG Set assembly shall be given by Owner only after successful erection, testing and commissioning of the combined set with all panels at site. All the as-built drawings and licensed software shall be provided by the vendor prior to request for final acceptance.

	TECHNICAL SPECIFICATION - DIESEL GENERATOR SET	PC183-TS-0839	0	
		Document No.	Rev	
		Sheet 35 of 45		

28.16 In addition, the equipment shall be subjected to stage inspection during process of manufacture at works and site inspection.

28.17 These inspections shall, however, not absolve the Contractor free from his responsibility for making good any defect which may be noticed subsequently.

29.0 SPARES

29.1 Commissioning Spares: Commissioning spares, as required, shall be supplied with the main equipment. Item-wise list of recommended commissioning spares shall be furnished for approval.

29.2 Spares for 2 Years operation (Mandatory), as specified shall be supplied.

29.3 Recommend 2 years Operational Spares (other than mandatory spare) along with recommended quantity & item-wise unit price shall be furnished.

29.4 All spare parts shall be identical to the parts used in the equipment

30.0 PACKING

30.1 The equipment shall be properly packed before despatch to avoid damage during transport, storage and handling.

30.2 The equipment shall be wrapped in polythene to make it water proof. Bags of silica gel shall be kept inside to absorb moisture present during transport and storage. An additional wrapping with bitumen paper shall also be provided before the equipment is packed in wooden crates.

30.3 A sign indicating the position of the equipment placed during transport and storage shall be clearly marked. Also proper arrangement shall be provided to handle the equipment.

30.4 The equipment / components supplied shall be transported to site using proper packing to prevent entry of rainwater, dust and damage to the finish during handling & shipment. Packing shall have proper arrangement for handling. Inside of the packing shall be provided with a trapper to avoid ingress of moisture. Spares shall be separately packed and shipped along with the DG set. Packing list shall be supplied along with the material. Each package shall have labels to show purchaser name, purchase order, equipment packed, equipment number, Suitable lifting lugs etc., shall be provided and lifting points clearly marked on each of the packages.

30.5 Necessary Cable end lugs & cable glands required for termination of cables on the Alternator, Engine Control Panel and other panels etc., shall be provided.

30.6 The unit shall be packed suitably to facilitate installation and transportation. During transport, care shall be taken to avoid damage to paint or accessories of the equipment if any damage is caused during transport, the Bidder shall repair the same, free of cost.

31.0 DRAWING AND DOCUMENTS

31.1 Drawings and documents as per Annexure-I shall be supplied unless otherwise specified.

31.2 The vendor shall develop his own general arrangement and schematic drawing adding necessary auxiliary devices, accessories, components specific to supplied equipment etc., which are required for safe convenient, efficient and proper operation of the offered DG set assembly.

31.3 The Owner's approval of the drawings shall not relieve the vendor of his responsibility for supplying equipment conforming with the relevant specification and standards or any mistakes, errors or omissions in the drawing.

31.4 All drawings and documents shall have the following descriptions written boldly.

	TECHNICAL SPECIFICATION - DIESEL GENERATOR SET	PC183-TS-0839	0	
		Document No.	Rev	
		Sheet 36 of 45		

- Name of client
- Name of consultant
- Enquiry / Order Number with plant / project name
- Code No. and Description

ANNEXURE – I
DOCUMENTATION FOR DIESEL GENERATOR SET

Sl.No.	Description	Documents Required (Y / N)			
		With Bid	For Approval	For Information	Final
1.0	Data sheet , duly filled-in	Y	Y	-	Y
2.0	Equipment layout drawing including the location of engine, fuel oin tank, control panel etc. With dimensions.	Y	Y	-	Y
3.0	Civil drawing for foundation with all details	N	Y	-	Y
4.0	GA drawing of Stack and its supports.	N	Y	-	Y
5.0	Control & schematic diagram		Y	-	Y
6.0	Cable schedule	N	Y	-	Y
7.0	Complete detailed SLD	N	Y	-	Y
8.0	Engine battery capacity calculation	N	Y	-	Y
9.0	Drawings & procedure for fabrication/insulation cladding and erection	N	-	Y	Y
10.0	Terminal arrangement drg. and Interconnection.	N	Y	-	Y
11.0	Sectional view of D.G. Set	N	-	Y	Y
12.0	Earthing layout	N	Y	-	Y
13.0	Illustrative and descriptive literature.	N	-	-	Y
14.0	Catalogue for bought out accessories.	N	-	-	Y
15.0	Installation operation & maintenance manual	N	-	-	Y
16.0	Type test certificates for engine, alternator and circuit breaker	N	-	Y	Y
17.0	Guarantee certificate	N	-	-	Y
18.0	Spare parts list with identification	N	-	Y	Y
19.0	Calculations for justifying DG set size offered with respect to load and starting of largest load.	N	-	Y	Y
20.0	Electrical wiring & schematic Diagram along with cable schedule and general arrangement drawing for control panel	N	Y	-	Y

Note:

	TECHNICAL SPECIFICATION - DIESEL GENERATOR SET	PC183-TS-0839	0	
		Document No.	Rev	
		Sheet 38 of 45		

1. 4 hard copies & 1 soft copy shall be supplied for approval after order within 4 weeks from the date of LOI.
2. 8 hard copies & 2 soft copies in Pen Drive shall be submitted as final documents prior to despatch of the equipment. These shall be made in sets and supplied in fine plastic coated folder.

Y - Yes, N – No

	TECHNICAL SPECIFICATION - DIESEL GENERATOR SET	PC183-TS-0839	0	
		Document No.	Rev	
		Sheet 39 of 45		

DATA SHEET

a) ALTERNATOR

S. N.	Details of Particulars	Details
1	Make (as per approved vendor list attached elsewhere) Details of alternator manufacturer along-with supply record and performance test certificates to be submitted	*
2	Excitation Type Brushless, Separately Excited (PMG), self regulated	*
3	Governing Specifications	IS : 4722
4	Full load output in KVA	
5	Output voltage level	11 kV
6	Ingress protection class of enclosure	IP 23
7	Speed/ Frequency	1500 RPM, 50 Hz
8	No. of phases	3
9	Is neutral brought out separately?	*
10	Regulation band of voltages	Maximum $\pm 1\%$ of rated voltage
11	Current carrying capacity of winding	* Amp.
12	Percentage imbalance permissible (As per IS: 4722) At Full load Other loads	* *
13	Short time overload at: 110 % load 150% load	1 Hour in 12 hours *
14	Efficiency At Rated P.F. 100 % load 75 % load	* * *
15	Insulation class of stator	Class F with Temp. rise limited to class B or Class H with Temp. rise limited to class F
16	Insulation class of rotor	Class F with Temp. rise limited to class B or Class H with Temp. rise limited to class F
17	Excitation method	Brushless
18	Excitation amps at full load	*
19	Excitation voltage	*
20	Exciter type	*
21	Specification for exciter	*
22	Fault level	*
23	Reactance(Saturated Values in %)	Saturated Values: $X_d = \%$, $X_d' = \%$, $X_d'' = \%$
24	Three phase sustained SC current	*
25	Transient voltage drop on 100% step loading/ unloading.	*
26	AVR make, type & response time	*
27	Head room needed for lifting/servicing	*
28	Weight of alternator	*
29	Direction of rotation	CCW from NDE
30	Details of other major unit assembled	*

 पी डी आई एल PDIL	TECHNICAL SPECIFICATION - DIESEL GENERATOR SET	PC183-TS-0839	0	 Tajher Fertilizers
		Document No.	Rev	
		Sheet 40 of 45		

31	Rating of each space heater (in Watt)	*
32	Details of control cable between AMF Panel and the Alternator & HT breaker	

b) ENGINE

S.No.	DESCRIPTION	DETAILS
1.	Model No.	*
2.	Manufacturer (as per approved vendor list attached elsewhere) Details of engine manufacturer along-with supply record and performance test certificates to be submitted	*
3.	No. of Cylinders	*
4.	Bore	*
5.	Stroke	*
6.	Mean Piston speed	*
7.	Rated RPM	*
8.	Compression Ratio	*
8(a)	Continuous HP at Max. Continuous rated RPM	*
9.	Absorbed HP & RPM at site	*
10.	Intermittent HP (1 Hr. in 12 Hrs.)	*
11.	Continuous Max. rated RPM	*
12.	Normal working Range (RPM)	*
13.	BMEP – Continuous rating	*
14.	Max. Firing Pressure	*
15.	Piston area	*
16.	Rotation (standard/counter clockwise)	*
17.	Mechanical Efficiency at rated HP & rated RPM	*
18.	Thermal Efficiency at rated HP & rated RPM	*
19.	Thermal Load Factor (BHP/sq. in. of piston area.	*
20.	Type of Governor	*
21.	Weight of the Engine without accessories (Tons)	*
22.	Power Weight Ratio	*
	FUEL SYSTEM	
25.	Specific Fuel Consumption at rated HP & rated RPM	*
26.	Fuel Consumption @ 3/4 Load	*
27.	Fuel Consumption @ 1/2 Load	*
	LUBRICATION	
28.	Lube Oil Sump Capacity	*
29.	Lube Oil Pressure at rated RPM	*
30.	Lube Oil Consumption (at rated HP & rated RPM Subject to tolerance of 10%)	*
31.	Lube oil Pumps	*



TECHNICAL SPECIFICATION - DIESEL GENERATOR SET

PC183-TS-0839

0

Document No.

Rev

Sheet 41 of 45



S.No.	DESCRIPTION	DETAILS
COOLING SYSTEM		
32.	Normal Jacket water outlet Temperature	*
33.	Normal Lube oil Outlet Temperature	*
34.	Engine Jacket water system Volume	*
35.	Jacket water Pump Flow at rated RPM	*
36.	Heat rejection to Jacket water at max. Cont. HP	*
37.	Heat rejection to Lube Oil at max. Cont. HP	*
38.	Heat rejection to Charge air at max. Cont. HP.	*
39.	Cooling system details	*
EXHAUST SYSTEM		
40.	Exhaust gas Volume at * deg.C	*
41.	Exhaust Gas temp. at stack	*
42.	Max. permissible Exhaust back pressure	*
43.	Exhaust outlet Bore at adopter	*
44.	Smoke level	*
45.	Exhaust system details	*
MATERIAL OF CONSTRUCTION		
46.	Bedplate	*
47.	Crankshaft	*
48.	Camshaft	*
49.	Connecting rod	*
50.	Piston	*
<u>PISTON RINGS</u>		
51.	Top	*
52.	2 nd /3 rd	*
53.	Scrapper rings	*
54.	Valve springs	*
55.	Cylinder liner	*
56.	Camshaft gears	*
57.	Cylinder Head	*
58.	Ex. Valve Seats	*
59.	Inlet Valve	*
60.	Exhaust valve	*
OTHER DETAILS		
61.	Fly Wheel details	*
62.	Damper details	*
63.	Flexible spacer Coupling details (between Engine and gear box, Gear box and Pump)	*
Maintenance Free Lead Acid Battery		
64.	Make, AH Capacity, Voltage, Number	*
65.	Whether capable for 3 consecutive start	*

 पी डी आई एल PDIL	TECHNICAL SPECIFICATION - DIESEL GENERATOR SET	PC183-TS-0839	0	 Tajher Fertilizers
		Document No.	Rev	
		Sheet 42 of 45		

S.No.	DESCRIPTION	DETAILS
	Fuel Tank Details	
66	Capacity	*
67	Whether provided at the base or separate	*
68	Explosion Proof level switches with potential free contacts for alarm and tripping – High level, low level, low low level	*
69	Fuel level Indicator provided	*
	Engine Controller	
70	Make & Model	*
71	Auto Load Management System	Yes/No
72	DG operation in individual / parallel	*
73	IP class (IP-22) of engine controller	*

c) NGR & NIS PANEL

SN	DESCRIPTION	DATA
1.	Service	Outdoor
2.	___KV, 3 Pole, Isolator with 4 NO+4NC Auxiliary contacts	* Amp, * Make
3.	Neutral Grounding Resistor, ___ KV, 10 seconds, suitable for 375 degree C temperature rise over ambient – 1 set	* Ohms, * Make
4.	CURRENT TRANSFORMERS EPOXY RESIN CAST DUAL CORE CT'S WITH STR-25 KA for 1 sec. BURDEN –15 VA CLASS – 1.0 (Metering) / 5P10 (Protection) / PS (Differential)	Make The CT characters tics are to be matched with CT's installed in Owner's HT panel at the time of drawing approval
a	Three numbers for Differential Protection	* make, */1/1 A
b	One number for neutral	* make, */1/1 A
5.	Approx panel dimensions Width Depth Height Sheet steel thickness Weight	*mm * mm * mm 14 SWG – Doors 16 SWG – Partitions *



TECHNICAL SPECIFICATION - DIESEL GENERATOR SET

PC183-TS-0839

0

Document No.

Rev

Sheet 43 of 45



	ii) Whether panel dust & vermin proof.	Shall be dust & vermin proof.
	iii) Panel IP class	IP – 55

d) AMF PANEL

S. N.	Item	Data
1	1 SET PLC comprising of :	Make
	1 no. CPU	*
	2 nos. BUS unit	*
	3 no. Input modules	8 Channels each
	3 nos. Output modules	8 Channels each
	1 no. EPROM	*
2	Software for PLC	*
3	Mains Voltage Monitor	EG / PIC
4	Alternator Voltage Monitor	EG / PIC
5	Hooter	Hella / Vaishno
6a	BATTERY CHARGER with Trickle & Boost charger capable to cater the charging requirement of starting batteries of DG set	
	a) Make	*
	b) Voltage	*
	c) AH capacity	*
6b	BATTERY CHARGER with Trickle & Boost charger capable to cater the charging requirement of AMF panel batteries	
	a) Make	*
	b) Voltage	*
	c) AH capacity	*
7	Metering:-	
	a) CTs (as per requirement)	*
	b) Ammeter.	
	c) Voltmeter.	
	d) Power factor meter.	
	e) Frequency meter.	
	f) Ammeter & voltmeter for charging of DG battery.	
	g) Ammeter & voltmeter for charging of AMF panel battery.	
8	16 point window Annunciator	Minilec / EG
9	Auxiliary contactors (As required)	
10	MCBs (As required)	
11	1 no. AUTO/ MANUAL /OFF switch	
12	Push buttons (as required)	
13	Indicating Lamps (as required)	
14	1 No. cooling fan	Rexnord

 पी डी आई एल PDIL	TECHNICAL SPECIFICATION - DIESEL GENERATOR SET	PC183-TS-0839	0	 Tata Fertilizers
		Document No.	Rev	
		Sheet 44 of 45		

S. N.	Item	Data
15	Relays (Hard Wired)	
	a) Type	*
	b) Make	
16	PANEL MAKE	*
17	PANEL IP CLASS (IP4x)	*

e) Distribution Panel

S. N.	Item	Data
1	Details of feeders for auxiliaries with requisite spare feeders	
a	Incoming Feeder TPN	*
b	DOL feeders TPN	*
c	MCB feeders, TPN	*
d	SFU feeders, TPN	*
e	Spare feeders 32 A TPN	*

f) HV circuit breaker

GENERAL		AMBIENT CONDITION	
Ref. Stds. :	IS <input checked="" type="checkbox"/> IEC <input type="checkbox"/>	Temp. Max./Min./Design Ref. : 46/1/50°C	
Encl. Docs. :	<input checked="" type="checkbox"/>	Relative Humidity 10%	Alt. above sea <1000 M
Make :		ATMOSPHERIC POLLUTION	
Maker's Ref. No. :		Dusts : Coal Dust & Urea Dust	
		Vapour : Ammonia & Highly corrosive	
		LOCATION	
		Indoor <input checked="" type="checkbox"/>	Outdoor <input type="checkbox"/>
		Gr. Floor <input checked="" type="checkbox"/>	1 st floor <input type="checkbox"/>
ADDL. SCOPE	Incoming Bus Duct	<input type="checkbox"/>	Tie Bus Duct <input type="checkbox"/>
	Erection & Comm.	<input checked="" type="checkbox"/>	Supervision of Erection Comm. <input type="checkbox"/>
TESTS:	Routine <input checked="" type="checkbox"/>	Type <input type="checkbox"/>	Others <input type="checkbox"/>
BASIC DATA			
TAG NO. & QTY.	Item No.		
	Switch board No.		
	Description	11 KV Switchboard	
REFERENCE DRAWINGS	Single Line Diagram	--	
	Feeder Details	--	
	Auto Trip Alarm Scheme	--	
	Non Trip Alarm Scheme	--	
	Trip Ckt. Supervision Scheme	--	
	Auto C/O Scheme	--	
	P.T. Bus Arrangement	--	
SYSTEM DETAILS	Rated Voltage with Variation	11 KV ± 10%	
	Rated Frequency with Variation	50 Hz ± 5%	
	Highest System Voltage	12 KV	
	Combined V & F Variation	± 10%	
	No. of Phases & Wires	3 Phase & 3 Wire	
	Insulation Level	70 KV _P / 28 kV BIL	
	Fault Level	750 MVA for 3 sec.	
	Earthing Mode	Non effectively earthed through resistor	
BUS BARS	Rating	Continuous	

	TECHNICAL SPECIFICATION - DIESEL GENERATOR SET	PC183-TS-0839	0	
		Document No.	Rev	
		Sheet 45 of 45		

CIRCUIT BREAKER	Short Time for		40kA	
	Type of Insulation		heat shrinkable sleeve	
	Type		Vacuum Circuit Breaker	
	Breaking Capacity	Symmetrical	40 kA	
		% DC	As per Generator requirement	
Making Capacity (peak)		110 kA		
CONTROL SUPPLY	Closing & Indication		110V DC	
	Tripping		110V DC	
	Alarm / Signal		110V DC (Provided by Bidder)	
	Space Heater		240V AC Non Ups Supply	
MISC. DATA	Cable Entry	Top /	Bottom	
	Dummy Panel Reqd.	Yes /	No	
	Width of Dummy Panel		--	
	No. of Dummy Panel		--	
	PAINTING	Type	Epoxy Based	
		Shade	631 of IS:5	
	Spares Parts Reqd. for a Period of		2 Years	

Note:

1. Information/data marked (*) above to be furnished by the bidder.
2. The bidder may supplement the data sheet to suit the particular design and model of DG Set offered and ensure that all relevant technical data and information are included in the data sheet.
3. Complete technical data on all auxiliary items such as governor, pumps, motors (if any), starting system, instrumentation and control system, etc. shall be included in the data sheet.
4. The materials details for the above items as applicable shall also be furnished.
5. Data wherever given in data sheet by Owner, is to be confirmed by bidder.
6. Bidder to furnish technical catalogue of the offered engine alone with the above data sheet.
7. Separate sheet to be in filled in with all required details for Micro Processor based system.

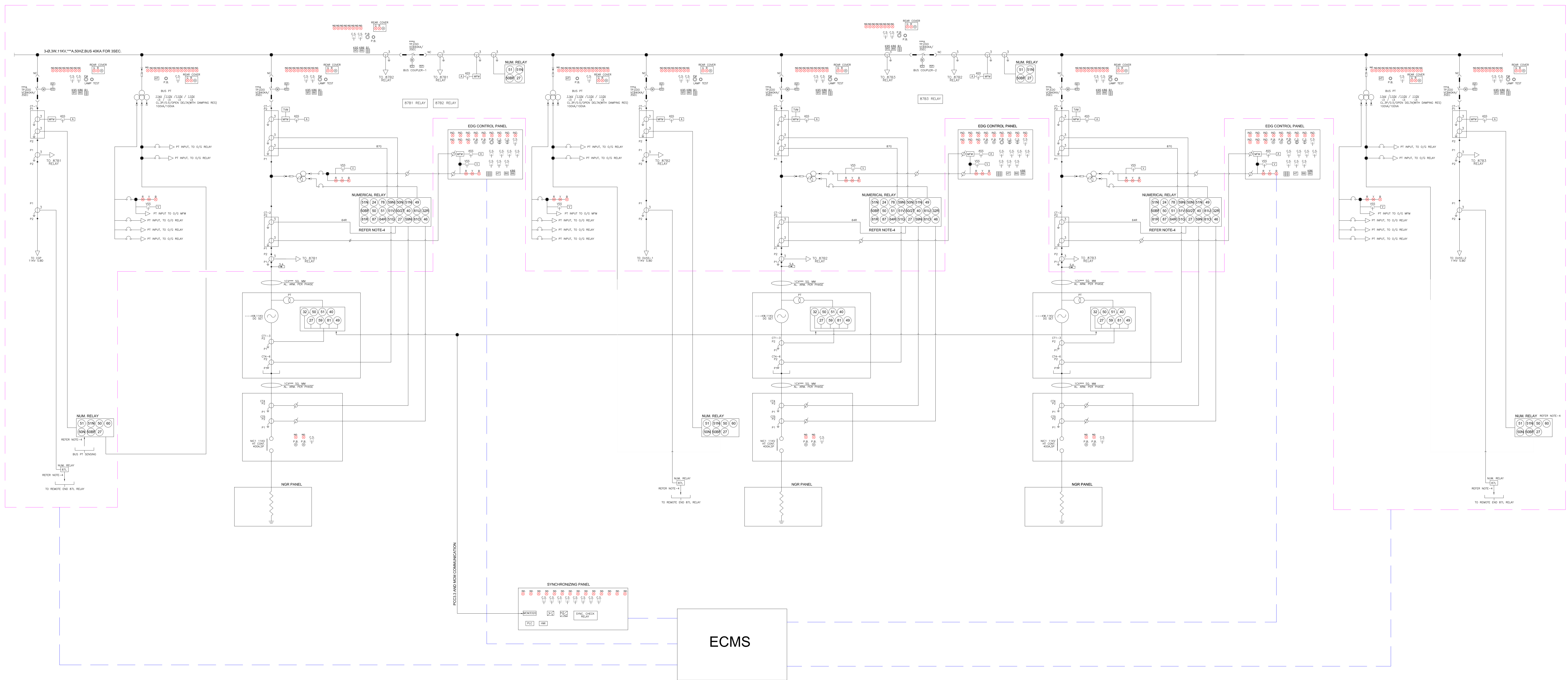

S.No.	SYMBOL	DESCRIPTION	S.No.	SYMBOL	DESCRIPTION
1		DRAW OUT TYPE VACUUM CIRCUIT BREAKER	15		TRI VECTOR METER
2		SURGE ARRESTER	16		SHUNT/CLOSING COIL
3		CURRENT TRANSFORMER	17		BREAKER CONTROL SWITCH
4		POTENTIAL TRANSFORMER	18		EMERGENCY STOP PUSH BUTTON
5		NEUTRAL LINK	19		SELECTOR SWITCH (ASS.VSS,A/M & L/R)
6		EARTHING	20		TOGGLE SWITCH
7		INDICATING LIGHT	21		GENERATOR
8		ILLUMINATING TYPE PUSH BUTTON	22		ANALOG METER
9		PUSH BUTTON	23		ANALOG VOLTMETER/AMMETER
10		SPRING RETURN TYPE PUSH BUTTON	24		MULTIFUNCTION METER
11		OUT GOING TERMINAL	25		DC AMMETER/VOLTMETER
12		CT SHORTING TERMINAL	26		ANNUNCIATOR
13		TRANSFORMER	27		SHIELDED WIRE
14		NEUTRAL GROUNDING RESISTOR	28		VACUUM CONTACTOR

DEVICE NUMBER	ANSI STANDARD DESCRIPTION
24	V/Hz OR OVERFLUXING
27	UNDERVOLTAGE RELAY
32R	REVERSE POWER
40	LOSS OF EXCITATION
46	STATOR CURRENT UNBALANCE
49	THERMAL OVERLOAD
27/50	ACCIDENTAL GENERATOR ENERGIZATION
50	INSTANTANEOUS OVERCURRENT
50N	NEUTRAL INSTANTANEOUS OVERCURRENT
51	OVERLOAD
51G	GROUND TIME OVERCURRENT
51N	NEUTRAL TIME OVERCURRENT
51V	VOLTAGE RESTRAINED TIME OVERCURRENT
52BF	BREAKER FAILURE ALARM
59N	NEUTRAL OVERVOLTAGE
60	VOLTAGE OR CURRENT BALANCE RELAY
64R	RESTRICTED EARTH FAULT
78	OUT-OF-STEP TRIPPING
81O	OVER FREQUENCY
81U	UNDER FREQUENCY
86	MASTER TRIP
87	DIFFERENTIAL PROTECTION
87B	BUS DIFFERENTIAL
87L	SEGREGATED LINE CURRENT DIFFERENTIAL
95	TRIP CIRCUIT SUPERVISION

RELAY	NOTATION	DESCRIPTION
87L	K87L	LINE DIFFERENTIAL
87B	K87B	BUS DIFFERENTIAL
85	K95	TRIP CKT. SUPERVISION
86	K86	MASTER TRIP
87	K50	OVERCURRENT

GENERAL NOTES:

- ALL BREAKERS ARE DRAW OUT TYPE AND 40KA FOR 3SEC.
- CABLE ENTRY FROM BOTTOM ONLY.
- PROTECTION RELAYS ARE NUMERICAL TYPE.
- NUMERICAL RELAYS SHALL HAVE IEC 61850 COMMUNICATION FACILITY INTERFACE VIA ETHERNET WITH LMS.
- ALL INDICATING LAMPS SHALL BE LED TYPE.
- ANNUNCIATOR SHALL BE MICROPROCESSOR BASED.
- ALL PANEL SHALL BE INDOOR TYPE.
- CONTROL SUPPLY SHALL BE 110VDC FROM BATTERY BANK AND 24V DC FOR DC CONTROLLER.
- 11KV BUSBAR SHALL BE MADE OF HIGH CONDUCTIVITY ELECTROLYTIC GRADE COPPER.
- INDICATING PUSH BUTTON & CONTROL SWITCH SHALL AS PER TENDER REQUIREMENTS.
- THIS IS INDICATIVE SLD, DETAILED SLD SHALL BE DEVELOPED BY CONTRACTOR.

FOR TENDER PURPOSE ONLY

REV.	DATE	DESCRIPTION	SS	AP	SKB
0	06.09.23	ISSUED FOR TENDER			
			PPD.	CKD.	APPD.
PROJECT:-		EMERGENCY DIESEL GENERATOR PKG. FOR COAL BASED FERTILIZER PROJECT	REV. 0		
TITLE:-		SLD 11KV EMERGENCY POWER DISTRIBUTION SCHEME	SHEET 1 OF 1		
			SCALE: N.T.S.		
			DRG. NO.- PC183-1251		
			FILE:		
		प्रोजेक्ट्स एंड डेवलपमेंट इंडिया लिमिटेड नोएडा PROJECTS & DEVELOPMENT INDIA LTD.-NOIDA			

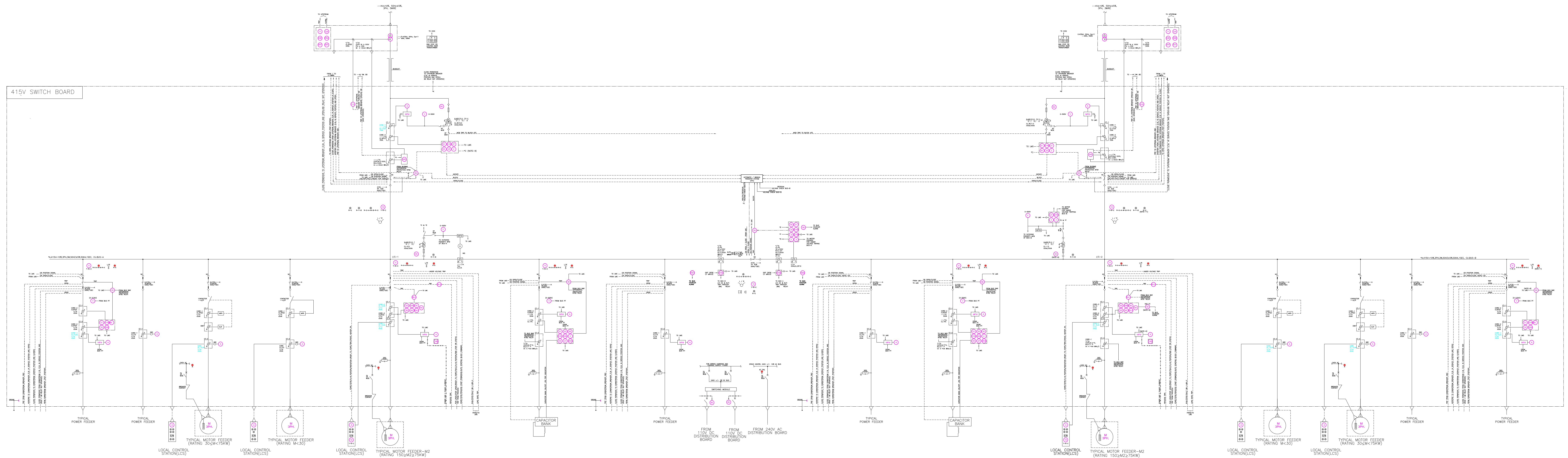

NOTE:-

- COMMUNICATION PROTOCOL SHALL BE AS FOLLOWS:-
 - NUMERICAL RELAY-IEC61850
 - MULTIFUNCTION METER (MFM)-MODBUS RTU
- AUTO CHANGE OVER LOGIC BETWEEN INCOMERS AND BUS COUPLER SHALL BE DEVELOPED IN NUMERICAL RELAY
- COMMANDS/INDICATION TO/FROM LMS SHOWN IN SLD ARE INDICATIVE.
- TNC SWITCH SHALL BE ABLE TO CLOSE ONLY IN TEST POSITION FOR ALL MOTOR FEEDERS
- FOLLOWING MINIMUM METERING SHALL BE PROVIDED ON MULTIFUNCTION METER :-
 - 3 PHASE CURRENT
 - LINE VOLTAGES
 - POWER FACTOR & FREQUENCY
 - KW,KVAR,KVA,KWH, & KVARH
 - HOUR RUN (ONLY FOR MOTOR FEEDER)
- COMMON ALARM CIRCUIT FOR HOOTER & BUZZER SHALL BE PROVIDED IN BUS COUPLER.
- LAMP TEST PUSH BUTTON SHALL BE PROVIDED.
- ALL RELAYS SHALL BE NUMERICAL TYPE UNLESS SPECIFICALLY MENTIONED IN SLD AND EXCEPT THE FOLLOWING:-
 - PT FUSE FAILURE RELAY(60)
 - AC/DC SUPPLY SUPERVISION RELAY (80)
 - TRANSFORMER LOCKOUT RELAY (86T)
 - TRIP CIRCUIT SUPERVISION RELAY (95)
 - BUS BAR DIFFERENTIAL SUPERVISION RELAY (95B1 & 95B2)
 - MOTOR FEEDER
 - 86-1 FOR ELECTRICAL TRIP (HAND RESET)
 - 86-2 FOR PROCESS TRIP (SELF RESET)
 - ALL FEEDER
 - 86 ELECTRICAL TRIP (HAND RESET)
- SIGNALS/INDICATIONS TO/FROM DCS SHOWN INN SLD ARE INDICATIVE. AND SHALL BE CONFIRMED DURING DETAIL ENG.
- CIRCUIT BREAKER 'ON' , 'OFF' INDICATION SHALL BE PROVIDED AT THE BACK OF EACH PANEL. ALTERNATIVELY ALARM SHALL BE PROVIDED IN CASE PANEL BACK DOOR IS OPENED WITH BREAKER 'ON'.

LEGENDS:-

MFM	MULTI FUNCTION METER	PR	REVERSE POWER RELAY
OC	OMFL OVER CURRENT RELAY	DOC	DIRECTIONAL OVER CURRENT RELAY
EF	TEMP EARTH FAULT RELAY	ROFR	RATE OF CHANGE OF FREQUENCY RELAY
CS	TRIP CIRCUIT SUPERVISION RELAY	UFR	UNDER/OVER FREQUENCY RELAY(40/60)
UV	UNDER VOLTAGE RELAY	DEF	DIRECTIONAL EARTH FAULT RELAY
TSR	TSR	LMS	LMS - LOAD MANAGEMENT SYSTEM
SCR	SYNCHRO CHECK RELAY	ICOG-PNL	ICOG-PNL - INCOMING CUM OUTGOING PANEL
LD	LINE DIFFERENTIAL RELAY	NDR	NDR - NEUTRAL GROUNDING RESISTOR
DOC	DIRECTIONAL OVER CURRENT RELAY	VC	VC - VACUUM SENSOR RELAY
BEF	BACKUP EARTH FAULT RELAY	VSR	VSR - VOLTAGE SENSOR RELAY
LO	LOOK OUT RELAY	VMS	VOLTMETER ALONG WITH VSS
TNC	TNC SWITCH	DM	DIGITAL AMMETER ALONG WITH ASS
OL	OIL LEVEL INDICATOR WITH CONTACTS	SPD	SURGE PROTECTION DEVICE
PR	PRESSURE RELAY DASH/PSM		
TR	TEMP. RELAY FOR WINDING		
TO	TEMP. RELAY FOR OIL		
LR	LOOK OUT RELAY(HAND RESET)-TRANSFORMER		
IO	INSTANT OVER CURRENT		
IOGR	INSTANT OVER CURRENT GROUND FAULT RELAY CONNECTED IN RESONANT WAY		
OV	OVER VOLTAGE RELAY		
DF	DC SUPPLY FAILURE		
UVTR	UNDER VOLTAGE RELAY TO INHIBIT MOTOR FEED TRIP		
VF	VT FAILURE		

THIS IS CONCEPTUAL SLD. DETAILS SLD SHALL BE PREPARED BY BIDDER & SUBMITTED WITH BID

0	06.09.23	ISSUED FOR TENDER	SS	AP	SKB
REV.	DATE	DESCRIPTION	PPD.	CKD.	APPD.
		CLIENT:- TALCHER FERTILIZER LIMITED	REV. 0	SHEET 1 OF 1	
		PROJECT:- EMERGENCY DIESEL GENERATOR PKG. FOR COAL BASED FERTILIZER PROJECT	SCALE: N.T.S.		
		TITLE:- TYPICAL 0.415V SW. BD. SINGLE LINE DIAGRAM	DRG. NO.- PC183-1233		
		FILE:			
		प्रोजेक्ट्स एंड डेवलपमेंट इंडिया लिमिटेड नोएडा PROJECTS & DEVELOPMENT INDIA LTD.-NOIDA			

PROJECT : INTEGRATED COAL BASED FERTILISER COMPLEX, AT TALCHER, ANGUL DISTRICT, ODISHA (INDIA)

EMERGENCY DIESEL GENERATORS PACKAGE : TENTATIVE LIST of EMERGENCY LOADS

EQP Tag No.	DESCRIPTION	P O W E R	S T A T U S	MOTOR/ EQUIPMENT RATING			UNIT TYPE & Qty		SHAFT POWER kW	LF	PF	EF	Kd	CALCULATED			REMARKS			
				RATED POWER kW	RATED VOLTAGE V	RATED CURRENT A	MOTOR DRIVE UNIT	POWER FEED UNIT						P	Q	S				
														kW	kvar	kVA				
030000 Coal Gasification Unit emergency load																				
030000	03P11304A			Temp. Water Pump	E	CO	55.00	415	95.46	1	—	38.66	0.70	0.85	0.943	1.00	41.00	25.41	48.23	
030000	03P11304B			Temp. Water Pump	E	ST	55.00	415	93.27	1	—	38.66	0.70	0.87	0.943	0.20	41.00	23.23	47.12	
030000	03P21304A			Temp. Water Pump	E	CO	55.00	415	93.27	1	—	38.66	0.70	0.87	0.943	1.00	41.00	23.23	47.12	
030000	03P21304B			Temp. Water Pump	E	ST	55.00	415	93.27	1	—	38.66	0.70	0.87	0.943	0.20	41.00	23.23	47.12	
030000	03P13202A			Emergency Cooling Water Pump	E	CO	15.00	415	27.36	1	—	10.73	0.72	0.83	0.919	1.00	11.68	7.85	14.07	
030000	03P13202B			Emergency Cooling Water Pump	E	ST	15.00	415	27.36	1	—	10.73	0.72	0.83	0.919	0.20	11.68	7.85	14.07	
030000	03P13303A			HP Process Water Pump	E	CO	120.00	415	206.53	1	—	107	0.89	0.85	0.951	1.00	112.51	69.73	132.37	
030000	03P13303B			HP Process Water Pump	E	ST	120.00	415	206.53	1	—	107	0.89	0.85	0.951	0.20	112.51	69.73	132.37	
030000				Emergency lighting	E	CO	15.00	415	23.19	—	1		1.00	0.90	0.95	1.00	15.79	7.65	17.54	
030000	351100UPS			AC 115V UPS	E	CO	80.00	415	117.15	—	1	*	1.00	0.95	0.95	1.00	84.21	27.68	88.64	
030000	341100UPS			AC 240V UPS	E	CO	20.00	415	29.29	—	1	*	1.00	0.95	0.95	1.00	21.05	6.92	22.16	
030000	341100DC			DC	E	CO	10.00	415	14.64	—	1	*	1.00	0.95	0.95	1.00	10.53	3.46	11.08	
030000	351100-HVAC			SSR HVAC Package	E	CO	101.50	415	174.87	1	—	92.365	0.91	0.85	0.95	1.00	97.23	60.26	114.38	Packaged
030000	FBP-M-01-1			Oil pump motor of Lubrication station	E	CO	6.00	415	11.25	—	1	4.8	0.80	0.83	0.89425	1.00	5.37	3.61	6.47	Packaged
030000	FBP-DE-01-1			Oil pump motor of Lubrication station	E	CO	6.00	415	11.25	—	1	4.8	0.80	0.83	0.89425	1.00	5.37	3.61	6.47	Packaged
030000	36P1001A			Drain Pump for Fire Elevator Pit	E	IO	5.50	415	10.34	—	1	4.4	0.80	0.83	0.892	0.40	4.93	3.31	5.94	Packaged
030000	36P1001B			Drain Pump for Fire Elevator Pit	E	ST	5.50	415	10.34	—	1	4.4	0.80	0.83	0.892	0.20	4.93	3.31	5.94	Packaged
030000	36P1002A			Drain Pump for Fire Elevator Pit	E	IO	5.50	415	10.34	—	1	4.4	0.80	0.83	0.892	0.40	4.93	3.31	5.94	Packaged
030000	36P1002B			Drain Pump for Fire Elevator Pit	E	ST	5.50	415	10.34	—	1	4.4	0.80	0.83	0.892	0.20	4.93	3.31	5.94	Packaged
030000	3610HV1001			Electrical valve	E	IO	1.10	415	2.23	—	1	0.88	0.80	0.83	0.827	0.40	1.06	0.72	1.28	
030000	3610HV1002			Electrical valve	E	IO	1.10	415	2.23	—	1	0.88	0.80	0.83	0.827	0.40	1.06	0.72	1.28	
030000	351100-ELDB01			Emergency Lighting Distribution Board	E	IO	2.50	415	4.31	1	—	2	0.80	0.85	0.95	0.40	2.11	1.30	2.48	
040000 Purification Unit emergency load																				
040000	K040401-2			Turbine Turning Motor	E	IO	1.50	415	2.99	1	—	*	0.80	0.83	0.842	0.40	1.43	0.96	1.72	
040000	K040401-3			Emergency Oil Pump Motor	E	IO	7.50	415	13.95	1	—	*	0.80	0.83	0.901	0.40	6.66	4.48	8.02	
040000				Emergency lighting	E	CO	20.00	415	30.92		1		1.00	0.90	0.95	1.00	21.05	10.20	23.39	
040000	351001UPS			AC 115V UPS	E	CO	100.00	415	146.44	—	1	*	1.00	0.95	0.95	1.00	105.26	34.60	110.80	
040000	341300UPS			AC 240V UPS	E	CO	15.00	415	21.97	—	1	*	1.00	0.95	0.95	1.00	15.79	5.19	16.62	
040000	341300DC			DC 110V PANEL	E	CO	10.00	415	14.64	—	1	*	1.00	0.95	0.95	1.00	10.53	3.46	11.08	
040000	351000-HVAC			CCR HAVC Package	E	CO	250.00	415	409.18	—	1	*	0.80	0.85	0.943	1.00	212.09	131.44	249.52	Package
040000	3610HV1003			Electrical valve	E	IO	1.10	415	2.23	—	1	0.88	0.80	0.83	0.827	0.40	1.06	0.72	1.28	
040000	3610HV1004			Electrical valve	E	IO	1.10	415	2.23	—	1	0.88	0.80	0.83	0.827	0.40	1.06	0.72	1.28	
040000	3610HV1005			Electrical valve	E	IO	1.10	415	2.23	—	1	0.88	0.80	0.83	0.827	0.40	1.06	0.72	1.28	

PROJECT : INTEGRATED COAL BASED FERTILISER COMPLEX, AT TALCHER, ANGUL DISTRICT, ODISHA (INDIA)

EMERGENCY DIESEL GENERATORS PACKAGE : TENTATIVE LIST of EMERGENCY LOADS

EQP Tag No.	DESCRIPTION	P O W E R	S T A T U S	MOTOR/ EQUIPMENT RATING			UNIT TYPE & Qty		SHAFT POWER	LF	PF	EF	Kd	CALCULATED			REMARKS	
				RATED POWER	RATED VOLTAGE	RATED CURRENT	MOTOR DRIVE	POWER FEED						P	Q	S		
				kW	V	A	UNIT	UNIT										kW
040000	3610HV1006	Electrical valve	E	IO	1.10	415	2.23	—	1	0.88	0.80	0.83	0.827	0.40	1.06	0.72	1.28	
040000	3610HV1007	Electrical valve	E	IO	1.10	415	2.23	—	1	0.88	0.80	0.83	0.827	0.40	1.06	0.72	1.28	
040000	3610HV1008	Electrical valve	E	IO	1.10	415	2.23	—	1	0.88	0.80	0.83	0.827	0.40	1.06	0.72	1.28	
040000	3610HV1009	Electrical valve	E	IO	1.10	415	2.23	—	1	0.88	0.80	0.83	0.827	0.40	1.06	0.72	1.28	Packaged
040000	3610HV1010	Electrical valve	E	IO	1.10	415	2.23	—	1	0.88	0.80	0.83	0.827	0.40	1.06	0.72	1.28	Packaged
040000	DV-F-01	Deluge valve	E	IO	1.10	240	3.86	—	1	0.88	0.80	0.83	0.827	0.40	1.06	0.72	1.28	Packaged
040000	DV-F-02	Deluge valve	E	IO	1.10	240	3.86	—	1	0.88	0.80	0.83	0.827	0.40	1.06	0.72	1.28	Packaged
040000	351000-DCDB01	DC Distribution Board (For Panic Light)	E	CO	1.00	415	1.72	1	—	0.8	0.80	0.85	0.95	1.00	0.84	0.52	0.99	
040000	351000-DCDB02	DC Distribution Board (For Panic Light)	E	CO	1.00	415	1.72	1	—	0.8	0.80	0.85	0.95	1.00	0.84	0.52	0.99	
010000 Air Separation Unit emergency load																		
010000	01P1103	Cooling oil pump	E	IO	1.10	415	2.23	1	—	*	0.80	0.83	0.827	0.40	1.06	0.72	1.28	Packaged
010000	01B1101	Oil mist fan	E	CO	4.00	415	7.61	1	—	3.2	0.80	0.83	0.881	1.00	3.63	2.44	4.38	Packaged
010000	01P1104	Jacking oil pump	E	IO	11.00	415	20.22	1	—	8.8	0.80	0.83	0.912	0.40	9.65	6.48	11.63	Packaged
010000	01P1106	Rotor turning gear	E	IO	7.50	415	13.95	1	—	*	0.80	0.83	0.901	0.40	6.66	4.48	8.02	Packaged
010000	01P1112	Emergency oil pump	E	IO	7.50	415	13.95	1	—	*	0.80	0.83	0.901	0.40	6.66	4.48	8.02	Packaged
010000	01P1113	Oil Centrifuge feed pump	E	IO	2.00	415	3.93	1	—	*	0.80	0.83	0.854	0.40	1.87	1.26	2.26	Packaged
010000	01P1114	Oil Transfer pump	E	IO	1.50	415	2.99	1	—	*	0.80	0.83	0.842	0.40	1.43	0.96	1.72	Packaged
010000	01B1111A	Oil mist fan	E	CO	0.37	415	0.82	1	—	0.296	0.80	0.83	0.755	1.00	0.39	0.26	0.47	Packaged
010000	01B1111B	Oil mist fan	E	ST	0.37	415	0.82	1	—	0.296	0.80	0.83	0.755	0.20	0.39	0.26	0.47	Packaged
010000	01P1115-1	Barring Device	E	IO	0.75	415	1.52	1	—	0.6	0.80	0.85	0.807	0.40	0.74	0.46	0.87	
010000	01P2103	Cooling oil pump	E	IO	1.10	415	2.23	1	—	*	0.80	0.83	0.827	0.40	1.06	0.72	1.28	Packaged
010000	01B2101	Oil mist fan	E	CO	4.00	415	7.61	1	—	3.2	0.80	0.83	0.881	1.00	3.63	2.44	4.38	Packaged
010000	01P2104	Jacking oil pump	E	IO	11.00	415	20.22	1	—	8.8	0.80	0.83	0.912	0.40	9.65	6.48	11.63	Packaged
010000	01P2106	Rotor turning gear	E	IO	13.00	415	23.80	1	—	10.40	0.80	0.83	0.9155	0.40	11.36	7.63	13.69	Packaged
010000	01P2112	Emergency oil pump	E	IO	7.50	415	13.95	1	—	*	0.80	0.83	0.901	0.40	6.66	4.48	8.02	Packaged
010000	01P2113	Oil Centrifuge feed pump	E	IO	2.00	415	3.93	1	—	*	0.80	0.83	0.854	0.40	1.87	1.26	2.26	Packaged
010000	01P2114	Oil Transfer pump	E	IO	1.50	415	2.99	1	—	*	0.80	0.83	0.842	0.40	1.43	0.96	1.72	Packaged
010000	01B2111A	Oil mist fan	E	CO	0.37	415	0.82	1	—	0.30	0.80	0.83	0.755	1.00	0.39	0.26	0.47	Packaged
010000	01B2111B	Oil mist fan	E	ST	0.37	415	0.82	1	—	0.30	0.80	0.83	0.755	0.20	0.39	0.26	0.47	Packaged
010000	01P2115-1	Barring device (Motor)	E	IO	0.37	415	0.82	1	—	0.30	0.80	0.83	0.755	0.40	0.39	0.26	0.47	Packaged
010000		Emergency lighting	E	CO	20.00	415	30.92		1		1.00	0.90	0.95	1.00	21.05	10.20	23.39	
010000	341600UPS	AC 240V UPS	E	CO	10.00	415	14.64	—	1	*	1.00	0.95	0.95	1.00	10.53	3.46	11.08	
010000	341300DC	DC 110V PANEL	E	CO	10.00	415	14.64	—	1	*	1.00	0.95	0.95	1.00	10.53	3.46	11.08	
481100 Solid Material System emergency load																		
481100	-	Emergency lighting	E	CO	15.00	415	23.19		1		1.00	0.90	0.95	1.00	15.79	7.65	17.54	
481100	341500UPS	AC 240V UPS	E	CO	10.00	415	14.64	—	1	*	1.00	0.95	0.95	1.00	10.53	3.46	11.08	
481100	341500DC	DC 110V PANEL	E	CO	10.00	415	14.64	—	1	*	1.00	0.95	0.95	1.00	10.53	3.46	11.08	

PROJECT : INTEGRATED COAL BASED FERTILISER COMPLEX, AT TALCHER, ANGUL DISTRICT, ODISHA (INDIA)

EMERGENCY DIESEL GENERATORS PACKAGE : TENTATIVE LIST of EMERGENCY LOADS

EQP Tag No.	DESCRIPTION	P O W E R	S T A T U S	MOTOR/ EQUIPMENT RATING			UNIT TYPE & Qty		SHAFT POWER	LF	PF	EF	Kd	CALCULATED			REMARKS		
				RATED POWER kW	RATED VOLTAGE V	RATED CURRENT A	MOTOR DRIVE UNIT	POWER FEED UNIT						P kW	Q kvar	S kVA			
481100																			
481100	36P1003A	Drain Pump for Fire Elevator Pit	E	IO	5.50	415	10.34	—	1	4.4	0.80	0.83	0.892	0.40	4.93	3.31	5.94	Packaged	
481100	36P1003B	Drain Pump for Fire Elevator Pit	E	ST	5.50	415	10.34	—	1	4.4	0.80	0.83	0.892	0.20	4.93	3.31	5.94	Packaged	
481100	23U1001A	Slide valve	E	IO	0.75	415	1.56	—	1	0.6	0.80	0.83	0.807	0.40	0.74	0.50	0.90	Packaged	
481100	23U1001B	Slide valve	E	ST	0.75	415	1.56	—	1	0.6	0.80	0.83	0.807	0.20	0.74	0.50	0.90	Packaged	
211000 Cooling Water System emergency load																			
211000		Main lighting Distribution Board (Incomer 2) - Emergency Lighting	E	CO	15.00	415	23.19	—	1	*	0.80	0.90	0.95	1.00	12.63	6.12	14.04		
211000	341200UPS	UPS	E	CO	10.00	415	14.64	—	1	*	0.80	0.95	0.95	1.00	8.42	2.77	8.86		
211000	341200DC	DC 110V PANEL	E	CO	4.00	415	5.86	—	1	*	0.80	0.95	0.95	1.00	3.37	1.11	3.55		
RWTP	103-ASPB-1 INC-2	103-ASPB-1 INC-2	E	CO		415			1		1.00	0.95	0.95	1.00	2.06	0.72	2.30		
RWTP			E	IO		415			1		1.00	0.95	0.95	0.40	26.66	10.41	33.34		
RWTP			E	ST		415			1		1.00	0.95	0.95	0.20	0.00	0.72	2.30		
RWTP	Owner	Fire Water Make-Up Pump Motor in Water Reservoir Pump House (Owner)	E	CO	180.00	3300			1		150	0.83	0.85	0.953	1.00	157.40	97.55	185.17	
RWTP																			
RWTP	103-BC-1	Battery Charger-1	E	CO		415			1	28.80	0.80	0.80	0.90	1.00	32.00	24.00	40.00		
RWTP	103-115V UPS-1	115V AC UPS Feeder-1	E	CO		415			1	108	1.00	0.80	0.90	1.00	120.00	90.00	150.00		
RWTP	103-240V UPS-1	240V AC UPS Feeder-1	E	CO		415			1	28.80	1.00	0.80	0.90	1.00	32.00	24.00	40.00		
RWTP	103-VMCC-2 INC-1	Control Building AC & Ventilation MCC Incomer-1	E	CO		415			1					1.00	14.12	11.04	17.92		
RWTP		Control Building AC & Ventilation MCC Incomer-1	E	IO		415			1					0.40	5.56	4.16	6.94		
RWTP		Control Building AC & Ventilation MCC Incomer-1	E	ST		415			1					0.20	61.11	48.39	77.95		
RWTP	103-VMCC-2 INC-2	Control Building AC & Ventilation MCC Incomer-2	E	CO		415			1					1.00	62.36	46.77	77.95		
RWTP		Control Building AC & Ventilation MCC Incomer-2	E	IO		415			1					0.40	14.45	10.83	18.06		
RWTP		Control Building AC & Ventilation MCC Incomer-2	E	ST		415			1					0.20	14.12	11.04	17.92		
RWTP	103-ELTR-2	Emergency Lighting Transformer-2	E						1						31.56	10.43	33.24		
RWTP	Owner	Power Feeder-1 for EOT & Other Loads of Water Reservoir (Owner)	E	CO		415			1					1.00	10.00	7.50	12.50		
RWTP		PDB Emergency	E	CO		415			1					1.00	46.69	34.98	58.34		
DM CPU																			
DM CPU	100-ASPB-1 INC-2	ASPB Incomer-2	E	CO		415			1					1.00	2.06	1.02	2.30		
DM CPU			E	IO		415			1					0.40	14.44	10.85	18.06		
DM CPU			E	ST		415			1					0.20	0.00	2.30	2.30		
DM CPU	100-BC-1	Battery Charger-1	E	CO		415			1	28.8				1.00	32.00	24.00	40.00		

PROJECT : INTEGRATED COAL BASED FERTILISER COMPLEX, AT TALCHER, ANGUL DISTRICT, ODISHA (INDIA)

EMERGENCY DIESEL GENERATORS PACKAGE : TENTATIVE LIST of EMERGENCY LOADS

EQP Tag No.	DESCRIPTION	P O W E R	S T A T U S	MOTOR/ EQUIPMENT RATING			UNIT TYPE & Qty		SHAFT POWER kW	LF	PF	EF	Kd	CALCULATED			REMARKS
				RATED POWER kW	RATED VOLTAGE V	RATED CURRENT A	MOTOR DRIVE UNIT	POWER FEED UNIT						P	Q	S	
														kW	kvar	kVA	
DM CPU	100-115V UPS-1			E	CO	415			1	50.4			1.00	56.00	42.00	70.00	
DM CPU	100-240V UPS-1			E	CO	415			1	28.8			1.00	32.00	24.00	40.00	
DM CPU	100-VMCC-2 INC-1			E	CO	415			1				1.00	44.44	33.34	55.56	
DM CPU				E	IO	415			1				0.40	1.11	0.83	1.39	
DM CPU				E	ST	415			1				0.20	8.01	7.63	11.06	
DM CPU	100-VMCC-2 INC-2			E	CO	415			1				1.00	8.71	6.82	11.06	
DM CPU				E	IO	415			1				0.40	7.77	5.84	9.72	
DM CPU				E	ST	415			1				0.20	44.44	33.34	55.56	
DM CPU	100-PDB-1			E	CO	415			1				1.00	43.92	28.01	52.09	
DM CPU	100-ELTR-2			E	CO	415			1				1.00	66.30	21.84	69.81	
ETP + STP																	
ETP + STP	104-ASPB-1 INC-2			E	CO	415			1				1.00	3.08	2.33	3.86	
ETP + STP				E	IO	415			1				0.40	16.67	12.51	20.84	
ETP + STP				E	ST	415			1				0.20	0	3.86	3.86	
ETP + STP																	
ETP + STP	104-BM-002 A			E	ST	30	415		1	19	0.84	0.936	0.20	20.3	13.11	24.17	
ETP + STP	104-BM-002 B			E	CO	30	415		1	19	0.84	0.936	1.00	20.3	13.11	24.17	
ETP + STP	104-BM-002 C			E	CO	30	415		1	19	0.84	0.936	1.00	20.3	13.11	24.17	
ETP + STP	104-BM-005 A			E	ST	3.7	415		1	2.77	0.78	0.896	0.20	3.19	2.56	4.09	
ETP + STP	104-BM-005 B			E	IO	3.7	415		1	2.77	0.78	0.896	0.40	3.19	2.56	4.09	
ETP + STP	104-PM-010 C			E	IO	132	415			113.84	0.82	0.956	0.40	119.08	83.12	145.22	
ETP + STP	104-PM-018 A			E	CO	18.5	415		1	11.35	0.84	0.926	1.00	12.26	7.91	14.59	
ETP + STP	104-PM-018 B			E	IO	18.5	415		1	11.35	0.84	0.926	0.40	12.26	7.91	14.59	
ETP + STP	104-PM-058 A			E	CO	37	415		1	28.19	0.84	0.936	1.00	27.5	17.76	32.74	
ETP + STP	104-PM-058 B			E	IO	37	415		1	28.19	0.84	0.936	0.40	27.5	17.76	32.74	
ETP + STP	106-BM-001 A			E	CO	15	415		1	9.387	0.78	0.921	1.00	10.19	8.18	13.07	
ETP + STP	106-BM-001 B			E	ST	15	415		1	9.387	0.78	0.921	0.20	10.19	8.18	13.07	
ETP + STP	106-BM-002 A			E	CO	2.2	415		1	1.3	0.72	0.867	1.00	1.5	1.44	2.08	
ETP + STP	106-BM-002 B			E	ST	2.2	415		1	1.3	0.72	0.867	0.20	1.5	1.44	2.08	
ETP + STP	104-BC-2			E	CO		415		1	54	0.80	0.90	1.00	60	45.00	75	
ETP + STP	104-240V UPS-1			E	CO		415		1	72	0.80	0.90	1.00	80	60.00	100	
ETP + STP	104-PDB-1			E	CO		415		1				1.00	66.81	49.94	83.41	
ETP + STP	TBA			E	CO		415		1				1.00	8	6.00	10	

PROJECT : INTEGRATED COAL BASED FERTILISER COMPLEX, AT TALCHER, ANGUL DISTRICT, ODISHA (INDIA)

EMERGENCY DIESEL GENERATORS PACKAGE : TENTATIVE LIST of EMERGENCY LOADS

EQP Tag No.	DESCRIPTION	P O W E R	S T A T U S	MOTOR/ EQUIPMENT RATING			UNIT TYPE & Qty		SHAFT POWER	LF	PF	EF	Kd	CALCULATED			REMARKS
				RATED POWER kW	RATED VOLTAGE V	RATED CURRENT A	MOTOR DRIVE UNIT	POWER FEED UNIT						P kW	Q kvar	S kVA	
ETP + STP	TBA					415			1				1.00	8.00	6.00	10.00	
Flare	Misc.	E	CO	7.50	415		1	—	5	0.80	0.83	0.901	1.00	6.66	4.48	8.02	
Lighting	Misc.	E	CO	10.00	415		—	1	*	1.00	0.90	0.95	1.00	10.53	5.10	11.70	
	Misc.	E	CO	10.00	415		—	1	*	1.00	0.90	0.95	1.00	10.53	5.10	11.70	
	Misc.	E	CO	20.00	415		—	1	*	1.00	0.90	0.95	1.00	21.05	10.20	23.39	
	Misc.	E	CO	20.00	415		—	1	*	1.00	0.90	0.95	1.00	21.05	10.20	23.39	
OUSS	AC 115V UPS	E	CO	70.00	415	102.51	—	1	*	1.00	0.95	0.95	1.00	73.68	24.22	77.56	
OUSS	AC 240V UPS	E	CO	80.00	415	117.15	—	1	*	1.00	0.95	0.95	1.00	84.21	27.68	88.64	
OUSS	DC	E	CO	10.00	415	14.64	—	1	*	1.00	0.95	0.95	1.00	10.53	3.46	11.08	
OUSS	HVAC Package	E	CO	50.00	415	86.14	1	—	43.5	0.87	0.85	0.95	1.00	45.79	28.38	53.87	
Coal Handling																	
Coal Handling	AC 115V UPS	E	CO	5.00	415	7.32	—	1	*	1.00	0.95	0.95	1.00	5.26	1.73	5.54	
Coal Handling	AC 240V UPS	E	CO	5.00	415	7.32	—	1	*	1.00	0.95	0.95	1.00	5.26	1.73	5.54	
Coal Handling	DC	E	CO	5.00	415	7.32	—	1	*	1.00	0.95	0.95	1.00	5.26	1.73	5.54	
Coal Handling	Misc Emergency Laods	E	CO	200.00	415	344.57	1	—	182	0.91	0.85	0.95	1.00	191.58	118.73	225.39	
Urea Prodcut Handling																	
UPH	AC 115V UPS	E	CO	35.00	415	51.25	—	1	*	1.00	0.95	0.95	1.00	36.84	12.11	38.78	
UPH	AC 240V UPS	E	CO	10.00	415	14.64	—	1	*	1.00	0.95	0.95	1.00	10.53	3.46	11.08	
UPH	DC	E	CO	5.00	415	7.32	—	1	*	1.00	0.95	0.95	1.00	5.26	1.73	5.54	
UPH	Misc Emergency Laods	E	CO	100.00	415	172.29	1	—	91	0.91	0.85	0.95	1.00	95.79	59.36	112.69	
Ash Handling																	
Ash Handling	Misc Emergency Laods	E	CO	200.00	415	344.57	1	—	182	0.91	0.85	0.95	1.00	191.58	118.73	225.39	
Admin. & Technical Building																	
Admin Tech	Admin. & Technical Building Ltg. Load	E	CO	20.00	415		—	1	*	1.00	0.90	0.95	1.00	21.05	10.20	23.39	
Admin Tech	Airconditioning Load	E	CO	30.00	415		—	1	*	1.00	0.90	0.95	1.00	31.58	15.29	35.09	
Admin Tech	Canteen	E	CO	10.00	415		—	1	*	1.00	0.90	0.95	1.00	10.53	5.10	11.70	
Warehouse																	
Warehouse	Ltg. Load	E	CO	10.00	415		—	1	*	1.00	0.90	0.95	1.00	10.53	5.10	11.70	

PROJECT : INTEGRATED COAL BASED FERTILISER COMPLEX, AT TALCHER, ANGUL DISTRICT, ODISHA (INDIA)

EMERGENCY DIESEL GENERATORS PACKAGE : TENTATIVE LIST of EMERGENCY LOADS

EQP Tag No.	DESCRIPTION	P O W E R	S T A T U S	MOTOR/ EQUIPMENT RATING			UNIT TYPE & Qty		SHAFT POWER	LF	PF	EF	Kd	CALCULATED			REMARKS
				RATED POWER kW	RATED VOLTAGE V	RATED CURRENT A	MOTOR DRIVE UNIT	POWER FEED UNIT						P kW	Q kvar	S kVA	
Workshop																	
Workshop	Ltg. Load	E	CO	10.00	415		—	1	*	1.00	0.90	0.95	1.00	10.53	5.10	11.70	
Workshop	Misc. Loads	E	CO	20.00	415		—	1	*	1.00	0.90	0.95	1.00	21.05	10.20	23.39	
Fire Station + First Aid + security																	
Fire	Ltg. Load	E	CO	5.00	415		—	1	*	1.00	0.90	0.95	1.00	5.26	2.55	5.85	
Fire	Misc. Loads	E	CO	10.00	415		—	1	*	1.00	0.90	0.95	1.00	10.53	5.10	11.70	
Plant maint. Office																	
Office	Misc. Loads	E	CO	10.00	415		—	1	*	1.00	0.90	0.95	1.00	10.53	5.10	11.70	
Lab Tech building																	
Lab	Misc. Loads	E	CO	5.00	415		—	1	*	1.00	0.90	0.95	1.00	5.26	2.55	5.85	

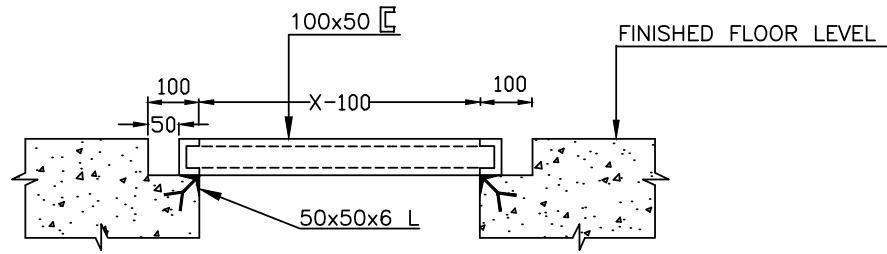

SECTION-A A

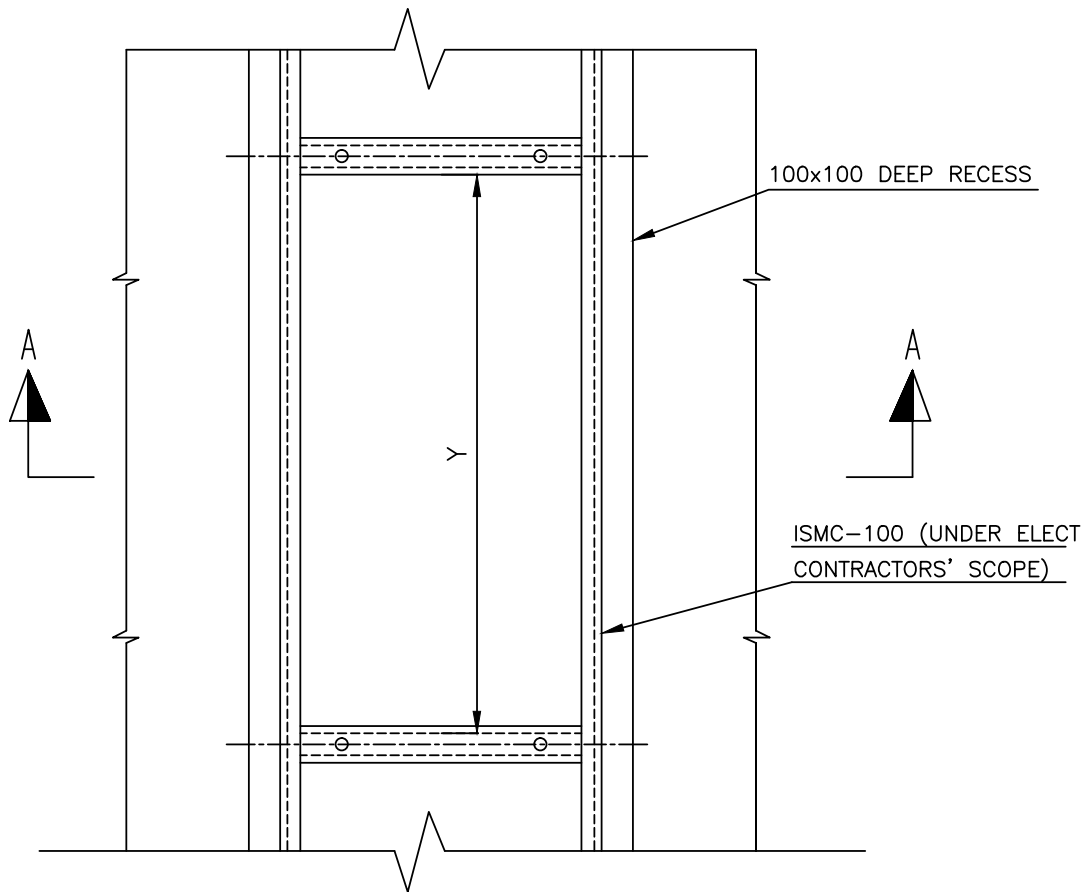

PLAN

X- DEPTH OF PANEL

Y- LENGTH OF TWO PANELS

NOTES:-

1. THIS ARRANGEMENT SHALL BE APPLICABLE FOR M.C.C., DISTRIBUTION BOARDS, CONTROL PANELS ETC.
2. PANELS AFTER ERECTION SHALL BE TAG WELDED TO FOUNDATION CHANNELS

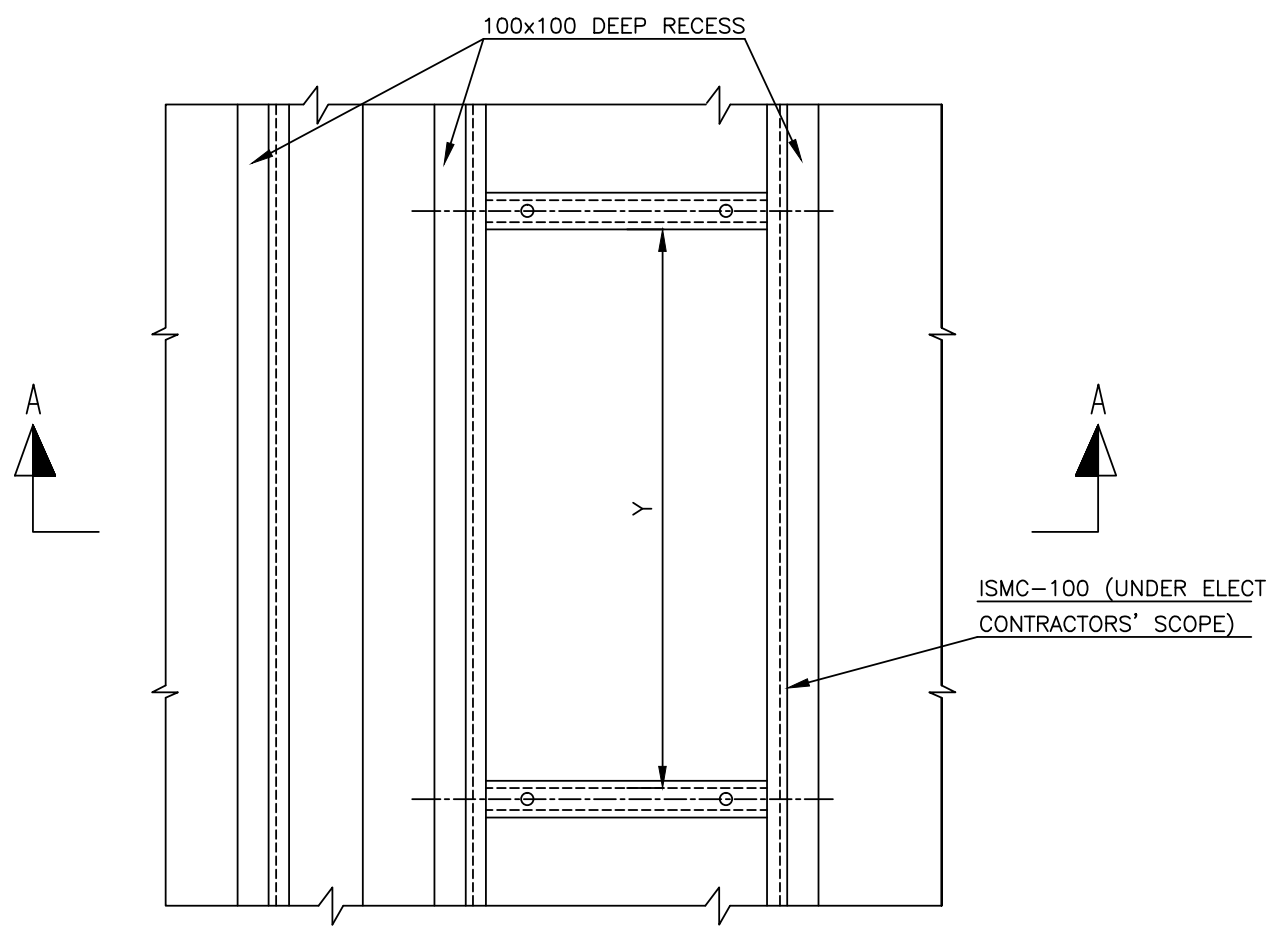
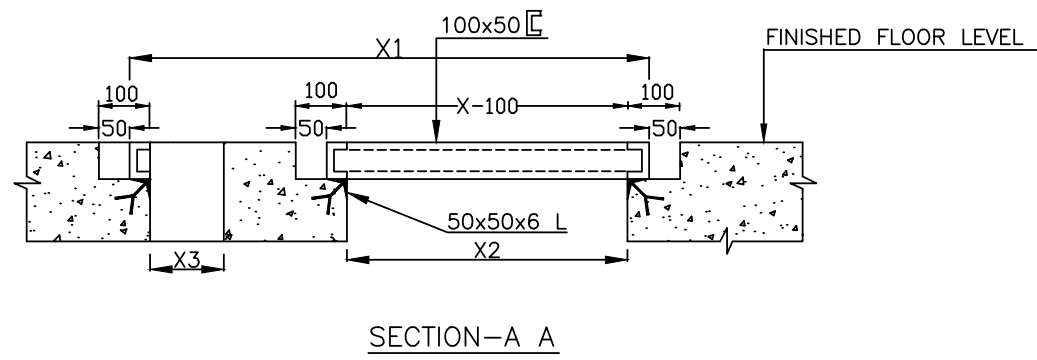

X1 = DEPTH OF PANEL
X2 = FOOR OPENING
X3 = FOOR OPENING
Y = LENGTH OF PANEL

- NOTES:-
1. PANELS AFTER ERECTION SHALL BE BOLTED TO FOUNDATION CHANNELS
 2. POWER & CONTROL CABLES SHALL ENTER THROUGH OPENING X2
 3. DEPENDING UPON THE FINAL DATA FROM THE VENDOR, ONLY TWO CHANNELS MAY BE NECESSARY IN WHICH CASE THE 3RD. RECESS SHALL BE FILLED AT SITE.

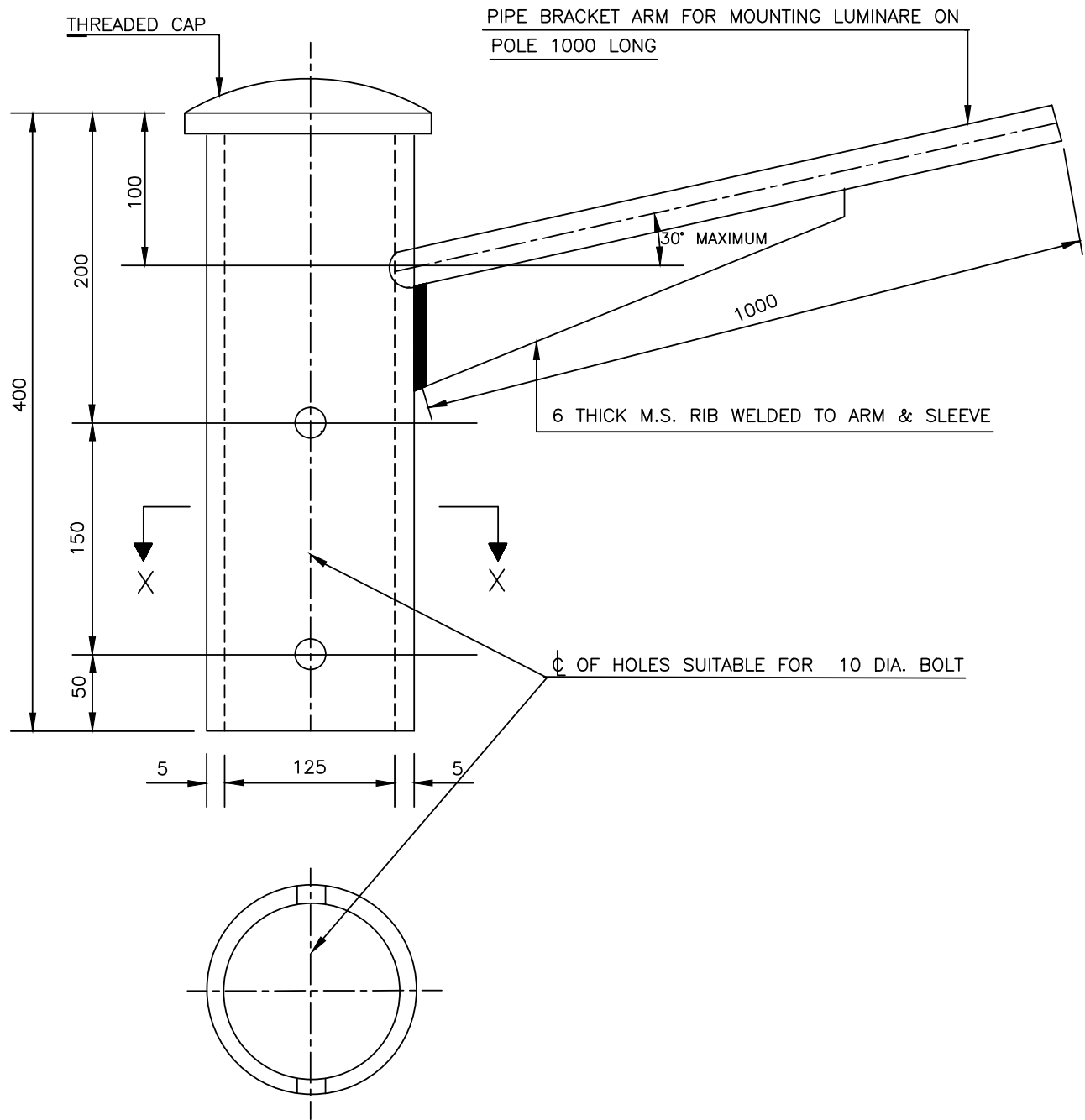

NOTES:-

1. SIZE OF PIPE SHALL BE 30mm FOR TL/80W HPL FIXTURES,
40mm FOR 70W SON/125W HPL FIXTURES AND 50mm FOR
150W SON/250W HPL FIXTURES.
2. ALL DIMENSIONS ARE IN mm.

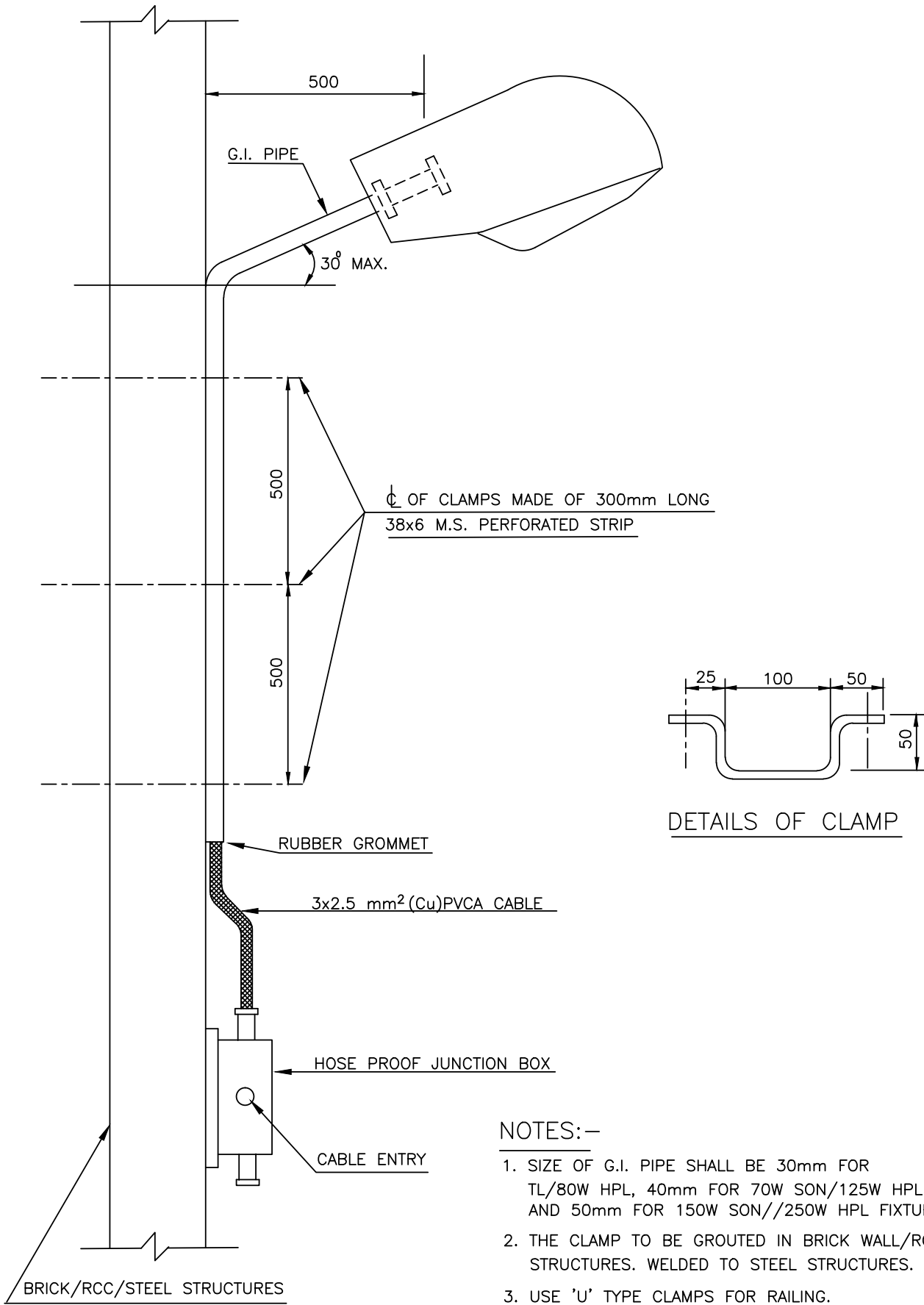

NOTES:—

1. SIZE OF G.I. PIPE SHALL BE 30mm FOR TL/80W HPL, 40mm FOR 70W SON/125W HPL AND 50mm FOR 150W SON//250W HPL FIXTURES.
2. THE CLAMP TO BE GROUTED IN BRICK WALL/RCC STRUCTURES. WELDED TO STEEL STRUCTURES.
3. USE 'U' TYPE CLAMPS FOR RAILING.
4. ALL DIMENSIONS ARE IN mm.

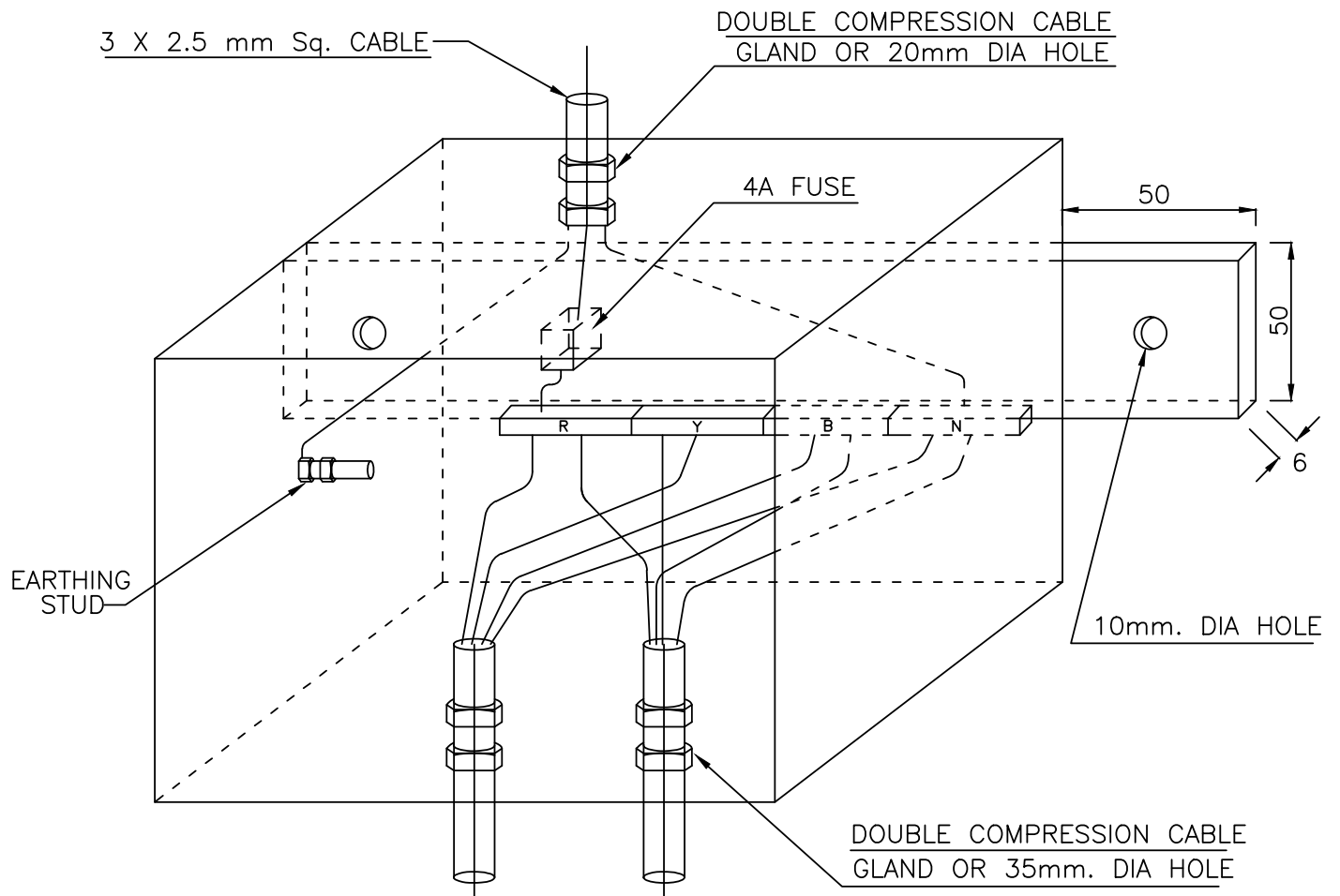

NOTE:-

1. THE MINIMUM INTERNAL DIMENSION OF THE J.B. SHALL BE 152 X 152 X 152.
2. THE FRONT DOOR SHALL BE HINGED & LOCKABLE TYPE.
3. THE CONNECTION OF FUSE TO THE PHASE 'R' IS TYPICAL ONE THE EXACT PHASE TO WHICH CONNECTION SHALL BE MADE SHALL BE DECIDED AT SITE.
4. FOR HAZARDOUS AREA'S THESE JUNCTION BOXES SHALL BE INCREASED SAFETY TYPE AND THE FUSE NEED NOT BE PROVIDED.
5. FOR POLE MOUNTED JUNCTION BOXED THE CABLE GLAND SHALL BE SIDE MOUNTED.
6. ALL DIMENSIONS ARE IN mm.

TYPICAL STREET LIGHTING POLE

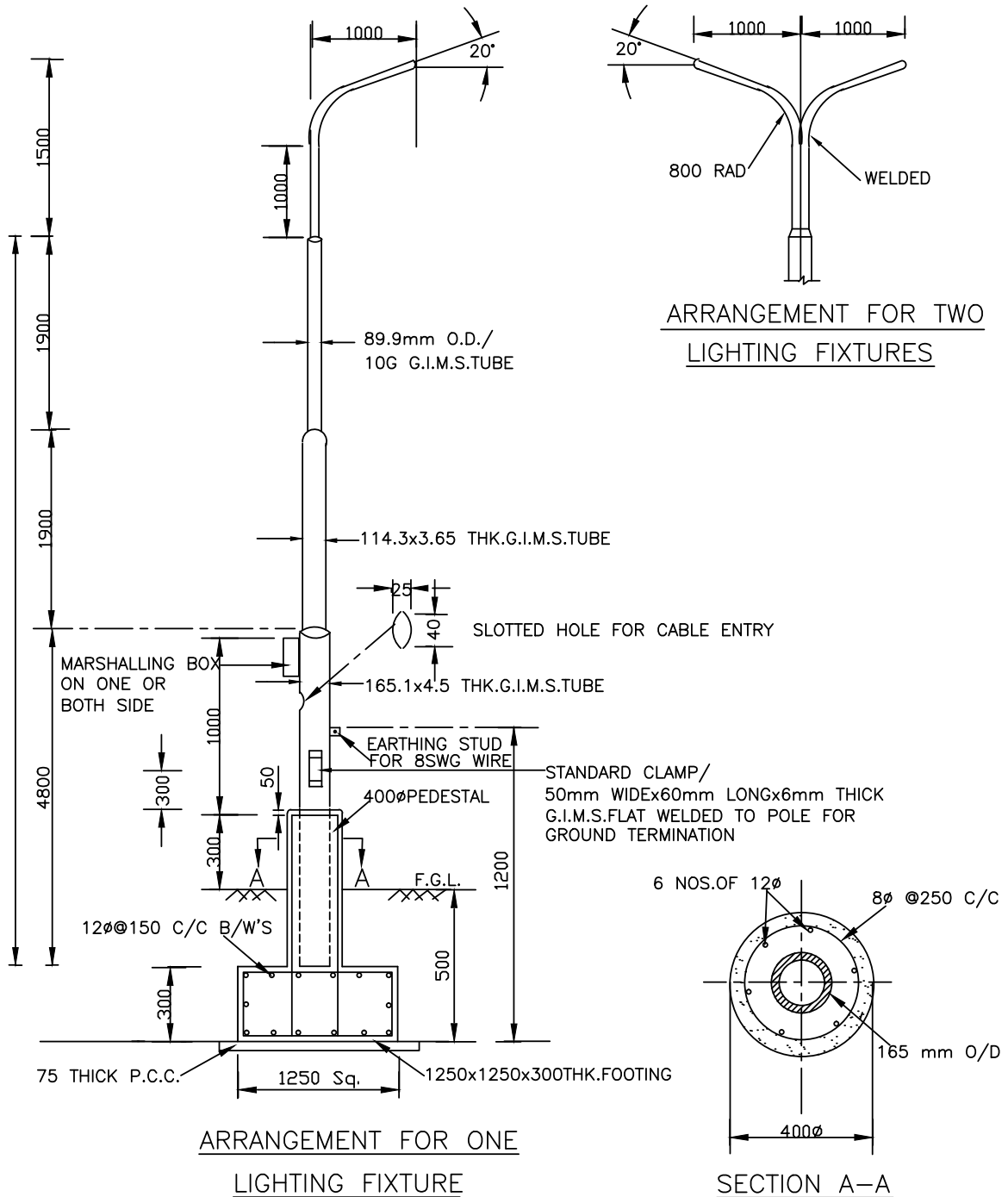

NOTE :-

1. CONCRETING AND APPROVED MOUNTING HARDWARE FOR LIGHTING FIXTURES ARE INCLUDING IN SCOPE OF SUPPLY.
2. CONCRETE FOUNDATION OF GRADE M15 SHALL BE PROVIDED.

ALL DIMENSIONS ARE IN mm.

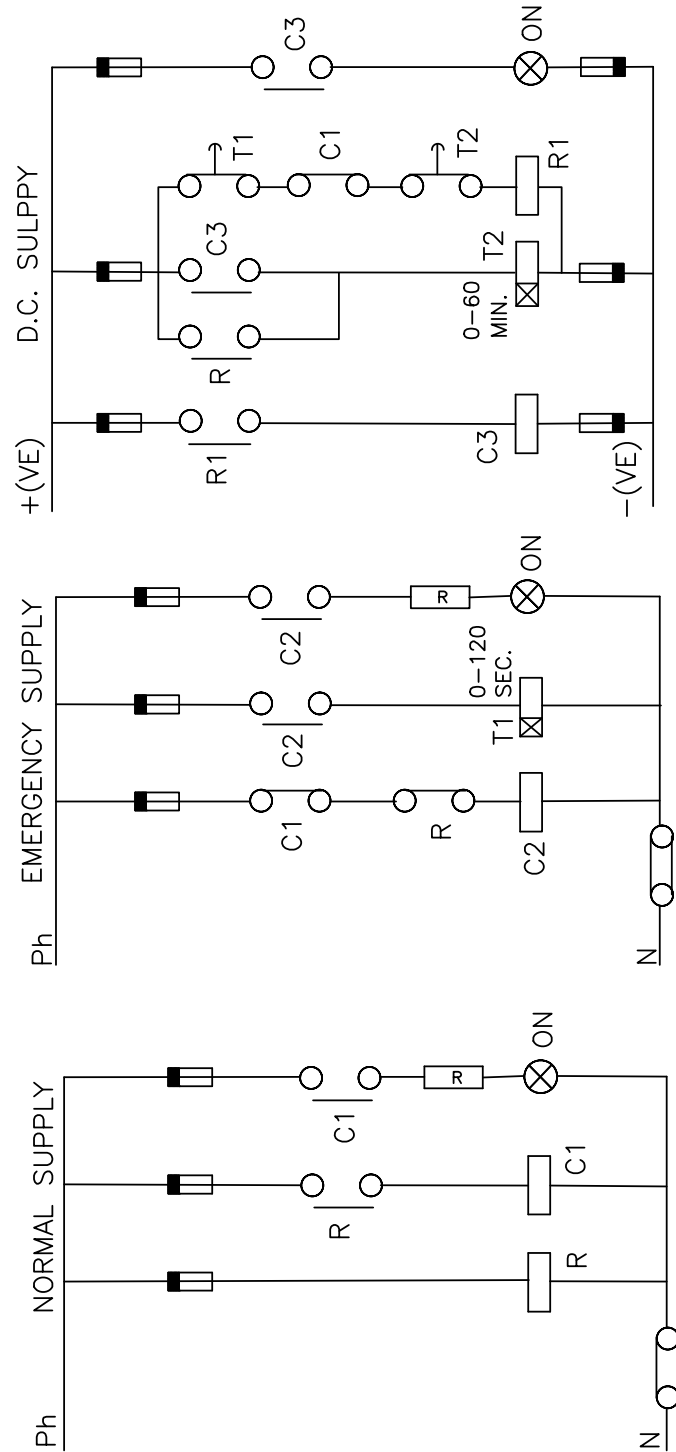

NOTE:-

CONTACTORS C1,C2 AND C3 CONTROLS THE LIGHTING FEEDERS FOR NORMAL,EMERGENCY AND D.C. SUPPLY RESPECTIVELY.

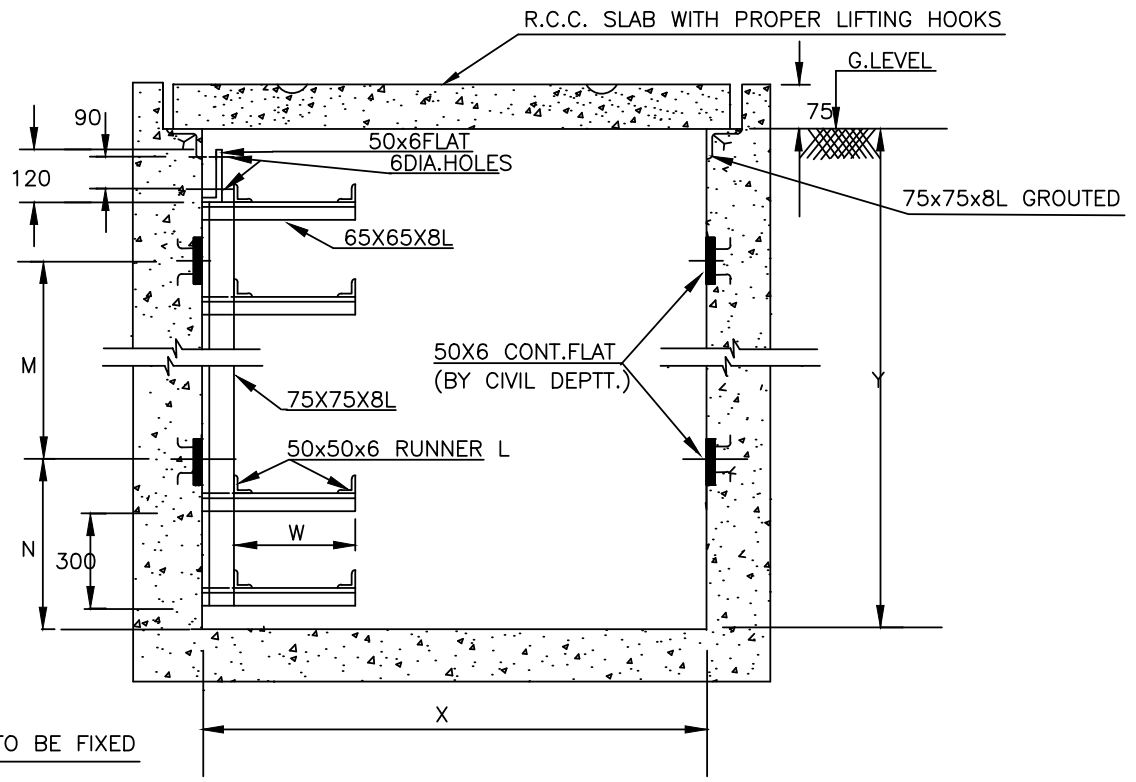

CABLE SUPPORTS TO BE FIXED
@ 1500 INTERVAL

SECTION OF TRENCH

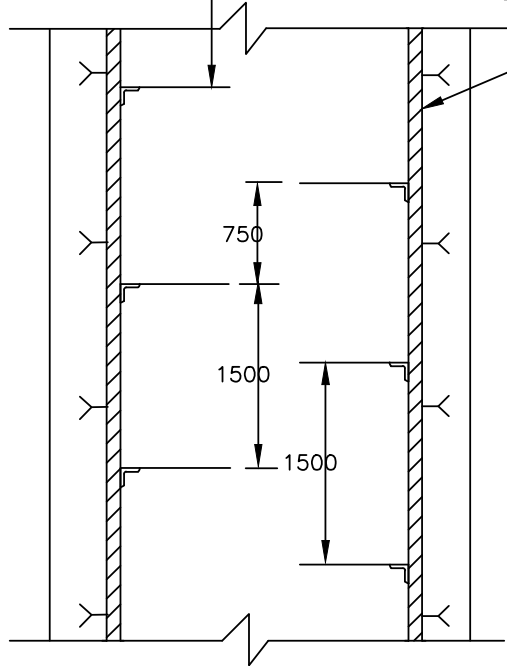

TYPICAL PLAN OF TRENCH

DESIGN TYPE	X	Y	N	M	W
5T-350-DS.	1400	1500	400	650	350
4T-350-DS.	1400	1200	250	650	350
3T-350-DS.	1400	900	250	300	350
5T-350-SS.	1000	1500	400	650	350
4T-350-SS.	1000	1200	250	650	350
3T-350-SS.	1000	900	250	300	350
5T-250-DS.	1200	1500	400	650	250
4T-250-DS.	1200	1200	250	650	250
3T-250-DS.	1200	900	250	300	250
5T-250-SS.	900	1500	400	650	250
4T-250-SS.	900	1200	250	650	250
3T-250-SS.	900	900	250	300	250

NOTES:-1. SS-SINGLE SIDE CABLE SUPPORT.
2. DS-DOUBLE SIDE CABLE SUPPORT.
3. ALL DIMENSIONS ARE IN mm.

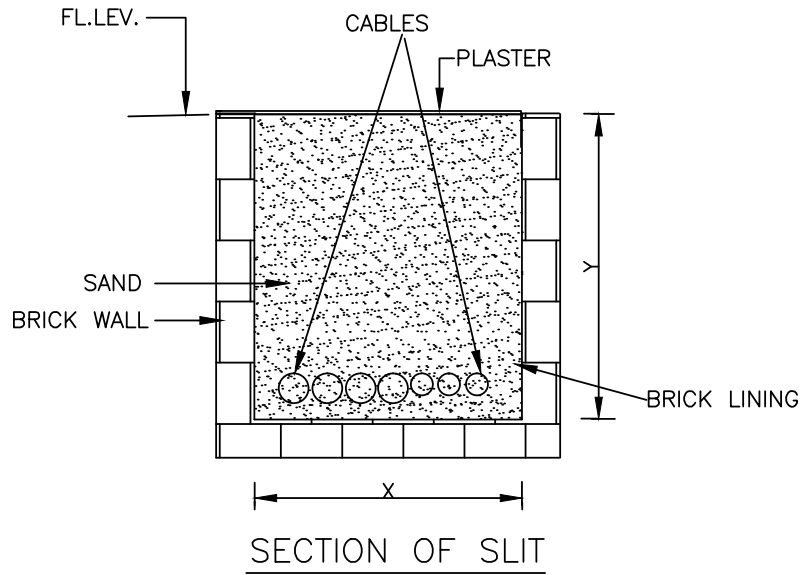

DESIGN TYPE	X	Y
S 300	300	300
S 200	200	200

NOTE:-

1. CABLE SLITS SHALL BE FILLED WITH SAND AND PROPERLY PLASTERED WITH LEAN CONCRETE AFTER LAYING OF CABLES.
2. WHEREVER CABLES ARE COMING OUT OF THE SLIT, SUITABLE MECH.PROTECTION TO BE PROVIDED.

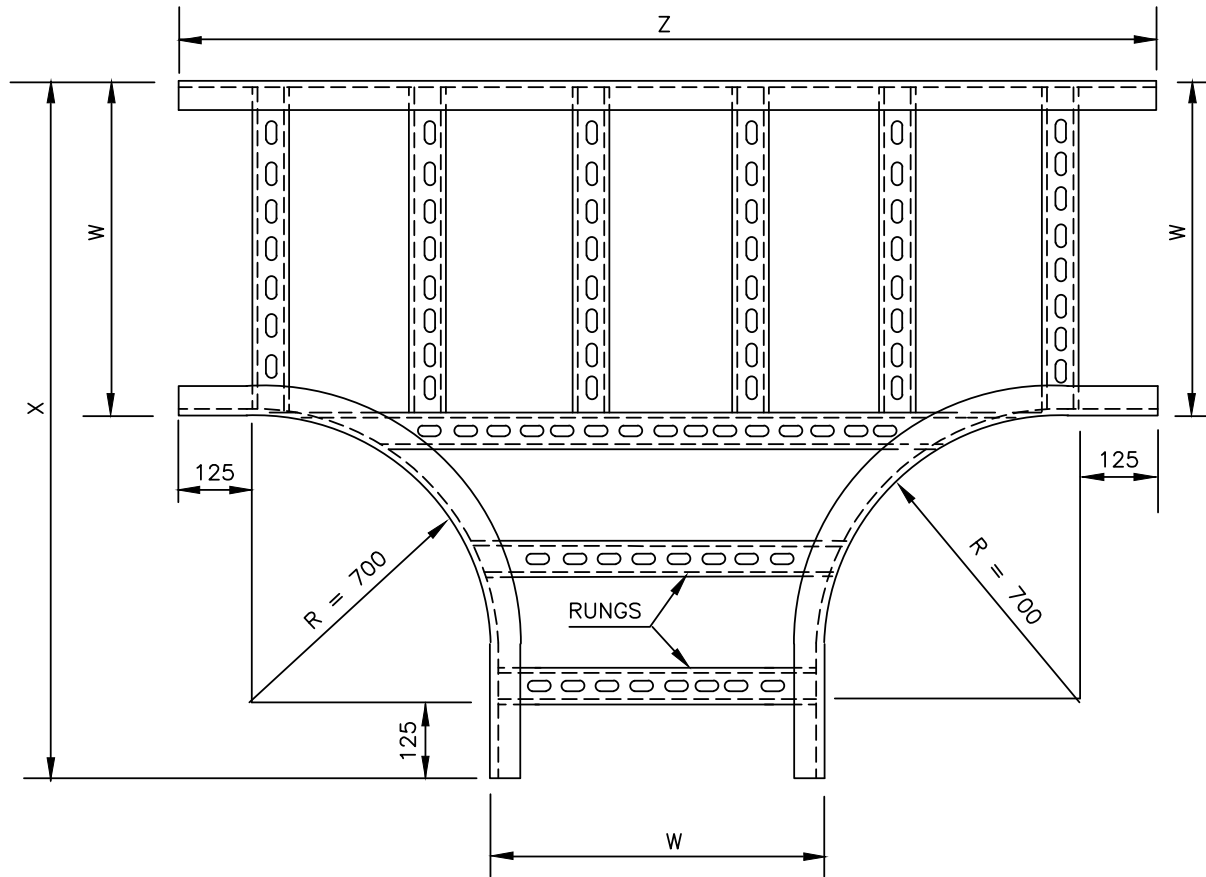

PLAN

DESIGN TYPE	W	$X=R+W+125$	$Z=2R+W+250$
HT 900	900	1725	2550
HT 600	600	1425	2250
HT 450	450	1275	2100
HT 300	300	1125	1950

NOTES :-

1. DISTANCE BETWEEN TWO RUNGS SHOULD BE APPROX. 300mm.
2. ALL DIMENSIONS ARE IN mm.

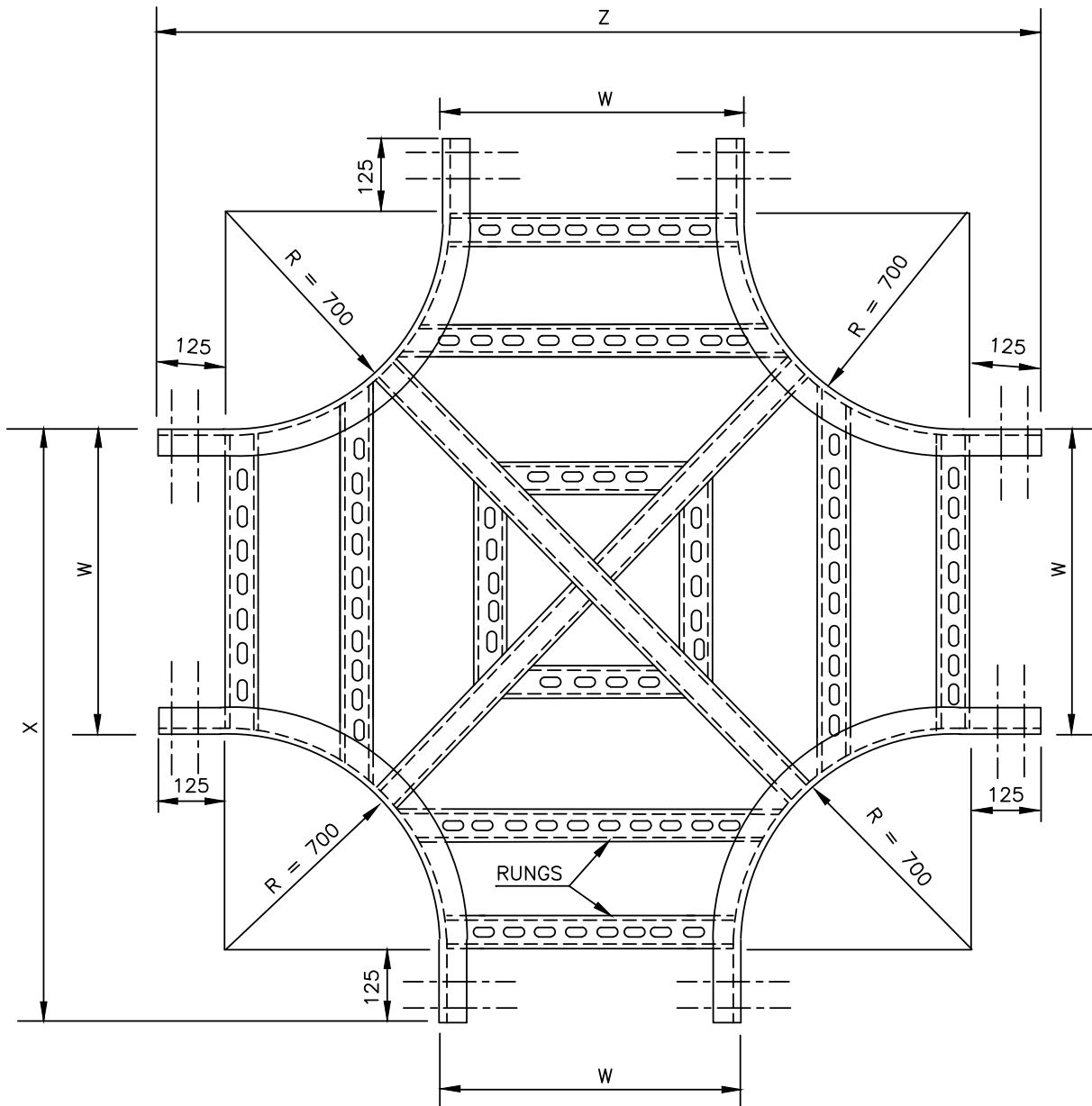

PLAN

DESIGN TYPE	W	$X=R+W+125$	$Z=2R+W+250$
HC 900	900	1725	2550
HC 600	600	1425	2250
HC 450	450	1275	2100
HC 300	300	1125	1950

NOTES :-

1. DISTANCE BETWEEN TWO RUNGS SHOULD BE APPROX. 300mm.
2. ALL DIMENSIONS ARE IN mm.

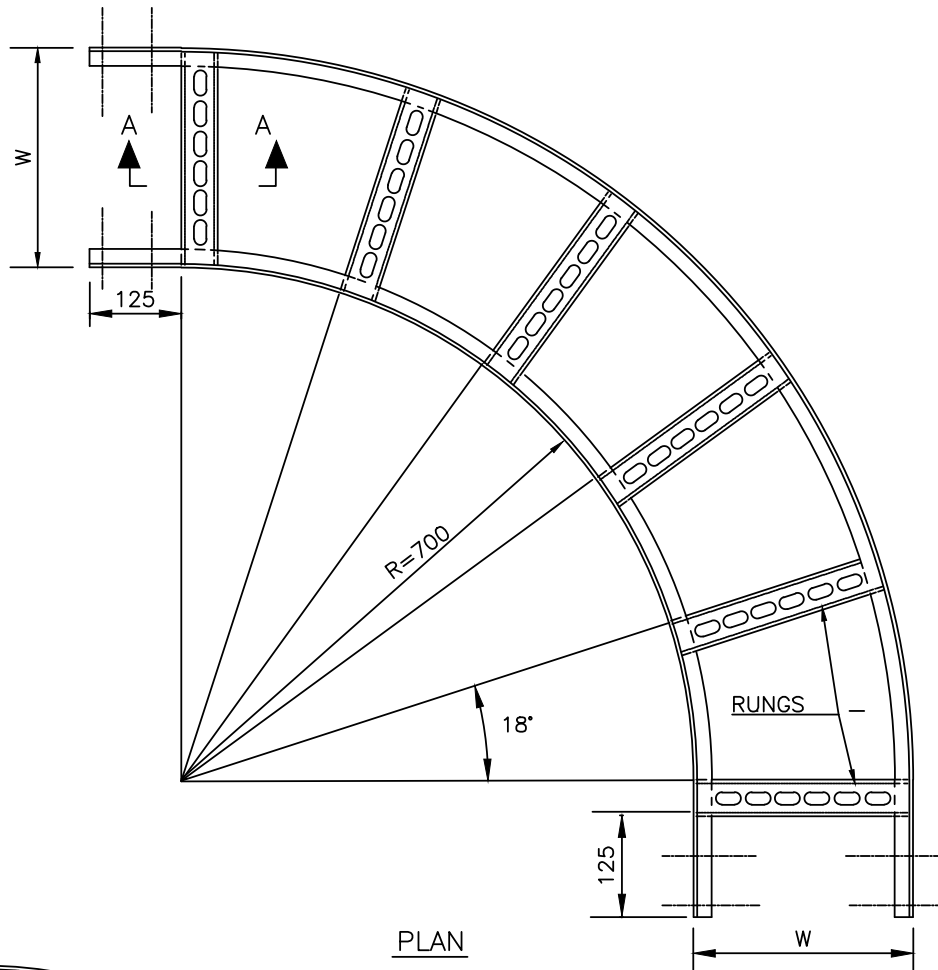

PLAN
(700R BEND)

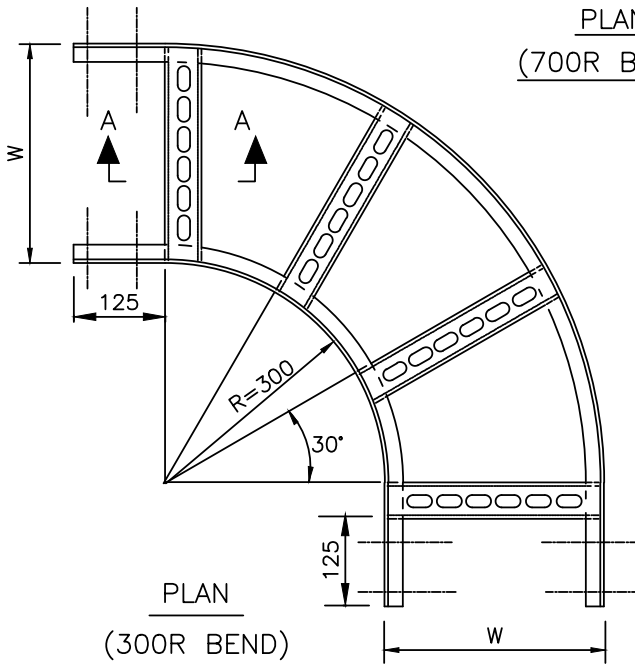

PLAN
(300R BEND)

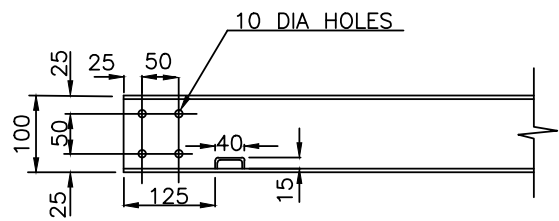

SECTION A-A

ALL DIMENSIONS ARE IN mm.

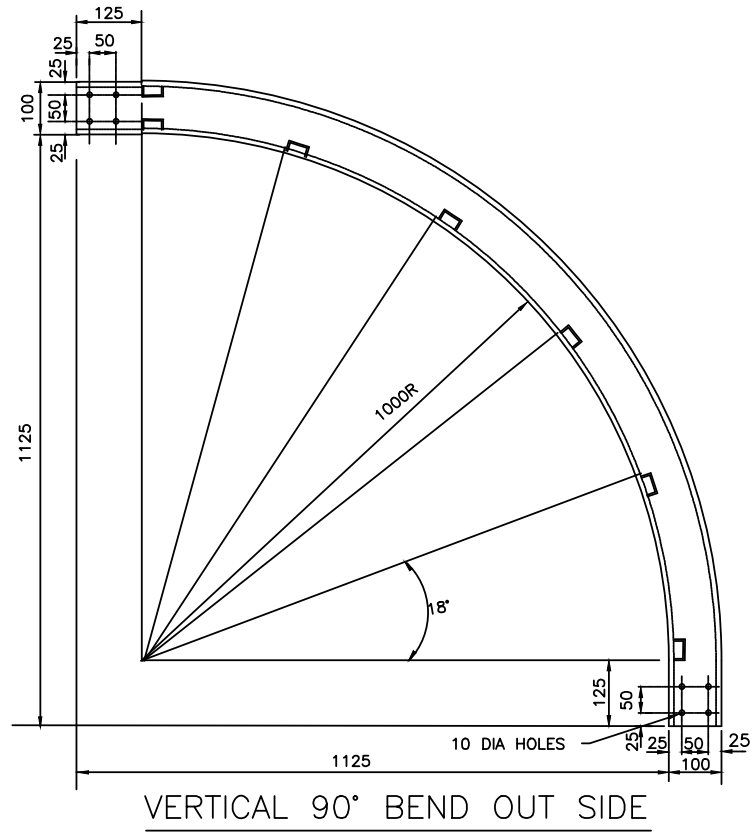
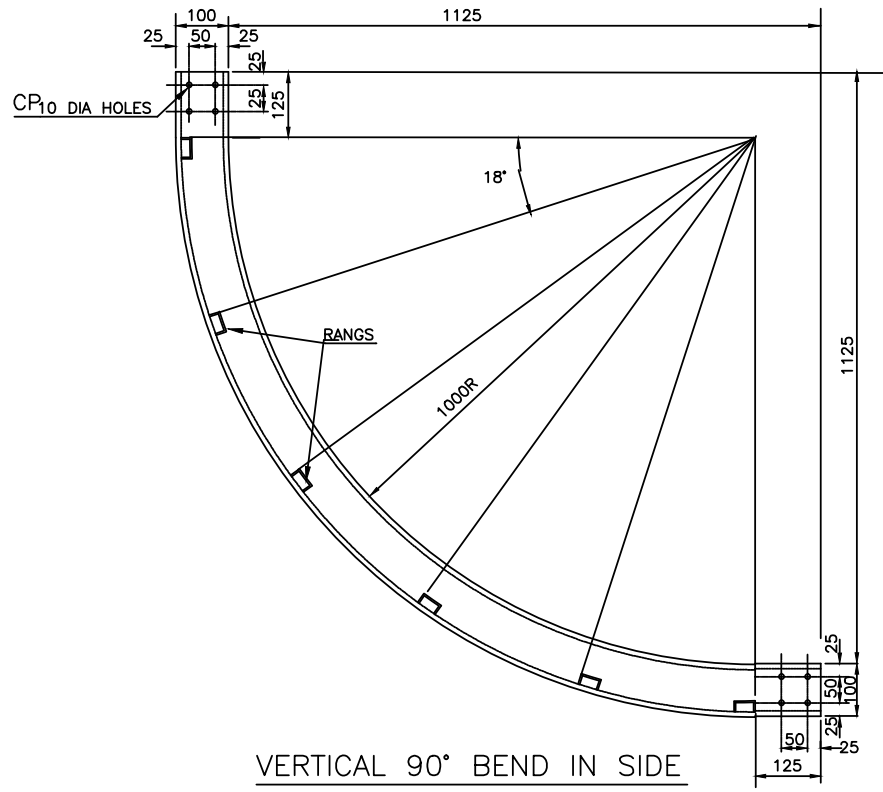

DIMENSIONS ARE IN mm.

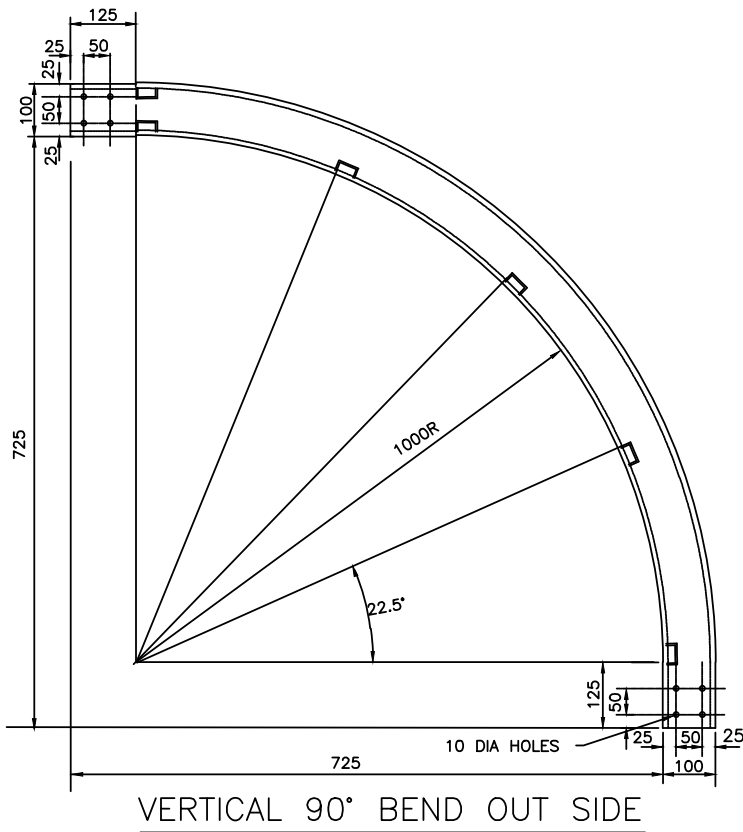
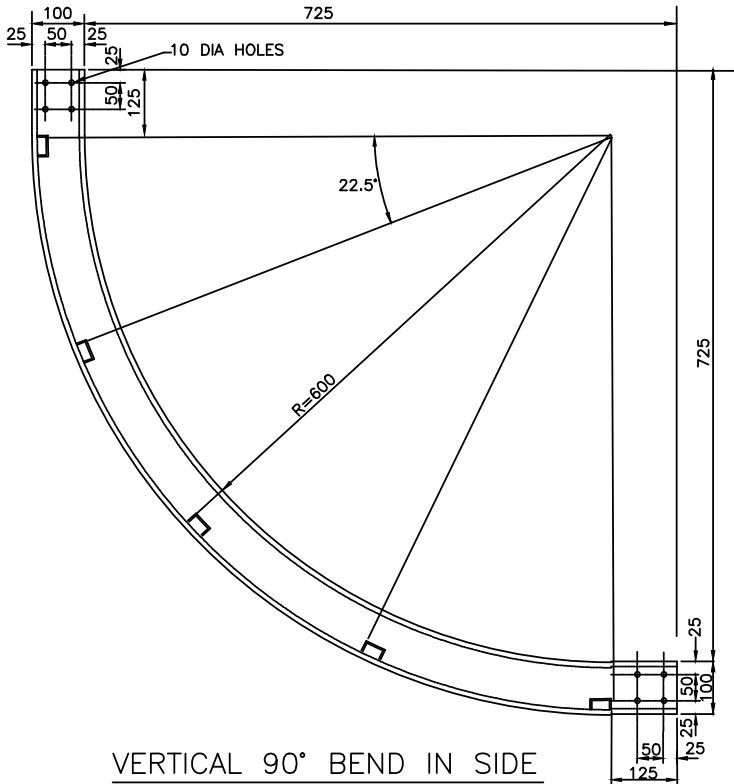

ALL DIMENSIONS ARE IN mm.

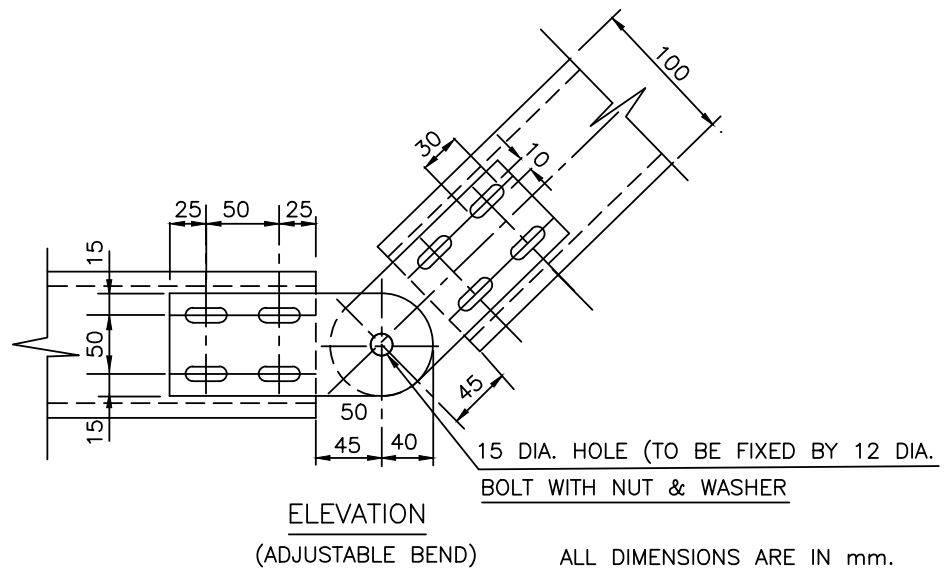
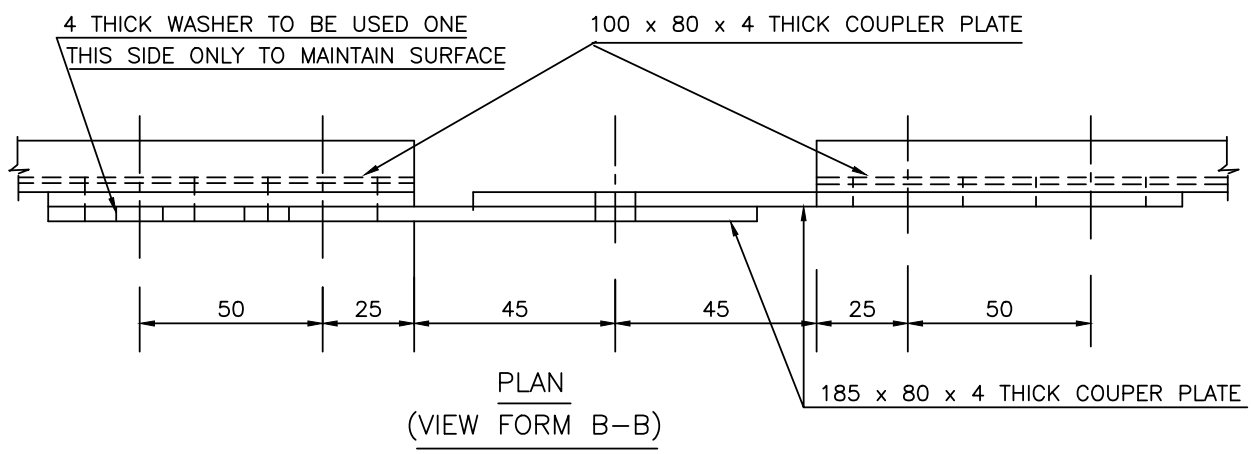
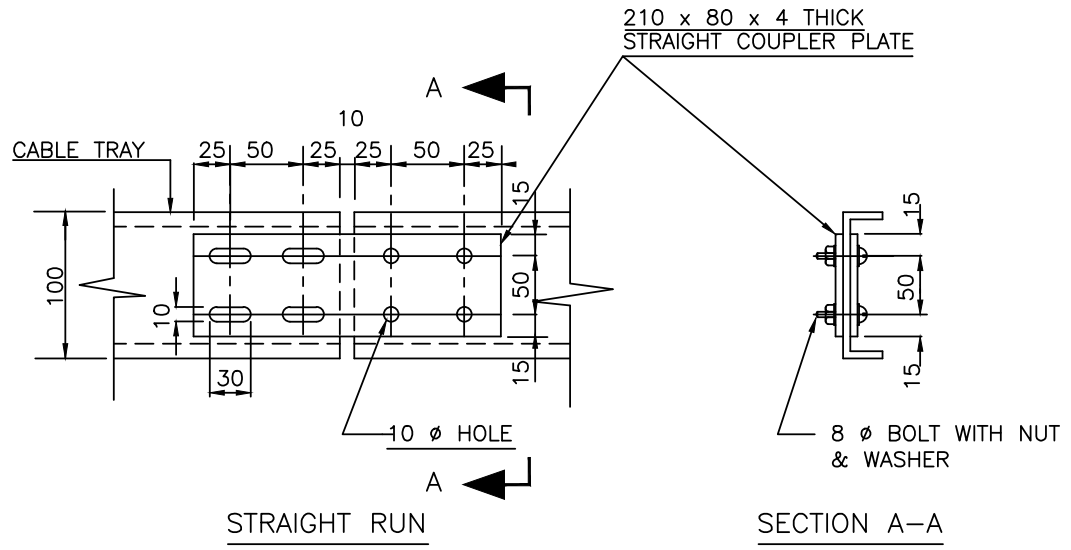

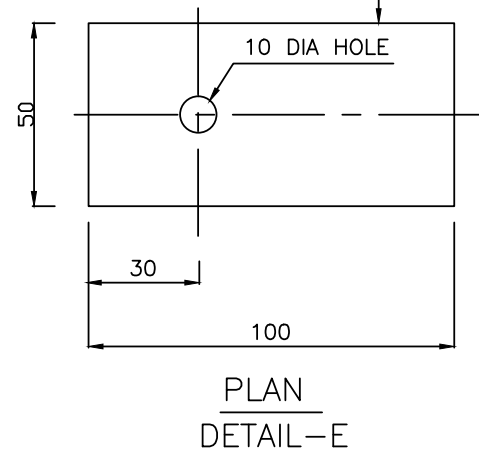
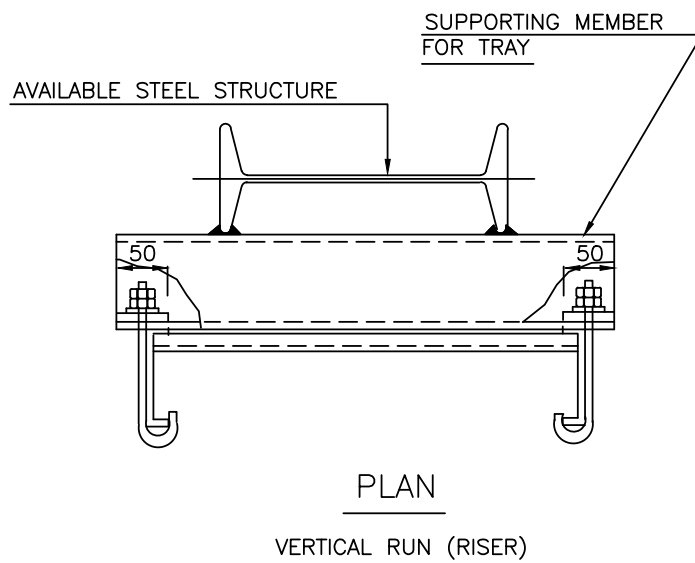
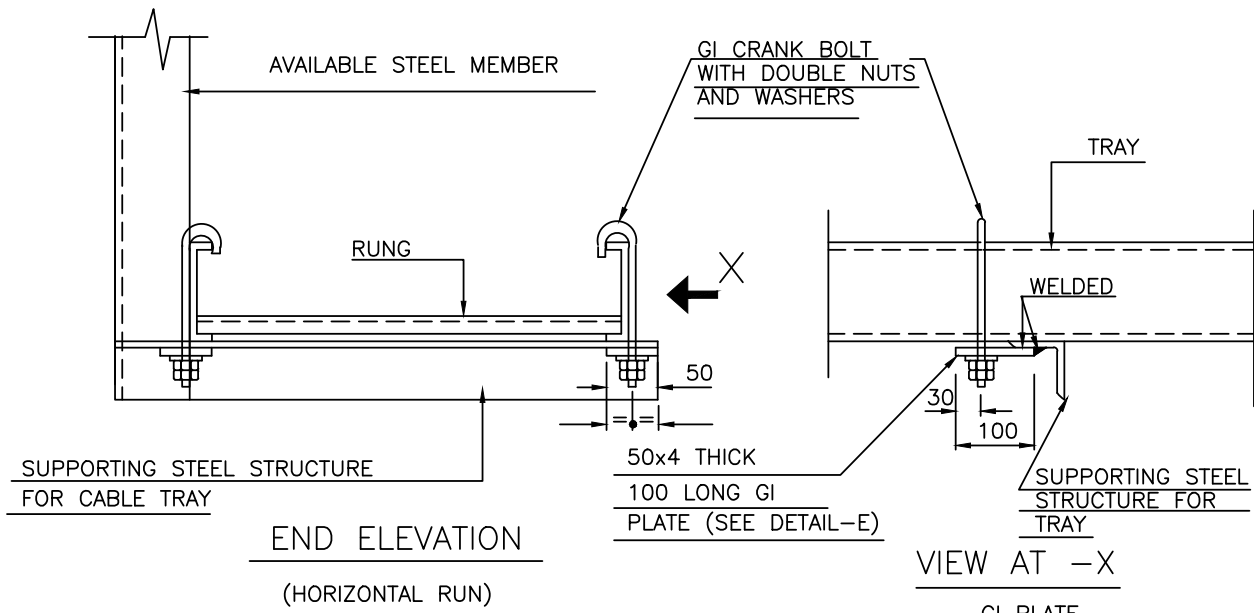

GI CRANK BOLT WITH DOUBLE NUTS & WASHERS.

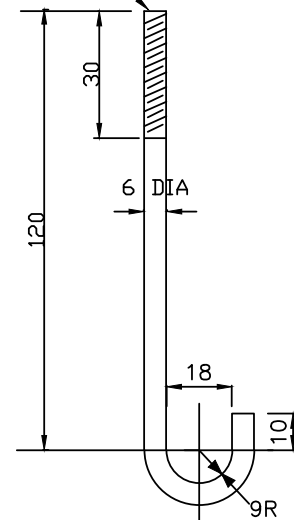

NOTES:-

1. HORIZONTAL RUN TO BE CLAMPED WITH EVERY SUPPORT AS PER LAYOUT
2. VERTICAL RUN/ RISER TO BE CLAMPED WITH EVERY SUPPORT AS PER LAYOUT
3. EACH CRANK HOOK SHALL BE SUPPLIED WITH ONE PLAIN WASHER, ONE SPRING WASHER AND TWO DOUBLE CHAMFERED HEX NUTS. THESE SHALL BE GALVANISED ITEMS.
4. ALL DIMENSIONS ARE IN mm.

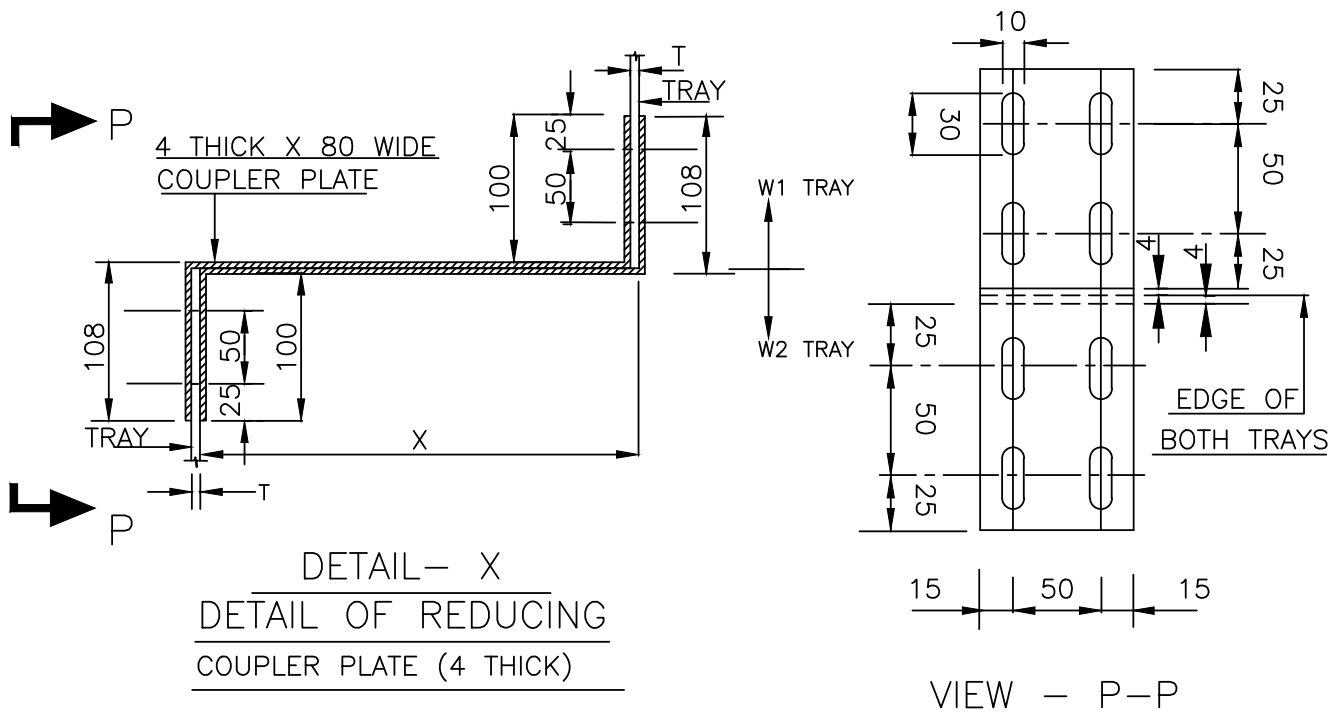
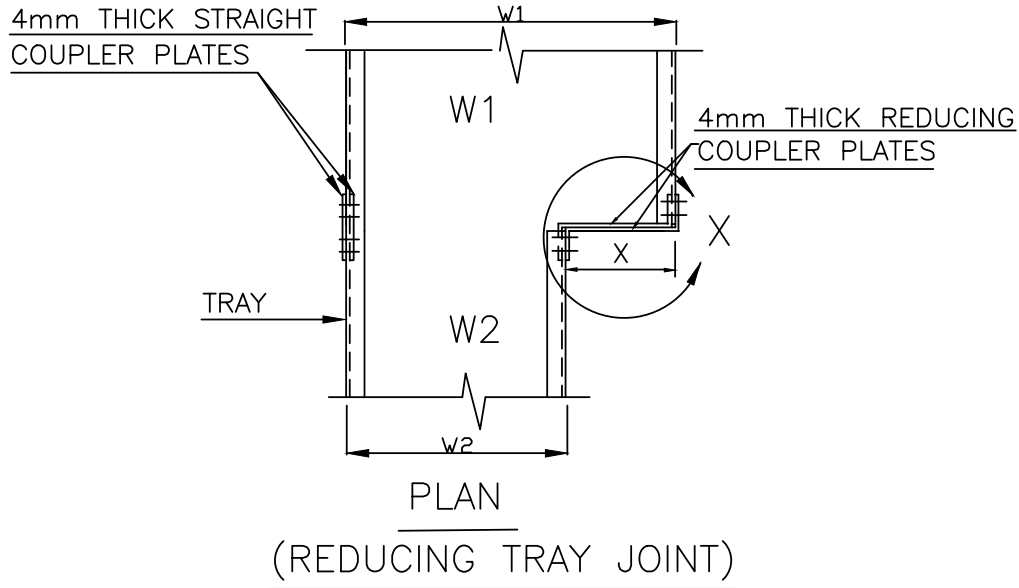

ALL DIMENSIONS ARE IN mm.

SL. NO.	W1	W2	X
1	900	600	300
		450	450
		300	600
2	600	450	150
		300	300
3	450	300	150
		150	300



GENERAL NOTES ON EARTHING AND LIGHTNING PROTECTION

PDSE: 601	0
DOCUMENT NO.	REV
SHEET 1 OF 2	

A. GENERAL

1. EARTHING AND LIGHTNING PROTECTION SHALL BE CARRIED OUT IN ACCORDANCE WITH IS : 3043 AND IS : 2309 RESPECTIVELY AND SHALL ALSO CONFORM TO THE REQUIREMENTS OF INDIAN ELECTRICITY RULES.
2. THESE NOTES SHALL BE READ IN CONJUNCTION WITH EARTHING & LIGHTNING PROTECTION LAYOUT DRGS. AND RELEVANT EARTHING STANDARDS (PDSE)
3. THE SIZE OF EARTH CONDUCTORS & SYMBOLS SHOWN IN THE LAYOUT DRGS. SHALL AS PER PDSE: 602
4. AS FAR AS POSSIBLE, THE EARTH CONDUCTORS SHALL BE TAKEN ALONG POWER & CONTROL CABLE ROUTES.
5. EARTHING CONDUCTORS BURIED UNDER THE GROUND SHALL BE LAID ATLEAST 500 MM BELOW THE GROUND LEVEL UNLESS REQUIRED OTHERWISE, e.g FOR CROSSING ANY UNDER GROUND PIPE OR TRENCH ETC. WHERE THE EARTHING CONDUCTORS SHALL RUN AT A MINIMUM DEPTH 300 MM BELOW THE BOTTOM OF THE PIPE/TRENCH.
6. BARE ALUMINIUM CONDUCTORS SHALL NOT BE BURIED DIRECTLY UNDER THE GROUND.
7. TAPPING FROM THE UNDER GROUND EARTH GRID SHALL BE TAKEN ONLY FROM EARTH PIT OR A PIT WITHOUT ELECTRODE PROVIDED FOR THIS PURPOSE.
8. JOINTING OF UNDERGROUND EARTHING STRIPS SHALL BE AVOIDED TO THE EXTENT POSSIBLE. HOWEVER, IF JOINTING IS TO BE DONE DUE TO UNAVOIDABLE REASONS, THIS SHALL BE DONE BY ELECTRIC ARC WELDING.
9. TERMINAL JOINTING & CLAMPING ARRANGEMENT SHALL BE AS SHOWN IN PDSE:603. ALL WELDED OR BOLTED JOINTS SHALL BE PAINTED WITH EPOXY RESIN PAINT OR BITUMINOUS PAINT.
10. EARTH BUSES, AS PER CONVENIENCE, SHALL BE PROVIDED IN PLANTS FOR EARTHING GROUPS OF EQUIPMENT TO EARTHING GRID. THESE EARTH BUSES, SHALL BE AS SHOWN IN PDSE: 615.
11. DETAILS OF EARTH PIT CONNECTIONS & ACCESSORIES FOR EARTH ELECTRODES SHALL BE AS SHOWN IN PDSE :604, 605 , 610 AND 611.
12. EARTH PITS FOR EQUIPMENT EARTHING, SYSTEM NEUTRAL EARTHING & LIGHTNING PROTECTION SHALL BE SEPARATE. HOWEVER, THESE PITS SHALL BE INTERCONNECTED.
13. SPACING BETWEEN TWO EARTH PITS SHALL NOT BE LESS THAN 10 M & THESE MAY BE LOCATED ABOUT 4M AWAY FROM THE BUILDING / STRUCTURE.
14. TYPICAL ARRANGEMENT OF NEUTRAL & EQUIPMENT EARTHING SHALL BE AS SHOWN IN PDSE: 617.

B. SYSTEM NEUTRAL EARTHING

1. THE NEUTRALS OF H.T & L.T SYSTEMS SHALL BE EARTHED BY USING 2 NOS. 150 SQ. MM ALUMINIUM CABLE OF RESPECTIVE VOLTAGE GRADE. EACH EARTH CONNECTION SHALL BE TERMINATED ON SEPERATE EARTH PITS. HOWEVER, FOR ECONOMY REASONS, 2 EARTH CONNECTIONS OF 2 DIFFERENT EQUIPMENT CAN BE TERMINATED ON THE SAME EARTH PIT AS SHOWN IN PDSE: 617.
2. THE NEUTRAL OF H.T. SYSTEM SHALL BE CONNECTED TO EARTH PIT AS ABOVE THROUGH THE NEUTRAL EARTHING RESISTOR (N.E.R.) AS REQUIRED, WHERE AS THE NEUTRAL OF L.T. SYSTEM SHALL BE SOLIDLY EARTHED THROUGH RESPECTIVE L.T. SWITCH BOARD.
3. FOR D.C. SYSTEM, POSITIVE POLE SHALL BE EARTHED THROUGH HIGH IMPEDANCE IN BATTERY CHARGER.

C. ELECTRICAL EQUIPMENT EARTHING

1. ALL EQUIPMENT RATED ABOVE 250V SHALL HAVE TWO EXTERNAL EARTH CONNECTIONS & THOSE RATED 250V & BELOW SHALL HAVE ONE EXTERNAL EARTH CONNECTION.
FLAME PROOF EQUIPMENT, IN ADDITION, SHALL HAVE ONE INTERNAL EARTH CONNECTION THROUGH ADDITIONAL CORE OF POWER / CONTROL CABLE.

0	03.01.07	15.01.07	ISSUED FOR IMPLEMENTATION			
REV	REV.DATE	EFF.DATE	PURPOSE	PREPD	REVWD	APPD



GENERAL NOTES ON EARTHING AND LIGHTNING PROTECTION

PDSE: 601	0
DOCUMENT NO.	REV
SHEET 2 OF 2	

2. EARTHING CONNECTION TO INDIVIDUAL EQUIPMENT SHALL BE TAPPED ONLY FROM THE EARTHING GRID / RING OR EARTH BUS EXCEPT FOR EQUIPMENT RATED 250V & BELOW, FOR WHICH THE CONNECTION MAY BE TAKEN FROM THE NEAR BY EARTH CONDUCTOR OF A LARGER EQUIPMENT OR FROM THE BODY OF THE LARGER EQPT.
3. EARTHING ARRANGEMENT OF MOTOR AND ASSOCIATED LOCAL CONTROL STATION SHALL BE AS SHOWN IN PDSE: 608.
4. EARTHING ARRANGEMENT OF RAILS SHALL BE AS SHOWN IN PDSE: 609 WITH BOTH ENDS EARTHED.
5. CABLES RACKS/RISERS/TRAYS SHALL BE ELECTRICALLY CONTINUOUS BY BONDING THE JOINTS BETWEEN THE RUNNER MEMBERS OF THE ADJACENT SECTIONS. THE CABLE RACKS SHALL BE CONNECTED TO THE EARTHING GRID AT SUITABLE INTERVALS.
6. EARTHING ARRANGEMENT OF LIGHTING FIXTURES & PLUG SOCKETS RATED 250V AND BELOW SHALL NOT BE SHOWN IN THE EARTHING LAYOUT DRGS. HOWEVER, PLUG SOCKETS SHALL BE EARTHED BY 10 SWG SIZE G.I./AL. CONDUCTOR TAKEN FROM THE NEAREST EARTHING GRID/CONDUCTOR AND LIGHTING FIXTURES SHALL BE PROVIDED EARTHING THROUGH CABLE ARMOURS.
7. IN SWITCH YARD AND GENERATING STATIONS SUITABLE EARTHING MAT SHALL BE PROVIDED TO REDUCE THE VALUE OF STEP/TOUCH POTENTIAL TO PERMISSIBLE VALUE.
8. SWITCH YARD FENCE SHALL BE CONNECTED TO EARTH AT A REGULAR INTERVAL, NOT EXCEEDING 10 M.

D. STATIC EARTHING

1. ALL PROCESS EQUIPMENT WHICH ARE LIKELY TO GET STATICALLY CHARGED, e.g. STORAGE TANKS, HIGH PRESSURE & MEDIUM PRESSURE VESSELS/PIPES, HIGH PRESSURE COMPRESSORS. HIGH PRESSURE STEAM EJECTORS ETC. SHALL BE EARTHED AGAINST STATIC CHARGE ACCUMULATION.
2. EARTHING ARRANGEMENT ACROSS PIPE JOINTS/VALVES SHALL BE AS SHOWN IN PDSE: 612
3. DETAILS OF EARTHING OF VESSELS SHALL BE AS SHOWN IN PDSE: 613.
4. MOBILE EQUIPMENT, REQUIRING EARTHING AGAINST STATIC CHARGE, SHALL BE TEMPORARILY EARTHED AS SHOWN IN PDSE: 608.
5. PIPE TRESTLE CARRYING PIPES WITH HYDRO CARBONS SHALL BE CONNECTED TO EARTH GRID AT REGULAR INTERVALS, NOT EXCEEDING 25 M.
6. WHEREVER PROCESS EQUIPMENT ARE MOUNTED ON STEEL STRUCTURE, THE BASE OF THE STRUCTURES SHALL BE EARTHED INSTEAD OF EARTHING THE INDIVIDUAL EQUIPMENT.

E. LIGHTNING PROTECTION

1. FIXING ARRANGEMENT ON AIR TERMINATION AND ROOF/DOWN CONDUCTOR FOR LIGHTNING PROTECTION SYSTEM SHALL BE AS SHOWN IN PDSE: 614.
2. FOR LIGHTNING PROTECTION OF TALL STEEL STRUCTURES/VESSELS/TANKS, DOWN CONDUCTOR SHALL BE TAKEN FROM THE BASE AND CONNECTED TO EARTH PITS. AIR TERMINATION ROD SHALL NOT BE REQUIRED.
3. LIFT SHAFT SHALL NOT BE USED FOR FIXING THE DOWN CONDUCTOR.
4. IN CASE EARTH PITS FOR CONNECTING THE DOWN CONDUCTORS ARE NOT AVAILABLE IN THE BEGINNING OF FABRICATION/ERECTION OF SUCH STRUCTURES/VESSELS / TANKS. THEIR BASES SHALL TEMPORARILY BE CONNECTED TO NEAR BY STEEL COLUMN. ELECTRICAL CONTINUITY OF THE STRUCTURES, HOWEVER, SHALL BE CHECKED AND ENSURED.
5. FOR ALL HIGH RISE CONCRETE STRUCTURES, TEMPORARY LIGHTNING PROTECTION NEED BE PROVIDED DURING CONSTRUCTION AND MAINTAINED TILL PERMANENT LIGHTNING PROTECTION IS INSTALLED. FOR THIS PURPOSE THE VERTICAL REINFORCEMENT, PROJECTING OVER EACH LIFT, SHALL BE CONNECTED TO EARTH PITS BY MEANS OF 2 NOS. FLEXIBLE COPPER CONDUCTOR CABLES. EACH OF THE FLEXIBLE CABLE SHALL BE OF 95 Sq. mm SIZE HAVING ONE END PERMANENTLY CONNECTED TO EARTH PIT AND OTHER END PROVIDED WITH A CLAMP FOR CONNECTING TO THE EXPOSED REINFORCEMENT.

0	03.01.07	15.01.07	ISSUED FOR IMPLEMENTATION	<i>USK</i> NKR	<i>Amur</i> AV	<i>BB</i> BB
REV	REV.DATE	EFF.DATE	PURPOSE	PREPD	REVWD	APPD

SL. No.	EQUIPMENT TO BE EARTHED	FAULT LEVEL (MVA)	G.I. STRIPS/WIRES		ALUMINIUM			REMARKS				
			MIN. SIZE (mm ²)	SIZE TO BE USED (mm ²)	SYMBOL	MIN. SIZE (mm ²)	STRIPS/WIRES SIZE TO BE USED (mm ²)		SYMBOL	1.1kv PVC SINGLE CORE CABLE SIZE (mm ²)		
1A.	FOR PLANTS HAVING SWITCHYARDS/ GENERATING STATION											
I.	SWITCH YARD EQUIPMENT, GENERATORS, H.T. SWITCH BOARDS, TRANSFORMERS, MAIN EARTHING GRID, CONNECTION FROM EARTH BUS TO EARTHING GRID.	750 AT 11KV	706	2-50x8	2	491	2-38.1x6.35=484	12	2	500	21	AS PER CLAUSE 17.3.2 OF IS:3043
II.	SWITCH YARD EQUIPMENT, GENERATORS, H.T. SWITCH BOARDS, TRANSFORMERS, MAIN EARTHING GRID, CONNECTION FROM EARTH BUS TO EARTHING GRID.	500 AT 11KV 300 AT 6.6KV 150 AT 3.3KV	471	60x8	1	328	50.8x6.35=323	11		400	22	-D0-
III.	SWITCH YARD EQUIPMENT, GENERATORS, H.T. SWITCH BOARDS, TRANSFORMERS, MAIN EARTHING GRID, CONNECTION FROM EARTH BUS TO EARTHING GRID.	250 AT 6.6KV 125 AT 3.3KV	392	50x8	2	272	50.8x6.35=323	11		300	23	-D0-
IV.	SWITCH YARD EQUIPMENT, GENERATORS, H.T. SWITCH BOARDS, TRANSFORMERS, MAIN EARTHING GRID, CONNECTION FROM EARTH BUS TO EARTHING GRID.	350 AT 11KV 200 AT 6.6KV 100 AT 3.3KV	330 314 314	50x8	2	229 218 218	38.1x6.35=242	12		240	24	-D0-
V.	SWITCH YARD EQUIPMENT, GENERATORS, H.T. SWITCH BOARDS, TRANSFORMERS, MAIN EARTHING GRID, CONNECTION FROM EARTH BUS TO EARTHING GRID.	250 AT 11KV 150 AT 6.6KV 75 AT 3.3KV	235	50x6	3	163	31.75x4.78=152	13		185	25	-D0-
1B	FOR PLANTS WITHOUT SW. YARD/GENERATING STN. H.T. SWITCH BOARDS, TRANSFORMERS, MAIN EARTHING GRID, CONNECTION FROM EARTH BUS TO EARTHING GRID.	ANY FAULT LEVEL AT ANY VOLTAGE	210	50x6	3	120	38.1x3.18=121	14		120	27	AS PER CLAUSE 12.3.2 OF IS:3043
1C	ALL M.V. SWITCH BOARDS		210	50x6	3	120	38.1x3.18=121	14		120	27	AS PER CLAUSE 12.3.2 OF IS:3043
2	H.V. MOTORS		210	50x6	3	120	38.1x3.18=121	14		120	27	-D0-
3	TRANSFORMER NEUTRALS		-	-	-	120	-			150	26	-
4	M.V. MOTORS RATED 75KW & ABOVE		210	50x6	3	120	38.1x3.18=121	14		120	27	AS PER CLAUSE 12.3.2 OF IS:3043
5	M.V. MOTORS ABOVE 30KW & LESS THAN 75KW		175	35x6	4	93	31.75x3.18=101	15		95	28	-D0-

SL. No.	EQUIPMENT TO BE EARTHED	FAULT LEVEL (MVA)	G.I. STRIPS/WIRES		ALUMINIUM STRIPS/WIRES			REMARKS			
			MIN. SIZE (mm ²)	SIZE TO BE USED (mm ²)	SYMBOL	MIN. SIZE (mm ²)	SIZE TO BE USED (mm ²)		SYMBOL		
6	M.V.MOTORS ABOVE 5.5KW & LESS THAN 30KW 63A SW.SOCKETS,BATTERY CHARGERS,LIGHTING SUB-DIST.BDS.,D.C.BDS.		44	25x6	5	25	2 SWG=38.6	17	25	29	AS PER CLAUSE 12.3.2 OF IS:3043
7	M.V.MOTORS RATED 5.5KW & BELOW		7	8 SWG=13	6	5	10 SWG=8.3	18	6	30	-D0-
8	ALL MINOR EQUIPMENT RATED FOR 250V & BELOW		-	10 SWG=8.3	7	-	10 SWG=8.3	18	6	30	
9	NON ELECTRICAL EQUIPMENT,SUCH AS VESSELS STRUCTURES IN HAZARDOUS AREA & LIGHTNING PROTECTION CONDUCTORS		32x6	35x6	4	-	25.4x3.18=81	16	-	-	AS PER IS:2309

NOTE :--EARTHING CONDUCTOR SIZES FOR ITEMS AT SL.No.4,5,6 & 7 SHOULD BE CHOSEN AS HALF THE POWER CABLE SIZES ACTUALLY USED.

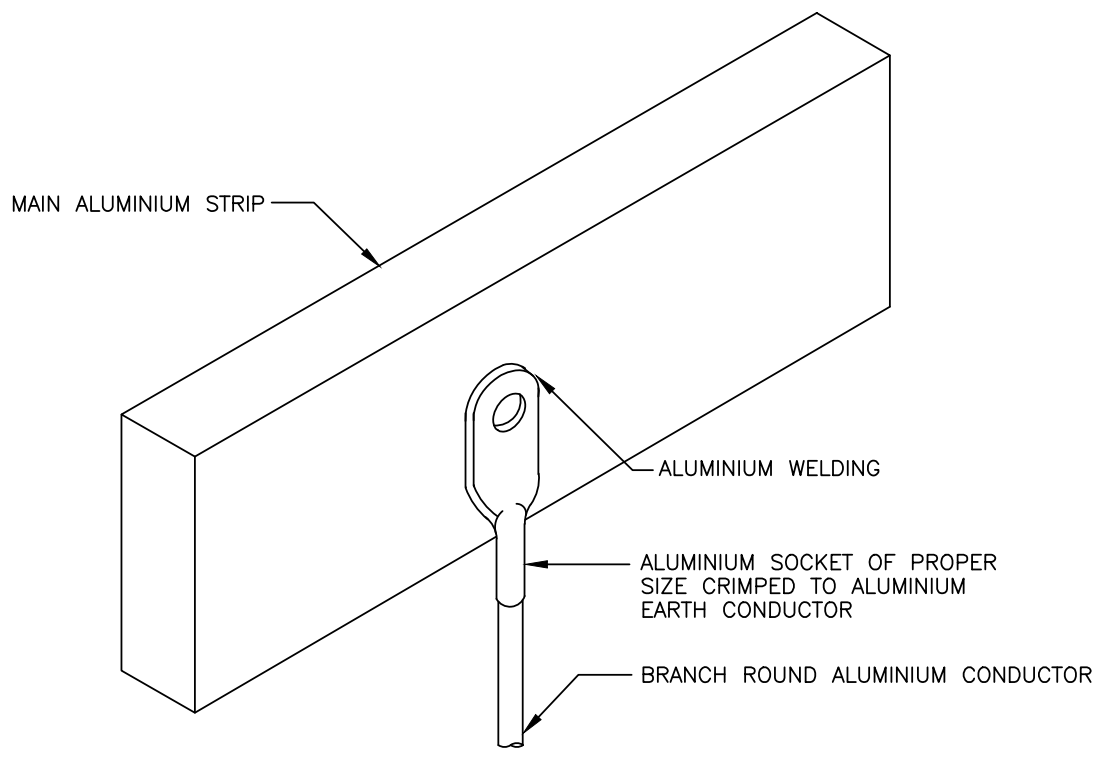

' T ' JOINT ALUMINIUM STRIP TO ROUND ALUMINIUM CONDUCTOR

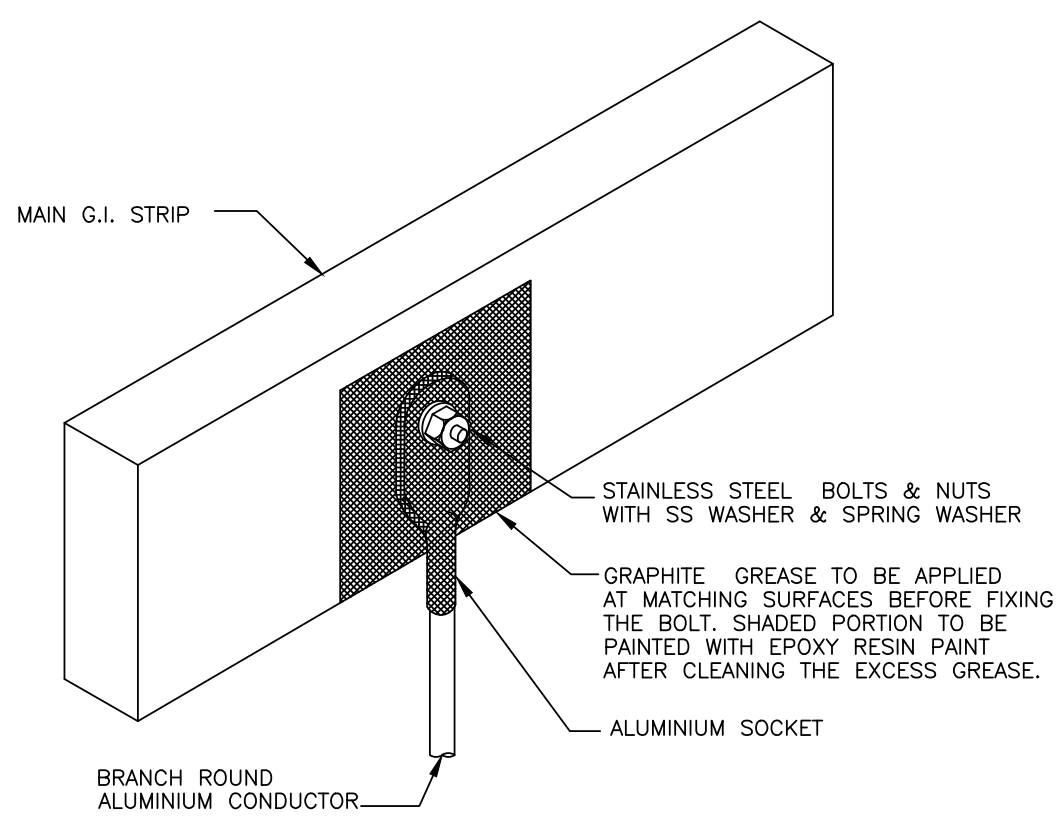

' T ' JOINT G.I. STRIP TO ROUND ALUMINIUM CONDUCTOR

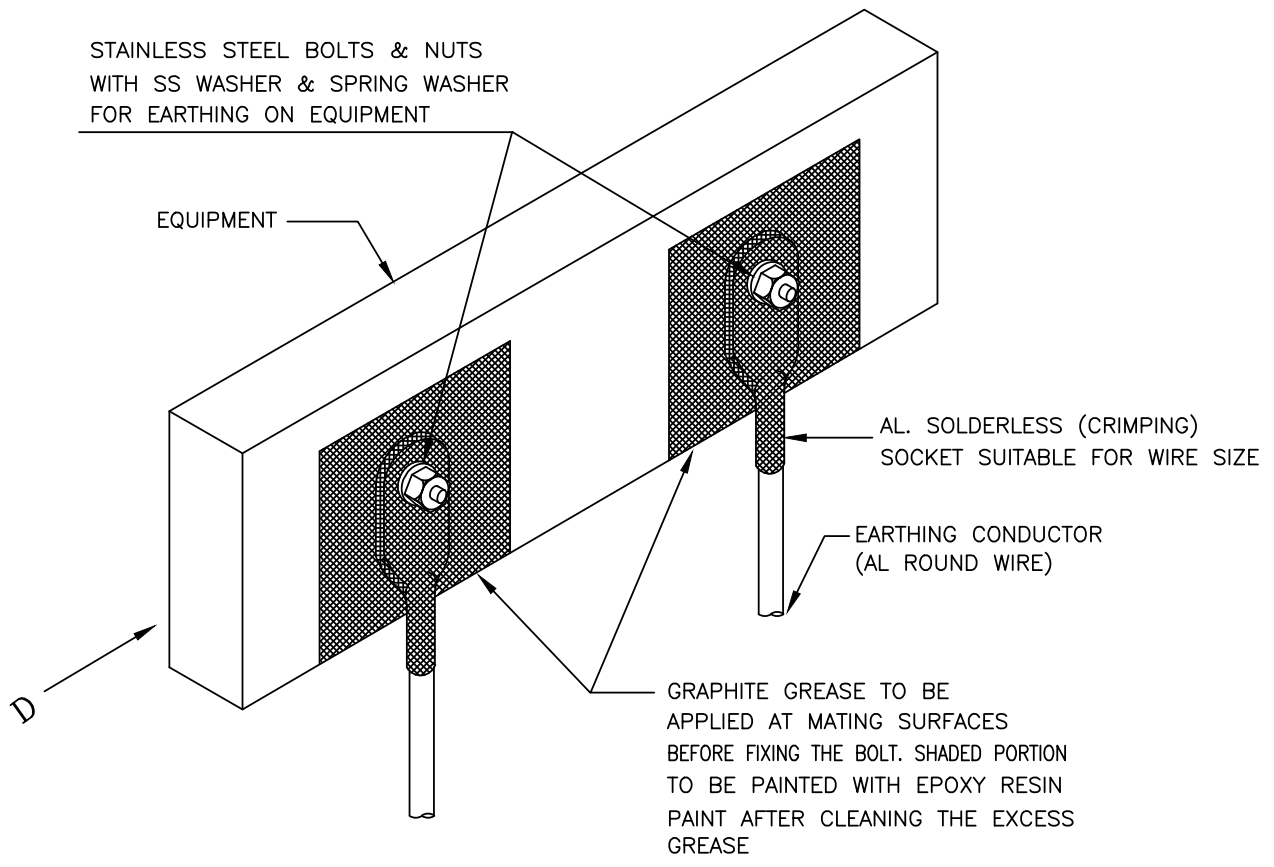

ARRANGEMENT OF DOUBLE EARTH CONNECTIONS TO EQUIPMENT

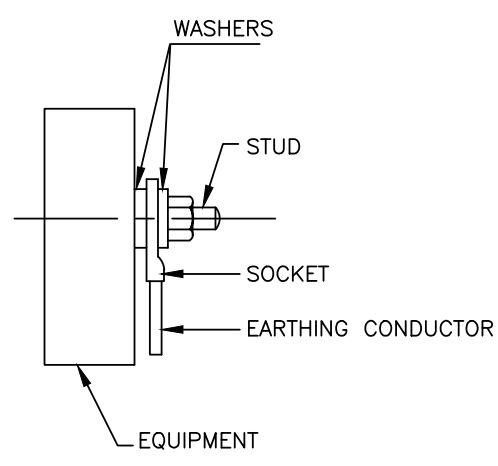

V I E W F R O M - D

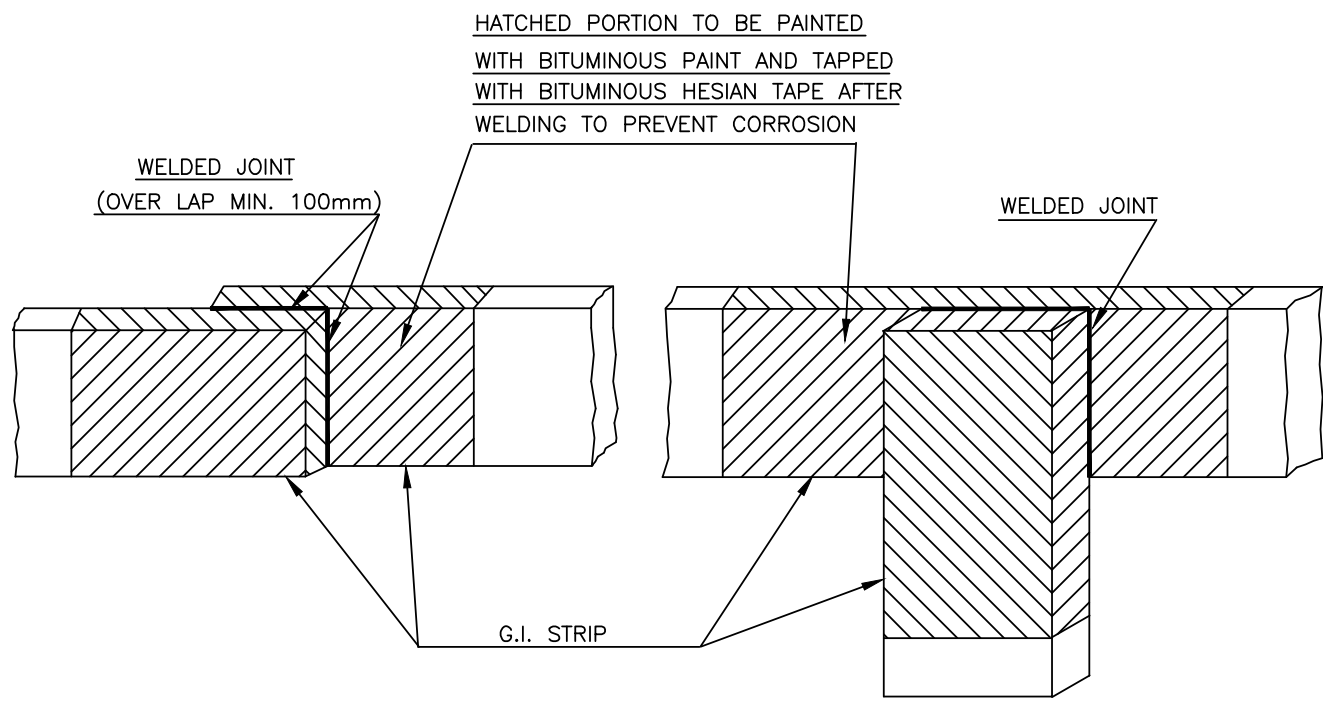

STRAIGHT JOINT G.I TO G.I. STRIP

" T " JOINT G.I. TO G.I. STRIP

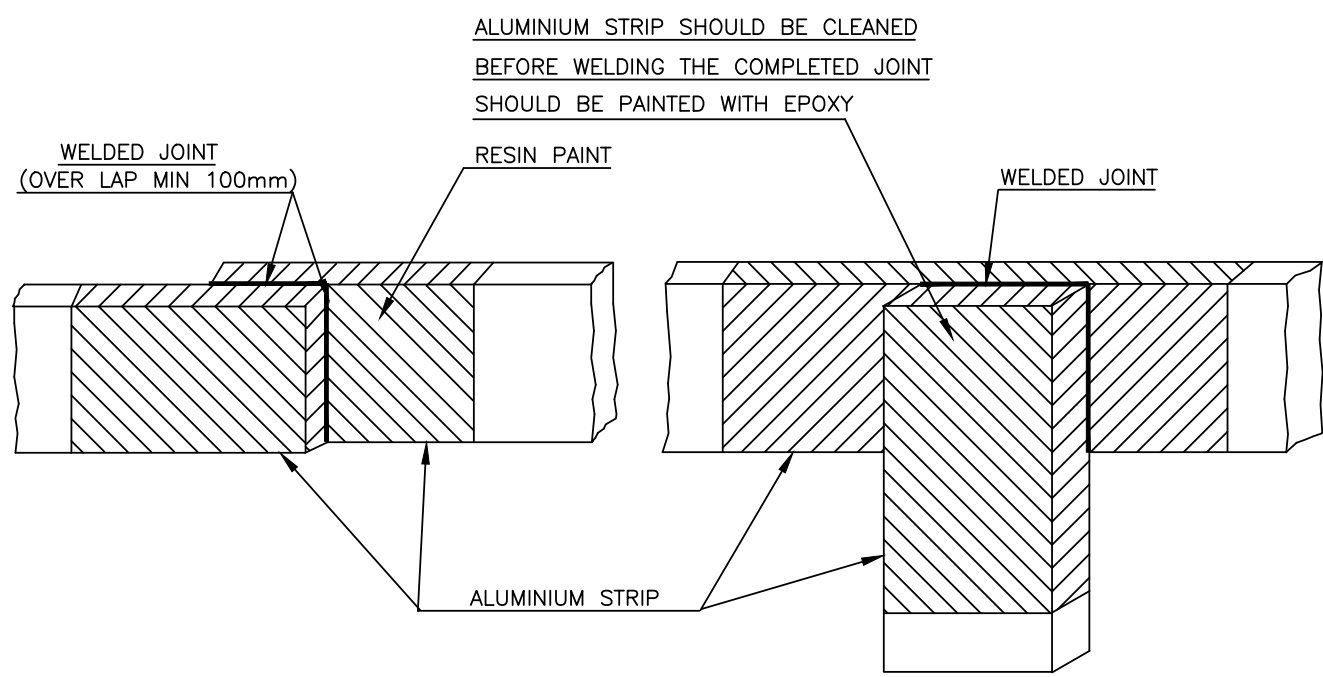

STRAIGHT JOINT AL. TO AL. STRIP

" T " JOINT AL TO AL STRIP

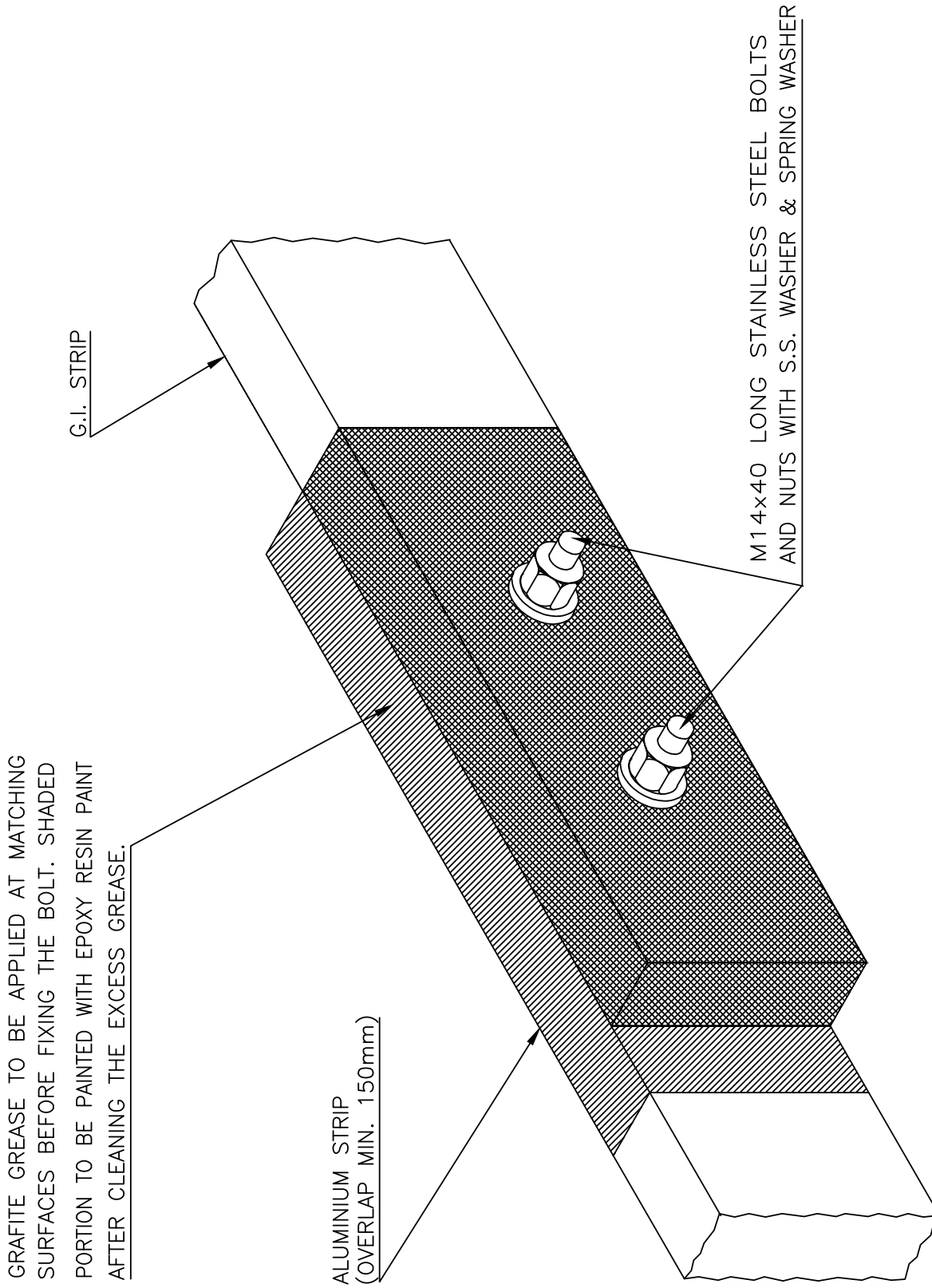

ARRANGEMENT OF LAP JOINT BETWEEN
AL. EARTH STRIP TO G.I. EARTH STRIP

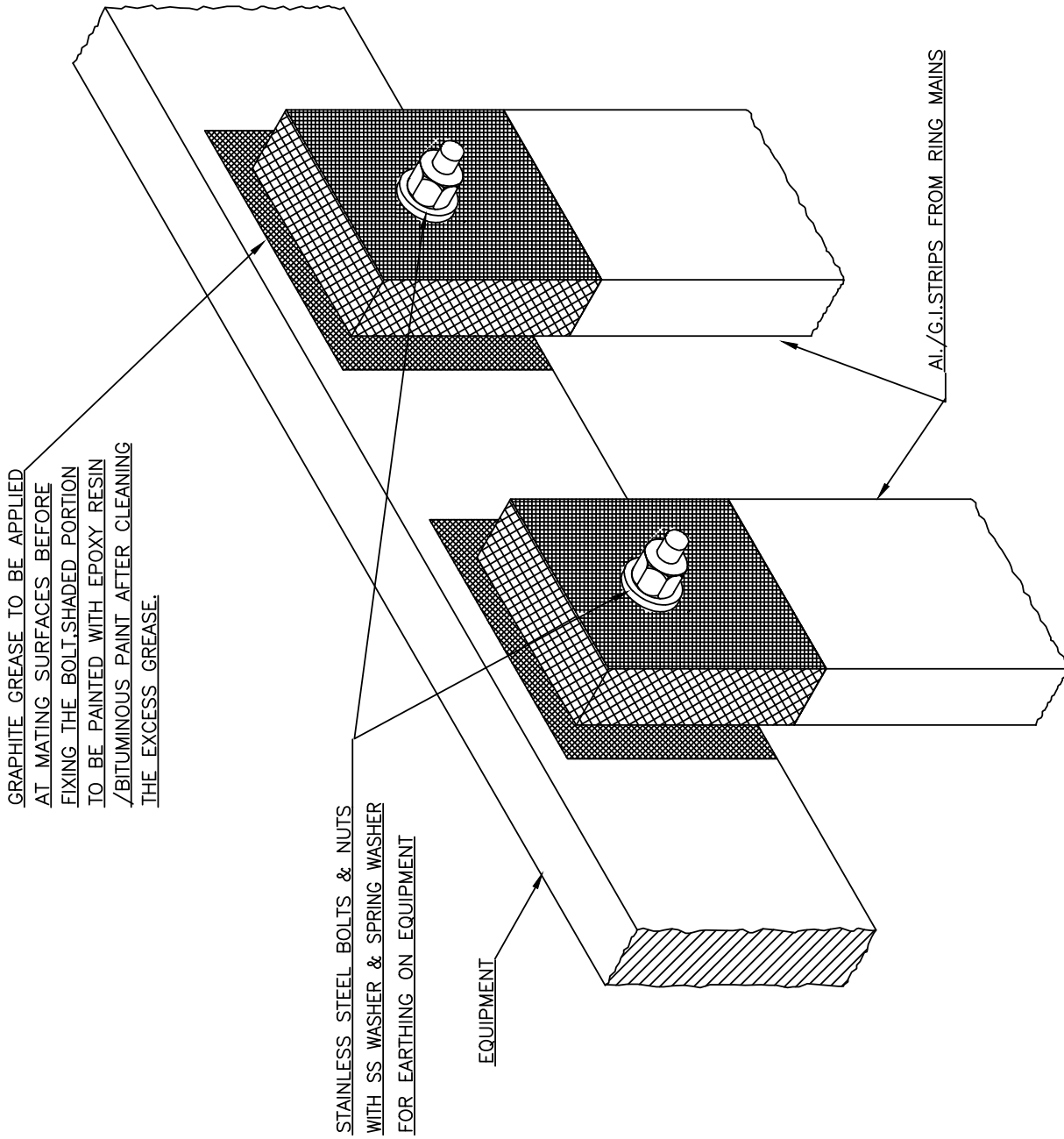

ARRANGEMENT OF DOUBLE EARTH CONNECTION ON EQUIPMENT

NOTE:-

EPOXY RESIN PAINT SHALL BE USED FOR AL STRIP AND BITUMINOUS PAINT FOR G.I. STRIP.

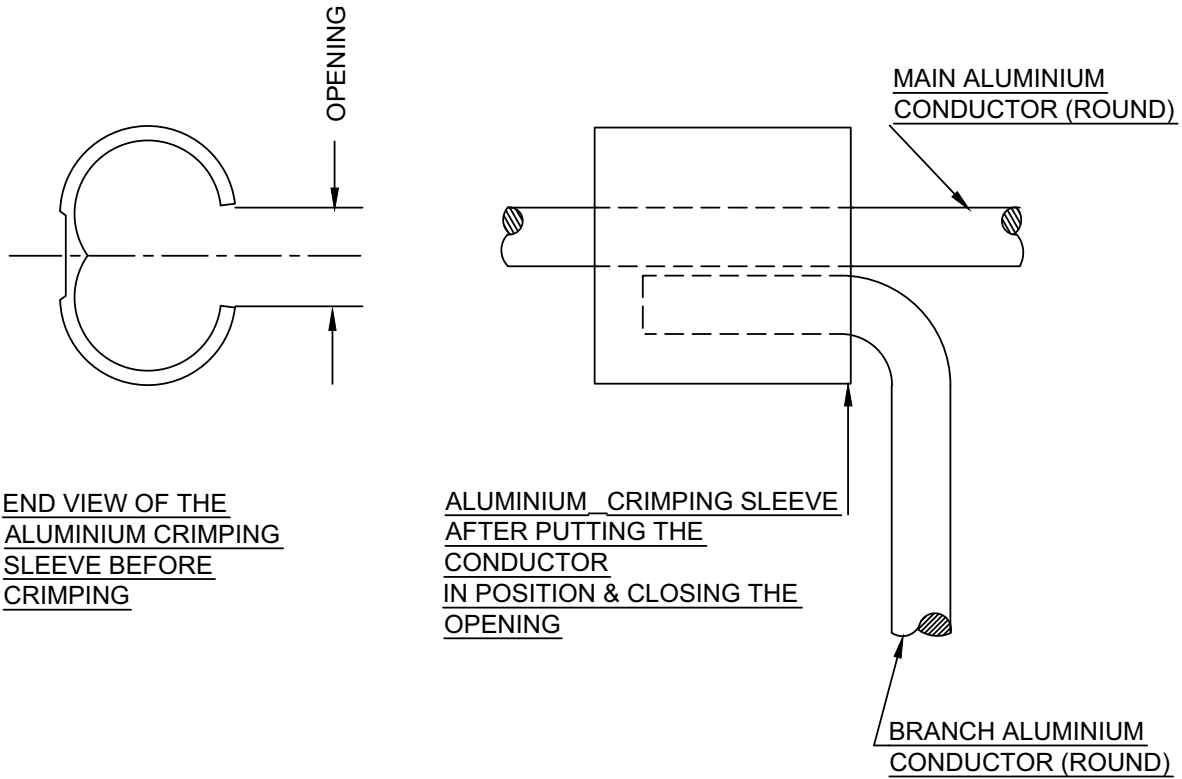

"T" JOINT ROUND ALUMINIUM CONDUCTOR TO ROUND ALUMINIUM CONDUCTOR (CRIMPING TYPE)

NOTE :-

USE CORRECT SIZE OF COMPRESSION DIES.

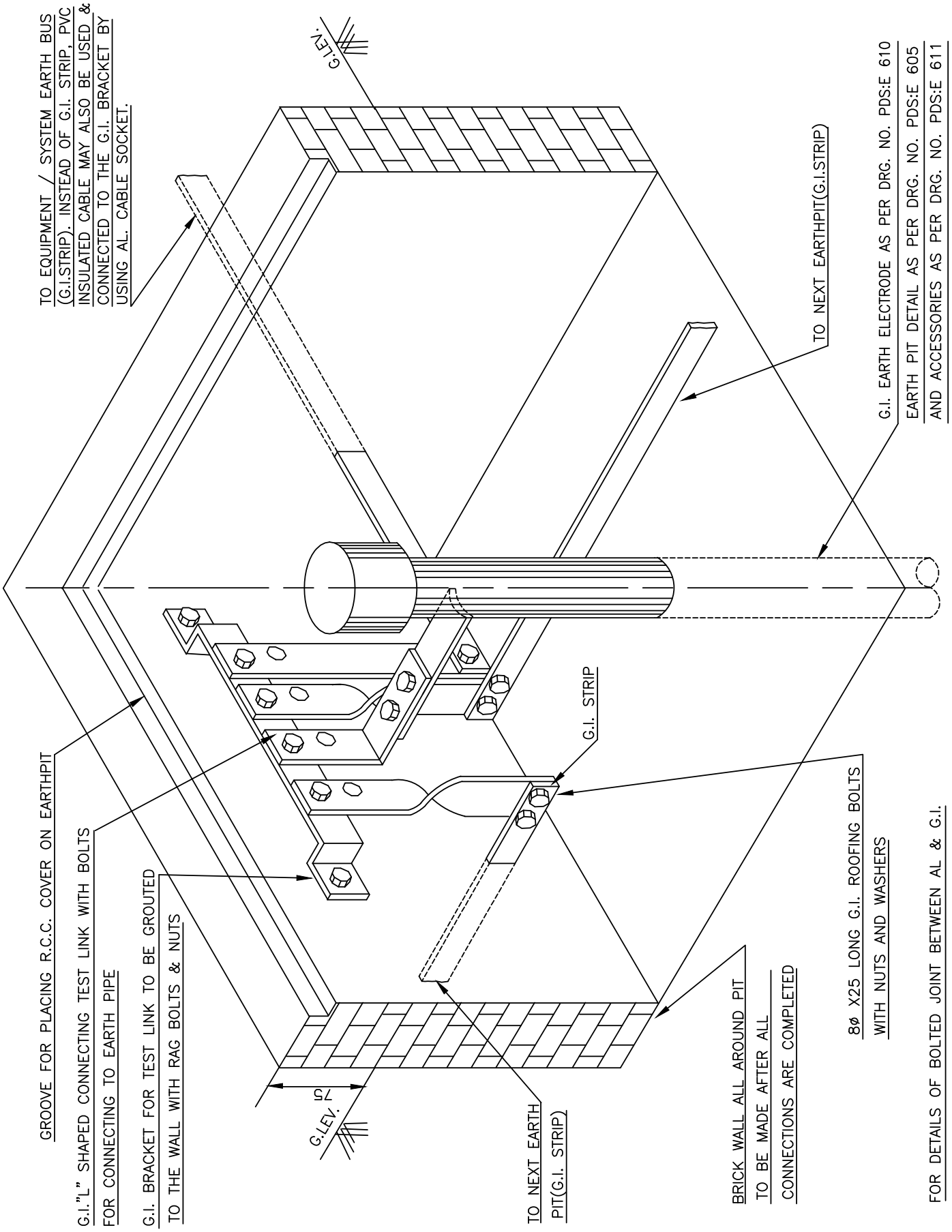

GROOVE FOR PLACING R.C.C. COVER ON EARTH PIT

G.I."L" SHAPED CONNECTING TEST LINK WITH BOLTS FOR CONNECTING TO EARTH PIPE

G.I. BRACKET FOR TEST LINK TO BE GROUDED TO THE WALL WITH RAG BOLTS & NUTS

TO NEXT EARTH PIT(G.I. STRIP)

BRICK WALL ALL AROUND PIT TO BE MADE AFTER ALL CONNECTIONS ARE COMPLETED

8φ X25 LONG G.I. ROOFING BOLTS WITH NUTS AND WASHERS

FOR DETAILS OF BOLTED JOINT BETWEEN AL & G.I. REFER PDS:E 603 (SHEET 4 OF 6)

TO EQUIPMENT / SYSTEM EARTH BUS (G.I.STRIP). INSTEAD OF G.I. STRIP, PVC INSULATED CABLE MAY ALSO BE USED & CONNECTED TO THE G.I. BRACKET BY USING AL. CABLE SOCKET.

TO NEXT EARTH PIT(G.I.STRIP)

G.I. EARTH ELECTRODE AS PER DRG. NO. PDS:E 610
EARTH PIT DETAIL AS PER DRG. NO. PDS:E 605
AND ACCESSORIES AS PER DRG. NO. PDS:E 611

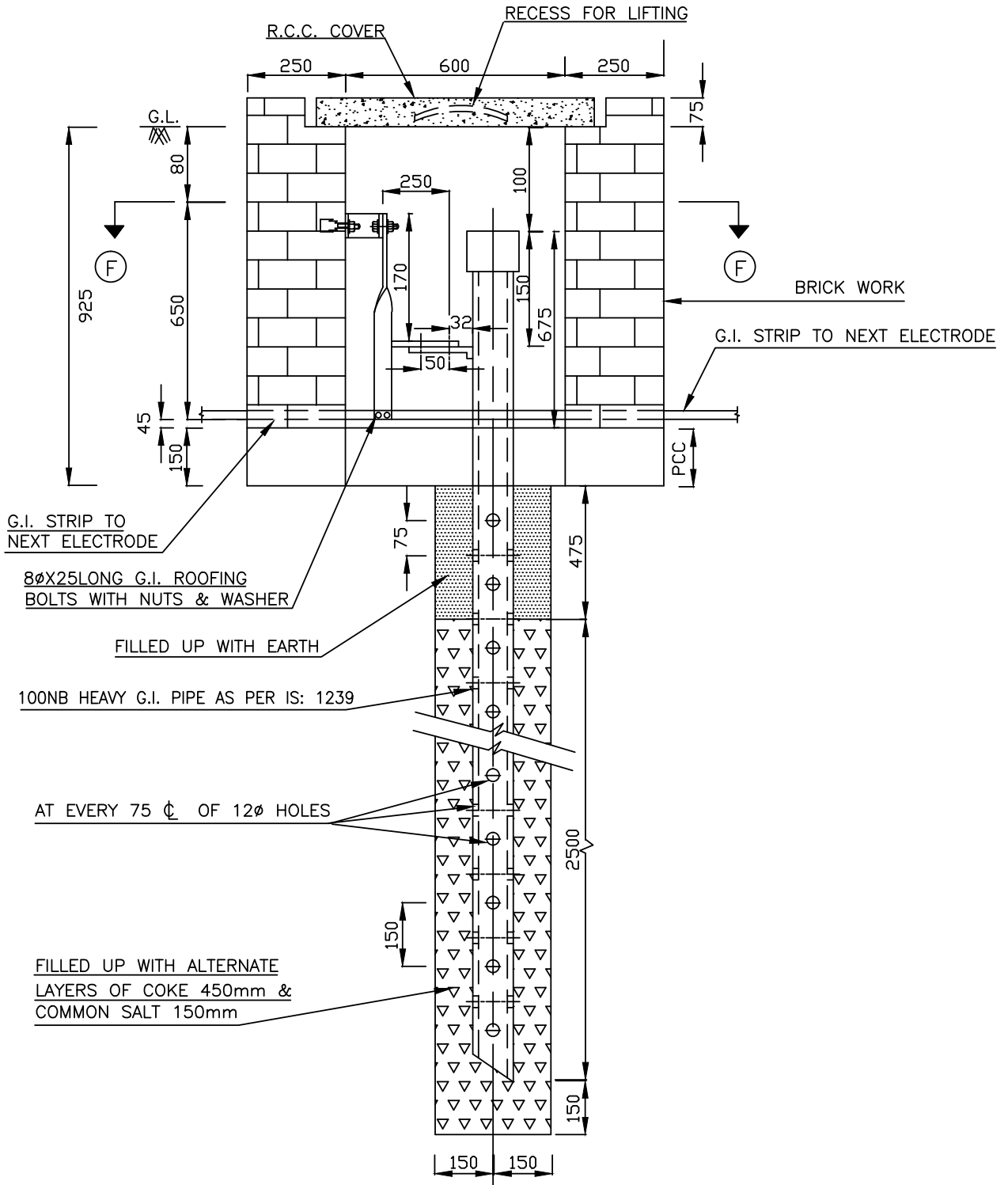

SECTIONAL ELEVATION OF EARTH PIT

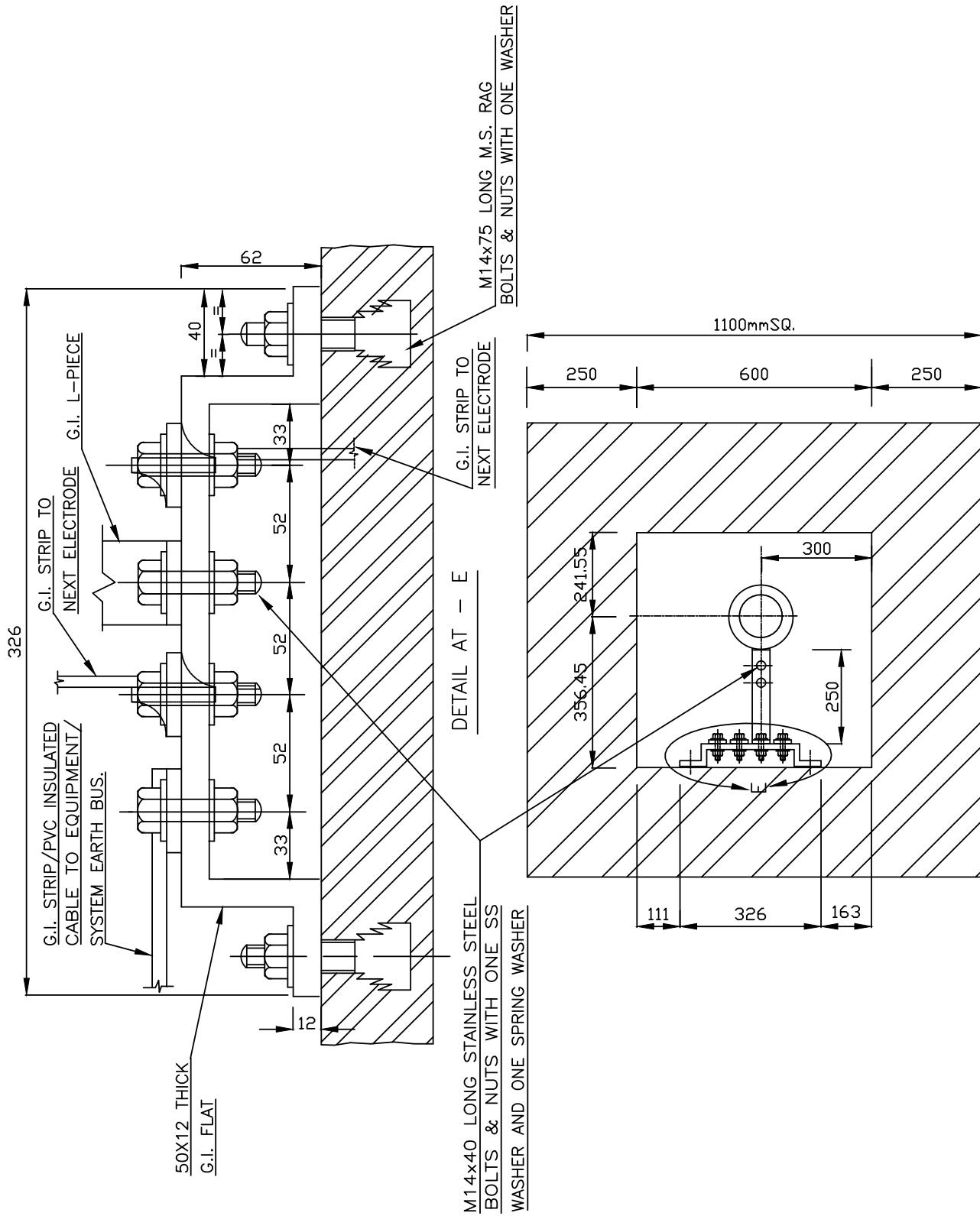

SECTION F-F

PVC INSULATED CONDUCTOR/ G.I.WIRE/
AL. WIRE FOR EARTHING OF MOTOR

2 NOS. EARTHING CONDUCTORS

POWER CABLE

CONTROL CABLE

CABLE CLAMPING
ARRANGEMENT

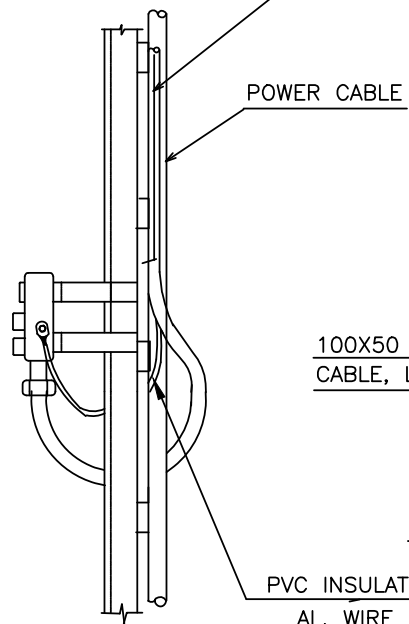

VIEW AT-A

MOTOR TERMINAL BOX

RUBBER BUSHING

50X6 FLATS WELDED TO
THE CHANNEL @ 300
INTERVAL

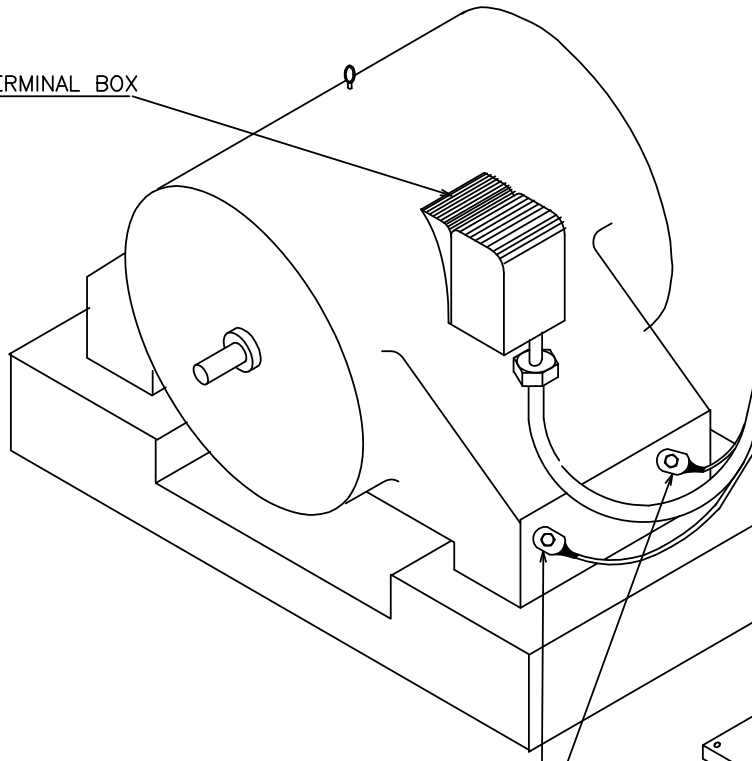

200x200x10 THCK PLATE
GROUTED FLUSHING WITH
FINISH FLOOR LEVEL

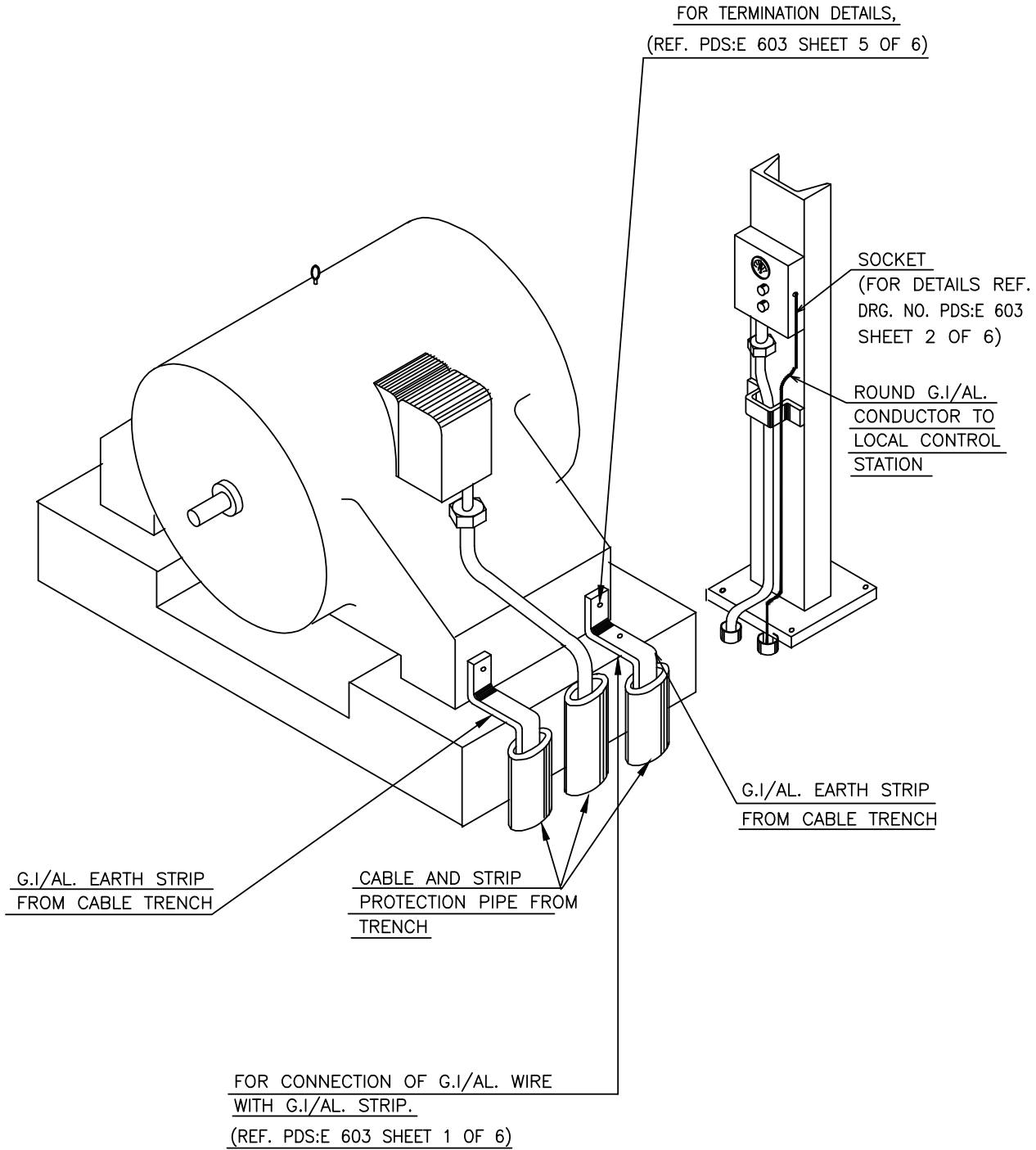

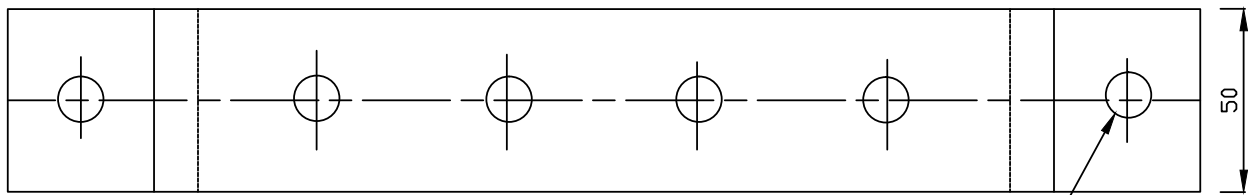
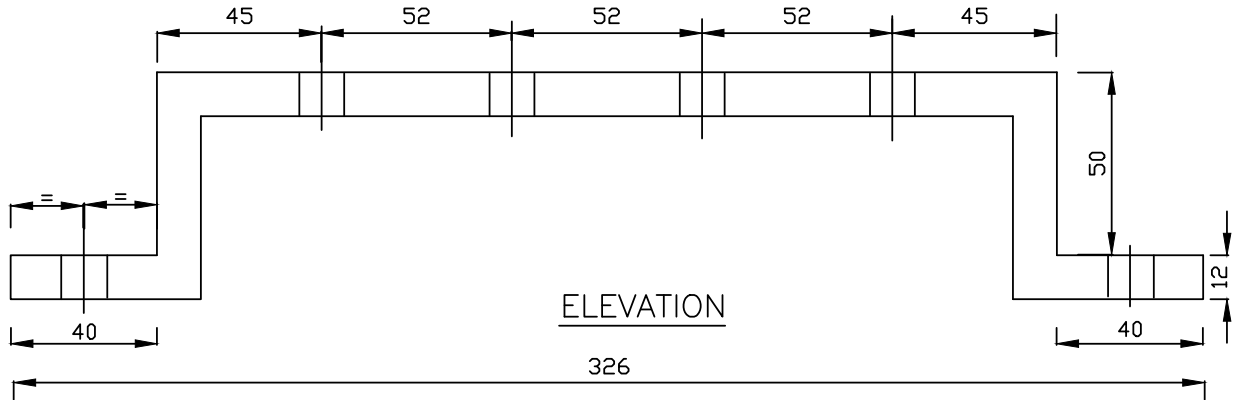

G.I. TEST LINK

HOLES SUITABLE FOR 12 ϕ (M14) BOLTS

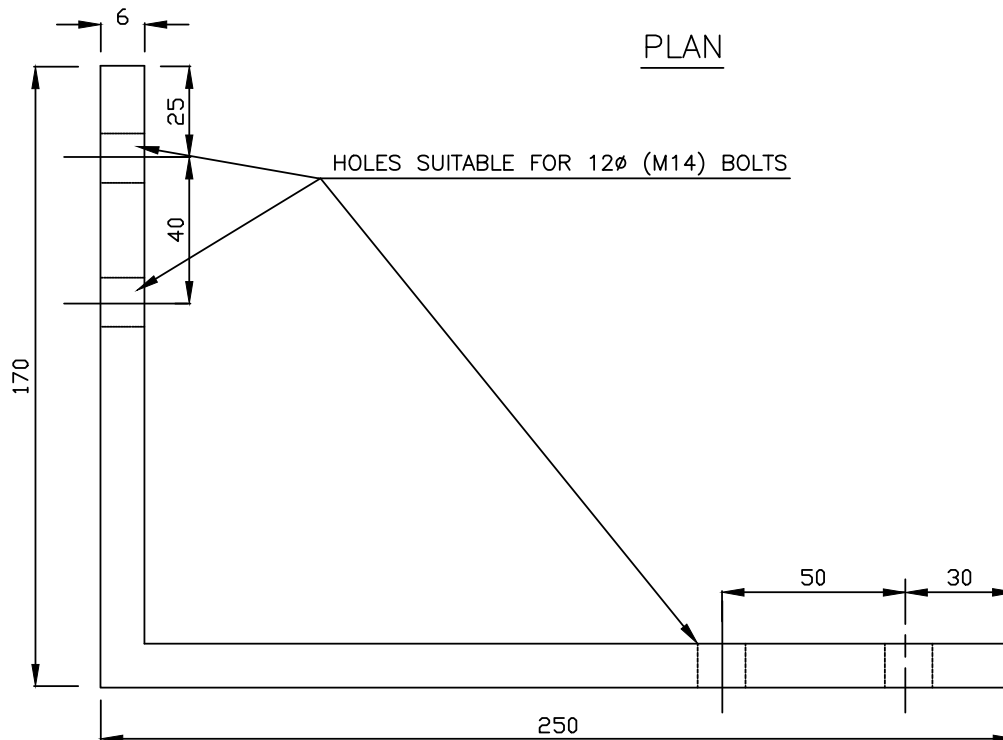
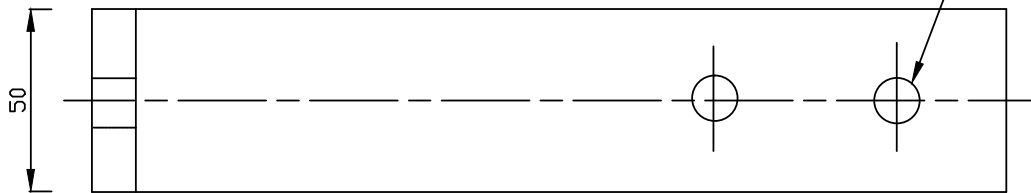

G.I. 'L' PIECE

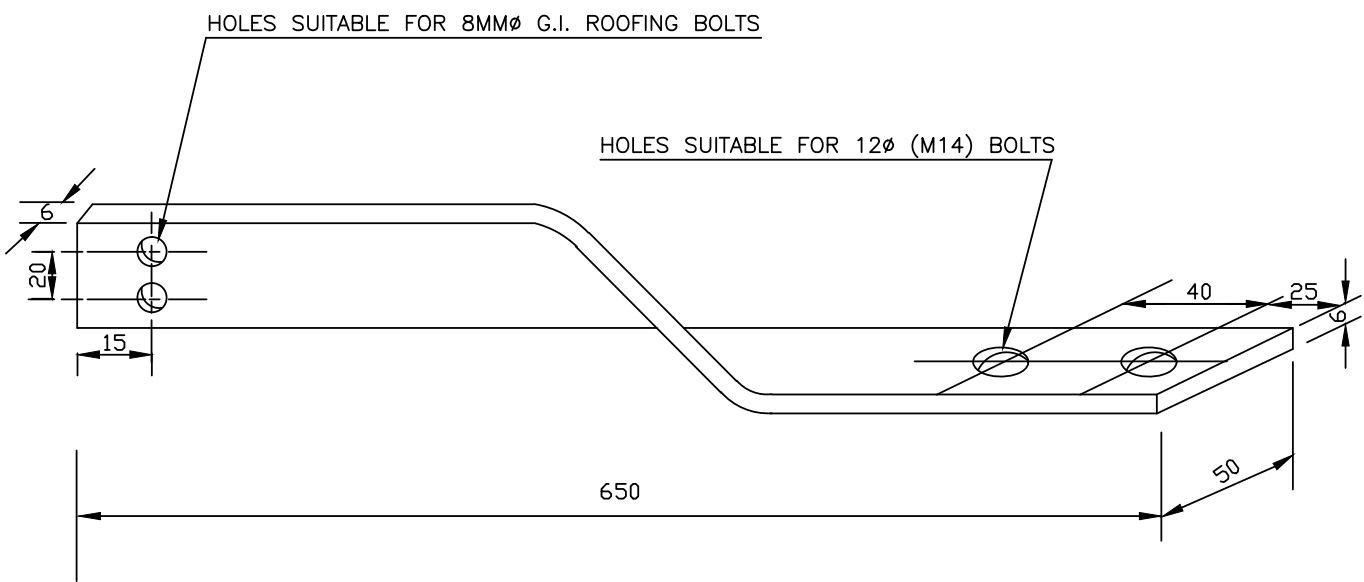

CONNECTING TWISTED ALUMINIUM FLAT PIECE

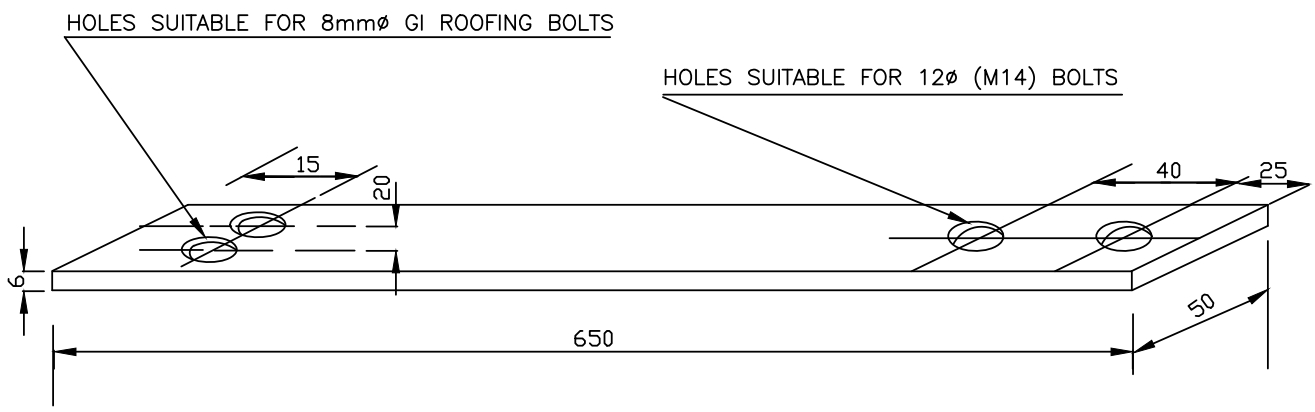

CONNECTING ALUMINIUM / G.I. FLAT PIECE

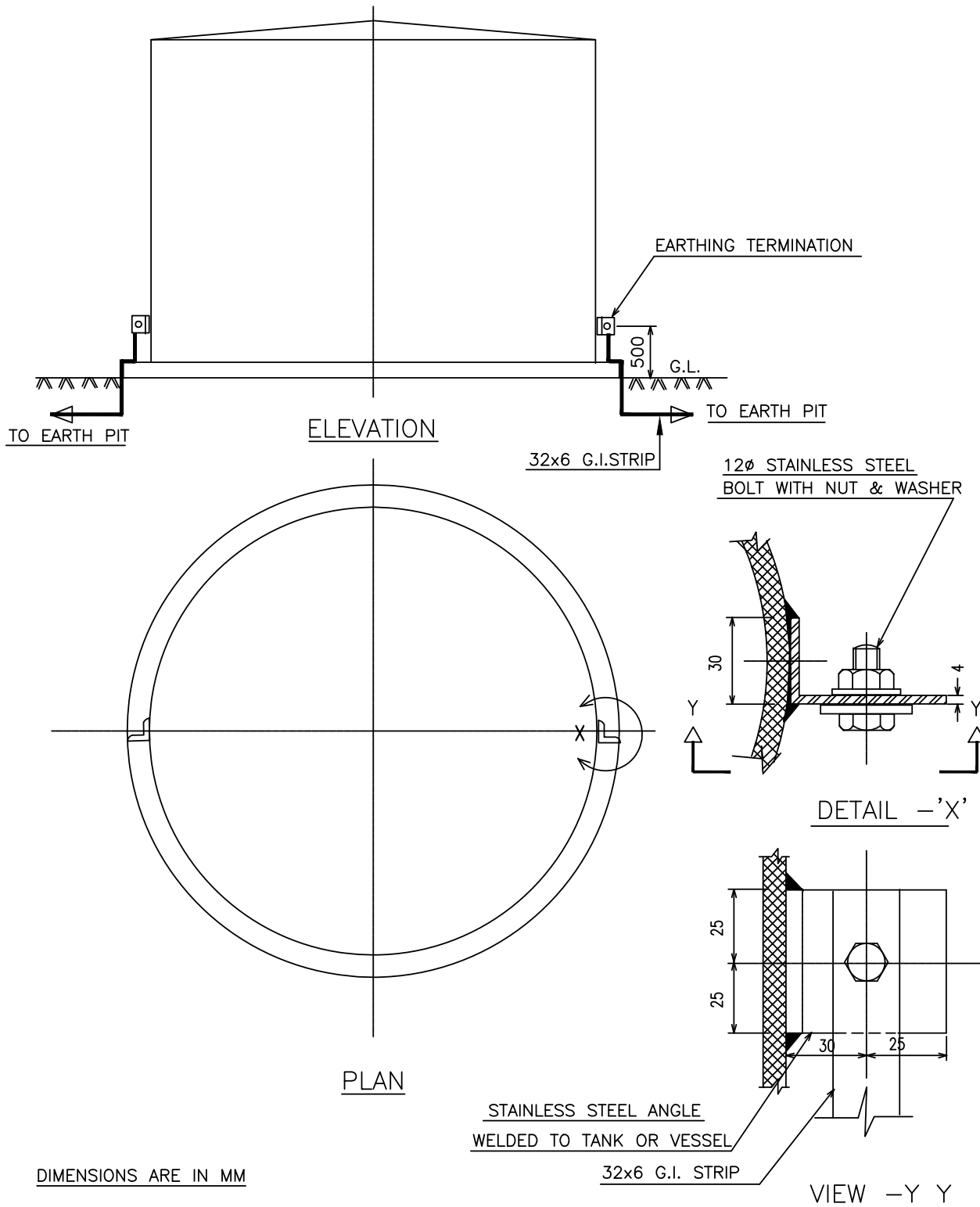

THE NO. OF EARTH CONDUCTOR SHALL BE AS FOLLOWS

EQUIPMENT WITH ANY DIMENSION	HAZARDOUS AREA	NON-HAZARDOUS AREA
≤ 3 Mts.	1	1
> 3 Mts. ≤ 30 Mts.	2	1
> 30 Mts.	3	2

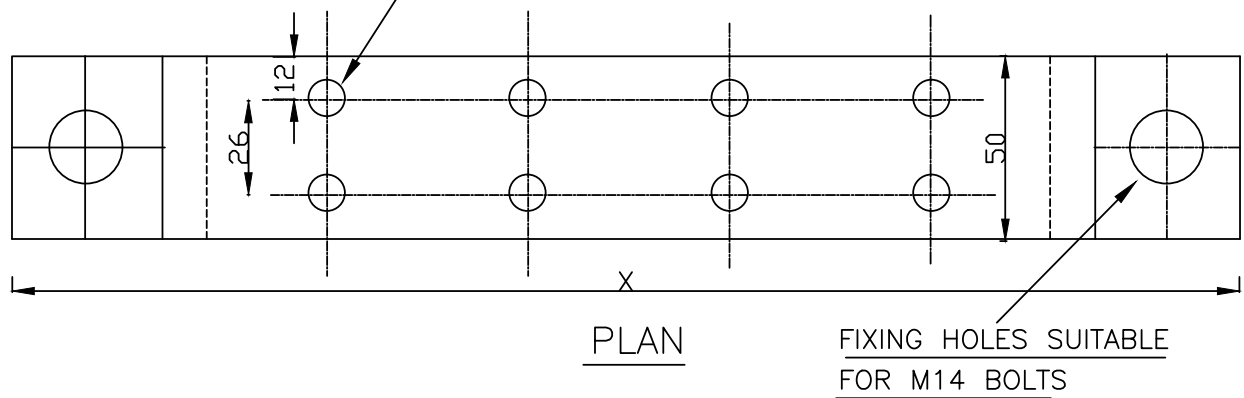
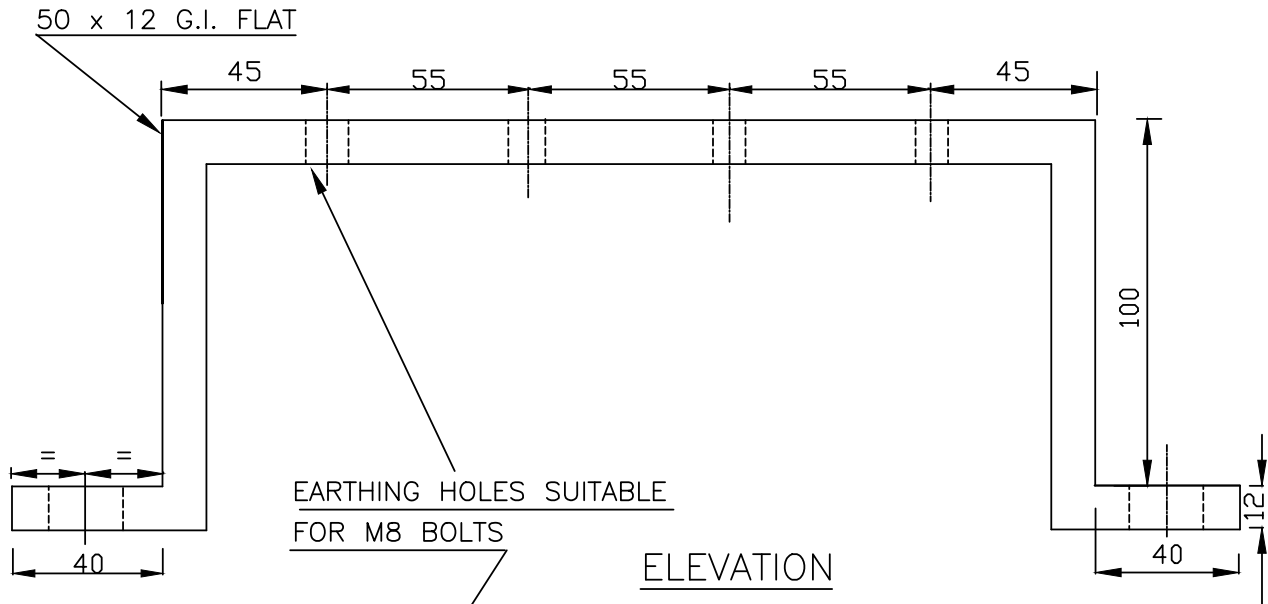

TYPE OF EARTH BUS	NO.OF EARTHING HOLES	OVERALL LENGTH x (mm)
1	8	335
2	10	390

NOTES:-

1. LOCATION OF EARTH BUS TO BE DECIDED AS PER EQUIPMENT POSITION AT SITE.
2. EARTH BUSES SHALL BE LOCATED ON STRUCTURES/COLUMNS WALLS/EQUIPMENT FOUNDATION ETC.
3. MOUNTING HEIGHT OF EARTH BUS SHALL NOT BE LESS THAN 500mm FROM FINISHED FLOOR LEVEL
4. ALL DIMENSIONS ARE IN mm

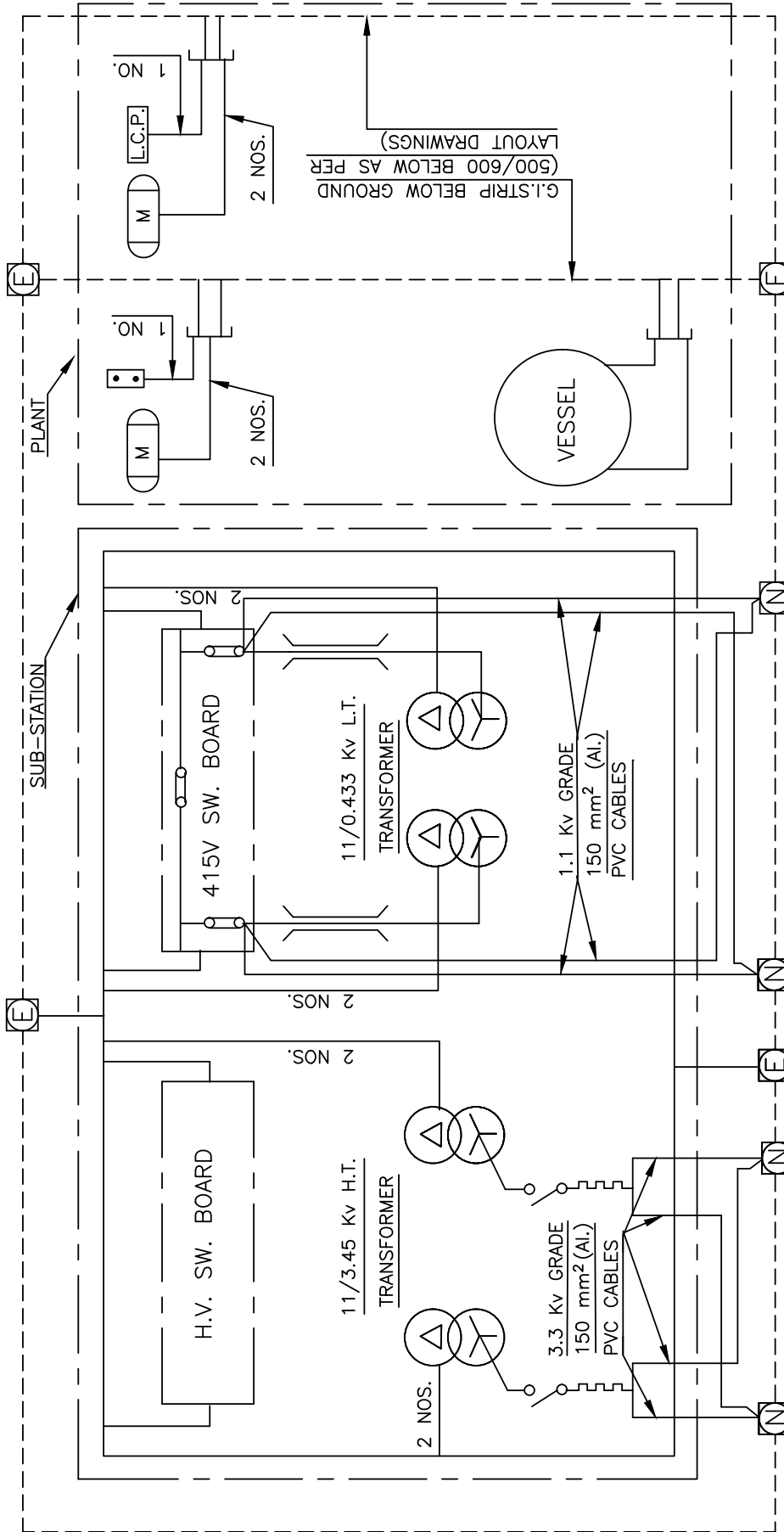

- REF. DRGS.
1. EARTH PIT DETAILS - PDS:E 605
 2. EARTH CONDUCTOR SIZES - PDS:E 602 (2 SHEETS)
- NOTE :-
EARTH BUS SHALL BE 500 ABOVE FROM FLOOR LEVEL

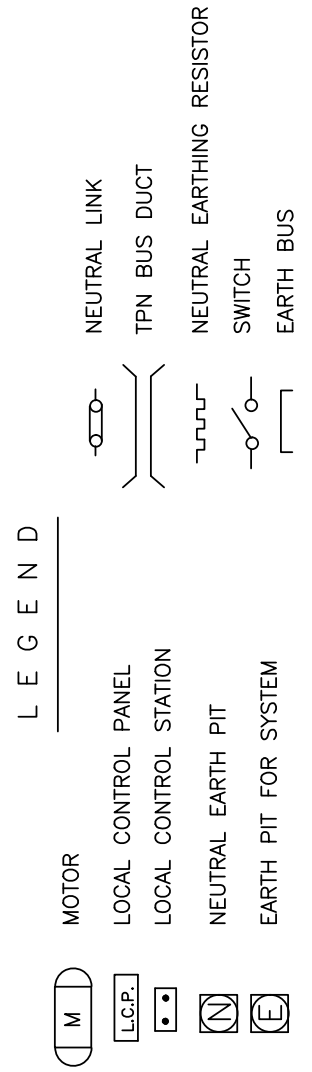

 PROJECTS & DEVELOPMENT INDIA LTD.	PC183/E/4022/SECVI-3.2.1		0	
	Document No.		Rev	
	Sheet 1 OF 12			

SECTION:VI – 3.2.1

DESIGN PHILOSOPHY – EOT CRANE & HOIST

PLANT : EMERGENCY DIESEL GENERATORS PACKAGE

**PROJECT : INTEGRATED COAL BASED FERTILISER
COMPLEX, AT TALCHER, ANGUL DISTRICT,
ODISHA**

0	06.09.2023	06.09.2023	Issued for Tender	NY	YKG	RRK
REV	REV DATE	EFF DATE	PURPOSE	PRPD	REVD	APPD





	EMERGENCY DIESEL GENERATORS PACKAGE TALCHER FERTILIZERS LIMITED DESIGN PHILOSOPHY – EOT CRANE & HOIST	PC183/E/4022/SECVI-3.2.1	0	
		Document No.	Rev	
		Sheet 2 OF 12		

TABLE OF CONTENTS

SL NO.	DESCRIPTION
1.0	Intent
2.0	Scope of Supply & Erection
3.0	General Design Requirements
4.0	Specific Design Requirements
5.0	Battery Limits
6.0	Extent of Supply & Erection
7.0	Inspection, Testing & Repairs
8.0	Preparation of Shipment
9.0	Painting
10.0	Spares
11.0	Drawings and Documents
12.0	Guarantee
13.0	Priority
14.0	Sub-Vendors

	EMERGENCY DIESEL GENERATORS PACKAGE TALCHER FERTILIZERS LIMITED DESIGN PHILOSOPHY – EOT CRANE & HOIST	PC183/E/4022/SECVI-3.2.1	0	
		Document No.	Rev	
		Sheet 3 OF 12		

1.0 INTENT

1.1 Design, detailed engineering, manufacturing, shop testing & inspection, painting, supply, transportation to site, unloading and storage at site, load testing at site, final painting and Erection & commissioning, requisite statutory approval of Electric Over head Travelling Crane along with runway rails and supply of spare parts for crane as per the technical specifications, terms and conditions mentioned in this Technical Specification.

LSTK Contractor to provide EOT Cranes of adequate capacity in various Maintenance Bay, Transformer House and other location wherever required for ease in operation and maintenance activities . Cranes to be provided in nearest multiple of 5 Metric Tonnes considering maximum weight to be lifted. Relevant Indian/ ISO Standards to be applicable for EOT Crane . The main hook capacity of each crane shall be minimum 25% over and above the heaviest component/ equipment to be handled. 15 T and above EOT cranes shall have 5T auxiliary hoist. All statutory guidelines to be complied by the contractor/ sub-contractor.



2.0 SCOPE OF SUPPLY & ERECTION

2.1 The scope of supply & erection shall be, but not limited to, the following:

Sl. No.	Description	Qty & Scope (Location wise)
1.1	Design, Engineering, Manufacturing, Testing, Inspection, Supply, Erection & Commissioning of suitable capacity EOT Cranes including its drives and all other relevant electricals	Bidder to furnish
1.2	Runway Rails for crane along-with necessary fixtures for fixing the rails on structural steel girder, along-with electrical interconnection for the earthing of rails.	Bidder to furnish
1.3	Mechanical stoppers on both the ends of runway rails for LT motion and for CT motion.	Bidder to furnish
1.4	Festoon flexible cable type down-shop leads system along with necessary insulators, brackets, lighting etc.	Bidder to furnish
1.5	Access ladder, Platform and safety handrail for EOT cranes	Bidder to furnish

2.2 CODES AND STANDARDS

The Design, manufacture, performance and testing of the EOT crane as specified herein after shall comply with the requirements of the applicable latest standards and codes of practice. The latest standards with all amendments shall be followed in particulars.

	EMERGENCY DIESEL GENERATORS PACKAGE TALCHER FERTILIZERS LIMITED DESIGN PHILOSOPHY – EOT CRANE & HOIST	PC183/E/4022/SECVI-3.2.1	0	
		Document No.	Rev	
		Sheet 4 OF 12		

IS:3177 code of practice for overhead traveling Crane and Gantry crane other than steel work crane.

IS:2365 steel wire suspension ropes for lifts elevators and hoists.

IS:807 code of practice for design, manufacture, erection & testing of crane and hoists.

IS:3443 crane rail section.

IS:3815 point hook with shanks for general Engineering purpose.

IS:800 code of practice for use of structural steel in general building structure.

IS:2062 weldable structural steel.

IS:3681 spur and helical gears.

IS:3734 dimensions for worm gearing.

IS:1364 precision and semi-precision, hexagonal bolts, screws, nuts and locknuts.

IS:816 code of practice for use of metal arc welding for general construction in mild steels.

IS:1181 qualifying test for metal arc welders.

IS:1323 code of practice for oxy-acetylene welding for structural work.

IS:3961 recommended current rating of cables.

IS:282 hard drawn copper conductors for overhead power transmission.

IS:2147 degree of protection provided by enclosures for L.V. switchgear and control gear.



IS:2959 contactors for voltage not exceeding 1000V AC or 1200V DC.

IS:2208 HRC cartridge fuse links for voltage above 650V.

IS:4047 heavy duty air break switches not exceeding 1000V.

IS: 5749 forged rams horn hooks.

The material of various components shall be in accordance with relevant IS or equivalent international standard.

	EMERGENCY DIESEL GENERATORS PACKAGE TALCHER FERTILIZERS LIMITED DESIGN PHILOSOPHY – EOT CRANE & HOIST	PC183/E/4022/SECVI-3.2.1	0	
		Document No.	Rev	
		Sheet 5 OF 12		

3.0 GENERAL DESIGN REQUIREMENTS:

Whole supply & erection shall conform to the following standards and specifications except as modified herein:

The Vendor shall be responsible for complying with any other statutory requirements governing the work.

DESIGN OF MECHANISM

For the hoist mechanism of cranes electric motor shall be connected to the reducer through floating shaft and half geared couplings. Coupling of the output shaft of the reducer to single or double drum shall be by means of geared coupling.

BEARINGS

All running shafts and wheels running on fixed axle shall be fitted with sealed antifriction ball or roller bearings.

COUPLINGS

1. All couplings shall be gear couplings, except that rigid coupling may be used on long transmission shafts.
2. All couplings shall be of steel. Cast Iron shall not be used.

GEARINGS

All gear boxes shall be in totally enclosed construction and gears shall be spur or helical type with machine cut teeth suitably hardened and tempered and shall conform to AGMA standard. The surface hardness of pinion shall be between 255 to 300 BHN and for gear 217 to 255 BHN. Difference in hardness of pinion and gear must not be less than 20 BHN.

For Accurate fixing of unit mechanism (reducer, brakes, motor etc.) and as well as to exclude the possibility of misalignment while working, support surfaces shall be machined level.



TRACK WHEELS

In case where crane and trolley have more than four wheels, balancers shall be used.

The body of the balancer may be fabricated from steel plates or from cast steel.

BRAKES

Hoisting Motion: - The brake shall be automatic electro-mechanical or thrusters release brake applied directly to the hoist motor shaft.

	EMERGENCY DIESEL GENERATORS PACKAGE TALCHER FERTILIZERS LIMITED DESIGN PHILOSOPHY – EOT CRANE & HOIST	PC183/E/4022/SECVI-3.2.1	0	
		Document No.	Rev	
		Sheet 6 OF 12		

Traversing Motion: - The traversing motion (CT) of every electric overhead travelling crane shall be fitted with an automatic electro-mechanical brake irrespective of traversing speed.

Capacity of hoist brakes shall be determined as follows:

$M_t = K \cdot M_{ct}$ Kg-m where,

M_{ct} = Static Moment on the braking shaft, due to action of the load, considering the maximum efficiency of the mechanism.

K= Co-efficient of reserve of braking, taking from following figures, corresponding to the class of duty of the mechanism.

For light duty (Class I)	K = 1.5
Medium duty (Class II)	K = 1.75
Heavy duty (Class III)	K = 2.0

Manufacturer to consider Heavy duty co-efficient (K=2.0) of reserve of braking and shall be compliant to IS: 3177.

In case of hoist mechanism with two drives, each drive must have at least one brake. Co-efficient of reserve of braking of each brake is taken not less than 1.25, considering that the full load can be held by one brake.

In case where two brakes are used for each of the two drives co-efficient of reserve of braking must not be less than 1.1 for each brake.

Required capacity of braking in case of traverse and travel motions shall be 0.8 – 1.0 times the static moment on the respective braking shafts due to action of inertial forces, considering maximum efficiency of the mechanism.

Brake drums shall preferably be made of steel castings or steel forging.

HOOKS

Hooks shall conform to the relevant Standards.

The crane hooks shall be provided with spring loaded safety locking arrangement.



No repair work on hook made to shall be allowed without prior approval from purchaser.

MEANS OF ACCESS

Platforms: - An adequately guarded platform minimum 750 mm wide shall be provided on both sides for the full length of the bridge. All platforms and ladders shall have non-skid chequered plate treads and shall be provided with handrails and toe guards. Opening on guard railings for access from outside shall be provided with safety chains.

The access ladder to EOT assembly from G.L. shall be suitably located avoiding any hindrance to EOT travel

LUBRICATION

	EMERGENCY DIESEL GENERATORS PACKAGE TALCHER FERTILIZERS LIMITED DESIGN PHILOSOPHY – EOT CRANE & HOIST	PC183/E/4022/SECVI-3.2.1	0	
		Document No.	Rev	
		Sheet 7 OF 12		

All the grease points shall be brought to a safe and easily accessible place which shall be prominently displayed.

All gear boxes shall be fully enclosed type prohibiting ingestion of outside dust, oil and moisture. Gear shall be compliant to AGMA/ IS:4460. There will be no centralised lubrication system.

BUFFERS

Bridge of crane and trolley shall be provided with buffers for soft dashing with end Stop. Buffers ends should be made of rubber or iron & wood.

Welding: Welding shall be in accordance with relevant Standards.



ELECTRICAL DESIGN

All electrical including electro-magnetic brakes, limit switches, cables, wirings, lightings etc. shall be in accordance with the Electrical Specifications enclosed.

4.0 SPECIFIC DESIGN REQUIREMENTS:

The Cranes shall be suitable for the duty conditions as given in the specifications sheets.

- 4.01 Material of construction must be well proven for the required services.
- 4.02 Cranes shall be suitable for outdoor installation but placed under the roof.
- 4.03 All gear boxes shall be fully enclosed type.
- 4.04 The rail and roller support for the flexible cable shall be designed for maximum reliability and minimum maintenance requirements. The roller supports shall be interconnected by flexible steel wire in order to protect the flexible cables against mechanical stress. DSL trolleys shall be provided with four wheels. Rollers should not require greasing.
- 4.05 Mechanical safety lowering brake shall be supplied by the Vendor which shall be capable of holding the test load in addition to electro hydraulic thrusters brake for all the hoisting motions.
- 4.06 The Vendor shall provide non-sparking type aluminium guards for couplings.
- 4.07 The Vendor shall, if required, provide a clearance certificate from a Competent Authority regarding following the safety rules and regulations.
- 4.08 All the Bearings shall be antifriction type. Bush Bearings are not acceptable.
- 4.09 1 No. rotary type and 1 No. gravity type limit switches will be provided for each crane/ hoist.

	EMERGENCY DIESEL GENERATORS PACKAGE TALCHER FERTILIZERS LIMITED DESIGN PHILOSOPHY – EOT CRANE & HOIST	PC183/E/4022/SECVI-3.2.1	0	
		Document No.	Rev	
		Sheet 8 OF 12		

- 4.10 2 Nos. one way lever type limit switch will be provided for trolley and 1 No. anti-collision device and 1 No. one way type limit switch will be provided for LT.

Anti collision device will consist of 1 No. one way lever type limit switch and striker arm.

- 4.11 Micro speed arrangement on main hoist, CT *and* LT will be achieved through separate sq. cage motors, 1 No. thruster brake and planetary gear box arrangement.

4.12 Installation

The cranes shall be placed on rails at an suitable elevation of equipment/ train building and shall be operated from pendant push-button boxes.

The flexible supply cables shall allow operation of the cranes in the full length of the equipment/ train building.

5.0 BATTERY LIMITS

The following items are excluded from the supply from EOT Crane Manufacturer :

Building structure including beams supporting crane rails.
Gangways and ladders along building walls.
Earth connection to gantry rails.

- 5.1 It is the obligation of the vendor / OEM to ensure supply of complete package of EOT Crane.
- 5.2 However, all requisite regarding supply, erection, commissioning covering wide spectrum of project shall be LSTK Contractor's responsibility.

6.0 EXTENT OF SUPPLY & ERECTION

6.1 General



Supply includes Design, calculations and all materials and services needed for satisfactory and safe operation of the cranes including :

erection on site
pre-commissioning and start-up
load testing which will be performed after erection.

- 6.2 The supply shall include but not be limited to:-

6.2.1 Design, engineering and fabrication.

6.2.2 The electrical equipment including isolator, flexible feeder cables/internal connection

	EMERGENCY DIESEL GENERATORS PACKAGE TALCHER FERTILIZERS LIMITED DESIGN PHILOSOPHY – EOT CRANE & HOIST	PC183/E/4022/SECVI-3.2.1	0	
		Document No.	Rev	
		Sheet 9 OF 12		

and the control system as per electrical specifications.

- 6.2.3 The roller supports, fixing material and rails for flexible supply cables.
- 6.2.4 Crane rails including support plates, cleats, etc. and electrical inter-connections for earthing of rails.
- 6.2.5 Mechanical stops and buffers for LT & CT motions.
- 6.2.6 Gangways and steps on the cranes but not on the building.
- 6.2.7 Workshop tests according to Clause No. 7.0
- 6.2.8 Painting according to brief specification as described in Article 9.0
- 6.2.9 The documentation in accordance with NIT/ITB.
- 6.2.10 The spare parts for 2 years operation as per NIT/ITB.
- 6.2.11 Inspection programme as per Clause No. 7.0
- 6.2.12 The name plate in the English Language with indication of max. Permissible load.
- 6.2.13 Alignment of sole plates, erection and alignment of rails, and down shop leads including supporting arrangement for DSL, wherever required.

7.0 INSPECTION, TESTING & REPAIRS



- 7.1 Inspection & Testing programme shall be furnished by the Vendor after placement of order for OWNER'S approval.
- 7.2 Inspection and testing shall conform to relevant standards.

Parts found defective or not conforming to the Standards as to workmanship or materials shall be rejected and replaced by the Vendor free of cost.

Waiving of inspection or acceptance of material or equivalent by the purchaser shall not relieve the manufacturer from the responsibility of furnishing material or workmanship in accordance with the relevant Standards.

All welding shall be carried out by qualified welders. Manufacturer shall furnish evidence acceptable to Third party Inspector of qualification tests of welders as required by relevant Indian Standards. All welding shall be subject to inspection by TPI, who will have the option to call for radiography or other non-destructive examination of welds to check soundness.

The main bridge girder shall be completely radiographed and radiographs produced. However, butt welds of bridge girder will be 100% radiographically tested on tension zone and 25% at random on compression zone.

	EMERGENCY DIESEL GENERATORS PACKAGE TALCHER FERTILIZERS LIMITED DESIGN PHILOSOPHY – EOT CRANE & HOIST	PC183/E/4022/SECVI-3.2.1	0	
		Document No.	Rev	
		Sheet 10 OF 12		

7.3 TESTS AT MANUFACTURER'S WORKS

All electrical and mechanical equipment shall be tested in accordance with the appropriate Standards at either the crane maker's or the equipment manufacturer's works and test certifications shall be furnished.

The cranes shall be tested at manufacturer's works under no-load. Travelling gear may be run light to check shaft and gear alignments.

TESTS AT SITE

For testing of electrical installation, refer Electrical Specification.

Test for Operation:

After the supply has been connected, and before the complete crane installation is put into commercial service, tests shall be carried out to prove the following :

Satisfactory operation of all motors under no-load conditions.

The satisfactory operation of each controller, switches contractor, relay and other control devices and in particular the correct operation of all limit switches under the most unfavourable conditions:

The correctness of all circuits and interlocks and sequence of operation.

The satisfactory operation of all protective devices:

The satisfactory operation of each motion of the cranes.

The compliance of the crane with the specified performance requirements: and

Tolerance on specified speeds at full load shall be with $\pm 10\%$.



7.4 DEFLECTION TESTS:

The deflection test shall be carried out *at site* with the safe working load at rest and with the crab in a central position. The measurement shall not be taken on the first application of the load. The datum line for measuring the deflection shall be obtained by placing the crab on the extreme end of the crane span with smaller hook approach.

7.5 OVERLOAD TESTS:

After tests but before the crane is put into service, it shall, with overload relays approximately set, be tested to lift and sustain a minimum test load of as per codes & standards requirement.

During the overload test each motion in turn shall be manoeuvred in both directions and the crane shall sustain the load under full control. The specified speeds need not be attained but the crane shall show itself capable of dealing with the overload without difficulty.

	EMERGENCY DIESEL GENERATORS PACKAGE TALCHER FERTILIZERS LIMITED DESIGN PHILOSOPHY – EOT CRANE & HOIST	PC183/E/4022/SECVI-3.2.1	0	
		Document No.	Rev	
		Sheet 11 OF 12		

8.0 PREPARATION FOR SHIPMENT

- 8.1 Each transport unit shall be suitably prepared for shipment, properly braced and loose parts secured to prevent damage during shipment. All material shipped shall be properly marked with the item number for which it is intended by means of a metal tag.
- 8.2 The vendor shall give all information concerning the protection needed for preservation of the equipment.

9.0 PAINTING

Painting shall be as per manufacturer standard and appropriately chosen for owner's site condition.

10.0 SPARES

- 10.1 All erection, pre-commissioning & commissioning spares including spares consumed during testing / PGTR till handing over the plant to owner shall be supplied by LSTK Contractor free of cost. Any unused commissioning spares shall be owner's property.
- 10.2 Mandatory spares shall be supplied by the LSTK contractor as per NIT.
- 10.3 LSTK Contractor to also furnish separate recommended list of 2 years operation & maintenance spare part list along with budgetary offers, valid for 2 years from the date of submission of offer for owner's consideration .
Recommended spares and their quantities should take into account related factors of equipment reliability, effect of equipment downtime upon production or safety, cost of parts and availability of vendor's service facilities around the proposed location of equipment.
- 10.4 Detail List of special tools & tackles shall be furnished by the LSTK bidder along with the bid and shall be in scope of supply of the LSTK contractor.

11.0 DRAWINGS AND DOCUMENTS:



The drawings, documents and data to be supplied after placement of the order shall be as per NIT.

12.0 GUARANTEE:

The crane shall be guaranteed by the supplier to be of accepted design, free from inherent defects in either workmanship or materials and to safely handle its rated capacity load without any undue deflections on its structure or mechanism. Any part proving defective within the warranty period shall be replaced free of charge by the Vendor.

12.1 Performance Guarantee:

The cranes with its drives and other equipment shall be tested at site to verify the electric consumption, various speeds, deflection and other performance figures guaranteed by the Vendor.

	EMERGENCY DIESEL GENERATORS PACKAGE TALCHER FERTILIZERS LIMITED DESIGN PHILOSOPHY – EOT CRANE & HOIST	PC183/E/4022/SECVI-3.2.1	0	
		Document No.	Rev	
		Sheet 12 OF 12		

Noise levels at 1.0 M distance from package machine's surface shall not exceed 85 d B(A).

13.0 PRIORITY:

In case of any conflict between the data sheets & the technical documents referred / enclosed, the information given in data sheets shall govern.

14.0 SUB-VENDOR(S):

The Sub vendor / manufacturer/ Supplier must have supplied similar model, size for two similar installations & service which are working satisfactorily. Feed Back report for the same shall be furnished to Owner / PMC prior to placement of order.

 पी डी आई एल PDIL	PROJECTS & DEVELOPMENT INDIA LTD.	PC183/E/4022/SecVI-4.0	0	 Talcher Fertilizers
		DOCUMENT NO.	REV	
		SHEET 1 OF 42		



SECTION : VI – 4.0

PROJECT EXECUTION PLAN, PLANNING & SCHEDULE, INSPECTION

PLANT : EMERGENCY DIESEL GENERATORS PACKAGE



**PROJECT : INTEGRATED COAL BASED FERTILISER
COMPLEX, AT TALCHER, ANGUL DISTRICT,
ODISHA**

0	06.09.2023	06.09.2023	Issued for Tender	SP	KJ	RRK
REV	REV DATE	EFF DATE	PURPOSE	PREPD	REVWD	APPD



	EMERGENCY DIESEL GENERATORS PACKAGE TALCHER FERTILIZERS LIMITED PROJECT EXECUTION PLAN	PC183/E/4022/SecVI-4.0	0	
		DOCUMENT NO	REV	
		SHEET 2 OF 42		

CONTENTS

1.0. PROJECT EXECUTION PLAN, PLANNING & SCHEDULING, INSPECTION.....	4
1.1. General	4
1.2. Engineering	5
1.3. Procurement	5
1.4. Construction and Installation.....	5
1.5. Commissioning	6
1.6. Quality Assurance.....	6
1.7. Statutory Approvals/State Regulations	6
1.8. Project Management.....	7
1.9. Organization.....	7
1.10. Safety	7
1.11. Sequence for Decisions	8
1.12. Vendor List	8
1.13. Waste Disposal / Scrap etc.	8
1.14. Environmental Management System	8
2.0. PROJECT MANAGEMENT AND EXECUTION	8
2.1. Project Management.....	8
2.2. Detailed Engineering Services:.....	9
2.3. Procurement	11
2.4. Kick-Off Meeting	18
2.5. Early Planning Document / Look Ahead Schedule	19
2.6. Overall Project Schedule	19
2.7. Detailed Activity Network	20
2.8. Functional Schedules.....	20
2.9. Progress Measurement Methodology	20
2.10. Vendor Scheduling and Monitoring	21
2.11. Construction Network	21
2.12. Construction Worksheets	21
2.13. Construction Contractor Schedule	21
2.14. Computerisation	21
2.15. Project Review Meetings.....	22
2.16. Progress Reporting	23
2.17. Material Control	24

	EMERGENCY DIESEL GENERATORS PACKAGE TALCHER FERTILIZERS LIMITED PROJECT EXECUTION PLAN	PC183/E/4022/SecVI-4.0	0	
		DOCUMENT NO	REV	
		SHEET 3 OF 42		

2.18.	Project Time Control Methodology	25
3.0.	CONSTRUCTION, CONSTRUCTION SUPERVISION AND MANAGEMENT	28
3.1.	Construction	28
3.2.	Quality Assurance/Quality Control	32
3.3.	Construction Equipment.....	35
3.4.	Construction Manpower	36
4.0.	QA SYSTEM / INSPECTION REQUIREMENTS FOR BOUGHT OUT ITEMS & DURING CONSTRUCTION.....	37
4.1.	General	37
4.2.	Specification for Turn-Key Bidder's Quality Assurance System.....	37
4.3.	Inspection Coordination Methodology for Turnkey Package	40

	EMERGENCY DIESEL GENERATORS PACKAGE TALCHER FERTILIZERS LIMITED PROJECT EXECUTION PLAN	PC183/E/4022/SecVI-4.0	0	
		DOCUMENT NO	REV	
		SHEET 4 OF 42		

1.0. INTRODUCTION

The Joint Venture of four major Public Sector Units – **M/s Rashtriya Chemicals & Fertilizers Ltd. (RCF)**, **M/s GAIL (India) Ltd. (GAIL)**, **M/s Coal India Ltd. (CIL)** and **M/s Fertilizers Corporation of India Ltd. (FCIL)** has decided to build a world class Coal based fertilizer complex. The fertilizer complex will consist of Coal Gasification based Ammonia Synthesis Gas Plant and Urea Plant, and is to be built at Talcher, Angul District, Odisha (India).

To cater the requirement of electrical power for the entire fertiliser complex, TFL intends to set up “Electrical Distribution System” under one LSTK package.

Projects and Development India Limited (PDIL) has been retained as Consultant by TFL to provide services for the selection of LSTK CONTRACTOR.

LSTK CONTRACTOR is advised to visit and examine the site conditions and obtain for itself on its own responsibility all information that may be necessary for preparing the bid and entering into the Contract. Claims of any kind due to variation or ignorance of site conditions and environmental conditions will not be eligible in any circumstances.



1.1. General

This Lump-sum Turnkey package has been prepared as a Bidding Package to the extent enumerated in various sections and documents enclosed.

Detailed scopes of work and discipline-wise technical requirements are provided in respective sections of this Tender Document.

The Contractor will execute the project on Lump-sum Turnkey basis, in accordance with and supported by Process Engineering Procedures, Procurement Procedures, Construction Management Procedure, Project Controls and Computer System to be developed to affect the maximum efficiency of quality of the project. To achieve this goal and requirements of the Owner/PMC, Contractor will establish his project organization giving due consideration to the following aspects:

- Effective execution and timely completion of each phase of the project.
- Maintaining high quality in each phase of the project.
- Good relation and coordination between the Owner/PMC and the Contractor.
- Assignment of experienced resources and personnel for immediate and smooth launching of the project.

	EMERGENCY DIESEL GENERATORS PACKAGE TALCHER FERTILIZERS LIMITED PROJECT EXECUTION PLAN	PC183/E/4022/SecVI-4.0	0	
		DOCUMENT NO	REV	
		SHEET 5 OF 42		

1.2. Engineering

Contractor's scope of work includes detailed engineering, preparation of engineering drawings and datasheets, making use of standard specifications, standards, design guides and technical documents enclosed in this Tender Document. Technical requirements, technical documents, standard specifications, PMC standards and guides to be followed for different type of works shall be as provided in this Tender document.

Contractor to carry out the Detailed Engineering defined above. Commissioning of the project in totality is a part of Contractor's scope. Engineering required to be done by the Contractor may arise singularly or in combination due to Manufacturing, Fabrication, purchased items, Construction, Commissioning, Statutory requirements, Government regulations, Safety requirements, site conditions, resultant total procurement and Construction, Installation and Testing, Insulation, Painting and Commissioning, etc.

1.3. Procurement

Contractor's scope includes ordering, all import formalities, fabrication/purchase of equipment and materials, port clearance, packaging and transportation to site, stores management which includes preservation and storage of equipment and materials, uncovered storage. Items contemplated for fabrication at site to be submitted along with the bid although both these aspects would be covered under the Contractor's responsibility.

Vendor manuals relating to installation, operation and maintenance and test certificates should be necessarily sent along with equipment. Please also refer Final Documentation Submission requirement spelt out in this Tender Document, in this regard.



Before ordering, clearances for technical portion would be taken from Owner / PMC in respect of the Critical Equipments (Special Equipments) comprising of Mechanical Static and Rotary Equipments, Electrical and Instrumentation items. Any ordered items which do not confirm to the contractual requirement identified at any stage of the project shall be rejected. Replacement / modification and project delay arising out of this shall be to the Contractors account.

Whenever clearances are to be taken, it would be necessary to submit details of technically acceptable offer.

Procurement of spares shall be as per spare part philosophy detailed in the scope of supply. Commissioning spares are also in the Contractor's scope.

1.4. Construction and Installation

Contractor's scope covers detail engineering including barricading of the allocated area complying with statutory norms, construction, installation and commissioning of the unit as

	EMERGENCY DIESEL GENERATORS PACKAGE TALCHER FERTILIZERS LIMITED PROJECT EXECUTION PLAN	PC183/E/4022/SecVI-4.0	0	
		DOCUMENT NO	REV	
		SHEET 6 OF 42		

per P&IDs, datasheets, drawings, standards, specifications, codes, statutory and state regulation. Supply of construction materials, labour, labour supervision, tools, tackles, consumable materials and accessories not specifically mentioned herein but nevertheless necessary, as per the PMC for the construction, installation, testing and commissioning of the complete system including cranes or any other material handling equipment is also part of Contractors scope.

1.5. Commissioning

Contractor's scope covers supply of all initial fill such as lubricants, seal oils, chemicals, consumables, spares required for start-up, pre-commissioning and commissioning of the project. Contractor shall arrange necessary loading / unloading equipments for undertaking this activity. The scope also includes providing manpower (skilled as well as unskilled) and organisation for commissioning and is to be indicated along with the bid.



1.6. Quality Assurance

The desired quality is to be met for different activities at various stages of the project. The quality checks by Owner and PMC could be of audit type / involvement at all stages of project execution by the Contractor and details of the quality plans will be furnished along with the bid. Contractor is required to submit detailed Quality Control (QC) measures to be adopted by him for all stages/types of activities. A notice period of six weeks is to be given for imported items and one week for indigenous items for association with respect to witness QC steps by Owner / PMC. Detailed methodology is enclosed in Tender Document for compliance. Facilities at shops / site / Engineering office for carrying out quality checks by Owner/PMC shall be provided /organised by Contractor.

1.7. Statutory Approvals/State Regulations

Statutory regulations as required during pendency of the contract will be adhered to for engineering, preparation of drawings/documents, fabrication, manufacturing, purchased items, construction and commissioning. Documents as required will be generated and submitted for the approval of statutory authorities. Follow up and obtaining clearances shall be responsibility of the Contractor.

State regulations as and when applicable for different phases of the project shall be adhered to by the Contractor. Statutory approval from any authority as per statutory rules and regulations of Central/State Government shall be the Contractor's responsibility unless otherwise specified in bid documents. The application on behalf of Owner/PMC for submission to relevant authorities along with copies of required certificates complete in all respects shall be prepared and submitted by the Contractor well ahead of time so that the actual construction / commissioning of the work is not delayed for want of approval or inspection by concerned authorities. The inspection of the works by the authorities shall be arranged by the Contractor and necessary coordination and liaison work in this respect

	EMERGENCY DIESEL GENERATORS PACKAGE TALCHER FERTILIZERS LIMITED PROJECT EXECUTION PLAN	PC183/E/4022/SecVI-4.0	0	
		DOCUMENT NO	REV	
		SHEET 7 OF 42		

shall be the responsibility of the Contractor. Statutory fees paid, if any, for all inspections and approvals by such authorities shall be borne by Contractor.

Any changes/additions required to be made to meet the requirements of statutory authorities shall be carried out by the Contractor free of charge. The inspection and acceptance of the work by statutory authorities shall however, not absolve the Contractor from his responsibilities under this contract.

1.8. Project Management

The project management services will include Planning, Scheduling, Monitoring, Progress Reporting, Quality Assurance and Quality Control and Overall Project Management functions. Contractor shall nominate a Project Manager who will be responsible for the total scope of work under this contract and shall respond to Owner and PMC's Project Managers on all matters relating to this contract.

The Contractor is expected to execute the Work/Services under this contract on Task Force concept with a dedicated team of specialists who will be responsible and respond to the Project Manager.

The Task Force shall be so organized as to give effective management and control of various services to the Project Manager.



1.9. Organization

The organisation up to working level including period envisaged for different phases of the project engineering, ordering, follow up for manufacture of equipment, clearances, transportation, inspection of equipment and materials, warehousing, safety, construction, commissioning coordination with statutory authorities and government authorities and project management will be submitted along with the bid. Bio-data of key personnel will also be submitted with the offer.

1.10. Safety

All measures required for safe constructions are to be taken and the schemes are to be approved by Owner/PMC before commencement of works. Besides, all personnel employed on the job are to follow safety requirement of Owner/PMC and state regulations as applicable from time to time. A list of safety implements/equipment proposed to be used by the Contractor, are to be indicated along with the bid. At least one safety engineer in each shift, for the project, shall be provided by the Contractor.

Safety report generation for different situations as per rules and required by Owner/PMC are to be adhered to. Copy of safety practices to be followed during construction is enclosed in this Tender Document. Contractor shall comply with the provisions of this document. This document specifies broad guidelines on safe practices to be adhered to

	EMERGENCY DIESEL GENERATORS PACKAGE TALCHER FERTILIZERS LIMITED PROJECT EXECUTION PLAN	PC183/E/4022/SecVI-4.0	0	
		DOCUMENT NO	REV	
		SHEET 8 OF 42		

during construction activities. However, before commencing any job, specific hazards and its effects should be assessed and necessary corrective/preventive action should be taken by the Contractor. This document shall supplement the prevailing statutory requirements, which shall also be followed as applicable.

1.11. Sequence for Decisions

Along with bid submission, it is necessary for the Contractor to bring out variation, if any, in related data sheets, drawings, specifications, standards, codes, scope, any other contractual clauses and seek clarifications from PMC/Engineer-In-Charge. The decision of the PMC shall be final and binding on the bidder in such cases. For those such items, which arise during execution of the project, the stringent specification/standards will be applicable, and shall be binding on the Contractor. However, the decision of the PMC/Engineer-in-Charge shall be final and binding on the Contractor.

1.12. Vendor List

All items required for project are to be purchased through approved vendors of Owner/PMC, wherever such details are not available, vendor list to be proposed by Contractor and clearance to be obtained from Owner/PMC before initiating the ordering process.

1.13. Waste Disposal / Scrap etc.

All waste generated which could be surplus earth after use and or surplus construction materials will be disposed off from time to time as directed by Owner/PMC.



1.14. Environmental Management System

Bidders should comply with the latest relevant elements of the International Standard for environmental protection, as applicable to their scope of work.

2.0. PROJECT MANAGEMENT AND EXECUTION

2.1. Project Management

Plot plan, detailed technical requirements along with the detailed scope of work and overall proposed implementation schedule is issued by Owner / PMC. These will form the basis for formulation of the **Overall Project Master Schedule** of the plant by Contractor. The Contractor is required to organise his services in a systematic manner to ensure execution and completion of the unit as per the schedule. The bidder is required to submit along with his bid the methodology/procedure proposed by him for this unit together with the organisational set up proposed and bio-data of key personnel.

	EMERGENCY DIESEL GENERATORS PACKAGE TALCHER FERTILIZERS LIMITED PROJECT EXECUTION PLAN	PC183/E/4022/SecVI-4.0	0	
		DOCUMENT NO	REV	
		SHEET 9 OF 42		

In order to achieve uniformity in execution of various activities of the project, PMC has developed engineering design basis and project procedures/methodologies to be adopted by the executing agency. The Contractor is required to carry out detailed engineering, procurement, tendering, construction supervision and management, planning scheduling, monitoring, reviewing, reporting, and overall project management activities. All activities to be performed and services to be rendered by the Contractor under this contract shall be monitored by Owner / PMC and will be subject to periodic reviews by PMC. The Contractor shall facilitate such reviews/monitoring by Owner / PMC.

Immediately after the award of job, a Kick-Off Meeting will be held to finalise and establish the modalities and procedures to be adopted for execution of the contract based on the enquiry document, commitments made by Contractor and subsequent agreements reached between Owner/PMC and Contractor during negotiations. The Kick-Off Meeting will be attended by key members of Owner/PMC and Contractor. This will address all necessary details and arrangement between Owner/PMC and the Contractor.

The Contractor's service for Engineering, Procurement, Tendering, Construction, Supervision and Management, Planning, Scheduling, Monitoring, Reporting, and Overall Project Management shall meet the requirements given in this section.

English language and Metric Units shall be used in all documents, drawings, reports, correspondences etc. under this contract.



2.2. Detailed Engineering Services:

The Contractor shall provide the detailed engineering services for the project as mentioned in this bid document furnished by the Owner/PMC. The services shall cover the detailed engineering required for execution and completion of the project along with the utilities to be provided inside the battery limit of the Plant.

All critical drawings / documents to be prepared by Contractor/sub-contractors/vendors as per given in the bid document for review and approval by Owner / PMC. Obtaining all such approvals shall be the responsibility of the Contractor and the same is included in his scope of work. Such review and approval by Owner/PMC shall, however, not relieve the Contractor of his responsibilities.

For achieving the project schedule, it may be necessary in some cases to prepare the drawings in stages and release it for construction so as to take up simultaneous execution of detail engineering and construction. Any revision involved for the above is included in the scope of work of the Contractor. Also any change required to meet site conditions/statutory requirements shall have to be carried by Contractor at no extra cost.

The Contractor is required to organise a Task Force of dedicated specialists from each discipline under a Project Engineering Manager who will be assisted by engineering Coordinator. An engineering schedule will be prepared and submitted to Owner/PMC for

	EMERGENCY DIESEL GENERATORS PACKAGE TALCHER FERTILIZERS LIMITED PROJECT EXECUTION PLAN	PC183/E/4022/SecVI-4.0	0	
		DOCUMENT NO	REV	
		SHEET 10 OF 42		

approval. This approved schedule shall be used for all engineering activities. The engineering coordinator shall coordinate all design and engineering activities and interact with purchase, inspection, expediting, C&T, tendering, planning, construction and project groups. His responsibilities shall include.

(a) Engineering coordination for procurement involving:

- Preparation of Material Requisitions (MRs).
- Technical evaluation of offers received (which may involve technical discussions with vendors and concerned specialists may have to be deputed to vendors works or to Owner/PMC's offices as per requirements) and preparation of recommendations.
- Preparation of Technical Purchase Requisition (PRs) on selection of vendor.
- Review/approval of vendor drawings/documents. (This may call for arranging specialist visits to vendor's works for timely approvals of critical items.)



(b) Engineering coordination for sub-contractors involving:

- Preparation of schedule of quantities and specifications for various contracts.
- Technical evaluation and recommendation of offers received. This may involve arranging technical discussions with Tenderers at Owner/PMC's office if called for due to job requirements.
- Preparation of technical-agreed variations for incorporation in contracts for the selected Contractor.

In any case, Contractor has to take owner approval for sub-contractors list prior to scrutiny and award.

(c) Engineering coordination for construction involving:

- Timely issue of approved construction drawings including drawings duly approved by Owner/PMC as per requirements.
- Providing/arranging clarification on drawings and specifications wherever called for including specialists visits to site.
- Making regular periodic visits to project site for review of site requirements in respect of engineering activities.
- Attending/arranging for discussions with statutory authorities such as Chief Electrical Inspector, Chief Inspector of Boiler, Tariff Advisory Committee, etc. to arrive at

	EMERGENCY DIESEL GENERATORS PACKAGE TALCHER FERTILIZERS LIMITED PROJECT EXECUTION PLAN	PC183/E/4022/SecVI-4.0	0	
		DOCUMENT NO	REV	
		SHEET 11 OF 42		

design basis/documents acceptable to them wherever required for obtaining statutory approvals and any other local approvals.

(d) Monitoring progress of engineering activities and advising Project Manager on shortfalls and corrective actions needed. He will also attend the review meetings.

Detailed engineering and construction shall be based on sound engineering practices. List of applicable codes, standards and mandatory rules to be used in design is also mentioned in bid document.

Drawings/Documents/MRs etc., which are to be generated by Contractor shall be numbered as per the Documents Numbering Procedure of Owner/PMC.

Head Office engineering support of Contractor shall be provided to site during construction including deployment of engineering specialists for field engineering as and when required by Contractor.

2.3. Procurement



The procurement services to be provided by the Contractor shall cover the purchasing, inspection, expediting, custom clearance and transportation activities

(a) Purchase

The purchase activities will cover all equipments and materials required for completion of the project. The purchase group shall consist of adequate number of experienced and qualified Purchase Officers commensurate with the number of material requisitions to be handled and the time schedule for ordering. A procurement schedule will be prepared and submitted to Owner/PMC for approval. This approved schedule will be followed for all procurement activities.

Purchasing activities shall be coordinated by an experienced purchase coordinator who shall be responsible for:

- Coordinating with engineering group regarding preparation of material requisitions (MRs), evaluation and clarifications on offers of vendors, technical discussions, negotiations with vendors, technical recommendations preparation of purchase requisitions to form part of purchase requisitions selected vendors purchase order.
- Coordination for processing of change orders as required during execution of the project on account of additions/modifications as well as transit losses/damages.
- Before ordering, clearance for technical portion for rotating, instrumentation and electrical items as indicated in technical details would be taken from PMC.

	EMERGENCY DIESEL GENERATORS PACKAGE TALCHER FERTILIZERS LIMITED PROJECT EXECUTION PLAN	PC183/E/4022/SecVI-4.0	0	
		DOCUMENT NO	REV	
		SHEET 12 OF 42		

- Preparation and issue of status reports on purchasing activities.
- Attending review meetings with Owner/PMC on all purchase activities.

(b) Inspection and Expediting

The Contractor is required to organise a proper inspection and expediting system so as to ensure timely delivery of all the items/equipment meeting the specified quality criteria. This function has to be carried out by appropriate deployment of qualified personnel who have wide experience in their respective fields. Owner/PMC will reserve the right to inspect items deemed necessary by them without any additional cost to Contractor/sub-contractor/vendor /third party.



Expediting is one of the vital activity of successful and efficient procurement system which enables timely execution on the project. Such expediting has to be carried out by deployment of expediting coordinator located at Contractor's Head Office who would be assisted by expeditors located in various regional offices. To enable this function to be very effective and fruitful, following functions are to be carried out as a minimum.

Expediting Coordinator

Expediting Coordinator located at the Contractor's HO will liaison with various departments such as purchase, projects, engineering, transportation etc. on one hand and regional inspection/expediting offices and vendors on the other. The basic functions of such expediting coordinator would be:



- Maintain effective communication link between various departments of the Contractor including his regional offices and vendors on whom the orders are placed.
- Status maintenance of all the orders.
- Analyzing the order status in detail after identifying the critical order and initiation of suitable remedial measures.
- Acting as an effective instrument in final delivery of the item within CDD.
- Preparation of order close out reports of each order.
- Expediting coordinator shall be a person who is highly communicative and has sound technical knowledge; he must be highly analytical, alert, quick in gathering up-to-date information of the various orders.

Responsibility of Expediting Coordinator

	EMERGENCY DIESEL GENERATORS PACKAGE TALCHER FERTILIZERS LIMITED PROJECT EXECUTION PLAN	PC183/E/4022/SecVI-4.0	0	
		DOCUMENT NO	REV	
		SHEET 13 OF 42		

- Attending periodical review meetings with Contractor's project department and Owner/PMC.
- Distribution of Fax of Intent/Letter of Intent and status maintenance.
- Liaison with regional offices to obtain order to generate acknowledgement of Fax of Intent/Letter of Intent.
- Intimate Owner/PMC of reservations (if any) from the vendor in purchase order acceptance.
- Distribution of POs / PRs to vendors and regions.
- Expediting of vendor's drawings and other related documents.
- Expediting of approval of drawing by respective engineering department and timely return of the same to the vendor.
- Ensure receipt of periodical expediting reports and preparation of monthly status report against each order as per the requirement of Owner/PMC.
- Identification of critical orders/issues and initiate of remedial action.
- Expediting of decision on deviation sought by the vendor.
- Follow up actions with various concerned departments regarding all the issues discussed in the review meetings.
- Prompt despatch of material after inspection with the assistance of transportation department.
- Follow up of despatch particulars after despatch.
- Ensure preparation of order close out report for each order giving complete details of the order including ordered quality, contractual delivery date (CDD).
- Date of completion, delay, if any and reasons for delay, status of final documents etc.
- Ensure receipt/distribution of vendor documents including final documents as per PR.
- Preparation of final procurement closing report. The order close out reports shall be accompanied with two sets of complete documents in respect of each order bound/put together in a folder comprising of: purchase order, purchase requisition, change orders (if any), inspection certificates, material test certificates, final vendor drawings (if applicable), operation/maintenance manuals, any other document as specified in PR.

Expeditor

	EMERGENCY DIESEL GENERATORS PACKAGE TALCHER FERTILIZERS LIMITED PROJECT EXECUTION PLAN	PC183/E/4022/SecVI-4.0	0	
		DOCUMENT NO	REV	
		SHEET 14 OF 42		



Expeditor's responsibility commences from the time he receives the intimation of placement of TOI/LOI/order on vendor located in his region till the time he furnishes the despatch particulars of the item under a particular PO. During this process expeditor shall monitor and maintain all activities of the vendors such as:

- Vendor's understanding of the order.
- Submission of design drawing documents for approval.
- Sub-ordering, planning and scheduling.
- Manufacturing testing and despatch.
- Delays, power cuts, strike lock out etc.
- Submission of final documents as per PR.

Above functions may be possible only by frequent visits to vendor's office and shops including their sub-vendor's establishments as the case may be. Expeditor shall be able to visualise the problems in advance and suggest timely corrective measure. In nutshell, expeditor is not a mere progress reporter but a vital catalyst for successful completion of the job. Expeditor's responsibilities are as below:

- Ensure order acknowledgement from the vendor.
- Communicate the person concerned the reason for vendor's inability to accept the order (if so).
- Progress reporting of various orders located in the region.
- Communication with the vendors whenever he finds lack of efforts on their part.
- Raise alarm report at an appropriate time on possible serious delay or vendor's inability in meeting with scheduled date of delivery and also to suggest action plan.
- Liaise with inspection department for timely inspection, including third party inspection/statutory inspection as specified/required.
- Liaise with engineering department for approval of drawing, acceptance of deviation etc. through the expediting coordinator.
- Liaise with transportation department for sound and quick despatch of material.

(c) Inspection Quality Assurance System

	EMERGENCY DIESEL GENERATORS PACKAGE TALCHER FERTILIZERS LIMITED PROJECT EXECUTION PLAN	PC183/E/4022/SecVI-4.0	0	
		DOCUMENT NO	REV	
		SHEET 15 OF 42		

The objective of the quality assurance scheme of the Contractor shall be to ensure the conformity of equipment, material, site construction (if any) to various standards, specifications, drawings and technical requirements that are being mutually agreed between the Contractor and Owner/PMC. Quality Assurance System should clearly indicate the organisational approach for quality control and quality assurance of the various equipment/construction activities (if any) and also provide a verifiable evidence of the Contractor having carried out all the activities laid down in the bid document and the procedure. Such conformity to quality level shall be ensured by controlling the quality level of purchased items at vendor's/sub-vendor's shop/site and shall cover from source surveillance to final inspection. The Contractor to submit a detailed inspection and testing plan for various shop/site activities as a part of his Procurement Manual which shall be duly approved by Owner/PMC. The Procurement Manual shall as a minimum include:

In house Inspection Programs



- Inspection procedures consistent with mandatory codes.
- Procedures for material identification and transportation.
- Certification of non-destructive testing.

Inspection responsibility shall include but not be limited to the following:

- Single or multiple visits to the vendor's shop/site as per the requirement.
- Pre-inspection liaison meeting with the vendor for vendors correct understanding of the inspection requirements.
- Approval of quality assurance/quality control plan procedure clearly indicating stages of inspection with specific reference to witness and review.
- Ensure submission of quality control procedure and approval of the same for critical sub-orders.
- Inspection of various equipment/items as per relevant codes, specifications/drawings including witnessing of final acceptance test at vendors works/site.
- Maintenance of inspection reports periodically highlighting hold, deviation etc.

As indicated for expediting coordinator, Contractor should nominate an inspection coordinator with similar responsibility who will liaise various inspection offices/vendors for proper coordination.

Inspection through an Approved Third Party Inspection Agency

	EMERGENCY DIESEL GENERATORS PACKAGE TALCHER FERTILIZERS LIMITED PROJECT EXECUTION PLAN	PC183/E/4022/SecVI-4.0	0	
		DOCUMENT NO	REV	
		SHEET 16 OF 42		

Inspection requirements shall be fulfilled through Owner/PMC approved Third Party Inspection Agency. The payments to be made to the Third Party Inspection Agency shall be the responsibility of the Contractor. Further, the responsibility for inspection/testing as per specification approved documents and agreed Quality Assurance procedure and plans shall be that of the Contractor. Inspection activities of the Third Party Inspection Agency shall be coordinated by the Inspection Coordinator of Contractor.

(d) Customs Clearance and Transportation

The Contractor is required to organise a custom clearance and transportation (C&T) system to ensure prompt clearance of imported equipments from customs and transportation of equipments/materials to project site from ports/vendors works. This function shall be carried out by deployment of qualified and experienced personnel. C&T functions shall include, but not be limited to the following:

Appointment of Contractors



- Clearing forwarding of imported equipments/materials.
- Collection and transportation of bulk materials by road from vendor’s works.
- Transportation of consignments from port to site by road.
- Handling of consignments at project site.
- Transportation of general cargo and over dimensioned consignments by road/rail wherever applicable.
- Clearing and handling of air consignments, if applicable.
- Any other contracts relating to C&T services.

Supervision of Contractors

Supervision, monitoring and coordination of above contracts for import clearance and transportation as detailed below by Contractor. EC (Essentiality certificate) shall be provided by Owner to main Contractor of Indian origin. Essentiality certificate is not applicable to foreign Contractor.

Import Clearances

- Monitoring and coordination with clearing agents, customs, ports, steamer agents, airlines, railways and transport agencies for clearance of imported consignments.
- Registration of contracts with custom under project imports.

	EMERGENCY DIESEL GENERATORS PACKAGE TALCHER FERTILIZERS LIMITED PROJECT EXECUTION PLAN	PC183/E/4022/SecVI-4.0	0	
		DOCUMENT NO	REV	
		SHEET 17 OF 42		

- Control of payment of import duty to customs, payment of port dues, etc.
- Conducting surveys with various agencies for imported consignments landed in damaged condition and corrective action for timely replacement of items.

Despatch of Indigenous Project Goods

- Coordination with inspection/expediting group and all indigenous suppliers for expeditious despatch of consignments.
- Monitoring movement of consignments from vendors works to project sites.
- Collection, transportation and delivery of bulk-material to project site.

(e) Monitoring Movement of Consignments

Total monitoring of movement of all consignments dispatched to project site from various points of despatch. A chaser has to be deployed from Contractor, for transportation of all ODC Consignments as well as important consignments (imported and indigenous) as and when advised by Owner/PMC.

(f) Reporting



Preparing and issuing Weekly, Fortnightly and Monthly Status Reports on clearance of imported equipments/materials and movement of equipments/materials from various despatch points to project site.

Monthly Reports on Over/Short Rejected/Damaged (OSRD) items. It shall be Contractor's responsibility to arrange for timely replacement of OSRD items.

(g) Tendering

Tendering activities of the Contractor shall be properly organised to ensure award of various contracts in line with the project schedule. The tendering group shall consist of sufficient number of contract engineers/officers who are having adequate professional experience and qualifications.

Contractor shall prepare a Tender schedule for carrying out different works such as civil and structural equipment erection, piping, electrical, instrumentation, painting etc. All tendering activities shall be carried out in accordance with this approved tender schedule. The Contractor shall deploy a contract coordinator for coordination of tendering activities. The contract coordinator shall be responsible for:

	EMERGENCY DIESEL GENERATORS PACKAGE TALCHER FERTILIZERS LIMITED PROJECT EXECUTION PLAN	PC183/E/4022/SecVI-4.0	0	
		DOCUMENT NO	REV	
		SHEET 18 OF 42		

- Coordinating with the Resident Construction Manager during execution of the contracts regarding clarifications on contract terms and conditions as required.
- Preparation and issue of status reports on contracting activities.
- Attending review meeting with Owner/PMC on all contracting activities.
- Preparation of tender documents, issue of enquiry to approved Contractors through receipt of bids, techno-commercial evaluation of offers for award of contract will be carried out by Contractor.

All major tenders will be handled by the Contractor from his Head Office. However, tenders for certain minor construction will be handled by Contractor's site office.



The Contractor is required to institute and maintain a proper planning, scheduling and monitoring system and employ professionally qualified and experienced planning engineers for the project. The system shall have latest state of the art technique. To this effect, Contractor shall implement this system through the Prima Vera Project Planner. The system developed should be capable to support and enforce proper control mechanism in the project. It should be based on hierarchical breakdown of works with elaborate level of detailing and control. The levels of controls should be such that it supports and foster controls at activity level, function level and management level with greater emphasis on target, scope and commitment at various stages of contract for accountability and action planning, such multi-level/ multi-tier system of planning, scheduling and monitoring, supports, effective information generation, assimilation, summarisation and reporting in proper and adequate manner.

The system shall be predictive type and should constitute pre-warning mechanism to diagnose and anticipate the problem well in advance and provide preventive features/measures. It is required that work breakdown structure should consist of details of systems, work packages, functions, work items and activities from monitoring point of view at micro level and summarisation at higher levels. It is expected that the work breakdown structure coding system or methodology to be followed shall be informed/discussed with the successful bidder during the kick-off meeting.

2.4. Kick-Off Meeting

On award of job, the Contractor is required to submit the following documents which will be discussed during the kick-off meeting to establish planning requirements, inputs and outputs for overall schedule, monitoring and progress reporting.

- List of work package/areas.
- List of critical drawings.
- Breakdown of work packages to work items level.

	EMERGENCY DIESEL GENERATORS PACKAGE TALCHER FERTILIZERS LIMITED PROJECT EXECUTION PLAN	PC183/E/4022/SecVI-4.0	0	
		DOCUMENT NO	REV	
		SHEET 19 OF 42		

- Input requirements of each work item/activity.
- Schedule start and finish dates of all milestone/activities in line with overall schedule of the project.
- Procedure for Project Planning, Scheduling, Monitoring & Control System including all reporting formats.
- Progress Measurement Methodology and Unit, Function, Discipline and Deliverable wise weightages breakdown. Overall system-wise, discipline-wise weightages for each item/activity.
- Procedure/presentation on proposed Bulk material control system
- Three month Front-End Schedule within a week of award.

In this kick-off meeting, it will be endeavoured to reach complete understanding with Contractor on activities, inputs and logic to establish planning documents for monitoring. Venue of the kick-off meeting to be held between the successful Bidder, PMC and the Owner, shall be either at PMC Office or Owner Office.



2.5. Early Planning Document / Look Ahead Schedule

Immediately after the award of contract and pending finalisation of overall project schedule, detailed activity chart/network, functional schedules etc., the Contractor in consultation with PMC shall prepare a look ahead schedule as a guideline for the activities to be performed during the relevant periods.

2.6. Overall Project Schedule

The Contractor shall submit within 30 days of Fax of Intent / Award of Work, the Work Breakdown Structure (Plant wise / Facility wise) showing project work load, that is, preparation of tenders, material requisitions, construction drawings equipments etc. alongwith a sufficiently detailed overall project schedule in the activity network form, clearly indicating the major milestones, inter relationship/interdependencies between various activities such as process, engineering, procurement tendering, manufacture, delivery, construction etc. together with computer analysis of critical path and floats as well as quantum of work for major activities.

The time and the date of completion of the works as stipulated in the CONTRACTOR's proposal and accepted by the OWNER shall be deemed to be of utmost importance. The CONTRACTOR shall so organise his resources and perform his work as to complete it not later than the date agreed to.

	EMERGENCY DIESEL GENERATORS PACKAGE TALCHER FERTILIZERS LIMITED PROJECT EXECUTION PLAN	PC183/E/4022/SecVI-4.0	0	
		DOCUMENT NO	REV	
		SHEET 20 OF 42		

The CONTRACTOR shall submit The detailed Primavera Level 4 Project Master Schedule within thirty (30) days or as specified elsewhere after effective date of the CONTRACT.

The Primavera Level 4 Project Master Schedule shall be for OWNER / PMC review and be based on a Proposal Schedule as attachment to the CONTRACT. Such Proposal schedule shall show the execution periods for (i) Engineering, (ii) Procurement & Delivery of Equipment and Materials, (iii) Construction & Erection and (iv) Commissioning, Testing.

Bidding consortium shall be contractually obliged to issue a Primavera Level 4 Project Master Schedule, provided that such schedule shall not (i) accelerate the OWNER obligations (to be agreed upon prior to Contract award) (ii) change the agreed GUARANTEED COMPLETION DATE (date to be agreed upon prior to Contract award)

The above Primavera Level 4 Project Master Schedule shall be periodically updated, & reviewed and reports shall be submitted by the CONTRACTOR as directed by the OWNER / PMC.

The schedule will be reviewed and approved by Owner/PMC and the comments if any shall be incorporated in the network issued for implementation within two weeks from receipt of comments. The network thus finalised shall form part of the Contract and will become the basis for developing further detailed activity network. This schedule shall not be revised without the prior permission from the Owner/PMC during the entire period of contract. The changes made during revision of the contract shall be approved by Owner/PMC.

2.7. Detailed Activity Network



The Contractor should develop Detailed Activity Networks for various systems of the project, based on approved Overall Master Project Schedule. Such networks would be computerised for further monitoring and reporting.

2.8. Functional Schedules

The Contractor should prepare resource-based detailed functional schedules in line with detailed activity networks for functional monitoring, scheduling and control. This should clearly reflect strategies and philosophy of execution. Owner/PMC reserves the right to check the functional schedule and status of activities at anytime and at any location of performance/execution. Further, the functional schedules shall be submitted by the Contractor on demand by the Owner/PMC.

2.9. Progress Measurement Methodology

The Contractor is required to submit during the Kick-Off Meeting, the detail Methodology of Progress Measurement of Engineering, Procurement, Manufacturing, Delivery,

	EMERGENCY DIESEL GENERATORS PACKAGE TALCHER FERTILIZERS LIMITED PROJECT EXECUTION PLAN	PC183/E/4022/SecVI-4.0	0	
		DOCUMENT NO	REV	
		SHEET 21 OF 42		

Computation of total Service/Physical Progress at the unit-wise level and on the overall basis. The progress basis shall be physical realisation of work such as in terms of deliverables and construction quantity/volume accomplished. The amalgamation of such output across the project to compute overall progress shall be suitably established with proper rational and norms and maintained throughout the project. Owner/PMC reserves the right to modify the methodology in part or in full.

2.10. Vendor Scheduling and Monitoring

The Contractor shall establish schedules for Pre-Ordering and Post Ordering for follow up. The vendor monitoring preferably should be on logical networks and commitments at least on critical items in order to monitor them on regular basis for effective control. Owner/PMC may demand such follow up procedure and logical networks for various Critical Equipment at any time during the course of order execution. The manufacturing schedule shall be established and agreed with the vendors and acceptance shall be brought to the notice of Owner/PMC in time.

2.11. Construction Network

The Contractor shall prepare and submit a Detailed Construction Network with full consideration of logistics, construction studies and method for Owner/PMC approval. The Contractor shall describe the resources required and special construction equipments, Tools and tackles to be mobilized. The network shall be developed subsequent of substantial progress of engineering and ordering with fairly known construction workload and quantities.

2.12. Construction Worksheets



The Contractor shall further detail out the construction network into area-wise details in terms of work, quantity and schedule, to firm up basis for area control. The construction schedule should be worked out based on work front generation criteria which will call for availability of input like drawings, materials and access for each/group of activity to be performed. It may be in the form of resource loaded bar chart with 'S' curve. Owner/PMC reserves the right to access the same.

2.13. Construction Contractor Schedule

The Contractor shall agree upon the construction schedules with sub-contractors for proper mobilisation, monitoring and control. Owner/PMC reserves the right to ask for such programme and status of any time as may be required.

2.14. Computerisation

Contractor should follow proper computerised control for the following project modules:

	EMERGENCY DIESEL GENERATORS PACKAGE TALCHER FERTILIZERS LIMITED PROJECT EXECUTION PLAN	PC183/E/4022/SecVI-4.0	0	
		DOCUMENT NO	REV	
		SHEET 22 OF 42		

- Activity network
- Engineering (Residual)
- Purchasing, delivery and expediting
- Tendering
- Construction planning and control
- Materials control at head office.
- Material allocation and control at field office
- Proper warehousing control
- Project documents and construction drawings

The above distinct but integrated components of project should be monitored as deliverable and quantum level. To perform such elaborate level of input-output control at each deliverable, the packages used should forecast resources based on recovery plan in dynamic manner for adequate control.

As indicated earlier, Project Schedules as above shall be developed/evolved using the Latest Version of the Primavera (P6) Project Planner Software Package.

2.15. Project Review Meetings



Contractor shall present programme and status at various review meetings as required.

Monthly Review Meeting

Level of participation	:	Project and planning of PMC, OWNER and Contractor
Agenda	:	Monthly Programme v/s Progress Status/Statistics Major hold ups/Slippage Completion outlook Assistance required Areas of concern and critical issue Recovery Action Plan
Venue	:	Owner / PMC Office or As Mutually Agreed Venue

Weekly Review Meeting

Level of participation	:	Contractor / PMC's site in-charge / Project Manager and Job Engineers
------------------------	---	---

	EMERGENCY DIESEL GENERATORS PACKAGE TALCHER FERTILIZERS LIMITED PROJECT EXECUTION PLAN	PC183/E/4022/SecVI-4.0	0	
		DOCUMENT NO	REV	
		SHEET 23 OF 42		

- Agenda : Weekly programme v/s actual achieved in week
Programme for next week
Purchase requisition status report
Recovery actions and hold up analysis,
Safety related incidents and action taken for the same
Man-Power status
- Venue : Site office or As Mutually Agreed Venue



2.16. Progress Reporting

The Contractor shall submit the following Progress Reports on a regular basis for Owner / PMC review.

Monthly Progress Report

This report shall be submitted on a monthly basis within seven calendar days from cut-off date, or as agreed upon, covering overall scenario of the project. The report shall include, but not limited, to the following:

- Executive summary or summary of major events/activities.
- Schedule v/s actual percentage progress and progress curves for engineering, ordering, manufacturing, delivery, contracting, construction, commissioning, overall.
- Areas of concern/problem/hold-ups, impact; recovery action plans/catch-up plans.
- Activities executed achievements during months and targets for the following month.
- Analysis of critical activities and impact on overall completion.
- Chronological achievements of key events indicating schedules and actual date.
- Annexure giving status summary for drawings material requisitions, equipment and materials delivery, contracting and construction.
- Resource requirement deployment status.
- Statutory requirements / compliance status
- Change order status.
- Invoice status.
- Construction photographs.
- Updated Project Schedule

	EMERGENCY DIESEL GENERATORS PACKAGE TALCHER FERTILIZERS LIMITED PROJECT EXECUTION PLAN	PC183/E/4022/SecVI-4.0	0	
		DOCUMENT NO	REV	
		SHEET 24 OF 42		

Weekly Reports

This report will be prepared for Head Office and construction site in summarized fashion and submitted on every Tuesday taking status as of Sunday by the Contractor on weekly basis and will cover following items:

- Activities completed (engineering, procurement, contracting, construction. etc.)
- Programme for subsequent week.
- Resource deployed – man and machine.
- Quantities and productivity achieved in key areas of work.
- Progress on procurement activities including material requisition status reports.
- Constraints, if any.



The report/information may be transmitted preferably through fax to Owner / PMC HO.

Daily Reports

- Important activities for the day at site.
- Engineering Deliverables Status
- Material/equipments receipts for the day.
- Labour deployment report.

2.17. Material Control

It is essential that the Contractor follow an integrated material control system for the project. In the system, material identification in the drawing office, procurement and allocation, are all channelized and controlled in an orderly manner. The Contractor should follow a system for material identification like system-wise or area-wise/zone-wise, and should give construction orientation to material control. The Contractor, right from the beginning, at the drawing office stage will start identifying materials system-wise or area-wise. The system will be based upon backing of material from the material take off stage through material requisitioning, placement of purchase order, manufacturing at vendor's shop upto receipt at site for making the material available for performing planned and sequential construction work.

	EMERGENCY DIESEL GENERATORS PACKAGE TALCHER FERTILIZERS LIMITED PROJECT EXECUTION PLAN	PC183/E/4022/SecVI-4.0	0	
		DOCUMENT NO	REV	
		SHEET 25 OF 42		

At the construction site, the Contractor will develop and implement a system of inspection, receipt and effective utilisation of materials received by re-examining the work front availability and priority between and amongst various systems and areas.

In the case of multiple agencies carrying out construction at site, the Contractor must adopt methodology of allocation and de-allocation and timely issue of the materials thereby preventing possible idle storage of items at the Contractor's level. Contractor must follow proper warehousing procedure at project store to maintain various planned and unplanned issues and dynamic stock status records. Through periodic reviews, the Contractor will have a system of generating hold up reports well in advance to identify exception on material availability and to track such material by the expeditery through a systematic follow up procedure from the vendors.

Owner/PMC may introduce checkpoints at procurement, allocation and construction stages to know the development, status and behaviour of the system and the Contractor shall submit the following reports on monthly basis: bulk material status report, and material hold up/shortage report.



2.18. Project Time Control Methodology

2.18.1. The time for completion of the complete scope of work shall be strictly as per the time schedule given in the tender document.

2.18.2. The CONTRACTOR shall furnish the following documents along with the bid:

- (a) An overall schedule in the form of network, clearly indicating all important milestones in design, engineering, fabrication, procurement construction, testing, commissioning, etc. for the plant commensurate with the overall time schedule.
- (b) Resource deployment schedule indicating mobilisation of all critical resources including manpower and machinery for the smooth execution of the job at engineering offices, fabrication shops and construction site. The resource schedule shall also contain various construction aids envisaged to be deployed for execution.
- (c) Organisation structure for effective project management and control, clearly indicating the responsibility centre as well as bio-data of the key personnel, who are permanent employees of the Contractor.

2.18.3. Within 30 days of issue of fax/letter of intent, the Contractor shall finalise the following as detailed earlier:

	EMERGENCY DIESEL GENERATORS PACKAGE TALCHER FERTILIZERS LIMITED PROJECT EXECUTION PLAN	PC183/E/4022/SecVI-4.0	0	
		DOCUMENT NO	REV	
		SHEET 26 OF 42		

(a) Overall Project Schedule

Overall project schedule in line with the agreed milestone and detailed to adequate work breakdown structure level covering all phases of the work such as detailed engineering, procurement, manufacturing, shipment, tendering and field erection. This schedule shall also include the interface activities to be provided by the Owner/Engineer-in-Charge and the dates by which such facilities are needed. Contractor shall get the schedule reviewed by Owner/Engineer-in-Charge and the agreed schedule shall form part of the Contract monitoring document based on which performance would be reported and evaluated. This document shall be signed by both the parties. The Owner/Engineer-in-Charge shall also review the weightage allotted to various activities and method of reporting to be adopted by the Contractor. During the progress of the contract if in the opinion of Owner/Engineer-in-Charge, desired progress as physically/sequentially is not maintained, it would be obligatory on the Contractor to re-programme the work schedule in order to accommodate the backlog and/or provide work front to other agency, without any obligation to the Owner/PMC.

(b) Functional Schedules

- **Engineering Schedule**

This shall indicate list of drawings, specification and sketches to be prepared discipline wise for each plant and scheduled date of issue of each document.

- **Ordering, Manufacturing & Delivery Schedule**



This will be in the form of bar chart and shall indicate item-wise all the major activities regarding ordering, shop fabrication/manufacturing and delivery of materials.

- **Construction Schedule**

This will be in the form of a detailed bar chart showing all the construction activities (civil structural, piping, equipment erection, electrical, instrumentation, insulation, painting, etc.) at site with their durations and workload and highlighting the inputs namely drawings, materials availability, etc., compatible with the related functional schedule. The Contractor shall provide on request key construction net work of any work module for critical review and control.

- **Resource Deployment Schedule**

A detailed deployment schedule indicating manpower, machinery, construction, equipment in line with the overall project schedule

	EMERGENCY DIESEL GENERATORS PACKAGE TALCHER FERTILIZERS LIMITED PROJECT EXECUTION PLAN	PC183/E/4022/SecVI-4.0	0	
		DOCUMENT NO	REV	
		SHEET 27 OF 42		

- **Pre-commissioning and Commissioning Schedule**

Contractor shall develop this schedule in the form of a bar chart and submit the same to OWNER / PMC for review.

- **Any other document required for monitoring.**



2.18.4. In line with the construction schedule, the Contractor shall submit a monthly programme for site activities and the target set in shall be strictly adhered to. In all matters concerning the extent of targets set out in the monthly programme and the degree of achievement, the decision of PMC shall be final and binding. The monthly programme shall be further broken into weekly programmes. At the end of each week, a report shall be submitted by the Contractor indicating the achievement during the week against the targets, reason for shortfall if any and the construction programme for the following week. Contractor shall also attend weekly/monthly review meeting conducted by PMC or by his representative to review project status.

2.18.5. The Contractor shall regularly submit a detailed progress report in respect of:

- Release of drawings
- Sub-ordering of materials
- Manufacturing
- Delivery of equipment/material status report
- Construction
- Other features like mobilisation, safety etc.
- Report indicating the critical activities governing the timely completion of the project and actions to overcome the same to be submitted every month.

This report will be issued every month on an agreed cut off date and shall include the following brief description of the progress achieved during the month. Reason for short fall if any and action plan to make up short-fall.

- Scheduled and actual percentage progress discipline-wise/system-wise as well as overall physical progress.
- Job completion trend in the form of updated overall schedule.
- Progress photograph highlighting major achievement.



	EMERGENCY DIESEL GENERATORS PACKAGE TALCHER FERTILIZERS LIMITED PROJECT EXECUTION PLAN	PC183/E/4022/SecVI-4.0	0	
		DOCUMENT NO	REV	
		SHEET 28 OF 42		

- 2.18.6. The Contractor at any point of time of operating would be permitted to revise the accepted schedule/control documents with the Owner/Engineer-in-Charge without changing the contractual completion date.
- 2.18.7. The review of the performance of work would be made at different levels of management and Contractor is expected to ensure proper participation for effective reviewing and action plan.
- 2.18.8. The Contractor should ensure availability of professionally qualified planning engineer both at HO and site deemed adequate by the Owner/Engineer-in-Charge.
- 2.18.9. The Contractor at his own cost should maintain a control room at site highlighting all the features, schedule and achievements of the project.
- 2.18.10. Weighted percentage of each discipline/group of work shall be mutually agreed to between the Contractor and Owner/ Engineer-in-Charge after the award of contract to facilitate compilation of progress.

3.0. CONSTRUCTION, CONSTRUCTION SUPERVISION AND MANAGEMENT

3.1. Construction

- 3.1.1. The Contractor will carry out the construction works in accordance with all relevant codes, standards, specifications, his documents and drawings, and based on the most efficient use of local resources. The Contractor will act as principal employer on the labour employed for construction activities and will follow Indian Labour Act, and all statutory regulations in this regard. The Contractor will have total responsibilities for the following:
- Construction, erection and installation of all equipment, machinery, piping and materials supplied by the Contractor.
 - Site supervision, planning and coordination at site.
- 3.1.2. Major categories of construction work performed by the Contractor will comprise of but not limited to the following:
- Civil work: Aboveground structure work; refractory, brick and castable work.
 - Civil foundation work shall be done by the bidder.
 - Machinery: Installation of machinery and equipment; assembling of large size equipment, if any

	EMERGENCY DIESEL GENERATORS PACKAGE TALCHER FERTILIZERS LIMITED PROJECT EXECUTION PLAN	PC183/E/4022/SecVI-4.0	0	
		DOCUMENT NO	REV	
		SHEET 29 OF 42		

- Piping Work: Prefabrication of piping, installation of piping; welding work of piping; non-destructive test for welded parts.
- Electrical Work: Installation of transformer, cubicles and electrical equipment; power cable and control cable wiring; installation of lighting fixtures and lighting wiring; installation of communication system and wiring; installation and wiring work for fire-alarm system; grounding work for equipment and structures.
- Instrument Work: Installation of local panel, all field devices like transmitters, control valves and other instruments/equipments; installation of cable duct and cable laying etc.; cable wiring work; air piping and tubing work; instrument pressure-piping work.
- Painting/Insulation Work: Painting of equipment, piping, impulse piping and steel structures; insulation of equipment and piping
- Safety work during construction period.
- Test and inspection work.



3.1.3. The Contractor is required to organise and mobilise construction management services in a systematic and sequential manner to ensure that the plant installation is carried out in accordance with the approved engineering drawings, specifications, standards, QA/QC procedures etc. and its mechanical completion is achieved within targeted time schedule. For this purpose, the Contractor shall deploy a construction management team headed by a Resident Construction Manager (RCM) at site.

The construction management team shall include engineers/specialists in QA/QC, project control (planning, scheduling, monitoring), contracts, construction supervision, progress measurement/billing, safety, warehousing, purchasing etc.

Construction supervision, coordination and management activities shall be carried out by Contractor in accordance with the approved construction procedures by PMC. Contractor will prepare construction schedules based on the overall project schedule of the plant and submit to Owner/PMC for approval. Monitoring and control of the construction activities will be carried out as per the approved construction schedule and procedure.

A construction management team headed by a Resident Construction Manager will be deployed at site by Contractor. The Contractor shall ensure delegation of adequate and sufficient power to his RCM for effective and smooth functioning of the field management. HO support shall be provided to the RCM at site during construction as and when required on all matters of project execution including the following:

- Field engineering

	EMERGENCY DIESEL GENERATORS PACKAGE TALCHER FERTILIZERS LIMITED PROJECT EXECUTION PLAN	PC183/E/4022/SecVI-4.0	0	
		DOCUMENT NO	REV	
		SHEET 30 OF 42		

- Vendor specialists required during construction
- Rectification/replacement of defective supplies, if any, noticed during construction
- Inspection/expediting of replacement orders/field purchase order for ordered items placed by field purchase
- Expediting replacement of imported items found short/damaged.

3.1.4. The Contractor shall establish and maintain a material testing laboratory for carrying on field tests during execution of contracts under different disciplines by Sub-contractors, at no extra cost to owner. Also, all material handling equipment shall be subjected by the Contractor to required load test initially and then periodically to ensure safe/stable operation including witnessing and maintaining records of such tests.

3.1.5. The construction organisation will include the following for effective execution, monitoring and control: planning, scheduling, monitoring reporting, construction supervision, quality assurance and quality control, warehouse management and material control, field engineering/purchase, safety personnel administration.



(a) Quality Assurance and Quality Control (QA/QC):

QA/QC personnel will be responsible for ensuring quality of construction carried out by different Sub-contractors in accordance with the approved QA/QC procedures and management of material testing laboratory.

(b) Warehouse Management and Material Control:

This discipline will be responsible for carrying out the warehouse management and material control in accordance with the warehousing procedure and material control procedure. The material control plan and warehousing procedure shall be Contractor for Owner/ PMC's review/approval. The activities of the contractor will include:

- Transport Liaison, filing of insurance claims and follow up.
- Receipt, handling, identification, inspection, and acceptance of materials including free issue materials to be supplied by owner.
- Documentation for control and accounting of materials.
- Materials control and issue
- Inventory checks
- Field requisition and purchase
- Spare and tools

	EMERGENCY DIESEL GENERATORS PACKAGE TALCHER FERTILIZERS LIMITED PROJECT EXECUTION PLAN	PC183/E/4022/SecVI-4.0	0	
		DOCUMENT NO	REV	
		SHEET 31 OF 42		

- Material appropriation and handing over
- Security
- Taking with suppliers on short supplied items and placing replacement orders for lost/damaged items.
- Intimating HO regarding short, lost, damaged items and taking up with suppliers and taking replacement action when applicable.
- Perform material reconciliation and identification of surplus material and its handing over to the Owner after certification by the PMC.
- Contractor will generate and issue following reports: fortnightly statement of consignments in transit; daily report of material received; report on over, short, reject, and damage receipts against each consignment on receipt at warehouse; weekly status of consignments, material receipt report; monthly status of field purchase; monthly status of excess, shortage rejected and damage settlement.



(c) Field Engineering:

This discipline will be responsible for controlling and issue of technical drawings and documents, preparation of field sketches, field modifications, checking/preparation of as-built drawings, technical assistance for field purchase and field tendering etc. Specialist engineers from Vendor HO will also be deployed at site as per requirements.

- Field tendering will be responsible for carrying out field tendering activities if required.
- Field purchase contractor will be responsible for carrying out field purchase activities if required. The bulk of procurement action will be done from HO. Field purchase items are restricted to those required for running and maintenance of the field offices, items required for field, items required to expedite construction work and items found short, missing or damaged against the main order when received at the site.

(d) Safety:

It is the responsibility of the Contractor to ensure that safe construction procedures are complied with. They will also ensure that adequate first aid medical facilities are available for emergency purpose and that safety procedures as per the approved safety procedure are followed by the different Contractors. To assist in the development of an effective safety programme, a safety checklist for various jobs shall be developed and the same shall be reviewed by the Contractors Site Incharge.

	EMERGENCY DIESEL GENERATORS PACKAGE TALCHER FERTILIZERS LIMITED PROJECT EXECUTION PLAN	PC183/E/4022/SecVI-4.0	0	
		DOCUMENT NO	REV	
		SHEET 32 OF 42		

The responsibilities will include the following: coordination and supervision of the details of the job safety programme; initiation and supervision of the use of accident report and investigation form; preparation of periodic accident summaries; tallying safety inspection of the job site and submission of summary inspection report to site PMC in charge.



3.2. Quality Assurance/Quality Control

All work/services to be performed by the Contractor under this contract shall be of specified/approved quality and Contractor shall have a quality assurance/quality control (QA/QC) system during the performance of various activities such as engineering, procurement, tendering, construction etc. Review/approval of activities by Owner/PMC shall not however dilute the responsibility of Contractor for maintaining quality.

(a) QA/QC Procedure:

Contractor shall submit the QA/QC procedure to be adopted for engineering procurement and construction activities of plant for review and approval to Owner/PMC. The QA/QC procedure shall cover all activities to be performed by Contractor. Some important activities and procedures to be evolved are listed below:

- **General:**
Document control, coordination, non-conformance report of Sub-contractors, output identification and traceability, QA system review
- **Procurement/Inspection:**
Incoming material control, welding qualification and repair, manufacturing or fabrication process control, applicable non-destructive examination, coating/lining, preservation, post-weld heat treatment wherever applicable, packaging and despatch control, transportation, inspection/test plans for all specific and mandatory tests (as per drawings and codes) with clear indication of witness, verification and hold points.
- **Construction:**
Pre-construction activities, job construction, welding qualification and repair, inspection/test plans for all specified tests (as per drawing and codes) with clear indication of witness, verification and hold points. Contractor shall prepare construction QA plans for review of the Owner/PMC and the same shall cover as minimum the areas as under, and shall confirm their compliance to approved codes/standards/specifications, etc.
- **Site Preparation:**
Tie-ins, structures, incorporation of all witness tests/hold points of construction work, clean-up testing, instrumentation installation and construction.



	EMERGENCY DIESEL GENERATORS PACKAGE TALCHER FERTILIZERS LIMITED PROJECT EXECUTION PLAN	PC183/E/4022/SecVI-4.0	0	
		DOCUMENT NO	REV	
		SHEET 33 OF 42		

(b) As a part of Construction and Quality Assurance, the Contractor shall also comply with the following activities:



- Stage-wise inspection of quality of work as per approved QA plan and contract specifications.
- Develop welding procedures and welders qualification procedures for their work.
- Ensure compliance of various statutory rules, regulations and safety measures and to arrange and co-ordinate site inspection, testing etc. as required under local statutory rules and regulations prevalent in India.
- Take all necessary precautions to protect construction work and material from damage by climate, outside elements and construction activities.
- Ensure that materials used are in accordance with drawings/project specification.
- Review safety procedures prepared by the Contractor for compliance with applicable codes, regulations and Owner requirements.
- Prepare schemes for heavy/critical equipment's erection/lifts/rigging before and submit the same for PMC review/approval.
- Ensure alignment (hot/cold) of all critical rotary equipment/machinery and their upkeep/maintenance as per suppliers' recommendations.
- Perform housekeeping activities, which include maintaining sanitary facilities, sweeping clean up, removal of excess materials/temporary facilities, scaffolding, as necessary.
- Conduct periodic quality/technical audits for ensuring quality and conformance with the contract.
- To take immediate appropriate corrective actions as and when such discrepancy arises to fulfil quality, safety obligations.

(c) QA/QC procedure shall also include quality plans, mostly in tabular formats defining the specific quality practices and flow of every identifiable activity of a discipline. All disciplines concerned with the performance of work are to be covered. These quality plans should indicate the following:

- For Design and Engineering: Activity description; preparation, checking, review and approval requirements; code of conformance (applicable standard specification number); applicable procedure number; QA data/records produced.

	EMERGENCY DIESEL GENERATORS PACKAGE TALCHER FERTILIZERS LIMITED PROJECT EXECUTION PLAN	PC183/E/4022/SecVI-4.0	0	
		DOCUMENT NO	REV	
		SHEET 34 OF 42		

- For Procurement and Construction: Activity description; procedure number, inspection and test plan number, conformance code, testing and inspection code
- (d) QA/QC procedure and quality plans will be discussed during kick-off meeting. Hold, witness and verification points and Owner/PMC review/audit requirements will be finalised between Contractor and Owner/PMC.
- (e) During the performance of the contract, the Contractor shall:
- Implement approved quality assurance programme including but not limited to:
 - (i) Performance of internal quality audits, preparation of audit reports and submission for review of PMC. Contractor shall evolve a comprehensive system of planned and documented audit to verify whether various performed activities comply with detailed procedures, specifications, guidelines etc. and to determine the effectiveness of quality system. Scope of such internal audits shall be furnished to PMC for review. Verification documents shall be generated during audit and submitted periodically to PMC for review. Throughout all stages of the scope of contract, the Contractors procedures, documents, activities, products and services and those of his Sub-contractor's shall be subject to Owner/PMC review/approval. Such surveillance and audit are optional and shall not relieve the Contractor of his contractual obligations and liabilities.
 - (ii) Generation of QA records (mostly inspection and test plans) as per quality plan and submission for review by Owner/PMC. The Contractor shall submit all quality records (generated during activity execution) and audit results on well laid formats/performance for Owner/PMC review. The rights of such review are reserved by Owner/PMC. Owner/PMC may review it in full, parts or selectively. However, complete correctness of the QA records shall be the sole responsibility of the Contractor irrespective of its review by Owner/PMC.
 - Facilitate Owner/PMC in the quality audit at works.
 - Certify QA Programme documents of Contractors and submit to Owner/PMC for review.
 - Carry out audits/inspection at Contractors works as per approved QA programme and submit the reports for review by Owner/PMC
 - Get similar QA system implemented at his Sub-contractor's works/office. QA records from the Contractor shall be reviewed and certified for compliance by the Contractor before submitting to Owner/PMC for information.

	EMERGENCY DIESEL GENERATORS PACKAGE TALCHER FERTILIZERS LIMITED PROJECT EXECUTION PLAN	PC183/E/4022/SecVI-4.0	0	
		DOCUMENT NO	REV	
		SHEET 35 OF 42		



- Carry out audits at Contractors' office/works and submit the report to Owner/PMC for information.
- Ensure that all personnel shall be assigned tasks commensurate with their qualification. Specialized workmen shall be qualified and certified.
- Handle non-conformance brought out by internal and external sources as follows:
 - (i) Non-conformance brought out by Contractor's own review/audit shall be resolved by Contractor himself. One level higher than those responsible to carry-out the activity shall resolve the non-conformance. Such resolution shall be in full knowledge of Departmental Manager. Corrective action shall be initiated at the earliest. Report of such resolution shall be submitted to Owner/PMC for information.
 - (ii) Non-conformance brought out by Owner/PMC through any of the following shall be resolved by the Contractor. Such corrective actions shall be submitted to Owner/PMC for review. However, corrective action shall be initiated at the earliest for : technical reviews, QA review and surveillance, inspection, external audit (Owner / PMC)

3.3. Construction Equipment

The Contractor is required to organize and mobilize the construction equipment and other tools tackles in a sequential manner to ensure that plant installation is carried out in a mechanized manner and its mechanical completion is achieved within targeted time schedule. The Contractor shall without prejudice to his responsibility to execute and complete the work strictly as per the specifications and other laid down procedures by mechanizing the construction activities to the maximum extent by deploying all necessary construction equipment/machinery of adequate capacities and numbers. For this purpose, the Contractor shall deploy a rigging team headed by a rigging foreman reporting to Area Engineer responsible for equipment erection.

Area Engineer should be well conversant with various erection techniques and shall be responsible for preparing erection schemes in accordance with the approved procedures and based on crane manuals suiting to plan layout. Area Engineer will have to foresee various other constructive activities in the surroundings while planning erection schedules including safety aspects of man and machinery also.

Contractor will prepare erection schedule based on the overall project schedule of the plant in phased manner with erection schemes of various equipments, vessels and submit to Owner/PMC for approval, monitoring and control of erection schedule. Erection activities will be carried out as per the approved construction procedures.

	EMERGENCY DIESEL GENERATORS PACKAGE TALCHER FERTILIZERS LIMITED PROJECT EXECUTION PLAN	PC183/E/4022/SecVI-4.0	0	
		DOCUMENT NO	REV	
		SHEET 36 OF 42		

For efficient working and maintenance of construction aids, Contractor shall establish and maintain crane yard/workshop equipped with regular maintenance facility for various construction aids for carrying out routine field maintenance during performance for the contract. Temporary approach road, wherever required for the movement of the crane and other vehicles for equipment erection and transportation of material shall be properly planned and be made by the Contractor for quick mobilisation of the transportation system. The proper padding for the crane movement shall be done to avoid any delays of erection schedule. Weekly/fortnightly maintenances shall be planned in such a way that it should not hamper the erection schedule.

Contractor shall ensure the timely augmentation of the plant, equipment and machinery depend upon the exigencies of the requirement to meet the overall project schedule. During performances of the work, Contractor must ensure that structures, materials or equipments are adequately braced by guys, struts or otherwise approved means which shall be supplied and installed by the Contractor as required till the erection works is satisfactorily completed. Such guys, shoring, bracing, strutting, planking supports etc. shall not interfere with the work of other agencies and shall not damage or cause distortion to other works executed by him or other agencies. Contractor to submit the construction equipment schedule along with the bid.



3.4. Construction Manpower

The Contractor is required to organise and mobilise construction staff in a sequential manner to ensure that plant installation is carried out in accordance with the S curve defined with other chapter of the Bid package. Mobilisation of construction staff should be such that 'S' curve based on the time schedule and progress achieved in the phased manner should match with the overall project time schedule. For this purpose, the Contractor shall clearly indicate in his construction methodology that work shall be done departmentally or by engaging such Sub-contractor or the combination of both.

Contractor will prepare detailed methodology for the work to be carried out departmental as well as by Sub-contractor clearly defining the scope and responsibility of main Contractor and Sub-contractor.

In case, Contractor proposes to engage Sub-contractor for the erection of various activities, he must enter into an agreement of Memorandum of Understanding and same shall be furnished along with their credential with the bid. Sub-contractor's credential will be evaluated along with the offer. Contractor shall not be permitted to change the Sub-contractor after the award of work under any circumstances. Non-compliances of the above will be strictly dealt with relevant provisions of the contract.

During the execution of works at site, if the principal Contractor engages Sub-contractors for execution of works at site as per approval obtained from Owner/PMC in line with contract provisions and in the event Sub-contractor complains in writing to the Owner with regard to the non-payment of their dues from the principal contractor for the works

	EMERGENCY DIESEL GENERATORS PACKAGE TALCHER FERTILIZERS LIMITED PROJECT EXECUTION PLAN	PC183/E/4022/SecVI-4.0	0	
		DOCUMENT NO	REV	
		SHEET 37 OF 42		

executed by them and site (excluding final payments and payments due after termination of Sub-contractors' services by the main contractor), Owner reserves their right to make such payment to the Sub-contractors based on approved measurement with due notice to the principal Contractor. Owner shall release such payments to Sub-contractor at the cost and risk of the main Contractor in order to ensure smart execution of work at site.

The above such payment made by Owner to the Sub-contractor shall be adjusted in the running account bills or any other payment due to the concerned principal contractor. Contractor to submit the construction manpower schedule.

All Sub-contractors will be managed by the main Contractor construction staff who will perform the duties of construction management and will administer, coordinate, and inspect the work of the Sub-contractor and be responsible for the quality.

The contractor will establish the prerequisite for successful construction of sub-contractor work. However, by deploying the Sub-contractors as approved by Owner/PMC for any discipline, does not absolve the principal Contractor for his total responsibility under the subject contract

The Contractor to ensure that in case of Sub-contract failure to execute the works as per standards/specifications/drawings and negligence and disobedience in carrying out any order or instruction of Owner / PMC will be viewed very seriously and dealt with appropriately in accordance with provisions of the contract. Contractor to submit the construction manpower schedule along with the bid

4.0. QA SYSTEM / INSPECTION REQUIREMENTS FOR BOUGHT OUT ITEMS & DURING CONSTRUCTION



4.1. General

Contractors are required to follow a well-documented quality assurance and quality control system covering all phases of project viz. engineering, procurement, installation, testing and commissioning. Similarly, Contractors are required to develop their own resources for inspection of all bought-out items supported by third party inspection services for specific cases. Supervision of construction activities is the responsibility of turnkey contractor; Owner/PMC role during construction phase is for quality surveillance.

4.2. Specification for Turn-Key Bidder's Quality Assurance System

(a) Introduction

This specification establishes the quality assurance requirements to be met by the turnkey bidder during execution of contracted services. in case of any conflict between the requirements of this specification and other documents such as technical specifications,

	EMERGENCY DIESEL GENERATORS PACKAGE TALCHER FERTILIZERS LIMITED PROJECT EXECUTION PLAN	PC183/E/4022/SecVI-4.0	0	
		DOCUMENT NO	REV	
		SHEET 38 OF 42		

contract conditions etc., the contractor shall notify Owner/PMC of all such conflicts for final resolution.

(b) Scope of Work by Contractor

Prior to the award of contract, the following documents shall be submitted along with the bid for evaluation:



- Quality policy
- Quality objective
- Company quality manual
- Project quality plans
- Copy of certificate of approval of quality management system

After the award of contract, within four weeks after the award of the contract, the Contractor shall participate in the pre-start meeting with Owner/PMC to finalize 'Project Quality Plans' as regards to the following:

- Standard practices specified by the Contractor
- Hold, witness and verification point
- Owner/PMC's review/audit requirements

During job execution, implement approved project quality plan including but not limited to:

- Performance of internal quality audits, preparation of audit reports and submission for Owner/PMC's review.
- Generation of QA records as per quality plan and submission for Owner/PMC's review.
 - Records of management review of quality system
 - Contract review records
 - Design review, verification and validator's records
 - Assessment records of acceptable vendors/sub-vendors
 - Records of nonconformity
 - Records of external quality audit
 - Records of training
 - Inspection reports
 - Test data/inspection and test plans
 - Qualification reports
 - Material review reports



	EMERGENCY DIESEL GENERATORS PACKAGE TALCHER FERTILIZERS LIMITED PROJECT EXECUTION PLAN	PC183/E/4022/SecVI-4.0	0	
		DOCUMENT NO	REV	
		SHEET 39 OF 42		

- Calibration data
- Quality cost report
- Schedule control and progress reports

- Facilitate Owner/PMC in the quality audit at his works.
- Certify QA Programme documents of sub-contractor and submission for review to Owner/PMC.
- Carry out audits/inspection at sub-contractor's works as per approved QA programme and submit the reports for Owner/PMC's review.

(c) Quality Assurance System Requirement



- Requirements stipulated in this specification shall be fulfilled by the Contractor/Sub-contractor. All other features of QA System shall be as per Contractor's standards.
- The Contractor shall ensure that the quality system is clearly understood and faithfully implemented at all levels in his organisation.
- The Contractor shall develop quality consciousness' among all personnel working for the contract.
- Non-conformances brought out by Contractors/Sub-contractors' own internal review/audit shall be resolved by Contractors'/Sub-contractors, themselves. One level higher than those responsible to carry out the activity shall resolve the non-conformances. Such resolution shall be in full knowledge of Departmental Manager. Corrective action shall be initiated at the earliest. Report of such resolution shall be submitted to Owner/PMC for information.
- Non-conformances brought out by Owner/PMC through any of the following: technical reviews, QA reviews and surveillance, inspection, external audit (Owner/PMC), post construction quality audit (by Owner/PMC) to be carried out immediately after declaration of mechanical completion by the Contractor. Non-conformances brought out due to the above, shall be resolved by the Contractor/Sub-contractor. Such corrective actions shall be submitted to Owner/PMC for review. However, corrective action shall be initiated at the earliest.
- The Contractor shall evolve a comprehensive system of planned and documented audit to verify whether various performed activities comply with detailed procedures, specifications, guidelines etc. and to determine the effectiveness of quality system. Scope of such internal audits shall be furnished to Owner/PMC for review. Verifiable documents shall be generated during audit and submitted periodically to Owner/PMC for review. Audits shall be carried out by independent engineers not responsible for execution of the activity to be audited.

	EMERGENCY DIESEL GENERATORS PACKAGE TALCHER FERTILIZERS LIMITED PROJECT EXECUTION PLAN	PC183/E/4022/SecVI-4.0	0	
		DOCUMENT NO	REV	
		SHEET 40 OF 42		

- Throughout all stages of the scope of contract, the Contractor's procedures, documents, activities, products and services and those of his Sub-contractors' shall be subjected to quality surveillance and audit by Owner/PMC. Such surveillance and audit are optional and shall not relieve the Contractor of his contractual obligations and liabilities.
- The Contractor shall submit all quality records (generated during activity execution) and audit results on well laid formats/proforma for Owner/PMC's review. The rights of such review are reserved by Owner/PMC. Owner/PMC may review it in full, parts or selectively. However, completes correctness of the QA records shall be the sole responsibility of the Contractor irrespective of its review by Owner/PMC.
- The Contractor shall get similar QA system implemented at his Subcontractors' works/office. QA records from the Subcontractor shall be reviewed and certified for compliance by the Contractor before submitting to Owner/PMC for information.
- Contractor shall carry out audits at Subcontractors, office/works and shall submit the report to Owner/PMC for information.
- All personnel shall be assigned tasks commensurate with their qualification. Specialized operators shall be qualified and certified. The Contractor shall have a system for identifying personnel training needs in line with the latest ISO guidelines.
- Immediately after submitting written declaration of mechanical completion by the Contractor, Owner/PMC will carry out post-construction quality audit. Contractor shall extend all help and cooperation to carry out this audit including providing all necessary resources to Owner/PMC and shall implement all corrective measures, based on the post-construction quality audit findings and observations at no cost to the Owner/PMC.
- A pre-startup safety review (PSSR) checklist is a tool used by a PSSR team during a safety review of a new facility before commissioning. This checklist helps ensure that a facility will be safe for employees and that equipment will operate according to design specifications. This may be added here to ensure safety aspect before pre-commissioning. All the points in the PSSR has to be complied by LSTK contractor before start up of the unit.



4.3. Inspection Coordination Methodology for Turnkey Package

- 4.3.1. All equipment and materials are to be procured from vendors listed in the approved Vendor List enclosed in this Bid, or from other reputed vendors after obtaining specific approval of the Owner/PMC. In this regard, no difference is made between the equipment and materials purchased by the contractor directly or by his contracted agencies.
- 4.3.2. After finalisation of purchase order, a detailed QA/QC plan shall be developed by the vendor, duly reviewed by the Contractor and shall be submitted for approval of the

	EMERGENCY DIESEL GENERATORS PACKAGE TALCHER FERTILIZERS LIMITED PROJECT EXECUTION PLAN	PC183/E/4022/SecVI-4.0	0	
		DOCUMENT NO	REV	
		SHEET 41 OF 42		

Owner/PMC. It is envisaged that QA/QC plans for the critical Items shall be reviewed/approved by the Owner/PMC and for the balance items QA/QC plans shall be submitted for records. The management of quality control system is to be developed generally based on the categorisation of various equipment and materials. Preliminary categorisation of various items involved is enclosed. For items not included here, categorisation shall be decided during detailed engineering and Owner/PMC may change inspection category based on final information and quantities. For indigenous items, Contractor shall employ an approved third party inspection agency to carry out inspection on his behalf, whose involvement must be brought out in the detailed QA/QC plans. For imported items, contractor should engage Owner/PMC approved Third Party Inspector (TPI). Each stage of inspection by the TPI, must define whether it is a hold point, witness point, verification point or internal inspection point by the vendor. Contractor shall make independent QA Plans through the approved Third Party Agency which shall be having a confirmation of meeting the minimum inspection requirements spelt out. All inspection stages where Owner/PMC desires to participate (which shall be preferably only for critical items) shall be marked on the QA/QC plan and these stages must necessarily be attended by the Contractor in addition to the other stages being attended by him. In case the QA/QC plans are not submitted in sufficient detail, the Contractor may be asked to re-submit the plans.

- 4.3.3. The personnel to be deployed by the third party inspection agency must have adequate qualification and experience for the type of work involved and the owner may ask for approval of the personnel employed for the job and his replacement, if required.
- 4.3.4. The Contractor shall submit a detailed vendor's inspection schedule for the coming two months at the beginning of each month as well as notify owner's involvement at the appropriate inspection stage, giving a clear notice period of 15 days. The contractor shall submit monthly inspection and expediting reports of the inspection agency regularly to the Owner/PMC.
- 4.3.5. PMC's inspector shall witness the test on a mutually agreed date according to contractor's inspection notification, wherever applicable.
- 4.3.6. Submission of category-wise inspection plan by Contractor at PMC HO for review. It is envisaged that the QA/QC plans shall be submitted to the PMC in accordance with the clauses as defined above.
- 4.3.7. After finalisation of the vendor, the copy of PO or technical specification for sub-ordered items along with QAP will be submitted by Contractor to PMC covering the location where the sub-ordered items are manufactured. The QAP is to be duly approved by the PMC.
- 4.3.8. Contractor will be totally responsible for furnishing the complete and correct technical document/specifications to his sub-vendor. It is responsibility of the contractor to ensure that relevant specifications indicated in the tender documents are incorporated in the sub-

	EMERGENCY DIESEL GENERATORS PACKAGE TALCHER FERTILIZERS LIMITED PROJECT EXECUTION PLAN	PC183/E/4022/SecVI-4.0	0	
		DOCUMENT NO	REV	
		SHEET 42 OF 42		

order/sub-order specification. Each PO shall categorically indicate involvement of various agencies for inspection.

- 4.3.9. Contractor shall forward the approved copy of relevant drawings/documents to the TPI before giving inspection call. The final inspection will be done by the TPI, based upon drawings/documents reviewed by TPI/PMC in Code 'AP' (Approved) wherever applicable.
- 4.3.10. Contractor will ensure presence of their inspection engineer at sub-vendor's works during inspection by TPI or Owner/PMC inspection engineer (wherever applicable).
- 4.3.11. Contractor shall expedite to ensure delivery of all the materials as per CDD.
- 4.3.12. All correspondence by contractor to the PMC for submission of documents and inspection calls shall also be intimated to Owner.

ॐ

 PROJECTS & DEVELOPMENT INDIA LTD.	PC183/E/4022/SecVI-5.0	0	
	Document No.	Rev	
	Sheet 1 of 117		



SECTION – VI – 5.0

CONSTRUCTION/ERECTION, PRE-COMMISSIONING, COMMISSIONING AND START-UP

PLANT : EMERGENCY DIESEL GENERATORS PACKAGE

**PROJECT : INTEGRATED COAL BASED FERTILISER
COMPLEX, AT TALCHER, ANGUL DISTRICT,
ODISHA**

0	06.09.2023	Issued for Tender	JKY	JKY	RRK
REV	REV ATE	PURPOSE	PREPD	REVWD	APPD



	EMERGENCY DIESEL GENERATORS PACKAGE TALCHER FERTILIZERS LIMITED CONSTRUCTION/ERECTION, PRE-COMMISSIONING, COMMISSIONING AND START-UP	PC183/E/4022/SecVI-5.0	0	
		Document No.	Rev	
		Sheet 2 of 117		

CONTENTS

Sl. No.	DESCRIPTION	REMARKS
1	General Scope of Works and Services-Construction / Erection	
2	General Scope of Works and Services -Pre-commissioning	
3	Basic Plan for Temporary Services	
4	Mechanical completion	
5	Commissioning	
6	Start up	

LIST OF ANNEXURES



ANNEXURE NO.	DESCRIPTION	REMARKS
ANNEXURE-7-1	LSTK Contractor's Work Definition	
ANNEXURE-7-2	Detail Technical Scope	
ANNEXURE-7-3	Quality Control Procedures and Inspection Requirement	
ANNEXURE-7-4	Schedule Progress Evaluation and Progress Reporting	
ANNEXURE-7-5	Execution Plan	
ANNEXURE-7-6	Minimum Qualification & Exp. Of Key Supervisory Construction Personnel	
ANNEXURE-7-7	Deployment Schedule of Supervisory Personnel	
ANNEXURE-7-8	Deployment Schedule of Construction Equipment	
ANNEXURE-7-9	Details Of Equipment Proposed to be used for Tended Work	

	EMERGENCY DIESEL GENERATORS PACKAGE TALCHER FERTILIZERS LIMITED	PC183/E/4022/SecVI-5.0	0	
	CONSTRUCTION/ERECTION, PRE-COMMISSIONING, COMMISSIONING AND START-UP	Document No.	Rev	
		Sheet 3 of 117		

1 General scope of Work and services - Construction/Erection

LSTK CONTRACTOR shall be responsible for construction and erection of the Plant/ Unit including but not limited to the following:



- 1.1 Construction and erection of Plant/Unit and perform all other activities required to be performed for implementation of the WORK.
- 1.2 Provide and supply in due course all construction Equipment and Materials, tools, and temporary facilities necessary for implementation of the WORK.
- 1.3 Establish and operate adequate material control system in site for receipt, unloading, inspection, maintenance, handling, storage and utilization to ensure all Equipment and Materials are preserved and available as necessary for completion of the Plant/Unit.
- 1.4 Provide and supply all staff, tradesmen and labours for implementation of the WORK.
- 1.5 Establishment of overall construction policy and procedures for the Plant/Unit.
- 1.6 Provision of overall management and control of construction phase of the Plant/Unit.
- 1.7 Ensuring that all parts of the Plant/Unit are constructed and tested strictly in accordance with the specifications and applicable codes and standards set forth in the contract.
- 1.8 Ensuring that construction is accomplished in accordance with the schedules.
- 1.9 Provide transportation of all Equipment and Materials to be provided and supplied by LSTK CONTRACTOR under the CONTRACT either from inside or outside to Site.
- 1.10 Construct, operate and maintain all temporary facilities required for its personnel involved in the WORK.
- 1.11 Provide transportation in the area of the Site and between Site and temporary facilities for all its personnel involved in the implementation of the WORK, including field labour, administrative staff, etc.
- 1.12 LSTK CONTRACTOR manages and supervises its Sub Contractors and field labour for the WORK.
- 1.13 Provide liaison with OWNER/PMC, Sub Contractors, Licensors and Vendors to ensure that the Plant/Unit is constructed in accordance with the respective standard and specifications, set forth in the CONTRACT.

	EMERGENCY DIESEL GENERATORS PACKAGE TALCHER FERTILIZERS LIMITED	PC183/E/4022/SecVI-5.0	0	
	CONSTRUCTION/ERECTION, PRE-COMMISSIONING, COMMISSIONING AND START-UP	Document No.	Rev	
		Sheet 4 of 117		

- 1.14 Establish with OWNER adequate procedures, control and reporting systems to provide close control of the progress of the WORK.
- 1.15 Provision of labour and facilities for loading, unloading and transportation of the Equipment within the site area.
- 1.16 Performance and/or provision of all other works and/or services required for performance of the WORK.
- 1.17 Deleted
- 1.18 Prefabrication of piping spools in a shop on the Site.
- 1.19 Erection and installation of EQUIPMENT and auxiliary facilities associated with the Plant/Unit.
- 1.20 Deleted
- 1.21 Installation of pipe work including field fabrication at site.
- 1.22 Installation and testing of all instrumentation network and equipment of the Plant/Unit.
- 1.23 Installation and testing of electrical system and equipment of the Plant/Unit.
- 1.24 Deleted
- 1.25 Painting of piping, supports & Equipment of the Plant/Unit.
- 1.26 Maintenance of construction equipment, vehicles and tackles of the Plant/Unit, during construction and erection period.
- 1.27 Pre-commissioning, Commissioning and Start-up of the Plant/Unit.
- 1.28 Carrying out Mechanical Completion.
- 1.29 Perform all material identification as per application codes and standards.
- 1.30 Provide winterization during construction.
- 1.31 Provide drawings and documents as required.
- 1.32 Supply to OWNER complete test records within three (3) days after completion of actual testing.
- 1.33 Installation and testing of all underground piping, if any.

2.0 General scope of WORK and Services- Pre-commissioning

LSTK CONTRACTOR shall be responsible for the pre-commissioning phase of the Plant.

	EMERGENCY DIESEL GENERATORS PACKAGE TALCHER FERTILIZERS LIMITED	PC183/E/4022/SecVI-5.0	0	
	CONSTRUCTION/ERECTION, PRE-COMMISSIONING, COMMISSIONING AND START-UP	Document No.	Rev	
		Sheet 5 of 117		



LSTK CONTRACTOR shall provide at SITE an adequate number of qualified pre-commissioning engineers to direct and control pre-commissioning activities.

LSTK CONTRACTOR shall also ensure that all special tools and test equipment required for pre-commissioning are to be arranged at its own cost.

LSTK CONTRACTOR shall provide adequate construction labour, construction tools and equipment for pre-commissioning.

Pre-commissioning which shall be performed by LSTK CONTRACTOR shall include, but not limited to the following:

- 2.1 Cleaning, flushing, draining blowing out, steaming out, drying and purging of Equipment and their linings and piping systems, including the installation and removal of temporary blinds, strainers, screens etc., and the replacement of all permanent items removed while the WORK is in progress.
- 2.2 Chemical cleaning wherever required, including but not limited to compressor suction piping and lube and seal oil piping, heaters, supply of chemical and disposal of wastes.
- 2.3. Chemical cleaning of feed water systems, and steam systems. Supply of chemical and disposal of wastes.
- 2.4 Chemical cleaning of any other parts, which have corroded to an extent, which, will detrimentally affect Plant/Unit performance or run length for such reasons as increased fouling due to rust. Supply of chemical and disposal of wastes.
- 2.5 Checking, Testing, calibration simulation test and adjustment of instruments, equipment and systems including control valves and safety devices, installation and checking of orifices plates and other sensor devices in so far as this can be done before actual operation of the item concerns of complete system and loops.
- 2.6 Function test and checking out of electrical systems including substations, transformers, cables and switchgear, checking of all interlocks and setting of all relays. This shall include drying out operations, filtering of oil if required.
- 2.7 For motor driven equipment, amperage checking of motors and removal of temporary safety screens.
- 2.8 Cleaning of screens and filters replacement and adjustment of packing and seals and tightening of flanges.
- 2.9 Introduction of fuels.

	EMERGENCY DIESEL GENERATORS PACKAGE TALCHER FERTILIZERS LIMITED CONSTRUCTION/ERECTION, PRE-COMMISSIONING, COMMISSIONING AND START-UP	PC183/E/4022/SecVI-5.0	0	
		Document No.	Rev	
		Sheet 6 of 117		



- 2.10 Introduction of lubricants and oil flushing for machinery.
- 2.11 Introduction of chemical into and initial operation of treatment plant.
- 2.12 Boiling out, bringing up to pressure and performing all required code tests on steam generation facilities and associated instrumentation.
- 2.13 Drying out of stacks and all refractory lined equipment.
- 2.14 For all piping systems, installation and removal of temporary blinds as required, circulation and commissioning of systems including process systems, services, effluent and drainage, utilities distribution, relief and blow down and interconnecting lines.
- 2.15 Test running of all other rotating equipment for 24 hours wherever possible.
- 2.16 Adjustment of all piping expansion and support devices.
- 2.17 Air-drying of Plant/Unit, which is required to be water-free.
- 2.18 Testing (including running, tightness and vacuum) of systems, as necessary to ensure that the sections and components of Plant/Unit are ready for operation.
- 2.19 All such further works which LSTK CONTRACTOR judges to be necessary or in the reasonable opinion of OWNER is necessary to bring the Plant/Unit to a state of readiness for the introduction of feedstock into Process Plant/Unit for processing requirements and for safe commencement of operation.

3.0 Basic Plan for Temporary Services

Temporary Construction Facilities

The LSTK CONTRACTOR shall arrange following facilities at his own cost for Construction/Erection purpose. Demolition and cleaning of temporary facilities developed for construction purpose shall also be under LSTK Contractor's scope.

1. Construction Power & Water shall be as per commercial part of NIT.
2. Construction sheds
3. Construction offices
4. Temporary Communication facilities
5. Office furniture
6. Labour colony during construction outside OWNER premise.

	EMERGENCY DIESEL GENERATORS PACKAGE TALCHER FERTILIZERS LIMITED CONSTRUCTION/ERECTION, PRE-COMMISSIONING, COMMISSIONING AND START-UP	PC183/E/4022/SecVI-5.0	0	
		Document No.	Rev	
		Sheet 7 of 117		

3.1 Sewage & Refuse Disposal

All temporary building like site office, canteen etc. shall be arranged by bidder with individual septic tanks and soak pits for treatment and disposal of sanitary sewers. Construction site shall be provided with a network of temporary drain for disposal of rain water.

4.0 Mechanical Completion

Mechanical Completion means the time when all construction, erection & installation work per finally approved P&ID after HAZOP study and pre-commissioning related to the Plant is completed in accordance with the Project drawings and specifications, and all mechanical and pressure tests, including but not limited to hydro-testing, non-operating adjustments, cold alignment checks, final cleanup, hot bolting, field calibration of safety valves, calibration of all instruments, instrument loop checking and testing, monitoring / control / safety systems checking and testing, and all pre-commissioning activities have been completed, all incoming & outgoing services and utilities have been connected to each unit of the PLANT, interconnections of process lines and interconnection are completed and the Plant/Unit is ready in every respect for commissioning and for the first introduction of feed materials.

When OWNER is satisfied that Mechanical Completion of the plant has been achieved, OWNER shall issue certificate of Mechanical Completion to LSTK CONTRACTOR in accordance with the CONTRACT for Owner's Approval.

In order to meet this, LSTK CONTRACTOR shall perform all necessary mechanical works, tests and checks.

5.0 COMMISSIONING



5.1 Schedule for Commissioning

LSTK CONTRACTOR shall prepare a schedule for commissioning, start-up, and performance testing and initial operation in conjunction with OWNER. This shall be issued at least three months before pre commissioning of the first facility.

This schedule shall include all activities as detailed herein and any other special activities, which require to be performed during commissioning.

5.2 Commissioning

LSTK CONTRACTOR shall be responsible to perform commissioning of the Plants and to provide necessary facilities during commissioning of the Plant including the Performance Tests. LSTK CONTRACTOR shall provide commissioning engineers and supporting staff and adequate commissioning labour. LSTK Contractor shall associate OWNER's engineers and operating staff with the commissioning work.



	EMERGENCY DIESEL GENERATORS PACKAGE TALCHER FERTILIZERS LIMITED CONSTRUCTION/ERECTION, PRE-COMMISSIONING, COMMISSIONING AND START-UP	PC183/E/4022/SecVI-5.0	0	
		Document No.	Rev	
		Sheet 8 of 117		

6.0 START UP

LSTK CONTRACTOR shall be responsible to perform start-up of the Plant/Unit. LSTK CONTRACTOR shall provide necessary facilities and for Start Up of the PLANT.

NOTE:

Detail CONTRACTOR'S scope of work in relation with the construction / erection, and pre-commissioning, commissioning and start-up from the point of scope of execution as well as performing way are described in detail in the following Sub-Annexes of Section-7.0.

	EMERGENCY DIESEL GENERATORS PACKAGE TALCHER FERTILIZERS LIMITED CONSTRUCTION/ERECTION, PRE-COMMISSIONING, COMMISSIONING AND START-UP	PC183/E/4022/SecVI-5.0	0	
		Document No.	Rev	
		Sheet 9 of 117		

Sub-Annexure:



Annex 7 - 1 : LSTK Contractor's Work Definition

Annex 7 - 2 : Detail Technical Scope

Annex 7 - 3 : Quality Control Procedures and Inspection Requirement

Annex 7 - 4 : Schedule Progress Evaluation and Progress Reporting

Annex 7 - 5 : General Notes

	EMERGENCY DIESEL GENERATORS PACKAGE TALCHER FERTILIZERS LIMITED CONSTRUCTION/ERECTION, PRE-COMMISSIONING, COMMISSIONING AND START-UP	PC183/E/4022/SecVI-5.0	0	
		Document No.	Rev	
		Sheet 10 of 117		

ANNEXURE-7-1



LSTK CONTRACTOR'S WORK DEFINITION

LSTK CONTRACTOR shall perform/provide the following activities but not limited to:



1. LSTK CONTRACTOR scope of work shall broadly consist of construction / erection, refurbishing, pre-commissioning, commissioning and Start Up of the Plant under the management of commissioning team it includes but not limited to mechanical erection and / or assembly and installation of all equipment and machinery, piping, electrical systems and network, instrumentation, insulation, painting, etc., except in so far as "Contract" otherwise provides, the provision of all temporary facilities, staff, tradesmen, labour, tools, tackle, construction equipment and materials, insurance, consumables and everything whether of temporary or permanent nature necessary and required in and for the work, so far as the necessity for providing the same is specified or reasonably inferred in or from the contract.
 2. Perform all piping fabrication and erection works as per Annex7 – 2A, titled piping fabrication and erection work.
 3. Perform all equipment erection works as per Annex 7 – 2B, titled equipment erection work.
 4. Perform all electrical works as per Annex7 – 2C, titled electrical work.
 5. Perform all instrumentation works as per Annex 7 – 2D, titled instrumentation works.
 6. Perform all insulation works as per Annex 7 – 2E, titled insulation works.
 9. Perform all painting works as per Annex 7 – 2F, titled painting Specification/work.
- Supply the materials in order to execute WORK as per CONTRACT.
10. LSTK CONTRACTOR shall be responsible for providing services and materials for construction of all temporary facilities, which are essential for successful completion of construction and erection.

The LSTK CONTRACTOR shall establish, operate and maintain all temporary facilities, such as, but not limits to:



- a) Labour camp/officers camps

	EMERGENCY DIESEL GENERATORS PACKAGE TALCHER FERTILIZERS LIMITED CONSTRUCTION/ERECTION, PRE-COMMISSIONING, COMMISSIONING AND START-UP	PC183/E/4022/SecVI-5.0	0	
		Document No.	Rev	
		Sheet 11 of 117		

- b) Fabrication shops/yard
 - c) Workshop for maintenance of construction/testing equipment.
 - d) Field drawing office
 - e) Temporary warehouses, including open storage yards.
 - f) Construction offices (including facilities for photocopying, drawing reproduction, etc.)
 - g) First aid.
 - h) Lab facilities, including NDT, for testing calibration, etc.
 - i) All temporary or approach roads for carrying out the WORK including temporary approach roads for access to LSTK CONTRACTOR'S site office/workshop/camp, etc. ground preparation for heavy lifts including approaches to cranes for heavy lifts. OWNER does not take any responsibility for making temporary roads.
 - j) Canteen & catering facilities for all LSTK CONTRACTOR'S work force.
 - k) All drainage around the facilities created for his WORK, and sewage disposal arrangements for labour camps/officers camps, site offices, etc.
 - l) Necessary transport for movement of its personnel, construction Equipment and Materials, consumables, etc.
 - n) Watering of roads through water tankers for dust suppression.
 - o) All temporary lighting for working during night.
 - p) All temporary hutments, sanitary & potable water and domestic sewerage requirements of LSTK Contractor's work force.
11. Supply to OWNER complete survey report within three (3) working days after completion of any survey.
 12. All excess soil shall be disposed of by LSTK CONTRACTOR outside the premises in a location designated by OWNER representative.
 13. Perform all nondestructive, hydrostatic and pre commissioning testing required.
 14. Supply to OWNER complete test records within three (3) days after completion of actual testing.

	EMERGENCY DIESEL GENERATORS PACKAGE TALCHER FERTILIZERS LIMITED	PC183/E/4022/SecVI-5.0	0	
	CONSTRUCTION/ERECTION, PRE-COMMISSIONING, COMMISSIONING AND START-UP	Document No.	Rev	
		Sheet 12 of 117		

15. Perform all welding including radiography required.
16. Provide drawings and documents as required.
17. Provide mobilization and demobilization, temporary material and temporary facilities and utilities required for executing work.
18. Provide winterization during construction, if required.
19. Provide scheduling, planning and reporting as per CONTRACT.
20. Keep complete administration and control of work, specified in CONTRACT.
21. Provide maintenance on all construction and permanent plant material as required during the CONTRACT period.
22. Perform all material identifications as per CONTRACT.
23. Perform all transportations as required.
24. Perform quality assurance, control and supply quality control documentation.
25. Perform all pre-commissioning activities as defined in the CONTRACT.
26. Provide and supply all procedures for execution of the work in accordance with drawings specifications, and applicable codes and standards.
27. Perform all other works and activities and supply all other materials which are required for completeness of the Work either mentioned in the CONTRACT or they are necessary for completeness of the Work, in compliance with highest available standards and good quality.



	EMERGENCY DIESEL GENERATORS PACKAGE TALCHER FERTILIZERS LIMITED CONSTRUCTION/ERECTION, PRE-COMMISSIONING, COMMISSIONING AND START-UP	PC183/E/4022/SecVI-5.0	0	
		Document No.	Rev	
		Sheet 13 of 117		

ANNEXURE- 7 - 2

DETAIL TECHNICAL SCOPE

See accompanying by discipline

- | | |
|-----------------|---------------------------------------|
| Annexure-7 - 2A | Pipe prefabrication and Erection |
| Annexure-7 – 2B | Equipment erection |
| Annexure-7 – 2C | Electrical work |
| Annexure-7 – 2D | Instrument work |
| Annexure-7 – 2E | Insulation work |
| Annexure-7 – 2F | Painting work (Refer TS-2001) |

	EMERGENCY DIESEL GENERATORS PACKAGE TALCHER FERTILIZERS LIMITED	PC183/E/4022/SecVI-5.0	0	
	CONSTRUCTION/ERECTION, PRE-COMMISSIONING, COMMISSIONING AND START-UP	Document No.	Rev	
		Sheet 14 of 117		

ANNEXURE- 7 – A

PIPE PREFABRICATION AND ERECTION

1.0 PIPING

1.1 Magnitude of Piping

LSTK CONTRACTOR shall prefabricate, install and test all piping as shown on the plan drawings and isometrics.

2.0 PIPING FABRICATION AND ERECTION

2.1 Piping systems and pipe supports shall be designed, fabricated, inspected, and tested in accordance with rules, codes, specifications and drawings.

2.2 Miscellaneous piping materials for vents, drains, instrument connections, etc. on equipment shall be installed using P & ID'S and equipment drawings.

2.3 The fabrication and erection of piping includes field welds. It is LSTK CONTRACTOR'S responsibility to choose the number and location of field welds to ensure efficient transportation and handling during erection. Furthermore LSTK CONTRACTOR shall locate the field welds in such a way that final adjustment for fit-up purposes will be possible.



For alloy piping that has to be stress relieved after welding the number of field welds shall be kept to a bare minimum. LSTK CONTRACTOR shall thoroughly evaluate the need for each field weld in alloy piping he deems necessary.

2.4 LSTK CONTRACTOR will furnish OWNER with a marked up set of isometrics identifying all spool pieces, and weld numbers. All piping spools shall be clearly identified, per isometric by means of stainless steel tags affixed with wire.

2.5 LSTK CONTRACTOR shall erect all prefabricated and straight run piping as required by the drawings and specifications.

The erection and installation of the piping shall include but not be limited to the following

- Control valves.
- Safety valves
- Rapture disks.
- Level instrument and gauges.
- External level displacers.
- Special fittings.

	EMERGENCY DIESEL GENERATORS PACKAGE TALCHER FERTILIZERS LIMITED	PC183/E/4022/SecVI-5.0	0	
	CONSTRUCTION/ERECTION, PRE-COMMISSIONING, COMMISSIONING AND START-UP	Document No.	Rev	
		Sheet 15 of 117		

- Breaching of vents, drains, instrument connections, etc.
- Rota meters.
- Orifice flanges.
- Orifice plates.
- In - line instruments.
- Steam tracing.
- Steam traps.
- Extension stems, Valve operators.
- Bellows, expansion joints and similar specialty items.
- Thermo wells (flanged, screwed and weld Ins.).
- Sample coolers.
- Instrument connections (up to and including the first block valve).
- Spring hangers and spring supports.
- Installation of miscellaneous piping and instrumentation supplied by equipment vendor.
- Temporary piping for drying, flushing and hydrostatic testing if necessary.
- Connection of piping to equipment.
- Connection of aboveground piping to underground piping.
- Pipe supports.

This shall include any necessary work to the piping to correct equipment misalignment.



2.6 Fastening of floor supports on concrete will be done with expansion type foundation bolts, if no anchor bolts are provided.

2.7 LSTK CONTRACTOR is responsible for the installation of steam tracing of piping, valves fittings and instruments where required, in accordance with the specifications and drawings. In general steam and condensate headers will be indicated on the piping plans. Lines to be traced will be indicated on P& ID'S and lines lists. Details of steam and condensate headers will be shown on separate drawings. Identification of steam tracers shall be by aluminum tag noting circuit number. Each end of system should be tagged.

A method of identification and tagging of the other various systems shall be established, subject to approval by OWNER and is for account of LSTK CONTRACTOR.

2.8 LSTK CONTRACTOR is responsible for the fabrication and erection of pipe supports, hangers, anchors and guides, as required by the drawings and specifications.

Spring pots and spring hangers, which shall be provided by LSTK CONTRACTOR as will be assembled, installed, adjusted and unlocked by LSTK CONTRACTOR after hydrostatic testing of the line. The required angle iron will be decided in the field and supplied by LSTK CONTRACTOR.

	EMERGENCY DIESEL GENERATORS PACKAGE TALCHER FERTILIZERS LIMITED	PC183/E/4022/SecVI-5.0	0	
	CONSTRUCTION/ERECTION, PRE-COMMISSIONING, COMMISSIONING AND START-UP	Document No.	Rev	
		Sheet 16 of 117		

2.9 LSTK CONTRACTOR shall install and remove all temporary strainers required for WORK defined herein. The removal of these items will be directed by OWNER.

2.10 LSTK CONTRACTOR shall be responsible for the fabrication, installation and dismantling of temporary spool pieces and blinds required for control valves, safety valves and in - line instruments during testing and cleaning. Requirements for these shall be minimized. Requirements for these will be prescribed by OWNER.

In general, in-line instruments, safety valves and control valves may be installed for fit-up purposes if available to avoid the use of temporary spool pieces. They shall be removed for flushing and testing and reinstalled as directed by OWNER. In the case of safety valves these must be installed for fit - up, taken down for calibration by LSTK CONTRACTOR, and reinstalled before mechanical completion. All open flanges and valves shall be blinded or plugged off.

2.11 LSTK CONTRACTOR is responsible for the installation and testing of all piping and steam, electrical tracing and all materials including all items necessary to completely close the systems in strict accordance with the established test system procedures and priorities as directed by OWNER.

2.12 **Wrapping & Coating:-** Surface preparations and installation of Wrapping & Coating of the underground piping with Cold tape (Materials for line coating and wrapping shall be of Tape coating system (Polyethylene backed tape with butyl rubber based adhesive system), if required

2.12.1 Protective coating shall consist of a coating system employing Primer, Inner Wrap and Outer Wrap.

2.12.2 The coating system shall be mechanically applied by an approved type of wrapping machine utilizing constant tension brakes except at tie-in welds, repair patches and at other locations where mechanical application is not practicable..

2.12.3 Coating and wrapping materials shall be handled, transported, stored and applied strictly in accordance with the manufacturer's instruction.



2.12.4 Wrapping Coating material is Cold tape type from **Polyken/Denso/Atla** shall be used.

2.13 **Flushing and Cleaning Of Piping Systems**

i) Sections fabricated in LSTK CONTRACTOR'S workshop shall be fitted with plastic end caps to seal pipe ends, and jointing surfaces shall be suitably protected.

These caps shall not be removed until sections are in the course of erection after delivery at SITE and then shall be removed for reuse.

ii) During fabrication and erection the sections shall be inspected or internal cleanliness.

	EMERGENCY DIESEL GENERATORS PACKAGE TALCHER FERTILIZERS LIMITED	PC183/E/4022/SecVI-5.0	0	
	CONSTRUCTION/ERECTION, PRE-COMMISSIONING, COMMISSIONING AND START-UP	Document No.	Rev	
		Sheet 17 of 117		

- iii) The water which will be used for testing and flushing of the piping system shall be recollected per instruction given by OWNER.
- v) Piping systems shall be flushed with suitable water as supplied by LSTK Contractor unless designated for nitrogen or air testing or otherwise specified by licensor. OWNER'S approval is required before start of flushing.
- v) LSTK CONTRACTOR shall supply all equipment, pumps, gauges, etc. required for flushing and testing of the piping systems.
- vi) For hydro testing and flushing the piping LSTK CONTRACTOR shall weld and caps and install drain plugs, remove end caps after successful hydro test.

3.0 **HYDRO TESTING**

3.1 Inspection and hydro testing of the piping systems shall be in accordance with the drawings and specifications and in strict witness by OWNER representatives.

3.2 Atmospheric pressure systems shall be:

- Visually inspected that all joints are properly made.
- Filled with water for a 24 hours leakage test under atmospheric conditions.

If any leakage occurs in the system during testing, repairs must be made without extra costs to OWNER.



3.3 LSTK CONTRACTOR shall test all piping systems as per the project test diagrams. Testing is to be witnessed and approved by OWNER and where applicable by the appointed (independent inspection authority) filed inspector. A test schedule by test system shall be prepared by LSTK CONTRACTOR and shall be submitted to OWNER for Approval.

3.4 Testing and completion shall be in accordance with project system priorities.



3.5 All equipment, pumps, gauges, pressure recorders temporary piping and fittings, test gaskets and bolting, required for testing of the piping systems and part of LSTK CONTRACTOR'S supply. Before testing LSTK CONTRACTOR shall calibrate its testing equipment.

3.6 LSTK CONTRACTOR shall supply and install blind flanges when required to enable testing of the lines.

3.7 Inexpensive temporary gaskets supplied by LSTK CONTRACTOR, shall be used instead of permanent gaskets where test blinds are located for hydrostatic testing. On successful completion of a test the permanent gasket shall be installed when the blinds are removed.

	EMERGENCY DIESEL GENERATORS PACKAGE TALCHER FERTILIZERS LIMITED	PC183/E/4022/SecVI-5.0	0	
	CONSTRUCTION/ERECTION, PRE-COMMISSIONING, COMMISSIONING AND START-UP	Document No.	Rev	
		Sheet 18 of 117		

- 3.8 Piping systems shall be tested with suitable water. Extreme care shall be taken that suitable water is used for stainless steel systems. For stainless steel the water must be approved by OWNER and shall have a content of chlorides ≤ 50 mg/L
- 3.9 The water for testing purposes will be furnished by LSTK CONTRACTOR.
- 3.10 LSTK CONTRACTOR is to perform the testing in a sequence so as to allow sufficient time for insulation and/or painting to complete within the time frame of the project schedule.
- 3.11 A formal system of documentation will be developed by LSTK CONTRACTOR and approved by OWNER for use by LSTK CONTRACTOR to certify this testing phase of the piping erection. This system will also include a section for supplying OWNER'S "But list" comments.
- 3.12 Erected piping shall be hydrostatically tested in test systems, but not through equipment, control valves etc. except where piping is welded to equipment.
- 3.13 LSTK CONTRACTOR remains responsible for ensuring that no item of equipment, or instrument, is damaged by the test pressure or the test fluid. Suitability of test fluid to be approved prior to testing by the OWNER.
- 3.14 It is emphasized that the installation of temporary strainers prior to testing shall be part of WORK. OWNER shall be contacted concerning installation of temporary strainers.
- 3.15 When lines are pressure tested, valves at the end of the lines must be covered with a test blank for safety reasons. A record, preferably on the test diagrams, shall be kept by LSTK CONTRACTOR indicating which sections have been completed.
- Note: Testing against closed valves is not allowed (spades to be used)
- 3.16 All material damaged during tests shall be replaced on LSTK CONTRACTOR'S account. All joints broken after testing for installation of strainers, orifice flanges, safety valves, etc. must be remade tightly; labour is for LSTK CONTRACTOR'S account.
- 3.17 After testing the piping systems, they shall be completely flushed and drained. OWNER will approve when a line is considered flushed and drained by LSTK CONTRACTOR.
- 3.18 When each section or circuit has been pressure tested and passed, a certificate prepared by LSTK CONTRACTOR on LSTK CONTRACTOR'S furnished forms showing details must be signed by LSTK CONTRACTOR and OWNER, when the test has been completed and the system drained, test blanks must be removed by LSTK CONTRACTOR.
- 3.19 The following activities by LSTK CONTRACTOR are included for the reinstatement of piping after hydro testing:

	EMERGENCY DIESEL GENERATORS PACKAGE TALCHER FERTILIZERS LIMITED	PC183/E/4022/SecVI-5.0	0	
	CONSTRUCTION/ERECTION, PRE-COMMISSIONING, COMMISSIONING AND START-UP	Document No.	Rev	
		Sheet 19 of 117		

- LSTK CONTRACTOR installed temporary testing blinds to be pulled.
- Temporary spool pieces taken out.
- Gaskets renewed, temporary replaced with permanent.
- Flange connection bolts tightened.
- Post hydro punch list items corrected.
- Temporary strainers installed.
- Chemical cleaning performed.
- Supports and hangers checked if in final position.
- Rotating equipment cold alignment checked.
- Reinstallation of control and safety valves and in - line instruments which LSTK CONTRACTOR has removed for hydro-testing.

3.20 Nondestructive testing of welds and systems is to be performed in accordance with standards, codes and specifications prior to perform any hydro-test.



4.0 **PIPING MATERIAL IDENTIFICATION AND PAINTING**

4.1 All piping materials are supplied by LSTK CONTRACTOR and shall be properly stamped and color-coded to ensure that the correct materials are used as required by the drawings, specifications, codes and regulations.

4.2 All materials will be adequately marked as to its specifications. Should LSTK CONTRACTOR be required to cut same or otherwise render piece(s) to have no marking, LSTK CONTRACTOR'S transfer or replacement of proper identification marking to the pieces involved, must be done according to approved stamping method and to be counter stamped by LSTK CONTRACTOR. Paint alone is unacceptable.

4.3 The governing principle shall be that in the installed piping systems, all components can be identified and their origin and complete specifications can be determined. The method for identification and stamping or tagging of the various components of the system shall be worked out in coordination with OWNER and only be implemented after approval.

LSTK CONTRACTOR shall be held responsible for this requirement as a minimum, and any other requirements of local codes and regulations as to identification and documentation of materials.

	EMERGENCY DIESEL GENERATORS PACKAGE TALCHER FERTILIZERS LIMITED	PC183/E/4022/SecVI-5.0	0	
	CONSTRUCTION/ERECTION, PRE-COMMISSIONING, COMMISSIONING AND START-UP	Document No.	Rev	
		Sheet 20 of 117		

- 4.4 Surface preparation and paint application of piping system by LSTK CONTRACTOR, shall be per paint specification.
- 4.5 LSTK CONTRACTOR shall assure that no welds are covered by prime coats prior to acceptance of hydro test.
- 4.6 LSTK CONTRACTOR must ensure that all stamping such as code stamps, registration spool identification, charge numbers etc. shall be visible after paintwork.



5.0 WELDING

- 5.1 All welding shall be carried out according to codes and specifications.
- 5.2 Welder's qualification
- 5.2.1 All welders including those with valid qualifications will be required to submit a test conducted by OWNER prior to start of welding.

Welders that have a certificate which is still valid for the type of material and in accordance with ASME IX will not be tested by OWNER.

- 5.2.2 A current list of qualified welders must be maintained by LSTK CONTRACTOR and a copy furnished to OWNER each time a revision is made.
- 5.3 Welders' identification stamps shall be provided by LSTK CONTRACTOR. Each weld shall be clearly stamped with welder's identification. All welding including tack welding shall be carried out by qualified welders. Unstamped welds shall be removed and replaced at LSTK CONTRACTOR'S expense.
- 5.4 Job SITE fabrication shall be carried out under cover where possible.
- 5.5 Weld spatter shall be knocked off around all welds leaving a smooth clean surface.
- 5.6 Where openings for branches are cut in run of pipe, all material, which may drop inside the pipe, shall be completely removed before the branch line is welded in place.
- 6.7 The interior welds of orifice flanges shall be ground smooth.
- 5.8 Electrodes, Rods, Wires and Fluxes**

Electrodes shall be stored in the makers' airtight containers until required for use. Electrode heaters shall be used on Job SITE, for low hydrogen types of electrodes.

	EMERGENCY DIESEL GENERATORS PACKAGE TALCHER FERTILIZERS LIMITED	PC183/E/4022/SecVI-5.0	0	
	CONSTRUCTION/ERECTION, PRE-COMMISSIONING, COMMISSIONING AND START-UP	Document No.	Rev	
		Sheet 21 of 117		

Electrodes and filler wires to be used at site in this job shall be procured from the approved vendors only. Electrodes and filter wires shall be **D&H, Advani Orlikon or ESAB, Mailam and Bohler group make only.**

5.9 **Open Air Welding**

Where welding in the open air is unavoidable, WORK must be discontinued where the quality of the weld may be impaired by weather conditions. Including but not limited to airborne moisture, sand or high winds. After rain the metal surfaces shall be dried. For metal temperature below 5 °C joints to be preheated.

5.10 **Welding Procedure Qualification**

LSTK CONTRACTOR shall supply welding procedure specifications and qualification in accordance with the rules as set by OWNER.

5.11 Fees for inspection required for welding procedure and welders qualifications, supply of equipment required for the qualification test of welders and welding procedures are for account of LSTK CONTRACTOR.

5.12 **Inspection and Testing**

5.12.1 Inspection of welds shall be in accordance with the instructions of OWNER and/or the requirements of codes and standards.

5.12.2 LSTK CONTRACTOR shall be responsible for the repair of faulty welds and for all the required extra radiography and inspection of the faulty welding work. In case of a faulty weld, 100% radiography, on LSTK CONTRACTOR'S account, shall be done on the weld performed as per code.



OWNER shall have absolute discretion in the selection of the welds, which are to be radio graphed.

5.12.3 LSTK CONTRACTOR shall provide NDE service, acceptable to OWNER.

NDT inspection shall be carried out in accordance with codes for all lines as indicated in the piping specification.

6.0 **STRESS RELIEVING**

6.1 LSTK CONTRACTOR shall provide stress-relieving service acceptable to OWNER. Spool pieces shall be stress relived in an approved furnace equipped with thermostatic control and temperature recorder. Field welds to be stress relieved with electric resistance heaters. Temperature cycles to be monitored with portable temperature recorder.

	EMERGENCY DIESEL GENERATORS PACKAGE TALCHER FERTILIZERS LIMITED	PC183/E/4022/SecVI-5.0	0	
	CONSTRUCTION/ERECTION, PRE-COMMISSIONING, COMMISSIONING AND START-UP	Document No.	Rev	
		Sheet 22 of 117		

6.2 Stress relieved welds shall be hardness tested by approved procedure and must meet criteria spelled out in specifications.

7.0 TRANSPORTATION

The following various categories of transportation of pipe, pipe fittings and prefabricated pipe spools will be performed by LSTK CONTRACTOR. All categories include loading and unloading materials. Categories will consist of but not limited to:

- From LSTK CONTRACTOR'S warehouse to LSTK CONTRACTOR'S pipe prefab shop.
- From LSTK CONTRACTOR'S pipe prefab shop to LSTK CONTRACTOR'S painting shop.
- From LSTK CONTRACTOR'S pipe prefab or painting shop to LSTK CONTRACTOR'S storage area or working area located on site or any other location on SITE.
- All transportation required performing nondestructive testing of prefabricated pipe spools.

8.0 LIFTING, LIFTING EQUIPMENT AND GEAR

8.1 Rigging and hoisting shall be executed as per construction specification and local requirements and safety rules, as manufacturer's instructions. If there are stringent one shall prevail.

8.2 Testing And Certification

All LSTK CONTRACTOR furnished cranes, lifting appliances and lifting gear must be properly tested, examined and/or inspected before being used on SITE, and at the intervals specified in the applicable regulations. Copies of the relevant certificates must always be available on SITE for inspection on request by OWNER or other authorities.



8.3 Operation

8.3.1 LSTK CONTRACTOR shall not permit a lifting appliance to be operated otherwise than by a person trained and competent to do so.

8.3.2 LSTK CONTRACTOR shall take express steps to ensure that all personnel employed by LSTK CONTRACTOR are competent and experienced for their assigned tasks.



9.0 DRAWINGS AND DOCUMENTS

LSTK CONTRACTOR shall fill in checklists as required by OWNER.

	EMERGENCY DIESEL GENERATORS PACKAGE TALCHER FERTILIZERS LIMITED	PC183/E/4022/SecVI-5.0	0	
	CONSTRUCTION/ERECTION, PRE-COMMISSIONING, COMMISSIONING AND START-UP	Document No.	Rev	
		Sheet 23 of 117		



10.0 **MISCELLANEOUS**

- 10.1 LSTK CONTRACTOR shall furnish all field engineering surveying layout, and checking to properly install all above ground piping to meet all requirements of the drawings and specification. OWNER is authorized to reject any WORK already installed, which is not in accordance with drawing and specifications and of adequate quality.
- 10.2 All costs involved in demolition, removal and replacement of rejected works shall be the responsibility of LSTK CONTRACTOR. All materials equipment or auxiliaries not accepted by OWNER shall be removed immediately from SITE.
- 10.3 Underground service lines are marked at their installation limits to above ground piping, indicating line size, service and line number.
- 10.4 During storage, fabrication and erection, care must be taken to ensure that sand, scrap materials, welding rods, items of clothing and other foreign bodies are not allowed to enter piping.
- 10.5 All connections which are left open by LSTK CONTRACTOR shall be well protected, so that no sand, dirt or any foreign object come into the system.
- 10.6 In certain instances special bolting torques might be required on critical connections. LSTK CONTRACTOR will arrange WORK in accordance with these requirements.
- 10.7 Flanged piping connections to vessels or equipment shall be aligned and shall be properly fitted before bolting up. Piping may be heated to bring it into alignment only when approved by OWNER. Extreme care should be exercised to avoid damage. Heating, welding and flame cutting on equipment will not be permitted.
- 10.8 No cold springing or pre- stressing of piping will be allowed other than indicated on piping drawings, isometrics and manufacturer's instructions (e.g. for expansion joints).
- 10.9 Flange faces shall be clean and free from foreign matter before assembly. Damaged flange faces may be dressed with a medium cut file only if the damage does not require new facing. This shall be decided by OWNER.
- 10.10 During erection care shall be taken to remove all dirt, seals, sand and foreign matters from inside the pipe.
- 10.11 Since LSTK CONTRACTOR is responsible for both the prefabrication and the erection of all the piping, it is LSTK CONTRACTOR'S sole responsibility to ensure that all piping to be installed fits properly prior to lifting. LSTK CONTRACTOR is to check all equipment and underground piping to be piped to, for proper location and orientation. OWNER will not

	EMERGENCY DIESEL GENERATORS PACKAGE TALCHER FERTILIZERS LIMITED CONSTRUCTION/ERECTION, PRE-COMMISSIONING, COMMISSIONING AND START-UP	PC183/E/4022/SecVI-5.0	0	
		Document No.	Rev	
		Sheet 24 of 117		

entertain any claims for extra work for :

- i. Taking piping down for rework after it is lifted
 - ii. Re-lifting piping after it is reworked.
- 10.12 Final hookup of piping to equipment such as pumps and compressors shall be done together with the final alignment of this equipment and shall include checking of dimensions. Piping must fill these flanges without inducing any strain on equipment.
- 10.13 In all cases, all designated support and hangers should be in unlocked / cold position before final alignment. LSTK CONTRACTOR will be expected to expedite this critical phase of construction.
- 10.14 Certain small vessels will be considered to be piping items and shall be fabricated as such by LSTK CONTRACTOR.

	EMERGENCY DIESEL GENERATORS PACKAGE TALCHER FERTILIZERS LIMITED	PC183/E/4022/SecVI-5.0	0	
	CONSTRUCTION/ERECTION, PRE-COMMISSIONING, COMMISSIONING AND START-UP	Document No.	Rev	
		Sheet 25 of 117		

ANNEXEURE- 7 -2B

EQUIPMENT ERECTION

1.0 SURVEYING

- 1.1 Baseline and base elevation will be furnished to the LSTK CONTRACTOR. LSTK CONTRACTOR will furnish all surveying from this baseline and elevation.
- 1.2 OWNER shall have the authority at any time to determine in accordance with the drawings or written directives, the correctness or completeness of the lines in use by LSTK CONTRACTOR.
- 1.3 Any erroneous WORK shall be corrected to OWNER'S satisfaction at LSTK CONTRACTOR'S expense.

2.0 RIGGING STUDIES AND PLANS

- 2.1 LSTK CONTRACTOR shall supply rigging studies and plans as specified.

3.0 EQUIPMENT HANDLING

- 3.1 The handling of all equipment shall include, but not limited to the following activities by LSTK CONTRACTOR:
- 3.1.1 Submittal to OWNER of detailed rigging studies and plans for lifting, transporting and setting of equipment 4 weeks in advance of work for OWNER to review and approval. Complicated lifts shall be started in the morning and completed the same day.

The transportation plans are to include as a minimum:



Type of equipment to be used to transport each piece.

The planned route of the movement.

The estimated duration of the movement.

The obstructions to the route to be temporarily removed.

- 3.1.2 Receive, inspect, store, protect and perform preventative maintenance on all equipment in accordance with the specifications and drawings and/or equipment manufacturer's instructions.

	EMERGENCY DIESEL GENERATORS PACKAGE TALCHER FERTILIZERS LIMITED	PC183/E/4022/SecVI-5.0	0	
		Document No.	Rev	
	Sheet 26 of 117			

- 3.1.3 Prepare foundations, pipe sleeves, paving, concrete structures and steel structures for setting equipment.
- 3.1.4 Transport form warehouse or point of unloading and install equipment on foundations, paving or structures.
- 3.1.5 Plumb level and align equipment with coordinates in accordance with the specifications and drawings.



3.1.5.1 **GENERAL**

All of the equipment must be plumbed, leveled and aligned with the coordinates specified on the drawings both in plan and elevation and to the tolerances called out in the specifications, specific manufacturer's instructions or recommended manufacture's practices.

- LSTK CONTRACTOR will be required to verify field conditions and will be responsible for final alignment of mechanical items for this project. LSTK CONTRACTOR will check the anchor bolt locations against the equipment. Any deviation must be reported to OWNER in writing.
- LSTK CONTRACTOR will be required to supply and install shims required for all equipment erection. All cinch anchors required for equipment and supports will be supplied and erected by LSTK CONTRACTOR.

Prior to the placement of the equipment on a foundation, the surfaces of the foundation shall be cleaned of oil, grease, excess concrete and foreign matters by LSTK CONTRACTOR.

- Prior to setting the equipment on the foundations, the underside of the equipment base plate or supports will be cleaned free of oil, grease and other loose materials by LSTK CONTRACTOR.
- Anchor bolts shall be checked for damage to the thread and the threaded part shall be properly greased.
- Damaged anchor bolts must be replaced by LSTK CONTRACTOR and brought to the attention of OWNER.
- The openings between the anchor bolts and sleeves have to be cleaned of foreign materials to full depth of the opening by LSTK CONTRACTOR.
- All steel wear plates and guide keys shall be coated by CONTRACT with proper lubrication, prior to setting the equipment.
- Equipment shall be set true to line. at correct elevation and in proper orientation as shown



	EMERGENCY DIESEL GENERATORS PACKAGE TALCHER FERTILIZERS LIMITED CONSTRUCTION/ERECTION, PRE-COMMISSIONING, COMMISSIONING AND START-UP	PC183/E/4022/SecVI-5.0	0	
		Document No.	Rev	
		Sheet 27 of 117		

and noted on the drawings.

- Maximum allowable setting tolerances shall be in accordance with manufacturer's requirements or with the specifications, whichever is more stringent.
- All equipment, unless otherwise specified, shall be leveled with shims at each anchor bolt (shim on both sides of each anchor bolt) and at intermediate points as required to prevent distortion of the equipment. Shims shall have square cut edges (not trimmed or sheared) and shall be of various thicknesses to minimize the number of shims required. Shims shall be supplied by LSTK CONTRACTOR.
- The equipment shall be set, leveled, aligned and inspected with precision tools (steel straight edge, graduated machinist levels, dial indicators, theodolites, water level instruments, turbine levels, etc.). Setting, leveling and alignment shall be according to manufacturer's recommended tolerances and specifications.
- There may be a number of items not installed by the manufacturer, i.e. seals, packing, lubricators, gauges, miscellaneous piping and tubing, thermometers, etc. that will come separately packed from the equipment itself that must be identified, stored, preferably inside in accordance with project criteria, and finally installed. LSTK CONTRACTOR is responsible for these activities.
- LSTK CONTRACTOR shall remove all temporary shipping supports or erection materials.
- LSTK CONTRACTOR shall do surface preparation for, and apply coating and wrapping on buried vessels before installation.

Equipment supported on legs or on saddles shall be set to the tolerances specified in specifications of the required elevation measured on the flange of the largest diameter pipe-connecting nozzle.

- For equipment with sliding type supports, LSTK CONTRACTOR will remove dirt, grease or other foreign matter and will coat with graphite grease supplied by LSTK CONTRACTOR on the support.
- The anchor bolt nuts will be placed so as not to restrict the longitudinal movement of the sliding end.
- Vessels, drums, etc. shall be aligned, where applicable and leveled per shown or drawing.
- Shims shall be placed approximately evenly spaced under the support ring of vessels, drums, tanks.
- Towers with two or more pieces shall be assembled and welded at site by LSTK



	EMERGENCY DIESEL GENERATORS PACKAGE TALCHER FERTILIZERS LIMITED CONSTRUCTION/ERECTION, PRE-COMMISSIONING, COMMISSIONING AND START-UP	PC183/E/4022/SecVI-5.0	0	
		Document No.	Rev	
		Sheet 28 of 117		

CONTRACTOR.

- LSTK CONTRACTOR is responsible to check and inspect at these equipments in the vendor's shop.
- All costs are included in the lump sum price.

3.1.5.2 Rotating Equipment

- Rotating equipment will be installed in accordance with manufacturer's instructions.
- Align drivers with all rotating equipment.
- LSTK CONTRACTOR shall install all ancillary equipment such as, but not limited to, drivers, guards, harness piping and all other interconnecting piping, casing drains, base plate drains and all necessary supports.
- The measurements for the positioning and leveling of mechanical equipment will be made on the suction flange.
- LSTK CONTRACTOR to install permanent packing, seals lubricating oils, greases and circulated oil systems.
- Services of manufacturer's technical representative by LSTK CONTRACTOR shall be used to the fullest extent.
- Rotating equipment base plates will be supported for positioning and leveling on shims located as follows.
- For bases with four (4) anchor bolts. one set of shims will be placed adjacent to each anchor bolt.
- For bases with six (6) or more anchor bolts, two (2) sets of shims will be placed adjacent to each anchor bolt, one on each side of the anchor bolt.
- In addition shims shall also be placed directly under those parts of the base plate carrying the greatest weight and shall be placed closely enough to give uniform support.
- When the base plate is level in all directions as indicated by an accurate instrument on the machined pads, the anchor bolt nuts shall be brought down evenly, but not too firmly. The unit is now ready for grouting. After the grout has adequately set, pull the anchor bolt nuts down tight and recheck the base for levelness.
- Release for grouting of base plates must be approved by OWNER.

	EMERGENCY DIESEL GENERATORS PACKAGE TALCHER FERTILIZERS LIMITED	PC183/E/4022/SecVI-5.0	0	
	CONSTRUCTION/ERECTION, PRE-COMMISSIONING, COMMISSIONING AND START-UP	Document No.	Rev	
		Sheet 29 of 117		

- After completion of the electric installation to the motor, the direction of rotation of the motor will be determined. Prior to checking the direction of rotation, the coupling between the motor and the equipment will be disconnected for the test run of motor by LSTK CONTRACTOR.
- Rough aligning of the centrifugal units and their respective drivers shall take place after the equipment has been put on the foundation.
- Coupling alignment
- Dial indicators shall be used and where possible optical alignment equipment.

Peripheral alignment shall be checked by using one dial reading peripheral differences between coupling halves as they are rotated together.

Face alignment shall be checked using two dials reading face-to-face differences between coupling halves.



- Tolerances shall be in accordance with manufacturer's instructions with and without pipe work connected.
- Manufacturer's representative shall check that the final alignment of equipment is satisfactory before any running takes place. For small equipment. Where it is agreed by OWNER that the services of a manufacturer's representative are not required, manufacturer's written instructions shall be followed.
- The final checks will be supervised by LSTK CONTRACTOR and the results recorded by LSTK CONTRACTOR and signed by OWNER and LSTK CONTRACTOR.

Final alignment shall be carried out in two stages.



- After piping is complete with all bolts removed from the flange connections.
- Final alignment with piping assemblies 100% complete and all flanges bolted up to ensure that no unforeseen vertical or horizontal pipe loading is imposed on the unit.
- The final aligning supervised by OWNER to make sure that the detailed instructions furnished by the equipment suppliers are carried out to the full satisfaction.

LSTK CONTRACTOR to supply qualified personnel in the final alignment activities.



- Prior to putting pumps, etc. into operation, loose equipment such as guards and gauges shall be installed by LSTK CONTRACTOR.

	EMERGENCY DIESEL GENERATORS PACKAGE TALCHER FERTILIZERS LIMITED	PC183/E/4022/SecVI-5.0	0	
	CONSTRUCTION/ERECTION, PRE-COMMISSIONING, COMMISSIONING AND START-UP	Document No.	Rev	
		Sheet 30 of 117		

- 3.1.6 Mount the drivers to the rotating equipment in case of turbines and any large motors that are shipped separately.
- 3.1.6.1 In case electric motors have to be installed in the field, this shall be done after leveling of base plate, but prior to grouting.
Chrome / nickel shim material, supplied by LSTK CONTRACTOR shall be used for alignment of drivers and pumps and shall be installed under the entire footing of the driver.
- 3.1.6.2 Equipment and drivers shall be doweled to bed plate if required by manufacturer's instructions.
- 3.1.7 Assembly whenever required for the items / package unit like Auxiliary Boilers, Waste Heat Boilers, Air - cooled exchangers, furnaces , compressors ,Turbo generators etc. units as part of the scope of WORK of installation by LSTK CONTRACTOR.
- 3.1.7.1 Compressor seal oil and lube oil systems and control panels are included in LSTK CONTRACTOR'S installation of compressors.
- 3.1.7.2 When equipment is delivered in two or more sections for site welding the weld preparation must match accurately on mating sections before assembling.
- 3.1.7.3 LSTK CONTRACTOR shall assemble and erect items, whether skid mounted or supplied in individual components as specified in the requisition or indicated on drawings in order to make a completed unit.
- 3.1.7.4 Installation, assembly and alignment of the various components shall be done by LSTK CONTRACTOR.
- 3.1.7.5 Installation of air - cooled exchangers includes the erection of structural steel on the pipe rack, which will support the tube bundles must be done by LSTK CONTRACTOR.
- 3.1.7.6 Walkways, platforms, stairs, ladders shall be installed for the items / package unit like Auxiliary Boilers, Waste Heat Boilers, Air - cooled exchangers, furnaces, compressors, Turbo generators etc. by LSTK CONTRACTOR.
- 3.1.7.7 Drying out systems, refractory and linings is included in LSTK CONTRACTOR scope of work.
- 3.1.8 Install ladders, platforms, davits, pipe supports and pipe guides in accordance with drawings and specifications.
- 3.1.9 Open man ways. Inspect. clean and close man ways of all tanks, towers. vessels and other equipment as directed by specification or manufacturer.

	EMERGENCY DIESEL GENERATORS PACKAGE TALCHER FERTILIZERS LIMITED	PC183/E/4022/SecVI-5.0	0	
	CONSTRUCTION/ERECTION, PRE-COMMISSIONING, COMMISSIONING AND START-UP	Document No.	Rev	
		Sheet 31 of 117		

- 3.1.10 Install all trays and vessel internals and support for same shipped loose. in accordance with drawings, specifications and manufacturer's recommended installation instruction.
- 3.1.11 Under the supervision of OWNER and respective manufacturer's representative LSTK CONTRACTOR shall load the first loading of chemicals.
- a) There will be certain items of equipment such as filters and package equipment that come with cartridges filled with –desiccants, resins, etc. Their items will be installed by LSTK CONTRACTOR if they are shipped separately from the equipment.
- b) Installations include the pick-up of these chemicals from the place of storage and transportation to point of installation.
- 3.1.12 Under the supervision of OWNER, LSTK CONTRACTOR install the first loading of catalysts. Installations include the pick-up of these catalysts from the place of storage and transportation to point of installation.
- 3.1.13 Touch - up of painting on new equipment after erection.
- 3.2 LSTK CONTRACTOR shall install grout under all equipment as required.
- 3.3 Grouting will be as per the specification per the equipment manufacturer's recommendation, whichever is more stringent.
- 3.4 The following work is included but not limited to LSTK CONTRACTOR'S scope for installation of grouting:
- 3.4.1 Prepare top surface of base and/or plinth, pockets, sleeves etc., prior to placing grout.
- 3.4.2 Install grout mortar consisting of one part Portland cement and one part of clean sand and sufficient clean water for workability.
- This grout mortar shall be used between steel base plate and concrete foundations.
- 3.4.3 Wherever non-shrinkage grout is specified on the drawings, the same shall be supplied by LSTK CONTRACTOR and installed in accordance with manufacturer's instructing.
- 3.5 Install non-shrink grout between reciprocating / rotary equipment base frame including the filling of the equipment steel frame if required, and concrete foundation in accordance with manufacturer specifications and project specifications. Type of non-shrink grout to be approved by OWNER. After grouting, shims used in leveling equipment will not be removed except where removal is specifically required by manufacturer's instructions.

	EMERGENCY DIESEL GENERATORS PACKAGE TALCHER FERTILIZERS LIMITED	PC183/E/4022/SecVI-5.0	0	
	CONSTRUCTION/ERECTION, PRE-COMMISSIONING, COMMISSIONING AND START-UP	Document No.	Rev	
		Sheet 32 of 117		

3.6 Unless indicated otherwise on drawings vessels supported on skirts and support rings will be grouted using a stiff mix under the support ring so as to obtain full bearing, Grout will be placed within the area of the skirt the high point of ground at the vertical axis of the tower (or vessel), sloping downward to the support ring with four (4) weep holes under the support ring sufficiently large to ensure drainage.

4.0 MATERIAL HANDLING SYSTEM

4.1 ERECTION & COMMISSIONING

4.1.1 The complete material handling system including its all equipment shall erected at site and commissioned in accordance with the best engineering practice.

4.1.2 Packing, forwarding, transportation, unloading and storage at site, safety and protection of various components at site, insurance etc. shall be the responsibility of the LSTK Contractor / supplier.

4.1.3 All men, material and tools required shall be arranged by the LSTK Contractor at his own cost. The LSTK Contractor shall also arrange for the safe handling, storage, protection and security of his good at site.



4.1.4 The purchaser shall be responsible for supplying his part of material only as covered by the clause pertaining to the work to be excluded from LSTK Contractor's scope of supply.

4.1.5 After erection at site, the belt conveyors and related equipment shall be tested for satisfactory operation for mechanical completion and full-load performance run. The LSTK Contractor shall carry out performance test as per mutually agreed procedure. The details of the procedure shall be submitted by the LSTK Contractor for purchaser's approval.

4.2 MECHANICAL COMPLETION

4.2.1 Mechanical completion shall be considered as achieved when the system is mechanically complete along with the pre-commissioning activities and is ready for feeding. This shall include but not limited to the following:

1. The installation as per FINAL PROPOSAL is complete in all respects in accordance with the drawings, specifications including any approved changes thereto and in accordance with all applicable codes and laws.
2. The machinery, conveyors and all drives are aligned and run or cycled under no-load conditions.

	EMERGENCY DIESEL GENERATORS PACKAGE TALCHER FERTILIZERS LIMITED	PC183/E/4022/SecVI-5.0	0	
	CONSTRUCTION/ERECTION, PRE-COMMISSIONING, COMMISSIONING AND START-UP	Document No.	Rev	
		Sheet 33 of 117		

3. The electrical system is installed and tested in accordance with applicable codes and specifications. All wiring is checked for correct hook-up. Motor rotation is checked and power system protective devices are set.
4. Painting is completed to the extent that the incomplete work does not prevent plant start-up and commissioning.
5. Successful completion of no-load test of all the equipment and the complete system.
6. Temporary construction facilities are removed to the extent necessary to permit the plant start-up and commissioning.

4.2.2 The OWNER shall inspect and certify that the LSTK Contractor executed the job in accordance with drawings and specifications.

4.2.3 When the complete belt conveyors and related equipment have been fully erected at site, LSTK CONTRACTOR shall request OWNER for his agreement to start the No-load Test Run. Owner shall, within 72 hours of receipt of such request, issue his agreement or advise LSTK Contractor in writing of any deficiencies noticed in the equipment.



4.2.4 Omissions / rectifications of minor items, if any, not affecting commissioning shall not withhold MECHANICAL COMPLETION as long as the LSTK Contractor agrees to supply / rectify the same within the specified period. The decision of the OWNER is final in this regard.

4.3 COMMISSIONING AND GUARANTEE TEST



4.3.1 After issue of Mechanical completion certificates by Owner, LSTK CONTRACTOR & OWNER shall mutually decide the date of commissioning of the equipment. From the date of commissioning, the equipment shall be gradually brought up to full load or any other load at the discretion of OWNER, and thereafter the equipment shall be run for a minimum period of 5 days. OWNER shall have the right to reduce this period where deemed necessary because of OWNER's difficulties. During this period of 5 days of operation or the reduced period, the system shall run at an average of 90% of rated capacity. If the LSTK CONTRACTOR is not able to bring the load to 90% of the rated capacity as mentioned above within 2 (two) months, OWNER shall, without prejudice to any of his rights under the contract, has the right to take over the equipment and to proceed with modifications / rectifications / additions as he considers necessary at LSTK CONTRACTOR's cost and risk to achieve this sustained load run.

5.0 PREPARE EQUIPMENT FOR OPERATION



5.1 Immediately prior to turnover, LSTK CONTRACTOR will make all the equipment ready for operation. This includes, but is not limited to such activities as:

	EMERGENCY DIESEL GENERATORS PACKAGE TALCHER FERTILIZERS LIMITED	PC183/E/4022/SecVI-5.0	0	
	CONSTRUCTION/ERECTION, PRE-COMMISSIONING, COMMISSIONING AND START-UP	Document No.	Rev	
		Sheet 34 of 117		

- 5.1.1 Removal of preservatives and rust preventatives.
- 5.1.2 Installation of seals or removal of steel covers.
- 5.1.3 Removal of moisture absorbing materials.
- 5.1.4 Draining of oil reservoirs and the flushing and filling of the initial charge.
- 5.1.5 If required by OWNER for the final inspection the opening and closing of man ways of vessels and tanks.
- 5.1.6 Assisting equipment manufacturer's representatives by final checkout of equipment.
- 5.1.7 Remove all temporary supports, bracing, or other foreign objects that were installed in vessels rotating equipment or other equipment to prevent damage during shipping, storage, transport and erection.
- 5.1.8 Conduct all flushing, blowing and chemical cleaning required by the specifications.
- 5.1.9 Check and run in all rotating equipment, i.e. compressors, pumps.
- 6.0 Scaffolding sufficient amount of scaffolding required for good performance of the WORK shall be supplied by LSTK CONTRACTOR.
- 7.0 **DRAWINGS AND DOCUMENTS**
- 7.1 **LSTK CONTRACTOR will carry out all construction and any required procurement activities directly from the AFC construction drawings and specifications and forming part of the CONTRACT. No additional design work or development e.g. completion of drawings will be required from LSTK CONTRACTOR.**
- However, the plan type drawings called out to be supplied by LSTK CONTRACTOR in previous subsections of this section are included in LSTK CONTRACTOR'S scope of WORK.
- 7.2 All of LSTK CONTRACTOR'S drawings, calculations, documents, test reports, and test certificates are to be submitted to OWNER for approval in 6-fold. After receiving approval LSTK CONTRACTOR to submit for final approval all of the above and one (1) soft copy in CF format. LSTK CONTRACTOR drawings receiving "Approved as Noted" stamp may be worked on provided all notes are incorporated. It is understood that OWNER'S approval shall not receive in no way LSTK CONTRACTOR from any of his obligations and further more shall not relieve LSTK CONTRACTOR from his obligations to timely complete the WORK according to approved project schedule by OWNER.
- 7.3 LSTK CONTRACTOR'S drawings shall be clearly marked with titles, equipment numbers or other item identification.

	EMERGENCY DIESEL GENERATORS PACKAGE TALCHER FERTILIZERS LIMITED	PC183/E/4022/SecVI-5.0	0	
	CONSTRUCTION/ERECTION, PRE-COMMISSIONING, COMMISSIONING AND START-UP	Document No.	Rev	
		Sheet 35 of 117		

- 7.4 Approval of drawings and calculations by OWNER in no way absolves LSTK CONTRACTOR from its responsibility for the accuracy or for the design, construction and timely performance of the WORK.
- 7.5 LSTK CONTRACTOR shall promptly submit reports of each and every test or inspection.
- 7.6 LSTK CONTRACTOR shall submit quality records of the materials, as specified in previous sections and the applicable engineering specifications.
- 7.7 LSTK CONTRACTOR shall furnish an equipment installation record indicating date of installation and tag number of each piece of equipment.
- 7.8 LSTK CONTRACTOR shall furnish an equipment maintenance record indicating date and type or maintenance of each piece of equipment during the LSTK CONTRACTOR period.
- 7.9 LSTK CONTRACTOR shall fill out checklists as required by OWNER.
- 8.0 LIFTING, LIFTING EQUIPMENT AND GEAR**
- 8.1 Rigging and hoisting shall be executed in accordance with construction specification local and governmental requirements and safety manuals, as well as specific equipment manufacturer's instructions. If there are conflicts, the more stringent shall prevail.
- 8.2 LSTK CONTRACTOR shall only perform the lifts and movements in accordance with approved LSTK CONTRACTOR submitted rigging studies and plans.
- 8.3 Preferably, equipment will be lifted in accordance with manufacturer's instructions, if include, using lifting trunnions, lifting lugs if provided, or by slings attached to or around the equipment, with adequate protective measures to prevent damage to equipment. No temporary lifting lugs shall be used without the written approval of OWNER.
- 8.4 No nozzles or other appurtenances not intended for lifting shall be used for attachment of slings.
- 8.5 Equipment shall be handled with sufficient care to prevent damage. Slings shall have adequate protection to prevent marring the surface of equipment. Where necessary, sling spreaders shall be used to prevent crushing or other damage to the equipment.
- 8.6 Testing And Certification**
All LSTK CONTRACTOR furnished cranes, lifting appliances and lifting gear must be properly tested, examined and /or inspected before being used on site and at the intervals specified in the applicable regulations. Copies of the relevant certificates must always be available on site for inspection on request by OWNER or proper authorities.

	EMERGENCY DIESEL GENERATORS PACKAGE TALCHER FERTILIZERS LIMITED CONSTRUCTION/ERECTION, PRE-COMMISSIONING, COMMISSIONING AND START-UP	PC183/E/4022/SecVI-5.0	0	
		Document No.	Rev	
		Sheet 36 of 117		

8.7 **Operation**

8.7.1 LSTK CONTRACTOR shall not permit a lifting appliance to be operated otherwise than by a person trained and competent to do so.



8.7.2 LSTK CONTRACTOR shall take express steps to ensure that all personnel employed by LSTK CONTRACTOR are competent and experienced for their assigned tasks.

9.0 **WELDING**

Welding of or on equipment shall only be permitted with the approval or OWNER.

10.0 **EQUIPMENT PAINTING & INSULATION TOUCH**

Rotating and special equipment to be erected by LSTK CONTRACTOR will be delivered to SITE finished painted. LSTK CONTRACTOR is responsible to apply remedial / touch up painting for any damages to paint, or protective coatings on equipment handled by it in connection. With any aspect of these operations such as unloading, transport, handling and erection as per Annexure mention in ITB Section.

	EMERGENCY DIESEL GENERATORS PACKAGE TALCHER FERTILIZERS LIMITED	PC183/E/4022/SecVI-5.0	0	
	CONSTRUCTION/ERECTION, PRE-COMMISSIONING, COMMISSIONING AND START-UP	Document No.	Rev	
		Sheet 37 of 117		

ANNEXURE- 7 – 2C

ELECTRICAL WORK

1.0 **SCOPE: ELECTRICAL WORK COVERS**

- 1.1 Installation and erection of the following equipment (items) consists of the preparation for installation, connection, testing and pre-commissioning etc. as per specifications and as per drawings.
- 1.2 Provision of all tools, equipment and consumables used in the course of the work.
- 1.3 The installation of the following systems (items) shall consist of the connection, testing and pre-commissioning etc., so that the systems are ready for use as per specifications and as per drawings.
- 1.4 Transport, store and protect supplied materials to the construction location.

2.0 **ELECTRICAL ITEMS**

- 2.1 Generators / Motors
- 2.2 Control panels
- 2.3 Transformer

Note: Installation of all accessories, tanks, levelling and fixing in place are also considered.

2.4 **Switch Gears**

Note: Bolting together sections where supplied separately and installation of panels, levelling and fixing in place are also considered.



2.5 **Bus Ducting**

Note: Jointing and securing the associated switch boards / transformers are also considered.

- 2.6 Battery charger, battery sets and UPS unit.

- 2.7 Cables in trench / conduit / tray / Rack.

Note: Following items are also necessary.



	EMERGENCY DIESEL GENERATORS PACKAGE TALCHER FERTILIZERS LIMITED	PC183/E/4022/SecVI-5.0	0	
	CONSTRUCTION/ERECTION, PRE-COMMISSIONING, COMMISSIONING AND START-UP	Document No.	Rev	
		Sheet 38 of 117		

- a) Measuring and cutting of cable and protection of cut ends.
- b) Identification of cables
- c) Fixing of cable to tray / rack

- 2.8 Cable Glands
- 2.9 Cable terminations
- 2.10 Earthing cable in trench / conduit / tape on tray / Rack
- 2.11 Earth cable tape terminations
- 2.12 Lightening protection
- 2.13 Lighting/ fittings / supports
- 2.14 Earth Rod PRT and cover
- 2.15 Cable tiles
- 2.16 Trench marker posts
- 2.17 Air craft warning
- 2.18 Underground electrical grounding system

Note: All bellow items are also considered:

- a) Pulling of grounding cable in trenches, through culverts, protection sleeves and cable ducts as per grounding cable supplier installation instruction, project specifications and layout and detail drawings.
- b) Coil up and clearly designate the final destination of the cable ends, especially if cables have to be continued their routing underground or overhead via cable tray or otherwise to their final destination at a later date.
- c) Install, including the provision of the required tools, the required through branch and end connections.
- d) Installation of all grounding electrodes including inspection pits as per specification and the layout and detail drawings.
- e) Return of the cable drums to the storage area including a clear make up of cable length left on the reels of drums that are not empty.

	EMERGENCY DIESEL GENERATORS PACKAGE TALCHER FERTILIZERS LIMITED	PC183/E/4022/SecVI-5.0	0	
	CONSTRUCTION/ERECTION, PRE-COMMISSIONING, COMMISSIONING AND START-UP	Document No.	Rev	
		Sheet 39 of 117		

- f) Measure cable resistance for grounding continuity and grounding resistance of ground rods, record data and submit the rest result reports to OWNER prior to commissioning of the installation.
- g) Check cables are in proper trenches and ground rods at their location.
- h) Perform all test; witnessed by OWNER'S REPRESENTATIVES of the founding installation including the provision of all OWNER approved testing equipment and measuring devices.

2.19 Miscellaneous Electrical equipment

2.20 Earth resistance testing including earth resistance rods for grounding, continuity of grounding, installation resistance testing for electrical cables and HL-POT testing for electrical cables.

2.21 Elevator

2.22 LSTK CONTRACTOR shall install the fire alarm including sensors, cabling, local panels, mimic panels and host system. In accordance with:



- Project engineering specification and codes and standards.
- Cabling between panel and detectors, alarms, switches etc. as described above.
- Installation of all junction / terminal boxes, cable terminations and connections, supporting brackets for cabling as described above.

3.0 TESTING AND COMMISSIONING

Testing and commissioning consist of the complete testing prior to commissioning, including provision of required testing apparatus and testing documents as requested and as specified in the testing specifications.

- All test results shall be recorded on the test form and submitted to OWNER. Each test record shall include. date of test, ambient temperature, climatic conditions, instruments used with serial numbers, names of test personnel and witnesses, identifications of equipment, ground electrode or circuit tested.
- Testing shall be scheduled at least 24 hours in advance and OWNER is to be notified by LSTK CONTRACTOR. LSTK CONTRACTOR will notify all necessary interested parties including manufacturer's representatives.

High potential tests shall not be repeated without authorization by OWNER.



	EMERGENCY DIESEL GENERATORS PACKAGE TALCHER FERTILIZERS LIMITED CONSTRUCTION/ERECTION, PRE-COMMISSIONING, COMMISSIONING AND START-UP	PC183/E/4022/SecVI-5.0	0	
		Document No.	Rev	
		Sheet 40 of 117		

4.0 **DRAWINGS AND DOCUMENTS**

4.1 LSTK CONTRACTOR will carry out all construction and any required erection activities directly from the AFC construction drawings and specifications.

4.2 LSTK CONTRACTOR shall promptly submit reports of each and every test or inspection.

4.3 For more details LSTK CONTRACTOR shall follow **Electrical design philosophy elsewhere mentioned in ITB.**

	EMERGENCY DIESEL GENERATORS PACKAGE TALCHER FERTILIZERS LIMITED	PC183/E/4022/SecVI-5.0	0	
	CONSTRUCTION/ERECTION, PRE-COMMISSIONING, COMMISSIONING AND START-UP	Document No.	Rev	
		Sheet 41 of 117		

ANNEXURE- 7 – 2D



INSTRUMENTATION WORK

1.0 GENERAL

- 1.1 Instrumentation symbols and identification of functions shall be based on the current edition of ISA S5.1.
- 1.2 Specifications for instruments and items of control equipment are shown on data sheets to be issued as they become available.
- 1.3 All materials and connections for control valves, relief valves, level controllers and similar equipment shall comply with applicable requirements for valves and fittings as noted in the piping specification.
- 1.4 LSTK CONTRACTOR shall install all shim plates, fixing material such as but not limited to anchors, red heads, etc.
- 1.5 LSTK CONTRACTOR shall install all instrument equipment tag plates.

2.0 FIELD INSTRUMENT INSPECTION AND CALIBRATION AND INSTALLATION

- 2.1.1 This item covers all activities and supply of all materials to import calibration of instruments. It includes, but is not limited to, the following:
- 2.1.1 Provision of all tools, equipment and consumables used in the course of the work.
- Calibration of instruments and provision of all necessary test equipment gauges, materials and ancillary items. All necessary testing instruments to be used must be certified by Govt. recognized testing laboratories.
 - Check orifice plates and control valves.
 - Protection of instruments to maintain cleanliness at all times.
 - Mark instrument to indicate status of calibration.
 - Return instruments, after calibration and checking to lay-down areas and / or stores including all packaging.
 - Pressure and leak test including the provision of all necessary test equipment gauges materials and ancillary items.

	EMERGENCY DIESEL GENERATORS PACKAGE TALCHER FERTILIZERS LIMITED	PC183/E/4022/SecVI-5.0	0	
	CONSTRUCTION/ERECTION, PRE-COMMISSIONING, COMMISSIONING AND START-UP	Document No.	Rev	
		Sheet 42 of 117		

Note: The calibration of all instruments within the packages is also the responsibility of LSTK Contractor.

2.1.2 LSTK CONTRACTOR shall install all instruments as listed in the instrument index and further per the relevant installation specifications, documents and drawings.

2.1.3 Field instrument installation includes, but is not limited to:



Mounting of instruments and related equipment, supports protection boxes, manifolds, junction boxes, nameplates, etc.

Installation of measuring elements (probes, sensors, detectors, etc) including their auxiliaries as required (thermo wells, supports, valves, etc.) unless done by others

Installation of on-line instruments (by piping)

The following is a typical list of on-line instruments:

- Safety blow down valves.
- Control valves (all types)
- Motor - operated valves.
- Safety shut - down valves (including solenoid valves).
- Safety / relief valves.
- Pressure / vacuum relief valves.
- Self - regulating valves.
- Level gauges.
- Level displacer chambers.
- Orifice assemblies.
- Orifice plates.
- Venturies.
- Turbine meters, annubars, magnetic flow meter.
- Positive displacement meters.



	EMERGENCY DIESEL GENERATORS PACKAGE TALCHER FERTILIZERS LIMITED	PC183/E/4022/SecVI-5.0	0	
	CONSTRUCTION/ERECTION, PRE-COMMISSIONING, COMMISSIONING AND START-UP	Document No.	Rev	
		Sheet 43 of 117		

- Variable area meters (rotameters)
- Stilling Wells.
- Thermo wells and etc.
- Installation of process connections, impulse lines and capillaries.
- Installation of purge and flushing supply tubing, filter blocks and rotameters.
- Installation of air supply lines.
- Supply and installation of instrument nameplates for field instruments.



2.2 Cable, Supports and Fixing Wire pins, Conduit

LSTK CONTRACTOR shall use for cable installation for indoor and outdoor use the materials such as tubing, cable trays, etc. as called in the specifications.

- 2.2.1 Cable tray ladder rack and tubing systems shall be installed to ensure electrical continuity throughout the run and such that water cannot collect or remain in any part of the system. Cable tray shall be laid as per cable tray lay out drawing and as required to install cables. Required supporting shall be in LSTK CONTRACTOR. No cable or cable portion shall be laid without cable tray.
- 2.2.2 Pulling of the cables into the trenches, through culverts, protection sleeves and cable ducts as per cable supplier installation instructions and layout drawings, cable lists, trench sections and reel schedules.
- 2.2.3 Installation of the cable separation tiles, if specified.
- 2.2.4 Coil up and clearly designate the final destination of the cable ends, especially if cables have to be continued their routing underground or overhead via cable tray or otherwise to their final destination at a later date.
- 2.2.5 Installation of the sealing shrouds to avoid water ingress after cable cutting.
- 2.2.6 Installation of the cable markers stamped with cable number by LSTK CONTRACTOR as per cable list.
- 2.2.7 Installation of cable splicing if required.
- 2.2.8 Return of the cable drums to the storage area including clear markup of the cable length left on the reels of cable drums that are not empty.

	EMERGENCY DIESEL GENERATORS PACKAGE TALCHER FERTILIZERS LIMITED	PC183/E/4022/SecVI-5.0	0	
	CONSTRUCTION/ERECTION, PRE-COMMISSIONING, COMMISSIONING AND START-UP	Document No.	Rev	
		Sheet 44 of 117		

- 2.2.9 Check if cables are spaced as specified.
- 2.2.10 Measure cable resistance and cable insulation, record data and submit the test result reports prior to commissioning of installation.
- 2.2.11 Check whether all cables are installed in the proper trenches/ cable trays.
- 2.2.12 Perform all tests, witnessed by OWNER of the underground cable installation including the provision of the OWNER'S approved testing equipment and measuring devices. However, it is recommended to use only overhead cable tray for instrumentation cable installation.
- 2.2.13 Record of actual installed cable lengths and location of cable splices.
- 2.2.14 where cables required to be installed through or across the edges of tray or other metal work the edge of the lips shall be smoothed painted and lined with a protective sleeving to avoid cable damage.
- 2.2.15 Supporting steelwork shall be fabricated and installed by LSTK CONTRACTOR. The material shall be primed in accordance with the painting specification by LSTK CONTRACTOR.
- 2.2.16 Storage and handling of cable before and during installation shall be carried out with due regard to manufacturer's recommendations. Cable drums shall be rotated only in the direction indicated by drum markings, and open ends of cables are to be effectively sealed immediately after cutting to prevent the ingress of moisture.
- 2.2.17 At all times, the utmost care shall be exercised to avoid damaging the protective sheathing to cable or of causing excessive bending or twisting which may result in damage to core insulation, sheaths armor and so on.
- 2.2.18 The bending radius of a cable either during or after installation shall not be less than manufacturer's recommended minimum.
- 2.2.19 Cables shall be run in continuous unbroken lengths and joints shall not be permitted.
- 2.2.20 Cables installed above ground shall be routed to avoid high-risk areas, e.g. high fire risk areas, and those areas where accidental leakage or spillage may occur and cause damage to cables and supports.
- 2.2.21 During installation, the ends of cables shall temporarily be protected using compound, tape, heat shrink seals or similar approved methods to avoid damage or entry or moisture until they are permanently terminated.
- 2.2.22 Pre-cast concrete members should not be drilled for any reason. Fixing shall always be by means of clamping brackets in the most efficient way and in consultation with OWNER.

	EMERGENCY DIESEL GENERATORS PACKAGE TALCHER FERTILIZERS LIMITED	PC183/E/4022/SecVI-5.0	0	
	CONSTRUCTION/ERECTION, PRE-COMMISSIONING, COMMISSIONING AND START-UP	Document No.	Rev	
		Sheet 45 of 117		

2.2.23 Under no circumstances shall welding be carried out to any process plant equipment, vessels, pipelines, or structures or to any protected surface unless specifically indicated on the drawings and documentation and then in strict accordance with a procedure subject to Approval of OWNER.

2.2.24 Fixings to the above shall normally be made where brackets and so on, have already been provided or when agreed by the use of purpose built clamps.

2.2.25 On trays horizontal cable runs shall be fastened with aluminum strip at every 1200 mm, vertical cable runs every 600 mm.

2.2.26 Grouping

The cables employed to convey electricity shall be grouped according to the signal kinds. The main group kinds are but not limited to the followings

- a) Intrinsically safe signals.
- b) Signal cables not intrinsically safe.
- c) Instruments power supply cables.
- d) Coaxial cables or telephone cables used as serial data buses.
- e) Analog input/output signals, Digital input signals
- f) Digital output signals
- g) Inter-Panel cable between electrical MCC room and instrumentation system



2.2.27 All cable trays, ladders, tubing and supports and fixing material for indoor and outdoor use shall be installed by LSTK CONTRACTOR.

2.2.28 All cables shall always be installed and connected in such a way that no forces can act on terminals. Further, all instrument and power supply cables inside and outside buildings shall be installed in accordance with both cable lists and drawings by LSTK CONTRACTOR.

Carbon steel coated cable stub ups shall be installed by LSTK CONTRACTOR for all cables from sand trenches to 500 mm above ground, in accordance with electrical connection detail drawings.

2.2.29 Conduit system

Single pair cables shall be used to connect field mounted instruments to local junction boxes. Single cables shall be armoured type laid laid open cable trays, However any unarmoured type cable shall be laid in galvanized carbon steel / aluminium pipes with open ends or on closed cable trays. In order not to damage the cable, a plastic annular cap shall cover the pipe end.

	EMERGENCY DIESEL GENERATORS PACKAGE TALCHER FERTILIZERS LIMITED CONSTRUCTION/ERECTION, PRE-COMMISSIONING, COMMISSIONING AND START-UP	PC183/E/4022/SecVI-5.0	0	
		Document No.	Rev	
		Sheet 46 of 117		

Multipair cables shall be used to connect above said local junction boxes to the control room. Multipair cables shall be armoured type and shall run over head in closed cable trays / ladders supported on the pipe racks.

2.2.30 **Wire Pins**

All stranded cable conductors shall be fitted with crimped taper pins (bootless type), amp (or equivalent) and all screens with lugs. Installation of all amp wire pins and screen lugs by LSTK CONTRACTOR.

Further, in general, all standby conductors shall be wired to terminals.

2.2.31 **Cable Marking**

All instrument cables, conductors and the instrument screen/earth wires shall be tagged on both sides in accordance with the instrument connection list for local and central control room signals by LSTK CONTRACTOR.

2.2.31a Cross ferruling shall be used for wire termination at each end.

2.2.32 **Cable Entry Sealing**

- **General**

After installation of all cables and on direction of OWNER, LSTK CONTRACTOR shall seal off all cable entries and passages.

- **Outside walls**

All cable entries in outside walls and below grade level shall be watertight sealed. Method of sealing shall be supplied by LSTK CONTRACTOR.

- **Separation walls**

All cable entries in separation walls of buildings shall be sealed with a fire resistant sealing as described hereafter.



- **Control Room Floors**

All cable and cabinet entries in floors shall be sealed with polyurethane foam.

- **Fire - resistant sealing**

All fire resistant sealing shall be class H-30.

Small openings in walls shall be sealed with CSD –F (or equal) in luminescent foam.

	EMERGENCY DIESEL GENERATORS PACKAGE TALCHER FERTILIZERS LIMITED	PC183/E/4022/SecVI-5.0	0	
	CONSTRUCTION/ERECTION, PRE-COMMISSIONING, COMMISSIONING AND START-UP	Document No.	Rev	
		Sheet 47 of 117		

Large openings in walls and between computer floor and cable basement shall be sealed by inserting CSD-F (or equal) in luminescent plates under between and above the cables. The remaining openings shall be sealed with CSD-F (or equal) in luminescent foam.

2.3 Alarm Systems

DELETED

2.4 Analyzers Installation



LSTK CONTRACTOR shall install all analyzers and sampling conditioning systems in the analyzer house (analyzer house shall be air conditioner and shall be design and constructed by LSTK Contractor) as well as in the field consisting of, but not limited to:

- Installation of all vents and drains from analyzers.
- Installation of calibration gas bottles as well as regulators and connecting tubing, as required.
- Installation of required tubing and cabling in cable tray from analyzer house to tapping point.
- Cable installation between Analyzer panel to DCS/ESD/other control system panel for hardwire signal communication.

3.0 LOCAL PANELS

LSTK CONTRACTOR shall install local panels, consisting of, but not limited to:

- a) Mounting, aligning and fixing to the foundation or steelwork. Uncoil, install and terminate underground cable ends. Install and terminate all aboveground cable to / from panels.
- b) Install and connect air supply and air signal piping and tubing to 'from panels.
- c) Install cabling and connect alarm horns.
- d) Identification / tagging of all equipment, terminals, cables and tubing which is not installed by panel vendor. Tag plates to be installed by LSTK CONTRACTOR.
- e) Installation of brackets / supports for cable, etc. and installation material as required to complete the installation.
- f) Cable installation between Local panel to DCS/ESD/other control system panel for hardwire signal communication.

	EMERGENCY DIESEL GENERATORS PACKAGE TALCHER FERTILIZERS LIMITED	PC183/E/4022/SecVI-5.0	0	
	CONSTRUCTION/ERECTION, PRE-COMMISSIONING, COMMISSIONING AND START-UP	Document No.	Rev	
		Sheet 48 of 117		

4.0 **TERMINATION OF CONTROL CABLES FROM THE LV SWITCH ROOM**

The control cables running from the switch room shall be installed and connected in the marshaling cabinet by LSTK CONTRACTOR.

5.0 **CONTROL BUILDING INSTRUMENT INSTALLATION**

5.1 LSTK CONTRACTOR shall install all control building instrumentation in accordance with the relevant installation specifications and drawings.

6.0 **CABINETS AND CONSOLES**

6.1.1 LSTK CONTRACTOR shall install align and anchor all equipment cabinets and consoles in accordance with design drawings and seller's installation instructions.

6.1.2 The false floor shall be completely installed by LSTK CONTRACTOR.

All panels, cabinets, tables, boxes, computers etc. located on the instrument equipment layout shall be place and installed by LSTK CONTRACTOR.

6.1.3 Where cable passage is required according to installation drawings, LSTK CONTRACTOR to indicate locations of holes and passages.

6.1.4 FCS/ESD/PLC cabinets and data base unit:

These groups / cabinets shall be installed in place and bolted together by LSTK CONTRACTOR.



Internal wiring / cabling and / or connections between these groups of cabinets shall be done by LSTK CONTRACTOR in accordance with the instructions of the system vendor's representative.

6.1.5 **FCS Consoles**

The consoles shall be installed in place and bolted together by LSTK CONTRACTOR, including installation of special table with peripherals.

Internal wiring and cabling and/or connections between consoles shall be done by LSTK CONTRACTOR in accordance with the instructions of the system vendor's representative who will be present during these operations.

6.1.6 Communication racks with the same work description as specified elsewhere in Tender documents.

	EMERGENCY DIESEL GENERATORS PACKAGE TALCHER FERTILIZERS LIMITED	PC183/E/4022/SecVI-5.0	0	
	CONSTRUCTION/ERECTION, PRE-COMMISSIONING, COMMISSIONING AND START-UP	Document No.	Rev	
		Sheet 49 of 117		

6.1.7 Main processor cabinets (data base units) with the same work description as as specified elsewhere in Tender documents.

6.1.8 **Marshaling Cabinets**

Cabinets shall be installed in place and bolted together by LSTK CONTRACTOR.

Cross wiring between these assembled sections shall be done by LSTK CONTRACTOR.

6.1.9 DELETED

6.2 Handling and installation. Termination and Connection of Cabling

Cables entering instrument room are installed under false floor and laid in cable tray. These cable shall be handled, cut to length, stripped and after installation of the cabinets be terminated and connected by LSTK CONTRACTOR.

LSTK CONTRACTOR shall leave slack in the cables and provide markings.

6.3 **Installation of System Cables**

LSTK CONTRACTOR shall install, plug in and support all system cables. Cable supporting rail in cabinets is installed by cabinet / console vendors, but in any case LSTK CONTRACTOR is responsible.

- System cable shall be installed by LSTK CONTRACTOR under false floor in auxiliary room. System cables are covered by instrument cable list.

6.4 **Conduits Cable Tray / Trucking. Support Frames and Brackets**



All cable trays, cable trucking, supports / brackets, etc. if required , shall be installed by LSTK CONTRACTOR. For cable tray installation see respective part.

6.5 **Auxiliary Cable Installation and Termination.**

LSTK CONTRACTOR shall install, terminate, support and connect all auxiliary cables.

Auxiliary cables are all cables covered by instrument cable list and instrument cable layout for control room.

LSTK CONTRACTOR shall open / remove and close parts of the false floor as required for cable installation.

	EMERGENCY DIESEL GENERATORS PACKAGE TALCHER FERTILIZERS LIMITED	PC183/E/4022/SecVI-5.0	0	
	CONSTRUCTION/ERECTION, PRE-COMMISSIONING, COMMISSIONING AND START-UP	Document No.	Rev	
		Sheet 50 of 117		

6.6 **Communication Cables**

LSTK CONTRACTOR shall install and support communication cables. The connection of the cables in the consoles and cabinets shall be done by LSTK CONTRACTOR, under direct supervision of system vendor. LSTK CONTRACTOR shall open / remove and close parts of the false floor as required for cable installation. Communication cables are listed on instrument cable layout for control room and the system cable list.

6.7 **Power Supply Cabling**

LSTK CONTRACTOR shall install, terminate and connect all power supply cables between power distribution boards and cabinets, consoles, printers and other instrument equipment when listed on the power supply list

6.8 **Earthing System**

LSTK CONTRACTOR shall install and connect the insulated earthing cabling / wiring from the earth buses to the cabinets, consoles and all other instrument equipment.

All cabinets and consoles shall be fitted with earthing bus bars and earthing connection bolts by the vendors and under supervision of LSTK CONTRACTOR.

LSTK CONTRACTOR shall install utility, shield and dedicated earth (clean earth) cabling and connections including tags at both ends.

LSTK CONTRACTOR shall check and test earthing system in accordance with relevant documents.



LSTK CONTRACTOR shall provide required nos. of earth pit. Earth pit shall be separate for electrical and instrument requirement.

7.0 **LIFTING**



7.1 Major instrument equipment shall be rigged from points designated or suitable to accept rigging. When available, LSTK CONTRACTOR shall utilize lugs on equipment.

7.2 When establishing hoisting loads, riggings plans and crane capacities, LSTK CONTRACTOR shall adhere to the requirements and instructions as defined in the specifications and as instructed by OWNER. Any equipment handling machine i.e. Hydra, cranes etc. required at that time, same shall be provided by LSTK contractor.

8.0 **TESTING AND PRECOMMISSIONING (FUNCTION TEST)**

	EMERGENCY DIESEL GENERATORS PACKAGE TALCHER FERTILIZERS LIMITED	PC183/E/4022/SecVI-5.0	0	
	CONSTRUCTION/ERECTION, PRE-COMMISSIONING, COMMISSIONING AND START-UP	Document No.	Rev	
		Sheet 51 of 117		

- 8.1 Testing and pre-commissioning consist of the complete testing and pre-commissioning prior to commissioning, including provision of required testing apparatus and testing documents, comprising, but not limited to:
- 8.1.1 Check for completion and conformance to specifications.
- 8.1.2 Check the accessibility of all instruments and components for field adjustments, routine maintenance and removal for overhaul, and relocate as necessary.
- 8.1.3 Perform pressure test on all air sub headers as required by the line specifications.
- 8.1.4 Clean all instrument air sub headers, transmission tubing and control tubing by blowing with dry, filtered air prior to connection of instrument components
- 8.1.5 Leak test pneumatic transmission and control tubing, using an approved method acceptable to OWNER
- 8.1.6 Perform hydrostatic or, where appropriate, pneumatic pressure tests on all instrument process piping, as required by the respective line specifications. Drain and below free of water, as necessary after test.
- 8.1.7 Check continuity and identification of transmission and control systems for each instrument to ensure proper hookup. Perform megger and continuity tests for instrument electrical wiring. Check correct source of power, polarity and earthing (take into account intrinsically safe technology of this procedure).
- 8.1.8 Check the bore of the orifice plates and flow direction during and after installation.
- 8.1.9 Check (on/off valve and) control valves for direction of flow and proper operation, e.g. travel, action with air failure, etc.
- 8.1.10 Calibrate all instruments (including the instruments in the fire and gas system) and synchronize transmitter and receiver readings for each instrument loop. Check the orifice plates and flow nozzles. Set air pressure regulators.
- 8.1.11 Install pressure and temperature gauges after line flushing.
- 8.2 Check fuses, perform voltage checks and energize all electrically powered instruments, alarm and shutdown system, etc. Maintain power supply.
- 8.3 Set pneumatic and electronic type switches and local control by simulation of input signals.
- 8.4 Check thermocouples and resistance thermometer circuits from element to measuring instrument by simulation.

	EMERGENCY DIESEL GENERATORS PACKAGE TALCHER FERTILIZERS LIMITED	PC183/E/4022/SecVI-5.0	0	
	CONSTRUCTION/ERECTION, PRE-COMMISSIONING, COMMISSIONING AND START-UP	Document No.	Rev	
		Sheet 52 of 117		

- 8.5 Check and adjust calibration of all other field and panel mounted instruments.
- 8.6 Complete loop functional test of all instruments, including the instruments in all package units and in the fire and gas system. Functionally test complete control loops alarm and shutdown systems and partial process sequence, etc., to verify capability to measure, operate and stroke final control elements in the direction and manner required by the process application. All test results shall be recorded and submitted to OWNER. Each test record shall include date of test, ambient temperature, climatic conditions, instruments used with serial numbers, names of test personnel and witnesses, identification of equipment, ground electrode or circuit tested.

Testing shall be scheduled at least 24 hours in advance and OWNER is to be notified by LSTK CONTRACTOR. LSTK CONTRACTOR shall advise OWNER prior to testing, of make, type and accuracy of test equipment used for above-mentioned items. All required test certificates should be of a recent date not exceeding 6 months.

9.0 PAINTING

Surface preparation and application of all required paint layers shall be executed in accordance with paint specifications and related standards.

10.0 WELDING

LSTK CONTRACTOR shall perform welding in accordance with the normal accepted industrial standards.

11.0 MECHANICAL COMPLETION

LSTK CONTRACTOR shall advise OWNER in writing when erection is completed.

Mechanical completion date shall be the date when the activities have been accomplished by LSTK CONTRACTOR as dictated by the construction schedule, which shall be submitted by LSTK CONTRACTOR and approved by OWNER on due time.



12.0 QUALITY ASSURANCE, QUALITY CONTROL, INSPECTION, CALIBRATION TEST AND MATERIAL CERTIFICATES

12.1 LSTK CONTRACTOR shall perform quality control, inspect, calibrate required testing, pre-commissioning and supply certificates.

12.2 LSTK CONTRACTOR shall submit reports of each and every test or inspection within three (3) days after actual test or inspection is made.



12.3 Calibration and Testing.

12.3.1 Calibration and testing to be executed by LSTK CONTRACTOR in accordance with respective specifications.

	EMERGENCY DIESEL GENERATORS PACKAGE TALCHER FERTILIZERS LIMITED	PC183/E/4022/SecVI-5.0	0	
	CONSTRUCTION/ERECTION, PRE-COMMISSIONING, COMMISSIONING AND START-UP	Document No.	Rev	
		Sheet 53 of 117		

Local instruments such as transmitters, converters, receivers and so on, will be preset by bench testing by LSTK CONTRACTOR in accordance with the specifications before installation on the process, so that no new settings will be necessary for loop acceptance tests.

- 12.3.2 LSTK CONTRACTOR shall inspect all materials up on receipt for damage and completeness. In case of damage incomplete material, LSTK CONTRACTOR shall modify/replace with new one and immediately inform OWNER.
- 12.3.3 LSTK CONTRACTOR shall carry out all tests included in this paragraph shall fill out the installation checklists and shall submit all required test certificates and documentation as required.
- 12.3.4 All tools and test gear necessary to carry out described tests shall be provided by LSTK CONTRACTOR.
- 12.3.5 Inspection and testing shall be phased with construction and installation in such a manner as to involve the minimum necessary concentration of effort and manpower and the minimum loss of time in reaching the pre-commissioning stage.
- 12.3.6 All inspection and testing shall be witnessed and approved by OWNER / authorized representative.
- 12.3.7 LSTK CONTRACTOR shall be responsible for the complete loop continuity check of the field and control room installation, including the parts of the package units, which have been connected by others.
- 12.3.8 OWNER reserves the rights whenever distinguished package Plant(s)/Unit(s) vendor's representative to be present at site LSTK CONTRACTOR shall be responsible to arrange this WORK.
- 12.3.9 LSTK CONTRACTOR shall be responsible for the loop continuity checks from the marshaling cabinets or direct connected cabinet cables in the control room (termination point of underground multi core cable). The loop continuity checks shall be performed on a complete loop, including all parts of the loop as indicated on the instrument loop diagrams (ILD'S).
- 12.3.10 The communication equipment between field and control room building and/ or other buildings shall be the responsibility of LSTK CONTRACTOR.
- 12.3.11 Only complete loops shall be accepted, signed by OWNER after all calibration / function checks have been demonstrated successfully completed and recorded.
- 12.3.12 For all package units and systems supplied by LSTK CONTRACTOR, installed or partly installed and connected by LSTK CONTRACTOR.

	EMERGENCY DIESEL GENERATORS PACKAGE TALCHER FERTILIZERS LIMITED	PC183/E/4022/SecVI-5.0	0	
	CONSTRUCTION/ERECTION, PRE-COMMISSIONING, COMMISSIONING AND START-UP	Document No.	Rev	
		Sheet 54 of 117		

LSTK CONTRACTOR shall perform a normal wiring and loop check of signals and supplies to and from these systems.



The following systems apply:

- Analyzer system
- Bentley Nevada system
- Flow metering system
- Fire, smoke and gas detection system
- Tank gauging
- FCS / ESD / PIC system, etc.
- Machine monitoring system
- Public address system (PA system)

For more details LSTK CONTRACTOR shall follow **Instrument design philosophy elsewhere mentioned in ITB.**

13.0 **Miscellaneous**

LSTK CONTRACTOR shall remove all waste and debris from the SITE.

	EMERGENCY DIESEL GENERATORS PACKAGE TALCHER FERTILIZERS LIMITED	PC183/E/4022/SecVI-5.0	0	
	CONSTRUCTION/ERECTION, PRE-COMMISSIONING, COMMISSIONING AND START-UP	Document No.	Rev	
		Sheet 55 of 117		

ANNEXURE- 7 – 2E

INSULATION WORK (IF APPLICABLE)

1.0 GENERAL



1.1 SCOPE

This standard covers the requirement for supply and application of materials for thermal insulation of equipment, piping and other items.

1.2 REFERENCE STANDARDS

The design shall be in accordance with established codes, sound engineering practices and shall conform to the statutory regulations applicable to the country. The main codes, standards and statutory regulations considered as minimum requirements are as follows:- (Latest revision of these shall be followed)

IS 14164	Code of Practice for Industrial Application and finishing of thermal insulation material at temperature -80 ⁰ C and up to 750 ⁰ C.
IS 737	Wrought aluminum and aluminum alloys, sheet, strip
IS 1254	Specification for corrugated aluminum sheet
IS 1322	Bitumen felts for waterproofing and damp proofing
IS 3069	Glossary of terms, symbols and units relating to thermal insulation materials.
IS 8183	Specifications for bonded mineral wool.
IS 9743	Thermal insulation finishing cements
IS 12436	Specification for Preformed Rigid Poly-urethane (PUF) and Poly-isocyanurate (PIR) Foams for Thermal Insulation
IS 13205	Code of practice for the application of polyurethane insulation by the in-situ pouring method.
ASTM C921	Standard Practice for Determining the Properties of Jacketing Materials for Thermal Insulation.
ASTM C1029	Specification for Spray-Applied Rigid Cellular Polyurethane Thermal Insulation
ASTM C1696-16	Standard Guide for Industrial Thermal Insulation Systems
ASTM C411	Standard Test Method for Hot-Surface Performance of High - Temperature Thermal Insulation

	EMERGENCY DIESEL GENERATORS PACKAGE TALCHER FERTILIZERS LIMITED	PC183/E/4022/SecVI-5.0	0	
	CONSTRUCTION/ERECTION, PRE-COMMISSIONING, COMMISSIONING AND START-UP	Document No.	Rev	
		Sheet 56 of 117		

ASTM C450	Practice for Fabrication of Thermal Insulating Fitting Covers for NPS Piping, and Vessel Lagging
ASTM C871	Test Methods for Chemical Analysis of Thermal Insulation Materials for Leachable Chloride, Fluoride, Silicate, and Sodium Ions
ASTM C1338	Standard Test Method for Determining Fungi Resistance of Insulation Materials and Facings.
ASTM C1055	Guide for Heated System Surface Conditions that Produce Contact Burn Injuries
ASTM C1139	Specification for Fibrous Glass Thermal Insulation and Sound Absorbing Blanket and Board
ASTM D1622	Test Method for Apparent Density of Rigid Cellular Plastics
ASTM C680	Standard Practice for Heat Loss or Gain and Surface Temp.

1.3 **Deviations:**

Should unforeseen difficulties arise to comply with requirements of this standard.

Alternative material and application techniques superior to the requirements of this standard be submitted with complete details for approval of owner.

In case of any conflict / deviations amongst various documents, the order of precedence shall be as follows:

1. Statutory regulations.
2. Job specifications.
3. Engineering design basis.
4. Standard specification.

1.4 **LIMITATIONS**



Temperature Limits.

This standard deals with insulation applied externally on piping equipments etc. as per the table below:-

Maximum Operating Temperature	Type of Insulation
60 ⁰ C to 750 ⁰ C for C.S., A.S. & S.S.	HOT
- 180 ⁰ C to 20 ⁰ C	COLD

1.5 **THICKNESS DESIGN BASIS**

Thickness calculation method as per procedure given in ASTM C-680

	EMERGENCY DIESEL GENERATORS PACKAGE TALCHER FERTILIZERS LIMITED	PC183/E/4022/SecVI-5.0	0	
		Document No.	Rev	
	CONSTRUCTION/ERECTION, PRE-COMMISSIONING, COMMISSIONING AND START-UP		Sheet 57 of 117	

1. Hot Insulation

Design Ambient Temperature	: 35°C
Design Surface Temperature	: 45°C
Permissible Heat Loss	: 100 kcal./m ² hr.
Permissible Wind Velocity Outside	: 1 m/sec
Permissible Wind Velocity Inside	: 0.25 m/sec

2. Cold Insulation

Design Ambient Temperature	: 35°C
Design Surface Temperature	: 2 °C below ambient/ 0.5 Deg C above the Dew Point
Permissible Heat Gain	: 10-12 kcal/m ² hr
Relative Humidity	: 85%
Permissible Wind Velocity Outside	: 1 m/sec.
Permissible Wind Velocity Inside	: 0.25 m/sec.

1.6 GENERAL REQUIREMENTS

1.6.1 Information to be supplied

- Material of construction / dimension of equipments / pipes required to be insulated.
- Temperature
- Location of equipment (Indoor/Outdoor/Elevn.)
- Requirement of removable box type insulation if any
- Special requirements if any regarding type of insulation material and other properties.
- These information shall be supplied in form of insulation schedule.
- Design calculations, drawings and insulation material schedule.
- Material Test certificate's.
- Insulation works execution schedule.
- Detailed procedure for all types of execution works.
- Bill of Quantities, Initial material take-off, final material take off and material requisition.
- QA/QC plan.



1.6.2 STORAGE OF MATERIAL

Insulation material shall at no time be stacked directly on the ground; instead it will be stored at a level higher than ground level. It should not only be covered by tarpaulin but other effective protections against weather are also to be provided. The contractor shall provide a properly covered storage to the satisfaction of engineer-in-charge (Refer IS: 10556).

1.6.3 HYDROSTATIC TEST FOR PIPES

Before taking up insulation job on piping or vessels it shall be ensured that hydrostatic test of the concerned equipment / piping is completed. Where it is felt necessary to take up the insulation job before such testing are performed all welded and mechanical joints shall be left un-insulated for a length of at least 150mm on either side of the joint.

1.6.4 PROTECTION OF INCOMPLETE JOBS

	EMERGENCY DIESEL GENERATORS PACKAGE TALCHER FERTILIZERS LIMITED	PC183/E/4022/SecVI-5.0	0	
	CONSTRUCTION/ERECTION, PRE-COMMISSIONING, COMMISSIONING AND START-UP	Document No.	Rev	
		Sheet 58 of 117		

Any part of insulation job which is not provided with final weather proofing will be adequately protected by means of tarpaulins and other aids. After the day's work similar protection should be provided for the partially completed jobs to be continued the next day to avoid any absorption of rain / moisture during the night.

2.0 INSULATION SUPPORTS (CLEATS) TO BE PROVIDED BY EQUIPMENT SUPPLIER

Suitable supports (cleats) in the form of rings, lugs, studs or pins shall be provided on equipment by equipment supplier, however should any additional supports or anchorage be felt necessary for insulation works, the same shall be also considered in LTKS's scope, including all allied work necessary for the same. These will be installed by the contractor free of any extra cost. Owner shall be informed about the same in advance, so also design/drawings shall be updated accordingly.

3.0 MATERIAL REQUIREMENTS

3.1 INSULATION MATERIALS

3.1.1 General

Whenever reference to any Standard is made it is presumed that the latest revision as on date should be considered unless otherwise specified.



3.1.2 Specification and other requirements

Specification and other requirements will be as per below mentioned table:-

Hot Insulation:

For operating temperature Upto 400 deg.C,	Rockwool Mattress of density 120 kg/m ³ conforming to IS:8183.
For operating temperature 401-450 deg.C,	Rockwool Mattress of density 150 kg/m ³ conforming to IS:8183.
For operating temperature 451-500 deg.C,	1 st layer insulation shall be 25mm Ceramic Fibre Blanket of density 128 kg/m ³ conforming to IS :15402 and balance layers with Rockwool Mattress of density 150 kg/m ³ conforming to IS:8183.
For operating temperature 501-550 deg.C	1 st layer insulation shall be 50mm Ceramic Fibre Blanket of density 128 kg/m ³ conforming to IS :15402 and balance layers with Rockwool Mattress of density 150 kg/m ³ conforming to IS:8183.
For operating temperature 551-600 deg.C,	1 st layer insulation shall be 75mm Ceramic Fibre Blanket of density 128 kg/m ³ conforming to IS :15402 and balance layers with Rockwool Mattress of density 150 kg/m ³ conforming to IS:8183.

Bands/Wires for securing insulation shall be of ASTM 8209 Alloy 3003 H16 or 18-737 designation 31000 (old NS3) condition H3 or 18/8 Stainless steel.

	EMERGENCY DIESEL GENERATORS PACKAGE TALCHER FERTILIZERS LIMITED	PC183/E/4022/SecVI-5.0	0	
	CONSTRUCTION/ERECTION, PRE-COMMISSIONING, COMMISSIONING AND START-UP	Document No.	Rev	
		Sheet 59 of 117		

For securing cladding on insulation on piping, aluminium band 12mm (min) X 24 SWG thick shall be used. For securing cladding on insulation on equipment, aluminium band 20mm wide X 24 SWG shall be used.

Other insulating materials may be used provided they have the same or better properties and durability aspects.

Insulation thickness of insulating materials shall be based on design calculation of thermal conductivity, insulation class, etc. Same shall be submitted to the Owner with necessary design calculations, drawings, test certificates and durability parameters.

For Valves, Turbines & Compressors Insulation



Prefabricated factory made Ceramic Fibre pad to be used made out of Ceramic Fibre Blanket of density 128 kg/m³ encased in high temperature resistant cloth. The minimum thickness of the pad shall be –

1. 0 Deg.C to 300 Deg.C = 25mm
2. 301 Deg.C to 400 Deg.C = 50mm
3. 401 Deg.C to 500 Deg.C = 75mm

Removable insulation for flanges and valves, like tailor made jackets or pre formed insulation boxes, shall be suitable for quick removal and reinstallation. All tailor made jackets shall fit the actual valve/flange/equipment and secure adequate overlap to incoming insulated pipes.

Technical data sheet of the Ceramic Fibre Pad is as below:

A.	Purpose/Application This Engineering specification is for Fabric jacketed supercera ceramic Fibre insulated flexible reusable covers/pad for application on pipes: pipe fittings, valves, flanges etc vessels & equipments, tubes etc in hot services.	
01	Dimension (mm)	As per drawing/sketch provided by OEM.
02	Thickness (mm)	25-100
1. Specification of Protective jacketed material		
i	Vest Cover	Liner Fibre Glass Fabric
ii	External Top Cover Fabric (for cold face)	Polymer Coated Fibre Glass fabric Temp. resistance 300 Deg. C, oil & water resistant
iii	External Bottom Cover fabric (for hot face)	High silica cloth for Temp Resistance up to 900 Deg C
2.	Specification of insulation Material	Ceramic Fibre Blanket (As per IS 15402)
i	Classification Temperature	1260 degree Celsius
ii	Thickness	25 – 100mm
iii	Bulk Density	128kg/m ³
iv	Shot content on 70 mesh (%)	<30
v	Tensile strength (KPa)	>40
vi	Mean Fibre Dia (Micron)	2-4
vii	Linear Shrinkage (%) At 1200 Deg. C for 24 Hrs	3.5

	EMERGENCY DIESEL GENERATORS PACKAGE TALCHER FERTILIZERS LIMITED	PC183/E/4022/SecVI-5.0	0	
	CONSTRUCTION/ERECTION, PRE-COMMISSIONING, COMMISSIONING AND START-UP	Document No.	Rev	
		Sheet 60 of 117		

viii	Thermal Conductivity (W/mK) Max.	1000C 0.046	2000C 0.072	3000C 0.078	5000C 0.150
ix	Chemical composition	SiO ₂ %		49-58	
		Al ₂ O ₃ %		41-48	
		ZrO ₂ %		0-7	
		FeO ₃ %		<0.1	
3	Hardware & Non Metal fastening				
i)	Buckle/Draw Stings	Stainless steel (min SS 316), High Temp Braided Chord of fibre glass			
ii)	Stic Pins	Stainless Steel (min SS 316), Pins to prevent the insulation from movement inside the cover			
iii)	Stitching	Double sewn with Teflon coated Fibre glass wrapped stainless thread. The sewing thread shall not resolve or decompose in typical chemical plant environment.			
iv)	Belting	High Temp Fabric same as used in hot face cover			
4	Other Properties				
i	Fire Resistance (As per BS 476 Part-4)	Non-Combustible			
ii	Chemical Stability/Resistance of Corrosion/water	Good			
iv	Shock Resistance	Excellent			

Rockwool Insulation shall be of water Repellent Grade and tested as per BS: 2972 for Water Absorption. Maximum water absorption is 0.5 kg/m² in 48 hours duration.

Precautions must be implemented in the design and fabrication of the insulation jackets to avoid the insulation material from sagging causing reduction of the insulation properties of the jackets.



Cold Insulation:

Insulation material and specifications for cold insulation for operating temperatures up to (-) 180°C and dual temperature (cold/hot) service where, upper temperature limit is 125°C shall be as given below for all sizes of piping/equipment:

- Polyurethane Foam

Preformed pipe section's and radial lags (for higher diameter pipe) of polyurethane foam of self-extinguishing type shall be in accordance with ASTM C591 TYPE-II Grade 2. The physical requirement of bulk density, chloride content, thermal conductivity and PH value of the material shall be as follows:

Temp. Limit Bulk density:	Upto (-)180°C & 120°C (max) 35.0 to 39.9kg/m ³
Chloride content :	20 ppm (max)
Thermal conductivity :	0.221 mw/cm°C at mean temp. 10 deg C
PH Value :	Neutral.
Closed cell content :	95% (min)

	EMERGENCY DIESEL GENERATORS PACKAGE TALCHER FERTILIZERS LIMITED	PC183/E/4022/SecVI-5.0	0	
	CONSTRUCTION/ERECTION, PRE-COMMISSIONING, COMMISSIONING AND START-UP	Document No.	Rev	
		Sheet 61 of 117		

High density polyurethane foam block of bulk density more than 300 Kg/m³ shall be used for supports.

- Polyurethane Foam Cast-in-Situ

Cast-in-Situ Polyurethane Foam of density 42±2 kg/m³ conforming to IS: 13205 shall be used. High density polyurethane foam block of bulk density more than 300 Kg/m³ shall be used for supports.

Temp. Limit : Up to (-) 45°C and 120°C (max.)

- Polyisocynaurate

Temp. Limit : Up to (-) 180°C and 125°C (max.)

Other insulating materials may be used provided they have the same or better properties and durability aspects.

Insulation material specification/ thickness/application mentioned in this document are the minimum requirements. Insulation specification/ thickness/ application shall be based on design calculation of thermal conductivity, insulation class, relevant IS/ ASTM codes etc. Same shall be submitted to the Owner with necessary design calculations, drawings, test certificates and durability parameters. LSTK shall submit detailed material specifications, durability parameters assured, test certificates and application procedure to OWNER/ PMC approval.

3.2 AUXILIARY MATERIALS FOR CLADDING



a) Aluminium Cladding

- Horizontal Vessels

Aluminium sheet as per IS-737 (designation 31000, condition H3 for flat sheet & 31500/51300, H4 for corrugated sheets)) shall be used for cladding. Insulation on overall piping, vessel and equipment, cladding will be coated on the side in contact with insulation with 3 mil thick polysurlyn film.

Specifications for aluminium Cladding material shall be as follows:

Material	Reference Code / Standard	Thickness	Application
Aluminium sheet with applied moisture barrier of 3 mil thick Polysurlyn coating	IS : 737 / ASTM C-653	22 SWG (0.71mm)	For all piping, tanks, vessels, heat exchanger, flanges, valves, equipments etc. upto 24" outside dia
		20 SWG (0.91mm)	For piping, tanks, vessels, heat exchanger, flanges, valves etc. above 24" outside dia
Removable cover for flanges, valves etc. shall be made out of minimum 18 SWG thickness Aluminium Sheets.			

	EMERGENCY DIESEL GENERATORS PACKAGE TALCHER FERTILIZERS LIMITED	PC183/E/4022/SecVI-5.0	0	
	CONSTRUCTION/ERECTION, PRE-COMMISSIONING, COMMISSIONING AND START-UP	Document No.	Rev	
		Sheet 62 of 117		



- Vertical Vessels
Cladding material for vessels with insulation O.D. 900 mm and less shall be same as for pipes. For vessels above 900 mm insulation O.D. 22 SWG corrugated aluminium sheet as per IS-1254 or ribbed aluminium sheet 32 mm x 5 mm deep corrugations may be used.

Aluminium Foil to protect stainless surfaces in Temperature below 0 deg c shall be 0.1 mm (42 SWG) thick per ASTM 8209 alloy 3003 H16 or IS-737 designation 31000 (0ldNS3) condition H3. For securing aluminium foil on stainless steel surface 24 SWG thick x 20mm wide aluminium bands shall be used.

- b) **Screws**
Screws used with aluminium sheeting shall be of self tapping type, A No.8x12mm long cadmium plated / SS of high quality at intervals of 150mm.
- c) **S-Clips.**
Aluminium, 20x1.5mm or 25mm wide stainless steel banding bent to form a shape of "S" provide a minimum lap of 50mm.
- d) **Bands for securing cladding.**
Aluminium of dimensions 12mm width x 0.56 mm thick (24 SWG) for pipes. Stainless Steel bands Type 304, 0.4mm thick x 13mm wide for large dia pipes (above 24") and cylindrical equipment up to outside dia 900mm, 0.5mm thick x 19mm wide for cylindrical equipment above 900mm outside dia meter.
- e) **Quick release clips for removable covers.**
Suitable quick release clips will be made as shown in fig. 7 from 20Cm width x 20 SWG aluminium sheet and some fig.7 from 20mm width x 20 SWG aluminium sheet and some suitable rectangular ring.
- f) Sealant for cladding joints with Foster 95-44 /TIKI F9544.
- g) The vapour barrier mastic shall be Foster 60-38/39 /TIKI M6038/39
- h) Adhesive for cold insulation shall be Foster 81-33 /TIKI P8133
- i) Vapour Stops at pipe support location shall be Foster 90-66 /TIKI F9066
- j) **Rivets:** Aluminium 'POP' blind eye type / Stainless Steel 9.5mm long x 5mm dia meter.
- k) Filler material shall be PUF dust or mineral wool mixed with specified adhesive shall be placed lightly so as to fill irregular voids and sealant shall be Foster Foam Seal Sealer 30-45. Glass cloth to be used for vapour barrier reinforcement shall be open weave 10 mesh having glass fibre thickness of 5 mils.

Galvanised steel sheets/ Annealed galvanised steel sheets/ Galvanised colour coated sheet are strictly **PROHIBITED** for use in cladding works. Other cladding materials (except G.I.) may be used provided they have the same or better properties and durability aspects, after prior approval from Owner/PMC.

Cladding material / auxiliary material specification/ thickness/ application mentioned in this document are the minimum requirements. Cladding material/ auxiliary material specification/ thickness/ application shall be based on design calculation of thermal conductivity, insulation class, corrosion aspects, durability, relevant IS/ ASTM codes, etc. Same shall be submitted to the Owner with necessary design calculations, drawings, test certificates and durability parameters.

	EMERGENCY DIESEL GENERATORS PACKAGE TALCHER FERTILIZERS LIMITED	PC183/E/4022/SecVI-5.0	0	
	CONSTRUCTION/ERECTION, PRE-COMMISSIONING, COMMISSIONING AND START-UP	Document No.	Rev	
		Sheet 63 of 117		

LSTK shall submit material specifications, durability parameters assured, test certificates and application procedure to OWNER/PMC approval.

4.0 INSPECTION.

4.1 General

All insulation material shall be subject to inspection by owner before application. In case of doubt, Owner's representative will have the liberty to get the material tested by the contractor at any approved test laboratory. Any material not meeting specified requirement will be rejected and the rejected material shall have to be replaced by the contractor with material of specified type and quality. Insulation found to be improperly installed shall be removed and reinstalled properly by the contractor.

Contractor shall maintain detailed log of various insulation works and same shall be updated on daily basis. QA/QC checks of work done and materials shall be also registered in the daily logs. Owner will have the liberty to check the logs.

4.2 Inspection

Inspection of materials and / or installation by owner shall not relieve the contractor of his responsibility to ensure that finished insulation conform to specified requirements and is free from defects, contractor shall correct any defects due to poor workmanship. Contractor shall maintain test certificates and other relevant data from manufacturer.

4.3 Test for thickness

Test for thickness shall be carried out after application. Thickness at any point shall not be less than 2mm than the indicated designed thickness and excess thickness up to 115% of the designed thickness is permissible. .

4.4 Testing for bulk density

Testing of bulk density of the insulating materials shall be carried out before the application of insulation. This should be within $\pm 15\%$ of the specified value. Test location shall be selected by owner and its repair shall be done by contractor.

5.0 APPLICATION



5.1 General

Insulation thickness shall be as per design calculations as specified in the drawings/ insulation schedule/ specification/isometric drawings prepared for equipments/piping.

Contractor shall submit detailed calculations and procedure for different insulation works based on relevant IS / ASTM codes.

5.2 No. of Layers

When insulation thickness exceeds 75 mm, the insulation shall be applied in multi-layers with all joints staggered. Each layer will be separately secured with metallic bands/wires.

	EMERGENCY DIESEL GENERATORS PACKAGE TALCHER FERTILIZERS LIMITED	PC183/E/4022/SecVI-5.0	0	
	CONSTRUCTION/ERECTION, PRE-COMMISSIONING, COMMISSIONING AND START-UP	Document No.	Rev	
		Sheet 64 of 117		

No. of layers shall be as follows:

Insulation Thickness

Up to 75mm
76 to 150 mm
151 and above

No. of Layers (Min.)

1 Layer
2 Layers
3 Layers or more.

5.3 GENERAL REQUIREMENTS

5.3.1 Surface preparation

- Surface to be insulated shall be cleaned of all dirt. Oil loose scale etc. by wire brushing. Insulation works shall commence only after necessary clearance from QA/QC for painting works as per painting specification. All insulation shall be applied at ambient temperature and both the metal surface and insulation material shall be dry prior to application of insulation.
- The surface for cold insulation shall be then coated with a bitumen emulsion or a mastic coating.
- If the vessel is made of stainless steel, it shall be wire-brushed. with stainless steel wire brush.

5.3.2 Expansion / contraction joint

Depending on the type of insulation used the operating temperatures and nature of the material it may be necessary to provide expansion/contraction joints on vessels or pipes to prevent the insulation from rupturing/buckling when the surface expands/contracts. Joints are to be designed as per relevant IS / ASTM codes.

5.3.3 Filling of Voids

All voids, irregularities and joints shall be packed with loose insulation material/insulation cement trowelled smooth whichever is applicable.

6.0 MEASUREMENT OF INSULATION WORK.

6.1 Measurement of insulation works shall be as per IS: 14164.



7.0 GUARANTEE

- There shall be a surface temperature recording as mentioned in the Design Parameter to be performed with the help of Thermography Camera, post the line/ equipment is charged in operating conditions. The same shall be in LSTK's scope and LSTK shall give a detailed report of the same.



-The guarantee test shall be carried out when plant is fully operative.

-The surface temperature, reading shall be taken at six points per pipe line and at each point it shall be taken on all four sides in top, bottom, left side and right side.

-The above reading shall be taken at 2 hours intervals and shall be taken for 18 hours starting from 11 a.m. in the morning.

	EMERGENCY DIESEL GENERATORS PACKAGE TALCHER FERTILIZERS LIMITED	PC183/E/4022/SecVI-5.0	0	
	CONSTRUCTION/ERECTION, PRE-COMMISSIONING, COMMISSIONING AND START-UP	Document No.	Rev	
		Sheet 65 of 117		

- Simultaneously ambient temperature shall be taken as per IS: 14164
- A graph shall be plotted between ambient and surface temperature reading
- From this graph the surface temperature against ambient temperature shall be found out
- The ambient and surface temperature shall be measured by the instrument provided by the contractor. The instrument shall be calibrated to the satisfaction of owner/consultant.
- The contractor is required to guarantee the surface temperature of 60°C (max.) for equipments and piping in case of Hot Insulation. For cold insulation of equipments and piping, the difference between skin temperature and ambient temperature shall not exceed 2 °C.
- Ambient temperature and surface temperature shall be measured by duly calibrated instruments provided by CONTRACTOR.
- The CONTRACTOR shall undertake immediate replacement of insulation material damaged in transit, storage or application, at no additional cost to Owner.
- LSTK shall produce required number of copies of test certificates as per relevant IS/ASTM Standard. LSTK shall certify/ensure that Test to be done are from NABL approved laboratory, approved by Owner.
- All materials are new and unused and are as per specifications called for in this standard.
- The operating thermal conductivity shall be as specified
- The workmanship shall be in accordance with good practice.
- **Other terms & conditions of the guarantee clause shall be as per NIT / purchase order / Commercial documents of ITB.**

	EMERGENCY DIESEL GENERATORS PACKAGE TALCHER FERTILIZERS LIMITED	PC183/E/4022/SecVI-5.0	0	
	CONSTRUCTION/ERECTION, PRE-COMMISSIONING, COMMISSIONING AND START-UP	Document No.	Rev	
		Sheet 66 of 117		

ANNEXURE- 7 – 2F

PAINING SPECIFICATION (TS-2001)

1.0 GENERAL

1.1 Scope

This specification covers the technical requirements for shop and site application of paint and protective coatings and includes; the surface preparation, priming, application, testing and quality assurance for protective coatings of mechanical equipment, structural steelwork, plate work, tankage, guards, pipe work, handrails and associated metal surfaces, which will be exposed to atmospheric for the Project.

1.2 Definitions

- C.S - Carbon steel and low chrome (1-¹/₄ Cr through 9 Cr) alloys
- S.S - Stainless steel, such as 304,316, 321, 347,
- Non-ferrous - copper, aluminium and their alloys.
- High Alloy - Monel, Inconel, Incoloy, Alloy 20, Hastelloy, etc.
- DFT - Dry Film thickness, the thickness of the dried or cured paint or coating film.

1.3 Safety Regulations

Protective coatings and their application shall comply with all national, state, and local codes and regulations on surface preparation, coating application, storage, handling, safety, and environmental recommendations.

Sand or other materials producing silica dust shall NOT be used for any open-air blasting operations.



1.4 Material Safety Data Sheets

The latest issue of the coating manufacturer's product datasheet, application instructions, and Material safety data Sheets shall be available prior to starting the work and shall be complied with during all preparation and painting / coating operations.

1.5 Materials

All paints and paint materials shall be obtained from the company's approved manufacturer's list. All materials shall be supplied in the manufacturer's containers, durably and legibly marked as follows.

- Specification number
- Colour reference number
- Method of application
- Batch number
- Date of Manufacture
- Shelf life expiry date
- Manufacturer's name or recognised trade mark.

	EMERGENCY DIESEL GENERATORS PACKAGE TALCHER FERTILIZERS LIMITED	PC183/E/4022/SecVI-5.0	0	
	CONSTRUCTION/ERECTION, PRE-COMMISSIONING, COMMISSIONING AND START-UP	Document No.	Rev	
		Sheet 67 of 117		

2.0 CODE AND STANDARDS:

Without prejudice to the provision of Clause 1.1 above and the detailed specifications of the contract, the following codes & standards shall be followed. Wherever reference to any code is made, it shall correspond to the latest edition of the code.

2.1 Indian Standards:

IS-5: 1994	Colors for ready mixed paints and enamels.
IS-2379: 1990	Color codes for identification of pipe lines.
IS-2629: 1985	Recommended practice for hot-dip galvanizing on iron and steel.
IS-2633: 1986	Methods for testing uniformity of coating of zinc-coated articles.
IS-8629: 1977	Code of practice for protection of iron and steel structures from atmospheric corrosion.
IS:110	Specification for Ready Mixed Paint, Brushing, Grey Filler, for Enamels, for Over Primers
IS:101	Methods of test for ready mixed paints & enamels.



2.2 Other Standards:

2.2.1 Swedish Standard: SIS-05 5900-1967 / ISO-8501-1-1988
(Surface preparations standards for Painting Steel Surface).
This standard contains photographs of the various standards on four different degrees of rusted steel and as such is preferable for inspection purpose by the Engineer-in-charge.

2.2.1 DIN: 53151 Standards for Adhesion test.

2.3 The paint manufacturer's, instructions shall be followed as far as practicable at all times. Particular attention shall be paid to the following:

- a) Instructions for storage to avoid exposure as well as extremes of temperature.
- b) Surface preparation prior to painting.
- c) Mixing and thinning.
- d) Application of paints and the recommended limit on time intervals between coats.

	EMERGENCY DIESEL GENERATORS PACKAGE TALCHER FERTILIZERS LIMITED	PC183/E/4022/SecVI-5.0	0	
	CONSTRUCTION/ERECTION, PRE-COMMISSIONING, COMMISSIONING AND START-UP	Document No.	Rev	
		Sheet 68 of 117		

3.0 SURFACE PREPARATION

3.1 Metal Surface Preparation

3.1.1 Safety

All work in adjacent areas, which may negatively affect the quality of blast cleaning, and/or impose safety hazards, must be completed or stopped before the blasting operation starts.

3.1.2 Pre-cleaning

Prior to surface preparation all weld spatter shall be removed from the surface, all sharp edges ground down and all surfaces cleaned free of contaminants including chalked paint, dust, grease, oil, chemicals and salt. All shop primed surfaces shall be water washed by means of suitable solvent, by steam cleaning, with an alkaline cleaning agent if necessary or by high-pressure water, to remove contaminants prior to top-coating

3.1.3 Surface Decontamination

Surface decontamination shall be performed prior to paint application when uncoated surface is exposed to a corrosive environment or existing paint work is to be repaired.

Existing coatings shall be removed by abrasive blast cleaning, and then high pressure potable water shall be used to clean steel surfaces.

Prior to application of coatings, the surface shall be chemically checked for the presence of contaminants. A surface contamination analysis test kit shall be used to measure the levels of chlorides, iron salts and pH in accordance with the kit manufacturer's recommendations.

Swabs taken from the steel surface, using cotton wool test swabs soaked in distilled water shall not be less than one swab for every 25m² of surface area to be painted.

Maximum allowable contaminant levels and pH range is as follows:



Sodium chloride, less than 50 microgram / cm²;

Soluble iron salts, less than 7 microgram / cm²; and

If the results of the contamination test fall outside the acceptable limits, then the wash water process shall be repeated over the entire surface to be painted, until the contaminant test is within the specified levels.

3.1.4 Abrasive Blasting

All C.S. materials shall be abrasive blast cleaned in accordance with Codes (Ref. Clause 2.0). To reduce the possibility of contaminating S.S., blasting is not usually specified. However, for coatings which require a blast-cleaned surface for proper adhesion, S.S. may be blast cleaned using clean aluminium oxide or garnet abrasives (Free from any chloride or Iron / Steel contamination). When hand or power tool cleaning is required on S.S., only S.S. wire-brushes (including 410 S.S.) which have not been previously used on C.S. surfaces may be used.

	EMERGENCY DIESEL GENERATORS PACKAGE TALCHER FERTILIZERS LIMITED	PC183/E/4022/SecVI-5.0	0	
	CONSTRUCTION/ERECTION, PRE-COMMISSIONING, COMMISSIONING AND START-UP	Document No.	Rev	
		Sheet 69 of 117		

The surface profile of steel surfaces after blasting shall be of preparation grade Sa 2-1/2 of Swedish Standards SIS-05-5900 (Latest Revision) or better according to ISO 8501-1 and shall be measured using the replica tape method or the comparator method.

The roughness (profile) of blast-cleaned surfaces shall be Medium (G) according to ISO 8503-2: 1988 (appendix 1) unless otherwise specified. Medium defines a surface profile with a maximum peak-to-valley height of 60-100 microns, and G indicates that the surface profile is obtained by grit blasting. For the evaluation of surface roughness Comparator G shall be used.

Abrasive blast cleaning shall NOT be performed when the ambient or the substrate temperatures are less than 3° C above the dew point temperature. The relative humidity should preferably be below 50% during cold weather and shall never be higher than 60% in any case.

Abrasive blast cleaning shall be performed with a clean, sharp grade of abrasive. Grain size shall be suitable for producing the specified roughness. Abrasives shall be free from oil, grease, moisture and salts, and shall contain no more than 50ppm chloride. The use of silica sand, copper slag and other potentially silica containing materials shall not be allowed

The blasting compressor shall be capable of maintaining a minimum air pressure of 7 kPa at the nozzle to obtain the acceptable surface cleanliness and profile.

The blast cleaning air compressor shall be equipped with adequately sized and properly maintained oil and water separators. The air supply shall be checked to ensure no oil and water contamination at the beginning of each work shift.

Blast cleaning abrasive shall be stored in a clean, dry environment at all times. Recycling of used abrasive is prohibited.

After blast cleaning, the surfaces shall be cleaned by washing with clean water (Pressure 7kg/Cm² using suitable nozzles. During washing broom corn brushes shall be used to remove foreign matter.

Assessment of the blast cleaned surfaces shall be carried out in accordance with reference code.

Blast cleaned surfaces which show evidence of rust bloom or that have been left uncoated overnight shall be re-cleaned to the specified degree of cleanliness prior to coating.



All grit and dust shall be removed after blasting and before coating application. Removal shall be by a combination of blowing clean with compressed air, followed by a thorough vacuum cleaning with an industrial grade, heavy duty vacuum cleaner.

All cleaned surfaces shall have protection from atmospheric corrosion as per IS8629:1977

3.1.5 Alternate Methods of Surface Preparation

When open air blasting is not permitted on site, or when space limitations or surface configurations preclude blasting, the alternate cleaning methods listed below may be used with prior approval. Alternate cleaning methods shall consider the degree of surface cleanliness and roughness profile required by the specified coating system.

- Vacuum or suction head abrasive blast-cleaning,

	EMERGENCY DIESEL GENERATORS PACKAGE TALCHER FERTILIZERS LIMITED	PC183/E/4022/SecVI-5.0	0	
	CONSTRUCTION/ERECTION, PRE-COMMISSIONING, COMMISSIONING AND START-UP	Document No.	Rev	
		Sheet 70 of 117		

- Wet jet abrasive blast-cleaning,
- Compressed-air wet abrasive blast cleaning,
- Pressurized liquid blast-cleaning,
- Power tool cleaning,
- Hand or power tool cleaning,

Hand and/or power tool cleaning shall only be used for spot repair where abrasive blasting is not permitted or is impractical, and on items which could be damaged by abrasive blasting. Power tool cleaning shall not be carried out with tools which polish the surface, e.g. power wire brushes.

The surfaces of equipments and prefabricated piping etc. which are received at site Primerised or with finish paints, depending upon their conditions, shall be touched up and painted at site. For these surfaces sand blasting is not envisaged and these surfaces shall be prepared using power brushes, buffing or scraping, so as to achieve a surface finish to St-3 as per SIS-05-5900 . After wash-up the area to be touched up shall be jointly marked, measured and recorded for payment purposes. The type of system & nos. of coat (primer and/or finish paint) to be applied after touch up, which shall be decided by OWNER/CONSULTANT in writing before taking up the job.

When paint is to be applied on damaged painted surfaces of equipments all loose and flaking paint work should be removed to a firm feathered edge. Rusted spots should be cleaned by one of the methods specified in the clauses 4.4.1 & 4.4.2 above. In case the previous paint work is not compatible to the specified one the entire coating must be removed.

It shall be ensured that sand blasted surface/machine cleaned surface is not contaminated with oil and grease. Water shall also not be allowed to come in contact with sand blasted surface.

4.0 APPLICATION

4.1 General

The final specification of paint systems to be used to suit the exposure conditions of equipment and steelwork, shall be as specified on the scope of work, equipment data sheets or the drawings.



All coatings shall be in accordance with Indian / International Standards, the coating manufacturer's product data sheets and application instructions and the requirements contained in this specification.

4.1.1 General Requirements for Shop Application

All work areas which facilitates shop paint application shall be surface prepared for painting and have the paint system applied before installation.

Equipments assembled at site shall only receive primer coat in the shop and finish coatings will be applied at site.

In all cases, where surfaces will be inaccessible after shop assembly, they shall be prepared and have the paint system applied before assembly is carried out. Drying times between successive coats shall be at least those recommended by the manufacturer.

	EMERGENCY DIESEL GENERATORS PACKAGE TALCHER FERTILIZERS LIMITED	PC183/E/4022/SecVI-5.0	0	
	CONSTRUCTION/ERECTION, PRE-COMMISSIONING, COMMISSIONING AND START-UP	Document No.	Rev	
		Sheet 71 of 117		

All known field weld areas shall be given the specified abrasive blast surface preparation but left uncoated for a distance of 50mm from the weld line. Such areas shall be given the appropriate touch-up treatment after installation.

The manufacturer's directions for preparation and application of coatings shall be followed to ensure that the durability of the coating system is not impaired.

The Contractor shall submit the full details of the proposed surface preparation and paint systems prior to the commencement of any surface preparation.

4.1.2 General Requirements for Site Application

Paint shall be stored only in accordance with the manufacturer's instructions.

All materials used for the specific system being applied shall be products supplied by one manufacturer and details of such product shall be submitted for approval before commencement of work.

The contents of cans shall be thoroughly stirred before being poured into paint pots and shall be thinned only in the specified proportions in accordance with the manufacturer's instructions.

Finish coats may be applied by spraying except where any over spray is likely to affect finished surfaces or where spraying constitutes a health hazard to workmen in the other areas. Brush and roller application will require multiple coats to achieve the specified dry film thickness.

Brush application may be used only with the approval of the company.

Roller application shall only be used on relatively large surface areas (i.e. > 50m²) and only if spraying is not an option.

The Contractor shall complete the application of any one type of paint or each coat thereof, before beginning the next coat on that section.



In cases nominated as critical, the application of each coat shall be approved before application of the next coat can proceed, in accordance with 'hold' points nominated in the Inspection and Test Plans (ITPs)

All fittings within any given area are to be painted with the same system as the area unless otherwise specified.

Where 2 coat of finish paint are indicated they shall be applied in two different shades to ensure that two coat are applied.

Paint shall not be applied in rain, snow, fog or mist or when the relative humidity is such as to cause condensation on metal surface.

The CONTRACTOR must ensure the availability of a specialist from the paint manufacturer, at SITE during pendency of CONTRACT within his quoted rates to ensure the quality of painting & procedure. Addition of drying agents, pigments or other substances is not allowed unless specifically prescribed or approved by paint manufacturer's specialist.

	EMERGENCY DIESEL GENERATORS PACKAGE TALCHER FERTILIZERS LIMITED	PC183/E/4022/SecVI-5.0	0	
	CONSTRUCTION/ERECTION, PRE-COMMISSIONING, COMMISSIONING AND START-UP	Document No.	Rev	
		Sheet 72 of 117		

Name plates/tags attached to the equipments/machineries shall not be painted or removed during painting job. Failing to comply with above, the CONTRACTOR may be required to replace name plates/tags at his cost.

4.1.3 Qualifications and Materials

All surface preparation, coatings application and inspection, shall be carried out by personnel experienced in that particular field. Contractors shall submit the names of subcontractors to be employed for the specific work together with the brand names of coating materials for approval prior to commencement of application.

4.1.4 Handling and Transport

All pipe work, steelwork and equipment that have been finish coated shall be handled with care to preserve the coating in the best practical condition.

Painted materials shall not be handled until the coating has completely cured and dried hard Supports in contact with coated steel during transport and storage shall be covered with a soft material to prevent damage to the coating. Appropriate materials shall be used during transportation between coated steelwork and holding down chains to prevent damage to the coating.

4.2 Application of Coatings

4.2.1 General

The application method and type of equipment to be used shall be suitable for the paint specified and the surface being painted.

Paints and thinners shall be brought to the point of usage in unopened original containers bearing the manufacturer's brand name and colour designation and ready-mixed unless otherwise specified. Two-pack systems shall be mixed at the site of application to the paint manufacturer's recommendations. The mixed amount prepared shall be no more than the amount that can be applied during the stated pot life.



Paint shall be applied so that an even film of uniform thickness, tint and consistency covers the entire surface and is free of pin holes, runs, sags or excessive brush marks. Film finish shall be equal to that of first class brushwork.

Unless it is practical to do so colour shades for primer, intermediate coat and finish coat must be different to identify each coat without any ambiguity

Paint ingredients shall be kept properly mixed during paint application.

Equipment shall be kept clean to ensure dirt, dried paint and other foreign materials are not deposited in the paint film. Any cleaning solvents left in the equipment shall be completely removed before painting.

To ensure the required film thickness is achieved on angles, welds, sharp external edges, nuts and bolts, a coat shall be applied to such items/locations immediately prior to the application of each coating to the whole area.

	EMERGENCY DIESEL GENERATORS PACKAGE TALCHER FERTILIZERS LIMITED	PC183/E/4022/SecVI-5.0	0	
	CONSTRUCTION/ERECTION, PRE-COMMISSIONING, COMMISSIONING AND START-UP	Document No.	Rev	
		Sheet 73 of 117		

Care shall be taken to ensure paint application into all joints and crevices.

The contact surfaces between steelwork to be fastened by means of friction grip bolting shall be abrasive blast cleaned and prime coated only, prior to erection.

4.2.2 Atmospheric conditions

Surface preparation and coating shall not be carried out in inclement weather and shall be carried out such that the surface being coated is free of moisture, wind-borne or blast cleaning dust.

Coatings shall not be applied if:

- The relative humidity exceeds 85%.
- The ambient temperature is less than 5⁰C (depending on local condition)
- The metal temperature is less than 3⁰C above the dew point.
- There is likely hood of an unfavourable change in weather conditions within two hours after painting.

As a general rule, sufficient ventilation, dehumidification and heating capacity to cope with local climatic conditions must be secured before any coating – related work is started.

In any case, humidity, ambient and surface temperature conditions at the time of paint application, and curing and drying time before application of the next coat, shall be in accordance with the paint manufacturer's recommendations. These conditions shall be recorded in the Inspection Test Record (ITR) by the Contractor and be available for review.

4.2.3 Conventional or Airless Spray

Spray equipment shall be equipped with accurate pressure regulators and gauges. Spray gun nozzles and needles shall be those recommended by the paint manufacturer.

Air from the spray gun shall be clean and dry with no traces of oil or moisture.

Coatings shall be wet on contacting the painted surface. Areas of dry spray shall be removed and the correct system re-applied.

4.2.4 Brush Application



The method of "laying-off" shall be suited to the paint specified and shall ensure minimum brush marking.

4.2.5 Roller Application

A uniform method of application shall be adopted when painting large areas. The rolling direction shall minimise paint joint build up. Edges and areas subject to possible roller damage shall be brush-painted prior to rolling.

4.2.6 Thickness of Coatings

The maximum thickness DFT in any one application shall not exceed that specified in Technical specifications/ recommended by the paint manufacturer.

	EMERGENCY DIESEL GENERATORS PACKAGE TALCHER FERTILIZERS LIMITED	PC183/E/4022/SecVI-5.0	0	
	CONSTRUCTION/ERECTION, PRE-COMMISSIONING, COMMISSIONING AND START-UP	Document No.	Rev	
		Sheet 74 of 117		

Wet film thickness gauges shall be used to make frequent checks on the applied wet film. The Contractor shall maintain at the site of painting operations, a dry film thickness tester of an approved type with a valid current calibration.

Coating thickness checks in accordance with reference code shall be performed, and the Contractor shall undertake remedial action if the measured thickness is less than specified.

Build up of each material to required thickness shall be made prior to the application of the subsequent coat; final film build shall be the minimum specified.

4.2.7 Multiple Coat Applications (Except Wet-On-Wet)

Before successive paint coats are applied, intermediate coats shall be inspected for surface contamination. The presence of any grease or oil, shall be removed by a suitable solvent, and any salt and dirt adhering to the surface shall be removed by scrubbing with a solution of non-toxic detergent (except those prescribed by the manufacturer as "wet-on-wet"). Removal of contaminants shall only be performed after an intermediate coat has had sufficient time to cure.

The surface shall then be pressure hosed or dusted down by brush to disturb and remove deposits not apparent on visual inspection.

Coatings shall be applied only under the following conditions:

- The surface has been cleaned and is dry;
- The manufacturer's stated minimum time for re-coat has elapsed;
- The manufacturer's stated maximum time for re-coat has not elapsed. If the maximum time has elapsed then pre-treatment shall be in accordance with the paint manufacturer's recommendations; and

Damaged areas in preceding coat have been made good in accordance with this Specification.

When multiple coat of finish paint is indicated, they shall be applied in different shades to ensure that multiple coats have been applied.

4.2.8 Protective Coatings for Fasteners



Black and galvanised erection bolts/nuts and galvanised holding down bolts/nuts shall be prepared and painted in accordance with Section 4.4 of this Specification.

Black high tensile bolts/nuts shall be painted after erection to the same paint system specification as the surrounding structural steel.

4.3 Hot Dip Galvanising

All galvanising shall be carried out by the hot dipping process and conform to the requirements of IS-2629:1985 and uniformity of coating shall confirm to IS 2633:1986.

All welding slag shall be removed by chipping, wire brushing, flame cleaning or abrasive blast cleaning where necessary prior to galvanising

	EMERGENCY DIESEL GENERATORS PACKAGE TALCHER FERTILIZERS LIMITED	PC183/E/4022/SecVI-5.0	0	
	CONSTRUCTION/ERECTION, PRE-COMMISSIONING, COMMISSIONING AND START-UP	Document No.	Rev	
		Sheet 75 of 117		

For temporary identification, either water-soluble marking paints or detachable metal labels shall be used. For permanent identification, figures/labels shall be heavily punched or embossed by the fabricator.

For galvanised items after pickling, the work shall be inspected and any defects that render the work unsuitable for galvanising shall be repaired. After such repairs, the work shall again be cleaned by pickling.

The coating mass of zinc shall be as specified on equipment data sheets and the Drawings. Galvanised coatings shall be tested by the methods described in referred code.

After galvanising all material shall be cooled to air temperature in such a manner that no embrittlement occurs.

Galvanised coatings shall be smooth, uniform, adherent and free from stains, surface imperfections and inclusions.

All gratings and fixtures including nuts, bolts and washers that are required to be galvanised, shall be hot dipped galvanised and all nut threads shall be re-tapped after galvanising and a lubricant applied on Cold working of galvanised steelwork shall be avoided.

4.4 Damaged or Inaccessible Surfaces

4.4.1 Damaged Paint Surface

Repair of damaged painted surfaces, as well as painting of galvanised and black bolts, and galvanised holding down bolts after erection shall comply with this Clause. The treatment shall be:

- Pre-clean the damaged or unpainted areas in accordance with Section 4.2.1 of this Specification;
 - Disc or hand sand to clean bright metal;
- Inorganic zinc primers subject to mechanical damage or weld etc shall be power tool cleaned
- Feather backs by sandpapering or whip blasting the original coatings surrounding the damaged area over a 50mm distance. A rough surface shall be obtained on epoxy coatings;
 - Clean surface to remove all dust;
- Conduct surface contaminant test in accordance with Section 4.2.2 of this document; and



Build up a new paint system over the affected area with paints equal to those originally used and having the same dry film thickness for each coat. As an exception, damaged inorganic zinc primers shall be repaired with epoxy organic zinc rich paint and shall be applied within four hours of blast cleaning.

The new coatings shall overlap the original coating over the 50mm prepared distance and shall be colour matched to the specified colour of the original coating.

4.4.2 Damaged Galvanised Surfaces

Damaged areas caused by oxy-cutting, welding or physical impact shall be treated as follows:

- Prepare the surface by removing any weld slag followed by vigorous power wire brushing of the coating surrounding the damaged area over a 50mm distance.

	EMERGENCY DIESEL GENERATORS PACKAGE TALCHER FERTILIZERS LIMITED	PC183/E/4022/SecVI-5.0	0	
	CONSTRUCTION/ERECTION, PRE-COMMISSIONING, COMMISSIONING AND START-UP	Document No.	Rev	
		Sheet 76 of 117		

- Clean surface to remove all dust; and apply two coats of organic zinc-rich primer to a minimum DFT of 100 microns.

The area to be reinstated shall be colour matched to the surrounding finish colour with 40 microns of aluminium paint to the manufacturer's **written instructions**.

4.4.3 Inaccessible Surfaces

Surfaces that will be inaccessible after erection of other elements of the structure, shall be fully painted prior to the installation of the obstructing item.

4.5 Surfaces Not To Be Coated

The following surfaces shall not be blasted or coated unless specifically directed:

Machined surfaces, bearings, seals, grease fittings, adjusting screws and name plates, and identification tags.

- Valve stems;
 - Raised faces on pipe and equipment flanges;
 - Electrical cabling;
 - Instrumentation, gauges and sight glasses;
 - Titanium, stainless steel and non-metallic surfaces; and
- Field weld margins, 50mm either side of weld, on tankage and piping, prior welding.

The rear face of piping flanges shall be shop prime coated only. Flange holes for fasteners shall be fully coated.

4.6 Wash-Up



All surface of equipments/prefabricated piping etc. Primerised / painted at Vendor shop and received at site if required shall be washed up as follow:

- a) Washing with clean water (Pressure 7 Kg/cm²) using suitable nozzles. During washing, broomcorn brushes shall be used to remove foreign matter.
- b) Solvent washing, if required, to remove traces of wash up as per above procedure of all surfaces of equipment, piping, structure etc. completely painted at contractor's shop shall be included in the quoted rates of oil, grease etc. Wash up as per above procedure of all surfaces of equipment, piping, structure etc. completely painted at contractor's shop shall be included in the quoted rates.

4.7 Touch-Up Painting

Prior to the application of any coat, all damage to the previous coat(s) shall be touched-up. Damage to finished work shall be thoroughly cleaned and re-coated.

Surface preparation shall be done as per clause no. 3.0

	EMERGENCY DIESEL GENERATORS PACKAGE TALCHER FERTILIZERS LIMITED	PC183/E/4022/SecVI-5.0	0	
	CONSTRUCTION/ERECTION, PRE-COMMISSIONING, COMMISSIONING AND START-UP	Document No.	Rev	
		Sheet 77 of 117		

Items supplied with the manufacturer's standard coating system shall be touched-up with the same generic coating system or recoated.

4.8 Paint Storage

The following must be ensured:

- All paints and painting material shall be stored only in such rooms assigned for the purpose. All necessary precaution shall be taken to prevent fire. The Storage building shall preferably be separate from adjacent buildings. A sign-board bearing the Words "PAINT STORAGE- NO NAKED LIGHT" shall be clearly displayed outside. The building shall be properly ventilated and shall be adequately protected with fire fighting equipment.
- Storage shall be far away from heated surface open flames, sparks & well protected from sun rays.
- Ambient temperature at which paints are stored shall be intimated to paint manufacturer & their advice sought regarding precautions to be taken if any, regarding flammability, explosiveness & toxicity.
- Maximum allowed storage time for various paint materials shall be clearly indicated on individual containers. Materials which have passed expiry date shall not be used.
- Paints in non-original containers and/or in containers without seals, shall not be used.



5.0 COATING SYSTEM SELECTION

Coating Systems for Structures Piping and Equipment



The following Table 1 shall be used as a general guide for the selection of a paint system suitable for a particular plant area application. Paint systems specified on equipment data sheets and the Drawings shall take precedence over the general paint system area applications listed in Table 1.

TABLE - 1



Ref No.	Application	Surface Preparation	Generic Coating System	Minimum DFT	Remarks	
01	Structural Steel work with operating temp. Up to 90° C (Steel structures, Piping support, uninsulated CS piping, flanges, valves, stairways, walkways etc. except grating).	Blast cleaning to near white metal grade 2 ½, of Swedish Standards SIS-05-5900 (Latest).	P2 : ONE coat of two pack zinc rich epoxy Primer meeting SSPC Paint 20 level 1 F1 : One coat of two packs. Polyamide Cured Epoxy. F5 : One coat of two pack aliphatic acrylic polyurethane	P2 : 60 microns F1 : 120 – 200 microns F5 : 60 microns	Total dry film thickness of paint system: 240 microns as per C4 – High durability	Total dry film thickness of paint system: 320 microns as per C5 – High durability
02	Uninsulated CS piping, flanges,	Blast cleaning to near white	P1 : One coat of Ethyl Silicate zinc rich with	P1 : 75 microns	Total dry film thickness of paint	

	EMERGENCY DIESEL GENERATORS PACKAGE TALCHER FERTILIZERS LIMITED	PC183/E/4022/SecVI-5.0	0	
	CONSTRUCTION/ERECTION, PRE-COMMISSIONING, COMMISSIONING AND START-UP	Document No.	Rev	
	Sheet 78 of 117			



Ref No.	Application	Surface Preparation	Generic Coating System	Minimum DFT	Remarks	
	valves with operating temp. From Above 90° C to 200° C.	metal grade Sa-2½, of Swedish Standards SIS-05-5900 (Latest)	solvent Primer meeting SSPC Paint 20 level 1 F3 : Two coats of single pack special Oleo resinous based heat resistant ready mixed Aluminium Paint.	F3 : 2 x 25 microns for each coat Total - 125 microns.	system: 125 microns.	
03	Uninsulated CS piping, flanges, valves with operating temp. Over 200° C.	Blast cleaning to near white metal grade 2 ½, of Swedish Standards SIS-05-5900 (Latest).	P1 : One coat of Ethyl Silicate zinc rich with solvent Primer meeting SSPC Paint 20 level 1 F4 : Two coats of Heat Resisting Silicon Aluminium Paint.	P1 : 75 microns F4 : 2 x 25 microns for each coat Total - 50 microns.	Total dry film thickness of paint system: 125 microns.	
04	Insulated CS piping flanges, valves with operating temp up to 90° C	Blast cleaning to near white metal grade 2 ½, of Swedish Standards SIS-05-5900 (Latest).	F8 : One coat of high temperature epoxy phenolic	F8 : 2 x 125 microns	Total dry film thickness of paint system: 250 microns.	
05	Insulated CS piping, flanges, valves with operating temp. From 90° C to 200° C.	Blast cleaning to near white metal grade Sa-2½, of Swedish Standards SIS-05-5900	F8 : Two coats of high temperature epoxy phenolic (novolac)	F8 : 2 x 125 microns	Total dry film thickness of paint system: 250 microns	
06	Insulated CS piping, flanges, valves with operating temp. Over 200° C.	Blast cleaning to near white metal grade 2 ½, of Swedish Standards SIS-05-5900 (Latest).	F9 : Two coats of Inorganic Co-polymer based coating With an Inert Multipolymer Matrix.	F9 : 2 x 150 microns	Total dry film thickness of paint system: 300 microns.	
07	Uninsulated CS equipment with operating temp. Up to 90° C, to be treated at Manufacturer's	Blast cleaning to near white metal grade 2 ½, of Swedish Standards SIS-05-5900	P2 : ONE coat of two pack zinc rich epoxy Primer meeting SSPC Paint 20 level 1 F1 : One coat of two	P2 : 60 microns F1 : 120 – 200 microns	Total dry film thickness of paint system: 240	Total dry film thickness of paint system: 320

	EMERGENCY DIESEL GENERATORS PACKAGE TALCHER FERTILIZERS LIMITED	PC183/E/4022/SecVI-5.0	0	
	CONSTRUCTION/ERECTION, PRE-COMMISSIONING, COMMISSIONING AND START-UP	Document No.	Rev	
	Sheet 79 of 117			



Ref No.	Application	Surface Preparation	Generic Coating System	Minimum DFT	Remarks	
	shop.	(Latest).	packs. Polyamide Cured Epoxy. F5 : One coat of two pack aliphatic acrylic polyurethane	F5 : 60 microns	microns as per C4 – High Durability	microns as per C5 – High Durability
08	Uninsulated CS equipment with operating temp. From 91 ^o C to 200 ^o C, to be treated at Manufacturer's shop.	Blast cleaning to near white metal grade 2 ½, of Swedish Standards SIS-05-5900 (Latest).	P1 : One coat of Ethyl Silicate zinc rich with solvent Primer meeting SSPC Paint 20 level 1 F3 : Two coats of single pack special Oleouresinous based heat resistant ready mixed Aluminium Paint.	P1 : 75 microns F3 : 2 x 25 microns for each coat	Total dry film thickness of paint system: 125 microns.	
09	Uninsulated CS equipment with operating temp. Over 200 ^o C, to be treated at Manufacturer's shop.	Blast cleaning to near white metal grade 2 ½, of Swedish Standards SIS-05-5900 (Latest).	P1 : One coat of Ethyl Silicate zinc rich with solvent Primer meeting SSPC Paint 20 level 1 F4 : Two coats of Heat Resisting Silicon Aluminium Paint.	P1 : 75 microns F4 : 2 x 25 microns for each coat Total - 50 microns.	Total dry film thickness of paint system: 125 microns.	
10	Insulated CS equipment with operating temp. Up to 90 ^o C, to be treated at Manufacturer's shop.	Blast cleaning to near white metal grade 2 ½, of Swedish Standards SIS-05-5900 (Latest).	F8 : Two coats of high temperature epoxy phenolic (novolac)	F8 : 2 x 125 microns	Total dry film thickness of paint system: 250 microns	
11	Insulated CS equipment with operating temp. From 91 ^o C to 200 ^o C, to be treated at Manufacturer's shop.	Blast cleaning to near white metal grade 2 ½, of Swedish Standards SIS-05-5900 (Latest).	F8 : Two coats of high temperature epoxy phenolic (novolac)	F8 : 2 x 125 microns	Total dry film thickness of paint system: 250 microns	
12	Insulated CS equipment with operating temp.	Blast cleaning to near white metal grade 2	F9 : Two coats of Inorganic Co-polymer based coating With an	F9 : 2 x 150 microns	Total dry film thickness of paint system: 300 microns.	

	EMERGENCY DIESEL GENERATORS PACKAGE	PC183/E/4022/SecVI-5.0	0	
	TALCHER FERTILIZERS LIMITED	Document No.	Rev	
	CONSTRUCTION/ERECTION, PRE-COMMISSIONING, COMMISSIONING AND START-UP	Sheet 80 of 117		



Ref No.	Application	Surface Preparation	Generic Coating System	Minimum DFT	Remarks	
	Over 200°C, to be treated at Manufacturer's shop.	½, of Swedish Standards SIS-05-5900 (Latest).	Inert Multipolymer Matrix.			
13	Surface of structural steel for furnaces, external surface of furnaces, external surface of flue duct, metal stacks and similar with operating temp. Up to 200°C. (With exclusion of stair ways, walk ways etc.).	Blast cleaning to near white metal grade 2 ½, of Swedish Standards SIS-05-5900 (Latest).	P1 : One coat of Ethyl Silicate zinc rich with solvent Primer meeting SSPC Paint 20 level 1 F3 : Two coats of single pack special Oleo resinous based heat resistant ready mixed Aluminium Paint.	P1 : 75 microns F3 : 2 x 25 microns for each coat	Total dry film thickness of paint system: 125 microns.	
14	For external surfaces of flue ducts, metal stacks, and similar with operating temp. Above 200°C.	Blast cleaning to near white metal grade 2 ½, of Swedish Standards SIS-05-5900 (Latest).	P1 : One coat of Ethyl Silicate zinc rich with solvent Primer meeting SSPC Paint 20 level 1 F4 : Two coats of Heat Resisting Silicon Aluminium Paint.	P1 : 75 microns F4 : 2 x 25 microns for each coat Total - 50 microns.	Total dry film thickness of paint system: 125 microns.	
15	For surfaces of air cooler heads not galvanized with operating temperature up to 90° C, treated at manufacturer's shop.	Blast cleaning to near white metal grade 2 ½, of Swedish Standards SIS-05-5900 (Latest).	P2 : ONE coat of two pack zinc rich epoxy Primer meeting SSPC Paint 20 level 1 F1 : One coat of two packs. Polyamide Cured Epoxy. F5 : One coat of two pack aliphatic acrylic polyurethane	P2 : 60 microns F1 : 120 – 200 microns F5 : 60 microns	Total dry film thickness of paint system: 240 microns as per C4 – High Durability	Total dry film thickness of paint system: 320 microns as per C5 – High Durability
		NOTE: All surfaces shall be galvanized at manufacturer's shop with exception of the end header of air cooled heat exchangers that shall be treated as described above at Manufacturer's shop. In case the same surfaces shall not be treated at shop, they shall be treated at site according to environmental and operating conditions.				

	EMERGENCY DIESEL GENERATORS PACKAGE	PC183/E/4022/SecVI-5.0	0	
	TALCHER FERTILIZERS LIMITED	Document No.	Rev	
	CONSTRUCTION/ERECTION, PRE-COMMISSIONING, COMMISSIONING AND START-UP	Sheet 81 of 117		



Ref No.	Application	Surface Preparation	Generic Coating System	Minimum DFT	Remarks	
16	For surfaces of air cooler heads not galvanized with operating temperature up to 91 ^o C TO 200 ^o C, treated at manufacturer's shop.	Blast cleaning to near white metal grade 2 ½, of Swedish Standards SIS-05-5900 (Latest).	P1 : One coat of Ethyl Silicate zinc rich with solvent Primer meeting SSPC Paint 20 level 1 F3 : Two coats of single pack special Oleouresinous based heat resistant ready mixed Aluminium Paint.	P1 : 75 microns F3 : 2 x 25 microns for each coat	Total dry film thickness of paint system: 125 microns.	
		NOTE: All surfaces shall be galvanized at manufacturer's shop with exception of the end header of air cooled heat exchangers that shall be treated as described above at Manufacturer's shop. In case the same surfaces shall not be treated at shop, they shall be treated at site according to environmental and operating conditions.				
18	STORAGE TANKS					
a)	Acid / Alkali CS Storage Tank (External Surface including all stair ways)	Blast cleaning to near white metal grade 2 ½, of Swedish Standards SIS-05-5900 (Latest).	P2 : ONE coat of two pack zinc rich epoxy Primer meeting SSPC Paint 20 level 1 F1 : One coat of two packs. Polyamide Cured Epoxy. F5 : One coat of two pack aliphatic acrylic polyurethane	P2 : 60 microns F1 : 120 – 200 microns F5 : 60 microns	Total dry film thickness of paint system: 240 microns as per C4 – High Durability	Total dry film thickness of paint system: 320 microns as per C5 – High Durability
b)	CS Storage Tanks, Excluding indicated in Sl. No. (a)	Blast cleaning to near white metal grade 2 ½, of Swedish Standards SIS-05-5900 (Latest).	P1 : One coat of Ethyl Silicate zinc rich with solvent Primer meeting SSPC Paint 20 level 1 F1 : One coat of two pack Polyamide Cured Epoxy. F5 : Two-pack aliphatic Isocyanate cured acrylic finish	P1 : 60 microns F1 : 120 - 200 microns F5 : 60 microns	Total dry film thickness of paint system: 240 microns as per C4 – High Durability	Total dry film thickness of paint system: 320 microns as per C5 – High Durability

	EMERGENCY DIESEL GENERATORS PACKAGE TALCHER FERTILIZERS LIMITED	PC183/E/4022/SecVI-5.0	0	
	CONSTRUCTION/ERECTION, PRE-COMMISSIONING, COMMISSIONING AND START-UP	Document No.	Rev	
	Sheet 82 of 117			

Ref No.	Application	Surface Preparation	Generic Coating System	Minimum DFT	Remarks	
			paint			
19	Cold Insulated Carbon Steel and low alloy Steel (1-1/4 Cr through 9 Cr) Piping and Equipment. (Upto 60 Deg. C)	Blast cleaning to near white metal grade 2 1/2, of Swedish Standards SIS-05-5900 (Latest).	F7 : Two coats of Tar Free Epoxy paint suitably pigmented	F7 : 2 x 125 microns	Total dry film thickness of paint system: 250 microns.	
20	Cold Insulated high alloy Steel piping and Equipment (Upto 200 Deg. C)	Lightly Blast cleaned as per Sa 1.0 Swedish Standards SIS-05-5900 (Latest).	F8 : Two coats of high temperature epoxy phenolic (novolac)	F8 : 2 x 125 microns	Total dry film thickness of paint system: 250 microns	
21	DELETED					
22	Surface (CS) with Equipment with temp. Indicating paint from 220°C to 240°C treated at Manufacturer's shop	Blast cleaning to near white metal grade 2 1/2, of Swedish Standards SIS-05-5900 (Latest).	P1 : One coat of Ethyl Silicate zinc rich with solvent Primer meeting SSPC Paint 20 level 1 F6 : Temperature indicating paint	P1 : 75 microns F6 : 2 x 25 microns for each coat Total - 50 microns.	Total dry film thickness of paint system: 125 microns.	
23	PACKAGE:					
a)	Surface (CS) with operating temperature upto 90°C treated at Manufacturer's shop	Blast cleaning to near white metal grade 2 1/2, of Swedish Standards SIS-05-5900 (Latest).	P2 : ONE coat of two pack zinc rich epoxy Primer meeting SSPC Paint 20 level 1 F1 : One coat of two packs. Polyamide Cured Epoxy. F5 : One coat of two pack aliphatic acrylic polyurethane	P2 : 60 microns F1 : 120 – 200 microns F5 : 60 microns	Total dry film thickness of paint system: 240 microns as per C4 – High Durability	Total dry film thickness of paint system: 320 microns as per C5 – High Durability
b)	Surfaces (CS) with operating temperature upto 91°C TO 200°C, treated at manufacturer's	Blast cleaning to near white metal grade 2 1/2, of Swedish Standards SIS-05-5900 (Latest).	P1 : One coat of Ethyl Silicate zinc rich with solvent Primer meeting SSPC Paint 20 level 1 F3 : Two coats of single pack special	P1 : 75 microns F3 : 2 x 25 microns for each coat	Total dry film thickness of paint system: 125 microns.	

	EMERGENCY DIESEL GENERATORS PACKAGE		PC183/E/4022/SecVI-5.0	0	
	TALCHER FERTILIZERS LIMITED		Document No.	Rev	
	CONSTRUCTION/ERECTION, PRE-COMMISSIONING, COMMISSIONING AND START-UP		Sheet 83 of 117		

Ref No.	Application	Surface Preparation	Generic Coating System	Minimum DFT	Remarks
	shop.		Oleouresinous based heat resistant ready mixed Aluminium Paint.		
c)	Surface (CS) with operating temp. Over 200°C, treated at manufacturer's shop.	Blast cleaning to near white metal grade 2 ½, of Swedish Standards SIS-05-5900 (Latest).	P1 : One coat of Ethyl Silicate zinc rich with solvent Primer meeting SSPC Paint 20 level 1 F4 : Two coats of Heat Resisting Silicon Aluminium Paint.	P1 : 75 microns F4 : 2 x 25 microns for each coat Total - 50 microns.	Total dry film thickness of paint system: 125 microns.
d)	Package in Carbon Steel and low Alloy Steel (1-¼ Cr through 9 Cr) with cold insulated surface treated at manufacturer's shop (Upto 60 Deg. C)	Blast cleaning to near white metal grade 2 ½, of Swedish Standards SIS-05-5900 (Latest).	F7 : Two coats of Tar Free Epoxy paint suitably pigmented	F7 : 2 x 125 microns	Total dry film thickness of paint system: 250 microns.
e)	Package in Cold Insulated high alloy Steel. (Upto 200 Deg. C)	Lightly Blast cleaned as per Sa 1.0 Swedish Standards SIS-05-5900 (Latest).	F8 : Two coats of high temperature epoxy phenolic (novolac)	F8 : 2 x 125 microns	Total dry film thickness of paint system: 250 microns
f)	DELETED				
24	For internal surface of shell, roof of CS tanks, with operating temp. Upto 110°C	Blast cleaning to near white metal grade 2 ½, of Swedish Standards SIS-05-5900 (Latest).	F2 : Two coats of two pack amine adduct cured Phenolic (Novolac) epoxy (immersion grade)	F2 : 2 x 150 microns for each coat	Total dry film thickness of paint system: 300 microns.
25	For underside (soil side) of the tank bottom (CS) below only of the fixed tanks,	Blast cleaning to near white metal grade 2 ½, of Swedish Standards SIS-	F7 : Two coats of Tar Free Epoxy paint suitably pigmented OR	F7 : 2 x 200 microns OR	Total dry film thickness of paint system: 400 microns. OR

	EMERGENCY DIESEL GENERATORS PACKAGE TALCHER FERTILIZERS LIMITED	PC183/E/4022/SecVI-5.0	0	
	CONSTRUCTION/ERECTION, PRE-COMMISSIONING, COMMISSIONING AND START-UP	Document No.	Rev	
		Sheet 84 of 117		

Ref No.	Application	Surface Preparation	Generic Coating System	Minimum DFT	Remarks
	bottom & shell shall be treated as follows:	05-5900 (Latest).	F8 : Two coats of high temperature epoxy phenolic (novolac)	F8 : 2 x 150 microns	Total dry film thickness of paint system: 300 microns.
26	CS Equipment and associated piping subject to cyclic, intermittent or regeneration operating condition (e.g. Molecular Sieve Driers) subjected to very severe corrosion with wide operating temperature range.	Blast cleaning to near white metal grade 3, of Swedish Standards SIS-05-5900 (Latest).	Primer: One coat of Thermal spray Aluminium paint and sealed with a Silicon Aluminium seal Finish Coat: One coat of Thermal spray Aluminium paint and sealed with a Silicon Aluminium seal.	Primer: 125 microns Finish: 125 microns	Total dry film thickness of paint system 250 microns.

NOTES:



Primers

ZINC ETHYL SILICATE PRIMER – P1

The zinc ethyl silicate consists of two packs. One pack contains the ethyl silicate binder with suitable solvents. The other pack contains zinc dust (NOT Paste). Zinc dust shall be ASTM D 520 Type II. They have to be mixed in suitable proportions before application as recommended by manufacturer.

Volume solids	:	Min.64% ±2
DFT Range	:	50 – 75 microns
Theoretical Spreading Rate	:	12.8 – 8.53 sqm/litre
Colour	:	Grey
Application	:	Spray (airless/air)
Drying time (dry to handle)	:	< 45 mins. @ 30 Deg. C and 65% RH
Curing	:	<16 hrs @ 30 Deg. C and 65% RH
% of total metallic zinc in dry film (As per the ASTM D520 – Spherical size)	:	(SSPC SP 20 Level 1) >85% by wt.
Specific Gravity	:	2.5 Kg/Litre min.
Storage life	:	6 months under sealed conditions

Zinc silicate Material curing shall be checked using ASTM D 4752, minimum Acceptable value is 4.

	EMERGENCY DIESEL GENERATORS PACKAGE TALCHER FERTILIZERS LIMITED	PC183/E/4022/SecVI-5.0	0	
	CONSTRUCTION/ERECTION, PRE-COMMISSIONING, COMMISSIONING AND START-UP	Document No.	Rev	
		Sheet 85 of 117		

ZINC RICH EPOXY PRIMER – P2

The zinc rich epoxy consists of two packs. One pack contains the epoxy binder with suitable solvents. The other pack contains zinc dust as per ASTM D520 Type II. They have to be mixed in suitable proportions before application as recommended by manufacturer.

Volume solids	:	65% min. ±2
DFT	:	50 – 100 microns
Theoretical Spreading Rate	:	13 – 6.5 sqm/litre
Colour	:	Grey
Application	:	Airless spray/air spray/brush
Drying time (dry to handle)	:	<10 min. @ 30 Deg C
Hared Dry	:	< 1.5 hrs @ 30 Deg C
% of total metallic zinc in dry film (As per the ASTM D520 – Spherical size)	:	(SSPC SP 20 Level 2) 81% by wt. min.
Specific Gravity	:	2.3 Kg/Litre min.
Storage life	:	12 months under sealed conditions

Finish Paints

HIGH BUILD EPOXY FINISH – F1

This finish paint is fast drying, high build, Two-pack polyamide cured epoxy resin



Volume solids	:	85% min. ±2
DFT Range	:	100 – 200 microns
Theoretical Spreading Rate	:	7.6 – 3.8 sqm/litre
Colour	:	As per Manufacturer List
Binder	:	Polyamide cured epoxy resin, Lead & Chrome Free
Application	:	Brush or spray
Drying time	:	< 2 hrs @ 30 Deg C
Over coating time	:	< 2 hrs @ 30 Deg C
Storage life	:	24 months under sealed conditions

HIGH BUILD EPOXY FINISH (Immersion Grade) – F2

This finish paint is high build, Two-pack phenolic (novolac) epoxy

Volume solids	:	68% min. ±2
DFT Range	:	100 – 150 microns
Theoretical Spreading Rate	:	6.8 – 4.5 sqm/litre
Colour	:	As per Manufacturer List
Binder	:	Amine adduct cured epoxy resin
Application	:	Brush or spray
Drying time	:	< 1.5 hrs @ 30 Deg C
Over coating time	:	< 6.5 hrs @ 30 Deg C
Storage life	:	24 months under sealed conditions

HEAT RESISTANT ALUMINIUM FINISH PAINT : F3

	EMERGENCY DIESEL GENERATORS PACKAGE TALCHER FERTILIZERS LIMITED	PC183/E/4022/SecVI-5.0	0	
	CONSTRUCTION/ERECTION, PRE-COMMISSIONING, COMMISSIONING AND START-UP	Document No.	Rev	
		Sheet 86 of 117		



It is a single pack system based on oleo resinous general purpose aluminium paint with good heat resistance upto 250 Deg. C. and light reflection.

Volume solids	:	25% min. ±2
DFT Range	:	25 microns
Theoretical Spreading Rate	:	10 sqm/litre
Main pigment	:	Aluminium (ASTM 962), Lead & Chrome Free
Colour	:	Metallic Aluminium
Pigment Volume Concentration	:	15 – 20%
Application	:	Brush or spray
Drying time	:	Surface dry <1hr. @ 30 Deg. C
		Hard dry < 3 hrs. @ 30 Deg. C
Storage life	:	24 months under sealed conditions

HEAT RESISTANT SILICON ALUMINIUM FINISH PAINT : F4

It is a single pack system based on ambient curing silicone aluminium pigmented polysiloxane paint with maximum heat resistance of upto 600 Deg. C.

Volume solids	:	25% min. ±2
DFT Range	:	25 microns
Theoretical Spreading Rate	:	10 sqm/litre
Main pigment	:	Aluminium (ASTM 962), Lead & Chrome Free
Colour	:	Metallic Aluminium
Pigment Volume Concentration	:	15 – 20%
Application	:	Brush or spray
Drying time	:	Surface dry < 1hr. at 30 Deg. C
		Hard dry < 3 hrs. at 30 Deg. C
Storage life	:	12 months under sealed conditions

	EMERGENCY DIESEL GENERATORS PACKAGE TALCHER FERTILIZERS LIMITED	PC183/E/4022/SecVI-5.0	0	
	CONSTRUCTION/ERECTION, PRE-COMMISSIONING, COMMISSIONING AND START-UP	Document No.	Rev	
		Sheet 87 of 117		



TWO PACK ALIPHATIC ACRYLIC POLYURETHANE FINISH PAINT – F5

It Consists of Acrylic Resin in Part A. Part B consists of an aliphatic poly-isocyanate with appropriate solvents and additives.

Volume solids	:	51% min. ±2
DFT range	:	50 – 100 microns
Theoretical Spreading Rate	:	10.2 – 5.1 sqm/litre
Main pigment	:	Suitable pigments to get the desired colour, Lead & Chrome Free
Colour	:	Metallic Aluminium
Binder	:	Shall not contain any binder other than acrylic resin; should not contain any alkyd / acrylate alkyds / esters.
Application	:	Brush or spray
Drying time	:	Surface dry < 1hr. @ 30 Deg. C Hard dry < 8 hrs. @ 30 Deg. C
ISO 11507/ASTM G 154, QUV A - Accelerated weathering	:	Gloss retention: approx. 80 % and colour change approx. DE 1.2 after 3000 hours exposure
Storage life	:	24 months under sealed conditions

TEMPERATURE INDICATING PAINT : F6

It is a single pack temperature indicating system based on silicone binder. Pigments change colour by heating. The colour change of the coating is permanent. At approximately 200°C, the colour changes from green to blue, above 310°C, the colour changes from blue to greyish white. Maximum service temperature is 400°C.

	EMERGENCY DIESEL GENERATORS PACKAGE TALCHER FERTILIZERS LIMITED	PC183/E/4022/SecVI-5.0	0	
		Document No.	Rev	
	CONSTRUCTION/ERECTION, PRE-COMMISSIONING, COMMISSIONING AND START-UP		Sheet 88 of 117	

Volume solids	:	40% min.
DFT	:	25 microns
Theoretical Spreading Rate	:	16 sqm/litre
Main pigment	:	As per shade requirement, Lead & Chrome free
Colour	:	As per manufacturer
Binder	:	Based in silicone Resins
Application	:	Brush or spray
Drying time	:	Surface dry < 1hr. @ 30 Deg. C
		Hard dry < 4 hrs. @ 30 Deg. C
Storage life	:	12 months under sealed conditions

TAR FREE EPOXY – F7 (Coal Tar is Banned Globally being Carcenogenic)



A high build two component abrasion resistant, pure epoxy with anti-corrosive properties meant for excellent performance.

Volume solids	:	Minimum 72%
DFT Range	:	150 – 200
Theoretical Spreading Rate	:	4.8 – 3.6 sqm/litre
Application	:	By brush or airless spray
Drying time	:	Touch Dry within 4 hrs. @ 30 Deg C
		Hard dry < 9 hours @ 30 Deg. C
Storage life	:	12 months under sealed conditions

EPOXY PHENOLIC (NOVOLAC) – F8

Two Pack epoxy-phenolic (novolac) cured with amine adduct used as an External coating for the protection of insulated (CUI) equipment.

Volume solids	:	68% min.
DFT Range	:	100 – 150 microns
Theoretical Spreading Rate	:	6.8 – 4.5 sqm/litre
Binder	:	Epoxy phenolic (novolac)
Dry Temp. Service	:	Min. -196 to max. 205 Deg. C.
Application	:	Airless Spray / Brush Touch up
Drying Time	:	Surface dry < 1.5hr. @ 30 Deg. C
		Hard dry < 6 hours @ 30 Deg. C

	EMERGENCY DIESEL GENERATORS PACKAGE TALCHER FERTILIZERS LIMITED	PC183/E/4022/SecVI-5.0	0	
	CONSTRUCTION/ERECTION, PRE-COMMISSIONING, COMMISSIONING AND START-UP	Document No.	Rev	
		Sheet 89 of 117		

Storage life	:	12 months under sealed conditions
---------------------	---	-----------------------------------

INORGANIC CO-POLYMER COATING – F9

MIO pigmented single component inorganic copolymer coating which cures to form an inorganic polymer matrix able to resist temperatures up to 650°C/1202°F and thermal shock/cycling dry or dry/wet service.

Volume solids	:	74% min.
DFT Range	:	150 microns
Theoretical Spreading Rate	:	5 sqm/litre
Binder	:	Inorganic copolymer coating
Dry Temp. Service	:	Min. -196 to max. 650 Deg. C.
Application	:	Airless Spray / Brush Touch up
Drying Time	:	Surface dry < 0.5hr. @ 30 Deg. C Hard dry < 1.5 hours @ 30 Deg. C
Storage life	:	12 months under sealed conditions

6.0 MACHINERY, ELECTRICAL AND INSTRUMENT EQUIPMENT:

6.1 Machinery

Steel surfaces shall be treated with complete paint system at Manufacturer's shop. The paint system shall be according to Manufacturer's Std. However, suitable for operating condition and the environmental condition where the machinery will operate. Where necessary machinery shall be restored at site by Contractor with suitable finish.



6.2 Electrical and Instrument Equipment

Steel surfaces shall be treated with complete paint system at Manufacturer's shop. The paint system shall be according to Manufacturer's Std., however suitable for operating condition and the environmental condition where the electrical and instrument equipment will operate. Where necessary Electrical and Instrument Equipment shall be restored at site by Contractor with suitable finish.

7.0 COLOURS:



These shall be as required by specification and in particular for:

Description	Colour	Ra1	Correspond. Asian Paint colors to be defined – See Note-2
- Piping with temperature less than 90°C	GREY	7035	
- Piping, hot surface, flue gas ducts and stacks with temperature above 90°C	SMOOTH	ALUMINIUM	"
- Cooling Water Piping	SEA		"

	EMERGENCY DIESEL GENERATORS PACKAGE	PC183/E/4022/SecVI-5.0	0	
	TALCHER FERTILIZERS LIMITED	Document No.	Rev	
	CONSTRUCTION/ERECTION, PRE-COMMISSIONING, COMMISSIONING AND START-UP	Sheet 90 of 117		

Description	Colour	Ra1	Correspond. Asian Paint colors to be defined – See Note-2
	GREEN		
- Fire fighting Piping	Red	3002	“
- Structures	GREY	7010	“
- Stair cases – ladders	BLACK	9005	“
- Walkwais	GREY	7010	“
- Handrails assemblies	YELLOW	1004	“
- Equipment	GREY	7035	“
- Hot equipment	SMOOTH	ALUMINIUM	“
- Fire fighting equipment	RED	3002	“
- Valves in general	GREY	7035	“
- Hot valves	SMOOTH	ALUMINIUM	“
- Safety and Fire fighting valves	RED	3002	“
- Valves handwheels	BLACK	9005	
- Electric Rotary Machines	SKY BLUE	5012	
- Electric Static Machines	GREY	7035	
- Machinery (compressors & pumps) with operating temperature less than 90°C	GREY	7035	“
- Machinery (compressors & pumps) with operating temperature above 90°C	SMOOTH	ALUMINIUM	“
FURNACES			
- Casing and connected steel works	SMOOTH	ALUMINIUM	“
- Steel work not connected to casing	SMOOTH	ALUMINIUM	“
AIR COOLER			
- High Temperature Surfaces (Temp. > 90°C)	SMOOTH	ALUMINIUM	
- Low Temperature surface (Temp. ≤ 90°C)	GREY	7035	“
- Flare ≤ 90°C	GREY	7035	“
- Flare ≥ 90°C)	SMOOTH	ALUMINIUM	“
TANKS			
- Shell of fixed roof	WHITE	9010	“
- Roof of fixed roof tank	WHITE	9010	

NOTE-1: The colours shall be according to IS2379:1990/International STD. RAL or BS, proposed by Contractor or Manufacturer

	EMERGENCY DIESEL GENERATORS PACKAGE TALCHER FERTILIZERS LIMITED	PC183/E/4022/SecVI-5.0	0	
	CONSTRUCTION/ERECTION, PRE-COMMISSIONING, COMMISSIONING AND START-UP	Document No.	Rev	
		Sheet 91 of 117		

8.0 PARTICULAR DESCRIPTION

The abrasive Grit Blasting shall be used for surface preparation. **Sand blasting is prohibited due to environmental regulations.**

Primerized surface shall be faultless and shall not have mud-cracking, dripping over thickness and dry sprays.

Blast cleaning and painting shall not be carried out on wet surfaces.
Blast cleaning shall not be done when surfaces temperatures are less than 3°C above dew point, or temperature is below 5°C.

No acid washes or other cleaning solutions or solvents shall be used on metal surfaces after they have been blasted.

The surface preparation of all steel surfaces to be coated shall be free of all mill scale, rust corrosion product, oxides, paint, oil or other foreign matter

Only dry abrasive blasting procedures will be allowed. The compressed air supply used for blasting shall be free of detrimental amounts of water and oil. Adequate separator and traps shall be provided and these shall be kept emptied of water and oil. Any blast cleaning set up without functioning moisture separators shall be removed from blast cleaning areas.

All welded areas and appurtenances shall be given special attention for removal of welding flux in crevices. Welding splatter, slivers, laminations and underlying mill scale exposed during sand blasting shall be removed or repaired.

The blast-cleaned or power brushing surfaces shall be coated with primer within four hours of surface preparation.

No primer or intermediate or finishing coating shall be applied without prior notification to the Company.

The application of the products shall be carried out in strict compliance with the paint manufacturer's recommendation.



The Contractor shall provide suitable protection for all adjacent plants or equipment from airborne during spraying and sand blasting.

9.0 INSPECTION AND TESTING

The inspection and testing requirements outlined in this section shall be performed for shop and site applied coating systems.

Preference shall be given to manufacturers and applicators that are quality certified to ISO 9001: 2000.

Documentation of coating material manufacturers and applicators shall include daily inspection reports, equipment reports, and shall clearly identify and trace materials supply and testing performed on coated items and areas.

	EMERGENCY DIESEL GENERATORS PACKAGE TALCHER FERTILIZERS LIMITED	PC183/E/4022/SecVI-5.0	0	
	CONSTRUCTION/ERECTION, PRE-COMMISSIONING, COMMISSIONING AND START-UP	Document No.	Rev	
		Sheet 92 of 117		

Inspection and Test Plans (ITPs), and quality control procedures used for application of coating systems shall form part of the Method Statement and shall be submitted for approval by the Principal prior to commencement of work.

The applicator shall appoint a certified inspector of coatings for inspection and testing of coating systems.

Tests of coated areas and items shall form part of the ITPs.

- Surface Preparation in accordance to Swedish Standard SIS-05-5900 (Latest).
- Blast cleaning profile shall be checked using a suitable profile meter – Acceptable profile shall be 40 - 60 microns.
- Check of time of top coating and drying in accordance with the direction of the paint manufacturer.
- Check of dry film thickness by suitable non-destructive Instrument such as “MIKROTEST”, “DIAMETER” or equivalent.
- Before any coating work is performed on the site, the contractor shall ensure that any works applied by others is acceptable.

Any defect that are discovered, are to be notified in writing to the owner before proceeding with the contract work. To ensure the good execution of painting work following test shall be performed:

- Surface Preparation
- Surface contaminant tests
- Surface profile tests
- Coating thickness tests
- Tests for cure of coatings
- Adhesion tests
- Continuity testing
- Iron contamination
- Chloride contamination
- Dust Contamination



All Inspection and Test Records (ITRs) shall be submitted with the Manufacturer’s Data Report (MDR) at the conclusion of the job.

Defective coated areas shall be suitably marked for rectification work to be performed in compliance with this specification.

Access shall be granted for inspection of all paint work, and witnessing of test work. This shall not however relieve the Contractor of their own QA/QC responsibilities.

10.0 ADHESION TEST RESULTS

For all type of primer the Contractor shall guarantee the Classification of Adhesion Test Results as per ASTM D3359. The acceptable Rate Adhesion Test Results shall be for sandblasted and primerized surfaces shall be minimum 3A (or Higher)

	EMERGENCY DIESEL GENERATORS PACKAGE TALCHER FERTILIZERS LIMITED	PC183/E/4022/SecVI-5.0	0	
	CONSTRUCTION/ERECTION, PRE-COMMISSIONING, COMMISSIONING AND START-UP	Document No.	Rev	
		Sheet 93 of 117		

For primer plus finishing coat(s) the Contractor shall guarantee the Classification of Adhesion Test Results as per ASTM D 3359. The acceptable Rate Adhesion Test Results shall be for blast cleaned and painted surfaces shall be minimum 3A (or higher). After test, the surface must be repaired according to the system applied.

11.0 SUBMISSION OF DATA

Contractor shall submit in phase of bid the original technical data sheet and system for all material supplied by him to apply for the permanent works and test report for the paint in compliance to IS101. This material shall be subject to Owner's approval. The test certificates of zinc silicate shall provide the specific gravity of mixed paint.

12.0 LETTER AND NUMBER INSCRIPTION

Inscriptions letters, as here below indicated, shall be made on equipments, piping, storage tanks, machinery etc.

12.1 Geometric forms and dimensions

Letters and numbers dimensions shall be orientatively fixed according to following:

(A – Dimension of side of unitary elements of grid)

- a) Storage Tanks A – 60 mm
- b) Equipments and piping with O.D. above 600 mm A– 40 mm and
- c) Equipments and pipings with O.D. from 300 to 600 mm and for machinery of great dimensions A – 20 mm
- d) Equipments and pipings with O.D. less than 300 mm and for machinery with small dimensions A – 10 mm

12.2 Inscription's Colours

Inscriptions shall be Black ENI 901 (RAL 9005) on light base

Inscriptions shall be White ENI 101 (RAL 9010) on dark base

12.3 Spaces and Interspaces



Spaces between words and assemblage of numbers shall have dimensions equal to 2A

Interspaces between letters or numbers shall have dimensions equal to A.

13.0 Colour Band for piping ;-

As a rule minimum width of colour band shall confirm to the following Table:-

Nominal pipe Size	Width L (mm)
3" & below	25
4" NB-6" NB	50
8" NB-12"NB	75
14" OD & above	100

	EMERGENCY DIESEL GENERATORS PACKAGE TALCHER FERTILIZERS LIMITED	PC183/E/4022/SecVI-5.0	0	
	CONSTRUCTION/ERECTION, PRE-COMMISSIONING, COMMISSIONING AND START-UP	Document No.	Rev	
		Sheet 94 of 117		

14.0 LIST OF MANUFACTURERS :

1. M/s Berger Paints
2. M/s Jensions & Nickolson
3. M/s Jotun Paints
4. M/s Asian Paints
5. M/s Grauer & Weil (India) Limited
6. M/s Shalimar paints
7. M/s Garware Paints
8. M/s Goodlass Nerolac Paints Ltd
9. M/s. HEMPEL Paints
10. M/s International Paints (Akzo Nobel Brand)
11. M/s Carboline (India) Pvt. Ltd.
12. M/s Mohan Paints

15.0 The contractor shall obtain prior approval from Engineer-In-Charge for the brands of paint material proposed to be used. The contractor shall submit the following details of paint material either at the time of bidding or soon after award of work for approval of paints.

- a. Technical data sheet
- b. Material safety data sheet
- c. Finger printing of paint products as per ISO 20340

16.0 Owner reserves the right to take random samples and get it tested through reputed labs. In case the supplied paint material do not meet the specified performance requirements then suitable action shall be taken against the paint supplier. The decision of Engineer-In Charge shall be final and binding on the Contractor in such cases

17.0 WARRANTY:

Contractor along with Paint Manufacturer jointly shall develop the paint schemes following the system specification.

They shall jointly provide a performance guarantee for a period 5 years as stipulated below,

After 1 years – Corrosion in 3% of total painted area accepted



After 2 years – Corrosion in 6% of total painted area accepted

After 3 years – Corrosion in 9% of total painted area accepted

After 4 years – Corrosion in 12% of total painted area accepted

After 5 years – Corrosion in 15% of total painted area accepted

where spontaneous visible corrosion has broken down the paint film to a degree exceeding “Ri 3” (as defined in ISO 4628/3-2003).

	EMERGENCY DIESEL GENERATORS PACKAGE TALCHER FERTILIZERS LIMITED	PC183/E/4022/SecVI-5.0	0	
	CONSTRUCTION/ERECTION, PRE-COMMISSIONING, COMMISSIONING AND START-UP	Document No.	Rev	
		Sheet 95 of 117		

ANNEXURE- 7 - 3

QUALITY CONTROL PROCEDURE AND INSPECTION REQUIREMENTS

1.0 LSTK CONTRACTOR'S QUALITY CONTROL



1.1 LSTK CONTRACTOR shall provide a quality control program manual include specific WORK methods and inspections, which assure quality.

This quality control program manual must be submitted to OWNER for Approval before starting the construction activities.

All installation WORK must be in strict accordance with this approved manual.

1.2 The quality control program shall include as a minimum the following:

- Methods use to control drawings; specifications and CONTRACT correspondence to assure that only the latest revisions are being used in the field.
- Inspection personal name, organization.
- Inspection methods and documentation of inspection (or tests) for shop fabrication, if required, and installation.
- Material control procedures from SITE receiving point, through "over, short and damage inspection" through storage and through installation.
- Positive material identification Procedures for:
 - Electrical cable pulling and testing.
 - Asphalt placement inspection.
 - Handling and storage methods to prevent damage.
- Inspection and testing procedures and reports for piping, electrical, instrument, equipment and all installation WORK.
- Repair.
- Scrap and reject.
- Grouting.
- Welding.
- Welder qualification.
- Receiving all permanent plant material & equipment.
- Rigging.
- Welder's tests.
- Nondestructive examinations to be used.
- Positive material identification. etc.
- Identification of LSTK CONTRACTORS and ensuring their compliance with the manual and WORK required.
- Material certification verification methods.
- Calibration procedures for measurements and test equipment.

	EMERGENCY DIESEL GENERATORS PACKAGE TALCHER FERTILIZERS LIMITED	PC183/E/4022/SecVI-5.0	0	
	CONSTRUCTION/ERECTION, PRE-COMMISSIONING, COMMISSIONING AND START-UP	Document No.	Rev	
		Sheet 96 of 117		

- Marking and identification of components in process and complete assemblies.

2.0 Shop fabrication and field installation inspection OWNER'S REPRESENTATIVE to ensure specifications. in the following areas will be performed by full adherence to Receiving and inspection.

- Calibration of test inspection equipment.
- Preventive maintenance and storage protection.
- Internal cleanliness.
- Proper material use and control.
- Nondestructive testing and its results.
- Workmanship.

3.0 OWNER'S REPRESENTATIVE or others as authorized by OWNER are to be permitted access to LSTK CONTRACTOR'S work areas for the purpose of inspection of material, equipment, documentation and other areas as required in LSTK CONTRACTOR'S quality assurance / quality control program.

4.0 No concrete will be placed by LSTK CONTRACTOR without an OWNER "Pour Release Form".

5.0 OWNER'S construction inspections will not relieve. LSTK CONTRACTOR of inspection or other responsibilities.

6.0 For piping all welders test pieces shall be supplied by LSTK CONTRACTOR and fully prepared for welding by LSTK CONTRACTOR.

7.0 LSTK CONTRACTOR shall evidence its familiarity and experience with the execution of the installation of WORK to the requirements of the applicable codes and shall perform its WORK in accordance to these requirements and to instructions issued by OWNER'S REPRESENTATIVE in this regard.



8.0 CHECK ON QUALITY OF WORK

8.1 OWNER'S REPRESENTATIVE'S inspector shall have free access to the place where the WORK is performed at all times, in order to check the quality of WORK.

8.2 If during inspection / check reveals unsatisfactory WORK, LSTK CONTRACTOR shall immediately at LSTK CONTRACTOR'S expense. take such corrective measures as deemed required.

9.0 CONTROL SYSTEMS

LSTK CONTRACTOR shall initiate and maintain the following control systems.

	EMERGENCY DIESEL GENERATORS PACKAGE TALCHER FERTILIZERS LIMITED	PC183/E/4022/SecVI-5.0	0	
	CONSTRUCTION/ERECTION, PRE-COMMISSIONING, COMMISSIONING AND START-UP	Document No.	Rev	
		Sheet 97 of 117		

9.1 **Piping**

- Weld x-ray file.
- Pipe and fitting certificate file.
- Isometric weld control sheet & hydrostatic test records.

9.2 **Grounding**

Earth resistance test records.

9.3 **Electrical Cable and Instrument cable**

- Insulation resistance test records.
- Continuity test records.

9.4 **Material certification files**

9.5 **Equipment**

- Weld x-ray file.
- Material certificate files.
- Equipment installation records.
- Equipment maintenance record.
- Hydrostatic test records.
- Grouting release records.
- Alignment records.
- Vibration records.

10. **Requirements for Certification of Materials**

10.1 Mill certification of materials will be required based on the material type, the use and the codes and requirements.

10.2 LSTK CONTRACTOR shall provide:

-Grouting materials, including grounding loop and branch wire which they are LSTK CONTRACTOR'S supply.



Type "B "certificate, for all but not limited to the following materials, which LSTK CONTRACTOR is responsible to supply:

- Materials to be considered structural or structural grade.
- Reinforcing grade.
- Wires mesh reinforcement fabric.
- Anchor bolts.

10.3 **Definition of Type of Certificates**

Type A (certificate of Compliance):

This is a certificate of compliance, issued by the manufacturing or processing works and signed by the quality department or persons to carry the responsibility for quality and conformity, stating that the materials) supplied correspond (5) with what was agreed in the

	EMERGENCY DIESEL GENERATORS PACKAGE TALCHER FERTILIZERS LIMITED CONSTRUCTION/ERECTION, PRE-COMMISSIONING, COMMISSIONING AND START-UP	PC183/E/4022/SecVI-5.0	0	
		Document No.	Rev	
		Sheet 98 of 117		

purchase order.



Type B (mill Certificate):

This is a certificate on which the manufacturer's head of quality department confirms that the product supplied corresponds with what has been agreed in the purchase order. Certification shall be on the basis of tests carried out on the material of the product itself, as per purchase order specification. The testing and certification are to be carried out by a testing center which is independent of the production section of the manufacturing works and which has the code-approved facilities. Independence of such testing center should be warranted by LSTK CONTRACTOR.

10.4 LSTK CONTRACTOR will maintain a systematic filing system of all certificates and reports for all tests and inspections carried out by it under the applicable specifications, standards and codes of practice quoted therein.

LSTK CONTRACTOR may use its own format for records but this must be submitted to OWNER'S REPRESENTATIVE for his approval prior to use.

LSTK CONTRACTOR can expect to be audited on a continuous basis. Originals of all documents to be sent to OWNER'S REPRESENTATIVE.

	EMERGENCY DIESEL GENERATORS PACKAGE TALCHER FERTILIZERS LIMITED CONSTRUCTION/ERECTION, PRE-COMMISSIONING, COMMISSIONING AND START-UP	PC183/E/4022/SecVI-5.0	0	
		Document No.	Rev	
		Sheet 99 of 117		

ANNEXURE- 7 – 4

SCHEDULE, PROGRESS EVALUATION AND PROGRESS REPORTING

1.0 GENERAL

1.1 WORK shall start and be completed in the field as indicated on the approved project construction schedule.

LSTK CONTRACTOR shall follow the sequence of construction in executing the WORK as shown in the schedule or as modified by OWNER.

The detailed scheduling of WORK will be supplied by the LSTK CONTRACTOR. WORK shall be conducted in such a manner that other construction activities are not affected.

Once detailed schedule, established and approved by OWNER, LSTK CONTRACTOR commits itself to follow the schedule in detail.

2.0 DETAILED & SCHEDULE

2.1 Detailed construction schedule must cover all construction work, from lowest level up to highest level.

2.2 Activities shown by means of a bar chart must include as a minimum the activities listed in 4.

3.0 PROGRESS REPORTING

LSTK CONTRACTOR shall issue a reporting procedure and a representative sample of all progress reports.

Following schedules and reports must be issued by LSTK CONTRACTOR to OWNER:

Construction schedule. (Preliminary and detailed)

Monthly status report.

Weekly progress report.



Monthly construction guide schedule.

Daily manpower reports.

All except detailed construction schedule based on approved project construction schedule.

4.0 CONSTRUCTION SCHEDULE

Within **Two** months after Effective Date, LSTK CONTRACTOR will issue separate graphical "S" curves for the following work activities of total CONTRACT.

	EMERGENCY DIESEL GENERATORS PACKAGE TALCHER FERTILIZERS LIMITED	PC183/E/4022/SecVI-5.0	0	
	CONSTRUCTION/ERECTION, PRE-COMMISSIONING, COMMISSIONING AND START-UP	Document No.	Rev	
		Sheet 100 of 117		

Installation of:

- Grouting.
- Underground piping.
- Underground cable trenches and cables.
- Building erection.
- Engineering and design of small bore carbon steel piping systems.
- Prefabrication of piping.
- Electrical installation.
- Instrument installation.
- Equipment assembly and elect
- Erection of piping.
- Flushing and cleaning
- Hydro-testing
- Painting
- Insulation.

5.0 INTRODUCTION

The introduction to the monthly status report shall include LSTK CONTRACTOR'S comments on the overall construction schedule with a status update line as attachment, and shall consist of the following items:

- Goals achieved last month.
- Goals for next month.
- Reason for delay, if any. Reason for deviation of original schedule.
- Average manpower by craft, including management and indirect staff.
- LSTK CONTRACTOR'S comments to general situation.

6.0 CONSTRUCTION ACTIVITIES STATUS

This section consists of scheduled versus actual progress curves.

The progress curves are to be commented upon by LSTK CONTRACTOR.



The basis for reporting shall be the construction schedule:

The monthly status shall be reported as a percentage of the total WORK per type of WORK.

7.0 MANPOWER AVAILABILITY / REQUIREMENTS FOR THE MONTH COMING

LSTK CONTRACTOR shall submit its manpower availability requirements for the next month. This section consists also of the scheduled versus the actual manpower curves.

These manpower curves are accompanied by LSTK CONTRACTOR'S comments hereon.

	EMERGENCY DIESEL GENERATORS PACKAGE TALCHER FERTILIZERS LIMITED CONSTRUCTION/ERECTION, PRE-COMMISSIONING, COMMISSIONING AND START-UP	PC183/E/4022/SecVI-5.0	0	
		Document No.	Rev	
		Sheet 101 of 117		

8.0 MAIN CONSTRUCTION EQUIPMENT AVAILABILITY / REQUIREMENTS FOR THE MONTH COMING

LSTK CONTRACTOR shall submit its main construction equipment availability / requirements for the next month. This section consists also of the scheduled versus actual construction equipment requirement curves. These by LSTK CONTRACTOR'S comments hereon.

9.0 WEEKLY PROGRESS REPORT

Progress reporting will be done on a weekly basis by the actually completed work based on details of work such as quantities or piece of equipment as a percentage of the total anticipated work per work activities as defined in item 4.

9.1 Progress will only be reported on the basis of completed activities as per the percentage breakdown of the major steps as follows:

PROGRESS MEASUREMENT PARAMETERS

Actual physical progress in the field shall be measured based upon standard percentage of completion of progress stages, that, they are to be prepared by LSTK CONTRACTOR and Approved by OWNER to calculate actual physical progress of the WORK, the exact weight value of each activity from lowest level up to highest level in each category of the WORK shall be specified by LSTK CONTRACTOR and supplied to OWNER.

After OWNER'S Approval this weight value can be used for calculation of actual progress of the WORK

10.0 WEEKLY PROGRESS MEETING

10.1 WEEKLY WORK LIST

In the weekly progress review meeting LSTK CONTRACTOR shall forecast the WORK it plans to perform during the week by means of a weekly WORK list including its manpower resource allocation as per the activities listed in 4 and 6.



This weekly program shall be in accordance with the construction guide schedules.

10.2 WORK FRONT

LSTK CONTRACTOR shall submit monthly and weekly a total recapitulation Of the total work front available with estimated manpower requirements, materials and equipment which shall be supplied by LSTK CONTRACTOR.

11.0 MONTHLY CONSTRUCTION GUIDE SCHEDULE

Based on approved overall construction schedule, LSTK CONTRACTOR must issue a monthly construction guide schedule covering a two (2) months period, for each individual

	EMERGENCY DIESEL GENERATORS PACKAGE TALCHER FERTILIZERS LIMITED CONSTRUCTION/ERECTION, PRE-COMMISSIONING, COMMISSIONING AND START-UP	PC183/E/4022/SecVI-5.0	0	
		Document No.	Rev	
		Sheet 102 of 117		

activity.



Progress updating of construction guide schedules must be weekly and presented in the weekly progress review meeting at site.

The updated issue will show for each individual activity:

- Percent complete.
- Weight factor complete.

12.0 DAILY MANPOWER REPORTS

LSTK CONTRACTOR shall be furnished daily manpower report as per agreed format.

	EMERGENCY DIESEL GENERATORS PACKAGE TALCHER FERTILIZERS LIMITED	PC183/E/4022/SecVI-5.0	0	
	CONSTRUCTION/ERECTION, PRE-COMMISSIONING, COMMISSIONING AND START-UP	Document No.	Rev	
		Sheet 103 of 117		

ANNEXURE- 7 – 5

EXECUTION PLAN

1.0 BIDDER ORGANISATION

1.1 Company Organisation

Bid shall include a description of the organization, its management structure and organization chart of Bidder's company with particular reference to the means whereby the execution of this project will be related to the overall company organization.

The Bidder shall also furnish the name(s) of their partners, associated/ subsidiary companies & their activities, and whether any such associated/ subsidiary company will be involved in the execution of WORK, and if so, their scope thereof.

1.2 Project Organization

Bidder shall give charts of organization, which he intends to use in the execution of the work. Such charts must show lines of authority and communication of senior personals who will be assigned to this work in Bidder's home - office and other offices where WORK shall be performed (if any) and the lines connecting such Project Organization to the Bidder's internal overall organization including partners (if any). The chart shall be supported by a narrative, which shall explain how the proposed organisation will operate and in particular will provide

The name of the location of the office(s) in which the Basic and Detail Engineering Design Packages of the plant shall be carried out.

If any parts of the Basic and Detail Engineering Design Packages are to be carried out in more than one office, then details of the distribution of the jobs between offices and coordination procedure shall also be presented.

A description of the facilities offered to the OWNER'S resident engineers.



2.0 Estimated project and Engineering man-hours

Bidder shall give an estimate of the engineering man-hours and its break down for all activities

3.0 Methods and procedures

Bidder shall summarise the methods and procedures that BIDDER intends to implement during the performance of the WORK. It shall include the proposed procedures such as Engineering, Procurement, construction strategy, WORK Progress Measurement, Pre-commissioning, Commissioning and Performance Test Run of the PLANT, and Training.

BIDDER shall also furnish proposed procedures for the Project management, communication and method and frequency of reporting the progress of the WORK.

	EMERGENCY DIESEL GENERATORS PACKAGE TALCHER FERTILIZERS LIMITED	PC183/E/4022/SecVI-5.0	0	
	CONSTRUCTION/ERECTION, PRE-COMMISSIONING, COMMISSIONING AND START-UP	Document No.	Rev	
		Sheet 104 of 117		

The final form for reports, which will be subject to OWNER's Approval, shall include as a minimum the following:

- a) Planning and Scheduling
- b) Work Progress
- c) Safety and Security

NOTES:



- a) Sample reporting forms and other key standard forms shall be included.
- b) Bidder shall state the extent to which he will be using computerized drafting, etc.

4.0 Job descriptions and personnel resumes

Bidder shall include job descriptions and personnel resumes of his staff nominated to the key positions, including (where applicable) at least the followings, or Bidder's equivalent:

- Project director
- Process engineering co-ordinator
- Construction manager
- Process engineer
- Project engineering co-ordinator
- Senior pre-commissioning engineer
- Senior commissioning engineer
- Training co-ordinator and instructor.
- Construction Engineering Coordinator
- Construction Quality Control Engineer
- Construction Project Control Engineer
- Welding Specialists
- Heavy Lift Rigging Specialist
- Senior Specialist Engineers
- Senior Planning Engineers
- Materials Coordinators
- Senior Construction Engineers
- Senior Pre-commissioning Engineers
- Warehousing Officer
- Material Planning Engineers

Resumes shall give at least the name, age, nationality, education, professional exception/deviation and previous experience of each assigned personnel. Additionally, one alternative shall be offered for each position. **Bidder shall ensure that personnel to be deployed meet the minimum criteria specified in Annexure-7-6**

	EMERGENCY DIESEL GENERATORS PACKAGE TALCHER FERTILIZERS LIMITED	PC183/E/4022/SecVI-5.0	0	
	CONSTRUCTION/ERECTION, PRE-COMMISSIONING, COMMISSIONING AND START-UP	Document No.	Rev	
		Sheet 105 of 117		

Bidder shall confirm that these key personnel will be made available to WORK on the Project as required by the schedule on full time basis.

Bidder shall furnish Summary of its Deployment Schedule Personnel as per **Annexure-7-7**.

Bidder understands that the said proposal represents the minimum deployment and the Bidder acknowledges that the said deployment may have to be augmented with additional number and/or categories, if required, if directed by Engineer-in-Charge in order to complete the work within the completion schedule and quoted lump sum price.

5.0 Construction equipment and machinery

The BIDDER shall furnish details of construction equipment & machinery, testing equipment, tools/tackles, etc., which will be made available by the Bidder at the Site. Bidder shall furnish Summary of such details as per **Annexure-7-8, Annexure-7-9**.

Such list shall, in no way limit the CONTRACTOR's responsibility to arrange & provide any additional construction equipment, tools, tackle, etc., which might be required to execute and complete the WORK as per contractual schedule.

BIDDER shall furnish the procedures and his tools for erection of the Heavy Lift Equipments including tall columns):

6.0 Heavy lifts

BIDDER shall furnish his proposed, site transportation, lifting, along with preliminary rigging schemes and erection procedure for the heavy lifts. Such plans / schemes shall be furnished along with detailed write -up on heavy cranes proposed to be deployed by CONTRACTOR, duly supported by relevant technical literature.

7.0 BIDDER experience & exception/deviation to perform the work

The BIDDER should have experience in the construction of similar Plants. The BIDDER should have successfully executed and completed construction of at least one similar Plant with his own project management and with complete responsibility of construction / erection and pre-commissioning.



The BIDDER shall furnish, as a part of his Tender Documents establishing the BIDDER'S experience and exception/deviation to perform the CONTRACT. Such documentary evidence shall also establish to OWNER's satisfaction that the BIDDER has the necessary financial, technical, project management capabilities and the requisite resources to execute the Work.

Such documentary evidence shall also be furnished for BIDDER'S proposed Subcontractors, if any. The Bidder shall furnish, in a tabular form, a list of jobs of similar type and magnitude executed by them in the past. BIDDER shall also furnish details of their experience in erection of heavy lifts. The Bidder shall furnish documentary evidence, establishing to OWNER satisfaction, that such jobs have been timely and successfully executed by them. The BIDDER shall also furnish the details of their present major commitments.

8.0 QA/QC Program

Bidder shall furnish a summary description of their proposed QA/QC program.

Bidder shall furnish any other technical information / details as per the requirements of ITB.

	EMERGENCY DIESEL GENERATORS PACKAGE TALCHER FERTILIZERS LIMITED	PC183/E/4022/SecVI-5.0	0	
	CONSTRUCTION/ERECTION, PRE-COMMISSIONING, COMMISSIONING AND START-UP	Document No.	Rev	
		Sheet 106 of 117		

9.0 Technical assistance

The extent of the Technical Services and Assistance to be rendered by CONTRACTOR for, commissioning and performance test run, etc., is to be proposed

10.0 Training

Bidder shall furnish the following details regarding the Training of OWNER'S personnel:

- a) Bidder's organisation set up for Training program.
- b) Training facilities available with the Bidder to train the OWNER'S personnel in
 - Theory of process, operation, maintenance and manufacturing of products
 - Field (on the job) training in process, operation, maintenance and manufacturing of products, to train the personnel on the job.
 - Test procedure and other matters.
- c) The courses and their duration, number of attendees in each course and location where such courses will be held that the Bidder would recommend OWNER to consider.
- d) Bidder's experience of training the personnel for units similar to the subject PLANT.

11.0 Estimate of the number of personnel required for the safe and satisfactory operation of the Plant.



For and on behalf of

Stamp & Signature :

Name :

Designation :



Date :

	EMERGENCY DIESEL GENERATORS PACKAGE TALCHER FERTILIZERS LIMITED	PC183/E/4022/SecVI-5.0	0	
		Document No.	Rev	
	CONSTRUCTION/ERECTION, PRE-COMMISSIONING, COMMISSIONING AND START-UP		Sheet 107 of 117	

ANNEXURE-7-6

Minimum Qualification & Exp. Of Key Supervisory Construction Personnel

SL. NO.	CATEGORY	QUALIFICATION & EXPERIENCE
1	RESIDENT CONSTRUCTION MANAGER / RESIDENT ENGINEER / SITE-IN-CHARGE	Degree in Engg. With minimum 20 years relevant experience in construction should successfully constructed & commissioned at least one process unit in hydrocarbon / fertilizer sector.
2	LEAD DISCIPLINE ENGINEER	Degree in relevant Engg. discipline with minimum 15 years experience in Construction or Diploma in relevant Engg. Discipline with minimum 20 years experience in Construction.
3	LEAD WELDING / NDT ENGINEER	Degree in Mechanical Engg./Metallurgy with minimum 15 years experience in Welding / NDT (Non-Destructive Testing) plus Level-II in RT (Radiographic Testing) or diploma in Mechanical Engg. / Metallurgy with minimum 20 years experience in Welding / NDT plus Level-II in RT.
4	LEAD QA/QC ENGINEER	Degree in Engg. With 15 years Construction Experience of which 5 years should be as QA Manager.
5	LEAD PLANNING ENGINEER	Degree in Engg. With 15 years experience in Planning & Scheduling.
6	LEAD SAFETY OFFICER	Degree / Diploma in Engg. And Diploma in Industrial Safety with min. 10 years relevant experience in Construction Safety.
7	WAREHOUSE-IN-CHARGE / MATERIALS MANAGER	Graduate in Science or Diploma in Engg. / Materials Management with 15 years experience in Warehousing / Stores Management of similar nature.
8	DISCIPLINE SURVEYORS	Degree in relevant Engineering Discipline with minimum 3 years experience in Construction or diploma in relevant Engineering Discipline with minimum 6 years experience in Construction.
9	QUANTITY SURVEYORS	Degree in relevant Engineering Discipline with minimum 3 years experience or diploma in relevant Engineering Discipline with minimum 6 years experience in quantity estimation, field measurement, rate analysis etc. in construction field.

	EMERGENCY DIESEL GENERATORS PACKAGE TALCHER FERTILIZERS LIMITED CONSTRUCTION/ERECTION, PRE-COMMISSIONING, COMMISSIONING AND START-UP	PC183/E/4022/SecVI-5.0	0	
		Document No.	Rev	
		Sheet 108 of 117		



For and on behalf of

Stamp & Signature :

Name :

Designation :



Date :

	EMERGENCY DIESEL GENERATORS PACKAGE TALCHER FERTILIZERS LIMITED	PC183/E/4022/SecVI-5.0	0	
	CONSTRUCTION/ERECTION, PRE-COMMISSIONING, COMMISSIONING AND START-UP	Document No.	Rev	
		Sheet 109 of 117		

ANNEXURE-7-7

Deployment Schedule of Supervisory Personnel

SL. NO.	DESCRIPTION	DEPLOYMENT SCHEDULE																				TOTAL			
		1	2	3	4	5	6	7	8	9	10		35	36	37
1	PROJECT MANAGEMENT																								
1.1	PROJECT MANAGER																								
1.2	PLANNING MANAGER																								
1.3	PLANNING ENGINEERS																								
2	RESIDUAL DESIGN AND DETAILED ENGINEERING																								
2.1	PROJECT ENGINEERING MANAGER																								
2.2	ENGINEERING COORDINATOR																								
2.3	ENGG. PERSONNEL FOR VARIOUS DISCIPLINE																								
2.3.1	CIVIL STRUCTURAL																								
(i)	ENGINEERS																								
2.3.2	PRESSURE VESSELS																								
2.3.3	MECHANICAL EQPT/ ROTARY EQPT.																								
2.3.4	PIPING																								
(i)	ENGINEERS																								
2.3.5	ELECTRICAL																								

	EMERGENCY DIESEL GENERATORS PACKAGE TALCHER FERTILIZERS LIMITED CONSTRUCTION/ERECTION, PRE-COMMISSIONING, COMMISSIONING AND START-UP	PC183/E/4022/SecVI-5.0	0	
		Document No.	Rev	
		Sheet 116 of 117		



For and on behalf of :...

Stamp & Signature :

Name :

Designation :

Date :

	EMERGENCY DIESEL GENERATORS PACKAGE TALCHER FERTILIZERS LIMITED CONSTRUCTION/ERECTION, PRE-COMMISSIONING, COMMISSIONING AND START-UP	PC183/E/4022/SecVI-5.0	0	
		Document No.	Rev	
		Sheet 117 of 117		

ANNEXURE-7-9

Details of Equipment Proposed to be used for Tendered Work

I / We shall use the following MAJOR equipments owned by the tenderer for the work, if awarded to me /us:

Sl. No	Description	Quantity. (Numbers)	Make	Capacity	Owner	Approximate date when it will be deployed at site	Period of retention at site

For and on behalf of

Stamp & Signature :

Name :

Designation :

Date :

 PROJECTS & DEVELOPMENT INDIA LIMITED	PC183/E/4022/SecVI-6.0	0	
	Document No.	Rev	
	Sheet 1 of 5		



SECTION: VI – 6.0

PERFORMANCE & GUARANTEE TESTS

PLANT : EMERGENCY DIESEL GENERATORS PACKAGE



**PROJECT : INTEGRATED COAL BASED FERTILISER
COMPLEX, AT TALCHER, ANGUL DISTRICT,
ODISHA**

0	06.09.2023	06.09.2023	Issued for Tender	DKG	SKB	SKB
REV	REV DATE	EFF DATE	PURPOSE	PREPD	REVWD	APPD

	EMERGENCY DIESEL GENERATORS PACKAGE TALCHER FERTILIZERS LIMITED PERFORMANCE & GUARANTEE TESTS	PC183/E/4022/SecVI-6.0	0	
		Document No.	Rev	
		Sheet 2 of 5		

CONTENTS

Section Number	Description	Sheet Number
1.0	Performance Guarantees	
2.0	Performance Tests	

	EMERGENCY DIESEL GENERATORS PACKAGE TALCHER FERTILIZERS LIMITED PERFORMANCE & GUARANTEE TESTS	PC183/E/4022/SecVI-6.0	0	
		Document No.	Rev	
		Sheet 3 of 5		

1.0 GENERAL

This section describes the guarantee parameter which Emergency Diesel Generator Package must fulfil and to avoid rejection of the Package plant by the Owner.

All Necessary instruments, accessories, Tools tackles etc. shall be provided/ arranged by the contractor without any additional cost during performance testing to establish the guarantee parameters.

The contractor shall guarantee the components/ equipment/ sub-system/complete system for the design, materials, workmanship, size, capacity, performance efficiency and compliance to various technical requirements mentioned in the tender document. The guarantee shall also include sub-ordered /bought out items forming part of the total supplies.

The contractor shall modify/ replace any part of equipment / component/ sub-system/ system/ auxiliaries/ accessories free of cost & without any time implication, if:

- (i) There is fault in design.
- (ii) There is defect in material or workmanship/manufacturing process and /or it does not comply with the fabrication requirement or there is wrong selection of material.
- (iii) It fails to achieve the capacity, requisite parameters, performance & efficiency requirements.
- (iv) It does not comply with the various requirements of the bid packages.
- (v) The material supplied is damaged during transit or during execution of work.
- (vi) The Sustained load test is not successful.
- (vii) Any other which is not covered in above points.

Owner's/ Consultant inspection OR review of vendor's design/ drawings/ documents/ deviations shall in no way absolve or reduce the Contractor's responsibility towards performance guarantee.



Performance guarantee shall be exclusive of instrument tolerances / uncertainties.

2.0 PERFORMANCE GUARANTEES

2.1 The contractor shall submit the detailed Performance Guarantee Test (PGTR) procedure along with the detailed calculations, supporting documents, measurement, data logging, basis & references for approval of the OWNER/ PMC prior to actual performance test run.



Contractor must fulfil guarantee parameters of Emergency Diesel Generator Package under the following heads to meet contractual obligations:-

- a. Capacity of DG Set.
- b. Emission
- c. Noise Level
- d. Consumption of Fuel

	EMERGENCY DIESEL GENERATORS PACKAGE TALCHER FERTILIZERS LIMITED PERFORMANCE & GUARANTEE TESTS	PC183/E/4022/SecVI-6.0	0	
		Document No.	Rev	
		Sheet 4 of 5		

Failure to meet the capacity of the Package, noise levels, emission, consumption of fuel etc. shall be the breach of contract and requires corrective action by contractor irrespective of the cost involved.

- 2.2 Each Generator shall be rated to deliver 2000 KVA (at 0.8 power factor) of power after deduction of all losses and power consumption in mechanical & electrical auxiliaries under specified site conditions. Contractor to indicate all losses and power consumption in mechanical & electrical auxiliaries.
- 2.3 Capacity mentioned for DG Set i.e. 2000 KVA, 0.8 P.F. are the minimum power capacity available at the output terminal of DG set hence engine capacities considering system losses, self utilizations and suitable de-rating.
- 2.4 The generator shall be designed to deliver rated output at 0.8 power factor. The system parameters shall be controlled such that voltage variations are held to $\pm 5\%$ and frequency $\pm 3\%$.
- 2.5 DG set shall be capable of starting from cold condition (Black Start), taking up full load without undue wear and stress on equipment under the specified ambient and system condition. Also DG set shall be stopped manually using push button, irrespective of the position of Auto/ manual selector switch located in generator control panel.
- 2.6 The Generator shall meet required performance as per G3 performance Class as per IS/IEC 60034 Part 22.
- 2.7 The windings shall not develop hot spots exceeding safe limit due to in imbalance of up to 25% between any two phases from no load to full load. The temperature rise of stator windings, exciter and other parts shall not exceed the limits specified in relevant IS.
- 2.8 The generator shall have an overload capacity of 10% for 1 hour in any consecutive period of 12 hours after having attained the thermal equilibrium corresponding to the rated load without exceeding permissible temperature limits and with a fairly clear visible exhaust.
- 2.9 The short circuit ratio, of the generator at rated KVA and rated voltage shall not be less than 0.5.
- 2.10 The generator shall withstand minimum 20% over speed for 2 minutes without any damage to any part as per IS-4722 / relevant IEC.
- 2.11 Total harmonic distortion shall be less than 5%.
- 2.12 At the time of switching 'ON' the loads, restarting or re-acceleration of squirrel cage motors may be required, which will be six times the rated load at power factor of 0.25 lagging in addition to switching 'ON' of the lighting loads. The generator and its accessories shall be capable of supplying this load at the above mentioned low power factor. Limitations, if any, shall be clearly indicated by the bidder.
- 2.13 The D.G. set shall be designed such that it can start largest squirrel cage induction motor of specified rating by DOL starting method when already loaded up to 80% of its rated load. The voltage dip at the generator terminal shall not exceed 10% of its rated voltage during the entire motor starting period which will not exceed approx. 5 seconds. Limitations of the engine size

	EMERGENCY DIESEL GENERATORS PACKAGE TALCHER FERTILIZERS LIMITED PERFORMANCE & GUARANTEE TESTS	PC183/E/4022/SecVI-6.0	0	
		Document No.	Rev	
		Sheet 5 of 5		

offered by the bidder, if any, shall be indicated clearly by the bidder.

Supporting calculation shall be supplied by the successful bidder for approval of the owner.

- 2.14 Generator shall be capable of withstanding effects of continuous current unbalance corresponding to the negative phase sequence current (8% of rated current) provided none of the phase current exceeds the rated current.
- 2.15 The generator shall be capable to withstand without any damage, short circuits current arises due to 3 phase/L-L/L-E/L-L-E faults for 3 second at rated speed and rated load with an excitation corresponding to 5% over voltage.
- 2.16 Total starting time from the receipt of starting impulse till the set reaches rated speed and generator set reaches rated voltage shall not be more than 20 second. Annunciation shall be provided in local DG control panel with a facility for repeat annunciation in owner's panel shall be provided if starting time of DG set shall exceed to 30 second.
- 2.17 The owner reserves the right to reject the DG set in the following conditions:
- i) Actual consumption of fuel during performance test at site not meets the criteria as per ISO-3046/ IS-10002 / BS.
 - ii) Actual output falls below 2000 KVA at site condition.

However, the Bidder will be given opportunity to rectify the defects in reasonable time and DG set may be accepted if it successfully passes the tests after rectification.

2.18 Gaseous Emission

Stack gas Emission Limits

S. No.	Source	Suspended Particulate Matter (mg/Nm ³)	(mg/Nm ³)	(mg/Nm ³)	(mg/Nm ³)
1.	Stack				

Contractor to follow latest norms pertaining to Central Pollution Control Board / State Pollution Control Board norms before submission of the bid.

2.19 Noise Level

Contractor shall guarantee the noise level within the Emergency Diesel Generator Package battery Limit. Noise nuisance from machinery is normally specified as sound pressure level which for standard design shall not exceed, in work areas, 85dB (a) at 1m distance from each source.

 पी डी आई एल PDIL	PROJECTS & DEVELOPMENT INDIA LIMITED	PC183/E/4022/SecVI-7.0	0	
		Document No.	Rev	
		Sheet 1 of 10		



SECTION : VI-6.0

DRAWINGS AND DOCUMENTS

PLANT : EMERGENCY DIESEL GENERATORS PACKAGE

**PROJECT : INTEGRATED COAL BASED FERTILISER
COMPLEX, AT TALCHER, ANGUL DISTRICT,
ODISHA**

0	06.09.2023	06.09.2023	Issued for Tender	DKG	SKB	SKB
REV	REV DATE	EFF DATE	PURPOSE	PREPD	REVWD	APPD



	EMERGENCY DIESEL GENERATORS PACKAGE TALCHER FERTILIZERS LIMITED DRAWINGS AND DOCUMENTS	PC183/E/4022/SecVI-7.0	0	
		Document No.	Rev	
		Sheet 2 of 10		

CONTENTS

Section Number	Description	Sheet Number
1.0	Drawings & Documents	3
2.0	Category of Documents	4
3.0	Procedure	6
4.0	List of Drawings & Documents	7

LIST OF ATTACHMENTS

Attachment Number	Description	Number of Sheets

	EMERGENCY DIESEL GENERATORS PACKAGE TALCHER FERTILIZERS LIMITED DRAWINGS AND DOCUMENTS	PC183/E/4022/SecVI-7.0	0	
		Document No.	Rev	
		Sheet 3 of 10		

1.0 DRAWINGS & DOCUMENTS

This chapter details out various drawings and documents to be generated at various stages during the course of execution of the Project by the Contractor for different project activities. Categorization of the documents/ drawings for review/ information/ records of PMC and the review/ approval requirements of the Owner/ PMC along with routing of the documents/ drawings will be conveyed separately as a philosophy.

The efficient handling of drawings and documents to be prepared by the Contractor under the contract is the key to the timely completion of the plants. The Contractor undertakes to ensure that all drawings and documents to be submitted by him to the Owner/ PMC shall be of professional quality and conforming to the contractual requirements. The Contractor also undertakes to institute a formal drawing control system which will be documented and submitted to the Owner/PMC for review or approval.

Compliance of this chapter on drawings and documents is mandatory and is non-negotiable.



The drawings / documents are to be generated by the Contractor at various stages of the project covering different activities. The drawings / documents generated will be in the category of Approval/ Review/ Information. The list of drawings and documents required is enclosed; however, the categorisation for the drawings/ documents will be informed separately. However, this will in no way relieve the Contractor of responsibility to conform to drawings, standards, specification, codes and contractual requirements / obligations.

The Contractor shall prepare the drawing numbering procedure and submit to Owner/ PMC for approval. Each Drawing submitted by the Contractor shall be clearly marked with the name of the Owner, PMC with revision number & date. It should contain the minimum following details:

- a. Size of Drawing.
- b. Discipline of Engineering for which the drawing is issued.
- c. Discipline wise segregation of numbering sequence for example:
200 Series for Mechanical etc.

Contractor to note that the number corresponds to Emergency Diesel Generators Package and shall be prefixed to all related documents/deliverables which shall be indicated to successful bidder.

All other documents like presentations etc. and other data shall be in MS Office; the required operating system for Data Exchange shall be at least Windows.

	EMERGENCY DIESEL GENERATORS PACKAGE TALCHER FERTILIZERS LIMITED DRAWINGS AND DOCUMENTS	PC183/E/4022/SecVI-7.0	0	
		Document No.	Rev	
		Sheet 4 of 10		

All documents before forwarding to Owner/PMC will have to be vetted in detail by the Contractor/duly approved engineering sub-contractor appointed by the Contractor. Document received without vetting will be returned.

The review by the PMC/Owner shall not be construed by the Contractor, as limiting any of his responsibilities and liabilities for mistakes and deviations from the requirements, specified under these specifications and drawings.

Each drawing submitted by the Contractor shall be clearly marked with the name of the Owner, Unit Designation, Specifications, Title, Specification number and the name of the Project with Revision number and date. If standards, catalogue pages are to be submitted, the applicable items shall be indicated therein. All titles, noting, markings and writings on the drawings shall be in English.



All the dimensions should be in metric units. Upon receiving comments on Drawings & Documents by the Contractor, the subsequent submission should give compliance report, separately on each of the comments, document-wise. Comments given by PMC/Owner to be discussed and finalised within agreed schedule.

The schedule of submission of the Drawings & Documents shall be in accordance with project plans only. The detailed list under different category, document-wise, shall be prepared by the Contractor for approval of Owner/PMC. This activity is to be completed within one month of Fax of Intent.

Sequence of submission of drawing is essential for proper review of documents and timely completion of the project is to be adhered. In case sequence is not maintained, the documents submitted will not be reviewed by Owner/ PMC and responsibility of timely execution of plant shall be to the Contractor's account.

2.0 CATEGORY OF DOCUMENTS

Category	Description	Action by Owner/ PMC
1	Records/ Information	Contractor can continue to progress with the work. This drawings or documents will be retained with Owner/PMC for information only. Owner/ PMC reserves the right to advise the Contractor of any comments (deviations from the contract) at any time and the contractor is liable to respond to satisfy that the work being done is in accordance with the contract; deviations, if any will be bidder's risk and cost.
2	Review	Owner/PMC will review and advise the Contractor of any

	EMERGENCY DIESEL GENERATORS PACKAGE TALCHER FERTILIZERS LIMITED DRAWINGS AND DOCUMENTS	PC183/E/4022/SecVI-7.0	0	
		Document No.	Rev	
		Sheet 5 of 10		

		<p>Comments on Contractor's Drawings / documents within specified schedule (ie 2 weeks), from date of receipt in PMC office of Contractor's drawings/documents. The review period is defined as date of receipt of documents by PMC, to date of issue of comments by PMC. This review period shall be valid only if submission of drawings is done by Contractor in accordance with approved drawings / documents schedule as indicated in ITB. In case of any non-conformity to the above by Contractor due to which the period of review extends beyond 2 weeks by the PMC, schedule delay, if any will have to be absorbed by the Contractor.</p>
--	--	--

The documents falling under Review category will be returned with comments within specified time schedules subject to fulfilling other conditions enumerated. The information category document will be retained for information only but however Owner/PMC reserves the right to comment at any stage of the Project, but not later than two weeks of receipt.

Where clearance of Owner/ PMC is required for ordering of equipment materials, enquiry documents and one technically selected offer is to be submitted for review. The unpriced copies of purchase orders detailing both technical and commercial aspects for all items shall be submitted to PMC/ Owner within 15 days of issue of the same.



Each purchase order forwarded should contain complete technical documents. It is obligatory for the Contractor to obtain acceptance on all the technical documents and accepted copy only to be forwarded to Owner / PMC. Any inaccuracies /omissions/inconsistencies noticed and brought to the notice of the Contractor at any stage of the project will be rectified/ replaced by Contractor without any cost & time implication to the Owner/ PMC.

Detailed manufacturing schedules of fabricated/ manufactured items shall be submitted within one month of ordering, Status report for all the items in detail, will be submitted once in a month.

Documents to Boiler Regulation authorities shall be submitted and getting the documents reviewed by PMC/Owner. To any other agencies, documents shall be submitted under intimation to PMC/Owner.

As built drawings and documents will be generated within one month of completion of activities on respective items of work.

As Built Drawings:

	EMERGENCY DIESEL GENERATORS PACKAGE TALCHER FERTILIZERS LIMITED DRAWINGS AND DOCUMENTS	PC183/E/4022/SecVI-7.0	0	
		Document No.	Rev	
		Sheet 6 of 10		



Contractor will furnish reproducible and electronic files of all the drawings under their scope to Owner / PMC, certified as "As-Built Issue" by Third Party Inspection Agency (TPIA) for Vendor Items coming under Third Party Inspection / Contractor for all other drawings.

Upon completion of identifiable units or components of the fabrication, construction and installation phase of the project the Contractor will complete all the related plans to the "as built" stage including all Vendor drawings and furnish Owner/PMC with the following:

- a. One complete set of all original tracings copies.
- b. One complete set of reduced size (A3-297x420 mm) copies of all drawings.
- c. One set of CD for all documents/drawings/data
- d. All the as built drawings duly certified should be scanned and converted into electronic files made on magnetic/discs/optical long storage.
- e. All other project documents such as operating and maintenance manuals, manufacturers' Catalogues etc. shall also be scanned on magnetic/optical discs for safe storage and retrievals by the Owner when needed.
- f. 10 complete sets of full size prints of the drawings and 4 sets of reduced size prints.
- g. 10 complete bound sets of Manufacturer's specifications including design calculations.
- h. 10 complete sets in hard binders of the Manufacturers data book including certified prints and data for all items including test reports. Data Books shall be complete with index as tag numbers associated with Manufacturer's data shown. Equipment data shall include as a minimum requirement the principal and description of operation, drawings and dimensions, spare parts lists and un-priced purchase orders and bill of material.
- i. 10 bound copies each of the Spare Parts data books and the Lubricants inventory Schedule.
- j. 10 complete sets of field records shall be signed by both the Contractor's and Owner's Representative at the site.
- k. Original approvals and related drawings and documents from the statutory authority.
- l. Copies of correspondence with the statutory authorities.



3.0 PROCEDURE

The procedure for compilation of final as-built documents / drawings shall be informed later. However the Procedure for routing the final / as built documents/ drawings to PMC / Owner shall be informed during the execution stage.



	EMERGENCY DIESEL GENERATORS PACKAGE TALCHER FERTILIZERS LIMITED DRAWINGS AND DOCUMENTS	PC183/E/4022/SecVI-7.0	0	
		Document No.	Rev	
		Sheet 7 of 10		

4.0 LIST OF DRAWINGS & DOCUMENTS

S. No	Description	With Bid (Y/N)	For Review/ Approval	For Information	Final/ Approved / As-built
A.	ELECTRICAL				
1.0	Load List indicating rated and absorbed power of loads and duty type (Continuous / Standby / Intermittent) at different voltages.	N	-	Y	Y
2.0	Load Data indicating normal, peak, starting and construction power requirement at various voltage levels.	N	-	Y	Y
3.0	Single line distribution diagram (power, lighting, DC supply and UPS supply) including protection and metering details giving rating of each equipment.	N	Y	-	Y
4.0	Filled in Specification Sheets / Datasheet and Technical Particulars, provided in the NIT	N	Y	-	Y
5.0	Specification Sheets and Technical Particulars of Electrical Equipment	N	Y	-	Y
6.0	General arrangement and foundation drawings of all equipment.	N	-	Y	Y
7.0	Equipment Layout in Panel Room, Control Room showing location of all electrical equipment.	N	Y	-	Y
8.0	Cable schedule.	N	Y	-	Y
9.0	Cable rack / trench / pipe layout.	N	Y	-	Y
10.0	Power Layout.	N	Y	-	Y
11.0	Schematic diagram for all control panel & switch boards.	N	Y	-	Y
12.0	Feeder Details of all switch boards / GIS	N	Y	-	Y
13.0	Interconnection & Terminal connection diagram	N	-	Y	Y
14.0	List of controls, interlocks, indication & metering at various locations for all drives.	N	-	Y	Y
15.0	Characteristic curves for motor/ relays etc.	N	-	Y	Y
16.0	Sizing Calculations for Electrical System and Equipment.	N	Y	-	Y



	EMERGENCY DIESEL GENERATORS PACKAGE TALCHER FERTILIZERS LIMITED DRAWINGS AND DOCUMENTS	PC183/E/4022/SecVI-7.0	0	
		Document No.	Rev	
		Sheet 8 of 10		

17.0	Earthing and lightning protection layout	N	Y	-	Y
18.0	Lighting layout and Distribution diagram	N	Y	-	Y
19.0	Drawings and documents asked for each equipment as per respective Technical Specifications	N	Y	-	Y
20.0	Control & operation write up/Block logic diagrams.	N	Y	-	Y
21.0	Catalogues for all bought out items	N	-	Y	Y
22.0	Bill of Materials covering all electrical equipment and installation materials	N	-	Y	Y
23.0	Installation operation and maintenance(Manual)	N	-	-	Y
24.0	Relay Co-ordination and settings	N	-	Y	Y
25.0	Spare Parts list	N	-	Y	Y
26.0	Test Certificates (Type Test, Routine Test)	N	-	Y	Y
27.0	Guarantee Certificates	N	-	Y	Y
28.0	Quality Assurance Plan & Formats	N	Y	-	Y
29.0	Erection Drawings & Details	N	Y	-	Y
30.0	Construction & Commissioning specification and procedure for all equipment.	N	-	Y	Y
31.0	Any other drawings & data as required for satisfactory installation, operation & maintenance.	N	Y	Y	Y
B	EOT Crane				
1.0	Data sheets – completely filled	N	Y		Y
2.0	Information to be supplied by manufacturer / Vendor	N	Y		Y
3.0	General arrangement Drg. showing various details & all principal dimensions of the assembled unit, horizontals and vertical clearances and approaches.	N	Y		Y
4.0	List of spare parts with individual part Nos. and prices.	N	Y		Y
5.0	Descriptive literature / catalogue	N	Y		Y
6.0	Detailed manufacturing programme Time-Bar Chart.	N	Y		Y

	EMERGENCY DIESEL GENERATORS PACKAGE TALCHER FERTILIZERS LIMITED DRAWINGS AND DOCUMENTS	PC183/E/4022/SecVI-7.0	0	
		Document No.	Rev	
		Sheet 9 of 10		

7.0	Individual structural drgs. For main girders and End-carriages.	N	Y	-	Y
8.0	Mechanical calculations (Brakes, Gear boxes, gears, pinions coupling, Bearing, Rope-drum, Wire-rope etc.	N	Y	-	Y
9.0	Civil load data drawing, Cross-sectional detailed drawings of sub-assemblies part nos., materials of construction and heat treatment details wherever applicable :	N	Y	-	Y
10.0	a) General Assembly Drg. Showing the complete mechanical details.	N	Y	-	Y
11.0	Crane rail & end stops fixing arrangement.	N	Y	-	Y
12.0	Material test certificates (including the originals) of load bearing parts e.g.	N	Y	-	Y
13.0	Crane rail & end stops fixing arrangement.	N	Y	-	Y
14.0	Material test certificates (including the originals) of load bearing parts e.g.	N	-	Y	Y
15.0	Test certificates of motors (including the originals)	N	-	Y	Y
16.0	Certificates of No load, load, over load deflection Test duly witnessed by the Inspector	N	-	Y	Y
17.0	Operation & Maintenance Manual (including the lubrication schedule also.)	N	-	Y	Y
18.0	Drg. Showing the supporting arrangement of flexible cable with main bridge and trolley.	N	Y		Y
C.	PIPING				
1.0	Piping Layout drg.	N	Y	-	Y
3.0	Filled in Valve Data Sheet.	N	Y	-	Y
9.0	Vendor Drawings	N	-	Y	Y
9.1	Valves	N	-	Y	-
10.0	As Built Drgs	N	-	-	Y
10.1	Piping GAD's	N	-	Y	Y

D.	GENERAL				
1.0	Master Time Schedule/Network	N	-	Y	Y

	EMERGENCY DIESEL GENERATORS PACKAGE TALCHER FERTILIZERS LIMITED DRAWINGS AND DOCUMENTS	PC183/E/4022/SecVI-7.0	0	
		Document No.	Rev	
		Sheet 10 of 10		

	(PERT Network/ Bar chart) showing all the activities				
2.0	Complete Recommended Spare Part List	N	-	Y	Y
3.0	List of all construction equipments, tool-tackles & man power resources proposed	N	-	Y	Y
4.0	Description and Catalogues of Auxiliary items	N	-	Y	Y

 पी डी आई एल PDIL	PROJECTS & DEVELOPMENT INDIA LIMITED	PC183/E/4022/SecVI-8.0	0	 Talcher Fertilizers
		Document No.	Rev	
		Sheet 1 of 9		



SECTION : VI – 7.0

SPARE PARTS

PLANT : EMERGENCY DIESEL GENERATORS PACKAGE

**PROJECT : INTEGRATED COAL BASED FERTILISER
COMPLEX, AT TALCHER, ANGUL DISTRICT,
ODISHA**

0	06.09.2023	06.09.2023	Issued for Tender	DKG	SKB	SKB
REV	REV DATE	EFF DATE	PURPOSE	PREPD	REVWD	APPD

	EMERGENCY DIESEL GENERATORS PACKAGE TALCHER FERTILIZERS LIMITED SPARE LIST	PC183/E/4022/SecVI-8.0	0	
		Document No.	Rev	
		Sheet 2 of 9		

CONTENTS

Section Number	Description	Sheet Number
1.0	Spare parts for Commissioning	3
2.0	Mandatory spare parts	3
2.1	EOT Cranes	3
2.2	Electrical Items	3
3.0	Vendor recommended spare parts	9
4.0	Maintenance Tools and Tackles	9

LIST OF ATTACHMENTS

Attachment Number	Description	Number of Sheets

	EMERGENCY DIESEL GENERATORS PACKAGE TALCHER FERTILIZERS LIMITED SPARE LIST	PC183/E/4022/SecVI-8.0	0	
		Document No.	Rev	
		Sheet 3 of 9		

1.0 SPARE PARTS FOR COMMISSIONING

- 1.1 Contractor shall supply free of cost all spares and consumables covering pre-commissioning, commissioning, testing, and till handing over of the Emergency Diesel Generators Package.
- 1.2 Supply of Mandatory Spares/Insurance spares for Electrical/Mechanical and other plant machinery shall be under Scope.
- 1.3 Supply of spares and consumables post handing over of the plant shall be under Owner's scope.
- 1.4 Contractor shall submit/provide recommended 2 years O&M spares (other than Mandatory spares) list with budgetary offers valid for 2 years from the date of submission of offer for TFL /Owners consideration..

2.0 MANDATORY SPARE PARTS

Contractor shall supply mandatory spare parts of the plant as detailed below.

- a) EOT cranes
- b) Electrical items

2.1 EOT Cranes :

SI. No.	DESCRIPTION	QUANTITY
1.	Wire rope for main hoist	1 set
2.	Wire rope for Auxiliary hoist	1 set
3.	Rope guide for main Hoist	1 set
4.	Rope guide for Auxiliary Hoist	1 set
5.	Brake linings of each type	2 sets
6.	Gear sets	2 sets
7.	All type of Bearings	2 sets
8.	All type of Seal, Gaskets , O-rings	2 sets

NOTE:

1. 'Set' means complete replacement of particular part in one machine.
2. The quotation should contain sectional drawing showing location & part no. (For exact identification) & material specification

2.2 Electrical Items:

Sr. No.	Item	Quantity
1.0	Neutral Earthing Resistor	
A.	Bushing with accessories	1 Set
B.	Support Insulators	2 Nos.
C.	Bushing Insulator	1 No.
D.	Resistor Element	20% minimum one cartridge per type

	EMERGENCY DIESEL GENERATORS PACKAGE TALCHER FERTILIZERS LIMITED SPARE LIST	PC183/E/4022/SecVI-8.0	0	
		Document No.	Rev	
		Sheet 4 of 9		

2.0	11 kV Switchboard	
A.	Complete VCB (ready to use) of each rating	1 No.
B.	Trip bar spring and any other spring used in the circuit breaker mechanism for breaker of each rating	1 No.
C.	Shunt trip coil for breaker of each rating	10%
D.	Closing coil for breaker of each rating	10%
E.	Spring charging motor of each rating	1 No.
F.	Spring charging handle for breaker of each rating	1 No.
G.	Racking out handles for breaker of each rating	1 No.
H.	Secondary Isolating contact blocks for breaker of each rating	1 No.
I.	Micro Switch for Test/ Service Position for breaker of each rating	1 No.
J.	Micro Switch for Spring Charging for breaker of each rating	1 No.
K.	Main contact sets/ Jaw contact, Moving coil, Fixed coil complete for breaker of each rating	1 Set
L.	Trip-Neutral-Close Control Switch	2 Nos.
M.	Local-OFF-Remote Selector Switch	2 Nos.
N.	Ammeter Selector Switch	2 Nos.
O.	Voltmeter Selector Switch	2 Nos.
P.	Push Button Element of each type & rating	20 %
Q.	Push Button Actuator of each type	20 %
R.	Trip Selector Switch	2 Nos.
S.	Panel limit switches & interlocking switches	10% each type
T.	Panel operating switches (all types)	1 Set each
U.	Breaker limit switches & interlocking switches	10% each type
V.	Protection Relays for different type of feeders i.e Incoming Feeder, Bus-coupler Feeder, Outgoing feeder, Motor Feeder, Transformer Feeder etc.	1 No. for each type of feeder
W.	Trip relays of each type	2 Nos
X.	Auxiliary Relays of each Type	2 Nos.
Y.	Miniature Circuit Breaker of each type & rating	20 %
Z.	Meters (of each type & rating) i) Ammeter ii) Voltmeter iii) Multifunction Meter iv) Energy Meter	1 No. 1 No. 1 No. 1 No.
AA.	Instrument Transformers of each type & rating i) CT ii) PT	3 Nos. 1 Nos.
BB.	Fuses of each type & rating i) HRC HV for VT ii) HRC LV	20 % 20 %
CC.	Lamp Complete assembly of each colour & voltage	10%
DD.	Current transducers of each rating	20%
EE.	Voltage transducers of each rating	20%
FF.	Power Transducers of each rating	20%
GG.	Bus-Bar Support Insulators	1 Set
HH.	Surge Arrestors	1 No.
II.	Inspection Glass	3 Nos.
JJ.	Sprouts	1 Set

	EMERGENCY DIESEL GENERATORS PACKAGE TALCHER FERTILIZERS LIMITED SPARE LIST	PC183/E/4022/SecVI-8.0	0	
		Document No.	Rev	
		Sheet 5 of 9		

KK.	Panel Space Heaters with Thermostat	2 Nos.
LL.	Alarm Annunciator of each type	1 No.
MM.	Interpanel insulation barriers	20% Minimum 1 No.
NN.	Earthing Trolley	1 No.
OO.	Maintenance Trolley for breaker of all rating	1 No.
PP.	Set of gaskets for all ratings & type	1 Set
QQ.	Panel shutter assembly	2 No.
RR.	Removable bus bar shrouds	1 Set
SS.	Bus bar mounted power fix contacts	1 Set
TT.	Ethernet Switch of each type	1 Set
3.0 Each LT (415V) Switchboard (PMCC/MCC/DCDB/ UPSDB/ LSDB)		
A.	Complete ACB (ready to use) of each rating	1 No.
B.	Trip coils for breaker of each rating	10%
C.	Closing coils for breaker of each rating	10%
D.	Spring charging motors of each rating	1 No.
E.	Secondary Isolating contact blocks for breaker of each rating	1 Set.
F.	Arcing contacts & arcing chutes block for breaker of each rating	1 Set.
G.	Main contact sets/ Jaw contact compete for breaker of each rating	1 Sets
H.	Trip-Neutral-Close Control Switch	2 Nos.
I.	Local-OFF-Remote Selector Switch	2 Nos.
J.	Ammeter Selector Switch	2 Nos.
K.	Voltmeter Selector Switch	2 Nos.
L.	Push Button Element of each type & rating	20 %
M.	Push Button Actuator of each type	20 %
N.	Trip Selector Switch	2 Nos.
O.	Panel limit switches & interlocking switches	10% each type
P.	Panel operating switches (all types)	1 Set each
Q.	Breaker limit switches & interlocking switches	10% each type
R.	Protection Relays for different type of feeders i.e Incoming Feeder, Buscoupler Feeder, Outgoing feeder, Motor Feeder etc.	1 No. for each type of feeder
S.	Trip relays of each type	2 Nos
T.	Auxiliary Relays of each Type	2 Nos.
U.	Thermal over Load Relay of each rating	2 Nos.
V.	Contactors of each type & rating	2 Nos.
W.	Coils for Contactors – each type/voltage	2 Nos.
X.	ELCB & RCBO of each type	2 Nos.
Y.	Miniature Circuit Breaker of each type & rating	20 %
Z.	SFU of each rating	20 %

	EMERGENCY DIESEL GENERATORS PACKAGE TALCHER FERTILIZERS LIMITED SPARE LIST	PC183/E/4022/SecVI-8.0	0	
		Document No.	Rev	
		Sheet 6 of 9		

AA.	Meters (of each type & rating) i) Ammeter ii) Voltmeter iii) Multifunction Meter iv) Energy Meter	1 No. 1 No. 1 No. 1 No.
BB.	Instrument Transformers of each type & rating i) CT ii) PT	3 Nos. 1 Nos.
CC.	Fuses of of each type & rating HRC LV	20 %
DD.	Lamp Complete assembly of each colour& voltage	10%
EE.	Current transducers of each rating	20%
FF.	Voltage transducers of each rating	20%
GG.	Power Transducers of each rating	20%
HH.	Bus-Bar Support Insulators	1 Set
II.	Panel Space Heaters with Thermostat	2 Nos.
JJ.	Alarm Annunciator of each type	1 No.
KK.	Interpanel insulation barriers	20% Minimum 1 No
LL.	Maintenance Trolley for breaker of all rating	1 No.
MM.	Set of gaskets for all ratings & type	1 Set
NN.	Panel shutter assembly	2 Nos.

OO.	Removable bus bar shrouds	1 Set
PP.	Bus bar mounted power fix contacts	1 Set
QQ.	Ethernet Switch of each type	1 Set

4.0 Bus Duct



A.	Bus support insulators each type	2 Nos.
B.	Flexible connector (for switchgear end connection)	1 Set
C.	Flexible connector (for Transformer end connection)	1 Set
D.	Gasket	1 Set
E.	Bus duct CT's / VT's	1 Set
F.	Set of special tools, for dismantling and maintenance	1 Set

5.0 LV Motor (For each rating)

A.	Bearings housing (complete with End Shield) both Driving End and Non driving end	1 set
B.	Cooling fan	2 No.
C.	Terminal box	1 No.
D.	Terminal stud with bushing & star links	1 No.
E.	Space heater, if installed	2 Nos.
F.	Grease nipple & Plug, if installed	2 Nos.
G.	Cooling fan cover	1 No.

6.0 Battery Charger

A.	Set of diodes of each type and rating	2 Sets
B.	Set of silicon controlled Rectifiers	2 Sets
C.	Set of chokes of each type and rating	1 Set
D.	Set of resistors of each type and rating	1 Set

	EMERGENCY DIESEL GENERATORS PACKAGE TALCHER FERTILIZERS LIMITED SPARE LIST	PC183/E/4022/SecVI-8.0	0	
		Document No.	Rev	
		Sheet 7 of 9		
E.	Set of capacitors of each type and rating	1 Set		
F.	Set of transistors of each type and rating	1 Set		
G.	Set of load breaking switches of each type and rating	1 Set		
H.	Off-Load Tap Changing Device	1 Set		
I.	Current Regulator	1 Set		
J.	Semiconductor fuses of each type and rating	3 Nos.		
K.	Set of contactors of each type and rating	2 Sets		
L.	Set of thermal overload relays of each type and rating	2 Sets		
M.	Set of auxiliary contactors of each type and rating	2 Sets		
N.	Set of power contactors of each type and rating	2 Sets		
O.	Set of control and selector switches of each type and rating	2 Sets		
P.	Set of controller cards of each installed charger	2 Sets		
Q.	Indicating lights of each colour & voltage	2 Sets		
R.	D.C. Ammeter	1 No.		
S.	Miniature circuit Breaker of each type & rating	1 No.		
T.	PCB's of each type	1 No.		
U.	Float indicator	1 No.		
V.	Thermometer	1 No.		
W.	Under, over voltage and earth leakage protection devices	1 No.		
X.	Panel / cabinet space heater	2 Nos.		
Y.	Thermostat	2 Nos.		
7.0	Each Battery Bank			
A.	Complete cells of each type	4 Sets		
B.	Float guide	2 Nos.		
C.	Cell lid	2 Nos.		
D.	Level indicators	2 Nos.		
E.	Vent plugs	2 Nos.		
F.	Inter cell connectors with nuts, bolts and washers	2 Sets		
G.	P.V.C. Spill Trays	2 Sets		
H.	Terminal Post	2 Sets		
8.0	Local Control Station			
A.	Trip – neutral – close switch	20%		
B.	Auto Manual / Local -Remote switch	20%		
C.	Ammeters of different ranges	20%		
D.	Terminal block	20%		
E.	Indicating Lamps of different type	20%		
F.	Push Buttons of different type	20%		
G.	Complete LCS of each type	20%		
9.0	Junction Box			
A.	Junction Box of each type	10 Sets		

	EMERGENCY DIESEL GENERATORS PACKAGE TALCHER FERTILIZERS LIMITED SPARE LIST	PC183/E/4022/SecVI-8.0	0	
		Document No.	Rev	
		Sheet 8 of 9		



10.0	Electricals for Overhead Cranes & Hoists (per crane/hoist)	
A.	Bearings of each type & no.	1 Set
B.	Contactors of various ratings	1 Set
C.	Complete set of contactors of each rating	1 Set
D.	Limit switches of each type	2 Nos.
E.	Push Button Elements	20%
F.	Push Button Actuators	20%

G.	Fuses of various ratings	20%
H.	Fuse fittings of various ratings	20%
I.	Indication lamp fittings of each type	20%
J.	Overload relays of various ranges	1 Set
K.	Brake coils for various brakes	1 Set
L.	Set of carbon brushes in case of S.R. motors	1 Set
M.	Set of resistors for S.R. motors	1 Set
N.	Any special tools and tackles required for maintenance	1 Set

11.0	Each ANNUNCIATOR PANEL	
A.	Hooters	1 No.
B.	Push Buttons of each type	3 Sets
C.	Terminals	3 Nos.
D.	Acrylics	1 No.
E.	PCB card of each type	1 No.
F.	LED of each colour & voltage	3 Sets
G.	DIP Switches	3 Nos.
H.	CPU	1 No.
I.	SMPS	1 No.
J.	Relays of each type	20% (Min. 1 No.)

	DG Set	
A	Generator relay	1 Set each
B	Exciter Diodes and fuses	1 Set each
C	Lube oil filter,	1 Set each
D	Air Filters	1 Set each
E	Fuel Filter	1 Set each

- 1) Set means complete replacement of particular part in one machine.
- 2) Wherever "Each Type" is specified, it means "of the Type/make/model/size/rating and exactly replaceable"
- 3) Wherever "% qty." is specified, Bidder to quote in next higher rounded figure
- 4) Out of % age spares and minimum qty specified against each item - higher of the two shall be supplied.
- 5) Electrical EQUIPMENT which has not been mentioned in this table and needs spare parts, CONTRACTOR shall consider spare parts for them, the quantities for such spare parts shall then be APPROVED by OWNER/CONSULTANT.

	EMERGENCY DIESEL GENERATORS PACKAGE TALCHER FERTILIZERS LIMITED SPARE LIST	PC183/E/4022/SecVI-8.0	0	
		Document No.	Rev	
		Sheet 9 of 9		

3.0 VENDOR'S RECOMMENDED SPARE PARTS

Contractor shall submit list of recommended spare parts of specialised items not covered under Mandatory spares, along with itemised price. Owner will review and decide the recommended spares required for the project.

General Notes:



- 1) The above spares do not include installed spares / commissioning spares. The above shall be Mandatory spares only.
- 2) Set means complete replacement of particular part in one machine/equipment/Fired heater etc.
- 3) Item wise price against each item shall be furnished.
- 4) Wherever "Each Type" is specified, it means "of the Type/make/model/size/rating and exactly replaceable"
- 5) Wherever "% qty." is specified, Contractor to quote in next higher rounded figure
- 6) Out of % age spares and minimum qty specified against each item - higher of the two shall be supplied.
- 7) Spares mentioned above to be offered as mandatory spares. However, if these spares are not used in the equipments being offered / supplied, the same need not be supplied. Bidder shall clearly indicate against each such spare that these spares / items are not used in their equipments.
- 8) The above is owner's recommended list of spares. The supplier may add other items as per their recommendations.
- 9) The quotation should contain sectional drawing showing location & part no. (For exact identification) & material specification.
- 10) **Contractor to supply all commissioning spares for all necessary equipment's for smooth & trouble free operation of complete system.**

Contractor to supply all mandatory spares parts as per the list for all necessary equipment's for smooth & trouble free operation of complete system.

Item-wise Price List to be furnished by Contractor with validity of 2 Years for 2 years Bidder's recommended Operational Spares (other than mandatory spares) for smooth & trouble free operation of complete system. However these prices shall not be part of bid.

4.0 MAINTENANCE TOOLS AND TACKLES

The Contractor shall include all necessary maintenance tools required for maintenance of the Emergency Diesel Generator Package supplied by him. The tools included by the Contractor shall cover all minimum maintenance tools considered necessary by the Contractor. A comprehensive list of maintenance tools shall be furnished. For some of the equipment/systems, requirement of maintenance tools and tackles has been specified in Data Sheets. Contractor shall necessarily supply these tools in addition to other tools and tackles as required.

 PROJECTS & DEVELOPMENT INDIA LTD.	PC183/E/4022/SecVI-9.0	0	
	Document No.	Rev	
	Sheet 1 of 13		

SECTION – VI - 9.0
SITE WORKING AND SAFETY CONDITIONS

PLANT : EMERGENCY DIESEL GENERATORS PACKAGE

PROJECT : INTEGRATED COAL BASED FERTILISER COMPLEX, AT TALCHER, ANGUL DISTRICT, ODISHA

0	06.09.2023	Issued for Tender	JKY	JKY	RRK
REV	REV ATE	PURPOSE	PREPD	REVWD	APPD





 EMERGENCY DIESEL GENERATORS PACKAGE TALCHER FERTILIZERS LIMITED	PC183/E/4022/SecVI-9.0	0	
	Document No.	Rev	
	Sheet 2 of 13		

TABLE OF CONTENTS

SL. NO.	DESCRIPTION	SHEET NUMBER
1.	SITE LOCATION	
2.	SITE ESTABLISHMENT	
3.	SUPERVISION OF WORK	
4.	INSPECTION	
5.	EMPLOYMENT OF LABOUR	
6.	COMPLETION OF WORK	
7.	WORKING AND SAFETY REGULATIONS	
8.	ELECTRICAL SAFETY REGULATIONS	
9.	REPORTING	
10.	GENERAL SAFETY REQUIREMENTS TO BE OBSERVED DURING SITE FABRICATION AND ERECTION BY THE CONTRACTOR	



	EMERGENCY DIESEL GENERATORS PACKAGE TALCHER FERTILIZERS LIMITED	PC183/E/4022/SecVI-9.0	0	
	SITE WORKING AND SAFETY CONDITIONS	Document No.	Rev	
	Sheet 3 of 13			

1.0 SITE LOCATION

The proposed project will be located within the premises of existing closed coal based Ammonia- urea complex of TALCHER FERTILIZERS LIMITED, Talcher, ANGUL DISTRICT, ODISHA (INDIA).

2.0 SITE ESTABLISHMENT

- 2.1 The LSTK CONTRACTOR shall provide all huts, stores, tarpaulins and other covers for the accommodation of his staff, workmen and materials. All materials likely to deteriorate in the open shall be stored under suitable cover.
- 2.2 The LSTK contractor shall advise the owner within 15 days of the placement of LOI his space requirement which shall include for office, covered storage, open storage, fabrication space, etc. Depending on availability & requirement, space shall be allotted to the contractor for the duration of this contract. He will not be permitted to make use of any other space without the sanction of the Owner. The use of this space shall strictly be made for the execution of this contract only. The sanitary conditions of the ground in or around such structures shall, at all times, be maintained by the contractor in a manner satisfactory to the owner.
- 2.3 The security of the LSTK contractor's equipment and materials is his own responsibility.
- 2.4 The LSTK contractor's shall clear away periodically any rubbish, scrap materials, etc. and dump the same in the area indicated by the OWNER/PMC. All construction material shall be neatly stacked in an orderly manner as directed by the owner and care shall be taken to allow proper access to workmen and easy movement of men, vehicles, cranes and materials.
- 2.5 The LSTK contractor shall maintain all the drawings carefully mounted on the board of appropriate size and well protected from the ravages of weather termites and other insects.
- 2.6 The LSTK contractor shall not permit the entry to the site of any person not directly connected/concerned with the work without first having obtained the written permission of OWNER.
- 2.7 The LSTK contractor shall submit a list of plant, equipments, tools, tackles, etc. which he will use, to perform the work. The contractor shall submit a list in duplicate of all materials, tools and tackles etc. brought inside the plant site duly signed by owner's security staff as per the rules laid by owner. These tools, etc. shall not be removed from the site till the completion of job. A gate pass must be obtained from the owner in order to remove from site any plant, machinery, tools, materials and equipment.
- 2.8 All items such as instructions and other pertinent data regarding erection/commissioning and maintenance should be typed and classified for transmittal in a manner approved by the owner.

	EMERGENCY DIESEL GENERATORS PACKAGE TALCHER FERTILIZERS LIMITED	PC183/E/4022/SecVI-9.0	0	
	SITE WORKING AND SAFETY CONDITIONS	Document No.	Rev	
	Sheet 4 of 13			

2.9 All employees of the LSTK contractor shall conform to any rules of conduct, etc. established by owner. Failure to comply with the rules of conduct will be sufficient cause for removal of such person from the site.

2.10 The LSTK contractor will be responsible for providing all plant, tools and tackles, consumables and scaffolding required for the execution of his work as per the best engineering practices.

2.11 The receipt, unloading, movement and storage at site of all the LSTK contractor plant, tools and materials is his responsibility. The receipt, movement & storage of material issued by owner also shall be the responsibility of the LSTK CONTRACTOR/CONSTRUCTION CONTRACTOR.

2.12 **ELECTRICITY**

DELETED

2.13 **CONSTRUCTION WATER**

DELETED

2.14 **FIRST AID**

The LSTK contractor may have access to the Owner's qualified first aid personnel and ambulance, in case of accidents, if available. The contractor will, however provide a first aid post for minor injuries to their staff.

3.0 SUPERVISION OF WORK

3.1 The LSTK contractor shall submit to the Owner resume of his site supervisors for approval prior to commencement of the work. Once approved, the LSTK contractor shall not remove his site supervisors without prior concurrence of the Owner.



3.2 The entire work is to be completed as per the agreed time schedule. The programme of work in details shall be submitted by the LSTK contractor before commencement of work. The detailed programmes prepared by the LSTK contractor shall conform to the targets set forth in the time schedule and will be subject to the approval of the owner. All the work shall be carried out in such a manner that the work of other agencies at site is not hampered due to any action of the LSTK contractor.

4.0 INSPECTION

The work of the LSTK contractor shall be subject to inspection by the OWNER/PMC at all times.

5.0 EMPLOYMENT OF LABOUR

5.1 The LSTK contractor will be expected to employ on the work only his regular skilled employees with experience of this particular work. The permission of the Owner must be obtained before tradesman is recruited locally for the work. This rule does not apply to unskilled labour. No female labour shall be employed in dark hours/ i.e.

	EMERGENCY DIESEL GENERATORS PACKAGE TALCHER FERTILIZERS LIMITED	PC183/E/4022/SecVI-9.0	0	
	SITE WORKING AND SAFETY CONDITIONS	Document No.	Rev	
	Sheet 5 of 13			

hours prohibited under the applicable law. No person below the age of eighteen years shall be employed at any point of time.



- 5.2 All traveling expenses including provision of all necessary transport to and from site, lodging allowances and other payments to the LSTK contractor employees are his own responsibility.
- 5.3 The hours of work on LSTK Contractors / Owner and contractor shall adhere to the same.
- 5.4 All Construction contractors employees shall wear safety helmet and such identification marks as may be provided by LSTK contractor on work site and duly approved by Owner.
- 5.5 All notices displayed on the site and any instructions issued by the Owner shall be strictly adhered to by the LSTK Contractors and/or his LSTK contractor employees.
- 5.6 It shall be the responsibility of LSTK contractor to provide suitable accommodation including necessary facilities for their labour and staff.
- 5.7 LSTK contractor will arrange ID-CARD and Permits for labour as per statutory provisions for its labour, as necessary.
- 5.8 The LSTK contractor shall be required to maintain employment records as covered in relevant Acts and produce documentary evidence to the effect that he has discharged his obligations under the Employees Provident Fund Act 1952 for the workmen working at site.
- 5.9 In case the Owner becomes liable to pay any wages or dues to the labour of the LSTK Contractors or his contractor or any Govt. agency under any of the provision of the Minimum Wages Act, Workmen Compensation Act or any other law due to act of omission of the contractor, the Owner may make such payment and shall recover the sum from Contractor's bills or any other dues.

6.0 COMPLETION OF WORK

Before finally leaving site, all the LSTK contractor store, huts, plant, tools and rubbish shall be removed and the site left clean and tidy. The space allocated by Owner shall be vacated and handed over to the Owner.

7.0 WORKING AND SAFETY REGULATIONS

- 7.1 The LSTK Contractor shall observe all statutory safety and legal requirements regulations issued by Central and State Governments applicable to the work as well as any local regulations applicable to the site issue by the consultant or any other authority.
- 7.2 Particular attention is drawn to the following:
 - a) In case of accident, the Owner shall be informed in writing forthwith.
The LSTK Contractor shall strictly follow regulations laid down by Factory Inspector, Govt. and State authorities in this regard.

	EMERGENCY DIESEL GENERATORS PACKAGE TALCHER FERTILIZERS LIMITED	PC183/E/4022/SecVI-9.0	0	
	SITE WORKING AND SAFETY CONDITIONS	Document No.	Rev	
	Sheet 6 of 13			

- b) LSTK contractor shall fence his plant, platforms, excavations etc.
- c) Compliance with all electricity regulations.
- d) Compliance with statutory requirements for inspection and test of all lifting appliances and auxiliary lifting gear.
- e) Safety belts proposed to be used, shall be got checked by Fire & Safety Department of LSTK Contractor / OWNER in written before use.
- f) Before using the lifting or pulling equipment, LSTK contractor shall carryout load test which shall be witnessed by LSTK Contractor / OWNER.

7.3 Staircase, doors or gangways shall not be obstructed in any way that will interfere with means of access of escape.

7.4 No excavations will be started without the permission of the PMC / OWNER, who will inform the LSTK contractor of the position of any pipes or cables known to be buried in the area. All excavations must be effectively railed off at all times, or completely boarded over properly marked during the hours of darkness by red warning lamps, using Flame proof warning lamps in non smoking areas. Debris or material which cannot be immediately removed must be heaped in such a way as to be immediately remove and also to leave adequate passage way. Any finds such as relics or antiques coins or fossils etc. shall be promptly handed over to the Owner.

7.5 The LSTK contractor will notify the Owner of his intention to bring on the site any equipment, such as, space heating or welding apparatus or any container holding liquid or gaseous fuel or other substance which might create a hazard. The Owner will have a right to prohibit the use of such equipment or to prescribe the conditions under which such equipment may be used. The LSTK Contractor will have the right to inspect any construction plant, and to forbid its use if in his opinion it is un-suitable or unsafe. No claim arising there from shall be made by the LSTK Contractor.



The LSTK contractor or any one acting on his instructions will not bring on to the site any radio active substance or any apparatus using such substances or any X ray apparatus until written permission and direction regarding the use of such equipment has been received from the Owner.

The LSTK contractor shall be responsible for the safe storage of the radio graphic sources or those of his Construction contractors.

7.6 The LSTK contractor will meet all requirements, and act on the instructions of the Owner where it is necessary to operate a permit to work system.

7.7 Where it is necessary to provide and/or store petroleum products or petroleum mixtures and explosive, the LSTK contractor shall be responsible for carrying out such provision and/or storage in accordance with the rules and regulation laid down in Petroleum Act 1934, Explosive Act 1948 and Petroleum and Carbide of Calcium Manual Published by the Chief Inspector of Explosive of India. All such storage shall have prior approvals of the OWNER/PMC. In case any approval or clearance from Explosive or any statutory authorities is required, the contractor shall be responsible for obtaining the same.

7.8 The LSTK contractor shall have his own Fire Fighting Extinguishers and Equipment.

	EMERGENCY DIESEL GENERATORS PACKAGE TALCHER FERTILIZERS LIMITED	PC183/E/4022/SecVI-9.0	0	
	SITE WORKING AND SAFETY CONDITIONS	Document No.	Rev	
	Sheet 7 of 13			

7.9 The LSTK contractor shall be responsible for the provision of all safety notices safety equipments including the safety gadgets for his workmen required by both the relevant legislation and such as the Owner may deem necessary.

7.10 While working at heights, safety belts with lifeline shall necessarily be used.

7.11 “LSTK contractor shall employ a safety officer for safe executing the construction activities of the project who will be responsible for implementing safety requirement contained in the documents.

The safety officer shall possess a recognised degree in engineering discipline preferably, F&S or (Any branch of engineering) and had a post qualification construction experience of minimum two years.

In addition, he/she shall also possess a recognised degree or diploma in industrial safety and preferably have adequate knowledge of the language spoken by majority of the workers at the construction sites.

Contractor shall ensure physical presence of safety personnel at each work location wherever Hot Work permit is required. No work shall be started at site until above safety personnel are physically present at site. The contractor shall submit a safety organogram clearly indicating the lines of responsibility and reporting system and elaborate the responsibilities of safety personnel in the HSE MAUAL/Program. The contractor should furnish Bio-Data/Resume of the safety personnel as above, at least 01 month before the mobilization for PMC/OWNER’S approval.

7.12 LSTK contractor shall use only steel planks and clamps executing scaffolding. Wooden planks and rope shall not be allowed for this purpose.

7.13 LSTK contractor shall use asbestos cloth to ensure falling of weld spatters down below during above ground welding to ensure safety of electrical cables and personnel and avoiding any fire hazards.



8.0 ELECTRICAL SAFETY REGULATIONS

8.1 In no circumstances will the LSTK contractor interfere with fuse and electrical equipment belonging to the owner or other contractors.

8.2 Before the LSTK contractor connects any electrical appliances to any plug or socket belonging to the other contractor or owner, he will -

- i. Satisfy the Owner that the appliance is in good working condition.
- ii. Uses of matching sixes plug & does not uses bare wire to insert in socket.
- iii. Inform the Owner of the maximum current rating, voltage and phase of appliance.
- iv. Obtain permission of the Owner dealing the sockets to which the appliance may be connected.
- v. Use distribution board with ELCB for feeding power to hand held tools.

8.3 The Owner will not grant permission to plug in until he is satisfied that-

	EMERGENCY DIESEL GENERATORS PACKAGE TALCHER FERTILIZERS LIMITED	PC183/E/4022/SecVI-9.0	0	
	SITE WORKING AND SAFETY CONDITIONS	Document No.	Rev	
	Sheet 8 of 13			

- i. The appliance is in good condition and is fitted with a suitable plug.
- ii. The appliance is fitted with a suitable cable having two earth conductors, one of which shall be earthed metal sheath surrounding the cores.

8.4 No electric cable in use by the other LSTK contractor/owner will be distributed without prior permission. No weight of any description be imposed on any such cable and no ladder or similar equipment will rest against or be attached to it. Cables / Wires used shall be in good condition without cuts & in insulation & joints.

8.5 The voltage for all portable equipment e.g. drilling machines, temporary lighting etc. will not exceed 240 volts.

8.6 No work must be carried out on any live equipment. The equipment must be made safe and a “permit to work” issued before any work is carried out.

8.7 LSTK contractor shall employ electrician to maintain his temporary electrical installation.



8.8 Take necessary clearance for working in hazardous area.

9.0 REPORTING



- a) The LSTK contractor must report the following information to the Owner in writing daily. Number of men employed, trades-wise,
 - Progress achieved;
 - Concrete pour card, if any.
- b) If during excavation any materials such as but not limited to precious materials or treasure troves etc are found, the same shall be reported to owner immediately and shall be the property of owner.

10.0 GENERAL SAFETY REQUIREMENTS TO BE OBSERVED DURING SITE FABRICATION AND ERECTION BY THE CONSTRUCTION CONTRACTOR



1. Before starting the work, **LSTK contractor** should get safety work permit and should strictly follow instructions written by the concerned authority in work permit. Permit is required for all types of job i.e. Hot, Cold Excavation, Chipping, Grinding etc.
2. Smoking is strictly prohibited inside factory areas.
3. Safety appraisal and equipments shall be provided to workmen as per the nature of work. Welders shall use gloves, goggles, shields etc. during welding, gas cutting etc. All technicians shall use gloves, goggles during grinding, chipping etc. If any unsafe practice is observed Fire & Safety Sections or the authority issuing the work permit is authorized to stop the work without any prior notice.

	EMERGENCY DIESEL GENERATORS PACKAGE TALCHER FERTILIZERS LIMITED	PC183/E/4022/SecVI-9.0	0	
	SITE WORKING AND SAFETY CONDITIONS	Document No.	Rev	
	Sheet 9 of 13			

4. Temporary fire extinguishers, water hose shall be available near work place and in case of fire, Owner's Fire & Safety Section should be immediately informed by LSTK contractor from nearest available telephone. Project Manager should also be immediately informed.
5. LSTK contractor shall secure necessary insurance of his workmen for the entire duration of works under the contract. Owner is not responsible for any accident/injury caused whatsoever, to any person employed by the Construction Contractor. However, LSTK contractor has to inform Owner's Fire & Safety Section about accident, if any, immediately.
6. Temporary switch boards, cables, wires and electrical equipments should be installed in accordance with standard electrical practice with proper earthing etc. and should have prior approval of LSTK Contractor / Owner electrical engineer. Switch board shall be suitably protected against rainwater. The cable used for welding machine should have flexible tough rubber sheathing.
7. Temporary cables and wires including welding cables should be routed as not to cluster the work areas. Also any possibility of damage to live wires by falling objects should be avoided. Temporary electrical lines for power & lighting shall run overhead or underground so that they should not hinder the movement of men, materials and vehicles.
8. Portable hand lamps being used by construction crew shall be preferably of 24 Volts supply bulb to be protected with safety shields.
9. Earthing for welding shall not be taken through existing structure or equipments due to the very explosive nature of the plant, raw materials, reaction during process and final product. There is every possibility of fire and explosion in the equipment due to electric spark caused by loose earthing connection etc.
10. LSTK contractor should be careful while excavating so that no underground cable or pipe line is damaged. As soon as any brick cover or under ground cables are exposed he should stop the work and inform Construction Manager immediately for necessary action.
11. LSTK contractor should not leave any welding machine etc. running after the work is stopped. Before leaving the work place, Contractor should ensure that welding sets are disconnected from welding socket outlet.
12. All work areas shall be kept reasonably clear and clean for easy movement of men & material. Also all approach roads shall be free from obstacles for easy movement of cranes, vehicles, fork-lifts, trollies etc. and all debris shall be periodically removed.
13. All temporary structure and supports for erection purpose such as scaffolding, ladders, walkways, platform, shuttering etc. shall be sufficiently strong for safe use and to prevent collapse & accidental fall of workman. Same shall be removed immediately after the work is completed.

	EMERGENCY DIESEL GENERATORS PACKAGE TALCHER FERTILIZERS LIMITED	PC183/E/4022/SecVI-9.0	0	
	SITE WORKING AND SAFETY CONDITIONS	Document No.	Rev	
	Sheet 10 of 13			

14. All workmen working at unsafe elevation during the construction activity such as concreting, plastering, welding, erection work, painting, insulation etc. shall be safe and sufficient passage and should be properly instructed to take necessary safety precautions and observe safe practice to prevent accidental fall. Safety belts and helmets shall be used wherever necessary.
15. All supervisors, welders, electricians, technicians, riggers, engaged in the work shall be adequately skilled, experienced and acquainted with standard rules, regulation & practices of the work.
16. All open trenches, pits and other excavation carried shall be barricaded out by Construction Contractor, to avoid accident.
17. All lifting tools, tackles & accessories shall be in good working condition and of suitable capacity for the purpose for which they are used. All certificates/permits/licenses etc. required under any law or regulation for the same shall be available and valid during the entire period of the execution of the work under this Work Order/Contract.
18. LSTK contractor shall not use any structure or equipments erected or under erection for fastening, lifting or flying tackle guy-ropes etc. which may impose such loads for which structure or equipments are not designed to carry. However, LSTK contractor has to get prior approval from Construction Manager of Owner before using beams, permanent structure for the above purpose.
19. When work is carried out at high elevations, it is the responsibility of the LSTK contractor to ensure that tools and materials are not left in a position where they can fall on peoples moving /working below. Where necessary, places below should be cordoned off and caution boards be provided by contractor. Also, LSTK contractor should not cut existing hand railing/structure.
20. Contractor's men must not tamper with any machines, switches, valve or equipment not connected with their work. Welding holders should not be tested on running pipe lines.
21. Nylon rope should not be used for scaffolding where hot line is running near by, because there is every possibility of wire rope catching the fire. Also, no scaffolding is to be made on hot as well as insulated lines.
22. Necessary sign boards clearly indicating "RADIOGRAPHY HAZARDS" on all the four sides of the cordoned area surrounding radiography source will have to be displayed by Construction Contractor. Surrounding area will be cordoned with the help of manila rope and his personnel will be kept for watching/guard on all the four sides to prevent entry of personnel till the radiography work is completed. Construction Contractor's personnel should be able to communicate clearly/properly to stop entry of unauthorized personnel within the area cordoned for the radiography work.

 पी डी आर् एल PDIL	EMERGENCY DIESEL GENERATORS PACKAGE TALCHER FERTILIZERS LIMITED	PC183/E/4022/SecVI-9.0	0	 Talcher Fertilizers
		Document No.	Rev	
	SITE WORKING AND SAFETY CONDITIONS		Sheet 11 of 13	

Refuse Disposal

23. Refuse must be removed daily to prevent accumulation. Materials liable to cause persons to slip or trip and fall should be cleared immediately.
24. Refuse removal teams working after work hour should be organized where normal cleaning can not cope with the build up of waste materials.
25. Projecting nails should be removed or bent over.

Personal Protective Equipments



26. Helmets should be provided for all who are exposed to the dangers of falling material or structures they might strike against.
27. Suitable eye protection should be provided for all who are exposed to flying particles, harmful glare and dangerous substances.
28. In the handling of rough objects, gloves should be provided and used.
29. Safety footwear should be provided to all who are exposed to foot injury, should be good fitting and comfortable to wear.
30. Safety belts should be provided where other means are not practicable. Both the anchorage points and lifelines provided for attaching safety belts should be of adequate strength. The umbilical line should be fixed in such a way that user's freefall will not exceed 1 metre.
31. Catch net should be used where persons are liable to fall and these should be securely supported at a level as near as possible to the working level.
32. Noise defenders should be provided for work area where the noise level exceeds 85 dBA.
33. Respiratory protection should be provided by employers and used by workers where the dust level remains high and where control at source is not practicable.

Inspection & Record Keeping

34. Where defects render the scaffolds unsafe, they should be rectified immediately. Where this is not practicable, a sign should be put warning against using it.

Winches

35. Adequate foundations should be provided for winches.

	EMERGENCY DIESEL GENERATORS PACKAGE TALCHER FERTILIZERS LIMITED	PC183/E/4022/SecVI-9.0	0	
		Document No.	Rev	
	SITE WORKING AND SAFETY CONDITIONS		Sheet 12 of 13	

Lifting Gear

36. All lifting gear and slinging should be tested before use and thereafter inspected regularly by competent engineers. Workers should also check the lifting gear visually before using them.
37. Each piece of lifting gear should bear its safe working load, its identification number and its last inspection date. It could in addition be colour coded according to due date of inspection.
38. Wire ropes should be preserved against rusting, kinking, fraying, birdcaging and heat damage. Defective wires should be destroyed to prevent recycling.

Concrete Mixers

39. Moving parts which are liable to become nip points, such as gears, chains and rollers should be guarded.
40. Where concrete mixers are driven by internal combustion engines, exhaust points should be located away from the workers' work station so as to eliminate their exposure to obnoxious fumes.

Electrical Components



41. All components and conductors used must be in good condition.
42. Proper junction boxes and distribution boards from which electric power could be tapped should be provided at every floor level.

Demolition: General Provisions

43. Uncontrolled collapse of walls or other structures under demolition should be prevented.
44. The throwing of materials over the sides of the buildings should not be permitted.

Waste Handling

45. Where demolition is carried out near public areas:
 - a) Hoardings slopping inwards should be erected around the building.
 - b) Protective nettings should be hung around the building to prevent materials falling outside the periphery shelter.
 - c) Where asbestos materials are present, appropriate dust control and respiratory protection approved by the local authority must be used.

	EMERGENCY DIESEL GENERATORS PACKAGE TALCHER FERTILIZERS LIMITED	PC183/E/4022/SecVI-9.0	0	
		Document No.	Rev	
	SITE WORKING AND SAFETY CONDITIONS		Sheet 13 of 13	

Excavation: General Provisions

46. Test for toxic gases should be carried out where their presence is suspected.
47. Exposure of shorings to vibration such as that produced by engines or vehicular traffic should be kept to a minimum.

General – Ventilation, Fire Protection/Fighting

48. Where flammable gas concentration could reach explosive levels, it may be necessary to provide intrinsically safe electrical equipments.
49. Adequate lighting and emergency lighting should be provided.
50. Adequate evacuation stairways should be provided for rapid evacuation in case of an emergency.

First Aid

51. Sufficient First Aid Boxes containing simple dressings and supplies should be provided on the site under the control of the foreman.

Awareness

52. The contractor shall brief the visitor about HSE precautions which are required to be taken before proceeding to site and make necessary arrangement to issue appropriate PPE's like HELMET, Safety shoes etc. to the visitors.
The contractor shall promote and develop consciousness about Health, safety and environment among all personnel working for the contractor. Regular awareness programmes and fabrication shop/work site meeting at least on fortnightly basis shall be arranged on HSE activities to cover hazards involved in various operations during construction phase. During the awareness program, step shall be taken by the contractor to motivate & encourage the workmen and supervisory staff by issuing/awarding them the tokens/gifts/mementos/ Monetary incentives.
A verbal warning shall be given to the workers during the first HSE violations. A written warning shall be issued on second violations and thereafter for the third violations; the services of worker shall be terminated. For all these violations, penalties' shall be imposed, separately on the contractor. Records of warning for each worker shall be kept in the records.

 पी डी आई एल PDIL	PROJECTS & DEVELOPMENT INDIA LIMITED	PC183/E/4022/SecVI-10.0	0	 Talcher Fertilizers
		Document No.	Rev	
		Sheet 2 of 30		

SECTION : VI - 10.0

VENDOR LIST

PLANT : EMERGENCY DIESEL GENERATORS PACKAGE



**PROJECT : INTEGRATED COAL BASED FERTILISER
COMPLEX, AT TALCHER, ANGUL DISTRICT,
ODISHA**

0	06.09.2023	06.09.2023	Issued for Tender	DKG	SKB	SKB
REV	REV DATE	EFF DATE	PURPOSE	PREPD	REVWD	APPD

	EMERGENCY DIESEL GENERATORS PACKAGE TALCHER FERTILIZERS LIMITED VENDOR LIST	PC183/E/4022/SecVI-10.0	0	
		Document No.	Rev	
		Sheet 2 of 30		

CONTENTS



SECTION NUMBER	DESCRIPTION
1.0	Electrical
2.0	Piping
3.0	Rotating Equipments

	EMERGENCY DIESEL GENERATORS PACKAGE TALCHER FERTILIZERS LIMITED VENDOR LIST	PC183/E/4022/SecVI-10.0	0	
		Document No.	Rev	
		Sheet 3 of 30		



Bidder shall select sub vendors from the vendor list as specified below. Bidder shall ensure that sub vendor for the specified item has supplied item for the specified service & the supplied item is in satisfactory service since last 3 years as on date of offer.

Vendor shall have well proven record for the specified services and shall be subjected to owner/consultant approval.



1.0	ELECTRICAL	
Generator Engine		
1.	Caterpillar	India
2.	Cummins	India
3.	MTU	India
Generator Alternator		
1.	Stamford	India
2.	Leroy Somer	India
3.	Caterpillar	India
4.	TD Power Systems	India
Neutral Earthing Resistor		
1.	Elecmech Corporation	India
2.	Lotus Powergear Pvt Ltd	India
3.	Resitech Electricals Private Limited	India
4.	RSI Switchgear Private Ltd.	India
5.	S R Narkhede Engineering Pvt. Ltd.	India
HV Switchboard (11 kV)		
1.	ABB India Limited	India
2.	Siemens Ltd	India
3.	BHEL (Electrical Machines Divn.)	India
4.	Schneider Electric	India
415 V SWITCH BOARD(PCC/MCC/PMCC)		
1.	Alstom Limited (Areva T & D)	India
2.	GE Power Controls India Pvt. Ltd.	India
3.	Larsen & Toubro Ltd.(El.Products Divn)	India
4.	Siemens Ltd.	India
5.	CG Power and Industrial Solution Limited (Formerly known as Crompton Greaves Ltd)	India
6.	Schneider	India
7.	Intrelec	India
Floor Mounting Type Distribution Boards		
1.	Associated Switchgears & Projects Ltd.	India

	EMERGENCY DIESEL GENERATORS PACKAGE TALCHER FERTILIZERS LIMITED VENDOR LIST	PC183/E/4022/SecVI-10.0	0	
		Document No.	Rev	
		Sheet 4 of 30		



2.	Elecmec Corporation	India
3.	GE Power Controls India Pvt. Ltd.	India
4.	Intrelec	India
5.	Jakson Engineers Ltd	India
6.	Larsen & Toubro Ltd.(El.Products Divn)	India
7.	Lotus Powergear Pvt Ltd	India
8.	Siemens Ltd.	India
9.	Spaceage Switchgears Limited	India
10.	Tricolite Electrical Industries Pvt. Ltd.	India
11.	United Electric Co. (Delhi) Pvt. Ltd	India
12.	Venus Controls & Switchgear (P) Ltd.	India
13.	Schneider	India
Wall Mounting Type Distribution Boards		
1.	Anand Power Limited	India
2.	Associated Switchgears & Projects Ltd.	India
3.	Cosmic Power Systems Pvt. Ltd.	India
4.	Elecmec Corporation	India
5.	GE Power Controls India Pvt. Ltd.	India
6.	Intrelec	India
7.	Larsen & Toubro Ltd.(El.Products Divn)	India
8.	Lotus Powergear Pvt Ltd	India
9.	Siemens Ltd.	India
10.	Spaceage Switchgears Limited	India
11.	Tricolite Electrical Industries Pvt. Ltd.	India
12.	Trident Switchgears Pvt. Ltd. (Upto 3200 A)	India
13.	United Electric Co. (Delhi) Pvt. Ltd	India
14.	Venus Controls & Switchgear (P) Ltd.	India
15.	Schneider	India
Control & Relay Panel		
1.	Alstom Limited (Areva T&D)	India
2.	ABB.	India
3.	Elecmec Corporation	India
4.	Larsen & Toubro Ltd. (El. Products Divn)	India
5.	Siemens Ltd.	India
6.	Schneider	India
Protective Relays (other than BMR)		
1.	Alstom Limited (Areva T & D)	India
2.	ABB.	India
3.	Schneider – MICOM Model	India
4.	SEL – Schweitzer Engineering	India

	EMERGENCY DIESEL GENERATORS PACKAGE TALCHER FERTILIZERS LIMITED VENDOR LIST	PC183/E/4022/SecVI-10.0	0	
		Document No.	Rev	
		Sheet 5 of 30		



	Laboratories	
5.	Woodward	India
6.	Siemens Ltd.- SIPROTEC Model	India
Vacuum Circuit Breakers (VCB)		
1.	Alstom Limited (Areva T & D)	India
2.	ABB	India
3.	BHEL (Electrical Machines Divn.)	India
4.	Siemens Ltd.	India
5.	Schneider	India
Air Circuit Breakers (ACB)		
1.	GE Power Controls India Pvt. Ltd.	India
2.	Larsen & Toubro Ltd.(EI.Products Divn)	India
3.	Siemens Ltd.	India
4.	ABB	India
5.	Schneider Electric	India
Moulded Case Circuit Breakers (MCCB)		
1.	Crompton Greaves Ltd.	India
2.	GE Power Controls India Pvt. Ltd.	India
3.	Larsen & Toubro Ltd.(EI.Products Divn)	India
4.	Siemens Ltd.	India
5.	ABB	India
6.	Schneider Electric	India
Miniature Circuit Breakers (MCB) / RCBO		
1.	Indo Asian Fusegear Ltd	India
2.	Legrand India Ltd	India
3.	S & S Power Switchgear Ltd	India
4.	Standard Electricals Limited	India
5.	Siemens Ltd.	India
6.	ABB	India
7.	Schneider Electric	India
ELCB		
1.	GE Power Controls India Pvt. Ltd.	India
2.	Havells India Ltd.	India
3.	Indo Asian Fusegear Ltd	India
4.	Legrand India Ltd	India
5.	S & S Power Switchgear Ltd	India
6.	Siemens Ltd.	India

	EMERGENCY DIESEL GENERATORS PACKAGE TALCHER FERTILIZERS LIMITED VENDOR LIST	PC183/E/4022/SecVI-10.0	0	
		Document No.	Rev	
		Sheet 6 of 30		



7.	Standard Electricals Limited	India
8.	ABB	India
9.	Schneider Electric	India
Low Voltage Industrial Switches/Isolators		
1.	ABB	India
2.	GE Power Controls India Pvt. Ltd.	India
3.	Havells India Ltd.	India
4.	Kaycee Industries Ltd	India
5.	Larsen & Toubro Ltd.(El.Products Divn)	India
6.	Siemens Ltd.	India
7.	Schneider Electric	India
Current Transformers (11 kV)		
1.	Anant Powertech	India
2.	ABB	India
3.	Kalpa Electrical Private Limited	India
4.	Mehru Electricals (Formerly Automatic Electric Limited)	India
5.	Perfect Sales Corporation	India
6.	Silkans	India
7.	Kappa	India
8.	Pragati	India
Potential Transformer (11 kV)		
1.	Anant Powertech	India
2.	ABB	India
3.	Kalpa Electrical Private Limited	India
4.	Mehru Electricals (Formerly Automatic Electric Limited)	India
5.	Perfect Sales Corporation	India
Current Transformers (415V)		
1.	Alstom Limited (Areva T & D)	
2.	Anant Powertech	India
3.	Indcoil Transformers Pvt. Ltd.	India
4.	Kappa Electricals	India
5.	Mehru Electricals (Formerly Automatic Electric Limited)	India
6.	Perfect Sales Corporation	India
7.	Siemens Ltd.	India
8.	Silkans	India
9.	Pragati	India
10.	Automatic Electric	India

	EMERGENCY DIESEL GENERATORS PACKAGE TALCHER FERTILIZERS LIMITED VENDOR LIST	PC183/E/4022/SecVI-10.0	0	
		Document No.	Rev	
		Sheet 7 of 30		



11.	Rishabh	India
12.	Newtek Electricals	India
Potential Transformers (415V)		
1.	Alstom Limited (Areva T & D)	India
2.	Indcoil Transformers Pvt. Ltd.	India
3.	Kalpa Electrical Private Limited	India
4.	Kappa Electricals	India
5.	Larsen & Toubro Ltd.(El. Products Divn)	India
6.	Mehru Electricals (Formerly Automatic Electric Limited)	India
7.	Perfect Sales Corporation	India
8.	Siemens Ltd.	India
9.	Newtek Electricals	India
Meters		
1.	Alstom Limited (Areva T & D)	India
2.	IMP Power Ltd.	India
3.	M.B. Control & Systms Pvt. Ltd. (Only For Multifunctional Meter)	India
4.	Meco Instruments	India
5.	Mehru Electricals (Formerly Automatic Electric Limited)	India
6.	Rishabh Instruments Pvt. Ltd.	India
7.	Seahorse Industries Ltd.	India
Multi Function Meter (MFM)		
1	Secure meter Limited	India
2	SEMS	India
3	Larsen & Toubro Ltd.	India
4	SATEC	India
5	Alstom Limited (Areva T & D)	India
6	Siemens Ltd.	India
7	Asea Brown Boveri Ltd.	India
8	Schneider Electric	India
Bus Ducts (11 kV)		
1.	Best & Crompton Engg. Co.	India
2.	C & S Electric Ltd.	India
3.	Crompton Greaves Ltd.	India
4.	Intrelec	India
5.	Powergear Limited	India
6.	Spaceage Switchgears Limited	India
7.	United Electric Co. (Delhi) Pvt. Ltd.	India
Bus Duct (415 V)		
1.	Associated Switchgears & Projects Ltd.	India

	EMERGENCY DIESEL GENERATORS PACKAGE TALCHER FERTILIZERS LIMITED VENDOR LIST	PC183/E/4022/SecVI-10.0	0	
		Document No.	Rev	
		Sheet 8 of 30		



2.	Best & Crompton Engg. Co.	India
3.	C & S Electric Ltd.	India
4.	Intrelec	India
5.	Lotus Powergear Pvt Ltd	India
6.	Spaceage Switchgears Limited	India
7.	United Electric Co. (Delhi) Pvt. Ltd.	India
8.	Venus Controls & Switchgear (P) Ltd.	India
9.	Globe Electrical Industries (MV bus duct)	India
10.	Powergear Ltd.	India
Induction Motors – LV (415 V) (Hazardous Area)		
1.	ABB	India
2.	Bharat Bijlee Ltd	India
3.	Crompton Greaves Ltd	India
4.	Kirloskar Electric Company Ltd	India
5.	Siemens Ltd	India
6.	Jeumont Industrie	France
7.	Siemens AG, Germany	Germany
8.	Fuji Electric Systems Co. Ltd.	Japan
9.	Mitsubishi Corporation	Japan
10.	Toshiba Corporation	Japan
11.	Asea Brown Boveri	Sweden
12.	General Electric Co.	USA
13.	Hem Industries (0.18 Kw To 200 Kw)	India
14.	Laxmi Hydraulics Pvt. Ltd. (Upto 315L Frame Size)	India
Induction Motors – LV (415 V) (Safe Area)		
1.	ABB	India
2.	Bharat Bijlee Ltd	India
3.	Crompton Greaves Ltd	India
4.	Kirloskar Electric Company Ltd	India
5.	Siemens Ltd	India
6.	Jeumont Industrie	France
7.	Siemens AG, Germany	Germany
8.	Fuji Electric Systems Co. Ltd.	Japan
9.	Mitsubishi Corporation	Japan
10.	Toshiba Corporation	Japan
11.	Asea Brown Boveri	Sweden
12.	General Electric Co.	USA
13.	Hem Industries	India
14.	Laxmi Hydraulics Pvt. Ltd. (Upto 355L Frame Size)	India
Industrial Type Sw. Socket & Plug		

	EMERGENCY DIESEL GENERATORS PACKAGE TALCHER FERTILIZERS LIMITED VENDOR LIST	PC183/E/4022/SecVI-10.0	0	
		Document No.	Rev	
		Sheet 9 of 30		



1.	Baliga Lighting Equipments Limited	India
2.	Chloride Power Systems and Solutions Ltd. (formerly CALDYNE)	India
3.	Crompton Greaves Ltd	India
4.	Cyclo Electric Devices & Services Co.	India
5.	Ex-protecta	India
6.	FCG Flameproof Control Gears Pvt. Ltd. (Formerly CEAG Flame	India
7.	FCG Power Industries Ltd	India
8.	Flameproof Equipments Pvt. Ltd.	India
9.	Legrand India Ltd	India
10.	Legrand S.A.	France
11.	BBC-Brown Boveri & Cie AG	Germany
12.	R Stahl Schaltgerate Gmbh	Germany
13.	Weidmuller Ltd.	Germany
14.	CORTEM S.p.A.	Italy
15.	Shrenik & Company	India
Street/Flood Lighting Fixtures		
1.	Bajaj Electricals Limited	India
2.	Crompton Greaves Ltd	India
3.	Havells India Ltd.	India
4.	Philips India Ltd.	India
5.	Surya Roshni Ltd.	India
6.	Wipro Lighting	India
Hose Proof Industrial Lighting Fixtures		
1.	Bajaj Electricals Limited	India
2.	Crompton Greaves Ltd.	India
3.	Philips India Ltd.	India
4.	Surya Roshni Ltd.	India
5.	Wipro Lighting	India
Air Obstruction Lights (Neon Type)		
1.	Bajaj Electricals Limited	India
2.	Elecab Poysha	India
3.	Wipro Lighting	India
Lighting Poles		
1.	Bharti Exports	India
2.	Metalite Industries	India
3.	Premier Power Products (Calcutta) Pvt. Ltd.	India
4.	Sadhana Engineering Corporation	India
5.	Surya Roshni Ltd.	India

	EMERGENCY DIESEL GENERATORS PACKAGE TALCHER FERTILIZERS LIMITED VENDOR LIST	PC183/E/4022/SecVI-10.0	0	
		Document No.	Rev	
		Sheet 10 of 30		



Explosion Proof Lighting Fixtures		
1.	Baliga Lighting Equipments Limited	India
2.	Crompton Greaves Ltd	India
3.	Ex-Protecta	
4.	FCG Flameproof Control Gears Pvt. Ltd. (Formerly CEAG Flame)	India
5.	FCG Power Industries Ltd	India
6.	Flameproof Equipments Pvt. Ltd.	India
7.	Flexpro Electricals Pvt. Ltd.	India
8.	Saieux Flameproof Equipments Pvt Ltd	India
9.	Shreya Ex-Tech Private Limited	India
10.	Sudhir Switchgears Pvt. Ltd.	India
Battery Charger		
1.	Amco Power Systems Limited	India
2.	Chloride Power Systems and Solutions Ltd. (formerly CALDYNE)	India
3.	Chhabi Electricals Pvt. Ltd.	India
4.	HBL Nife Power Systems Ltd.	India
5.	Universal Industrial Products	India
Battery (Ni-Cd)		
1.	AMCO Power Systems Ltd.	India
2.	HBL Nife Power Systems Ltd.	India
3.	Fuji Electric Systems Co. Ltd.	Japan
4.	Hitachi Limited	Japan
HT Power Cables		
1.	Cable Corpn. of India Limited	India
2.	KEC International Ltd. (Formerly RPG Cables Limited)	India
3.	KEI Industries Limited (Upto 33 kV)	India
4.	Ravin Cables Limited	India
5.	Torrent Cables Ltd.	India
6.	Universal Cables Ltd.	India
7.	Uniflex	India
8.	Polycab	India
LT Power Cables		
1.	Cable Corpn. of India Limited	India
2.	Cords Cable Industries Ltd	India
3.	Delton Cables Ltd	India
4.	Finolex Cables Ltd	India
5.	KEC International Ltd. (Formerly RPG Cables Limited)	India
6.	KEI Industries Limited	India

	EMERGENCY DIESEL GENERATORS PACKAGE TALCHER FERTILIZERS LIMITED VENDOR LIST	PC183/E/4022/SecVI-10.0	0	
		Document No.	Rev	
		Sheet 11 of 30		



7.	Plaza Cable Industries Limited	India
8.	Ravin Cables Limited	India
9.	Torrent Cables Ltd	India
10.	Universal Cables Ltd.	India
11.	Polycab	India
LT Control Cables (1.1 kV)		
1.	Cable Corpn. of India Limited	India
2.	Cords Cable Industries Ltd	India
3.	Delton Cables Ltd	India
4.	Finolex Cables Ltd	India
5.	KEC International Ltd. (Formerly RPG Cables Limited)	India
6.	KEI Industries Limited	India
7.	Plaza Cable Industries Limited	India
8.	Radiant Cables Pvt. Limited	
9.	Ravin Cables Limited	India
10.	Torrent Cables Ltd	India
11.	Universal Cables Ltd.	India
12.	Miracle cables	India
13.	Polycab	India
Cables For Earthing		
1.	Advance Cable Technologies (P) Ltd.	India
2.	Delton Cables Ltd	India
3.	Finolex Cables Ltd	India
4.	Gupta Electric & Machinery Stores (GEMSCAB)	India
5.	J K Cables Limited	India
6.	Netco Cable Industries (Pvt.) Ltd.	India
7.	Prestige Cable Industries	India
8.	Shyam Cables Industries	India
9.	Special Cables Pvt. Ltd.	India
10.	T C Communication Pvt Ltd	India
11.	Universal Cables Ltd.	India
Cable Jointing Kits		
1.	Raychem RPG Ltd.	India
Pre-Fabricated Al-Cable Trays		
1.	Globe Electrical Industries	India
2.	Hindustan Vidyut Products	India
3.	Indiana Engg Works Pvt Ltd	India
4.	Indmark Formtech Pvt. Ltd.	India
5.	Jamna Metal Company	India

	EMERGENCY DIESEL GENERATORS PACKAGE TALCHER FERTILIZERS LIMITED VENDOR LIST	PC183/E/4022/SecVI-10.0	0	
		Document No.	Rev	
		Sheet 12 of 30		



6.	Kanade Anand Udyog Pvt. Ltd.	India
7.	Maheshwari Electrical Mfrs. (P) Ltd.	India
8.	Metalite Industries	India
9.	Parekh Engineering Company	India
10.	Premier Power Products (Calcutta) Pvt. Ltd.	India
11.	Rukmani Electricals & Components Pvt Ltd	India
12.	Sadhana Engineering Corporation	India
13.	Sree Atreya Enterprises	India
14.	Stealite Engg Co	India
15.	R.K. Engineering Works	India
16.	Ratan Projects And Engineering Co. Pvt. Ltd.	India
Pre-Fabricated G.I. Cable Trays		
1.	Globe Electrical Industries	India
2.	Indiana Engg Works Pvt Ltd	India
3.	Jamna Metal Company	India
4.	Maheshwari Electrical Mfrs. (P) Ltd.	India
5.	Premier Power Products (Calcutta) Pvt. Ltd.	India
6.	Rukmani Electricals & Components Pvt Ltd	India
7.	R.K. Engineering Works	India
8.	Ratan Projects And Engineering Co. Pvt. Ltd.	India
Hose Proof Local Control Station		
1.	Baliga Lighting Equipments Limited	India
2.	Bhartia Industries Ltd. (Divn. Bch)	India
3.	C & S Electric Ltd.	India
4.	Ex-Protecta	
5.	FCG Flameproof Control Gears Pvt. Ltd. (Formerly CEAG Flame)	India
6.	FCG Power Industries Ltd.	India
7.	Flameproof Equipments Pvt. Limited	India
8.	Hotline Switchgear & Controls	India
9.	Power Engg Co	India
10.	Shrenik & Company	India
Flameproof Items (Switch, Switch Socket, Plugs, Isolators, Junction Box, Local Control Station, Distribution Board)		
1.	Baliga Lighting Equipments Ltd.	India
2.	Ex-Protecta	India
3.	FCG Flameproof Control Gears Pvt. Ltd. (Formerly CEAG Flame)	India
4.	FCG Power Industries Ltd	India
5.	Flameproof Equipments Pvt. Ltd.	India
6.	Flexpro Electricals Pvt. Ltd.	India

	EMERGENCY DIESEL GENERATORS PACKAGE TALCHER FERTILIZERS LIMITED VENDOR LIST	PC183/E/4022/SecVI-10.0	0	
		Document No.	Rev	
		Sheet 13 of 30		

7.	Legrand S.A.	France
8.	AEG Telefunken AG	Germany
9.	BBC-Brown Boveri & CIE AG	Germany
10.	R Stahl Schaltgerate GMBH	Germany
11.	Siemens AG, Germany	Germany
12.	Weidmuller Ltd.	Germany
13.	Cortem S.p.A.	Italy
14.	Fuji Electric Systems Co. Ltd.	Japan
15.	Togami Electric Mfg. Company	Japan
16.	Toshiba Corporation	Japan
17.	Asea Brown Boveri	Sweden
18.	Crouse-Hinds (Europe) Ltd.	U.K.
19.	GEC Industrial Control Ltd.	U.K.
20.	M&C Switchgear	U.K.
21.	Shreya Ex-Tech Private Limited	India
22.	Sudhir Switchgears Pvt. Ltd.	India
Hose proof Junction Boxes		
1.	Baliga Lighting Equipments Limited	India
2.	Bhartia Industries Ltd. (Divn. Bch)	India
3.	Ex-protecta	India
4.	FCG Flameproof Control Gears Pvt. Ltd. (Formerly CEAG Flame)	India
5.	Flameproof Equipments Pvt. Ltd.	India
6.	FCG Power Industries Ltd	India
7.	Shrenik & Company	India
Earthing & Lightning Protection Material – (Al) Wire/Strip		
1.	Anand Electric Trading Co.	India
2.	C & S Electric Ltd.	India
3.	Indmark Formtech Pvt. Ltd.	India
4.	Jayant Metal Mfg. Co.	India
5.	Premier Power Products (Calcutta) Pvt. Ltd.	India
6.	Jamna Metal Company	India
7.	Mahavir Industrial Corporation	India
8.	Metropolitan Industries	India
9.	Sai Galvanisers & Fabricators Pvt Ltd	India
Earthing & Lightning Protection Material – (GI) Wire/Strip		
1.	Anand Electric Trading Co.	India
2.	Controls & Switchgear Co. Ltd.	India
3.	Jayant Metal Mfg. Co.	India
4.	Indmark Formtech Pvt. Ltd.	India
5.	Premier Power Products (Calcutta) Pvt. Ltd.	India

	EMERGENCY DIESEL GENERATORS PACKAGE TALCHER FERTILIZERS LIMITED VENDOR LIST	PC183/E/4022/SecVI-10.0	0	
		Document No.	Rev	
		Sheet 14 of 30		

6.	Jamna Metal Co.	India
7.	Mahavir Industrial Corporation	India
8.	Metropolitan Industries	India
9.	Sai Galvanisers & Fabricators Pvt Ltd	India
10.	Bharti Exports	India
11.	Metalite Industries	India
12.	Rukmani Electricals & Components Pvt Ltd	India
13.	Sadhana Engineering Corporation	India
14.	Stealite Engg Co	India
15.	R.K. Engineering Works	India
16.	Ratan Projects And Engineering Co. Pvt. Ltd.	India
17.	Telecom Network Solutions Pvt.Ltd.	India
GI Pipes & Conduits		
1.	Bharti Exports	India
2.	Indian Tube Co. (Tata Div. of Tubes & Pipes)	India
3.	Jindal Pipes Ltd.	India
4.	Meghjyot Enterprises	India
5.	Rukmani Electricals & Components Pvt Ltd	India
6.	Steelcraft	India
Industrial Cable Gland		
1.	Baliga Lighting Equipments Limited	India
2.	Comet Brass Products	India
3.	Comet Industries	India
4.	Dowell's Electricals	India
5.	Electromac Industries	India
6.	FCG Flameproof Control Gears Pvt. Ltd. (Formerly CEAG Flame	India
7.	Gland-Mech. Industries	India
8.	Industrial products Equipment	India
9.	Power Engg Co	India
10.	Quality & Precision Indl. Equipment	India
11.	S J Metal Industries (Jainson)	India
Cable Lugs		
1.	Dowell's Electricals	India
2.	Forward Engg Industries	India
3.	KSE Electrical Pvt. Ltd.	India
4.	MG Electrica	Indai
5.	Power Engg Co	India
6.	S J Metal Industries (Jainson)	India
7.	Usha Martin Industries Ltd. (IsmaI Divn)	India
Flameproof Cable Gland		
1.	Baliga Lighting Equipments Limited	India
2.	Comet Brass Products	India
3.	Comet Industries	India

	EMERGENCY DIESEL GENERATORS PACKAGE TALCHER FERTILIZERS LIMITED VENDOR LIST	PC183/E/4022/SecVI-10.0	0	
		Document No.	Rev	
		Sheet 15 of 30		

4.	Dowell's Electricals	India
5.	Electromac Industries	India
6.	Ex-Protecta	
7.	FCG Flameproof Control Gears Pvt. Ltd. (Formerly CEAG Flame)	India
8.	FCG Power Industries Ltd	India
9.	Flameproof Equipments Pvt. Ltd.	India
10.	Flexpro Electricals Pvt. Ltd.	India
11.	Industrial Products Equipment	India
12.	Kaysons Techno Equipments Pvt. Ltd.	India
13.	Power Engg Co	India
14.	Prompt Engineering Works	India
15.	Sudhir Switchgears Pvt. Ltd.	India
16.	Saix Flameproof Equipments Pvt Ltd	India
17.	Shreya Ex-Tech Private Limited	India
18.	Sudhir Switchgears Pvt. Ltd.	India

Explosion Proof Exhaust Fan

1.	Alstom Limited (Areva T & D)	India
2.	Crompton Greaves Ltd	India
3.	FCG Flameproof Control Gears Pvt. Ltd. (Formerly CEAG Flame)	India
4.	Flameproof Equipments Pvt. Ltd.	India
5.	Industrial Products Equipment	India
6.	Shreya Ex-Tech Private Limited	India

Fuse

1.	Larsen & Toubro Ltd. (El. Products Divn.)	India
2.	Siemens Ltd.	India
3.	Alstom Power	India
4.	Havells India Ltd.	India

Contactor / Relay /



1.	Larsen & Toubro Ltd. (El. Products Divn.)	India
2.	Siemens Ltd.	India

Timer

1.	ABB	India
2.	Alstom Power	India
3.	Bhartia Cutler Hammer	India
4.	Siemens Ltd	India

Control Switches

1.	Alstom Power	India
2.	Siemens Ltd.	India
3.	Kaycee	India
4.	Larsen & Toubro Ltd. (El. Products Divn.)	India

	EMERGENCY DIESEL GENERATORS PACKAGE TALCHER FERTILIZERS LIMITED VENDOR LIST	PC183/E/4022/SecVI-10.0	0	
		Document No.	Rev	
		Sheet 16 of 30		

Push Buttons		
1.	Alstom Power	India
2.	Larsen & Toubro Ltd. (El. Products Divn.)	India
3.	Siemens Ltd.	India
4.	Tecnik	India
5.	Tulsi	India

Signal Lamps		
1.	Alstom Power	India
2.	Binoy	India
3.	Larsen & Toubro Ltd. (El. Products Divn.)	India
4.	Siemens Ltd.	India
5.	Tulsi	India



Terminal Blocks		
1.	Connectwell	India
2.	Elmex	India
3.	Larsen & Toubro Ltd. (El. Products Divn.)	India
4.	Siemens Ltd.	India

Programmable Logic Controller		
1.	Rockwell Automation India Pvt. Ltd.	India
2.	Siemens Ltd.	India
3.	ABB	India



Optical Fiber Cable		
1.	Finolex	India
2.	DLink	India
3.	Molex	India
4.	Lucent	India
5.	Ericson	India
6.	Sterlite	India
7.	HFCL	India
8.	OPTEL	India
9.		

Transducer		
1.	Crompton	UK
2.	Elster (ABB)	India



HDPE Pipe		
1.	Astral	India
2.	Reliance Industries 'RELPIPE	India
3.	APOLLO	India
4.	Cliamx Synthesis	India

	EMERGENCY DIESEL GENERATORS PACKAGE TALCHER FERTILIZERS LIMITED VENDOR LIST	PC183/E/4022/SecVI-10.0	0	
		Document No.	Rev	
		Sheet 17 of 30		



2.0	MECHANICAL – PIPING	
CS WELDED PIPES TO API 5L SPIRAL LONG. WELDED		
Sl.No	Vendor's Name	Country
1	HEAVY METAL PIPE CENTRE (UPTO 24" (UPTO SCHXXS)	INDIA
2	JINDAL PIPES LTD. (2" TO 14")	INDIA
3	JOTINDRA STEEL & TUBES LTD. (½" TO 14")	INDIA
4	KALPESH TUBE(INDIA), (TRADER)	INDIA
5	LALIT PIPES & PIPES LTD.. (16" to 64" thickness upto 20mm)	INDIA
6	MUKAT PIPES LTD.	INDIA
7	P.K.FORGE & FITTING INDUSTRIES	INDIA
8	PRATIBHA INDUSTRIES LTD. (16" to 24" thickness 6mm to 14.27mm)	INDIA
9	RATNAMANI METALS & TUBES LTD.	INDIA
10	SAGAR STEEL CORPORATION (TRADER)	INDIA
11	SAIL	INDIA
12	SURINDRA ENGINEERING CO. PVT. LTD.	INDIA
13	SURYA ROSHINI LTD (GR. A 3" TO 4", GR. B, 6" TO 14")	INDIA
14	THE BENGAL MILL STORES SUPPLY CO.(TRADER)	INDIA
15	WELSPUN GUJARAT STAHL ROHREN LIMITED (FOR ANJAR AND DAHEJ PLANTS) (UPTO 72" 50 MM THK FOR DAHEJ PLANT AND UPTO 100" 30 MM THK. FOR ANJAR PLANT.)	INDIA
16	PHOCEENNE	FRANCE
17	ETS TROUVAY & CAUVIN	FRANCE
18	MANNESMANN HANDEL AG	GERMANY
19	THYSSEN-KRUPP STAHLUNION GMBH	GERMANY
20	DALMINE SPA	ITALY
21	RACCORTUBI SRL	ITALY
22	KOSEI SANGYO LTD	JAPAN
23	MARUBENI ITOCHU STEEL	JAPAN
24	MITSUBISHI CORPORATION	JAPAN
25	NIPPON KOKAN	JAPAN
26	NIPPON STEEL CORPORATION	JAPAN
27	NISHITANI & CO. LTD.	JAPAN
28	NISSHO IWAI CORPORATION	JAPAN
29	OKURA & CO. LTD.	JAPAN
30	SOJITZ CORPORATION	JAPAN

	EMERGENCY DIESEL GENERATORS PACKAGE TALCHER FERTILIZERS LIMITED VENDOR LIST	PC183/E/4022/SecVI-10.0	0	
		Document No.	Rev	
		Sheet 18 of 30		



31	SUMITOMO METAL INDUSTRIES LTD.	JAPAN
32	HYUNDAI CORPORATION	KOREA
33	BRITISH STEEL CORPORATION	U.K.
34	CORUS TUBES LIMITED	U.K.
35	SAW PIPES USA, INC	U.S.A
CS/AS LTCS SEAMLESS PIPES		
1	BHEL	INDIA
2	CHETAN STEELS (Upto 12", SCH80)	INDIA
3	HEAVY METAL & TUBES (Upto 8", thickness upto 18.26mm)	INDIA
4	HEAVY METAL PIPE CENTRE (UPTO 24" (UPTO SCHXXS)	INDIA
5	INDIAN TUBE CO. (TATA DEV. OF TUBES & PIPES)	INDIA
6	ISMT LIMITED	INDIA
7	JINDAL SAW LTD.	INDIA
8	MAHARASHTRA SEAMLESS LTD.	INDIA
9	P.K.FORGE & FITTING INDUSTRIES	INDIA
10	RATNADEEP METAL & TUBES PVT. LTD.	INDIA
11	SAINEST TUBES PVT. LTD. (½ " NB TO 3" UPTO SCH. 160 (ASTM A 106 GR. B, A333 GR. 1 & 6 & A335 GR. P11))	INDIA
12	PHOCEENNE	FRANCE
13	ETS TROUVAY & CAUVIN	FRANCE
14	MANNESMANN HANDEL AG	GERMANY
15	HORST KURVERS GMBH	GERMANY
16	DALMINE SPA	ITALY
17	GAM RACCORDI S.P.A	ITALY
18	IBF SEAMLESS PIPES SPA	ITALY
19	RACCORTUBI SRL	ITALY
20	MARUBENI ITOCHU STEEL	JAPAN
21	MITSUBISHI CORPORATION	JAPAN
22	NIPPON STEEL CORPORATION	JAPAN
23	NISHITANI & CO. LTD.	JAPAN
24	NISSHO IWAI CORPORATION	JAPAN
25	OKURA & CO. LTD.	JAPAN
26	SOJITZ CORPORATION	JAPAN
27	SUMITOMO METAL INDUSTRIES LTD.	JAPAN
28	HYUNDAI CORPORATION	KOREA
29	AB SANDVIK STEEL	SWEDEN
30	VOMAL INTERNATIONAL LIMITED	U.K.
31	CORUS TUBES LIMITED	U.K.
32	BRITISH STEEL CORPORATION	U.K.
FITTINGS: CS/AS/SS SEAMLESS & FORGED		
1	AMFORGE INDUSTRIES	INDIA

	EMERGENCY DIESEL GENERATORS PACKAGE TALCHER FERTILIZERS LIMITED VENDOR LIST	PC183/E/4022/SecVI-10.0	0	
		Document No.	Rev	
		Sheet 19 of 30		



2	ANIL METAL CORPORATION	INDIA
3	CHETAN STEELS (UPTO 6" SCH. 80)	INDIA
4	COMMERCIAL SUPPLYING AGENCY	INDIA
5	CSA FITTINGS (Forged ½" to 2"-upto 900#, Seamless: 2" to 8"- upto SCHXXS)	INDIA
6	EBY FASTENERS	INDIA
7	EBY INDUSTRIES	INDIA
8	FIT-TECH INDUSTRIES (Forged/Seamless -upto 24", Welded upto 48")	INDIA
9	FLASH FORGE(P) LTD.(Forged upto 4"-upto 900#, Seamless/welded: up to 42")	INDIA
10	GUJARAT INFRAPIPES PVT. LTD.	INDIA
11	KALPESH TUBE(INDIA),(TRADER) (UPTO A MAX ORDER VALUE RS.25.0 LAKH)	INDIA
12	M.S FITTINGS MANUFACTURING CO. PVT LTD.	INDIA
13	MARDALE PIPES PLUS LTD.	INDIA
14	NAVKAR FORGINGS & FITTINGS PVT. LTD	INDIA
15	NL HAZRA (upto SCH80)	INDIA
16	P.K TUBES & FITTINGS PVT. LTD.	INDIA
17	P.K FORGE & FITTING INDUSTRIES	INDIA
18	PARAS FITTINGS PVT. LTD. (Forged: CS ½" to 2" & CS Seamless: 2" to 8"- upto SCHXXS)	INDIA
19	PARMAR TECHNO FORGE (Elbow, Tee, Reducer- ½" to 12" & Cap upto 18")	INDIA
20	PERFECT MARKETTING PVT. LTD.	INDIA
21	PETROCHEM INDUSTRIES (Seamless: Upto 16" (All Fittings) & upto 36" (caps) SCH : XXS /80S, Forged: upto 3"-6000#)	INDIA
22	RAJENDRA FORGE INDUSTRIES (CS: UPTO 12" SCH 40 & SS: 6" SCH 40S)	INDIA
23	S & G ENGINEERS (P) LTD.	INDIA
24	SAGAR STEEL CORPORATION (TRADER)	INDIA
25	SANGHVI METALS (TRADER)	INDIA
26	SAWAN ENGINEERS	INDIA
27	SHIVANANDA PIPE FITTINGS LTD.,	INDIA
28	STEWARTS AND LLOYDS OF INDIA LIMITED	INDIA
29	TEEKAY TUBES PRIVATE LIMITED	INDIA
30	THE BENGAL MILL STORES SUPPLY CO.(TRADER)	INDIA
31	TOPAZ PIPING INDUSTRIES	INDIA
32	TUBE BEND (CALCUTTA) PVT. LTD. (CS FITTINGS ONLY)	INDIA
33	TUBE PRODUCTS INCORPORATE	INDIA
34	ZOLOTO INDUSTRIES (upto 6" (only CS Galv.))	INDIA
35	PHOCEENNE	FRANCE

	EMERGENCY DIESEL GENERATORS PACKAGE TALCHER FERTILIZERS LIMITED VENDOR LIST	PC183/E/4022/SecVI-10.0	0	
		Document No.	Rev	
		Sheet 20 of 30		



36	ETS TROUVAY & CAUVIN	FRANCE
37	VALLOUREC	FRANCE
38	SEIKMANN ANLAGEN-TECHNIK GMBH.	GERMANY
39	TPS-TECHNITUBE ROHRENWERKE GMBH	GERMANY
40	MANNESMANN HANDEL AG	GERMANY
41	HORST KURVERS GMBH	GERMANY
42	PETROL RACCORD S.P.A. (Seamless: 1" to 42" (Elbow) & 1" to 56" Tee/Reducer/Cap))	ITALY
43	DALMINE SPA	ITALY
44	GAM RACCORDI S.P.A	ITALY
45	IBF SEAMLESS PIPES SPA	ITALY
46	IND MECCANICA BASSI LUIGI & C. SPA	ITALY
47	MANTOVANI SPA	ITALY
48	RACCORTUBI SRL	ITALY
49	TECHNO FORGE SPA	ITALY
50	MARUBENI ITOCHU STEEL	JAPAN
51	NIPPON KOKAN	JAPAN
52	NISHITANI & CO. LTD.	JAPAN
53	NISSHO IWAI CORPORATION	JAPAN
54	OKURA & CO. LTD.	JAPAN
55	SOJITZ CORPORATION	JAPAN
56	SUMITOMO METAL INDUSTRIES LTD.	JAPAN
57	HAITIMA CORPORATION	TAIWAN
58	CORUS TUBES LIMITED	U.K.
59	BRITISH STEEL CORPORATION	U.K.
60	EUROTUBE LIMITED	U.K.
61	VOMAL INTERNATIONAL LIMITED	U.K.
62	BONNEY FORGE	U.S.A.
FORGED FLANGES		
1	AJAY FORGING PVT. LTD	INDIA
2	AMFORGE INDUSTRIES	INDIA
3	ANANDMAYEE FORGINGS PVT. LTD.	INDIA
4	C D ENGINEERING	INDIA
5	CHAUDHARY HAMMER WORKS (P) LTD.	INDIA
6	CHETAN STEELS (UPTO 6", 150#)	INDIA
7	'ECHJAY INDUSTRIES LTD	INDIA
8	FERROUS ALLOYS FORGING PVT. LTD	INDIA
9	GOOD LUCK ENGINEERING CO. (½"-12" (UPTO 2500#), 14"-16" (UPTO 900#), 18"-32" (UPTO 600#), 34"-48" (UPTO 300#),	INDIA
10	J.K FORGINGS	INDIA

	EMERGENCY DIESEL GENERATORS PACKAGE TALCHER FERTILIZERS LIMITED VENDOR LIST	PC183/E/4022/SecVI-10.0	0	
		Document No.	Rev	
		Sheet 21 of 30		



11	KUNJ FORGINGS PVT. LTD.(MATERIAL CS/SS/AS) (upto 60" (upto 300#) & upto 12" (upto 2500#))	INDIA
12	MAHESH INDUSTRIES (Upto 8" -150#, material ASTM A105 only)	INDIA
13	P.K TUBES & FITTINGS PVT. LTD. (Upto 24"(upto1500#) & Upto 12"(upto2500#) Spectacle Blind and Spacer & Blinds only)	INDIA
14	PARAMOUNT FORGE (CS,AS & SS : ½" TO 42" (UPTO 600#), ½" TO 24" (UPTO 900#, ½" TO 16" (UPTO 1500#), ½" TO 12" (UPTO 2500#)).	INDIA
15	PERFECT MARKETING (P) LTD.	INDIA
16	PUNJAB STEEL	INDIA
17	R D FORGE (A UNIT OF R D CHEMICALS PVT LTD) (Upto 54" (150#), 42" (upto 600#), 20" (upto 1500#) & 12" (2500#))	INDIA
18	RAJENDRA FORGE INDUSTRIES (CS & SS : UPTO 12", 300#)	INDIA
19	S & G ENGINEERS (P) LTD.	INDIA
20	SANGHVI FORGINGS & ENGINEERING LTD	INDIA
21	SANGHVI METALS (TRADER)	INDIA
22	SAWAN ENGINEERS	INDIA
23	TECHNO FORGE LTD. (UPTO 42" (UPTO 300#), UPTO 24" (600#), UPTO 20" (900#), UPTO 16" (1500#),	INDIA
24	TUBE BEND (CALCUTTA) PVT LTD	INDIA
25	PHOCEENNE	FRANCE
26	ETS TROUVAY & CAUVIN	FRANCE
27	HORST KURVERS GMBH	GERMANY
28	I.S. INTERNATIONAL	ITALY
29	MANTOVANI SPA	ITALY
30	OFFICINE NICOLA GALPERTI & FIGLIO S.P.A	ITALY
31	RACCORTUBI SRL	ITALY
32	NICHINAN SANGYO CO. LTD.,	JAPAN
33	NISHITANI & CO. LTD.	JAPAN
34	SOJITZ CORPORATION	JAPAN
35	VOMAL INTERNATIONAL LIMITED	U.K.
GATE/ GLOBE/ CHECK VALVES CS/SS/AS < 900 LBS		
1	AV VALVES LTD. (CAST UPTO 42" ,150#) 28" 300#, 24" (600#) & FORGE UPTO 2" (800#)	INDIA
2	ADVANCE VALVES (2"-80" (Upto 600#) Dual Plate Check Valves only)	INDIA
3	ASSOCIATED TOOLINGS (I) PVT. LTD.	INDIA
4	AUDCO INDIA LIMITED (L&T VALVES DIVN.)	INDIA
5	AUTOCAP INDUSTRIES (1/2" to 2" 800# (only CS & SS)	INDIA

	EMERGENCY DIESEL GENERATORS PACKAGE TALCHER FERTILIZERS LIMITED VENDOR LIST	PC183/E/4022/SecVI-10.0	0	
		Document No.	Rev	
		Sheet 22 of 30		



6	BELL- O-SEAL VALVES LTD.(FOR ZERO LEAKAGE , HAZARDOUS FLUIDS.)	INDIA
7	BHEL (VALVES DIVISION)	INDIA
8	BRIGHTCH VALVES AND CONTROLS PVT. LTD. (Upto 8" x 300#)	INDIA
9	CHEMTECH INDUSTRIAL VALVES PVT. LTD.	INDIA
10	CRAWLEY & RAY (FOUNDERS & ENGINEERS) PVT. LTD. (<=300#, (only CS))	INDIA
11	DATRE CORPORATION LTD. (Upto 300#, 2" to 8" (Gate), 2" to 6" (Globe & Check Valves))	INDIA
12	DEWRANCE MACNEILL & CO. LTD.	INDIA
13	ECONO VALVES PVT. LTD.	INDIA
14	EXPERT ENGINEERING ENTERPRISES	INDIA
15	FLOCON SYSTEMS PVT. LTD. (CS upto 6" – 1500#)	INDIA
16	FLOVEL VALVES PVT. LTD.(SINGLE DISC , DULA PLATE & NOZZLE CHECK VALVES ONLY : UPTO 48" (150#) & 24 (UPTO 600#)	INDIA
17	FLUIDTECH EQUIPMENT PVT. LTD. (CAST # CS & SS 2" TO 12" 150# & 2 " TO 8" 300 # AND FORGED (CS AND SS) 1/2" TO 2" (800#)	INDIA
18	FORWARD ALLOYS & CASTINGS (UPTO 14")	INDIA
19	GURU INDUSTRIAL VALVES PVT. LTD. (Cast CS only: upto 24"(150#), 20"(300#), 10" (600#) & Forged : upto 2" (800#)	INDIA
20	HAWA ENGINEERS LTD. (Gate Valves: upto 40"(150#), upto 26" (300#), upto 24" (600#), upto 2" (800#); Globe Valves: upto 20"(150#), upto 16" (300#), upto 12" (600#), upto 2" (800#), Check Valves: upto 36"(150#), upto 24" (300#), upto 16" (600#), upto 2" (800#) (Dual Plate: 36" (150#)	INDIA
21	HAWA VALVES INDIA PVT. LTD. (CS upto 6", 150#)	INDIA
22	HI-TECH VALVES PVT. LTD. (CS,<=800 #, SIZE 1/2-2, <=300# FOR SIZE 2-6")	INDIA
23	INTERVALVE INDIA LTD. (CAST UPTO 24" (UPTO 300#) & UPTO 12" 600# , FORGED UPTO 2" (800#))	INDIA
24	JC VALVES & CONTROLS INDIA PVT. LTD. (CAST UPTO 48" (150#) & 24" (UPTO 600#) & FORGED UPTO 2" (800#))	INDIA
25	KIRLOSKAR BROTHERS LTD.(CS UPTO 12" , 300#)	INDIA
26	KSB PUMPS LIMITED (VALVES DIVN)	INDIA
27	LARSEN & TOUBRO LIMITED (1/2" TO 24")	INDIA
28	LEADER VALVES LTD. (Casting<=20"-600#, 300-150#, Forging<=2"-800#)	INDIA
29	M.H. VALVES PVT. LTD. (1/2" to 1 1/2"-800#, 2" to 6"-600#)	INDIA
30	MICON ENGINEERS (HUBLI) [PVT. LTD.(Cast: Upto 12" (150# & 300#), 6" (600#) & Forged: upto 2" (800#))	INDIA
31	MICROFINISH VALVES LTD.	INDIA

	EMERGENCY DIESEL GENERATORS PACKAGE TALCHER FERTILIZERS LIMITED VENDOR LIST	PC183/E/4022/SecVI-10.0	0	
		Document No.	Rev	
		Sheet 23 of 30		



32	NSSL LTD. (UPTO 80" (150#), 56" UPTO 600# & FORGED UPTO 2" (800 #))	INDIA
33	NITON VALVES INDUSTRIES PVT. LTD.	INDIA
34	OSWAL IND. LTD. (UPTO 48" (150#), 32" (300#) & 24" (600#)	INDIA
35	S & M INDUSTRIAL VALVES LTD. (CS Gate & Globe Valves 2" – 24" <=300#)	INDIA
36	SHALIMAR VALVES PVT. LTD. (Cast Upto 24" (Upto 600#), Forged: ½" to 1 ½" (800#))	INDIA
37	SHREERAJ INDUSTRIES (CS upto 150#)	INDIA
38	STEEL STRONGVALVES (I) PVT. LTD. (Upto 42")	INDIA
39	VENUS PUMP & ENGINEERING WORKS.	INDIA
40	VIBA FLUID CONTROL	INDIA
41	WEIR BDK VALVES (A UNIT OF WEIR INDIA PVT. LTD.) (Cast UPTO 36" (150#); 24" (300#); 12" (600#) & Forged: Upto 2" (800#))	INDIA
42	ZED VALVES CO. PVT. LTD. (Upto 14" (600#))	INDIA
43	ZOLOTO INDUSTRIES. (40 MM TO 200 MM(ONLY CS & SS))	INDIA
44	VELAN INC. (UPTO 48" , 600#)	CANADA
45	BOTELI VALVE GROUP CO. LTD.(Cast Upto 56" (150#), 36" (300#), 24" (600#) & Forged: Upto2" (800#))	CHINA
46	ZHEJIANG JIEHUA VALVE CO. LTD.	CHINA
47	PEMTO VALVE	GERMANY
48	CESARE BONETTI SPA (Cast Upto 42" (Upto 300#), 24" (600#) Forged: ½" to 1 ½" (800#))	ITALY
49	FASANI S.P.A.	ITALY
50	FRIULCO SPA (UPTO 48" (150#), 32" (Upto 600#)	ITALY
51	GTC ITALIA, S.R.L.	ITALY
52	MANTOVANI SpA	ITALY
53	OMB S.P.A.	ITALY
54	PETROL VALVES S.R.L.	ITALY
55	MATSURA H. P MACHINE WORKS CO.LTD.	JAPAN
56	NISHITANI & CO. LTD.	JAPAN
57	SOJITZ CORPORATION	JAPAN
58	REDPOINT ALLOYS BV	NETHERLAND
59	WALTHAN & WEIR	SPAIN
60	POYAM VALVES (AMPO S.CCP.) (Size upto 60" (Rating upto 800#)	SPAIN
61	BABCOCK BORSIG ESPANA , S.A	SPAIN
62	SUFA LIMITED	U.A.E.
63	BEL VALVES	U.K.
BALL VALVES (SOFT SEATED)		

	EMERGENCY DIESEL GENERATORS PACKAGE TALCHER FERTILIZERS LIMITED VENDOR LIST	PC183/E/4022/SecVI-10.0	0	
		Document No.	Rev	
		Sheet 24 of 30		



1	A V VALVES LIMITED (Upto 12" (Upto 600#))	INDIA
2	AIRA EURO AUTOMATION PVT. LTD. (Upto 6", Rating 150# & 300#),	INDIA
3	AQUA VALVES PVT. LTD.	INDIA
4	BRIGHTECH VALVES & CONTROLS PVT. LTD. (4" x 150# for CS, AS & SS material)	INDIA
5	CHEMTECH INDUSTRIAL VALVES PVT. LTD.	INDIA
6	CRAWLEY & RAY (FOUNDER & ENGINEERS) PVT. LTD. (DN25)	INDIA
7	DELVAL FLOW CONTROLS PVT. LTD. (Upto 12" (Upto 900#))	INDIA
8	FLOCON SYSTEMS PVT. LTD. (CS upto 6", 150#)	INDIA
9	FLOW CONTROL	INDIA
10	FLOWCHEM INDUSTRIES (UPTO 300# and upto 10")	INDIA
11	FLUIDTECH EQUIPMENT PVT. LTD(UPTO 4" (300#))	INDIA
12	FORWARD ALLOYS AND CASTINGS (Upto 900#)	INDIA
13	GURU INDUSTRIAL VALVES PVT. LTD. (Cast CS only: Upto 12" (Upto 300#), 4" (Upto 900#) & Forged: Upto 2" (800#))	INDIA
14	HAWA ENGINEERS LTD. (Upto 16" (150# & 300#), Upto 12" (600# & 900#))	INDIA
15	INTERVALVE INDIA LTD. (Forged: Upto 2" (800#), Cast: Upto 12" (Upto 300#))	INDIA
16	JC VALVES & CONTROLS INDIA PVT. LTD. (CAST UPTO 28" (upto 600#), 12" (900# , 1500#) & 10" (2500#))	INDIA
17	KSB PUMPS LTD. (VALVES DIVN.) (CS upto 100DN, 20 bar)	INDIA
18	LEADER VALVES LTD. (Casting upto 600#, 6" & forging upto 800#, 2")	INDIA
19	MICON ENGINEERS (HUBLI) PVT. LTD. (Cast: Upto 6" (150# & 300#) & Forged: Upto 2" (800#)	INDIA
20	MICROFINISH VALVES (P) LTD.	INDIA
21	NSSL LTD. (Upto 12" (150# & 300#))	INDIA
22	OSWAL IND. LTD. (Upto 24" (150#, 300# & 600#))	INDIA
23	SHALIMAR VALVES PVT. LTD. (Upto 18" (600#) Material: CS/AS/SS)	INDIA
24	VIBA FLUID CONTROL (Upto 300#)	INDIA
25	VIRGO ENGINEERS LTD. (Upto 16" (upto 600#))	INDIA
26	WEIR BDK VALVES (Cast: Upto 30" (150# & 300#), 20" (600#), 16" (900#), 12" (1500#) & Forged: Upto 2" (800#))	INDIA

	EMERGENCY DIESEL GENERATORS PACKAGE TALCHER FERTILIZERS LIMITED VENDOR LIST	PC183/E/4022/SecVI-10.0	0	
		Document No.	Rev	
		Sheet 25 of 30		



27	XOMOX SANMAR LTD.(FISHER XOMOX)	INDIA
28	BHDT GMBH	AUSTRIA
29	BOTELI VALVE GROUP CO. LTD. (Upto 32" (150# & 300#), 30" (600#), 24" (900#)	CHINA
30	ZHEJIANG JIEHUA VALVE CO. LTD.	CHINA
31	VELAN INC.(UPTO 16", 600#)	CANADA
32	ETS TROUVAY & CAUVIN	FRANCE
33	PERRIN GMBH (2500#, SIZE UPTO 24")	GERMANY
34	FRIULCO SPA (UPTO 48" (150# & 300#); 20" (upto 1500#); 12" (2500#))	ITALY
35	CESARE BONETTI SPA (Cast: Upto 4" (150#) & Forged: Upto 1" (800#) Floating only)	ITALY
36	GTC ITALIA S.R.L	ITALY
37	MANTOVANUI SPA	ITALY
38	PIBIVESSE SRL (UPTO 48" , 600#)	ITALY
39	PETROL VALVES S.R.L	ITALY
40	METSO AUTOMATION	SINGAPORE
41	POYAM VALVES (AMPO S. COOP.) (Size upto 42" (Rating upto 2500#))	SPAIN
42	HATIMA CORPORATION	TAIWAN
FLAT GASKETS		
1	FERROLITE JOININGS (P) LTD.	INDIA
2	GASKETS (INDIA) PVT. LTD	INDIA
3	GOODRICH GASKET PVT. LTD. (UPTO 24")	INDIA
4	HINDUSTAN ASBESTOS & ALLIED PRODUCTS	INDIA
5	HINDUSTAN COMPOSITE LTD.	INDIA
6	HINDUSTAN FERREDO LTD.	INDIA
7	IGP ENGINEERS LIMITED	INDIA
8	MADRAS INDUSTRIAL PRODUCTS(UPTO 48")	INDIA
9	MECHANICAL PACKING INDUSTRIES LTD.	INDIA
10	PACKING & JOINTINGS (P) LTD.	INDIA
11	PERFECT MARKETING (P) LTD,	INDIA
12	PRASHANT ENGG STORES	INDIA
13	REIN TALBROS PVT. LTD.	INDIA
14	SPIRALSEAL GASKETS PVT. LTD. (CAF & Teflon)	INDIA
15	STARFLEX SEALING INDIA PVT. LTD.	INDIA
16	THE BENGAL MILL STORES SUPPLY CO. (TRADER)	INDIA
17	UNIQUE INDUSTRIAL PACKINGS PVT. LTD.	INDIA
SPIRALLY WOUND GASKETS		

	EMERGENCY DIESEL GENERATORS PACKAGE TALCHER FERTILIZERS LIMITED VENDOR LIST	PC183/E/4022/SecVI-10.0	0	
		Document No.	Rev	
		Sheet 26 of 30		

1	GASKETS (INDIA) PVT. LTD	INDIA
2	GOODRICH GASKET PVT. LTD.	INDIA
3	IGP ENGINEERS LIMITED	INDIA
4	MADRAS INDUSTRIAL PRODUCTS	INDIA
5	PACKINGS & JOINTINGS PVT. LTD	INDIA
6	PERFECT MARKETING (P) LTD,	INDIA
7	PRASHANT ENGG STORES	INDIA
8	SPIRASEAL GASKETS PVT. LTD.	INDIA
9	STARFLEX SEALING INDIA PVT. LTD.	INDIA
10	THE BENGAL MILL STORES SUPPLY CO. (TRADER)	INDIA
11	UNIQUE INDUSTRIAL PACKINGS PVT.LTD. (UPTO 42"(600#) & UPTO 24" (2500#))	INDIA
12	ZHEJIANG JIEHUA VALVE CO. LTD.	INDIA
STRAINERS (PERMANENT INCLUDING Y-TYPE)		
1	CHEMTECH INDUSTRIAL VALVES PVT. LTD	INDIA
2	FLAIR STRAINERS & FILTERS (SIZE UPTO 42" (RATING UPTO 1500#))	INDIA
3	GRAND PRIX ENGINEERING PVT. LTD. (UPTO 60" PIPELINE, UPTO ANSI 1500#)	INDIA
4	GREAVES LIMITED	INDIA
5	GUJARAT OTOFILT	INDIA
6	HAWA ENGINEERS LTD. (1/2" to 24" (150# / 300#)	INDIA
7	KWIKFLO FILTERS PVT. LTD.	INDIA
8	LEADER VALVES LTD. (upto 300# & upto 12" size)	INDIA
9	MULTITEX FILTERATION ENGINEERS LTD	INDIA
10	MOD FABRICATORS	INDIA
11	ZOLOTO INDUSTRIES (15MM TO 100MM)	INDIA
12	BOTELI VALVE GROUP CO. LTD. (Y - TYPE ONLY: 14" (150#) & 3" (300# & 600#))	CHINA
SPRING SUPPORTS		
1	MYRICS PIPING SYSTEM PVT.LTD.	INDIA
2	PIPE SUPPORTS INDIA PVT. LTD.	INDIA
3	PIPING & ENERGY PRODUCTS (P) LTD.	INDIA
4	SARATHI ENGG. ENTERPRISES PVT. LTD.	INDIA
5	SPRING SUPPORTS MFG. CO.	INDIA

	EMERGENCY DIESEL GENERATORS PACKAGE TALCHER FERTILIZERS LIMITED VENDOR LIST	PC183/E/4022/SecVI-10.0	0	
		Document No.	Rev	
		Sheet 27 of 30		

6	FLEXIDER S.P.A.	ITALY
FASTENERS		
1	AEP COMPANY	INDIA
2	CAPITAL INDUSTRIES	INDIA
3	CONSOLE ENGG. & FASTNERS INDUSTRIES	INDIA
4	EBY FASTNERS	INDIA
5	FIT TIGHT NUTS & BOLTS LTD.	INDIA
6	FIX FIT FASTENERS MFG. PVT. LTD.	INDIA
7	INDUSTRIAL ENGINEERING CORPORATION (SIZE UPTO 4" (M100))	INDIA
8	MEGA ENGINEERING PRIVATE LIMITED (1/2" TO 3" MATERIAL: CS/AS/SS)	INDIA
9	METRO MECHANICAL PVT.LTD.	INDIA
10	NAGBHUSHANAM INDUSTRIES	INDIA
11	NIREKA ENGG. CO. PVT. LTD.	INDIA
12	PACIFIC FORGING & FASTENERS PVT. LTD. (M 10 TO M125)	INDIA
13	PERFECT MARKETING (P) LTD,	INDIA
14	PIONEER NUTS & BOLTS PVT. LTD.	INDIA
15	PRECISION AUTO ENGINEERS	INDIA
16	PRECISION ENGINEERING INDUSTRIES	INDIA
17	PTD FASTNERS PVT. LTD.	INDIA
18	SANGHVI METALS (TRADER)	INDIA
19	SUNDARAM FASTENERS LIMITED	INDIA
20	UDHERA FASTENERS	INDIA
HOSE PIPE (METALLIC) & CAM LOCK COUPLING		
1	AEROFLEX INDUSTRIES LIMITED (Size 6mm to 250mm dia. (SS Corrg. Flex. Hose with Braid, Braid & Assembly)	INDIA
2	CHHATARIA RUBBER CHEMICALS INDUSTRIES	INDIA
3	D. WREN & CO.	INDIA
4	FLEXATHERM EXPANLLOW PVT. LTD. (1/2" to 6")	INDIA
5	GAYATRI INDUSTRIES	INDIA
6	GAYATRI INDUSTRIAL CORPORATION (UPTO 6" ID)	INDIA
7	HELIFEX HYDRAULICS & ENGG CO. LTD.	INDIA
8	SENIOR INDIA PVT. LTD.	INDIA
HOSE PIPE (NON-METALLIC) & CAM LOCK COUPLING		

	EMERGENCY DIESEL GENERATORS PACKAGE TALCHER FERTILIZERS LIMITED VENDOR LIST	PC183/E/4022/SecVI-10.0	0	
		Document No.	Rev	
		Sheet 28 of 30		

1	CHHATARIA RUBBER CHEMICALS INDUSTRIES	INDIA
2	D. WREN & CO.	INDIA
3	GAYATRI INDUSTRIES	INDIA
4	GAYATRI INDUSTRIAL CORPORATION (UPTO 8" ID)	INDIA
5	HELIFEX HYDRAULICS & ENGG CO. LTD.	INDIA
6	PADMINI INDUSTRIES LIMITED	INDIA
7	PYROTEK INDUSTRIES (INDIA) PVT. LTD.	INDIA
8	SENIOR INDIA PVT. LTD.	INDIA

3.0	ROTATING EQUIPMENTS
------------	----------------------------

EOT CRANE		
1	TECHNOCRAFT	INDIA
2	UNICON TECHNOLOGIES PVT LTD.	INDIA
3	UNIQUE INDUSTRIAL HANADLERS PVT. LTD	INDIA
4	ELECTROMECH MATERIAL HANDLING SYSTEM.	INDIA
5	CENTURY CRANE PVT. LTD.	INDIA
6	GRIP ENGG.	INDIA
7	SAFEX INDUSTRIES LTD	INDIA
8	BRADY & MORIRIS ENGINEERING	INDIA
9	MEEKA MACHINERY PVT LTD	INDIA



GENERAL NOTES:

- i. Only 'First' Quality materials shall be used.
- ii. Bidder shall select sub vendors from the vendor list as specified below. Bidder shall ensure that sub vendor for the specified item has supplied item for the specified service & the supplied item is in satisfactory service since last 3 years as on date of offer. Vendor shall have well proven record for the specified services and shall be subjected to owner/consultant approval.
- iii. OWNER / CONSULTANT reserve the right to choose any of the approved make / vendor as per this list. Make of the item not indicated and any other make for the specified item shall be subject to owner's / consultant's approval.
- iv. Specifications of manufacturer's items shall be checked against tender item / specifications before selecting any product or brand name. In case of any discrepancy,

	EMERGENCY DIESEL GENERATORS PACKAGE TALCHER FERTILIZERS LIMITED VENDOR LIST	PC183/E/4022/SecVI-10.0	0	
		Document No.	Rev	
		Sheet 29 of 30		

tender item / specifications shall prevail, and any such brand of item shall not be used which is not conforming to tender specifications even if it is listed in this vendor list.

- v. In case of non-availability of any material among approved vendors / makes in a particular site / region, alternate vendor / make conforming to IS / BS etc. Shall be used subject to approval by OWNER / CONSULTANT.
- vi. Contractor shall get the the material sample approved by EIC as per the Vendor list before procurement.

	EMERGENCY DIESEL GENERATORS PACKAGE TALCHER FERTILIZERS LIMITED VENDOR LIST	PC183/E/4022/SecVI-10.0	0	
		Document No.	Rev	
		Sheet 30 of 30		

NOTE:

1. Bidder to note that above vendor list enclosed with the NIT shall only be followed by bidder. Any additional vendor list furnished by bidder along with bid shall not be considered.
2. Contractor shall evaluate and decide present financial, performance credential and Shop loading conditions of the above vendors before placement of enquiry/orders.
3. Make of the equipment/machinery/item, not indicated shall be subject to Owner's / Consultant's approval.
4. Vendor List shall be prepared by Bidder for equipment/machinery/item not covered in above Vendor List. While submitting the additional vendor list, bidder has to ensure the following points.
 - As it is not possible to ascertain credentials of all the added vendors by Bidders by Owner, with regard to the additional vendors proposed by Bidder, following prequalification criteria, with respect to Past Performance / Experience for any Equipment/item shall be applicable:

The Vendor during the last 15 (fifteen) years, should have designed, manufactured (under third party inspection agencies like Lloyds Register/TUV/BVIS) and supplied at least TWO similar Plant Equipment or Machinery or Item for similar duties and operating conditions and same should be operating satisfactorily after installation for at least TWO years.

The Bidders should satisfy themselves that sufficient documentary proof is submitted such as:

- a. Copy of Purchase Orders with full technical details of the equipment
- b. Certificate from user regarding satisfactory performance.
- c. Accreditation from third party inspection agencies like Lloyds Register, TUV, BVIS.
- d. Availability of After Sales Service and Spares in India.
- e. Availability of ASME Certification and its validity.

All documents (PTR) shall be in English language only.

The Bidder shall certify suitability of such vendors as per above..

Vendor for these equipment/machinery/item shall be finalized during detail engineering stage upon mutually agreed condition between bidder & Owner/Consultant.