



NOTICE INVITING TENDER

FOR

**SUPPLY CUM ERECTION OF ELECTRICAL &
INSTRUMENTATION WORKS ON ITEM RATE BASIS**

AT

**TALCHER FERTILIZERS LTD.,
ANGUL, ODISHA**



NIT NO. : PNPM/PC-183/E/8003/NCB

PREPARED AND ISSUED BY



**PROJECTS & DEVELOPMENT INDIA LTD.
(A Govt. of India Enterprise)
PDIL BHAWAN, A-14, Sector-1,
NOIDA-201301, U.P., India**

Date of Issue: 9th March '23

	SUPPLY CUM ERECTION OF ELECTRICAL & INSTRUMENTATION WORKS ON ITEM RATE BASIS AT TALCHER FERTILIZERS LIMITED, ANGUL, ODISHA MASTER INDEX	PC-183/ E-8003/ / MI	0	
		DOC. NO.	REV.	
		Page 1 of 1		

MASTER INDEX

NIT NO. : PNP/PC-183/E/8003/NCB

NIT DESCRIPTION : SUPPLY CUM ERECTION OF ELECTRICAL & INSTRUMENTATION WORKS ON ITEM RATE BASIS

Section-I	Invitation for Bid [IFB]
Section-II	BID EVALUATION CRITERIA [BEC] & Evaluation methodology
Section-III	Instructions to Bidders [ITB] Annexure(s) Forms & Formats
Section-IV	General Conditions of Contract [GCC]
Section-V	Special Conditions of Contract [SCC]
Section-VI	Specifications, Scope of Work and Drawing
Section-VII	Schedule of Rates





PROJECTS & DEVELOPMENT INDIA LIMITED

PC-183/ E-8003/ S-I

0

DOC. NO.

REV.



Page 1 of 7

SECTION-I

INVITATION FOR BID (IFB)

Date of Issue: 9th March'23



**COMPOSITE SUPPLY CUM ERECTION OF
ELECTRICAL & INSTRUMENTATION WORKS FOR
OSBL FACILITIES ON ITEM RATE BASIS
AT
TALCHER FERTILIZERS LIMITED, ANGUL, ODISHA**

PC-183/ E-8003/ S-I 0

DOC. NO. REV.

Page 2 of 7



SECTION-I

"INVITATION FOR BID (IFB)"

Ref No: PNPM/PC-183/E/8003/NCB

Date: 09.03.2023

To,

PROSPECTIVE BIDDERS

SUB: TENDER DOCUMENT FOR "COMPOSITE SUPPLY CUM ERECTION OF ELECTRICAL & INSTRUMENTATION WORKS" FOR OSBL FACILITIES ON ITEM RATE BASIS AT TALCHER FERTILIZERS LIMITED, TALCHER, ODISHA"

Dear Sir/Madam,

1.0 Projects and Development India Limited (PDIL), hereinafter referred to as CONSULTANT on behalf of M/s Talcher Fertilizers Ltd. (TFL), hereinafter referred as OWNER, has the pleasure of inviting eligible bidders to submit Bid ONLINE through Central Public Procurement (CPP) Portal (<https://eprocure.gov.in>) in Single Stage Two Bid System, for the subject Project.

The entire set of Bidding documents is also placed on the website at TFL website (<http://tflonline.co.in>) and PDIL website (www.pdilin.com),

2.0 The brief details of the tender are as under:

(A)	NAME OF WORK / BRIEF SCOPE OF WORK/JOB	COMPOSITE SUPPLY CUM ERECTION OF ELECTRICAL & INSTRUMENTATION WORKS FOR OSBL FACILITIES ON ITEM RATE BASIS AT TALCHER FERTILIZERS LIMITED, TALCHER, ODISHA	
(B)	TENDER NO. & DATE	PNPM/PC-183/E/8003/NCB dated 09.03.2023	
(C)	TYPE OF BIDDING SYSTEM	SINGLE BID SYSTEM	<input type="checkbox"/>
		TWO BID SYSTEM	<input checked="" type="checkbox"/>
(D)	TYPE OF TENDER	E-TENDER (CPP PORTAL)	<input checked="" type="checkbox"/>

Date of Issue: 9th March'23



**COMPOSITE SUPPLY CUM ERECTION OF
ELECTRICAL & INSTRUMENTATION WORKS FOR
OSBL FACILITIES ON ITEM RATE BASIS
AT
TALCHER FERTILIZERS LIMITED, ANGUL, ODISHA**

PC-183/ E-8003/ S-I 0
DOC. NO. REV.
Page 3 of 7



		MANUAL	<input type="text"/>				
(E)	COMPLETION PERIOD	14 (Fourteen) months from date of issuance of FOA (Fax of Acceptance)					
(F)	BID VALIDITY	The bid validity period shall be 60 Days from Bid due date.					
(G)	BID SECURITY / EARNEST MONEY DEPOSIT (EMD)	<table border="1"><tr><td>APPLICABLE</td><td>✓</td></tr><tr><td>NOT APPLICABLE</td><td>✗</td></tr></table>	APPLICABLE	✓	NOT APPLICABLE	✗	<p>Amount: Rs.24.75 Lakh (Rupees Twenty Four Lakh and Seventy Five Thousand Only).</p> <p>Exempted Bidders (i.e. MSMEs and Govt. Dept./PSUs) are required to submit declaration for Bid security as per Form F-2B</p> <p>(Also refer clause no.16 of ITB)</p>
APPLICABLE	✓						
NOT APPLICABLE	✗						
(H)	AVAILABILITY OF TENDER DOCUMENT ON WEBSITE(S)	From 09.03.2023 (09:00 Hrs, IST) to 10.04.2023 (15:00 Hrs, IST) on following websites: (i) Govt. CPP Portal https://eprocure.gov.in (ii) TFL Website - http://tflonline.co.in (iii) PDIL website - www.pdilin.com					
(I)	DATE, TIME & VENUE OF PRE-BID MEETING	On 20.03.2023 (14:30 Hrs, IST), through Physical mode at PDIL, Noida office.					
(J)	START OF BID SUBMISSION ON CPP PORTAL	29.03.2023 at 09:00 Hrs. (IST)					
(K)	DUE DATE & TIME OF BID-SUBMISSION	Date : 10.04.2023 Time : 15:00 Hrs (IST)					
(L)	DATE AND TIME OF UN-PRICED BID OPENING (IN PRESENCE OF AUTHORIZED REPRESENTATIVE OF BIDDERS)	Date: 11.04.2023 Time :15:00 hrs (IST) Onwards Venue: M/s Projects & Development India Limited, (Project Management Department) P.D.I.L Bhawan, A-14, Sector-1, Noida, (PIN 201301) Dist. Gautam Budh Nagar (UP). (India)					



**COMPOSITE SUPPLY CUM ERECTION OF
ELECTRICAL & INSTRUMENTATION WORKS FOR
OSBL FACILITIES ON ITEM RATE BASIS
AT
TALCHER FERTILIZERS LIMITED, ANGUL, ODISHA**

PC-183/ E-8003/ S-I 0

DOC. NO. REV.

Page 4 of 7



(M)	ADDRESS FOR COMMUNICATION WITH PDIL	Projects & Development India Limited, (Project Management Department) P.D.I.L Bhawan, A-14, Sector-1, Noida , (India) Fax no.:0120-2529801	
		Kind Attention: 1) Mr. Kailash Joshi- Project Manager Tel no. : +91-120-2529842/43/47/51/53/54 Extn. 314 Mob. No. : 9718762091 Fax no. : +91-120-2529801 E-mail : kjoshi@pdilin.com	
		2) Mr. Abhilesh Kumar- Project Co-ordinator Tel no. : +91-120-2529842/43/47/51/53/54 Extn. 316 Mob. No. : 8178085434 Fax no. : +91-120-2529801 E-mail : abhilesh@pdilin.com	
	ADDRESS FOR COMMUNICATION WITH OWNER (TFL) AT PROJECT OFFICE	GAIL Training Institute PARC Building PLOT NO. 24, FILM CITY, SECTOR 16A, NOIDA- 201301 Kind Attention : Mr. S.M. Badruddoja DGM (Projects) E-mail : sm.badruddoja@gail.co.in Mob. No. : +91-8859500094	
(O)	ADDRESS FOR COMMUNICATION WITH OWNER (TFL) AT SITE FOR SITE VISIT	M/s Talcher Fertilizers Ltd. (TFL), Administrative Building, Talcher, Post: Vikrampur, Dist: Angul, Pincode-759106, Odisha Mr. Satyabrata Mishra-GM (Projects) Mob No. : +91-9927339444 E-mail : smishra@gail.co.in	
(P)	Reverse Auction	APPLICABLE	<input type="checkbox"/>
		NOT APPLICABLE	<input checked="" type="checkbox"/>
		(Also refer Clause No. 52 of ITB)	

Date of Issue: 9th March'23



**COMPOSITE SUPPLY CUM ERECTION OF
ELECTRICAL & INSTRUMENTATION WORKS FOR
OSBL FACILITIES ON ITEM RATE BASIS
AT
TALCHER FERTILIZERS LIMITED, ANGUL, ODISHA**

PC-183/ E-8003/ S-I

0

DOC. NO.

REV.



Page 5 of 7

(Q)	Original Documents to be submitted at	Projects & Development India Limited, (Project Management Department) P.D.I.L Bhawan, A-14, Sector-1, Noida, (PIN 201301) Dist. Gautam Budh Nagar (UP). (India) Kind Attention: Mr. Kailash Joshi, Project Manager Mob.no.: 9718762091
------------	---------------------------------------	--

In case the days specified above happens to be a holiday in TFL/PDIL, the next working day shall be implied.

- 3.0 Bids must be submitted strictly in accordance with Clause No. 11 of ITB depending upon Type of Tender as mentioned at Clause no. 2.0 (D) of IFB. The IFB is an integral and inseparable part of the bidding document.
- 4.0 Bid must be submitted only on CPP Portal (<https://eprocure.gov.in/eprocure/app>). Further, the following documents in addition to uploading the bid on CPPP's Portal shall also be submitted in Original (in physical form) within 7 (seven) days(*) from the bid due date, provided the scanned copies of the same have been uploaded in e-tender by the bidder along with e-bid within the due date and time to the address mentioned in Clause no. 2.0 (Q) of IFB:-
- i) EMD (for all bidders except exempted category) /Declaration for Bid Security (for exempted bidders)
 - ii) Power of Attorney
 - iii) Integrity Pact
- 5.0 Bidder(s) are advised to quote strictly as per terms and conditions of the tender documents and not to stipulate any deviations/exceptions.
- 6.0 Any bidder, who meets the Bid Evaluation Criteria (BEC) and wishes to quote against this Tender Document, may download the complete Tender Document along with its amendment(s) if any from websites as mentioned at 2.0 (H) of IFB and submit their Bid complete in all respect as per terms & conditions of Tender Document on or before the Due Date & Time of Bid Submission.
- 7.0 Bid(s) received from bidders to whom tender/information regarding this Tender Document has been issued as well as offers received from the bidder(s) by downloading Tender Document from above mentioned website(s) shall be taken into consideration for evaluation & award provided that the Bidder is found responsive subject to provisions contained in Clause No. 2 of ITB (Section-III of tender).

The Tender Document calls for offers on single point "Sole Bidder" responsibility basis (except where JV/Consortium bid is allowed pursuant to clause no. 3.0 of ITB) and in total compliance of Scope of Works as specified in Tender Document.

Date of Issue: 9th March'23



**COMPOSITE SUPPLY CUM ERECTION OF
ELECTRICAL & INSTRUMENTATION WORKS FOR
OSBL FACILITIES ON ITEM RATE BASIS
AT
TALCHER FERTILIZERS LIMITED, ANGUL, ODISHA**

PC-183/ E-8003/ S-I	0
DOC. NO.	REV.
Page 6 of 7	



- 8.0 Any revision, clarification, corrigendum, time extension, etc. to this Tender Document will be hosted on the website(s) only as mentioned at 2.0 (H) of IFB. Bidders are requested to visit the CPP Portal regularly to keep themselves updated. No complaint/representation shall be entertained from bidders in case they do not see / download the amendments, etc. issued to the tender document by TFL from time to time on the CPP Portal.
- 9.0 All bidders who are willing to submit their bid are required to submit F-6 (Acknowledgement cum Consent letter) duly filled within 7 days from date of receipt of tender information.
- 10.0 The bidder shall submit the bid ONLINE through Central Public Procurement (CPP) Portal. Bids complete in all respects should be uploaded in the CPP portal on or before the Bid Due Date and time mentioned in at SI No. 2(K) above. Bids through Post/ Fax / E-mail /CD/ any other mode other than that specified in ITB will not be accepted.
- 11.0 TFL/PDIL reserves the right to reject any or all the bids received at its discretion without assigning any reason whatsoever.

This is not an Order

Thanking You,
For and on behalf of
Talcher Fertilizers limited

(Kailash Joshi)
Project Manager
Projects & Development India Limited
E-mail ID : kjoshi@pdilin.com
Contact No. :0120-2529842/ Ext. 314

Date of Issue: 9th March'23



**COMPOSITE SUPPLY CUM ERECTION OF
ELECTRICAL & INSTRUMENTATION WORKS FOR
OSBL FACILITIES ON ITEM RATE BASIS
AT
TALCHER FERTILIZERS LIMITED, ANGUL, ODISHA**

PC-183/ E-8003/ S-I

0

DOC. NO.

REV.

Page 7 of 7



DO NOT OPEN - THIS IS A QUOTATION
PHYSICAL DOCUMENTS

Tender Document No. :

Description : **COMPOSITE SUPPLY CUM ERECTION OF ELECTRICAL
& INSTRUMENTATION WORKS FOR OSBL FACILITIES
ON ITEM RATE BASIS AT TALCHER FERTILIZERS
LIMITED, TALCHER, ODISHA**

Due Date & Time : **10.04.2023 at 15:00 Hrs.**

From:

.....
.....
.....
.....

To:

Projects & Development India Limited,
(Project Management Department)
P.D.I.L Bhawan, A-14, Sector-1,
Noida , (India)
Fax no.:0120-2529801

Kind Attention:

1) Mr. Kailash Joshi- Project Manager
Tel no. : +91-120-2529842/43/47/51/53/54
Extn. 314

Mob. No. : 9718762091

Fax no. : +91-120-2529801

E-mail : kjoshi@pdilin.com

2) Mr. Abhilesh Kumar- Project Co-ordinator

Tel no. : +91-120-2529842/43/47/51/53/54
Extn. 316

Mob. No. : 8178085434

Fax no. : +91-120-2529801

E-mail : abhilesh@pdilin.com

(To be pasted on the envelope containing Physical Document)

Date of Issue: 9th March'23



PROJECTS & DEVELOPMENT INDIA LIMITED

PC-183/ E-8003/ S-II

0

DOC. NO.

REV.

Page 1 of 10





SECTION-II

BID EVALUATION CRITERIA

&

EVALUATION METHODOLOGY

Date of Issue: 9th March'23

	COMPOSITE SUPPLY CUM ERECTION OF ELECTRICAL & INSTRUMENTATION WORKS FOR OSBL FACILITIES ON ITEM RATE BASIS AT TALCHER FERTILIZERS LIMITED, ANGUL, ODISHA	PC-183/ E-8003/ S-II	0	
		DOC. NO.	REV.	
		Page 2 of 10		

SECTION-II

BID EVALUATION CRITERIA (BEC) & EVALUATION METHODOLOGY

Bidder shall submit bid subject to meeting the Bid Evaluation Criteria as stated here. Evaluation of Technical and Commercial offers shall be carried out for only those Bidders who shall meet the Bid Evaluation Criteria.

1.0 Technical Criteria:

- 1.1** The bidder must have completed “**Similar work**”, during the last Seven (07) years reckoned from the original bid opening date.

“**Similar work**” shall mean the following:

The bidder must have completed Supply and Erection of Electrical and Instrumentations works (which must include Supply & Erection of Electrical equipments i.e. HV/415V Switchboards, Power Transformers).

Bidder meeting the criteria above must have completed

The bidder must have completed One “**Similar work**”, having completed value not less than **INR 23.36 Crore** (including all applicable taxes & duties).

(OR)

The bidder must have completed Two “**Similar works**”, each having completed value not less than **INR14.60 Crore** (including all applicable taxes & duties).

(OR)



The bidder must have completed Three “**Similar works**”, each having completed value not less than **INR11.68 Crore** (including all applicable taxes & duties).

Note: In case bidder has executed and completed composite works which includes any of the qualifying works(s) stated above i.e. (1.1), then value of such qualifying works out of the total value of composite works shall be considered for the purpose of qualification

- 1.2** The bidder must have valid ‘A’ Class Electrical Contractors License or equivalent to ‘A’ Class Electrical License issued from any State Government Agency/Authority

- 1.3 Applicability of Policy for providing preference to domestically manufactured Iron & Steel (DMI & SP) products.**

Bidder should have minimum prescribed domestic value addition requirement in line with the Domestic Manufactured iron & Steel Policy (DMI & SP) for the Iron & Steel products involved in execution of the contract. Bidder shall submit affidavit from the

	COMPOSITE SUPPLY CUM ERECTION OF ELECTRICAL & INSTRUMENTATION WORKS FOR OSBL FACILITIES ON ITEM RATE BASIS AT TALCHER FERTILIZERS LIMITED, ANGUL, ODISHA	PC-183/ E-8003/ S-II	0	
		DOC. NO.	REV.	
		Page 3 of 10		

domestic manufacturers of such Iron & steel products as per the Form-I mentioned in the policy document.



A bidder who is not manufacturer of Iron & Steel product and is unable to submit the Affidavit from domestic manufacturers at bidding stage, such bidder can submit the Affidavit issued by domestic manufacturers after placement of order. In this case bidder along with his bid shall submit an undertaking as per attached format in NIT.

If a bidder does not submit above affidavit/ undertaking as per format, the offer of bidder shall be rejected.

Notes for 1.1 above:

- I. Job completed by a Bidder for its own plant/ project cannot be considered as experience for the purpose of meeting BEC of the tender. However, jobs completed for Subsidiary/ Fellow subsidiary/ Holding company will be considered as experience for the purpose of meeting BEC subject to submission of tax paid invoice(s) duly certified by Statutory Auditor of the Bidder towards payments of statutory tax in support of the job completed for Subsidiary/ Fellow subsidiary/ Holding company. Such Bidders to submit these documents in addition to the documents specified to meet BEC.
- II. The bidder must submit the completion certificate/acceptance certificate issued by Order issuing authority/end user/ owner (or their consultant who has been duly authorized by them to issue such certificate) only after completion of work/ supply in all aspects.
- III. Only documents (Work order, completion certificate, execution certificate etc.) which have been referred /specified in the bid shall be considered in reply to the queries during evaluation of bids.

(After submission of bid, only related shortfall documents will be asked for in TQ/CQ and considered for evaluation. For example, if the bidder has submitted a contract without its completion/ performance certificate, the certificate will be asked for and considered. However, no new reference/ PO/WO/LOA is to be submitted by bidder in response to TQ/CQ so as to qualify and such documents will not be considered by TFL for evaluation of Bid.)
- IV. In case more than one contract/order/agreement/DLOA are emanating against same tender, these contracts are to be considered as single contract for evaluation of credentials of a bidder for meeting their experience criteria.
- V. Experience of bidder acquired as a sub-contractor is acceptable against submission of certificate from end user by such bidder along with other specified documents.
- VI. Bids from Consortium / Joint Venture shall not be accepted

	COMPOSITE SUPPLY CUM ERECTION OF ELECTRICAL & INSTRUMENTATION WORKS FOR OSBL FACILITIES ON ITEM RATE BASIS AT TALCHER FERTILIZERS LIMITED, ANGUL, ODISHA	PC-183/ E-8003/ S-II	0	
		DOC. NO.	REV.	
		Page 4 of 10		

2.0 Financial Criteria:



- 2.1** The Average Annual financial Turnover during the last three preceding financial years of the bidder should be minimum INR12.52Crore.
- 2.2** Net Worth of the bidder should be positive as per last audited financial year.
- 2.3** The Bidder should have minimum working capital equal to **INR 2.50 Crore** as per last audited financial year. However, if the bidder's working capital is negative or inadequate, the bidder shall submit a letter from their Bank having Net worth of the bank not less than Rs.100.0 Crore (or equivalent USD), confirming the availability of line of credit for **INR 2.50 Crore**. The line of credit from bank shall be submitted strictly as per prescribed format.

"Notes for 2.1, 2.2 & 2.3"

Annual Turnover: Preceding 3 financial years mentioned in aforesaid BEC refer to immediate 3 preceding financial years wherever the closing date of the bid is after 30th September of the relevant financial year. In case the tenders having the due date for submission of bid up to 30th September of the relevant financial year, and audited financial results of the immediate 3 preceding financial years are not available, the audited financial results of the 3 years immediately prior to that will be considered. Further, in case bidder is meeting the Annual Turnover criteria of BEC based on Audited Financial Statement of any one of the preceding 3 financial years (as mentioned above), the same shall suffice and bidder may submit prescribed format accordingly.

Net Worth/Working Capital: Immediate preceding financial year mentioned in aforesaid BEC refer to audited financial results for the immediate preceding financial year wherever the closing date of the bid is after 30th September of the relevant financial year. In case the tenders having the due date for submission of bid up to 30th September of the relevant financial year, and audited financial results of the immediate preceding financial year is not available, in such case the audited financial results of the year immediately prior to that year will be considered. Bidder is to submit Audited Financial Statement of immediate preceding financial years (as mentioned above) along with format F-10 accordingly for Network / Working Capital.

Any shortfall information / documents on the Audited Annual Report / Financial Statement of the Bidder and/or line of credit for working capital issued on or before the final bid due date can only be sought against Commercial queries (CQs). Any information/ documents issued post final bid due date shall not be considered for evaluation.

	COMPOSITE SUPPLY CUM ERECTION OF ELECTRICAL & INSTRUMENTATION WORKS FOR OSBL FACILITIES ON ITEM RATE BASIS AT TALCHER FERTILIZERS LIMITED, ANGUL, ODISHA	PC-183/ E-8003/ S-II	0	
		DOC. NO.	REV.	
		Page 5 of 10		

3.0 **General Notes (for both Technical BEC and Financial BEC):**

Exchange rate for conversion of currency for evaluation of documents relating to BEC:



Exchange rate for Conversion of Currency for evaluation of documents submitted by bidders for BEC which are in a currency other than INR, shall be as follows:

- a) **BEC (Technical):** Bill Selling (foreign exchange) Rate of State Bank of India as prevailing on the date of award of order / contract submitted by bidder .
- b) **BEC (Financial)**
 - (i) **For Annual Turnover:** The average of Bill Selling (foreign exchange) Rate of State Bank of India as prevailing on the First date and Last date of the respective Financial Year.
 - (ii) **For Net Worth & Working Capital:** The Bill Selling (foreign exchange) Rate of State Bank of India as prevailing on the Last date of the respective Financial Year
- c) In case, the SBI Selling rate is not available as on the date of conversion as specified above for respective cases, the exchange rate for conversion of currency shall be taken from the internet, such as

<https://www.xe.com/currencyconverter>
<https://economictimes.indiatimes.com/markets/forex/currency-converter>
<https://www.oanda.com/currency/converter>

4.0 **BEC for START-UPS:**

The Technical and Financial BEC as stipulated above shall also be applicable for start-ups. However, the Startups are exempted from submission of EMD. For availing the relaxation of EMD, bidder is required to submit requisite certificate towards Startup enterprise registration issued by Department of Industrial Policy and Promotion, Ministry of Commerce & Industry and the certificate should be certified by the Chartered Accountant (not being an employee or a Director or not having any interest in the bidder's company/firm) and notary public with legible stamp."

	COMPOSITE SUPPLY CUM ERECTION OF ELECTRICAL & INSTRUMENTATION WORKS FOR OSBL FACILITIES ON ITEM RATE BASIS AT TALCHER FERTILIZERS LIMITED, ANGUL, ODISHA	PC-183/ E-8003/ S-II	0	
		DOC. NO.	REV.	
		Page 6 of 10		

5.0 Documents to be submitted for Compliance to BEC

(i) Technical Criteria of BEC:

To meet the criteria of **1.1** above, Bidder must submit copy of Detailed Letter of Acceptance (DLOA) / Work Order /relevant extract of work Order/ Contract Agreement along with detailed scope of work and Completion / Acceptance Certificate. Such certificate shall be issued by Owner/End user.

The Detailed Letter of Acceptance (DLOA) / Work Order / Contract Agreement must inter alia include Scope of work, completion time, contract value, etc. Similarly, the Completion Certificate/ Acceptance Certificate must clearly indicate reference of relevant work order/DLOA/Contract Agreement, Name of Work, Completed order value and date of completion.



In cases where bidder has executed the work as a sub-contractor, such Completion certificate (for compliance to **1.1**) issued by the “Order issuing Authority” is also acceptable, provided that a certificate or letter from end user/Owner is submitted that the bidder has worked as a sub-contractor for that project.

To meet the criteria **1.2**, bidder shall submit valid ‘A’ Class Electrical Contractors License or equivalent to ‘A’ Class Electrical License issued from any State Government Agency/Authority

To meet the criteria **1.3** above, Bidder shall submit affidavit from the domestic manufacturers of Iron & steel products as per the Form-I enclosed with the policy documents. A bidder who is not manufacturer of Iron & Steel product and is unable to submit the Affidavit from domestic manufacturers at bidding stage, such bidder can submit the Affidavit issued by domestic manufacturers after placement of order. In this case bidder along with his bid shall submit an undertaking as per prescribed format.

(ii) Financial Criteria of BEC:

- (a) To meet the criteria for Sr. No. **2.1**, Bidder shall submit the Audited Financial Statements of the company for last preceding three (03) financial years.
- (b) To meet the criteria for Sr. No. **2.2**, Bidder shall submit the Audited Financial Statements of the last financial year
- (c) To meet the criteria for Sr. No. **2.3**, Bidder shall submit the Audited Financial Statements of last financial year along with (i) Bank’s Letter (if applicable)

	COMPOSITE SUPPLY CUM ERECTION OF ELECTRICAL & INSTRUMENTATION WORKS FOR OSBL FACILITIES ON ITEM RATE BASIS AT TALCHER FERTILIZERS LIMITED, ANGUL, ODISHA	PC-183/ E-8003/ S-II	0	
		DOC. NO.	REV.	
		Page 7 of 10		

(d) If the bidder's working capital is negative or inadequate, the bidder shall submit a letter from their bank having net worth not less than Rs.100 Crores (or equivalent USD), confirming the availability of line of credit for working capital amount mentioned herein above. The line of credit letter from bank to be submitted strictly as per prescribed format.

For 5 (ii) above, the “Notes for (2.1), (2.2) & (2.3) under 2.0” (Financial Criteria of BEC) shall apply.

(iii) Bidder shall submit Checklist as per prescribed format in respect of documents to be submitted by bidder towards BEC.

6.0 Authentication of documents submitted against BEC

1) Technical BEC

All documents in support of SI. No. 1.1, 1.2 & 1.3 of Technical Criteria of BEC to be furnished by the Bidder shall necessarily be duly certified/ attested by Chartered Engineer as well as Notary Public with legible stamp.

2) Financial BEC



Bidder shall submit “Details of financial capability of Bidder” in prescribed format (F-10) duly signed and stamped by a chartered accountant/ Certified Public Accountant (CPA).

Further, copy of audited annual financial statements submitted in bid shall be duly certified/ attested by Notary Public with legible stamp.

7.0 Evaluation Methodology:

The subject work is indivisible and complete work shall be awarded to successful overall lowest bidder as per evaluation methodology described below. In other words, evaluation of bids shall be done on overall L-1 basis considering all applicable taxes & duties including GST as under:

- (i) Total quoted price as per BOQ inclusive of all taxes & duties including GST after arithmetic correction of errors (if any).
- (ii) In case any cess on GST is applicable, same shall also be considered in evaluation.
- (iii) In case any unregistered bidder is submitting their bid, their prices will be loaded with applicable GST (CGST & SGST/UTGST or IGST) while evaluation of bid (if applicable as per Govt. Act/Law in vogue).
- (iv) The Price Evaluation will be subject to applicability of Purchase Preference Policies as mentioned in the tender document.

	COMPOSITE SUPPLY CUM ERECTION OF ELECTRICAL & INSTRUMENTATION WORKS FOR OSBL FACILITIES ON ITEM RATE BASIS AT TALCHER FERTILIZERS LIMITED, ANGUL, ODISHA	PC-183/ E-8003/ S-II	0	
		DOC. NO.	REV.	
		Page 8 of 10		

8.0 Applicability of Public Procurement (Make in India) Policy

The said policy shall be applicable for this package. Further, as the work is non divisible/non-splittable, therefore, the relevant provisions of policy shall be applicable. The minimum local content and all other provisions shall be as per Public Procurement (Make in India) Policy latest policy no. P-45021/2/2017-PP (BE-II) dated 16th September, 2020 or as updated from time to time.

9.0 Applicability of purchase preference of MSE's

Considering that the subject work falls under "Works Contract", Purchase preference to MSE Bidders shall not be applicable as per government guidelines. However, MSMEs and Government Department/ PSUs shall be exempted from payment of EMD and they shall submit Declaration of Bid security as per format.

~~**10.0 E-Reverse Auction (eRA)** - Not Applicable for this tender.
Please refer clause no.26.3 of Sec-III of ITB.~~

11.0 Bidder shall submit CBA Format as per attached Appendix-II.



**COMPOSITE SUPPLY CUM ERECTION OF
ELECTRICAL & INSTRUMENTATION WORKS FOR
OSBL FACILITIES ON ITEM RATE BASIS
AT
TALCHER FERTILIZERS LIMITED, ANGUL, ODISHA**

PC-183/ E-8003/ S-II 0

DOC. NO. REV.

Page 9 of 10



Appendix-I

**POLICY FOR PROVIDING PREFERENCE TO DOMESTICALLY MANUFACTURED
IRON & STEEL PRODUCTS IN GOVERNMENT PROCUREMENT**

Date of Issue: 9th March'23



भारत का राजपत्र The Gazette of India

असाधारण

EXTRAORDINARY

भाग II—खण्ड 3—उप-खण्ड (i)

PART II—Section 3—Sub-section (i)

प्राधिकार से प्रकाशित

PUBLISHED BY AUTHORITY

सं. 324]

नई दिल्ली, बुधवार, मई 29, 2019/ज्येष्ठ 8, 1941

No. 324]

NEW DELHI, WEDNESDAY, MAY 29, 2019/JYAISTHA 8, 1941

इस्पात मंत्रालय

अधिसूचना

नई दिल्ली, 29 मई, 2019

सा.का.नि. 385(अ).—घरेलू रूप से उत्पादित किए जाने वाले लौह एवं स्टील उत्पाद की सरकारी खरीद को प्राथमिकता दिए जाने के लिए संशोधित नीति सामान्य सूचना हेतु प्रकाशित की जाती है।

[फा. सं. 3(2)/2018-आईडीडी]

रसिका चौबे, अपर सचिव

सरकारी खरीद में घरेलू स्तर पर निर्मित लौह एवं इस्पात उत्पादों को बरीयता देने के लिए नीति - संशोधित, 2019

1. भूमिका

- 1.1 यह नीति सरकारी खरीद में घरेलू स्तर पर निर्मित लौह एवं इस्पात उत्पादों (डी एम आई एंड एस पी) को बरीयता देती है।
- 1.2 यह नीति यथा लागू निर्धारित गुणवत्ता मानदंडों के अनुपालन में उत्पादित लौह एवं इस्पात उत्पादों जिसे परिशिष्ट क में दिया गया है और परिशिष्ट ख में दिए गए लौह एवं इस्पात उत्पादों के लिए पूंजीगत माल पर लागू होती है।
- 1.3 यह नीति सरकार के प्रत्येक मंत्रालय अथवा विभाग और उनके प्रशासनिक नियंत्रण के अधीन सभी एजेंसियों/प्रतिष्ठानों तथा सरकारी परियोजनाओं के वास्ते लौह एवं इस्पात उत्पादों की खरीद के लिए इन एजेंसियों द्वारा वित्त पोषित परियोजनाओं पर लागू है। हालांकि, यह नीति वाणिज्यिक पुनः बिक्री के उद्देश्य से अथवा वाणिज्यिक बिक्री के लिए वस्तुओं के उत्पादन में उपयोग करने के उद्देश्य से लौह एवं इस्पात उत्पादों की खरीद पर लागू नहीं होगी।

2. परिभाषाएं

- 2.1 **बोली** लगाने वाला लौह एवं इस्पात का कोई घरेलू/विदेशी निर्माता अथवा उनके बिक्री एजेंट/अधिकृत वितरक/अधिकृत डीलर/अधिकृत आपूर्ति गृह अथवा सरकारी एजेंसियों द्वारा वित्त पोषित निधि परियोजनाओं की बोली लगाने में कार्यरत कोई अन्य कंपनी हो सकती है।

- 2.2 **घरेलू स्तर पर निर्मित लौह एवं इस्पात उत्पाद (डी एम आई एंड एस पी)** वे लौह एवं इस्पात उत्पाद हैं जिनका निर्माण उन प्रतिष्ठानों द्वारा किया जाता है जो भारत में पंजीकृत और स्थापित हैं, जिसमें विशेष आर्थिक क्षेत्र (एम ई ज़ेड) शामिल है। इसके अलावा, इस प्रकार के उत्पाद परिशिष्ट क में किये गये उल्लेख के अनुसार घरेलू न्यूनतम मूल्यवर्धन के मानदंडों को पूरा करेंगे।
- 2.3 **घरेलू निर्माता** खंड 7 में दिशा-निर्देशों और केंद्रीय उत्पाद शुल्क अधिनियम में दी गई 'निर्माता' की परिभाषा के अनुरूप लौह एवं इस्पात उत्पादों का एक निर्माता है।
- 2.4 इस नीति के प्रयोजन से **सरकार** का तात्पर्य भारत सरकार से है।
- 2.5 **सरकारी एजेंसियों** में सरकार के सार्वजनिक क्षेत्र के उपक्रम, सरकार द्वारा स्थापित सोसायटी, ट्रस्ट और सांविधिक निकाय शामिल हैं।
- 2.6 **एम ओ एस** का आशय इस्पात मंत्रालय, भारत सरकार से है।
- 2.7 **निवल बिक्री कीमत** बीजक कीमत होगी जिसमें निवल घरेलू कर और शुल्क शामिल नहीं होंगे।
- 2.8 **अर्ध तैयार इस्पात** का तात्पर्य इनगोट्स, बिलेट, ब्लूम और स्लेब्स से है, जिसे बाद में प्रसाधित कर तैयार इस्पात बनाया जा सकता है।
- 2.9 **तैयार इस्पात** का तात्पर्य सपाट और लंबे उत्पादों से होगा जिन्हें बाद में प्रसाधित कर निर्मित मद बनाया जा सकता है।
- 2.10 **एल1** का तात्पर्य निविदा अथवा अन्य खरीद संबंधी अनुरोध के अनुसार मूल्यांकन प्रक्रिया में यथाघोषित निविदा, बोली लगाने संबंधी प्रक्रिया अथवा अन्य खरीद संबंधी अनुरोधों में प्राप्त निम्नतम निविदा अथवा निम्नतम बोली अथवा निम्नतम भाव से होगा।
- 2.11 **खरीद वरीयता के मार्जिन** का तात्पर्य उस अधिकतम सीमा से है जिस सीमा तक किसी घरेलू आपूर्तिकर्ता द्वारा लगाई गई कीमत खरीद वरीयता के प्रयोजन से एल1 से अधिक हो। डी एम आई एंड एस पी नीति के मामले में, खरीद वरीयता का मार्जिन परिशिष्ट ख में मदों के लिए 20 प्रतिशत होगा।
- 2.12 **लौह एवं इस्पात उत्पाद** का तात्पर्य ऐसे लौह एवं इस्पात उत्पादों से होगा जिनका उल्लेख परिशिष्ट क में किया गया है।
- 2.13 **घरेलू मूल्यवर्धन** निवल बिक्री कीमत (निवल घरेलू करों और शुल्कों को छोड़कर बीजक कीमत) होगी जिससे प्रतिशत में निवल बिक्री कीमत के एक अनुपात के रूप में भारत में निर्माण संयंत्र (सभी सीमा शुल्कों सहित) में आयात की गई इनपुट सामग्री की पहुंच लागत घटाई गई हो, 'घरेलू मूल्यवर्धन' परिभाषा डी पी आई आई टी (पूर्व में डी आई पी पी) के दिशानिर्देशों के अनुरूप होगी और उसमें भविष्य में डी पी आई आई टी द्वारा परिवर्तन किये जाने की स्थिति में उपयुक्त रूप से संशोधन किया जाएगा। इस नीति दस्तावेज के प्रयोजन के लिए घरेलू मूल्यवर्धन और स्थानीय विषय वस्तु का उपयोग एक दूसरे के स्थान पर किया गया है।
- 3. अपवर्जन**
- 3.1 इस्पात मंत्रालय द्वारा इस प्रकार की सभी सरकारी खरीदों के लिये निम्नलिखित शर्तों के अधीन छूट प्रदान की जाएगी।
- 3.1.1 जहां विशिष्ट शेडों के इस्पात का निर्माण इस देश में नहीं किया जाता हो, अथवा
- 3.1.2 जहां परियोजना की मांग के अनुसार इन मात्राओं को घरेलू स्रोतों के माध्यम से पूरा नहीं किया जा सकता हो।
- अपवर्जन संबंधी अनुरोधों को घरेलू स्तर पर निर्मित लौह एवं इस्पात उत्पादों के उपलब्ध न होने के पर्याप्त प्रमाण के साथ स्थायी समिति को प्रस्तुत किया जाएगा।
- 4. स्थायी समिति**
- इस नीति के कार्यान्वयन का पर्यवेक्षण करने के लिए इस्पात मंत्रालय (एम ओ एस) के अधीन एक स्थायी समिति का गठन किया जाएगा। जिसके अध्यक्ष सचिव इस्पात होंगे। इस समिति में उद्योग/उद्योग संघ/सरकारी संस्था अथवा निकाय/इस्पात मंत्रालय (एम ओ एस) से लिए गए विशेषज्ञ होंगे। इस्पात मंत्रालय में उक्त समिति के पास निम्नलिखित के लिए अधिदेश होगा :
- 4.1 इस नीति के कार्यान्वयन की मॉनीटरिंग करना
- 4.2 परिशिष्ट क और परिशिष्ट ख में यथा उल्लिखित लौह एवं इस्पात उत्पादों की सूची और घरेलू बिक्री वर्धन की आवश्यकता से संबंधित मानदंडों की समीक्षा करना और उसे अधिसूचित।

- 4.3 खंड 3 के अनुसार खरीद एजेंसियों को अपवर्जन की स्वीकृति देने सहित इस नीति के कार्यान्वयन के लिए आवश्यक स्पष्टीकरण जारी करना।
- 4.4 शिक्कायत निवारण करने के लिए एक अलग समिति का गठन करना।
- 4.5 स्थायी समिति इस्पात मंत्रालय को अनुमोदन हेतु अपनी सिफारिशें प्रस्तुत करेगी।
- 5. सरकार द्वारा खरीदे जाने वाले लौह एवं इस्पात उत्पादों को अधिसूचित करना**
- 5.1 निम्नलिखित दिशानिर्देशों का उपयोग इस नीति के अंतर्गत उपरोक्त उत्पादों की पहचान करने और उमें अधिसूचित करने के लिए किया जा सकता है :
- 5.1.1 यह नीति परिशिष्ट क में दिए गए अनुसार लौह एवं इस्पात उत्पादों और परिशिष्ट ख में लौह एवं इस्पात उत्पादों का निर्माण करने के लिए पूंजीगत माल पर लागू है।
- 5.1.2 परिशिष्ट क में लौह एवं इस्पात उत्पादों की सूची दी गई है जिसका निर्माण अनन्य रूप से घरेलू स्तर पर किया जाना है और उसका आयात इस्पात मंत्रालय के अनुमोदन के बिना नहीं किया जा सकता है।
- 5.1.3 परिशिष्ट ख में पूंजीगत माल की एक सूची (जो विस्तृत नहीं है) दी गई है जिसके लिए खरीद संबंधी बरीयता घरेलू स्तर पर निर्मित पूंजीगत माल को दी जाएगी, यदि उनकी दी गई कीमत सदृश्य आयात किये गये पूंजीगत माल के लिए दी गई कीमत के 20 प्रतिशत के अंदर आती हो।
- 5.1.4 इस नीति का उद्देश्य सभी लौह एवं इस्पात उत्पादों को अधिसूचित करना है जिसकी खरीद सरकारी एजेंसियों द्वारा सरकारी परियोजनाओं के लिए की जाती है और न कि वाणिज्यिक पुनः बिक्री के उद्देश्य से अथवा वाणिज्यिक बिक्री के लिए उत्पादों के उत्पादन में प्रयोग करने के उद्देश्य से की गई हो।
- 5.1.5 यह नीति सरकार के मंत्रालय अथवा विभाग के द्वारा निधि प्रदत्त सभी परियोजनाओं और उनके प्रशासनिक नियंत्रण के अधीन सभी एजेंसियों/प्रतिष्ठानों पर लौह एवं इस्पात उत्पादों की खरीद के लिए लागू है।
- 5.1.6 यह नीति उन परियोजनाओं पर लागू होगी जहां लौह एवं इस्पात उत्पादों का खरीद मूल्य 25 करोड़ रुपए से अधिक होता हो। यह नीति अन्य खरीद (गैर परियोजना) के लिए भी लागू होगी जहां उस सरकारी संगठन के लिए लौह एवं इस्पात उत्पादों का वार्षिक खरीद मूल्य 25 करोड़ रुपए से अधिक होता हो।
- 5.1.7 यह नीति सरकार के मंत्रालय अथवा विभाग अथवा उनके सार्वजनिक क्षेत्र के उपक्रमों की किसी अन्य आवश्यकता को पूरा करने के लिए और/अथवा ई पी सी संविदा को पूरा करने के लिए प्राइवेट एजेंसियों द्वारा लौह एवं इस्पातों की खरीद पर लागू है।
- 5.1.8 घरेलू लौह एवं इस्पात उत्पादों के विभिन्न ग्रेडों की उपलब्धता का विश्लेषण इस नीति के अंतर्गत अधिसूचित करने से पहले करना होगा। केवल उन लौह एवं इस्पात को उत्पादों को जिनके संबंध में कम से कम एक घरेलू निर्माता मौजूद हो, अधिसूचित किया जाएगा। स्थायी समिति से परामर्श किया जा सकता है।
- 5.1.9 यह नीति यथा लागू निर्धारित गुणवत्ता मानदंडों के अनुपालन में उत्पादित परिशिष्ट ख में दिए गए लौह एवं इस्पात उत्पादों का निर्माण करने के लिए पूंजीगत माल के लिए लागू है।
- 5.1.10 लौह एवं इस्पात उत्पादों का निर्माण करने के लिए पूंजीगत मालों की घरेलू खरीद के लिए नीति लौह एवं इस्पात उत्पादों का निर्माण करने के लिए और न कि वाणिज्यिक पुनः बिक्री के उद्देश्य से पूंजीगत मालों की खरीद के वास्ते और सार्वजनिक क्षेत्र के इस्पात विनिर्माताओं और उनके प्रशासनिक नियंत्रणाधीन सभी एजेंसियों/प्रतिष्ठानों पर लागू है।
- 5.1.11 यह नीति ई पी सी संविदा और/अथवा सार्वजनिक क्षेत्र से इस्पात निर्माताओं और उनके प्रशासनिक नियंत्रण के अधीन सभी एजेंसियों/प्रतिष्ठानों की किसी अन्य आवश्यकता को पूरा करने के लिए निजी एजेंसियों द्वारा लौह एवं इस्पात उत्पादों का निर्माण करने के लिए पूंजीगत माल की खरीद पर लागू है।
- 5.1.12 सरकारी एजेंसियां जो लौह एवं इस्पात उत्पादों के निर्माण के लिए पूंजीगत माल और लौह एवं इस्पात उत्पादों की खरीद में उन स्थितियों में शामिल है जहां लौह एवं इस्पात उत्पादों का उल्लेख परिशिष्ट क और परिशिष्ट ख में नहीं किया गया हो, स्थायी समिति को निर्धारित मानदंडों के साथ इस उत्पाद के विवरण और तकनीकी विनिर्देशन उपलब्ध करायेगा। स्थायी समिति खंड 3 और खंड 4 में अधिदेश के अनुसार कार्य करेगी।

- 5.2 इस्पात मंत्रालय (एम ओ एम) परिशिष्ट क में दिए गए न्यूनतम निर्धारित घरेलू मूल्यवर्धन के साथ लौह एवं इस्पात उत्पादों को अधिसूचित करेगा।
- 5.3 लौह एवं इस्पात उत्पादों का निर्माण करने के लिए पूंजीगत माल के संबंध में नीतिगत दिशानिर्देश, परियोजना के आकार पर विचार किये बिना परिशिष्ट ख में लौह एवं इस्पात उत्पादों का निर्माण करने के लिए पूंजीगत माल की सभी खरीदों के लिए सार्वजनिक क्षेत्र के इस्पात निर्माताओं पर लागू होंगे।
- 5.4 परिशिष्ट क में लौह एवं इस्पात उत्पादों के लिए तथा परिशिष्ट ख में लौह एवं इस्पात उत्पादों का निर्माण करने के लिए पूंजीगत माल के लिए सुझाव दिए गए न्यूनतम घरेलू मूल्यवर्धन आवश्यकता घरेलू आपूर्तिकर्ता का आधार, आपूर्तिकर्ताओं की संख्या और खपत की तुलना में आयात का अनुपात जैसे कारकों के आधार पर तय किया गया है।
- 5.5 घरेलू मूल्यवर्धन आवश्यकता संबंधी मानदंडों का इस प्रकार से निर्धारण किया जाएगा जिस से कि यह किमी दिए गए समय में लौह एवं इस्पात उत्पादों के लिए घरेलू उद्योग की औसत/औसत से अधिक निर्माण क्षमता दर्शाता हो। स्थायी समिति द्वारा समय समय पर उपयुक्त रूप से इसकी समीक्षा की जाएगी और आवश्यकता पड़ने पर इस्पात मंत्रालय के अनुमोदन से इसमें संशोधन किया जाएगा।
- 6. सरकार एवं सरकारी एजेंसियों द्वारा खरीद के लिए निविदा प्रक्रिया**
- 6.1 खरीद करने वाली/सरकारी एजेंसियां डी एम आई एंड एस पी का पालन करते समय वित्त मंत्रालय और सी वी सी के अनुदेशों के अनुसार मानक खरीद संबंधी प्रक्रियाओं का पालन करेगी। यह नीति सभी निविदाओं जहां कीमत बोली नहीं खोली गई है, में इसके अधिसूचना की तिथि से लागू होगी।
- 6.2 दोनों वस्तुओं की खरीद तथा ई पी सी संविदाओं के लिए निविदा दस्तावेज में लौह एवं इस्पात उत्पादों का निर्माण करने के लिए लौह एवं इस्पात उत्पादों तथा पूंजीगत माल (जैसा कि परिशिष्ट क और परिशिष्ट ख में दर्शाया गया है, के लिए बोली लगाने वाले द्वारा न्यूनतम निर्धारित घरेलू मूल्यवर्धन का पालन करने के लिए अर्हता मानदंडों का स्पष्ट उल्लेख होना चाहिए।
- 6.3 घरेलू उत्पादों के विकास का सहयोग करने में, लौह एवं इस्पात व्यापार क्रियाकलापों में घरेलू मूल्यवर्धन का लक्ष्य निर्धारित किया गया है जिसे **परिशिष्ट क और परिशिष्ट ख** में दिया गया है।
- 6.4 परिशिष्ट क में लौह और इस्पात उत्पादों के खरीद की प्रक्रिया केवल उन निर्माताओं/आपूर्तिकर्ताओं के लिए ही खुली रहेगी जिसमें घरेलू मूल्यवर्धन लक्ष्यों को पूरा करने/उमसे ज्यादा पूरा करने की क्षमता हो। घरेलू मूल्यवर्धन लक्ष्यों को पूरा न करने वाले निर्माता/आपूर्तिकर्ता बोली लगाने में भाग लेने के लिए पात्र नहीं हैं।
- 6.5 परिशिष्ट ख में दी गई मदों के मामलों में, यदि खरीद करने वाली कंपनी की राय में, निविदाओं (खरीदी गई मात्रा) को 50:50 के निर्धारित अनुपात में नहीं बांटा जा सकता है, तब उनके पास मात्रा जो 50 प्रतिशत से कम नहीं हो, जो कि विभाज्य हो, के लिए पात्र घरेलू निर्माता को संविदा देने का अधिकार होगा।
- 6.6 उपर्युक्त शर्त को जारी रखते हुए, परिशिष्ट ख की मदों के लिए, यदि निविदा दी गई मद विभाज्य न हो (खरीद करने वाली कंपनी द्वारा निविदा दस्तावेज में शामिल किए जाने के लिए) यह संविदा समग्र मात्रा के लिए पात्र घरेलू निर्माता को दी जा सकती है।
- 6.7 परिशिष्ट ख के मदों के मामलों में, यदि घरेलू मूल्यवर्धन की आवश्यकताओं को पूरा करने वाले पात्र निर्माताओं में से कोई भी एल1 की बोली के अनुरूप न हो, तब एल1 की बोली धारण करने वाले मूल बोली लगाने वाला खरीद के पूर्ण मूल्य के लिए आदेश प्राप्त करेंगे।
- 6.8 वे बोली लगाने वाले जो लौह एवं इस्पात उत्पादों के घरेलू निर्माताओं के बिक्री एजेंट/अधिकृत वितरक/अधिकृत डीलर/अधिकृत आपूर्ति गृह हैं इस नीति के अंतर्गत घरेलू निर्माताओं की ओर से बोली लगाने के लिए पात्र हैं। हालांकि, यह निम्नलिखित शर्तों के अध्वधीन होगा।
- 6.8.1 बोली लगाने वाले घरेलू स्तर पर निर्मित लौह एवं इस्पात उत्पादों की बिक्री करने के लिए घरेलू निर्माता द्वारा जारी किए गए अधिकार प्रमाण पत्र प्रस्तुत करेगा।

- 6.8.2 यदि खरीद को डी एम आई एंड एम पी नीति के परिशिष्ट क के अंतर्गत शामिल किया गया हो तब बोली लगाने वाला यह घोषणा करते हुए खरीद करने वाली एजेंसी को घरेलू निर्माता द्वारा जारी किया गया स्व-प्रमाणन का शपथ पत्र प्रस्तुत करेगा कि लौह और इस्पात उत्पादों का घरेलू स्तर पर निर्माण निर्धारित घरेलू मूल्यवर्धन के मामले में किया जाता है।
- 6.8.3 यदि खरीद को डी एम आई एंड एम पी नीति के परिशिष्ट ख के अंतर्गत शामिल किया गया हो तब बोली लगाने वाला यह घोषणा करते हुए घरेलू निर्माता को सांविधिक लेखा परीक्षक द्वारा जारी किया गया प्रमाणन प्रस्तुत करेगा कि लौह और इस्पात उद्योग में उपयोग किये जाने वाले पूंजीगत माल का घरेलू स्तर पर निर्माण निर्धारित घरेलू मूल्यवर्धन के मामले में किया जाता है।
- 6.8.4 बोली लगाने वाले की यह जिम्मेदारी होगी कि वह इस नीति के अनुसार खरीद करने वाली एजेंसी को घरेलू निर्माता द्वारा जारी किये जाने के लिए अपेक्षित अन्य आवश्यक दस्तावेज प्रस्तुत करे।

7. घरेलू मूल्यवर्धन आवश्यकता

- 7.1 घरेलू रूप में निर्मित लौह और इस्पात उत्पाद अथवा पूंजीगत माल के रूप में उत्पाद के रूप में पात्र होने के लिए न्यूनतम घरेलू मूल्यवर्धन आवश्यकता का उल्लेख परिशिष्ट क और परिशिष्ट ख में किया गया है।
- 7.2 घरेलू मूल्यवर्धन निवल बिक्री कीमत (निवल घरेलू करों और शुल्कों को छोड़कर बीजक कीमत) होगी जिसमें से प्रतिशत में निवल बिक्री कीमत के एक अनुपात के रूप में भारत में निर्माण करने वाले संयंत्र में आयात की गई इनपुट सामग्री की पहुंच लागत (सभी सीमा शुल्कों को शामिल करते हुए) घटाई जाएगी।
- 7.2.1 यदि लौह और इस्पात उत्पादों को घरेलू इनपुट इस्पात (अर्ध तैयार/तैयार इस्पात) का उपयोग करके निर्माण किया जाता हो, तब खरीदी गई मात्रा और अन्य संबंधित दस्तावेजों के साथ वास्तविक घरेलू उत्पादों से खरीद का बीजक खरीद करने वाली सरकारी एजेंसी को अवश्य प्रस्तुत किया जाना चाहिए।
- 7.2.2 यदि लौह एवं इस्पात उत्पादों ने इनपुट इस्पात का आयात किया हो तब खरीदी गई मात्रा और अन्य संबंधित दस्तावेजों के साथ वास्तविक उत्पादकों से खरीदों के बीजकों को अलग से प्रस्तुत किया जाना चाहिए। घरेलू मूल्यवर्धन की सीमा निकालने के लिए, दोनों इनपुट इस्पातों (आयात किये और घरेलू) की भारित औसत पर विचार यह सुनिश्चित करने के लिए किया जाएगा कि इस नीति की न्यूनतम निर्धारित घरेलू मूल्यवर्धन आवश्यकता का पालन किया गया है।
- 7.3 यह सिफारिश की जाती है कि निविदा की प्रक्रिया में भाग लेने वाले प्रत्येक बोली लगाने वाले को नीचे दिए गए सूत्र का उपयोग करते हुए घरेलू मूल्यवर्धन की गणना करनी चाहिए ताकि यह सुनिश्चित किया जा सके कि दावा किये गये घरेलू मूल्यवर्धन इस नीति के न्यूनतम निर्धारित घरेलू मूल्यवर्धन के अनुरूप है।

लौह एवं इस्पात उत्पादों के लिए

% घरेलू मूल्यवर्धन

$$= \frac{\text{अंतिम उत्पाद की निवल बिक्री कीमत} - \text{संयंत्र में आयात किये गये लौह अथवा इस्पात की पहुंच लागत}}{\text{अंतिम उत्पाद की निवल बिक्री कीमत}} \times 100\%$$

पूंजीगत माल के लिए

% घरेलू मूल्यवर्धन

$$= \frac{\text{अंतिम उत्पाद की निवल बिक्री कीमत} - \text{संयंत्र में आयात किये गये इनपुट सामग्री की पहुंच लागत}}{\text{अंतिम उत्पाद की निवल बिक्री कीमत}} \times 100\%$$

8. प्रमाणन और लेखा परीक्षण

- 8.1 परिशिष्ट क में दिए गए उत्पादों के लिए, प्रत्येक घरेलू निर्माता यह घोषणा करते हुए खरीद करने वाली सरकारी एजेंसी को स्व-प्रमाणन का शपथ पत्र प्रस्तुत करेगा कि लौह एवं इस्पात उत्पाद का निर्धारित घरेलू मूल्यवर्धन के संबंध में घरेलू स्तर पर निर्माण किया गया है। परिशिष्ट ख के पूंजीगत माल के लिए, बोली लगाने वाला यह घोषणा करते हुए घरेलू निर्माता को सांविधिक लेखा परीक्षक द्वारा जारी किया गया प्रमाणन प्रस्तुत करेगा कि पूंजीगत माल का निर्माण घरेलू स्तर पर निर्धारित घरेलू मूल्यवर्धन के संबंध में किया गया है। वे बोली लगाने वाले जो लौह एवं इस्पात उत्पादों के घरेलू निर्माताओं का एकमात्र बिक्री एजेंट/अधिकृत वितरक/अधिकृत डीलर/अधिकृत आपूर्ति गृह हैं, ई पी सी के अंतर्गत घरेलू निर्माताओं की ओर से बोली लगाने के लिए पात्र हैं।

बोली लगाने वाला घरेलू निर्माताओं के द्वारा जारी किए गए स्व-प्रमाणन और सांविधिक लेखा परीक्षकों द्वारा जारी किये गये प्रमाणनों को यह घोषणा करते हुए खरीद करने वाली एजेंसी को प्रस्तुत करेगा कि लौह एवं इस्पात उत्पादों का घरेलू स्तर पर निर्माण निर्धारित घरेलू मूल्यवर्धन के संबंध में किया गया है। स्व-प्रमाणन का शपथ पत्र इन दिशानिर्देशों से संलग्न **प्रपत्र 1** में प्रस्तुत किया जाएगा।

- 8.2 घरेलू निर्माता की यह जिम्मेदारी होगी कि वह यह सुनिश्चित करे कि इस प्रकार से दावा किये गये उत्पादों का घरेलू स्तर पर उम उत्पाद के लिए निर्धारित घरेलू मूल्यवर्धन के संबंध में किया गया है। बोली लगाने वाले से यह भी अपेक्षित होगा कि वह घरेलू निर्माता के सांविधिक लेखा परीक्षकों द्वारा विधिवत प्रमाणित अर्धवार्षिक (मिंतंबर 30 और मार्च 31) आधार पर घरेलू मूल्यवर्धन प्रमाणपत्र उपलब्ध कराये कि पहले 6 महीनों के दौरान इस उत्पाद के लिए किये गये घरेलू मूल्यवर्धन के दावे इस नीति के अनुसार हैं। इस प्रकार के प्रमाण पत्र को संबंधित सरकारी एजेंसियों को प्रत्येक छमाही के शुरू होने के 60 दिनों के भीतर प्रस्तुत किया जाएगा और उस उत्पादों की आपूर्ति को पूरा करने तक प्रस्तुत करता रहेगा।
- 8.3 खरीद करने वाली एजेंसी बोली लगाने वाले द्वारा प्रस्तुत किये गये इस्पात उत्पाद में घरेलू मूल्यवर्धन के संबंध में स्व-प्रमाणन का शपथ पत्र स्वीकार करेगा। सामान्य तौर पर खरीद करने वाली एजेंसी की यह जिम्मेदारी होगी कि वह इस दावे की सत्यता की जांच करे। इसकी सत्यता प्रदर्शित करने की जिम्मेदारी बोली लगाने वाले की होगी जब उसे ऐसा करने के लिए कहा जाए।
- 8.4 यदि खरीद करने वाली एजेंसी अथवा संबंधित सरकारी एजेंसी द्वारा लौह एवं इस्पात उत्पादों में घरेलू मूल्यवर्धन के संबंध में बोली लगाने वाले के दावे के विरुद्ध कोई शिकायत प्राप्त होती है तब खरीद करने वाली एजेंसी के पास सभी संबंधित दस्तावेजों का निरीक्षण करने और उसकी जांच करने तथा निर्णय लेने का पूर्ण अधिकार होगा। यदि कोई स्पष्टीकरण की आवश्यकता होती है तब मामले को तकनीकी सहायता के लिए अनुरोध के साथ इस्पात मंत्रालय को भेजा जा सकता है।
- 8.5 सरकारी एजेंसी को भेजे गए किसी शिकायत का निपटारा सभी आवश्यक दस्तावेजों को प्रस्तुत करने के साथ इसे भेजे जाने के 4 सप्ताह के भीतर किया जाएगा। बोली लगाने वाले से यह अपेक्षित होगा कि वह शिकायत दायर करने के 2 सप्ताह के भीतर सरकारी एजेंसी को लौह एवं इस्पात उत्पादों में दावा किये गये घरेलू मूल्यवर्धन के समर्थन में आवश्यक दस्तावेज प्रस्तुत करे।
- 8.6 यदि इस मामले को इस्पात मंत्रालय के पास भेजा जाता है तब इस्पात मंत्रालय के अधीन गठित शिकायत निवारण समिति सरकारी एजेंसी के दृष्टिकोण पर विचार करने के बाद बोली लगाने वाले से सभी दस्तावेजों के प्राप्त होने और उसका संदर्भ भेजे जाने के 4 सप्ताह के भीतर शिकायत का निपटारा करेगी। बोली लगाने वाले से यह अपेक्षित होगा कि वे इस मामले के संदर्भ के 2 सप्ताह के भीतर इस्पात मंत्रालय के अंतर्गत शिकायत निवारण समिति को लौह एवं इस्पात उत्पादों में दावा किए गए घरेलू मूल्यवर्धन के समर्थन में आवश्यक दस्तावेज प्रस्तुत करे। यदि बोली लगाने वाले द्वारा कोई सूचना प्रस्तुत नहीं की जाती है तब शिकायत निवारण समिति दावे की प्रमाणिकता अधिक करने के लिए सरकारी एजेंसी के परामर्श से आगे आवश्यक कार्रवाई कर सकती है।
- 8.7 घरेलू मूल्यवर्धन की निर्धारित सीमा का आकलन करने की लागत का वहन खरीद करने वाली एजेंसी द्वारा किया जाएगा यदि घरेलू मूल्यवर्धन प्रमाण पत्र के अनुसार सही पाया गया हो। हालांकि, यदि ऐसा पाया गया हो कि दावा किए गए अनुसार घरेलू मूल्यवर्धन सही नहीं है तब आकलन की लागत बोली लगाने वाले द्वारा भुगतान के योग्य होगी जिन्होंने एक गलत प्रमाण पत्र प्रस्तुत किया है। इसे लागू करने के तरीके को निविदा दस्तावेज में परिभाषित किया जाएगा।

9. प्रतिबंध

- 9.1 प्रत्येक सरकारी एजेंसी निविदा दस्तावेज में निर्धारित घरेलू मूल्यवर्धन का बोली लगाने वाले के द्वारा गलत घोषणा किए जाने की स्थिति में दण्ड को स्पष्ट रूप से परिभाषित करेगा। इस दण्ड में ऐसे निर्माता/सेवा प्रदाता की ई एम डी को जब्त करना, अन्य वित्तीय दंड लगाना और उसे काली सूची में डालना शामिल हो सकता है।
- 9.2 संबंधित बोली लगाने वाले के द्वारा इस्पात मंत्रालय को किसी प्रकार की शिकायत भेजे जाने की स्थिति में, 10 लाख रुपए अथवा खरीदी जा रही डी एम आई एंड एस पी के मूल्य का 0.2 प्रतिशत (अधिकतम 20 लाख के अध्येधीन) इसमें से जो भी अधिक हो, का शिकायत शुल्क होगा जिसका भुगतान शिकायतकर्ता द्वारा शिकायत के साथ इस्पात मंत्रालय के अधीन शिकायत निवारण समिति के पास जमा किए गए डिमाण्ड ड्राफ्ट के द्वारा किया जाएगा। यदि, शिकायत को सही नहीं पाया जाता है तब सरकारी एजेंसी के पास उक्त राशि को जब्त करने का अधिकार सुरक्षित है। यदि शिकायत पर्याप्त रूप से सही पाई जाती है तब शिकायतकर्ता द्वारा जमा किए गए शुल्क को बिना किसी ब्याज के वापिस किया जाएगा।

10. इस्पात मंत्रालय द्वारा कार्यान्वयन की मॉनीटरिंग

- 10.1 इस नीति के प्रावधान प्रकाशन की तिथि से 5 वर्षों की अवधि के लिए लागू रहेंगे। इस नीति की अवधि को इस्पात मंत्रालय के विवेक से और आगे बढ़ाया जा सकता है।
- 10.2 इस्पात मंत्रालय इस नीति के कार्यान्वयन की मानीटरिंग करने के लिए नोडल मंत्रालय होगा।
- 10.3 डी एम आई एंड एम पी नीति के अंतर्गत सभी लागू एजेंसियां इस नीति का कार्यान्वयन मुनिश्चित करेंगी और वार्षिक रूप से जून के महीने में एक घोषणा भेजेगी जिसमें इस नीति के अनुपालन की सीमा और पिछले वित्तीय वर्ष के दौरान उसके अनुपालन न किए जाने के कारणों को दर्शाया जाएगा।

इस्पात मंत्रालय को संदर्भ

किमी ऐसे प्रश्न की स्थिति में कि क्या खरीदी जा रही मद इस नीति के अंतर्गत शामिल किए जाने वाले डी एम आई एंड एम पी है, इस मामले को स्पष्टीकरण के लिए इस्पात मंत्रालय के पास भेजा जाएगा।

परिशिष्ट क - धरेलू स्तर पर निर्मित उत्पादों के लिए अनन्य

क्र. सं.	लौह एवं इस्पात उत्पादों की सांकेतिक सूची	लागू एच एस कोड	न्यूनतम धरेलू मूल्यवर्धन आवश्यकता
1	600 मि. मी. अथवा उससे अधिक की चौड़ाई वाले लौह अथवा गैर एलॉय इस्पात का फ्लेट रोल उत्पाद, हॉट रोल, न ढका हुआ, प्लेट लगाया हुआ अथवा कोट किया हुआ	7208	50%
2	600 मि. मी. अथवा उससे अधिक की चौड़ाई वाले लौह अथवा गैर एलॉय इस्पात का फ्लेट रोल उत्पाद, कोल्ड रोल (कोल्ड - कम किया हुआ), न ढका हुआ, प्लेट लगाया हुआ अथवा कोट किया हुआ	7209	50%
3	600 मि. मी. अथवा उससे अधिक की चौड़ाई वाले लौह अथवा गैर एलॉय इस्पात का फ्लेट रोल उत्पाद, ढका हुआ, प्लेट लगाया हुआ अथवा कोट किया हुआ	7210	50%
4	600 मि. मी. से कम की चौड़ाई वाले लौह अथवा गैर एलॉय इस्पात का फ्लेट रोल उत्पाद, न ढका हुआ, प्लेट लगाया हुआ अथवा कोट किया हुआ	7211	35%
5	600 मि. मी. से कम की चौड़ाई का लौह अथवा गैर एलॉय इस्पात का फ्लेट रोल उत्पाद, ढका हुआ, प्लेट लगाया हुआ अथवा कोट किया हुआ	7212	35%
6	लौह एवं गैर एलॉय इस्पात का अनियमित रूप से षंठा हुआ क्वाडल में बार्स और रॉड, हॉट रोल	7213	35%
7	लौह अथवा गैर एलॉय इस्पात के अन्य बार्स और रॉड्स जिसे फोर्ज किए जाने की तुलना में आगे अधिक वर्क नहीं किया हुआ, हॉट रोल, हॉट ड्रॉन अथवा हॉट एक्सट्रूडेड परंतु रोलिंग के बाद उसे टिबिस्ट किये जाने सहित	7214	35%
8	लौह अथवा गैर एलॉय इस्पात का अन्य बार्स एंड रोड्स	7215	35%
9	लौह अथवा गैर एलॉय इस्पात का एंगल, शेप और सेक्शन	7216	35%
10	लौह अथवा गैर एलॉय इस्पात का तार	7217	50%
11	600 मि. मी. अथवा उससे अधिक की चौड़ाई का स्टेनलैस इस्पात का फ्लेट रोल इस्पात	7219	50%
12	600 मि. मी. से कम की चौड़ाई का स्टेनलैस इस्पात का फ्लेट रोल इस्पात	7220	50%
13	स्टेनलैस स्टील का अन्य बार्स और रोड्स; स्टेनलैस स्टील का एंगल शेप और सेक्शन	7222	50%
14	अन्य एलॉय इस्पात का तार	7229	35%
15	लौह अथवा इस्पात को रेल, रेलवे अथवा ट्रामवे ट्रेक निर्माण सामग्री	7302	50%

16	कास्ट लौह का ढूब, पाइप और होलो पाइप	7303	35%
17	लौह (कास्ट आयरन को छोड़कर) अथवा इस्पात का ढूब पाइप और होलो प्रोफाइल, मीमलैस	7304	35%
18	लौह अथवा इस्पात का सर्कुलर क्रॉस सेक्शन वाले अन्य ढूब और पाइप (उदाहरण के लिए, वेल्ड किया हुआ, रिबेट किया हुआ अथवा समान रूप से बंद किया गया हुआ), जिमकी बाहरी त्रिज्या 406.4 मि. मी. से अधिक हो	7305	35%
19	लौह अथवा इस्पात के अन्य ढूब, पाइप और होलो प्रोफाइल (उदाहरण के लिए ओपन मीन अथवा वेल्ड किया हुआ, रिबेट किया हुआ अथवा समान रूप से बंद किया गया हुआ)	7306	35%
20	लौह अथवा इस्पात का ढूब अथवा पाइप फिटिंग (उदाहरण के लिए, कनेक्टर/कप्लिंग, एल्बो स्लीव्स)	7307	35%
21	स्टेनलैस स्टील का अनियमित रूप से ँंठा हुआ क्वाइल में बार्स और रॉड, हॉट रोल्ड	7221	35%
22	स्टेनलैस स्टील का वायर	7223	35%
23	इलेक्ट्रिकल स्टील सहित 600 मि. मी. अथवा उससे अधिक की चौड़ाई वाले अन्य एलॉय स्टील का फ्लेट रोल्ड इस्पात	7225	35%
24	इलेक्ट्रिकल स्टील सहित 600 मि. मी. से कम की चौड़ाई वाले अन्य एलॉय स्टील का फ्लेट रोल्ड इस्पात	7226	35%
25	अन्य एलॉय स्टील का अनियमित रूप से ँंठा हुआ क्वाइल में बार्स और रोड, हॉट रोल्ड	7227	15%
26	अन्य एलॉय स्टील का अन्य बार्स और रोड्स; अन्य एलॉय स्टील का एंगल, शेप्स और सेक्शन्स; एलॉय अथवा नॉन एलॉय स्टील का होलो ड्रिल बार्स और रोड्स	7228	35%
27	लौह अथवा इस्पात की शीट पाइलिंग, चाहे ड्रिल किया हुआ हो अथवा नहीं, चाहे पंच किया हुआ हो अथवा नहीं, चाहे असेम्बल किये हुए तत्वों से बना हुआ हो अथवा नहीं; लौह अथवा इस्पात का वेल्ड किया हुआ एंगल, शेप और सेक्शन्स	7301	15%
28	स्ट्रक्चर्स (9406 के शीर्ष का प्रीफैब्रिकेटेड भवनों को छोड़कर) और स्ट्रक्चर्स का हिस्सा	7308	15%
29	300 लीटर से अधिक क्षमता का लौह अथवा इस्पात का किसी सामग्री (कम्प्रेस किए हुए अथवा सरलीकृत गैस को छोड़कर) के लिए भंडार, टैंक, वैट और समान कन्टेनर चाहे उसे लाइन किया गया हो अथवा नहीं या उसे हीट से इन्सुलेट किया गया हो अथवा नहीं लेकिन यांत्रिक अथवा तापीय उपक्रम से युक्त न हो	7309	15%
30	अधिकतम 300 लीटर की क्षमता का लौह अथवा इस्पात का किसी सामग्री (कम्प्रेस किए हुए अथवा सरलीकृत गैस को छोड़कर) के लिए टैंक, कास्ट, ड्रम, केन, बॉक्स और समान कन्टेनर चाहे उसे लाइन किया गया हो अथवा नहीं या उसे हीट से इन्सुलेट किया गया हो अथवा नहीं लेकिन यांत्रिक अथवा तापीय उपक्रम से युक्त न हो	7310	15%
31	लौह अथवा इस्पात का कम्प्रेस किया हुआ अथवा सरलीकृत गैस के लिए कन्टेनर	7311	15%
32	लौह अथवा इस्पात का स्टेंडिड वायर, रोप, केबल, प्लेटिड बैंड, स्लिंग और उसके समान वस्तु जिसे त्रिचूतीय रूप से इन्सुलेट न किया गया	7312	15%
33	लौह अथवा इस्पात का फेनसिंग के लिए उपयोग किये जाने वाला बार किया हुआ वायर; ट्रिवस्ट किया हुआ हूप अथवा सिंगल प्लेट वायर, बार्स किया हुआ अथवा नहीं और लूज तरीके से ट्रिवस्ट किया हुआ डबल वायर	7313	15%
34	लौह अथवा इस्पात तार का ड्रिल, नेटिंग और फेनसिंग; लौह अथवा इस्पात का विस्तार किया हुआ धातु	7314	15%

35	लौह अथवा इस्पात का चैन और उसका हिस्सा	7315	15%
36	लौह अथवा इस्पात का टैंकर, ग्रेपनेल्म और उसका हिस्सा	7316	15%
37	लौह एवं इस्पात की वस्तुएं	7317	15%
38	लौह एवं इस्पात की वस्तुएं	7318	15%
39	लौह एवं इस्पात की वस्तुएं	7319	15%
40	लौह अथवा इस्पात का स्प्रिंग और स्प्रिंग के लिए लीन्स	7320	15%
41	लौह अथवा इस्पात का स्टोव्स, रेंज, ग्रेड, कूकर (केंद्रीय हार्डिंग के लिए सहायक बायलरों के साथ उन वस्तुओं सहित), वारवेक्यूज, ब्रेजियर्स, गैस रिंग, प्लेट वामर्स और समान गैर-विद्युतीय घरेलू उपकरण और उसका हिस्सा	7321	15%
42	लौह अथवा इस्पात का केंद्रीय हार्डिंग के लिए रेडियेटर जिसे विद्युतीय रूप से हीट न किया गया हो और उसका हिस्सा; लौह अथवा इस्पात का हेयर हीटर और हॉट एयर वितरक जिसे विद्युतीय रूप से हीट न किया गया हो, फेन अथवा ब्लोअर जो मोटर से चलती हो और उसके हिस्से को शामिल करते हुए	7322	15%
43	लौह अथवा इस्पात का टेबल और समान घरेलू वस्तुएं और उसका हिस्सा	7323	15%
44	लौह अथवा इस्पात का सेनेटरी वेयर और उसको पार्ट्स	7324	15%
45	लौह अथवा इस्पात का अन्य कास्ट सामान	7325	15%
46	लौह अथवा इस्पात का विद्युतीय इस्पात और अन्य वस्तु	7326	15%
47	रेलवे अथवा ट्रामवे पेसेंजर कोच जो स्वयं आगे नहीं बढ़ता हो	8605	50%
48	रेलवे अथवा ट्रामवे माल वेन और वेगेन जो स्वयं आगे नहीं बढ़ता हो	8606	50%
49	रेलवे अथवा ट्रामवे लोकोमोटिव का हिस्सा अथवा रोलिंग स्टॉक जैसे बोगिज, बिसल बोगिज, एक्सेल और फोज्ड किया हुआ पहिया और उसका हिस्सा	8607	50%

विवरणों में शामिल किए गए उत्पाद सांकेतिक हैं, विनिर्दिष्ट एच एम कोड के अंतर्गत सभी उत्पादों को परिशिष्ट के भाग के रूप में शामिल किया गया है।

परिशिष्ट ख

लौह और इस्पात उत्पादों का निर्माण करने के लिए पूंजीगत माल की सांकेतिक सूची (जो विस्तृत नहीं है)

क्र. सं.	संयंत्र शॉप	पूंजीगत माल	न्यूनतम घरेलू मूल्यवर्धन आवश्यकता
1	कच्चा माल संभाल प्रणाली	चूर्ण की हुई सामग्री के लिए एप्रोन फीडर, बेरल कप्लिंग, हैवी ड्यूटी वियेरिंग, हाइड्रोलिक डिक्स ब्रेक्स, टैंकर एंड कंटेनर, पाइप कंवेयर के लिए कंवेयर बेल्ट, हार्ड एंगल कंवेयर प्रणाली, क्रशर्स, क्रेन रेल लुब्रिकेशन, चार गरडर ग्राइडर ई ओ टी क्रेन, क्रेन वेइंग प्रणाली, क्रेन एयर कंडीशनिंग, फ्यूड कप्लिंग, 4 लिफ्ट ट्रक्स, हाइड्रोलिक मोटर्स, हाइड्रोलिक सिस्टम, लॉकिंग एसेम्बली (फ्रिक्शन ग्रिप), लोड सेल्स, लेवल सेन्सर्स, पाइप कंवेयर प्रणाली, प्लग/पाडेल फीडर, न्यूमेटिक हुलाई - धना एवं लिन फेस, रिक्लेमर्स, रेडियो रिमोट कंट्रोल, रेल फिक्सिंग व्यवस्था (विशेष), रेपिड/फ्लेड लोडिंग प्रणाली, स्टेर्स, स्पेशल स्क्रीन, स्लिव रिंग वियेरिंग, ट्रिप्लर्स, ट्रांसफर कार, टॉर्स (स्पेशल), वाइब्रेशन, आइसोलेशन प्रणाली (स्प्रिंग डम्पर) वेगन टिप्लर्स, वेगन लोडर	50%
2	मिनिरल बेनिफिकेशन (लौह अयस्क और कोयला) उपकरण	इंडस्ट्रीयल क्रशर्स, ग्राइनिंग मिल, परम्परागत स्क्रीन, स्लूरी पम्पस, हिरेट थिकनर्स, फिल्टर्स, हाइड्रोक्लोन्स	50%

3	कॉक अवेन	कॉक ओवन मिलिका रिफेक्टरी, एन्क्रेज सिस्टम, ब्रंच तरडन के साथ वेस्ट गैस वाल, फ्लेस प्लेट, डोर फ्रेम, डोर बॉडी, माइनर कास्टिंग: गुजनेक, बाल बॉक्स, ए पी लिड, चार्जिंग और इन्स्पेक्शन होल लिड एंड फ्रेम रिचर्सिंग मंकेनिजम, केंद्रीकृत लूत्रिकेशन प्रणाली हाइड्रोजेट डोर क्लीनिंग तंत्र, कोड कंवेयर सिस्टम, स्क्रिप होइस्ट, डोर लोवरिंग रैक, आइसोलेशन/रिचर्सिंग कॉक्स, II ऑटोमेशन, अवेन मशीन	50%
4	उप-उत्पाद संयंत्र	प्राथमिक गैस कूलर, इलेक्ट्रोस्टैटिक तार प्रेसिपिटेटर, H ₂ S, NH ₃ और नपथलिन स्कूब्वर, कोम्बी स्ट्रीप्पर, फ्लेशिंग लिक्व पम्प, क्लास किन, क्लाक रियेक्टर, वेस्ट हीट बायलर, डिक्लेटर्स	50%
5	सिंटर संयंत्र उपकरण	पेलेट कार, ड्राइव/डिस्चार्ज इंड स्पोकेट एंसेम्बली कब्ड रेल, स्लाइड रेल, हॉट सिंटर ब्रेकर और गिजली, डिप रेल एंड रनिंग रेल, प्रोसेस फेन के लिए इम्पेलर एंसेम्बली, सिंटर मशीन का ड्राइव एंसेम्बली, उच्च तीव्रता वाला मिक्सर और नोडूलाइजर	50%
6	पेलेट संयंत्र उपकरण	पेलेट कार, ड्राइव/डिस्चार्ज इंड स्पोकेट एंसेम्बली कब्ड रेल, स्लाइड रेल, रनिंग रेल बरटिकल रोलर मिल, प्रोसेस फेन के लिए इम्पेलर एंसेम्बली, इनडूरेटिंग मशीन का ड्राइव एंसेम्बली, उच्च तीव्रता वाला मिक्सर, बालिंग डिक्स, सिंगल डेक्स रोलर स्क्रीन एंड डबल डेक्स रोलर स्क्रीन	50%
7	ब्लास्ट फरनेस उपकरण	ब्लेडर बाल के साथ बेल रहित टॉप प्रणाली, एस जी आयरन स्टेव कूलर, कोपर स्टेव कूलर, स्टॉक लेवल इंडिकेटर (रडार टाइप), मड गन, ड्रिलिंग मशीन एंड मेनिपुलेटर, गैस किल्लिंग प्लांट प्रणाली, इसके बाइस-पास वाल सहित टॉप रिक्वरी टूबाइन सिस्टम, डि-ब्रिक्किंग मशीन, रि-रेलिंग उपकरण, पी सी आई प्रणाली, पी सी आई के लिए ग्राइनिंग मिल, स्टॉक लेवल इंडिकेटर, टूयेरे स्टाक एंसेम्बली, वेस्ट हीट रिक्वरी प्रणाली, बी एफ एवं हॉट ब्लास्ट स्टोव प्रौद्योगिकीय वाल, एन्व ब्रंडन प्रोब्स, स्लग ग्रेन्यूलेशन यूनिट, टूयेरे एंड टूयेरे कूलर, टोरपेडो लेडल कार, बी एफ हरथ रिफेक्ट्री	50%
8	डायरेक्ट रिडक्शन प्लांट उपकरण	चार्ज डिस्चार्ज, अपर एंड लोअर सील लेग, रिफोमर एंड रि-क्यूरेटर सिस्टम, बर्डन फिडर्स, टूबो-एक्सपेंडर, प्रोसेस गैस कम्प्रेसर, सील गैस कम्प्रेसर एवं बोटम सील गैस कम्प्रेसर, सील गैस जेनरेटर एवं डायर्स, प्रोसेस गैस हीटर, CO ₂ रिमूवल प्लांट	50%
9	वेमिक ऑक्सीजन फर्नेस उपकरण	मुख्य और अनुरक्षण उपकरण जिसमें कंवेटर, गनिंग मशीन, रिफेक्ट्री/स्लग मॉनीटरिंग उपकरण, कंवेटर वेसेल, ट्रनिअन रिंग एंड सम्पेशन प्रणाली, ट्रनिअन बियरिंग और हाउसिंग, कंवेटर बुल गियर यूनिट और टिल्ट ड्राइव सिस्टम, कंवेटर के रोटेरी ज्वाइंट, बोटम स्ट्रिंग सिस्टम, क्लपिंग के साथ लांस बाडी, लांस कोपर टिप्स, ऑक्सीजन ब्लोबिंग/बोटम स्टीरिंग के लिए बाल स्टेशन, सब-लान सिस्टम, प्रोसेस मॉड्यूल अर्थात् प्रोसेस साफ्टवेयर/हार्डवेयर के साथ ऑफ गैस एनेलाइजर, कंटेनर लैब मेजरमेंट प्रोब, स्विच ओवर स्टेशन, प्राइमरी गैस के लिए आई डी फेन, हॉट मेटल और स्टील लेडल, लेडल ट्रांसफर कार, लेडल अनुरक्षण उपकरण, स्लेग पोट, स्लग पोट ट्रांसफर कार, स्क्रैप बॉक्स क्रेप ट्रांसफर कार, लांस करेज, लांस गाइड, क्रेन एंड हाइस्ट, लांस होइस्ट एंड ट्राली, लांस टिल्टिंग उपकरण, लांस को लिफ्ट करने के लिए ट्रेवस, विभिन्न आकर के बंकर, बिन बाइब्रेटर, वेइंग हूपर, अनुरक्षण स्टेण्ड, डी इस्टिंग सक्शन हूड, टीमिंग/एच एम, लेडल रिलाइनिंग स्टैंड, स्टैंड कूलिंग स्टेक इन्स्पेक्शन उपकरण, हूड ट्रेवर्स करेज, रिफेक्ट्री, बाइपास एवं आइसोलेशन वाल्व, फ्लेयर स्टेक एवं इगनिवेशन सिस्टम, स्क्रबिंग टोवर सेल - वेट गैस क्लीनिंग सिस्टम, डॉंग हाउस लेडल डायर, लेडल	50%

		प्री-हीटर, लेडल कूलर, फ्यूम कोलेक्शन हूड्स, क्लीन गैस स्टेक, इस्ट सिलो, वेग ब्रिज, स्लग रिट्रैनिंग उपकरण	
10	इलेक्ट्रिक आर्क फर्नेस	फर्नेस प्रोपर (जिसमें फर्नेस लोवर सेल, अपर सेल और रूफ, टिल्टिंग प्लेटफार्म, फर्नेस गेन्ट्री शामिल है) और ट्रांसफार्मर, इलेक्ट्रोड रेगुलेशन प्रणाली, हाइड्रोलिक सिस्टम, रिफैक्ट्री, लेवल I एंड II आटोमेशन सिस्टम के पार्ट्स। एल एफ - वाटर कूल्ड लेडल रूफ, इलेक्ट्रोड मास्ट एंड आमर्स, इलेक्ट्रोड रेगुलेशन सिस्टम, वायर फिडिंग सिस्टम, बोटम इनडरट गैस स्टिरिंग बाल सिस्टम पोरुस प्लग और टॉप लांस के लिए, इमरजेंसी लांसतंत्र, ड्राइव यूनिट के साथ लांस केरेजि सिस्टम, स्वचालित तापक्रम, सेम्पलिंग और बाथ लेबल/ओ2 मेजरमेंट, तापक्रम और आक्सीजन इम्मजन लांस, ड्राइव यूनिट के साथ लांस केरेज सिस्टम, हाइड्रोलिक सिस्टम, रिफैक्ट्री, लेडल रूफ डेल्टा पोरशन, आर एच प्रोपर (जिसमें लेडल ट्रांसफर कार, बेक्यूम वेमेल, वेमेल लिफ्टिंग और लोवरिंग सिस्टम शामिल है, हाइड्रोलिंग सिस्टम, मल्टी फंक्शन लांस, वाल्व रेक्स/स्टेशन, इलेक्ट्रोड क्लेप यूनिट, इलेक्ट्रोड आमर्स का कंडक्टर, वाटर कूल्ड केबल, ए आर स्टेरिंग वाल्व रेक, लांस ट्रांसपोर्ट कार, रिफैक्ट्री लांस, हाइड्रोलिक सिलेंडर, लेडल रूफ लिफ्टिंग सिलेंडर, लूत्रिकेशन प्रणाली, सक्शन हूड, डम्पर, वाइब्रो फीडर, वेडंग होपर, वायर फिडिंग प्रणाली, इलेक्ट्रोड निपिलिंग स्टेड, क्रेन, होइस्ट, तापमान और सेम्पलिंग टिप्स, लेडल स्टैंड, ई एस पी, डिडिक्टिंग हूड, रिफैक्ट्री, वेग फिल्टर, क्रेन इत्यादि।	50%
11	सतत कास्टिंग उपकरण	लाइले टरेट, लेडल कवर मेनिपुलेटर, लेडल शारउड मेनिपुलेटर, टनडिस कार, कंटिन्यूअस टनडिस टेम्पेचर मेजरमेंट सिस्टम, टनडिस स्टोपर रूड मेकेनिजम, इमरजेंसी कट-आफ गेट, मोल्ड एसेम्बली, नोजल क्लिक चेंज डिवाइस, मोल्ड ओसीलेटर एंड ई एम एस सिस्टम, इलेक्ट्रो-मेगेनेटिक ब्रेकिंग सिस्टम, स्ट्रेड गाइड सेगमेंट, विदड्रावल एंड स्ट्रेघटेनिंग यूनिट (डब्ल्यू एस यू), रोल गेप चेकर इमरजेंसी टार्च कटर, टार्च कटिंग मशीन, डेबरर, मार्किंग मशीन, टेकेनोलोजी कंट्रोल सिस्टम एंड प्रोसेस मोडल, ब्लेक रिफैक्ट्रीज, स्ट्रेड गन्डे सेगमेंट, टनडिश, लाइले कवर, रोलर टेबल एंड आक्सीलिरीज, माल्ड एंड सेगमेंट मेनटेनेस इक्यूपमेंट टनडिस मेनटेनेस इक्यूपमेंट, ई एम बी आर सिस्टम	50%
12	प्लेट मिल	लार्ज कास्टिंग एंड फाजिग लाइक मिल हाउसिंग, बेड प्लेट्स वर्क्स रोल, बेकअप रोल, इंड स्पिडल्स; रोलर टेबल, बेकअप रोल एंड वर्क रोल चक्स क्वाडलर/टेशन रिल/अनक्वाइलर, ए जी सी सिलेंडर, शेयर्स, लेवेलेर्स, लाजेर वेल्डर, पेकेजिंग मशीन, नॉन कान्टेक्ट, गेज/प्रोफाइल गेज, एंटी-फ्रिक्शन रोल नेक बियरिंग, आयल फिल्म बियरिंग, गियर बॉक्स, मिल मोटर्स	50%
13	लॉग मिल	मिलम हाउसिंग, बेड प्लेट, वर्क रोल, बेकअप रोल, स्पिनडेल्स; रोलर टेबल, कॉयलर /टेशन रिल /अनकॉयलर, शेयर्स, बिल्डट वेल्डर, पेकेजिंग मशीन, नान-कान्टेक्ट गॉज/प्रोफाइल गॉज, एंटी-फ्रिक्शन रोल नेक बियरिंग, आयल फिल्म बियरिंग, फिनिशिंग ब्लाक्स, गियर बॉक्स, मिल मोटर	50%

* परिशिष्ट ख में मर्दाने निर्माण करने वाले इस्पात के लिए पूंजीगत सामानों की एक सांकेतिक सूची है। यह सूची विस्तृत नहीं है। इस्पात के निर्माण के लिए सभी पूंजीगत मालों पर 50% की न्यूनतम घरेलू मूल्यवर्धन आवश्यकता के साथ इस नीति के अंतर्गत खरीद बरीयता के लिए विचार किया जाएगा।

फार्म - 1

100/- रुपए के स्टाम्प पेपर पर दिए जाने के लिए लौह एवं इस्पात उत्पादों/पूँजीगत मालों में घरेलू मूल्यवर्धन के संबंध में स्व-प्रमाणन शपथ के लिए प्रपत्र :

मैं _____ सुपुत्र, सुपुत्री, पत्नी, _____ का निवासी _____
एतद् द्वारा निष्ठापूर्वक नीचे दिए गए अनुसार वचन देता हूँ और घोषण करता हूँ :

कि मैं अधिसूचना सं. : _____ के माध्यम से जारी किए गए भारत सरकार की नीति के नियम और शर्तों का पालन करने के लिए सहमत होऊंगा।

कि यहां नीचे दी गई सूचना मेरे सर्वोत्तम ज्ञान और विश्वास के अनुसार सही है और मैं घरेलू मूल्यवर्धन का आकलन करने के प्रयोजन से खरीद करने वाली एजेंसी के समक्ष संगत रिकार्ड प्रस्तुत करने का वचन देता हूँ।

कि सभी इनपुट्स के लिए घरेलू मूल्यवर्धन जिसमें उक्त लौह एवं इस्पात उत्पाद शामिल हैं का सत्यापन मेरे द्वारा कर लिया गया है और मैं उसमें किये गये दावों की सत्यता के लिए जिम्मेदार हूँ।

कि इसमें उल्लिखित उत्पाद घरेलू मूल्यवर्धन सही नहीं पाये जाने और मूल्यवर्धन के लिए निर्धारित मानदंडों को पूरा नहीं किये जाने की स्थिति में, घरेलू मूल्यवर्धन का आकलन करने के उद्देश्य से खरीद करने वाली एजेंसी के आकलन के आधार पर मैं 36 महीनों की अवधि के लिए किसी सरकारी निविदा से अयोग्य ठहराया जाऊंगा। इसके अलावा मैं इस प्रकार के आकलन की सभी लागतों का वहन करूंगा।

कि मैंने अधिसूचना संख्या _____ जिसमें सरकारी खरीद में घरेलू स्तर पर निर्मित लौह एवं इस्पात उत्पादों को बरीयता दी गई है, में संदर्भित सभी शर्तों का पालन किया है और यह कि खरीद करने वाली एजेंसी को एतद् द्वारा अधिकार दिया जाता है कि वह मेरे ई एम डी को जप्त करे। मैं यह भी वचन देता हूँ कि आकलन की लागत का भुगतान करूंगा और निविदा दस्तावेज में यथा उल्लिखित सभी दण्ड राशि का भुगतान करूंगा।

मैं 8 वर्षों की अवधि के लिए कम्पनी के रिकॉर्ड में निम्नलिखित सूचना रखने के लिए सहमत हूँ और किसी सांविधिक प्राधिकारी को सत्यापन के लिए इसे उपलब्ध कराऊंगा।

- i. बोली लगाने वाले का नाम और ब्यौरा (पंजीकृत कार्यालय, विनिर्माण इकाई का स्थान, कानूनी प्रतिष्ठान की प्रकृति)
- ii. वह तिथि जब यह प्रमाण पत्र जारी किया गया है।
- iii. लौह एवं इस्पात उत्पाद जिसके लिए इस प्रमाण पत्र को प्रस्तुत किया जाता है।
- iv. खरीद करने वाली एजेंसी जिसे यह प्रमाण पत्र प्रस्तुत किया जाता है।
- v. दावा की गई घरेलू मूल्यवर्धन की प्रतिशतता और क्या यह निर्धारित घरेलू मूल्यवर्धन के आरंभिक मूल्य को पूरा करता है।
- vi. विनिर्माता की इकाई का नाम और संपर्क विवरण
- vii. लौह और इस्पात उत्पादों की निवल बिक्री कीमत
- viii. संयंत्र तक भाड़ा, बीमा और रखरखाव
- ix. लौह एवं इस्पात उत्पादों का निर्माण करने के लिए उपयोग की जाने वाली इनपुट इस्पात (आयात किया गया) की सूची और कुल लागत मूल्य।
- x. इनपुट इस्पात जिसकी आपूर्ति घरेलू स्तर पर की जाती है की सूची और कुल लागत
- xi. कृपया यदि इनपुट इन हाऊस नहीं हो तब आपूर्तिकर्ताओं से प्राप्त घरेलू मूल्यवर्धन प्रमाणपत्र संलग्न करें।
- xii. आयात किये गये इनपुट इस्पात के लिए, सी आई एफ मूल्य, शुल्क और करों, पोर्ट पर उतारने से संबंधित प्रभारों और अंतर्देशीय भाड़े की लागत के ब्यौरे के साथ भारतीय पोर्ट पर पहुंच कीमत।

(प्रतिष्ठान/कंपनी का नाम) के लिए और उसकी ओर से

अधिकृत हस्ताक्षरकर्ता (निदेशक बोर्ड द्वारा विधिवत अधिकृत किये जाने के लिए)

<नाम, पदनाम और संपर्क सं. की प्रविष्टि करें>

MINISTRY OF STEEL

NOTIFICATION

New Delhi, the 29th May, 2019

G.S.R. 385(E).—The revised Policy for providing preference to domestically manufactured Iron & Steel Products in Government procurement is hereby published for general information.

[F. No.3(2)/2018-IDD]

RASIKA CHAUBE, Addl. Secy.

POLICY FOR PROVIDING PREFERENCE TO DOMESTICALLY MANUFACTURED IRON & STEEL PRODUCTS IN GOVERNMENT PROCUREMENT- REVISED, 2019**1 Background**

- 1.1 This policy provides preference to Domestically Manufactured Iron and Steel Products (DMI&SP) in Government procurement.
- 1.2 The policy is applicable to iron & steel products as provided in Appendix A and capital goods for manufacturing iron & steel products in Appendix B, produced in compliance to prescribed quality standards, as applicable.
- 1.3 The policy is applicable to every Ministry or Department of Government and all agencies/entities under their administrative control and to projects funded by these agencies for purchase of iron & steel products for government projects. However, this policy shall not apply for purchase of iron & steel products with a view to commercial resale or with a view to use in the production of goods for commercial sale.

2 Definitions

- 2.1 **Bidder** may be a domestic/ foreign manufacturer of iron & steel or their selling agents/ authorized distributors/ authorized dealers/ authorized supply houses or any other company engaged in the bidding of projects funded by Government agencies.
- 2.2 **Domestically Manufactured Iron & Steel Products (DMI&SP)** are those iron and steel products which are manufactured by entities that are registered and established in India, including in Special Economic Zones (SEZs). In addition, such products shall meet the criteria of domestic minimum value-addition as mentioned in Appendix A.
- 2.3 **Domestic Manufacturer** is a manufacturer of iron & steel products conforming to guidelines in section 7 and confirming to the definition of 'manufacturer' as per Central Excise Act.
- 2.4 **Government** for the purpose of the Policy means Government of India.
- 2.5 **Government agencies** include Government PSUs, Societies, Trusts and Statutory bodies set up by the Government.
- 2.6 **MoS** shall mean Ministry of Steel, Government of India.
- 2.7 **Net Selling Price** shall be the invoiced price excluding net domestic taxes and duties
- 2.8 **Semi-Finished Steel** shall mean Ingots, billet, blooms and slabs, which can be subsequently processed to finished steel.
- 2.9 **Finished Steel** shall mean Flat and Long products, which can be subsequently processed into manufactured items.
- 2.10 **L1** means the lowest tender or the lowest bid or the lowest quotation received in a tender, bidding process or other procurement solicitation as adjudged in the evaluation process as per the tender or other procurement solicitation.
- 2.11 **Margin of purchase preference** means the maximum extent to which the price quoted by a domestic supplier may be above L1 for the purpose of purchase preference. In case of DMI&SP policy, the margin of purchase preference shall be 20% for items in Appendix B.
- 2.12 **Iron & Steel Product(s)** shall mean such iron and steel product(s) which are mentioned in Appendix A.
- 2.13 **Domestic value addition** shall be the net selling price (invoiced price excluding net domestic taxes and duties) minus the landed cost of imported input materials at the manufacturing plant in India (including all customs duties) as a proportion of the net selling price, in percent. The 'domestic value addition' definition shall be in line with the DPIIT (formerly DIPP) guidelines, and shall be suitably amended in case of any changes by DPIIT in the future. For the purpose of this policy document, domestic value addition and local content have been used interchangeably.

3 Exclusions

3.1 Waivers shall be granted by the Ministry of Steel to all such Government procurements subject to the below conditions.

3.1.1 Where specific grades of steel are not manufactured in the country, or

3.1.2 Where the quantities as per the demand of the project cannot be met through domestic sources

The exclusion requests shall be submitted to the Standing Committee along with sufficient proof of unavailability of domestically manufactured iron & steel products

4 Standing Committee

A Standing Committee under the Ministry of Steel (MoS) to be chaired by the Secretary (Steel), shall be constituted to oversee the implementation of the policy. The Committee shall comprise of experts drawn from Industry / Industry Association / Government Institution or Body / Ministry of Steel (MoS). The said Committee in MoS shall have the mandate for the following:

4.1 Monitoring the implementation of the policy

4.2 Review and notify the list of Iron & Steel products and the domestic value addition requirement criteria as mentioned at Appendix A and Appendix B.

4.3 Issue necessary clarifications for implementation of the policy including grant of exclusions to procuring agencies as per section 3

4.4 Constitute a separate committee to carry out grievance redressal

4.5 The Standing Committee shall submit its recommendations for approval to Ministry of Steel.

5 Notifying Iron & Steel Products Procured by Government

5.1 The following guidelines may be used for identifying and notifying the aforementioned products under the policy:

5.1.1 The policy is applicable to iron & steel products as provided in Appendix A and to capital goods for manufacturing iron & steel products in Appendix B.

5.1.2 Appendix A contains list of iron & steel products which are to be exclusively domestically manufactured and cannot be imported without the approval of the Ministry of Steel

5.1.3 Appendix B contains a list (non-exhaustive) of capital goods for which purchase preference shall be provided to domestically manufactured capital goods, if their quoted price falls within 20% of the price quoted for corresponding imported capital good.

5.1.4 The objective of the policy is to notify all iron & steel products which are procured by Government Agencies for government projects and not with a view to commercial resale or with a view to use in the production of products for commercial sale.

5.1.5 The policy is applicable to all projects funded by Ministry or Department of Government and all agencies/entities under their administrative control for purchase of iron & steel products.

5.1.6 The policy shall be applicable to projects where the procurement value of iron and steel products is greater than Rs. 25 crores. The policy shall also be applicable for other procurement (non-project), where annual procurement value of iron and steel products for that Government organization is greater than Rs. 25 crores.

5.1.7 The policy is applicable to purchase of iron & steel products by private agencies for fulfilling an EPC contract and/or any other requirement of Ministry or Department of Government or their PSUs.

5.1.8 Analysis of the availability of various grades of domestic iron and steel products needs to precede for notification under the policy. Only those iron & steel products, in respect of which at least one domestic manufacturer exists, shall be notified. Consultation may be carried out by the Standing Committee.

5.1.9 The policy is applicable to capital goods for manufacturing iron & steel products in Appendix B produced in compliance to prescribed quality standards, as applicable.

5.1.10 Policy for domestic procurement of capital goods for manufacturing iron and steel products is applicable to all public sector steel manufacturers and all agencies/entities under their administrative control for purchase of capital goods for manufacturing iron & steel products, not with a view to commercial resale.

5.1.11 The policy is applicable to purchase of capital goods for manufacturing iron & steel products by private agencies for fulfilling an EPC contract and/or any other requirement of public sector steel manufacturers and all agencies/entities under their administrative control

- 5.1.12 Government agencies which are involved in procurement of iron and steel products, and capital goods for manufacturing of iron and steel products, in cases where the iron and steel products are not mentioned in Appendix A and Appendix B, shall provide description and technical specifications of the product along with prescribed standards to the Standing Committee. The Standing Committee will act as per mandate in section 3 and section 4.
- 5.2 The Ministry of Steel (MoS) would notify iron & steel products along with the minimum prescribed domestic value addition, furnished at Appendix A.
- 5.3 The policy guidelines on capital goods for manufacturing iron & steel products shall be applicable to public sector steel manufacturers for all purchases of capital goods for manufacturing iron & steel products in Appendix B, irrespective of the project size.
- 5.4 Minimum domestic value addition requirement suggested for iron and steel products in Appendix A, and for capital goods for manufacturing iron and steel products in Appendix B have been decided on the basis of factors such as domestic supplier base, number of suppliers and import to consumption ratio.
- 5.5 The domestic value addition requirement norm shall be so calibrated that it reflects the average/above average manufacturing capability of the domestic industry for the iron & steel products at a point of time. This shall be suitably reviewed by the Standing Committee from time to time and amended, if required with the approval of Ministry of Steel.

6 Tender procedure for procurement by government and government agencies

- 6.1 The procuring/ Government agencies shall follow standard procurement procedures, in accordance with instructions of Ministry of Finance and CVC while adhering to DMI&SP. The policy shall come into effect from the date of its notification in all tenders where price bid have not been opened.
- 6.2 The tender document, for procurement of both Goods as well as for EPC contracts, should explicitly outline the qualification criteria for adherence to minimum prescribed domestic value addition by the bidder for iron and steel products and capital goods for manufacturing iron & steel products(as indicated in Appendix A and Appendix B)
- 6.3 In supporting the growth of domestic products, the target of domestic value addition in iron and steel business activities has been set as contained in **Appendix A and Appendix B**.
- 6.4 For iron and steel products in Appendix A, the procurement process shall be open only to the manufacturers / suppliers having the capability of meeting / exceeding the domestic value addition targets. Manufacturers / suppliers not meeting the domestic value addition targets are not eligible to participate in the bidding.
- 6.5 In case of Appendix B items, if in the opinion of the procuring company, the tenders (procured quantity) cannot be divided in the prescribed ratio of 50:50, then they shall have the right to award contract to the eligible domestic manufacturer for quantity not less than 50%, as may be divisible.
- 6.6 In continuation to the above clause, for Appendix B items, if the tendered item is non divisible, (to be included in the tender document by procuring company) the contract can be awarded to the eligible domestic manufacturer for the entire quantity.
- 6.7 In case of Appendix B items, if none of the eligible manufacturers meeting domestic value addition requirements match the L1 bid, the original bidder holding L1 bid shall secure the order for full value of procurement.
- 6.8 The bidders who are selling agents/ authorized distributors/ authorized dealers/ authorized supply houses of the domestic manufacturers of iron & steel products are eligible to bid on behalf of the domestic manufacturers under the policy. However, this shall be subject to the following conditions:
- 6.8.1 The bidder shall furnish the authorization certificate issued by the domestic manufacturer for selling domestically manufactured iron & steel products.
- 6.8.2 In case the procurement is covered under Appendix A of the DMI&SP policy, the bidder shall furnish the Affidavit of self-certification issued by the domestic manufacturer to the procuring agency declaring that the iron & steel products is domestically manufactured in terms of the domestic value addition prescribed.
- 6.8.3 In case the procurement is covered under Appendix B of the DMI&SP policy, the bidder shall furnish the certification issued by the statutory auditor to domestic manufacturer declaring that the capital goods to be used in Iron & Steel industry are domestically manufactured in terms of the domestic value addition prescribed.
- 6.8.4 It shall be the responsibility of the bidder to furnish other requisite documents required to be issued by the domestic manufacturer to the procuring agency as per the policy.

7 Domestic value addition requirement

- 7.1 Minimum domestic value addition requirement to qualify the product as a domestically manufactured iron & steel product or a Capital good are mentioned in Appendix A and B.
- 7.2 Domestic value addition shall be the net selling price (invoiced price excluding net domestic taxes and duties) minus the landed cost of imported input materials at the manufacturing plant in India (including all customs duties) as a proportion of the net selling price, in per cent.
- 7.2.1 In case the iron & steel products are made using domestic input steel (semi-finished/ finished steel), invoices of purchases from the actual domestic producers along with quantities purchased and the other related documents must be furnished to the procuring Government agency.
- 7.2.2 In case the iron & steel products have imported input steel, the invoices of purchases from the actual producers along with quantities purchased and the other related documents must be furnished separately. To derive the extent of domestic value addition, the weighted average of both (imported & domestic) input steel shall be considered to ensure that the minimum stipulated domestic value addition requirement of the policy is complied with.
- 7.3 It is recommended that each bidder participating in the tender process should calculate the domestic value addition using the below formula below so as to ensure the domestic value addition claimed is consistent with the minimum stipulated domestic value addition requirement of the policy.

For Iron and Steel products

% Domestic value addition

$$= \frac{\text{Net selling price of final product} - \text{Landed cost of imported iron or steel at plant}}{\text{Net selling price of final product}} \times 100\%$$

For Capital Goods

% Domestic value addition

$$= \frac{\text{Net selling price of final product} - \text{Landed cost of imported input materials at plant}}{\text{Net selling price of final product}} \times 100\%$$

8 Certification and audit

- 8.1 For products in Appendix A, each domestic manufacturer shall furnish the Affidavit of self-certification to the procuring Government agency declaring that the iron & steel products are domestically manufactured in terms of the domestic value addition prescribed. For capital goods in Appendix B, the bidder shall furnish the certification issued by the statutory auditor to the domestic manufacturer declaring that the capital goods are domestically manufactured in terms of the domestic value addition prescribed. The bidders who are sole selling agents / authorized distributors / authorized dealers / authorized supply houses of the domestic manufacturers of iron & steel products are eligible to bid on behalf of domestic manufacturers under the policy. The bidder shall furnish the Affidavits of self-certification issued by the domestic manufacturers and the certifications issued by the statutory auditors, to the procuring agency declaring that the iron & steel products are domestically manufactured in terms of the domestic value addition prescribed. The Affidavit of self-certification shall be furnished in **Form I** attached to these guidelines.
- 8.2 It shall be the responsibility of the domestic manufacturer to ensure that the products so claimed are domestically manufactured in terms of the domestic value addition prescribed for the product. The bidder shall also be required to provide a domestic value addition certificate on half-yearly basis (Sep 30 and Mar 31), duly certified by the Statutory Auditors of the domestic manufacturer, that the claims of domestic value addition made for the product during the preceding 6 months are in accordance with the Policy. Such certificate shall be filed within 60 days of commencement of each half year, to the concerned Government agencies and shall continue to be filed till the completion of supply of the said products.
- 8.3 The procuring agency shall accept the Affidavit of self-certification regarding domestic value addition in a steel product submitted by a bidder. It shall not normally be the responsibility of procuring agency to verify the correctness of the claim. The onus of demonstrating the correctness of the same shall be on the bidder when asked to do so.
- 8.4 In case a complaint is received by the procuring agency or the concerned Government Agency against the claim

of a bidder regarding domestic value addition in iron & steel products, the procuring agency shall have full rights to inspect and examine all the related documents and take a decision. In case any clarification is needed, matter may be referred to MoS with a request for technical assistance.

- 8.5 Any complaint referred to the Government Agency shall be disposed off within 4 weeks of the reference along with submission of all necessary documents. The bidder shall be required to furnish the necessary documentation in support of the domestic value addition claimed in iron & steel products to the Government Agency within 2 weeks of filing the complaint.
- 8.6 In case, the matter is referred to the Ministry of Steel, the grievance redressal committee setup under the MoS shall dispose of the complaint within 4 weeks of its reference and receipt of all documents from the bidder after taking in consideration, the view of the Government Agency. The bidder shall be required to furnish the necessary documentation in support of domestic value addition claimed in iron & steel products to the grievance redressal committee under MoS within 2 weeks of the reference of the matter. If no information is furnished by the bidder, the grievance redressal committee may take further necessary action, in consultation with Government Agency to establish bonafides of claim.
- 8.7 The cost of assessing the prescribed extent of domestic value addition shall be borne by the procuring agency if the domestic value addition is found to be correct as per the certificate. However, if it is found that the domestic value addition as claimed is incorrect, the cost of assessment will be payable by the bidder who has furnished an incorrect certificate. The manner of enforcing the same shall be defined in the tender document.

9 Sanctions

- 9.1 Each Government Agency shall clearly define the penalties, in case of wrong declaration by the bidder of the prescribed domestic value addition, in the tender document. The penalties may include forfeiting of the EMD, other financial penalties and blacklisting of such manufacturer/ service provider.
- 9.2 In case of reference of any complaint to MoS by the concerned bidder, there would be a complaint fee of Rs. 10 Lakh or 0.2 % of the value of the DMI&SP being procured (subject to a maximum of Rs. 20 Lakh), whichever is higher, to be paid by Demand Draft deposited with the grievance redressal committee under MoS along with the complaint by the complainant. In case, the complaint is found to be incorrect, the Government Agency reserves the right to forfeit the said amount. In case, the complaint is found to be substantially correct, deposited fee of the complainant would be refunded without any interest.

10 Implementation monitoring by Ministry of Steel

- 10.1 The policy provisions shall be applicable for a period of 5 years from the date of publication. The policy period may further be extended at the discretion of Ministry of Steel.
- 10.2 MoS shall be the nodal ministry to monitor the implementation of the policy.
- 10.3 All applicable agencies under DMI&SP policy shall ensure implementation of the policy and shall annually, in the month of June, send a declaration indicating the extent of compliance to the policy and reasons for noncompliance thereof, during the preceding financial year.

Reference to Ministry of Steel

In case of a question whether an item being procured is a DMI&SP to be covered under the policy, the matter would be referred to the Ministry of Steel for clarification.

Appendix A - Exclusive for domestically manufactured products

Sl. No.	Indicative list of Iron & Steel Products	Applicable HS code	Minimum domestic value addition requirement
1	Flat-rolled products of iron or non alloy steel, of a width of 600 mm or more, hot rolled, not clad, plated or coated	7208	50%
2	Flat-rolled products of iron or non alloy steel, of a width of 600 mm or more, cold rolled (cold-reduced), not clad, plated or coated	7209	50%
3	Flat-rolled products of iron or non alloy steel, of a width of 600 mm or more, clad, plated or coated	7210	50%

4	Flat-rolled products of iron or non alloy steel, of a width of less than 600 mm, not clad, plated or coated	7211	35%
5	Flat-rolled products of iron or non alloy steel, of a width of less than 600 mm, clad, plated or coated	7212	35%
6	Bars and rods, hot-rolled, in irregularly wound coils, of iron or non-alloy steel	7213	35%
7	Other bars and rods of iron or non alloy steel, not further worked than forged, hot rolled, hot-drawn or hot-extruded, but including those twisted after rolling	7214	35%
8	Other bars and rods of iron or non alloy steel	7215	35%
9	Angles, shapes and sections of iron or non-alloy steel	7216	35%
10	Wire of iron or non-alloy steel	7217	50%
11	Flat-rolled products of stainless steel, of a width of 600 mm or more	7219	50%
12	Flat-rolled products of stainless steel, of a width of less than 600 mm	7220	50%
13	Other bars and rods of stainless steel; angles, shapes and sections of stainless steel	7222	50%
14	Wire of other alloy steel	7229	35%
15	Rails, railway or tramway track construction material of iron or steel	7302	50%
16	Tubes, pipes and hollow profiles, of cast iron	7303	35%
17	Tubes, pipes and hollow profiles, seamless, of iron (other than cast iron) or steel	7304	35%
18	Other tubes and pipes (for example, welded, riveted or similarly closed), having circular cross-sections, the external diameter of which exceeds 406.4 mm, of iron or steel	7305	35%
19	Other tubes, pipes and hollow profiles (for example, open seam or welded, riveted or similarly closed), of iron or steel	7306	35%
20	Tube or pipe fittings (for example, connectors/couplings, elbow sleeves), of iron or steel	7307	35%
21	Bars and rods, hot-rolled, in irregularly wound coils, of stainless steel	7221	35%
22	Wire of stainless steel	7223	35%
23	Flat-rolled products of other alloy steel, of a width of 600 mm or more, including electrical steel	7225	35%
24	Flat-rolled products of other alloy steel, of a width of less than 600 mm, including electrical steel	7226	35%
25	Bars and rods, hot-rolled, in irregularly wound coils, of other alloy steel	7227	15%
26	Other bars and rods of other alloy steel; angles, shapes and sections, of other alloy steel; hollow drill bars and rods, of alloy or nonalloy steel	7228	35%
27	Sheet piling of iron or steel, whether or not drilled, punched or made from assembled elements; welded angles, shapes and sections, of iron or steel	7301	15%
28	Structures (excluding prefabricated buildings of heading 9406) and parts of structures	7308	15%
29	Reservoirs, tanks, vats and similar containers for any material (other than compressed or liquefied gas), of iron or steel, of a capacity exceeding 300 whether or not lined or heatinsulated, but not fitted with mechanical or Thermal equipment	7309	15%

30	Tanks, casks, drums, cans, boxes and similar containers, for any material (other than compressed or liquefied gas), of iron or steel, of a capacity not exceeding 300 L, whether or not lined or heat-insulated, but not fitted with mechanical or thermal equipment	7310	15%
31	Containers for compressed or liquefied gas, of iron or steel	7311	15%
32	Stranded wire, ropes, cables, plaited bands, slings and the like, of iron or steel, not electrically insulated	7312	15%
33	Barbed wire of iron or steel; twisted hoop or single flat wire, barbed or not, and loosely twisted double wire, of a kind used for fencing, of iron or steel	7313	15%
34	Grill, netting and fencing, of iron or steel wire; expanded metal of iron or steel	7314	15%
35	Chain and parts thereof, of iron or steel	7315	15%
36	Anchors, grapnels and parts thereof, of iron or steel	7316	15%
37	Articles of iron and steel	7317	15%
38	Articles of iron and steel	7318	15%
39	Articles of iron and steel	7319	15%
40	Springs and leaves for springs, of iron or steel	7320	15%
41	Stoves, ranges, grates, cookers (including those with subsidiary boilers for central heating), barbecues, braziers, gas-rings, plate warmers and similar non-electric domestic appliances, and parts thereof, of iron or steel	7321	15%
42	Radiators for central heating, not electrically heated, and parts thereof, of iron or steel; air heaters and hot air distributors, not electrically heated, incorporating a motor-driven fan or blower, and parts thereof, of iron or steel	7322	15%
43	Tables and similar household articles and parts thereof, of iron or steel	7323	15%
44	Sanitary ware and parts thereof, of iron or steel	7324	15%
45	Other cast articles of iron or steel	7325	15%
46	Electrical steel and other articles of iron or steel	7326	15%
47	Railway or tramway passenger coaches, not self-propelled	8605	50%
48	Railway or tramway goods vans and wagons, not self-propelled	8606	50%
49	Parts of railway or tramway locomotives or rolling-stock; such as bogies, bissel-bogies, axles and forged wheels, and parts thereof	8607	50%

Products included in descriptions are indicative; all products under the specified HS codes are included as part of the appendix

Appendix B

Indicative list of capital goods(non-exhaustive) for manufacturing iron & steel products

Sl. No.	Plant shop	Capital goods	Minimum domestic value addition requirement
1	Raw material handling system	Apron feeder, barrel couplings, heavy duty bearings, hydraulic disc brakes, tanker & container for powdered materials, conveyor belt for pipe conveyors, high angle conveyor system, crushers, crane rail lubrication system, four girder EOT Crane, crane weighing system, crane air conditioning, fluid couplings, fork lift trucks, hydraulic motors, hydraulic system, locking assembly (friction grip), load cells, level sensors, pipe	50%

		conveyor system, plough/ paddle feeder, pneumatic transportation - dense & lean phase, reclaimers, radio remote control, rail fixing arrangements (special), rapid/ flood loading system, stackers, special screen, slew ring bearings, tippers, transfer cars, tongs (special), vibration, isolation system (spring damper), wagon tippers, wagon loaders	
2	Mineral beneficiation (iron ore and coal) equipment	Industrial crushers, grinding mills, conventional screens, slurry pumps, hire thickeners, filters, hydroclones	50%
3	Coke oven	Coke Oven Silica Refractory, Anchorage System, Waste gas valve with branch pipe, Flash Plate, Door Frame, door body, Minor Casting: Gooseneck, Valve box, AP Lid, Charging & inspection hole lid and frame Reversing mechanism, Centralised lubrication system, Hydrojet Door Cleaning Mechanism, Spillage code conveyor system, skip hoist, Door Lowering Rack, Isolation/ Reversing Cocks, Level II automation, Oven machines	50%
4	By-product plant	Primary Gas Cooler, Electrostatic Tar Precipitator, H ₂ S, NH ₃ & Naphthalene Scrubber, Combi Stripper, Flushing Liquor Pump, Claus Kiln, Claus reactors, Waste Heat Boilers, Decanters	50%
5	Sinter plant equipment	Pallet car, Drive/discharge end Sprocket assembly, Curved rail, Slide rails, Hot sinter breaker and Grizzly, Dip rail & running rail, Impeller assembly for Process fan, Drive assembly of Sinter machine, Hi-intensity Mixer & Noduliser	50%
6	Pellet plant equipment	Pallet car, Drive/discharge end Sprocket assembly, Curved rail, Slide rails, running rail, Vertical roller mill, Impeller assembly for Process fan, Drive assembly of Indurating machine, Hi-intensity Mixer, Balling disc, Single deck roller screen and Double deck roller screen	50%
7	Blast furnace equipment	Bell less top system with Bleeder valve, SG Iron stove coolers, Copper stove coolers, Stock level indicator (Radar Type), Mud gun, Drilling machine and Manipulator, Gas Cleaning Plant system, Top Recovery Turbine system including its by-pass valve, De-bricking Machine, Re-railing equipment, PCI system, Grinding mill for PCI, Stock level indicator, Tuyere Stock assembly, Waste Heat Recovery system, BF & Hot Blast Stoves Technological Valves, Above Burden probes, Slag granulation unit, Tuyere & Tuyere cooler, Torpedo Ladle Car, BF hearth refractory	50%
8	Direct reduction plant equipment	Charge distributor, Upper & lower seal leg, Reformer & Re-cuperator system, Burden feeders, Turbo-expander, Process Gas Compressor, Seal gas compressors & bottom seal gas compressors, Seal gas generators & driers, Process Gas Heater, CO ₂ removal plant	50%
9	Basic oxygen furnace equipment	Main and Maintenance equipment comprising of converter, gunning machine, Refractory/ slag monitoring device, converter vessel, trunnion ring and suspension system, trunnion bearings and housing, Converter bull gear unit and tilt drive system, Rotary joint for converter, bottom stirring system, Lance body with clamping, Lance copper tips, Valve stations for oxygen blowing/ bottom stirring, Sub-lance system, Off gas analyzer with process module i.e. Process software/ hardware, container lab Measurement probes, Switch over station, ID fan for primary gas, Hot metal and steel ladle, Ladle Transfer car, Ladle maintenance equipment, Slag pot, Slag pot transfer car, Scrap boxes, Scrap Transfer car, Lance carriage, Lance guide, Crane & hoist, Lance hoist & trolley, Lance tilting device, Traverse for lifting lances, Bunker of various sizes, Bin Vibrator, Weighing Hopper, Maintenance stands, De dusting suction hood, Teeming/HM, ladle relining stands, Stand Cooling stack inspection device, Hood traverse carriage, Refractories, Bypass & isolation valves, Flare stack & ignition system, Scrubbing tower	50%

		shell - Wet gas cleaning system, Dog house, Ladle drier, ladle pre-heater, ladle cooler, Fume collection hoods, Clean gas stack, Dust silo, Weigh Bridge, Slag retaining device	
10	Electric arc furnace	Furnace proper (includes furnace lower shell, upper shell and roof, Tilting platform, Furnace Gantry) and transformer, Electrode regulation system, Hydraulic system, Refractories, Parts of Level I & Level II Automation system. LF - water cooled ladle roof, electrode mast and arms, electrode regulating system, wire feeding system, Bottom inert gas stirring Valve stand for porous plug and top lance, Emergency lance mechanism, Lance carriage system with drive unit, Automatic temperature, sampling & bath level / O ₂ measurement, Temp. & oxygen immersion lance, lance carriage system with drive unit, Hydraulic system, Refractories, Ladle roof Delta portion, RH proper (includes Ladle transfer car, vacuum vessel, Vessel lifting & lowering system. Hydraulic system, Multi Function lance, Valve racks/station, Electrode clamp unit, conductor of electrode arms, water cooled cable, A R stirring valve rack, lance transport car, Refractory lance, Hydraulic cylinder, Ladle roof lifting cylinder, Lubrication system, Suction hood, damper, Vibro feeder, weighing hopper, wire feeding system, Electrode nippling stand, Cranes, hoist, Temperature & sampling tips, ladle stands, ESP, Deducing hoods, Refractories, bag filter, Cranes etc.	50%
11	Continuous casting equipment	Ladle turret, ladle cover manipulator, Ladle Shroud manipulator, tundish car, Continuous tundish temperature measurement system, Tundish stopper rod mechanism, emergency cut-off gate, mould assembly, Nozzle quick change device, mould oscillator and EMS system. Electro-Magnetic braking system, Strand guide segment, Withdrawal & Straightening unit (WSU), Roll gap checker, Emergency torch cutter, Torch cutting machine, Deburrer, Marking machine, Technological control system & process models, Black Refractories, strand gunde segment, tundish, ladle cover, roller tables & auxiliaries, mould& segment maintenance equipments, tundish maintenance equipments, EMBR system	50%
12	Flat product mills	Large castings and forgings like mill housing, bed plates, work rolls, backup rolls, end spindles; roller tables, backup roll and work roll chucks, coilers / tension reels / uncoilers, AGC cylinders, shears, levelers, lazer welders, packaging machines, non-contact gauges / profile gauges, anti-friction roll neck bearings, oil film bearings, gear boxes, mill motors	50%
13	Long product mills	Mill housing, bed plates, work rolls, backup rolls, spindles; roller tables, coilers / tension reels / uncoilers, shears, billet welder, packaging machines, non-contact gauges / profile gauges, anti-friction roll neck bearings, oil film bearings, finishing blocks, gear boxes, mill motors	50%

**Items in appendix B are an indicative list of capital goods for manufacturing steel, the list is not exhaustive. All capital goods for steel manufacturing shall be considered for purchase preference under the policy with a minimum domestic value addition requirement of 50%*

Form-1

Format for Affidavit of Self Certification regarding Domestic Value Addition in Iron & Steel Products/capital goods to be provided on Rs.100/- Stamp Paper Date:

I _____ S/o, D/o, W/o, _____ Resident of _____ hereby solemnly affirm and declare as under:

That I will agree to abide by the terms and conditions of the policy of Government of India issued vide Notification No: _____.

That the information furnished hereinafter is correct to the best of my knowledge and belief and I undertake to produce relevant records before the procuring agency (ies) for the purpose of assessing the domestic value addition.

That the domestic value addition for all inputs which constitute the said iron & steel products has been verified by me and I am responsible for the correctness of the claims made therein.

That in the event of the domestic value addition of the product mentioned herein is found to be incorrect and not meeting the prescribed value-addition criteria, based on the assessment of procuring agency (ies) for the purpose of assessing the domestic value-addition, I will be disqualified from any Government tender for a period of 36 months. In addition, I will bear all costs of such an assessment.

That I have complied with all conditions referred to in the Notification No. _____ wherein preference to domestically manufactured iron & steel products in Government procurement is provided and that the procuring agency (ies) is hereby authorized to forfeit and my EMD. I also undertake to pay the assessment cost and pay all penalties as specified in the tender document.

I agree to maintain the following information in the Company's record for a period of 8 years and shall make this available for verification to any statutory authority.

- i. Name and details of the Bidder (Registered Office, Manufacturing unit location, nature of legal entity)
- ii. Date on which this certificate is issued
- iii. Iron & Steel Products for which the certificate is produced
- iv. Procuring agency to whom the certificate is furnished
- v. Percentage of domestic value addition claimed and whether it meets the threshold value of domestic value addition prescribed
- vi. Name and contact details of the unit of the manufacturer (s)
- vii. Net Selling Price of the iron & steel products
- viii. Freight, insurance and handling till plant
- ix. List and total cost value of input steel (imported) used to manufacture the iron & steel products
- x. List and total cost of input steel which are domestically sourced.
- xi. Please attach domestic value addition certificates from suppliers, if the input is not in house.
- xii. For imported input steel, landed cost at Indian port with break-up of CIF value, duties & taxes, port handling charges and inland freight cost.

For and on behalf of (Name of firm / entity)

Authorized signatory (To be duly authorized by the Board of Directors)

<Insert Name, Designation and Contact No.>



सत्यमेव जयते

भारत का राजपत्र

The Gazette of India

सी.जी.-डी.एल.-अ.-04012021-224171
CG-DL-E-04012021-224171

असाधारण
EXTRAORDINARY

भाग II—खण्ड 3—उप-खण्ड (i)
PART II—Section 3—Sub-section (i)

प्राधिकार से प्रकाशित
PUBLISHED BY AUTHORITY

सं. 1]
No. 1]

नई दिल्ली, शुक्रवार, जनवरी 1, 2021/पौष 11, 1942
NEW DELHI, FRIDAY, JANUARY 1, 2021/PAUSHA 11, 1942

इस्पात मंत्रालय

अधिसूचना

नई दिल्ली, 31 दिसम्बर, 2020

सा.का.नि. 1(अ).—सरकारी प्रापण में देशी निर्मित लोहा और इस्पात उत्पादों को प्राथमिकता प्रदान करने हेतु नीति (डीएमआई एंड एसपी नीति) - परिशोधित, 2019 में संशोधनों को आम सूचना के लिए एतद्वारा प्रकाशित किया जाता है:

"सं. S-13026/1/-2020-आईडीडी

इस्पात मंत्रालय

आईडीडी प्रभाग

उद्योग भवन,

नई दिल्ली 31 दिसंबर, 2020

विषय : सरकारी खरीद में घरेलू निर्मित लोहा और इस्पात उत्पादों को प्राथमिकता प्रदान करने की नीति-परिशोधित, 2019-में संशोधन/परिवर्धन

सरकारी खरीदमें स्वदेशी निर्मित लोहा और इस्पात उत्पादों को प्राथमिकता प्रदान करने की नीति-परिशोधित, 2019-(डीएमआईएंडएसपी परिशोधित, 2019) में निम्नलिखित संशोधन/ परिवर्धन तत्काल प्रभाव से लागू हैं। ये संशोधन/

परिवर्धन ऐसी निविदा या खरीद पर लागू नहीं होंगे जिनके लिए निविदा आमंत्रित करने वाला नोटिस अथवा अन्य प्रकार का खरीद अध्याचन इस अधिसूचना के जारी होने से पूर्व जारी हुआ है।

1 – संशोधन:तालिका 1

क्रम सं.	डीएमआईएंडएसपी परिशोधित 2019 ,में मौजूदा खंड	डीएमआईएंडएसपी परिशोधित 2019 ,में संशोधित खंड
1	<p>खंड 1.3:</p> <p>यह नीति सरकार के प्रत्येक मंत्रालय अथवा विभाग और उनके प्रशासनिक नियंत्रण के अधीन सभी एजेंसियों/ प्रतिष्ठानों तथा सरकारी परियोजनाओं के वास्ते लौह एवं इस्पात उत्पादों की खरीद के लिए इन एजेंसियों द्वारा वित्तपोषित परियोजनाओं पर लागू है। हालांकि, यह नीति वाणिज्यिक पुनः बिक्री के उद्देश्य से अथवा वाणिज्यिक बिक्री के लिए वस्तुओं के उत्पादन में उपयोग करने के उद्देश्य से लौह एवं इस्पात उत्पादों की खरीद पर लागू नहीं होगी।</p>	<p>खंड 1.3:</p> <p>यह नीति सरकार के प्रत्येक मंत्रालय अथवा विभाग और उनके प्रशासनिक नियंत्रण के अधीन सभी एजेंसियों/ प्रतिष्ठानों तथा सरकारी परियोजनाओं के वास्ते लौह एवं इस्पात उत्पादों की खरीद के लिए इन एजेंसियों द्वारा वित्त पोषित परियोजनाओं पर लागू है। केन्द्रीय क्षेत्र की सभी योजनाएं (सीएस)/ केन्द्रीय प्रायोजित योजनाएं (सीएसएस) जिनके लिए राज्यों और स्थानीय निकायों द्वारा खरीद की जाती है, इस नीति की परिधि में आएंगी यदि उस परियोजना/योजना को भारत सरकार द्वारा पूर्णतया/ अंशतः वित्तपोषित किया जाता है।</p> <p>हालांकि, यह नीति वाणिज्यिक पुनः बिक्री के उद्देश्य से अथवा वाणिज्यिक बिक्री के लिए वस्तुओं के उत्पादन में उपयोग करने के उद्देश्य से लौह एवं इस्पात उत्पादों की खरीद पर लागू नहीं होगी।</p>
2	<p>खंड 2.13:</p> <p>घरेलू मूल्यवर्धन निवल बिक्री कीमत(निवलघरेलू करों और शुल्कों को छोड़कर बीजक कीमत) होगी जिससे प्रतिशत में निवल बिक्री कीमत के एक अनुपात के रूप में भारत में निर्माण संयंत्र(सभी सीमा शुल्कों सहित) में आयात की गई इनपुट सामग्री की पहुंच लागत घटाई गई हो, 'घरेलू मूल्यवर्धन'परिभाषा डी पी आई आई टी (पूर्व में डी आई पी पी) के दिशानिर्देशों के अनुरूपहोगी और उसमें भविष्य में डी पी आई आई टी द्वारा परिवर्तन किये जाने की स्थिति में उपयुक्त रूप से संशोधन किया जायेगा। इस नीति दस्तावेज के प्रयोजन के लिए घरेलूमूल्यवर्धन और स्थानीय विषय वस्तु का उपयोग एक दूसरे के स्थान पर किया गया है।</p>	<p>खंड 2.13:</p> <p>घरेलू मूल्यवर्धन का तात्पर्य है- भारत में वर्धित मूल्य की राशि जो खरीदी/बेची जाने वाली वस्तुओं का कुल मूल्य होगा (निवल घरेलू अप्रत्यक्ष करों को छोड़कर)- खरीदी/बेची जाने वाली वस्तुओं के कुल मूल्य के समानुपात के रूप में प्रतिशत में मद में आयातित सामग्री का मूल्य (सभी सीमा शुल्कों सहित)। घरेलू मूल्यवर्धन निवल बिक्री कीमत (निवल घरेलू करों और शुल्कों को छोड़कर बीजक कीमत) होगी जिससे प्रतिशत में निवल बिक्री कीमत के एक अनुपात के रूप में भारत में निर्माण संयंत्र (सभी सीमा शुल्कों सहित) में आयात की गई इनपुट सामग्री की पहुंच लागत घटाई गई हो, 'घरेलू मूल्यवर्धन'परिभाषा डी पी आई आई टी (पूर्व में डी आई पी पी) के दिशानिर्देशों के अनुरूप होगी और उसमें भविष्य में डी पी आई आई टी द्वारा परिवर्तन किये जाने की स्थिति में उपयुक्त रूप से संशोधन किया जायेगा। इस नीति दस्तावेज के प्रयोजन के लिए घरेलू मूल्यवर्धन और स्थानीय विषय वस्तु का उपयोग एक दूसरे के स्थान पर किया गया है।</p>

<p>3 खंड 5.1.5</p> <p>यह नीति सरकार के मंत्रालय अथवा विभाग के द्वारा वित्त-पोषित सभी परियोजनाओं और उनके प्रशासनिक नियंत्रण के अधीन सभी एजेंसियों/ प्रतिष्ठानों पर लौह एवं इस्पात उत्पादों की खरीद के लिए लागू है।</p>	<p>खंड 5.1.5</p> <p>यह नीति सरकार के मंत्रालय अथवा विभाग के द्वारा वित्त पोषित सभी परियोजनाओं और उनके प्रशासनिक नियंत्रण के अधीन सभी एजेंसियों/ प्रतिष्ठानों पर लौह एवं इस्पात उत्पादों की खरीद के लिए लागू है। केन्द्रीय क्षेत्र की सभी योजनाएं (सीएस)/ केन्द्रीय प्रायोजित योजनाएं (सीएसएस) जिनके लिए राज्यों और स्थानीय निकायों द्वारा खरीद की जाती है, इस नीति की परिधि में आएंगी यदि उस परियोजना/योजना को भारत सरकार द्वारा पूर्णतया/अंशतः वित्तपोषित किया जाता है</p>
<p>4 खंड 5.1.6</p> <p>यह नीति उन परियोजनाओं पर लागू होगी जहां लौह एवं इस्पात उत्पादों का खरीद मूल्य 25 करोड़ रुपए से अधिक होता हो। यह नीति अन्य खरीद (गैर परियोजना) के लिए भी लागू होगी जहां उस सरकारी संगठन के लिए लौह एवं इस्पात उत्पादों का वार्षिक खरीद मूल्य 25 करोड़ रुपए से अधिक होता हो।</p>	<p>खंड 5.1.6</p> <p>यह नीति उन परियोजनाओं पर लागू होगी जहां लौह एवं इस्पात उत्पादों (डीएमआई एंड एसपी नीति का परिशिष्ट-क) का खरीद मूल्य 5लाख रुपए से अधिक होता हो। यह नीति अन्य खरीद (गैर परियोजना) के लिए भी लागू होगी जहां उस सरकारी संगठन के लिए लौह एवं इस्पात उत्पादों का वार्षिक खरीद मूल्य 5 लाख करोड़ रुपए से अधिक होता हो। तथापि, प्रापण इकाइयों द्वारा इस बात को सुनिश्चित किया जाएगा कि इस नीति के प्रावधानों से बचने के प्रयोजनार्थ खरीद का विभाजन न किया जाए।</p>
<p>5 खंड 7.2</p> <p>घरेलू मूल्यवर्धन निवल बिक्री कीमत (निवल घरेलू करों और शुल्कों को छोड़कर बीजककीमत) होगी जिसमें से प्रतिशत में निवल बिक्री कीमत के एक अनुपात के रूप में भारत में निर्माण करने वाले संयंत्र में आयात की गई इनपुट सामग्री की पहुंच लागत (सभी सीमा शुल्कों को शामिल करते हुए) घटाई जायेगी।</p>	<p>खंड 7.2</p> <p>घरेलू मूल्यवर्धन का तात्पर्य है- भारत में वर्धित मूल्य की राशि जो खरीदी/बेची जाने वाली वस्तुओं का कुल मूल्य होगा (निवल घरेलू अप्रत्यक्ष करों को छोड़कर)- खरीदी/बेची जाने वाली वस्तुओं के कुल मूल्य के समानुपात के रूप में प्रतिशत में मद में आयातित सामग्री का मूल्य (सभी सीमा शुल्कों सहित)।</p>
<p>6 खंड 7.3</p> <p>यह सिफारिश की जाती है कि निविदा की प्रक्रिया में भाग लेने वाले प्रत्येक बोली लगाने वाले को नीचे दिए गए सूत्र का उपयोग करते हुए घरेलू मूल्यवर्धन की गणना करनी चाहिए ताकि यह सुनिश्चित किया जा सके कि दावा किये गये घरेलू मूल्यवर्धन इस नीति के न्यूनतम निर्धारित घरेलू मूल्यवर्धन के अनुरूप है।</p> <p>लौह एवं इस्पात उत्पादों के लिए % घरेलू मूल्यवर्धन</p> <p>अंतिम उत्पाद की निवल बिक्री कीमत- संयंत्र में आयात किये गये लौह अथवा इस्पात की पहुंच लागत----- X100%</p>	<p>खंड 7.3</p> <p>यह सिफारिश की जाती है कि प्रापण करने वाली सरकारी एजेंसी/ निविदा की प्रक्रिया में भाग लेने वाले प्रत्येक बोली लगाने वाले को नीचे दिए गए सूत्र का उपयोग करते हुए घरेलू मूल्यवर्धन की गणना करनी चाहिए ताकि यह सुनिश्चित किया जा सके कि दावा किये गये घरेलू मूल्यवर्धन इस नीति के न्यूनतम निर्धारित घरेलू मूल्यवर्धन के अनुरूप है।</p> <p>लौह एवं इस्पात उत्पादों तथा पूंजीगत माल के लिए % घरेलू मूल्यवर्धन</p> <p>खरीदी/बेची जाने वाली वस्तु का कुल मूल्य (निवल घरेलू अप्रत्यक्ष करों को छोड़कर - मद में आयातित सामग्री का मूल्य (सभी सीमा शुल्कों सहित) ----- -----X100%</p>

अंतिम उत्पाद की निवल ब्रिकी कीमत पूँजीगत माल के लिए % घरेलू मूल्यवर्धन अंतिम उत्पाद की निवल ब्रिकी कीमत- संयंत्र में आयात किये गये इनपुट सामग्री की पहुंच लागत-----X 100% अंतिम उत्पाद की निवल ब्रिकी कीमत	खरीदी/बेची जाने वाली वस्तु का कुल मूल्य
--	---

II डीएमआईएंडएसपी परिशोधित, 2019 के परिशिष्ट क में निम्नलिखित संशोधन किया जाता है:- जहां कहीं न्यूनतम घरेलू मूल्य वर्धन आवश्यकता कॉलम के अंतर्गत डीएमआईएंडएसपी परिशोधित, 2019 के परिशिष्ट क में 15% का न्यूनतम घरेलू मूल्य वर्धन विनिर्दिष्ट होगा, वहां उसे 20% न्यूनतम घरेलू मूल्यवर्धन से प्रतिस्थापित कर दिया जाएगा (परिशोधित परिशिष्ट-क संलग्न है)

III- परिवर्धन/सन्निवेशन: तालिका 2

क्रम सं	डीएमआईएंडएसपी परिशोधित, 2019 में शामिल/जोड़े गये खंड
1	<p>खण्ड 5.1.13 को खण्ड 5.1.12 के नीचे निम्नवत जोड़ा जाता है:</p> <p>खण्ड 5.1.13: लोहे और इस्पात उत्पादों की खरीद से संबंधित निविदाओं के लिए कोई वैश्विक निविदा इन्क्वायरी (जीटीई) आमंत्रित नहीं की जाएगी (डीएमआई और एसपी नीति का परिशिष्ट-क)। लोहे और इस्पात उत्पादों के विनिर्माण जिनका अनुमानित मूल्य 200 करोड़ रु तक हो, (डीएमआई और एसपी नीति के परिशिष्ट- ख) के लिए पूँजीगत सामानों की खरीद से संबंधित निविदाओं के लिए कोई वैश्विक निविदा इन्क्वायरी (जीटीई) व्यय विभाग द्वारा यथा नाम-निर्दिष्ट सक्षम प्राधिकारी के अनुमोदन के अलावा आमंत्रित नहीं की जाएगी,</p>
2	<p>खंड 6.9 को खंड 6.8 के नीचे निम्नवत जोड़ा जाता है:</p> <p>खंड 6.9: निविदाओं और अन्य खरीद अधियाचनों में विनिर्देशन:</p> <p>6.9.1 प्रत्येक क्रय इकाई यह सुनिश्चित करेगी कि किसी भी निविदा या अधियाचन में निर्धारित पिछले अनुभव के संबंध में पात्रता की शर्तों हेतु अन्य देशों में आपूर्ति के प्रमाण या निर्यात के प्रमाण की आवश्यकता नहीं है।</p> <p>6.9.2 क्रय इकाईयाँ यह देखने का प्रयास करेंगी कि पात्रता की शर्तों, जैसे टर्नओवर, उत्पादन क्षमता और वित्तीय ताकत जैसे मामलों में वैसे स्थानीय आपूर्तिकर्ता का अनुचित अपवर्जन नहीं होता है 'जो आपूर्तिकर्ता की गुणवत्ता या साख संबंधी पात्रता सुनिश्चित करने के लिए जो आवश्यक है, उससे परे अन्यथा पात्र होंगे।</p> <p>6.9.3 क्रय इकाईयाँ, इस नीति के जारी होने के 2 महीने के भीतर ऊपर उप-पैराग्राफ 6.9.1 और 6.9.2 के संदर्भ में सभी मौजूदा पात्रता मानदंडों और शर्तों की समीक्षा करेंगी।</p> <p>6.9.4 यदि इस्पात मंत्रालय इस बात से संतुष्ट है कि लौह और इस्पात उत्पादों के भारतीय आपूर्तिकर्ताओं को प्रतिबंधात्मक निविदा शर्तों के कारण किसी भी विदेशी सरकार द्वारा खरीद में भाग लेने और / या प्रतिस्पर्धा करने की अनुमति नहीं है, जिसका भारतीय कंपनियों को प्रतिबंधित करने पर प्रत्यक्ष या अप्रत्यक्ष प्रभाव पड़ता है, जैसे कि प्रापण देश में पंजीकरण, प्रापण देश इत्यादि में विशिष्ट मूल्य की परियोजना का निष्पादन इत्यादि। यदि उपयुक्त समझा जाएगा तो उस देश के बोलीदाताओं को इस्पात मंत्रालय से संबंधित उस वस्तु तथा/ या अन्य वस्तुओं की खरीद के लिए पात्रता से प्रतिबंधित या अपवर्जित किया जा सकता है।</p> <p>6.9.5 ऊपर उप-पैरा 6.9.4 के प्रयोजन से, किसी आपूर्तिकर्ता या बोलीदाता को उस देश से माना जाएगा यदि (i) इकाई को उस देश में निगमित किया गया है, या (ii) उसकी शेयरधारिता या इकाई का प्रभावी नियंत्रण उस देश से किया जाता है; या (iii) आपूर्ति की जा रही वस्तु के मूल्य का 50% से अधिक उस देश में शामिल किया गया है। भारतीय आपूर्तिकर्ताओं का अर्थ उन संस्थाओं से होगा जो भारत के संबंध में इनमें से किसी भी मानदंड को पूरा करते हैं। किसी देश की 'इकाई' (एन्टिटी) शब्द का अर्थ वहीं होगा जो डीपीआईआईटी की एफडीआई नीति के तहत समय-समय पर यथा संशोधित के अंतर्गत है।</p>

3	<p>खंड 6.10 को खंड 6.9 के नीचे निम्नवत जोड़ा जाता है:</p> <p>खंड 6.10: यदि घरेलू आपूर्तिकर्ताओं के खिलाफ प्रतिबंधात्मक या भेदभावपूर्ण शर्तों को बोली दस्तावेजों में शामिल किया जाता है, तो उस के लिए जिम्मेदारी तय करने के लिए खरीद (इसके प्रशासनिक नियंत्रणाधीन किसी ईकाई द्वारा खरीद सहित) करने वाले प्रशासनिक विभाग द्वारा जांच शुरू की जाएगी। तत्पश्चात्, संबंधित प्रावधानों के तहत खरीद संस्थाओं के अधिकारियों के खिलाफ उचित, प्रशासनिक या अन्यथा कार्रवाई की जाएगी। ऐसी सभी कार्रवाई की सूचना डीएमआई और एसपी नीति के तहत स्थायी समिति को भेजी जाएगी।</p>
---	---

संशोधित परिशिष्ट क - घरेलू स्तर पर निर्मित उत्पादों के लिए विशिष्ट रूप से

क्र. सं.	लौह एवं इस्पात उत्पादों की सांकेतिक सूची	लागू एच एस कोड	न्यूनतम घरेलू मूल्यवर्धन आवश्यकता
1	600 मि. मी. अथवा उससे अधिक की चौड़ाई वाले लौह अथवा गैर एलॉय इस्पात का फ्लेट रोल उत्पाद, हॉट रोल, न ढका हुआ, प्लेट लगाया हुआ अथवा कोट किया हुआ	7208	50%
2	600 मि. मी. अथवा उससे अधिक की चौड़ाई वाले लौह अथवा गैर एलॉय इस्पात का फ्लेट रोल उत्पाद, कोल्ड रोल (कोल्ड - कम किया हुआ), न ढका हुआ, प्लेट लगाया हुआ अथवा कोट किया हुआ	7209	50%
3	600 मि. मी. अथवा उससे अधिक की चौड़ाई वाले लौह अथवा गैर एलॉय इस्पात का फ्लेट रोल उत्पाद, ढका हुआ, प्लेट लगाया हुआ अथवा कोट किया हुआ	7210	50%
4	600 मि. मी. से कम की चौड़ाई वाले लौह अथवा गैर एलॉय इस्पात का फ्लेट रोल उत्पाद, न ढका हुआ, प्लेट लगाया हुआ अथवा कोट किया हुआ	7211	35%
5	600 मि. मी. कम की चौड़ाई का लौह अथवा गैर एलॉय इस्पात का फ्लेट रोल उत्पाद, ढका हुआ, प्लेट लगाया हुआ अथवा कोट किया हुआ	7212	35%
6	लौह एवं गैर एलॉय इस्पात का अनियमित रूप से ऐंठा हुआ क्वाइल में बार्स और रॉड, हॉट रोल	7213	35%
7	लौह अथवा गैर एलॉय इस्पात के अन्य बार्स और रॉड्स जिसे फोर्ज किए जाने की तुलना में आगे अधिक वर्क नहीं किया हुआ, हॉट रोल, हॉट ड्रॉन अथवा हॉट एक्सट्रूडेड परंतु रोलिंग के बाद उसे टिविस्ट किये जाने सहित	7214	35%
8	लौह अथवा गैर एलॉय इस्पात का अन्य बार्स एंड रॉड्स	7215	35%
9	लौह अथवा गैर एलॉय इस्पात का एंगल, शेष और सेक्शन्स	7216	35%
10	लौह अथवा गैर एलॉय इस्पात का तार	7217	50%
11	600 मि. मी. अथवा उससे अधिक की चौड़ाई का स्टेनलैस इस्पातका फ्लेट रोल इस्पात	7219	50%
12	600 मि. मी. से कम की चौड़ाई का स्टेनलैस इस्पातका फ्लेट रोल इस्पात	7220	50%
13	स्टेनलैस स्टील का अन्य बार्स और रॉड्स; स्टेनलैस स्टील का एंगल शेष और सेक्शन्स	7222	50%
14	अन्य एलॉय इस्पात का तार	7229	35%
15	लौह अथवा इस्पात को रेल, रेलवे अथवा ट्रामवे ट्रेक निर्माण सामग्री	7302	50%

16	कास्ट लौह का ट्यूब, पाइप और होलो पाइप	7303	35%
17	लौह (कास्ट आयरन को छोड़कर) अथवा इस्पात का ट्यूब पाइप और होलो प्रोफाइल, सीमलैस	7304	35%
18	लौह अथवा इस्पात का सर्कुलर क्रॉस सेक्शन वाले अन्य ट्यूब और पाइप (उदाहरण के लिए, वेल्ड किया हुआ, रिबेट किया हुआ अथवा समान रूप से बंद किया गया हुआ), जिसकी बाहरी त्रिज्या 406.4 मि. मी. से अधिक हो	7305	35%
19	लौह अथवा इस्पात के अन्य ट्यूब, पाइप और होलो प्रोफाइल (उदाहरण के लिए ओपन सीन अथवा वेल्ड किया हुआ, रिबेट किया हुआ अथवा समान रूप से बंद किया गया हुआ)	7306	35%
20	लौह अथवा इस्पात का ट्यूब अथवा पाइप फिटिंग (उदाहरण के लिए, कनेक्टर/ कप्लिंग, एल्बो स्लीव्स)	7307	35%
21	स्टेनलैस स्टील का अनियमित रूप से ऎंठा हुआ क्वाइल में बार्स और रॉड, हॉट रोल्ड	7221	35%
22	स्टेनलैस स्टील का वायर	7223	35%
23	इलेक्ट्रिकल स्टील सहित 600 मि. मी. अथवा उससे अधिक की चौड़ाई वाले अन्य एलॉय स्टील का फ्लेट रोल्ड इस्पात	7225	35%
24	इलेक्ट्रिकल स्टील सहित 600 मि. मी. से कम की चौड़ाई वाले अन्य एलॉय स्टील का फ्लेट रोल्ड इस्पात	7226	35%
25	अन्य एलॉय स्टील का अनियमित रूप से ऎंठा हुआ क्वाइल में बार्स और रॉड, हॉट रोल्ड	7227	20%
26	अन्य एलॉय स्टील का अन्य बार्स और रॉड्स; अन्य एलॉय स्टील का एंगल, शेप्स और सेक्शन्स; एलॉय अथवा नॉन एलॉय स्टील का होलो ड्रिल बार्स और रॉड्स	7228	35%
27	लौह अथवा इस्पात की शीट पाइलिंग, चाहे ड्रिल किया हुआ हो अथवा नहीं, चाहे पंच किया हुआ हो अथवा नहीं, चाहे असेम्बल किये हुए तत्वों से बना हुआ हो अथवा नहीं; लौह अथवा इस्पात का वेल्ड किया हुआ एंगल, शेप और सेक्शन्स	7301	20%
28	स्ट्रक्चर्स (9406 के शीर्ष का प्रीफेब्रिकेटिड भवनों को छोड़कर) और स्ट्रक्चर्स का हिस्सा	7308	20%
29	300 से अधिक क्षमता का लौह अथवा इस्पात का किसी सामग्री (कम्प्रेस किए हुए अथवा सरलीकृत गैस को छोड़कर) के लिए भंडार, टैंक, वैट और समान कन्टेनर चाहे उसे लाइन किया गया हो अथवा नहीं या उसे हीट से इन्सुलेट किया गया हो अथवा नहीं लेकिन यांत्रिक अथवा तापीय उपक्रम से युक्त न हो	7309	20%
30	अधिकतम 300 लीटर की क्षमता का लौह अथवा इस्पात का किसी सामग्री (कम्प्रेस किए हुए अथवा सरलीकृत गैस को छोड़कर) के लिए टैंक, कास्ट, ड्रम, केन, बॉक्स और समान कन्टेनर चाहे उसे लाइन किया गया हो अथवा नहीं या उसे हीट से इन्सुलेट किया गया हो अथवा नहीं लेकिन यांत्रिक अथवा तापीय उपक्रम से युक्त न हो	7310	20%
31	लौह अथवा इस्पात का कम्प्रेस किया हुआ अथवा सरलीकृत गैस के लिए कन्टेनर	7311	20%

32	लौह अथवा इस्पात का स्टैंडिड वायर, रोप, केबल, प्लेटिड बैंड, स्लिंग और उसके समान वस्तु जिसे विद्युतीय रूप से इन्सुलेट न किया गया	7312	20%
33	लौह अथवा इस्पात का फेनसिंग के लिए उपयोग किये जाने वाला बार किया हुआ वायर; ट्विस्ट किया हुआ हूप अथवा सिंगल फ्लेट वायर, बार्स किया हुआ अथवा नहीं और लूज तरीके से ट्विस्ट किया हुआ डबल वायर	7313	20%
34	लौह अथवा इस्पात तार का ड्रील, नेटिंग और फेनसिंग; लौह अथवा इस्पात का विस्तार किया हुआ धातु	7314	20%
35	लौह अथवा इस्पात का चैन और उसका हिस्सा	7315	20%
36	लौह अथवा इस्पात का टैंकर, ग्रेपनेल्स और उसका हिस्सा	7316	20%
37	लौह एवं इस्पात की वस्तुएं	7317	20%
38	लौह एवं इस्पात की वस्तुएं	7318	20%
39	लौह एवं इस्पात की वस्तुएं	7319	20%
40	लौह अथवा इस्पात का स्प्रिंग और स्प्रिंग के लिए लीव्स	7320	20%
41	लौह अथवा इस्पात का स्टोव्स, रेंज, ग्रेड, कूकर (केंद्रीय हिटिंग के लिए सहायक बायलरों के साथ उन वस्तुओं सहित), बारबेक्यूज, ब्रेजियर्स, गैस रिंग, प्लेट वामर्स और समान गैर-विद्युतीय घरेलू उपकरण और उसका हिस्सा	7321	20%
42	लौह अथवा इस्पात का केंद्रीय हिटिंग के लिए रेडियेटर जिसे विद्युतीय रूप से हीट न किया गया हो और उसका हिस्सा; लौह अथवा इस्पात का हेयर हीटर और हॉट एयर वितरक जिसे विद्युतीय रूप से हीट न किया गया हो, फेन अथवा ब्लोअर जो मोटर से चलती हो और उसके हिस्से को शामिल करते हुए	7322	20%
43	लौह अथवा इस्पात का टेबल और समान घरेलू वस्तुएं और उसका हिस्सा	7323	20%
44	लौह अथवा इस्पात का सेनेटरी वेयर और उसकेपार्ट्स	7324	20%
45	लौह अथवा इस्पात का अन्य कास्ट सामान	7325	20%
46	लौह अथवा इस्पात का विद्युतीय इस्पात और अन्य वस्तु	7326	20%
47	रेलवे अथवा ट्रामवे पेसेंजर कोच जो स्वयं आगे नहीं बढ़ता हो	8605	50%
48	रेलवे अथवा ट्रामवे माल वेन और वेगेन जो स्वयं आगे नहीं बढ़ता हो	8606	50%
49	रेलवे अथवा ट्रामवे लोकोमोटिव का हिस्सा अथवा रोलिंग स्टॉक जैसे बोगिज, बिसल बोगिज, एक्सेल और फोज्ड किया हुआ पहिया और उसका हिस्सा	8607	50%

विवरणों में शामिल किए गए उत्पाद सांकेतिक हैं; विनिर्दिष्ट एच एस कोड के अंतर्गत सभी उत्पादों को परिशिष्ट के भाग के रूप में शामिल किया गया है।"

[फा. सं. एस-13026/1/2020-आईडीडी]

रसिका चौबे, अपर सचिव

MINISTRY OF STEEL
NOTIFICATION

New Delhi, the 31st December, 2020

G.S.R. 1(E).—The amendments in the Policy for providing preference to domestically manufactured Iron & Steel products in Government procurement (DMI&SP Policy)—Revised, 2019 is hereby published for general information.

"No. S-13026/1/2020- IDD

Ministry of Steel

ID Division

Udyog Bhawan,

New Delhi 31st December, 2020

Sub.: Amendments / additions to the Policy for Providing Preference to Domestically Manufactured Iron & Steel Products in Government Procurement - revised, 2019

The following amendments / additions to the Policy for Providing Preference to Domestically Manufactured Iron & Steel Products in Government Procurement - revised, 2019 (DMI&SP revised, 2019) are applicable with immediate effect. These amendments / additions shall not apply to any tender or procurement for which notice inviting tender or other form of procurement solicitation has been issued before the issue of this notification.

I - Amendments: Table 1

Sl. No.	Existing Clause in DMI&SP revised, 2019	Amended Clause in DMI&SP revised, 2019
1	<p><u>Clause 1.3:</u> The policy is applicable to every Ministry or Department of Government and all agencies/entities under their administrative control and to projects funded by these agencies for purchase of iron & steel products for government projects. However, this policy shall not apply for purchase of iron & steel products with a view to commercial resale or with a view to use in the production of goods for commercial sale.</p>	<p><u>Clause 1.3:</u> The policy is applicable to every Ministry or Department of Government and all agencies/entities under their administrative control and to projects funded by these agencies for purchase of iron & steel products for government projects. <u>All Central Sector Schemes (CS)/Centrally Sponsored Schemes (CSS) for which procurement is made by States and Local Bodies, would come within the purview of this Policy, if that project / scheme is fully / partly funded by Government of India.</u> However, this policy shall not apply for purchase of iron & steel products with a view to commercial resale or with a view to use in the production of goods for commercial sale.</p>
2	<p><u>Clause 2.13:</u> Domestic value addition shall be the net selling price (invoiced price excluding net domestic taxes and duties) minus the landed cost of imported input materials at the manufacturing plant in India (including all customs duties) as a proportion of the net selling price, in percent. The 'domestic value addition' definition shall be in line with the DPIIT (formerly DIPP) guidelines, and shall be suitably amended in case of any changes by DPIIT in the future. For the purpose of this policy document, domestic value addition and local content have been used interchangeably.</p>	<p><u>Clause 2.13:</u> Domestic value addition means - <u>amount of value added in India which shall be the total value of the item to be procured / sold (excluding net domestic indirect taxes) minus the value of imported content in the item (including all customs duties) as a proportion of the total value of the item to be procured / sold, in percent.</u> The 'domestic value addition' definition shall be in line with the DPIIT (formerly DIPP) guidelines, and shall be suitably amended in case of any changes by DPIIT in the future. For the purpose of this policy document, domestic value addition and local content have been used interchangeably.</p>

3	<p>Clause 5.1.5 The policy is applicable to all projects funded by Ministry or Department of Government and all agencies/ entities under their administrative control for purchase of iron & steel products.</p>	<p>Clause 5.1.5: The policy is applicable to all projects funded by Ministry or Department of Government and all agencies/ entities under their administrative control for purchase of iron & steel products. <u>All Central Sector Schemes (CS)/Centrally Sponsored Schemes (CSS) for which procurement is made by States and Local Bodies, would come within the purview of this Policy, if that project / scheme is fully / partly funded by Government of India.</u></p>
4	<p>Clause 5.1.6: The policy shall be applicable to projects where the procurement value of iron and steel products is greater than Rs. 25 crores. The policy shall also be applicable for other procurement (non-project), where annual procurement value of iron and steel products for that Government organization is greater than Rs. 25 crores.</p>	<p>Clause 5.1.6 The policy shall be applicable to projects where the procurement value of iron and steel products (Appendix - A of the DMI&SP Policy) is greater than Rs. 5 lakhs. The policy shall also be applicable for other procurements (non-project), where annual procurement value of iron and steel products for that Government organization is greater than Rs. 5 lakhs. However, it shall be ensured by procuring entities that procurement is not split for the purpose of avoiding the provisions of this policy.</p>
5	<p>Clause 7.2: Domestic value addition shall be the net selling price (invoiced price excluding net domestic taxes and duties) minus the landed cost of imported input materials at the manufacturing plant in India (including all customs duties) as a proportion of the net selling price, in per cent.</p>	<p>Clause 7.2: Domestic value addition means - amount of value added in India which shall be the total value of the item to be procured / sold (excluding net domestic indirect taxes) minus the value of imported content in the item (including all customs duties) as a proportion of the total value of the item to be procured / sold, in percent.</p>
6	<p>Clause 7.3: It is recommended that each bidder participating in the tender process should calculate the domestic value addition using the below formula below so as to ensure the domestic value addition claimed is consistent with the minimum stipulated domestic value addition requirement of the policy.</p> <p>For iron and steel products</p> <p><u>% domestic value addition</u></p> <p><i>Net selling price of final product - landed cost of imported iron or steel at the plant-----</i> <i>----- X 100 %</i></p> <p><i>Net selling price of final product</i></p> <p>For capital goods</p> <p><u>% domestic value addition</u></p> <p><i>Net selling price of final product - landed cost of imported iron or steel at the plant</i> <i>----- X 100 %</i></p> <p><i>Net selling price of final product</i></p>	<p>Clause 7.3: It is recommended that procuring Government agency / bidder participating in the tender process should calculate the domestic value addition using the below formula so as to ensure that the domestic value addition claimed is consistent with the minimum stipulated domestic value addition requirement of the policy.</p> <p>For iron and steel products & capital goods</p> <p><u>% domestic value addition</u></p> <p><i>Total value of the item to be procured / sold (excluding net domestic indirect taxes) - the value of imported content in the item (including all customs duties)</i> <i>----- X 100 %</i></p> <p><i>Total value of the item to be procured / sold</i></p>

II - Following amendment is made to the Appendix A of the DMI&SP revised, 2019 :- Wherever minimum domestic value addition of **15%** is specified in the Appendix - A of the DMI&SP revised, 2019 under the column Minimum domestic value addition requirement, same shall be replaced with **20%** minimum domestic value addition). (Revised Appendix - A is attached)

III - Additions / Insertions: Table 2

Sl. No.	Added / Inserted Clause in DMI&SP revised, 2019
1	<p>Clause 5.1.13 is inserted below Clause 5.1.12 as:</p> <p>Clause 5.1.13: No Global Tender Enquiry (GTE) shall be invited for tenders related to procurement of iron and steel products (Appendix-A of the DMI&SP Policy). No Global Tender Enquiry (GTE) shall be invited for tenders related to procurement of Capital Goods for manufacturing iron & steel products (Appendix- B of the DMI&SP Policy) having estimated value upto Rs. 200 Crore except with the approval of competent authority as designated by Department of Expenditure.</p>
2	<p>Clause 6.9 is inserted below Clause 6.8 as:</p> <p>Clause 6.9: Specifications in Tenders and other procurement solicitations:</p> <p>6.9.1 Every procuring entity shall ensure that the eligibility conditions in respect of previous experience fixed in any tender or solicitation do not require proof of supply in other countries or proof of exports.</p> <p>6.9.2 Procuring entities shall endeavour to see that eligibility conditions, including on matters like turnover, production capability and financial strength do not result in unreasonable exclusion of local supplier' who would otherwise be eligible, beyond what is essential for ensuring quality or creditworthiness of the supplier.</p> <p>6.9.3 Procuring entities shall, within 2 months of the issue of this policy review all existing eligibility norms and conditions with reference to sub-paragraphs 6.9.1 and 6.9.2 above.</p> <p>6.9.4 If Ministry of Steel is satisfied that Indian suppliers of iron and steel products are not allowed to participate and/ or compete in procurement by any foreign government due to restrictive tender conditions which have direct or indirect effect of barring Indian companies such as registration in the procuring country, execution of project of specific value in the procuring country etc., it may, if deemed appropriate, restrict or exclude bidders from that country from eligibility for procurement of that item and/ or other items relating to Ministry of Steel.</p> <p>6.9.5 For the purpose of sub-paragraph 6.9.4 above, a supplier or bidder shall be considered to be from a country if (i) the entity is incorporated in that country, or (ii) a majority of its shareholding or effective control of the entity is exercised from that country; or (iii) more than 50% of the value of the item being supplied has been added in that country. Indian suppliers shall mean those entities which meet any of these tests with respect to India. The term 'entity' of a country shall have the same meaning as under the FDI Policy of DPIIT as amended from time to time.</p>
3	<p>Clause 6.10 is inserted below Clause 6.9 as:</p> <p>Clause 6.10: In case restrictive or discriminatory conditions against domestic suppliers are included in bid documents, an inquiry shall be conducted by the Administrative Department undertaking the procurement (including procurement by any entity under its administrative control) to fix responsibility for same. Thereafter, appropriate action, administrative or otherwise, shall be taken against erring officials of procurement entities under relevant provisions. Intimation on all such action shall be sent to the Standing Committee under the DMI&SP Policy.</p>

IV - Revised Appendix A - Exclusive for domestically manufactured products

Sl. No	Indicative list of Iron & Steel Products	Applicable HS code	Minimum domestic value addition requirement
1	Flat-rolled products of iron or non alloy steel, of a width of 600 mm or more, hot rolled, not clad, plated or coated	7208	50%
2	Flat-rolled products of iron or non alloy steel, of a width of 600	7209	50%

	mm or more, cold rolled (cold-reduced), not clad, plated or coated		
3	Flat-rolled products of iron or non alloy steel, of a width of 600 mm or more, clad, plated or coated	7210	50%
4	Flat-rolled products of iron or non alloy steel, of a width of less than 600 mm, not clad, plated or coated	7211	35%
5	Flat-rolled products of iron or non alloy steel, of a width of less than 600 mm, clad, plated or coated	7212	35%
6	Bars and rods, hot-rolled, in irregularly wound coils, of iron or non-alloy steel	7213	35%
7	Other bars and rods of iron or non alloy steel, not further worked than forged, hot rolled, hot-drawn or hot-extruded, but including those twisted after rolling	7214	35%
8	Other bars and rods of iron or non alloy steel	7215	35%
9	Angles, shapes and sections of iron or non-alloy steel	7216	35%
10	Wire of iron or non-alloy steel	7217	50%
11	Flat-rolled products of stainless steel, of a width of 600 mm or more	7219	50%
12	Flat-rolled products of stainless steel, of a width of less than 600 mm	7220	50%
13	Other bars and rods of stainless steel; angles, shapes and sections of stainless steel	7222	50%
14	Wire of other alloy steel	7229	35%
15	Rails, railway or tramway track construction material of iron or steel	7302	50%
16	Tubes, pipes and hollow profiles, of cast iron	7303	35%
17	Tubes, pipes and hollow profiles, seamless, of iron (other than cast iron) or steel	7304	35%
18	Other tubes and pipes (for example, welded, riveted or similarly closed), having circular cross-sections, the external diameter of which exceeds 406.4 mm, of iron or steel	7305	35%
19	Other tubes, pipes and hollow profiles (for example, open seam or welded, riveted or similarly closed), of iron or steel	7306	35%
20	Tube or pipe fittings (for example, connectors/couplings, elbow sleeves), of iron or steel	7307	35%
21	Bars and rods, hot-rolled, in irregularly wound coils, of stainless steel	7221	35%
22	Wire of stainless steel	7223	35%
23	Flat-rolled products of other alloy steel, of a width of 600 mm or more, including electrical steel	7225	35%
24	Flat-rolled products of other alloy steel, of a width of less than 600 mm, including electrical steel	7226	35%
25	Bars and rods, hot-rolled, in irregularly wound coils, of other alloy steel	7227	20%

26	Other bars and rods of other alloy steel; angles, shapes and sections, of other alloy steel; hollow drill bars and rods, of alloy or nonalloy steel	7228	35%
27	Sheet piling of iron or steel, whether or not drilled, punched or made from assembled elements; welded angles, shapes and sections, of iron or steel	7301	20%
28	Structures (excluding prefabricated buildings of heading 9406) and parts of structures	7308	20%
29	Reservoirs, tanks, vats and similar containers for any material (other than compressed or liquefied gas), of iron or steel, of a capacity exceeding 300 whether or not lined or heatinsulated, but not fitted with mechanical or Thermal equipment	7309	20%
30	Tanks, casks, drums, cans, boxes and similar containers, for any material (other than compressed or liquefied gas), of iron or steel, of a capacity not exceeding 300 L, whether or not lined or heat-insulated, but not fitted with mechanical or thermal equipment	7310	20%
31	Containers for compressed or liquefied gas, of iron or steel	7311	20%
32	Stranded wire, ropes, cables, plaited bands, slings and the like, of iron or steel, not electrically insulated	7312	20%
33	Barbed wire of iron or steel; twisted hoop or single flat wire, barbed or not, and loosely twisted double wire, of a kind used for fencing, of iron or steel	7313	20%
34	Grill, netting and fencing, of iron or steel wire; expanded metal of iron or steel	7314	20%
35	Chain and parts thereof, of iron or steel	7315	20%
36	Anchors, grapnels and parts thereof, of iron or steel	7316	20%
37	Articles of iron and steel	7317	20%
38	Articles of iron and steel	7318	20%
39	Articles of iron and steel	7319	20%
40	Springs and leaves for springs, of iron or steel	7320	20%
41	Stoves, ranges, grates, cookers (including those with subsidiary boilers for central heating), barbecues, braziers, gas-rings, plate warmers and similar non-electric domestic appliances, and parts thereof, of iron or steel	7321	20%
42	Radiators for central heating, not electrically heated, and parts thereof, of iron or steel; air heaters and hot air distributors, not electrically heated, incorporating a motor-driven fan or blower, and parts thereof, of iron or steel	7322	20%
43	Tables and similar household articles and parts thereof, of iron or steel	7323	20%
44	Sanitary ware and parts thereof, of iron or steel	7324	20%
45	Other cast articles of iron or steel	7325	20%

46	Electrical steel and other articles of iron or steel	7326	20%
47	Railway or tramway passenger coaches, not self-propelled	8605	50%
48	Railway or tramway goods vans and wagons, not self-propelled	8606	50%
49	Parts of railway or tramway locomotives or rolling-stock, such as bogies, bissel-bogies, axles and forged wheels, and parts thereof	8607	50%

Products included in descriptions are indicative; all products under the specified HS codes are included as part of the appendix."

[F. No. S-13026/1/2020-IDD]
RASIKA CHAUBE, Addl. Secy.



**COMPOSITE SUPPLY CUM ERECTION OF
ELECTRICAL & INSTRUMENTATION WORKS FOR
OSBL FACILITIES ON ITEM RATE BASIS
AT
TALCHER FERTILIZERS LIMITED, ANGUL, ODISHA**

PC-183/ E-8003/ S-II	0
DOC. NO.	REV.
Page 10 of 10	



Annexure-1 to Appendix-I

**POLICY FOR PROVIDING PREFERENCE TO DOMESTICALLY MANUFACTURED IRON
& STEEL PRODUCTS IN GOVERNMENT PROCUREMENT (TO BE SUBMITTED ON
BIDDER'S LETTERHEAD) SELF-CERTIFICATE**

To,
M/s Talcher Fertilizers Limited

SUB:
TENDER NO:

Dear Sir,

This has reference to "Policy for providing Preference to Domestically Manufactured Iron & Steel Products in Government Procurement" issued by Ministry of Steel, Govt. of India, vide their revised notification "The Gazette of India, Notification No. 385 (E) dated 29.05.2019".

We confirm that we will obtain Affidavit of Self Certification of Domestic value addition in Iron & Steel Products from manufacturer before supply of iron and steel products required under the tender/bidding document.

Sign & Stamp of bidder

Date of Issue: 9th March'23

APPENDIX-II (COMMERCIAL BID ANALYSIS (CBA) - WORKS)		
TENDER SUBJECT		
TENDER DOCUMENT NUMBER & DESCRIPTION:		
S.NO.	NAME OF BIDDER	M/s.
1.0 PARTICULARS		
1.1	ADDRESS OF REGISTERED OFFICE	
1.2	ADDRESS WHERE CONTRACT TO BE PLACED	
1.3	ADDRESS FROM WHERE SERVICES ARE TO BE RENDRED ALONG WITH GST REGISTRATION NO.	ADDRESS: GST NO:
1.4	PHONE NO.	
1.5	E-MAIL	
1.6	NAME, DESIGNATION & CONTACT DETAILS OF CONTACT PERSON AS PER FORM F-3 (LETTER OF AUTHORITY)	
1.7	OFFER NUMBER & DATE	
1.8.1	STATUS OF BIDDER (MSE or Others) In case of MSE, specify the type of MSE i.e. Micro-SC/ST/WOMEN/others OR Small-SC/ST/WOMEN/others	
1.8.2	In case of MSE, submitted Udyam Registration Certificate duly certified by Chartered Accountant and Notary Public with Legible stamp	Submitted/ Not Submitted
1.9.1	STATUS OF BIDDER (Start-Up / Non-Start-up) Specify the type of bidder along with documents submitted.	
1.9.2	In case of Start-Up, submitted relevant documents duly certified by Chartered Accountant and Notary Public with Legible stamp	Submitted/ Not Submitted
2.0 EMD DETAILS (WHEREVER APPLICABLE)		
2.1	Item/ Section/ Group / Part Quoted	
2.2	Required EMD for Quoted Items	
2.3	EMD Amount submitted by the bidder	
2.4	Details of EMD / Bid Security	specify DD/ BG No, DD/BG date, issuing bank, DD/BG validity
2.5	Net Worth Letter for Bank regarding Net Worth >100 Crores (If Applicable)	Submitted/ Not Submitted with appropriate comments (if any)
3.0 BEC FINANCIAL		
3.1	The minimum Annual Turnover , of the Bidder as per their audited financial results in any one of the immediately three preceding financial years shall be as under:- 1 Item/ Section/ Group / Part _____, 2 Items/ Sections/ Groups / Parts _____, 3 Items/ Sections/ Groups / Parts _____ etc.	
3.1.1	Item/ Section/ Group / Part Quoted	
3.1.2	Required Turnover for Quoted Item/ Section/ Group / Part	
3.1.3	Turnover of the bidder	FY ____-____=INR/USD/Euro ____ FY ____-____=INR/USD/Euro ____ FY ____-____=INR/USD/Euro ____
3.2	2. Net worth ; Net worth of the Bidder shall be positive as per the last audited financial statement.	Positive/ Negative (Enter the net worth as per Form F-10.)
3.3	3. Working capital ; The minimum working capital of the Bidder as per the last audited financial statement shall be as under: 1 item _____, 2 items _____, 3 items _____ etc. Note: If the bidder's working capital is inadequate, the bidder should supplement this with a letter from the bidder's bank, having net worth not less than Rs.100 Crores (or equivalent in USD), as per provisions of Tender Document.	
3.3.1	Item/ Section/ Group / Part Quoted	
3.3.2	Required Working Capital for Quoted Items	
3.3.3	Working capital of the bidder as per the last audited financial year	INR /US \$/ Euro/ home currency _____ as per FY _____ (refer Form F-10)
3.3.4	Deficiency of Working Capital Amount, if any	Yes/No (specify amount (if any))
3.3.5	Working Capital letter from the bank as per Format F-9	Details of the letter (Amount, Bank, date etc.)
3.4	Submitted copy of Audited Annual Financial Statement [including Auditor's Report, Balance Sheets, Profit and Loss Accounts statements, Notes & schedules etc.] of three (3) preceding Financial Year(s) . Copy of the audited annual financial statements shall be duly certified / attested by Notary Public with legible stamp.	Submitted / Not Submitted with appropriate remarks (if any)
4.0 FORMS & FORMATS		
4.1	FORMAT F-1: BIDDER'S GENERAL INFORMATION	Submitted/ Not Submitted

TENDER DOCUMENT NUMBER & DESCRIPTION::		
S.NO.	NAME OF BIDDER	M/s.
1.0	PARTICULARS	
4.1.1	Status of Firm/ Company: Proprietorship Firm / Partnership Firm/ Company (Private or public) (As per Format F-1)	
4.1.2	Name of Proprietor/Partners/Directors (As per Format F-1)	
4.1.3	PAN No. (As per Format F-1)	
4.1.4	GST Registration No. (As per Format F-1)	
4.1.5	EPF Registration No.	
4.1.6	ESI code No.	
4.2	FORMAT F-2A:DECLARATION FOR BID SECURITY [applicable for bidders who are exempted from submission of EMD/Bid Security]	Submitted/ Not Submitted with appropriate comments (if any)
4.3	FORMAT F-3 LETTER OF AUTHORITY [ON LETTER HEAD]	Submitted/ Not Submitted
4.4	FORMAT-F-5: AGREED TERMS & CONDITIONS (ATC)	Submitted/ Not Submitted
4.4.1	Acceptance of Bid validity	Accepted/ Not Accepted
4.4.2	Acceptance of payment terms	Accepted/ Not Accepted
4.4.3	Acceptance of Contract Performance Security	Accepted/ Not Accepted
4.4.4	Acceptance of Completion Schedule	Accepted/ Not Accepted
4.4.5	Acceptance of Price Reduction Schedule	Accepted/ Not Accepted
4.4.6	Whether bidder is liable to raise E-Invoice as per GST Act.	Yes/No
4.4.7	If yes, bidder will raise E-Invoice and confirm compliance to provision of tender in this regard.	Accepted/ Not Accepted
4.4.8	Whether in the instant tender services/works are covered in reverse charge rule of GST (CGST & SGST/UTGST or IGST)	Yes/No
4.4.9	If yes, Bidder confirms that they have quoted rate of applicable GST (CGST & SGST/UTGST or IGST) in Price Schedule / Schedule of Rates of Price Bid	Confirmed / Not Confirmed
4.5	FORMAT F-9: CERTIFICATE FROM BANK IF BIDDER'S WORKING CAPITAL IS INADEQUATE/NEGATIVE	Submitted/ Not Submitted with appropriate comments (if any)
4.6	FORMAT F-10: FORMAT FOR CHARTERED ACCOUNTANT CERTIFICATE FOR FINANCIAL CAPABILITY OF THE BIDDER	Submitted/ Not Submitted
4.7	FORMAT F-13: E-BANKING MANDATE FORM	Submitted/ Not Submitted with appropriate comments (if any)
4.8	FORMAT-F-14: IIF APPLICABLE] INTEGRITY PACT (ON PLAIN PAPER)	Submitted/ Not Submitted
4.9	FORMAT-F-18: IIF APPLICABLE] SELF-CERTIFICATE TOWARDS POLICY FOR PROVIDING PREFERENCE TO DOMESTICALLY MANUFACTURED IRON & STEEL PRODUCTS IN GOVERNMENT PROCUREMENT	Submitted/ Not Submitted with appropriate comments (if any)
5.0	POWER OF ATTORNEY & NAME OF PERSON	Specify the complete details of the Power of Attorney (like POA is submitted in the name of Mr.....authorized through Board Resolution dated.....)]
5.1	NAME OF DIGITAL SIGNATORY	
6.0	IBID DOCUMENT / GCC / REPLY TO BIDDERS QUERIES / PRICE SCHEDULE (WITH PRICES BLANKED OUT)	
6.1	ACCEPTANCE & SUBMISSION OF COMPLETE BID DOCUMENT WITH IFB, ITB, FORMS & FORMATS, GCC, VENDOR PERFORMANCE ETC.	Accepted/ Not Accepted AND Submitted/Not Submitted
6.2	ACCEPTANCE & SUBMISSION OF REPLY TO BIDDER QUERIES	Accepted/ Not Accepted AND Submitted/Not Submitted
6.3	ACCEPTANCE & SUBMISSION OF CORRIGENDUM	Accepted/ Not Accepted AND Submitted/Not Submitted
6.4	SUBMISSION OF COPY OF "SCHEDULE OF RATES" WITH PRICES BLANKED OUT	Submitted/Not Submitted
6.5	Name of the bidder is not appearing in Holiday/ Banning list as per provisions of tender	Yes/No
7.0	LAND BORDER SHARING	
7.1	submission of certificate as Form-I to Section-II w.r.t. Provisions of 'Procurement from a Bidder which shares a land border with India'	Submitted/Not Submitted Not from such Country OR from such country
8.0	PPP-MII POLICY	
8.1	Undertaking as per Form 2 of Annexure-V to Section-III and certificate from Statutory Auditor or Cost Auditor (in the case of companies) or from a practicing cost accountant or practicing chartered accountant (in respect of other than companies) as per Form 3 of Annexure-V to Section-III have been submitted.	Submitted/Not Submitted
8.2	Class-I Local supplier or Class-II Local Supplier	
9.0	ADDITIONAL CLAUSES, IF ANY (*)	
9.1	
9.2	
9.3	
9.4	
9.5	
10.0	REMARKS	

TENDER DOCUMENT NUMBER & DESCRIPTION::	
S.NO.	NAME OF BIDDER
	M/s.
1.0	PARTICULARS
	<i>(*) Dealing Officers may add additional clauses, if any, based on requirement of specific tender document.</i>
	Note: In case of contradiction between the confirmations provided in this format and to confirmations provided in the bid, the confirmations provided in the bid shall prevail.



PROJECTS & DEVELOPMENT INDIA LIMITED

PC-183/ E-8003/ S-III

0

DOC. NO.

REV.

Page 1 of 142





SECTION-III

INSTRUCTION TO BIDDERS

[TO BE READ IN CONJUNCTION WITH BIDDING DATA SHEET (BDS)]

Date of Issue: 9th March'23

	COMPOSITE SUPPLY CUM ERECTION OF ELECTRICAL & INSTRUMENTATION WORKS FOR OSBL FACILITIES ON ITEM RATE BASIS AT TALCHER FERTILIZERS LIMITED, ANGUL, ODISHA	PC-183/ E-8003/ S-III	0	
		DOC. NO.	REV.	
		Page 2 of 142		

SECTION-III

INSTRUCTION TO BIDDERS

INDEX

[A] GENERAL:

1. SCOPE OF BID
2. ELIGIBLE BIDDERS
3. BIDS FROM CONSORTIUM
4. ONE BID PER BIDDER
5. COST OF BIDDING
6. SITE-VISIT

[B] BIDDING DOCUMENTS:

7. CONTENTS OF BIDDING DOCUMENTS
8. CLARIFICATION OF TENDER DOCUMENTS
9. AMENDMENT OF BIDDING DOCUMENTS

[C] PREPARATION OF BIDS:

10. LANGUAGE OF BID
11. DOCUMENTS COMPRISING THE BID
12. BID PRICES
13. GST (CGST & SGST/ UTGST or IGST)
14. BID CURRENCIES
15. BID VALIDITY
16. EARNEST MONEY DEPOSIT/BID SECURITY
17. PRE-BID MEETING
18. FORMAT AND SIGNING OF BID
19. ZERO DEVIATION & REJECTION CRITERIA
20. E-PAYMENT



[D] SUBMISSION OF BIDS:

21. SUBMISSION, SEALING AND MARKING OF BIDS
22. DEADLINE FOR SUBMISSION OF BIDS
23. LATE BIDS
24. MODIFICATION AND WITHDRAWAL OF BIDS

[E] BID OPENING AND EVALUATION:

25. EMPLOYER'S RIGHT TO ACCEPT ANY BID AND TO REJECT ANY OR ALL BIDS
26. BID OPENING

Date of Issue: 9th March'23



	COMPOSITE SUPPLY CUM ERECTION OF ELECTRICAL & INSTRUMENTATION WORKS FOR OSBL FACILITIES ON ITEM RATE BASIS AT TALCHER FERTILIZERS LIMITED, ANGUL, ODISHA	PC-183/ E-8003/ S-III	0	
		DOC. NO.	REV.	
		Page 3 of 142		

27. CONFIDENTIALITY
28. CONTACTING THE EMPLOYER
29. EXAMINATION OF BIDS AND DETERMINATION OF RESPONSIVENESS
30. CORRECTION OF ERRORS
31. CONVERSION TO SINGLE CURRENCY FOR COMPARISON OF BIDS
32. EVALUATION AND COMPARISON OF BIDS
33. COMPENSATION FOR EXTENDED STAY
34. PURCHASE PREFERENCE

[F] AWARD OF CONTRACT:

35. AWARD
36. NOTIFICATION OF AWARD / FAX OF ACCEPTANCE [FOA]
37. SIGNING OF AGREEMENT
38. CONTRACT PERFORMANCE SECURITY / SECURITY DEPOSIT
39. PROCEDURE FOR ACTION IN CASE CORRUPT/ FRAUDULENT / COLLUSIVE / COERCIVE PRACTICES
40. PUBLIC PROCUREMENT POLICY FOR MICRO AND SMALL ENTERPRISE
41. AHR ITEMS
42. VENDOR EVALUATION
43. INCOME TAX & CORPORATE TAX
44. DISPUTE RESOLUTION MECHANISM
45. DISPUTES BETWEEN CPSE'S/GOVERNMENT DEPARTMENT'S/ ORGANIZATIONS
46. INAM-PRO (PLATFORM FOR INFRASTRUCTURE AND MATERIALS PROVIDERS)
47. PROMOTION OF PAYMENT THROUGH CARDS AND DIGITAL MEANS
48. CONTRACTOR TO ENGAGE CONTRACT MANPOWER BELONGING TO SCHEDULED CASTES AND WEAKER SECTIONS OF THE SOCIETY
49. ~~PROVISIONS FOR STARTUPS (AS DEFINED IN GAZETTE NOTIFICATION NO. D.L-33004/99 DATED 18.02.2016 AND 23.05.2017 OF MINISTRY OF COMMERCE AND INDUSTRY AND AS AMENDED FROM TIME TO TIME)~~
50. PROVISION REGARDING INVOICE FOR REDUCED VALUE OR CREDIT NOTE TOWARDS PRS.
51. UNIQUE DOCUMENT IDENTIFICATION NUMBER BY PRACTICING CHARTERED ACCOUNTANTS POLICY
52. DOCUMENTS FOR PAYMENT
53. SUBLETTING AND ASSIGNMENT



Date of Issue: 9th March'23

	COMPOSITE SUPPLY CUM ERECTION OF ELECTRICAL & INSTRUMENTATION WORKS FOR OSBL FACILITIES ON ITEM RATE BASIS AT TALCHER FERTILIZERS LIMITED, ANGUL, ODISHA	PC-183/ E-8003/ S-III	0	
		DOC. NO.	REV.	
		Page 4 of 142		

[G] ANNEXURES:

1. Annexure-I:PROCEDURE FOR ACTION IN CASE CORRUPT/FRAUDULENT/
COLLUSIVE/ COERCIVE PRACTICES
2. Annexure-II: VENDOR PERFORMANCE EVALUATION PROCEDURE:
: ANNEXURE-1: Performance Rating Data Sheet
: ANNEXURE-2: Performance Rating Data Sheet
3. Annexure-III : INSTRUCTION FOR SUBMISSION OF BID ONLINE THROUGH CPP
PORTAL
4. Annexure-IV: BIDDING DATA SHEET (BDS)
5. Annexure-V: PUBLIC PROCUREMENT (PREFERENCE TO MAKE IN INDIA),
ORDER 2017
: **FORM-I OF ANNEXURE-V:** Certificate by Statutory Auditor/Cost Auditor/
Chartered Accountant of Bidder towards Mandatory Minimum Local
Content/ Domestic Value Addition (Applicable for all Bidders Including
MSEs)
: **FORM-II OF ANNEXURE-V:** Salient Points of Public Procurement
(Preference to Make in India) Policy
6. Annexure-VI: PREAMBLE TO SCHEDULE OF RATES
7. Annexure-VII:PROVISION FOR PROCUREMENT FROM A BIDDER WHICH SHARES A
LAND BORDER WITH INDIA
: **Form-I to Annexure-VII:** Undertaking on Letter Head

Date of Issue: 9th March'23

	COMPOSITE SUPPLY CUM ERECTION OF ELECTRICAL & INSTRUMENTATION WORKS FOR OSBL FACILITIES ON ITEM RATE BASIS AT TALCHER FERTILIZERS LIMITED, ANGUL, ODISHA	PC-183/ E-8003/ S-III	0	
		DOC. NO.	REV.	
		Page 5 of 142		

INSTRUCTION TO BIDDERS [ITB]
(TO BE READ IN CONJUNCTION WITH BIDDING DATA SHEET (BDS))

[A] – GENERAL

1 SCOPE OF BID

- 1.1 The Employer as defined in the "General Conditions of Contract [GCC]", wishes to receive Bids as described in the Invitation For Bid (the "**Tender Document /Bid Document**") issued by Employer.. Employer/Owner/TFL occurring herein under shall be considered synonymous.
- 1.1 SCOPE OF BID: The scope of work/ Services shall be as defined in Section-VI of the Tender documents.
- 1.2 The successful bidder will be expected to complete the scope of Bid within the period stated in Special Conditions of Contract.
- 1.3 Throughout the Tender Documents, the terms 'Bid', 'Tender' & 'Offer' and their derivatives [Bidder/Tenderer, Bid/Tender/Offer etc.] are synonymous. Further, 'Day' means 'Calendar Day' and 'Singular' also means 'Plural'.



2 ELIGIBLE BIDDERS

- 2.1 Provision for procurement from a bidder which shares a land border with India has been attached as **Annexure-VII** herewith.
- 2.2 The Bidder shall not be under a declaration of ineligibility by Employer for Corrupt/ Fraudulent/ Collusive/ Coercive practices, as defined in "Instructions to Bidders [ITB], Clause No. 39" (Action in case Corrupt/ Fraudulent/ Collusive/ Coercive Practices).
- 2.3 The Bidder is not put on 'Holiday' by TFL or any of the JV partner of OWNER (viz. GAIL, RCF, CIL) or Public-Sector Project Management Consultant (like PDIL,EIL, MECON only due to "poor performance" or "corrupt and fraudulent practices") or banned/blacklisted by Government department/ Public Sector on due date of submission of bid.. Further, neither bidder nor their allied agency/(ies) (as defined in the Procedure for Action in case of Corrupt/Fraudulent/Collusive/ Coercive Practices)are on banning list of TFL or any of the JV partner of OWNER viz. GAIL, RCF, CIL.

If the Bidding documents were issued inadvertently/ downloaded from website, offers submitted by such bidders shall not be considered for opening/ evaluation/Award and will be returned immediately to such bidders.

In case there is any change in status of the declaration prior to award of contract, the same has to be promptly informed to TFL/PDIL by the bidder.

Date of Issue: 9th March'23

	COMPOSITE SUPPLY CUM ERECTION OF ELECTRICAL & INSTRUMENTATION WORKS FOR OSBL FACILITIES ON ITEM RATE BASIS AT TALCHER FERTILIZERS LIMITED, ANGUL, ODISHA	PC-183/ E-8003/ S-III	0	
		DOC. NO.	REV.	
		Page 6 of 142		

It shall be the sole responsibility of the bidder to inform about their status regarding para 1 of clause 2.2 herein above on due date of submission of bid and during the course of finalization of the tender. Concealment of the facts shall tantamount to misrepresentation of facts and shall lead to action against such Bidders as per clause 39 of ITB.

- 2.4 The Bidder should not be under any liquidation court receivership or similar proceedings on due date of submission of bid. In case there is any change in status of the declaration prior to award of contract, the same has to be promptly informed to TFL/PDIL by the bidder.

It shall be the sole responsibility of the bidder to inform TFL there status on above on due date of submission of bid and during the course of finalization of the tender. Concealment of the facts shall tantamount to misrepresentation of facts and shall lead to action against such Bidders as per clause no. 39 of ITB.

- 2.5 Bidder shall not be affiliated with a firm or entity:

- (i) that has provided consulting services related to the work to the Employer during the preparatory stages of the work or of the project of which the works/services forms a part of or
- (ii) that has been hired (proposed to be hired) by the Employer as an Engineer/ Consultant for the contract.

- 2.6 Neither the firm/entity appointed as the Project Management Consultant (PMC) for a contract nor its affiliates/ JV'S/ Subsidiaries shall be allowed to participate in the tendering process unless it is the sole Licensor/Licensor nominated agent/ vendor.

- 2.7 Pursuant to qualification criteria set forth in the bidding document, the Bidder shall furnish all necessary supporting documentary evidence to establish Bidder's claim of meeting qualification criteria.



- 2.8 **Power of Attorney:**

Power of Attorney (PoA) to be issued by the bidder in favour of the authorised employee(s), in respect of the particular tender, for purpose of signing the documents including bid, all subsequent communications, agreements, documents etc. pertaining to the tender and act and take any and all decision on behalf of the bidder (including Consortium). Any consequence resulting due to such signing shall be binding on the Bidder (including Consortium).

- (I) In case of a Single Bidder, the Power of Attorney shall be issued as per the constitution of the bidder as below:

- a) **In case of Proprietorship:** By Proprietor

Date of Issue: 9th March'23

	COMPOSITE SUPPLY CUM ERECTION OF ELECTRICAL & INSTRUMENTATION WORKS FOR OSBL FACILITIES ON ITEM RATE BASIS AT TALCHER FERTILIZERS LIMITED, ANGUL, ODISHA	PC-183/ E-8003/ S-III	0	
		DOC. NO.	REV.	
		Page 7 of 142		

- b) **In case of Partnership:** by all Partners or Managing Partner.
- c) **In case of Limited Liability Partnership:** by any bidder's employee authorized in terms of Deed of LLP.
- d) **In case of Public /Limited Company:** PoA in favour of authorized employee(s) by Board of Directors through Board Resolution or by the designated officer authorized by Board to do so. Such Board Resolution should be duly countersigned by Company Secretary / MD / CMD / CEO.

The Power of Attorney should be valid till award of contract/order to successful bidder.

- (II) In case of a Consortium, Power of Attorney shall be issued both by Leader as well as Consortium Member(s) of the Consortium as per procedure defined herein above in favour of employee of Leader of Consortium.



3 BIDS FROM "CONSORTIUM"

Not applicable.

4 ONE BID PER BIDDER

- 4.1 A Bidder shall submit only 'one [01] Bid' in the same Bidding Process either as single entity or as a member of any consortium (wherever consortium bid is allowed). A Bidder who submits or participates in more than 'one [01] Bid' will cause all the proposals in which the Bidder has participated to be disqualified.
- 4.2 A bidder shall not have conflict of interest with other bidders. Such conflict of interest can lead to anti-competitive practices. The bidder found to have a conflict of interest shall be disqualified. A bidder shall be considered to have a conflict of interest with one or more bidders in this bidding process, if:
 - a) they have controlling partner (s) in common; or
 - b) they receive or have received any direct or indirect subsidy/ financial stake from any of them; or
 - c) they have the same legal representative/authorized signatory/agent for purposes of this bid; or
 - d) they have relationship with each other, directly or through common third parties, that puts them in a position to have access to information about or influence on the bid of another Bidder; or
 - e) Bidder participates in more than one bid in bidding process. Participation by a Bidder in more than one Bid will result in the disqualification of all bids in which the parties are involved. However, this does not limit the inclusion of the components/ sub-assembly/ Assemblies from one bidding manufacturer in more than one bid.
 - f) a Bidder or any of its affiliates participated as a consultant in the preparation of the design or technical specifications of the contract that is the subject of the Bid;
 - g) In case of a holding company having more than one independently manufacturing units, or more than one unit having common business ownership/management, only one unit should quote. Similar restrictions would apply to closely related sister companies. Bidders must

Date of Issue: 9th March'23

	COMPOSITE SUPPLY CUM ERECTION OF ELECTRICAL & INSTRUMENTATION WORKS FOR OSBL FACILITIES ON ITEM RATE BASIS AT TALCHER FERTILIZERS LIMITED, ANGUL, ODISHA	PC-183/ E-8003/ S-III	0	
		DOC. NO.	REV.	
		Page 8 of 142		

proactively declare such sister/ common business/ management units in same/ similar line of business.

Bidders are required to submit a confirmation for no conflict of interest with other bidders in Format F-5.

Failure to comply this clause during tendering process will disqualify all such bidders from process of evaluation of bids.

4.3 Alternative Bids shall not be considered.

4.4 The provisions mentioned at sl. no. 4.1 and 4.2 shall not be applicable wherein bidders are quoting for different Items / Sections / Parts / Groups/ SOR items of the same tender which specifies evaluation on Items / Sections / Parts / Groups/ SOR items basis.

5 COST OF BIDDING

The Bidder shall bear all costs associated with the preparation and submission of the Bid including but not limited to Documentation Charges, Bank charges all courier charges translation charges, authentication charges and any associated charges including taxes & duties thereon. Further, TFL/PDIL will in no case, be responsible or liable for these costs, regardless of the outcome of the bidding process.

6 SITE VISIT

6.1 The Bidder is advised to visit and examine the site of works and its surroundings and obtain for itself on its own responsibility all information that may be necessary for preparing the Bid and entering into a Contract for the required job. The costs of visiting the site shall be borne by the Bidder.



6.2 The Bidder or any of its personnel or agents shall be granted permission by the Employer to enter upon its premises and land for the purpose of such visits, but only upon the express conditions that the Bidder, its personnel and agents will release and indemnify the Employer and its personnel, agents from and against all liabilities in respect thereof, and will be responsible for death or injury, loss or damage to property, and any other loss, damage, costs, and expenses incurred as a result of inspection.

6.3 The Bidder shall not be entitled to hold any claim against TALCHER FERTILIZERS LIMITED for non-compliance due to lack of any kind of pre-requisite information as it is the sole responsibility of the Bidder to obtain all the necessary information with regard to site, surrounding, working conditions, weather etc. on its own before submission of the bid.

[B] –BIDDING DOCUMENTS

CONTENTS OF BIDDING DOCUMENTS

Date of Issue: 9th March'23

	COMPOSITE SUPPLY CUM ERECTION OF ELECTRICAL & INSTRUMENTATION WORKS FOR OSBL FACILITIES ON ITEM RATE BASIS AT TALCHER FERTILIZERS LIMITED, ANGUL, ODISHA	PC-183/ E-8003/ S-III	0	
		DOC. NO.	REV.	
		Page 9 of 142		

7.1 The contents of Bidding Documents /Tender documents are those stated below, and should be read in conjunction with any 'Addendum / Corrigendum and Clarification(s)' issued in accordance with "ITB: Clause-8 & 9":

- Section-I : Invitation for Bid [IFB]
- Section-II : BID EVALUATION CRITERIA [BEC] & Evaluation methodology
- Section-III : Instructions to Bidders [ITB], Annexure, Forms & Formats
- Section-IV : General Conditions of Contract [GCC]
- Section-V : Special Conditions of Contract [SCC]
- Section-VI : Scope of Work & Technical Specifications
- Section-VII : Price Schedule/ Schedule of Rates

*'Request for Quotation', wherever applicable, shall also form part of the Bidding document.

For participation in e-tender, instructions are mentioned at Annexure-III to Section-III.

7.2 The Bidder is expected to examine all instructions, forms, terms & conditions in the Bidding Documents. The "Request for Quotation [RFQ] & Invitation for Bid (IFB)" together with all its attachments thereto, shall be considered to be read, understood and accepted by the Bidders. Failure to furnish all information required by the Bidding Documents or submission of a Bid not substantially responsive to the Bidding Documents in every respect will be at Bidder's risk and may result in the rejection of his Bid.

7 CLARIFICATION OF TENDER DOCUMENTS



8.1 A prospective Bidder requiring any clarification(s) of the Bidding Documents may notify TFL in writing or through CPP Portal (<https://eprocure.gov.in/eprocure/app>) or email at PDIL's mailing address indicated in the BDS no later than 02 (two) days prior to pre-bid meeting (in cases where pre-bid meeting is scheduled) or 05 (five) days prior to the due date of submission of bid in cases where pre-bid meeting is not scheduled. TFL/PDIL reserves the right to ignore the bidders request for clarification if received after the aforesaid period. TFL/PDIL may respond in writing to the request for clarification. TFL/PDIL's response including an explanation of the query, but without identifying the source of the query will be uploaded on the websites mentioned at Clause No. 2.0 (G) of IFB. Hence, bidders are requested to regularly visit the said websites for updates.

8.2 Any clarification or information required by the Bidder but same not received by the Employer at clause 8.1 (refer BDS for address) above is liable to be considered as "no clarification / information required".

8 AMENDMENT OF BIDDING DOCUMENTS

9.1 At any time prior to the 'Bid Due Date', Employer for any reason, whether at its own initiative or in response to a clarification requested by a prospective Bidder, modify the Bidding Documents by addenda / corrigendum.

Date of Issue: 9th March'23

	COMPOSITE SUPPLY CUM ERECTION OF ELECTRICAL & INSTRUMENTATION WORKS FOR OSBL FACILITIES ON ITEM RATE BASIS AT TALCHER FERTILIZERS LIMITED, ANGUL, ODISHA	PC-183/ E-8003/ S-III	0	
		DOC. NO.	REV.	
		Page 10 of 142		

- 9.2 Any corrigendum thus issued shall be integral part of the Tender Document and shall be hosted only on the websites as provided at clause no. 2.0 (H) of IFB. Bidders, in their own interest, are advised to regularly check the websites for any amendment/Corrigendum/Addendum. Bidders have to take into account all such amendment / corrigendum before submitting their Bid. TFL/PDIL will not take any responsibility or entertain any representation whatsoever, in case bidders have not checked/seen/downloaded such amendment/Corrigendum/Addendum or reply to pre-bid queries uploaded on the said websites.
- 9.3 The Employer, if it considers necessary, may extend the Bid Due Date in order to allow the Bidders a reasonable time to furnish their most competitive bid taking into account the addenda / corrigendum issued thereof.

[C] – PREPARATION OF BIDS

10 LANGUAGE OF BID:

The bid prepared by the Bidder and all correspondence, drawing(s), document(s), certificate(s) etc. relating to the Bid exchanged by Bidder and TFL shall be written in English language only. In case a document, certificate, printed literature etc. furnished by the Bidder in a language other than English, the same should be accompanied by an English translation duly authenticated by the Indian Chamber of Commerce, in which case, for the purpose of interpretation of the Bid, the English translation shall govern.



11. DOCUMENTS COMPRISING THE BID

- 11.1 Bidders are requested to refer instructions for participating in e-Tendering (Annexure-I to Section III), Ready Reckoner for Bidders and FAQs available in e-portal and bids submitted manually shall be rejected. All pages of the Bid must be digitally signed by the "authorized signatory" of the Bidder holding Power of Attorney. The bids must be submitted on e-tendering website of CPP portal (<https://eprocure.gov.in/eprocure/app>) comprising following documents:-

11.1.1 **PART-I: "TECHNO-COMMERCIAL / UN-PRICED BID"** shall contain the following:

- (a) 'Covering Letter' on Bidder's 'Letterhead' clearly specifying the enclosed Contents with index.
- (b) 'Bidder's General Information', as per 'Form F-1'.
- (c) Copies of documents, as specified in tender document
- (d) Copy of Schedule of Rate (SOR) with prices blanked out mentioning quoted / not quoted (as applicable) written against each item as a confirmation that the prices are quoted in requisite format.
- (e) 'Letter of Authority' on the Letter Head, as per 'Form F-3'
- (f) 'Agreed Terms and Conditions', as per 'Form F-5'

Date of Issue: 9th March'23

	COMPOSITE SUPPLY CUM ERECTION OF ELECTRICAL & INSTRUMENTATION WORKS FOR OSBL FACILITIES ON ITEM RATE BASIS AT TALCHER FERTILIZERS LIMITED, ANGUL, ODISHA	PC-183/ E-8003/ S-III	0	
		DOC. NO.	REV.	
		Page 11 of 142		

- (g) 'ACKNOWLEDGEMENT CUM CONSENT LETTER', as per 'Form F-6'
- (h) Duly attested documents in accordance with the "BID EVALUATION CRITERIA [BEC]" establishing the qualification.
- (i) Copy of Power of Attorney as per 'F-20'/copy of Board Resolution, in favour of the authorized signatory of the Bid, as per clause no. 2.8 of ITB (Original to be submitted physically).
- (j) Copy of EMD/ Copy of Declaration for Bid Security in original as per Clause 16 of ITB (Original to be submitted physically)
- (k) Certification from the statutory auditor or cost auditor of the company (in the case of companies) or from a practicing cost accountant or practicing chartered accountant (in respect of other than companies) as per Form-I to Annexure-V and Declaration by bidder towards Minimum Local Content as per Form-II of Annexure-V. **(Applicable for all bidders irrespective of seeking purchase preference or not).**
- (l) Undertaking as per Form-I to Annexure VII regarding Provisions for Procurement from a bidder which shares a land border with India.
- (m) All forms and Formats including Annexures
- (n) 'Integrity Pact' as per 'Form F-14'
- (o) 'Indemnity Bond' as per 'Form F-15'
- (p) Checklist for Bid Evaluation Criteria (BEC) qualifying documents for bidder as per 'Form F-8 & F-8B.
- (q) Tender Document, its Corrigendum/Amendment/Clarification(s) duly signed on each page (in case of manual tendering)/ digitally signed (in case of e-Tender) by the Authorized Signatory holding POA.
- (r) Additional document specified in BDS, SCC, Scope of Supply or mentioned elsewhere in the Tender Document, its Corrigendum/Amendment/Clarification(s).
- (s) Any other information/details required as per Tender Document



Note:

1. All the pages of the Bid must be signed/ digitally signed by the "Authorized Signatory" of the Bidder holding POA.

PART-II: Price Bid

- (a) The Prices are to be submitted strictly as per the Schedule of Rate of the bidding documents. TFL shall not be responsible for any failure on the part of the bidder to follow the instructions.
- (b) Bidders are advised NOT to mention Rebate/Discount separately, either in the SOR format or anywhere else in the offer. In case Bidder(s) intend to offer any Rebate/Discount, they should include the same in the item rate(s) itself under the "Schedule of Rates (SOR)" and indicate the discounted unit rate(s) only.
- (c) If any unconditional rebate has been offered in the quoted rate the same shall be considered in arriving at evaluated price. However no cognizance shall be taken for any conditional discount for the purpose of evaluation of the bids.
- (d) In case, it is observed that any of the bidder(s) has/have offered suo-moto Discount/Rebate after opening of unpriced bid but before opening of price bids

Date of Issue: 9th March'23

	COMPOSITE SUPPLY CUM ERECTION OF ELECTRICAL & INSTRUMENTATION WORKS FOR OSBL FACILITIES ON ITEM RATE BASIS AT TALCHER FERTILIZERS LIMITED, ANGUL, ODISHA	PC-183/ E-8003/ S-III	0	
		DOC. NO.	REV.	
		Page 12 of 142		

such discount /rebate(s) shall not be considered for evaluation. However, in the event of the bidder emerging as the lowest evaluated bidder without considering the discount/rebate(s), then such discount/rebate(s) offered by the bidder shall be considered for Award of Work and the same will be conclusive and binding on the bidder.

- (e) In the event as a result of techno-commercial discussions or pursuant to seeking clarifications / confirmations from bidders, while evaluating the un-priced part of the bid, any of the bidders submits a sealed envelope stating that it contains revised prices; such bidder(s) will be requested to withdraw the revised prices failing which the bid will not be considered for further evaluation.

11.1.2 PART-II: Price Bid

The Prices are to be filled strictly in the Schedule of Rate of the bidding documents and provision mentioned at para 11.1.2 hereinabove and to uploaded in SOR attachment/Conditions of CPP portal.

- 11.2.1 **PART-I: “TECHNO-COMMERCIAL/UN-PRICED BID”** comprising all the above documents mentioned at 11.1.1 along with copy of EMD/Bid Security/Declaration for Bid Security, copy of Power of Attorney and copy of integrity pact should be uploaded in the technical bid in the e-tender portal.



Further, Bidders must submit the original " EMD, Power of Attorney, Integrity Pact (wherever applicable) and any other documents specified in the Tender Document to the address mentioned in IFB, in a sealed envelope, superscribing the details of Tender Document (i.e. tender number & tender for) within 7 days from the date of un-priced bid opening.

Bidders are required to submit the EMD in original by Due Date and Time of Bid Submission or upload a scanned copy of the same in the Part-I of the Bid. If the Bidder is unable to submit EMD in original by Due Date and Time of Bid Submission, the Bidder is required to upload a scanned copy of the EMD in Part-I of Bid, provided the original EMD, copy of which has been uploaded, is received within 7 days from the Due Date of Bid Opening, failing which the Bid will be rejected irrespective of their status/ranking in tendering process and notwithstanding the fact that a copy of EMD was earlier uploaded by the Bidder.

12 BID PRICES

- 12.1 Unless stated otherwise in the Bidding Documents, the Contract shall be for the whole works as described in Bidding Documents, based on the rates and prices submitted by the Bidder and accepted by the Employer.

Date of Issue: 9th March'23

	COMPOSITE SUPPLY CUM ERECTION OF ELECTRICAL & INSTRUMENTATION WORKS FOR OSBL FACILITIES ON ITEM RATE BASIS AT TALCHER FERTILIZERS LIMITED, ANGUL, ODISHA	PC-183/ E-8003/ S-III	0	
		DOC. NO.	REV.	
		Page 13 of 142		

- 12.2 Prices must be filled in format for "Schedule of Rates [SOR]" enclosed as part of Tender document. If quoted in separate typed sheets and any variation in item description, unit or quantity is noticed; the Bid is liable to be rejected.
- 12.3 Bidder shall quote for all the items of "SOR" after careful analysis of cost involved for the performance of the completed item considering all parts of the Bidding Document. In case any activity though specifically not covered in description of item under "SOR" but is required to complete the works as per Specifications, Scope of Work / Service, Standards, General Conditions of Contract ("GCC"), Special Conditions of Contract ("SCC") or any other part of Bidding Document, the prices quoted shall deemed to be inclusive of cost incurred for such activity.
- 12.4 All duties, taxes and other levies [if any] payable by the Contractor under the Contract, or for any other cause except final **GST (CGST & SGST/ UTGST or IGST)** shall be included in the rates / prices and the total bid-price submitted by the Bidder.
- 12.5 Prices quoted by the Bidder, shall remain firm and fixed and valid till completion of the Contract and will not be subject to variation on any account unless any price escalation/variation is allowed elsewhere in Tender Document.
- 12.6 Deleted
- 12.7 Bidder shall also mention the **Service Accounting Codes (SAC) / Harmonized System of Nomenclature (HSN)** at the designated place in Form F-5.



13 GST (CGST & SGST/ UTGST or IGST)

- 13.1 Bidders are required to submit a copy of the GST Registration Certificate, while submitting the bids wherever **GST (CGST & SGST/UTGST or IGST)** is applicable
- 13.2 Please note that the responsibility of payment of **GST (CGST & SGST or IGST or UTGST)** lies with the Contractor only. Contractor providing taxable service shall issue an e- Invoice/ Invoice / Bill, as the case may be as per rules/ regulation of GST. Further, returns and details required to be filled under GST laws & rules should be timely filed by Contractor with requisite details.

Payments to Contractor for claiming **GST (CGST & SGST/UTGST or IGST)** amount will be made provided the above formalities are fulfilled. Further, TFL may seek copies of challan and certificate from Chartered Accountant for deposit of **GST (CGST & SGST/UTGST or IGST)** collected from Owner.

- 13.3 In case CBIC (Central Board of Indirect Taxes and Customs)/ any tax authority / any equivalent Government agency brings to the notice of TFL that the Contractor has not remitted the amount towards **GST (CGST & SGST/UTGST or IGST)** collected from TFL to the government exchequer, then, that Contractor shall be put under Holiday list of TFL for period of six months after following the due procedure. This action will be in addition to the

Date of Issue: 9th March'23

	COMPOSITE SUPPLY CUM ERECTION OF ELECTRICAL & INSTRUMENTATION WORKS FOR OSBL FACILITIES ON ITEM RATE BASIS AT TALCHER FERTILIZERS LIMITED, ANGUL, ODISHA	PC-183/ E-8003/ S-III	0	
		DOC. NO.	REV.	
		Page 14 of 142		

right of recovery of financial implication arising on TFL.



- 13.4 For statutory variation in **GST (CGST & SGST/UTGST or IGST)**, please refer clause no. **48.0 of SCC (Section V of NIT)**
- 13.5 Where TFL is entitled to avail the input tax credit of **GST (CGST & SGST/UTGST or IGST)**:-
- 13.5.1 Owner/TFL will reimburse the **GST (CGST & SGST/UTGST or IGST)** to the Contractor at actuals against submission of E-Invoices/Invoices as per format specified in rules/ regulation of GST, to enable Owner/TFL to claim input tax credit of **GST (CGST & SGST/UTGST or IGST)** paid. In case of any variation in the executed quantities, the amount on which the **GST (CGST & SGST/UTGST or IGST)** is applicable shall be modified in same proportion. Returns and details required to be filled under GST laws & rules should be timely filed by supplier with requisite details.
- 13.6 Where TFL is not entitled to avail/take the full input tax credit of **GST (CGST & SGST/UTGST or IGST)**:
- 13.6.1 Owner/TFL will reimburse **GST (CGST & SGST/UTGST or IGST)** to the Contractor at actual against submission of E-Invoices/Invoices as per format specified in rules/ regulation of GST subject to the ceiling amount of **GST (CGST & SGST/UTGST or IGST)** as quoted by the bidder, subject to any statutory variations, except variations arising due to change in turnover. In case of any variation in the executed quantities (If directed and/or certified by the Engineer-In-Charge) the ceiling amount on which **GST (CGST & SGST/UTGST or IGST)** is applicable will be modified on pro-rata basis.
- 13.7 TFL will prefer to deal with registered supplier of goods/ services under GST. Therefore, bidders are requested to get themselves registered under GST, if not registered yet.

However, in case any unregistered bidder is submitting their bid, Bids will be evaluated as per quoted prices without loading of **GST (CGST & SGST/UTGST or IGST)**, if not quoted. their prices will be loaded with applicable GST (CGST & SGST/UTGST or IGST) while evaluation of bid (if applicable as per Govt. Act/ Law in vogue). Where TFL is entitled for input credit of **GST (CGST & SGST/UTGST or IGST)**, the same will be considered for evaluation of bid as per evaluation methodology of tender document. Further, an unregistered bidder is required to mention its Income Tax PAN in bid document. Further, an unregistered bidder is required to mention its Income Tax PAN in bid document.

- 13.8 In case TFL is required to pay entire/certain portion of applicable **GST (CGST & SGST/UTGST or IGST)** and remaining portion, if any, is to be deposited by Bidder directly as per **GST (CGST & SGST/UTGST or IGST)** laws, entire applicable rate/amount of **GST (CGST & SGST/UTGST or IGST)** to be indicated by bidder in the SOR.

Where TFL has the obligation to discharge **GST (CGST & SGST/UTGST or IGST)** liability under reverse charge mechanism and TFL has paid or is /liable to pay **GST (CGST &**

Date of Issue: 9th March'23

	COMPOSITE SUPPLY CUM ERECTION OF ELECTRICAL & INSTRUMENTATION WORKS FOR OSBL FACILITIES ON ITEM RATE BASIS AT TALCHER FERTILIZERS LIMITED, ANGUL, ODISHA	PC-183/ E-8003/ S-III	0	
		DOC. NO.	REV.	
		Page 15 of 142		

SGST/UTGST or IGST) to the Government on which interest or penalties becomes payable as per GST laws for any reason which is not attributable to TFL or ITC with respect to such payments is not available to TFL for any reason which is not attributable to TFL, then TFL shall be entitled to deduct/ setoff / recover such amounts against any amounts paid or payable by TFL to Contractor /Supplier..

- 13.9 Contractor shall ensure timely submission of correct invoice(s)/e-invoice(s), as per GST rules/ regulation, with all required supporting document(s) within a period specified in Contract to enable TFL to avail input credit of GST (CGST & SGST/UTGST or IGST). Further, returns and details required to be filled under GST laws & rules should be timely filed by Contractor with requisite details.

If input tax credit is not available to TFL for any reason not attributable to TFL, then TFL shall not be obligated or liable to pay or reimburse GST (CGST & SGST/UTGST or IGST) claimed in the invoice(s) and shall be entitled to deduct/ setoff/ recover such GST amount (CGST & SGST/UTGST or IGST) or Input Tax Credit amount together with penalties and interest, if any, against any amounts paid or becomes payable by TFL in future to the Contractor under this contract or under any other contract



13.10 Anti-profiteering clause

As per Clause 171 of GST Act it is mandatory to pass on the benefit due to reduction in rate of tax or from input tax credit to the consumer by way of commensurate reduction in prices. The Contractor may note the above and quote their prices accordingly.

- 13.11 In case the GST rating of Contractor on the GST portal / Govt. official website is negative / black listed, then the bids may be rejected by TFL. Further, in case rating of bidder is negative / black listed after award of work, then TFL shall not be obligated or liable to pay or reimburse GST to such Contractor and shall also be entitled to deduct / recover such GST along with all penalties / interest, if any, incurred by TFL.

- 13.12 GST (CGST & SGST/UTGST or IGST) is implemented w.e.f. 01.07.2017 which subsumed various indirect taxes and duties applicable before 01.07.2017. Accordingly, the provisions of General Condition of Contract relating to taxes and duties which are subsumed in GST are modified to aforesaid provisions mentioned in clause no. 12 and 13 of ITB.

Date of Issue: 9th March'23

	COMPOSITE SUPPLY CUM ERECTION OF ELECTRICAL & INSTRUMENTATION WORKS FOR OSBL FACILITIES ON ITEM RATE BASIS AT TALCHER FERTILIZERS LIMITED, ANGUL, ODISHA	PC-183/ E-8003/ S-III	0	
		DOC. NO.	REV.	
		Page 16 of 142		

13.13 GST, as quoted by the bidder in Schedule of Rates, shall be deemed as final and binding for the purpose of bid evaluation (applicable for tenders where bidder quotes the GST rates). In case a bidder enters “zero/blank” GST or an erroneous GST, the bid evaluation for finalizing the L1 bidder will be done considering the “Zero” or quoted GST rate GST rate, as the case may be. No request for change in GST will be entertained after submission of bids. In case GST column is left blank in the SOR, the quoted prices shall be considered as “Inclusive of GST” and evaluation shall be done accordingly.

In cases where the successful bidder quotes a wrong GST rate, for releasing the order, the following methodology will be followed:

- In case the actual GST rate applicable is lower than the quoted GST rate, the actual GST rate will be added to the quoted basic prices. The final cash outflow will be based on actual GST rate.
- In case the actual GST rate applicable is more than the quoted GST rate, the basic prices quoted will be reduced proportionately, keeping the final cash outflow the same as the overall quoted amount.

Based on the Total Cash Outflow calculated as above, TFL shall place orders.

13.14 Wherever TDS under GST Laws has been deducted from the invoices raised / payments made to the Contractors, as per the provisions of the GST law / Rules, Contractors should accept the corresponding GST-TDS amount populated in the relevant screen on GST common portal (www.gst.gov.in). Further, Vendors should also download the GST TDS certificate from GST common portal (reference path: Services>User Services> View/Download Certificates option).



13.15 **Provision w.r.t. E- Invoicing requirement as per GST laws:**

Supplier who is required to comply with the requirements of E-invoice for B2B transactions as per the requirement of GST Law will ensure the compliance of requirement of E Invoicing under GST law. If the invoice issued without following this process, such invoice can-not be processed for payment by TFL as no ITC is allowed on such invoices.

Therefore, all the payments to such supplier who is liable to comply with e-invoice as per GST Laws shall be made against the proper e-invoice(s) only. Further, returns and details required to be filled under GST laws & rules against such e-invoices should be timely filed by Supplier of Goods with requisite details.

If input tax credit is not available to TFL for any reason attributable to supplier (both for E-invoicing cases and non-E-invoicing cases), then TFL shall not be obligated or liable to pay or reimburse GST (CGST & SGST/UTGST or IGST) claimed in the invoice(s) and shall be entitled to deduct / setoff / recover such GST amount (CGST & SGST/UTGST or IGST) or Input Tax Credit amount together with penalties and interest, if any, by adjusting against any amounts paid or becomes payable in future to the contractor under this contract or

Date of Issue: 9th March'23

	COMPOSITE SUPPLY CUM ERECTION OF ELECTRICAL & INSTRUMENTATION WORKS FOR OSBL FACILITIES ON ITEM RATE BASIS AT TALCHER FERTILIZERS LIMITED, ANGUL, ODISHA	PC-183/ E-8003/ S-III	0	
		DOC. NO.	REV.	
		Page 17 of 142		

under any other supplier .

To ensure compliance, undertaking in requisite format is to be submitted by supplier as per format enclosed at Form F-21 along with documents for release of payment.

13.16 **New Taxes & duties:** Any new taxes & duties, if imposed by the State/ Central Govt. of India after the due date of bid submission but before the Contractual Completion Date, shall be reimbursed to the Service Provider on submission of copy of notification(s) issued from State/ Central Govt. Authorities along with documentary evidence for proof of payment of such taxes & duties, but only after ascertaining it's applicability with respect to the Contract.

13.17 Full payment including GST will be released at the time of processing of invoice for payment, where the GST amount reflects in Form GSTR-2A of TFL. However, in case where the GST amount doesn't reflect in Form GSTR-2A of TFL, the amount of GST will be released after reflection of GST amount of corresponding invoice in Form GSTR-2A of TFL.

14 BID CURRENCIES:

Bidders must submit bid in Indian Rupees only.

15 BID VALIDITY

15.1 Bids shall be kept valid for period specified in BDS from the Due date of Technical Bid Opening. A Bid valid for a shorter period may be rejected by TFL as 'non-responsive'.



15.2 In exceptional circumstances, prior to expiry of the original 'Bid Validity Period', the Employer may request the Bidders to extend the 'Period of Bid Validity' for a specified additional period. The request and the responses thereto shall be made in writing or by email. A Bidder may refuse the request without forfeiture of his EMD / Bid Security.

A Bidder agreeing to the request will not be required or permitted to modify his Bid, but will be required to extend the validity of its EMD for the period of the extension and in accordance with "ITB: Clause-16" in all respects.

16 EARNEST MONEY DEPOSIT

16.1 Bid must be accompanied with earnest money [i.e. **Earnest Money Deposit (EMD)**] also known as **Bid Security**] in the form of '**Demand Draft**' / '**Banker's Cheque**'/ '**Insurance Surety Bond**'/ '**Fixed Deposit Receipt**' [in favour of **TALCHER FERTILIZERS LIMITED** payable at place mentioned in **BDS**] or '**Bank Guarantee**' strictly as per the format given in form F -2A (as the case may be) of the **Tender Document**. Bidder shall ensure that EMD submitted in the form of '**Bank Guarantee**' should have a validity of at least 'two [02] months' beyond the validity of the Bid. EMD submitted in the form of '**Demand Draft**' or '**Banker's Cheque**' should be valid for three months.



Date of Issue: 9th March'23

	COMPOSITE SUPPLY CUM ERECTION OF ELECTRICAL & INSTRUMENTATION WORKS FOR OSBL FACILITIES ON ITEM RATE BASIS AT TALCHER FERTILIZERS LIMITED, ANGUL, ODISHA	PC-183/ E-8003/ S-III	0	
		DOC. NO.	REV.	
		Page 18 of 142		

Bid not accompanied with EMD, or EMD not in requisite format shall be liable for rejection. The EMD shall be submitted in Indian Rupees only.

- 16.2 The bidder can also submit the EMD through online banking transaction i.e. IMPS/NEFT/RTGS etc. For this purpose, the details of TFL's Bank Account are mentioned under BDS. While remitting, the bidder must indicate EMD and tender/E-tender no. under remarks. Bidders shall be required to submit/ upload the successful transaction details along-with their bid/e-bid in addition to forwarding the details to dealing officer through email/letter with tender reference number immediately after remittance of EMD. In absence of submitting/ uploading the remittance details, the bid is likely to be considered as bid not accompanied with EMD. Further, in case of the online transaction, submission of EMD in original is not applicable.
- 16.3 OWNER shall not be liable to pay any documentation charges, Bank charges, commission, interest etc. on the amount of EMD. In case EMD is in the form of a "Bank Guarantee", the same shall be from any Indian scheduled Bank(excluding Co-operative banks and regional Rural bank) or a branch of an International Bank situated in India and registered with "Reserve Bank of India" as Scheduled Foreign Bank. However, in case of „Bank Guarantee" from Banks other than the Nationalized Indian Banks, the Bank must be commercial Bank having networth in excess of Rs. 100 Crores [Rupees One Hundred Crores] and a declaration to this effect should be made by such commercial Bank either in the "Bank Guarantee" itself or separately on its letterhead. Purchaser will verify the BG from issuing bank.
- 16.4 Any Bid not secured in accordance with "ITB: Clause-16.1 & Clause-16.3" may be rejected by TFL as non-responsive.
- 16.5 Unsuccessful Bidder's EMD will be discharged/ returned as promptly as possible, but not later than "thirty [30] days" after finalization of tendering process.
- 16.6 The successful Bidder's EMD will be discharged upon the Bidder's acknowledging the "Award" and signing the "Agreement" (if applicable) and furnishing the Contract Performance Security (CPS)/ Security Deposit" pursuant to clause no. 38 of ITB.
- 16.7 Notwithstanding anything contained herein, the EMD may also be forfeited in any of the following cases:
- If a Bidder withdraws his Bid during the "Period of Bid Validity"
 - If a Bidder has indulged in corrupt/fraudulent /collusive/coercive practice
 - If the Bidder modifies Bid during the period of bid validity (after Due Date and Time for Bid Submission).
 - Violates any other condition, mentioned elsewhere in the Tender Document, which may lead to forfeiture of EMD.
 - ~~In case of Cartelization of bid.~~
 - In the case of a successful Bidder, if the Bidder fails to:
 - to acknowledge receipt of the "Notification of Award" / Fax of Acceptance

Date of Issue: 9th March'23

	COMPOSITE SUPPLY CUM ERECTION OF ELECTRICAL & INSTRUMENTATION WORKS FOR OSBL FACILITIES ON ITEM RATE BASIS AT TALCHER FERTILIZERS LIMITED, ANGUL, ODISHA	PC-183/ E-8003/ S-III	0	
		DOC. NO.	REV.	
		Page 19 of 142		

- (ii) [FOA] / Detailed Letter of Acceptance [DLOA]",
to furnish "Contract Performance Security / Security Deposit", in accordance with "ITB: Clause-38".
- (iii) to accept 'arithmetical corrections' as per provision of the clause 30 of ITB

- 16.8 In case EMD is in the form of „Bank Guarantee“, the same must indicate the Tender Document No. and the name of Tender Document for which the Bidder is quoting. This is essential to have proper correlation at a later date.
- 16.9 MSEs (Micro & Small Enterprises) are exempted from submission of EMD in accordance with the provisions of PPP-2012 and Clause 40 of ITB. However, Traders/Dealers/ Distributors /Stockiest /Wholesaler are not entitled for exemption of EMD. The Government Departments/PSUs are also exempted from the payment of EMD. Further, Startups are also exempted from the payment of EMD.
- 16.10 In case of forfeiture of EMD/ Bid Security, the forfeited amount will be considered inclusive of tax and tax invoice will be issued by TFL. The forfeiture amount will be subject to final decision of TFL based on other terms and conditions of order/contract.
- 16.11 EMD/Bid Bond will not be accepted in case the same has reference of 'remitter'/'financer' other than bidder on the aforementioned financial instrument of EMD/ Bid Bond submitted by the bidder and bid of such bidder will be summarily rejected.



16A DECLARATION FOR BID SECURITY

MSEs (Micro & Small Enterprises), Start-ups and CPSEs (to whom exemption is allowed as per extant guidelines in vogue) are required to submit, "DECLARATION FOR BID SECURITY" as per prescribed format (F-2B).

17 PRE-BID MEETING (IF APPLICABLE)

- 17.1 The Bidder(s) or his designated representative are invited to attend a "Pre-Bid Meeting" which will be held at address specified in IFB. It is expected that a bidder shall not depute more than 02 representatives for the meeting.
- 17.2 Purpose of the meeting will be to clarify issues and to answer questions on any matter that may be raised at that stage and give hands-on e-tendering.
- 17.3 Text of the questions raised and the responses given, together with any responses prepared after the meeting, will be uploaded on Central Public Procurement (CPP) Portal (<https://eprocure.gov.in/eprocure/app>) websites. Any modification of the Contents of Bidding Documents listed in "ITB: Clause-7.1", that may become necessary as a result of the Pre-Bid Meeting shall be made by the Employer exclusively through the issue of an Corrigendum pursuant to "ITB: Clause-9", and not through the minutes of the Pre-Bid

Date of Issue: 9th March'23

	COMPOSITE SUPPLY CUM ERECTION OF ELECTRICAL & INSTRUMENTATION WORKS FOR OSBL FACILITIES ON ITEM RATE BASIS AT TALCHER FERTILIZERS LIMITED, ANGUL, ODISHA	PC-183/ E-8003/ S-III	0	
		DOC. NO.	REV.	
		Page 20 of 142		

Meeting.

- 17.4 Non-attendance of the Pre-Bid Meeting will not be a cause for disqualification of Bidder.

18 FORMAT AND SIGNING OF BID

- 18.1 The original and all copies of the Bid shall be typed or written in indelible ink [in the case of copies, photocopies are also acceptable] and shall be signed by a person or persons duly authorized to sign on behalf of the Bidder (as per POA). The name and position held by each person signing, must be typed or printed below the signature. All pages of the Bid except for unamendable printed literature where entry(s) or amendment(s) have been made shall be initialed by the person or persons signing the Bid.
- 18.2 The Bid shall contain no alterations, omissions, or additions, unless such corrections are initialed by the person or persons signing the Bid.
- 18.3 In case of e-tendering, digitally Digitally signed documents to be uploaded as detailed in addendum to ITB (Annexure-III of Section –III).



19 ZERO DEVIATION AND REJECTION CRITERIA

- 19.1 **ZERO DEVIATION:** Deviation to terms and conditions of "Bidding Documents" may lead to rejection of bid. TFL will accept bids based on terms & conditions of "Bidding Documents" only. Bidder may note TFL will determine the substantial responsiveness of each bid to the Tender documents pursuant to provision contained in clause 29 of ITB. For purpose of this, a substantially responsive bid is one which conforms to all terms and conditions of the Bidding Documents without deviations or reservations. TFL's determination of a bid's responsiveness is based on the content of the bid itself without recourse to extrinsic evidence.

Bidder is requested not to take any deviation(s)/exception(s) to the terms & conditions of Tender Document, and submit all requisite documents as mentioned in this Tender Document, failing which their Bid will be liable for rejection. If a Bidder does not reply to the queries in the permitted time frame then its Bid shall be evaluated based on the documents available in the Bid.

As a principle, clarifications from bidders after opening of tenders will not be sought. However, where clarifications / documents from the bidders on important aspects are absolutely necessary for finalization of tender, clarifications from bidder can be asked. The request for clarification shall be given in email/portal, asking the bidder to respond by a specified date, and also mentioning therein that, if the bidder does not comply or respond by the date, his tender will be liable to be rejected. Depending on the outcome, such tenders are to be ignored or considered further. No change in prices or substance of the bid including specifications, shall be offered or permitted. No post-bid clarification at the initiative of the bidder shall be entertained. The shortfall information/ documents should be sought only in case of historical documents which pre-existed bids and which have not undergone change since then.

Date of Issue: 9th March'23

	COMPOSITE SUPPLY CUM ERECTION OF ELECTRICAL & INSTRUMENTATION WORKS FOR OSBL FACILITIES ON ITEM RATE BASIS AT TALCHER FERTILIZERS LIMITED, ANGUL, ODISHA	PC-183/ E-8003/ S-III	0	
		DOC. NO.	REV.	
		Page 21 of 142		

19.2 **REJECTION CRITERIA:** Notwithstanding the above, deviation to the following clauses of Tender document shall lead to summarily rejection of Bid:

- a) Bidder not meeting Bid Evaluation Criteria as per Tender Document
- b) Firm Price
- c) EMD / Declaration for Bid Security (as applicable)
- d) Specifications & Scope of Work
- e) Schedule of Rates / Price Schedule / Price Basis
- f) Duration / Period of Contract/ Completion Period
- g) Payment Terms
- h) Period of Validity of Bid
- i) Integrity Pact
- j) PRS Clause
- k) Overall ceiling on total liability
- l) Contract Performance Security
- m) Guarantee / Defect Liability Period
- n) Arbitration / Settlement of Dispute
- o) Governing laws, language & measures
- p) Force Majeure
- q) Undertaking forms, Form I of Annexure VII for provision for procurement from a bidder which shares a land border with India
- r) Bidder quoting less than 20% as minimum Local content (as per make in India PPLC policy)
- s) Any other condition specifically mentioned in the tender document elsewhere that non-compliance of the clause lead to rejection of bid

Note: Further, it is once again reminded not to mention any condition in the Bid which is contradictory to the terms and conditions of Tender document.

20 **E-PAYMENT**



OWNER has initiated payments to Contractors electronically, and to facilitate the payments electronically through '**e-banking**'.

[D] – SUBMISSION OF BIDS

21 **SUBMISSION, SEALING AND MARKING OF BIDS**

- 21.1 In case of e-tendering, bids shall be submitted through e-tender in the manner specified elsewhere in tender document. No Manual/ Hard Copy (Original) offer shall be acceptable. Physical documents shall be addressed to the owner at address specified in IFB.

Date of Issue: 9th March'23

	COMPOSITE SUPPLY CUM ERECTION OF ELECTRICAL & INSTRUMENTATION WORKS FOR OSBL FACILITIES ON ITEM RATE BASIS AT TALCHER FERTILIZERS LIMITED, ANGUL, ODISHA	PC-183/ E-8003/ S-III	0	
		DOC. NO.	REV.	
		Page 22 of 142		

21.2 Deleted

21.3 Bids submitted under the name of AGENT/ REPRESENTATIVE /RETAINER/ ASSOCIATE etc. on behalf of a bidder/affiliate shall not be accepted.

22 DEADLINE FOR SUBMISSION OF BIDS

22.1 In case of e-bidding, the bids must be submitted through e-tender mode not later than the date and time specified in the tender document/BDS (Bidding Data Sheet).

22.2 Deleted.

22.3 TFL may, in exceptional circumstances and at its discretion, extend the deadline for submission of Bids (clause 8 and/or 9 of ITB refers). In which case all rights and obligations of TFL and the Bidders, previously subject to the original deadline will thereafter be subject to the deadline as extended. Notice for extension of due date of submission of bid will be uploaded on website only as mentioned in Clause No. 2.0(G) of IFB.

23 LATE BIDS

23.1 Any bids received after the notified date and time of closing of tenders will be treated as late bids.

23.2 In case of e-tendering, e-tendering system of CPP Portal (eprocure.gov.in) shall close immediately after the due date for submission of bid and no bids can be submitted thereafter.

23.3 Physical documents received to address other than one specifically stipulated in the Tender Document will not be considered for evaluation/opening/award if not received to the specified destination within stipulated date & time.

23.4 Unsolicited Bids or Bids received to address other than one specifically stipulated in the tender document will not be considered for evaluation/opening/award if not received to the specified destination within stipulated date & time.



24 MODIFICATION AND WITHDRAWAL OF BIDS

24.1 Modification and withdrawal of bids shall be as follows:-

24.1.1 IN CASE OF E- TENDERING

The bidder may withdraw or modify its bid after bid submission but before the due date and time for submission as per tender document.

Date of Issue: 9th March'23

	COMPOSITE SUPPLY CUM ERECTION OF ELECTRICAL & INSTRUMENTATION WORKS FOR OSBL FACILITIES ON ITEM RATE BASIS AT TALCHER FERTILIZERS LIMITED, ANGUL, ODISHA	PC-183/ E-8003/ S-III	0	
		DOC. NO.	REV.	
		Page 23 of 142		

24.1.2 IN CASE OF MANUAL BIDDING

Deleted.

[E] – BID OPENING AND EVALUATION

25 EMPLOYER'S RIGHT TO ACCEPT ANY BID AND TO REJECT ANY OR ALL BIDS

25.1 TFL reserves the right to accept or reject any Bid, and to annul the Bidding process and reject all Bids, at any time prior to award of Contract, without thereby incurring any liability to the affected Bidder(s) or any obligations to inform the affected Bidder(s) of the ground for TFL's action. However, Bidder if so desire may seek the reason (in writing) for rejection of their Bid to which TFL shall respond quickly.

25.2 A bidder is to be permitted to send his representation in writing to dealing officer specified in tender for rejection of bid. But, such representation has to be sent upto 10(ten) days from the date of Notification of Award/FOA. A decision on representation will be taken by TFL within 15 (fifteen) days of the receipt of the representation. Only a directly affected bidder can represent in this regard:

- i) Only a bidder who has participated in tender can make such representation
- ii) In case technical bid has been evaluated before the opening of the financial bid, an application for review in relation to the financial bid may be filed only by a bidder whose technical bid is found to be acceptable

25.3 However, following decisions of TFL shall not be subject to review:



- a) Determination of the need for procurement;
- b) Selection of the mode of procurement or bidding system;
- c) Choice of selection procedure;
- d) Provisions limiting participation of bidders in the procurement process;
- e) The decision to enter into negotiations with the L1 bidder;
- f) Cancellation of the procurement process except where it is intended to subsequently re-tender the same requirements;
- g) Issues related to ambiguity in contract terms may not be taken up after a contract has been signed, all such issues should be highlighted before consummation of the contract by the vendor/ contractor; and
- h) Complaints against specifications except under the premise that they are either vague or too specific so as to limit competition may be permissible.

26 BID OPENING

26.1 Unpriced Bid Opening:

TFL/ PDIL will open bids in the presence of bidders' designated representatives who choose to attend date, time and location stipulated in the BDS. The bidders' representatives, who are present shall sign a bid opening register evidencing their

Date of Issue: 9th March'23

	COMPOSITE SUPPLY CUM ERECTION OF ELECTRICAL & INSTRUMENTATION WORKS FOR OSBL FACILITIES ON ITEM RATE BASIS AT TALCHER FERTILIZERS LIMITED, ANGUL, ODISHA	PC-183/ E-8003/ S-III	0	
		DOC. NO.	REV.	
		Page 24 of 142		

attendance.

26.2 Priced Bid Opening:

26.2.1 TFL will open the price bids of those Bidders who meet the qualification requirement and whose bid is determined to be technically and commercially responsive. Techno-commercial bid evaluation status will be are to be informed to all bidders (including informing the techno-commercially not qualified Bidders). Price bids are to be opened in the presence of only techno-commercially acceptable bidders, who are willing to attend the bid opening, at a pre-publicised date, time and place or on the portal in case of e-procurement. The bidder's name, bid price, discount (if any) and any such details considered appropriate shall be read out during the price bid opening. Offers should not, repeat not, be circulated amongst the bidder's representative. Bidders selected for opening of their price bid shall be informed about the date & time of price bid opening. Bidders may depute their authorized representative to witness the price bid opening. The Bidders' representatives, who are present shall sign a Price Bid Opening Register evidencing their attendance and may be required to be present even on a short notice.

26.2.2 The price bids of those Bidders who were not found to be techno-commercially responsive shall not be opened.

26.3 Reverse Auction (Clause not applicable)

~~26.3.1 OWNER shall finalize tender after conducting reverse auction except in those cases where less than four techno-commercially acceptable offers are available.~~

~~— In case, after techno commercial evaluation, number of technically & commercially acceptable offers are less than 04 (four), then no reverse auction will be conducted (but the OWNER/CONSULTANT shall take appropriate decision regarding conducting offline price negotiation, if required).~~



~~— Accordingly, the decision to conduct reverse auction shall be communicated to shortlisted bidders prior to opening of price bid. The due date and time of conducting the event of Reverse Auction (if conducted) shall be intimated well in advance to the techno-commercially acceptable bidders, through email.~~

~~26.3.2 Detailed methodology of Reverse Auction~~

~~With the assistance of RA system provider, training to all eligible bidders on the Online Reverse Auction process shall be facilitated prior to conduct of Online Reverse Auction.~~

- ~~a) Computerized Reverse Auction shall be conducted by PDIL through M/s e-Procurement Technologies Limited, on pre-specified date, while the bidders shall be quoting from their own offices/ place of their choice.~~

Date of Issue: 9th March'23

	COMPOSITE SUPPLY CUM ERECTION OF ELECTRICAL & INSTRUMENTATION WORKS FOR OSBL FACILITIES ON ITEM RATE BASIS AT TALCHER FERTILIZERS LIMITED, ANGUL, ODISHA	PC-183/ E-8003/ S-III	0	
		DOC. NO.	REV.	
		Page 25 of 142		

b) ~~The due date and time of conducting the event of Reverse Auction shall be intimated at least 2 (two) days in advance to the techno-commercially acceptable bidders, through email /letter. For better understanding of Reverse Auction by the bidders, one day online training shall be conducted by M/s e Procurement Technologies Limited i.e. the agency conducting the Reverse Auction, for all the techno-commercially qualified bidders. Reverse Auction Training and Demo auction shall be conducted through Video conferencing only.~~

e) ~~A user ID and a password shall be created for each techno-commercially qualified bidder by the M/s e Procurement Technologies Limited and the same shall be communicated to the bidders during the training process. A Valid Digital Signature Certificate is required to take part in Reverse Bidding process.~~

d) ~~Display of Details during Reverse Auction(RA)~~

~~The bidder will be able to view the following details on their screen during RA:~~

- ~~1) "Total basic Price" (i.e. Total Price excluding GST)~~
- ~~2) "Loading factor"~~
- ~~3) "Total Evaluated Price" (i.e. Total Basic Price x Loading factor, calculated by system)~~
- ~~4) "Rank of the bidder" (i.e. present rank, auto updated by system)~~
- ~~5) "L1 price" (i.e. Present Lowest Total Evaluated Price, auto updated by system)~~

~~The "Total basic Price", Loading factor and the "Total Evaluated Price" before RA shall be informed to individual bidders shortly after completion of the RA training. The "Total basic Price" before RA shall be the "Start price" of each bidder. During RA, the bidder will be able to reduce only the "Total Basic Price". The "Total Evaluated Price" will be automatically calculated by the system and system will then compare it with "Total Evaluated Price" of other bidders to arrive at Rank and L1 price after every price change during the RA. After completion of RA, the "Total Evaluated Price" of the lowest bidder shall be considered as the L-1 price after RA.~~



~~However, at no point of time will any bidder see names of other bidders, or prices of bidders other than the lowest bid. The Bidder has to out bid his own previous price & try to reach Number 1 rank.~~

~~The tender shall be processed further for award or otherwise based on L-1 prices received at the end of Online Reverse Auction. Price reasonableness will still need to be established by PDIL/TFL even though the bidding is through Online Reverse Auction and TFL will reserve the right to negotiate with the L1 bidder as per CVC guidelines.~~

e) ~~All timings of the online bid shall be based on the time indicated by the Server hosting the Auction Engine which would reflect as closely as possible the Indian Standard Time (IST) i.e. GMT+05:30 hrs. However, in the event of any deviations between the Server Time and the Indian Standard Time, the functioning of the Auction Engine (launch, operation and closure) would be guided by the Server time. Bidders should be advised to refresh the window of the Auction module and check the exact server Time.~~

f) ~~The start price of bidders will be automatically populated by system at the time of start of Reverse Auction. The same will be considered as participation by bidder in Online Reverse Auction process. In case any bidder emerges lowest bidder after RA based on their start price(s), the same will be considered as their final price(s) taking into consideration~~



Date of Issue: 9th March'23

	COMPOSITE SUPPLY CUM ERECTION OF ELECTRICAL & INSTRUMENTATION WORKS FOR OSBL FACILITIES ON ITEM RATE BASIS AT TALCHER FERTILIZERS LIMITED, ANGUL, ODISHA	PC-183/ E-8003/ S-III	0	
		DOC. NO.	REV.	
		Page 26 of 142		

respective loading factor (to arrive at “Total Evaluated Price”) for award of contract/ order irrespective of whether bidder had actually logged in RA portal or not. In case bidder does not accept the same, such bidder will be considered as errant bidder and action will be taken against bidder as per provision in this regard.

- ~~g) During Reverse Auction, a bidder can reduce his prices repeatedly. The minimum percentage reduction in each step namely, the bid decrement’ shall not be less than 0.5% of the last bid of the respective bidder. Bidders are allowed to submit/accept first price without decrement amount but afterwards participation in reverse auction is allowed only with minimum decrement amount /percentage.~~
- ~~h) The process of Online Reverse Auction shall initially be held for a period of 30 minutes. In the event of a bid received in the last 5 minutes resulting in a change of prevailing L1 price, the period of the auction shall get extended automatically by 8 minutes from the time of submission of such bid. This process will continue till no change in L 1 price takes place in last 5 minutes after which the auction will close. All bidders regardless of their previous position can submit their bid during the extended period also.~~
- ~~i) In case of a tie during auction i.e. two bidders entering same lowest price, the bidder who enters the prices first in the system would be taken as L-1 and the other bidder would see their ranking as L-2.~~
- ~~j) Internet connectivity shall have to be ensured by bidders themselves. Bidders are requested to make all the necessary arrangements/ alternatives whatever required so that they are able to circumvent such situation and still be able to participate in the Reverse Auction successfully.~~
- ~~k) Bidders in their own interest should ensure uninterrupted internet connectivity at their end during the reverse auction with necessary backups to take care of any connectivity problem. No request for any extension of RAP due to internet connectivity issues or for any other reason at bidders end shall be entertained by PDIL/TFLL.~~
- ~~l) In case of disruption of service at the service provider's end i.e. M/s e-Procurement Technologies Limited while the RAP (Reverse Auction Process) is online, due to any technical snag or otherwise attributable to the system failure at the server end, the RAP process will start all over again, through a fresh RAP (hereinafter referred to as “Restarted RAP”), the time and date of which will be intimated in writing to all bidders. In such a situation, the last recorded lowest price of prematurely ended RAP, will be the 'Start Bid Price' for the “Re-started RAP”. The prices quoted in the prematurely ended RAP will be binding on all the bidders for consideration. All the time stipulations of normal RAP will be applicable to the “Restarted RAP”.~~
- ~~m) Communication with any official with service provider/PDIL/TFLL when the RAP is online is strictly prohibited. Bidders in their own interest will have to get themselves satisfied on any queries that they may have during the RAP training session. No query when the RAP is online will be entertained.~~

Date of Issue: 9th March'23

	COMPOSITE SUPPLY CUM ERECTION OF ELECTRICAL & INSTRUMENTATION WORKS FOR OSBL FACILITIES ON ITEM RATE BASIS AT TALCHER FERTILIZERS LIMITED, ANGUL, ODISHA	PC-183/ E-8003/ S-III	0	
		DOC. NO.	REV.	
		Page 27 of 142		

~~n) Upon completion of reverse auction, rate of individual items of SOR shall be worked out applying uniform reduction (reduction being derived from the original Total Evaluated Price & final Total Evaluated Price after RA).~~

~~e) While working out rate of individual items, unit rate upto two decimals only will be considered and the figures beyond two decimals shall be ignored without rounding off (e.g. if item rates after applying uniform reduction works out to 10.910 or 10.912 or 10.915 or 10.919, the rate will be considered as 10.91). Above prices shall be the final prices of lowest bidder against the tender for all the purposes and the original quoted prices against tender shall no more be valid for tender for which Reverse Auction was held.~~

~~26.3.3 Preferences: Purchase Preference shall be applicable as defined in tender document.~~

27 CONFIDENTIALITY

Information relating to the examination, clarification, evaluation and comparison of bids, and recommendations for the award of a contract, shall not be disclosed to bidders or any other person not officially concerned with such a process until the award to the successful bidder.

28 CONTACTING THE EMPLOYER

28.1 From the time of bid opening to the time of contract award, no bidder shall contact TFL on any matter related to the bid, except on request and prior written permission.



28.2 Any effort by the bidder to influence TFL in bid evaluation, bid comparison or contract award decisions will vitiate the process and will result in the rejection of the bidder's bid and action shall be initiated as per the TFL's procedure for action in case Corrupt / Fraudulent / Collusive / Coercive practices in this regard apart from forfeiture of EMD/ Bid Security, if any.

29 EXAMINATION OF BIDS AND DETERMINATION OF RESPONSIVENESS

29.1 The employer's determination of a bid's responsiveness is based on the content of the bid only. Prior to the detailed evaluation of Bids, the Employer will determine whether each Bid:

- (a) Meets the "Bid Evaluation Criteria" of the Bidding Documents ;
- (b) Has been properly signed;
- (c) Is accompanied by the required 'Earnest Money / Bid Security / Bid Security Declaration'
- (d) Is substantially responsive to the requirements of the Bidding Documents ; and
- (d) Provides any clarification and/or substantiation that the Employer may require to determine responsiveness pursuant to "ITB: Clause-29.2"

Date of Issue: 9th March'23

	COMPOSITE SUPPLY CUM ERECTION OF ELECTRICAL & INSTRUMENTATION WORKS FOR OSBL FACILITIES ON ITEM RATE BASIS AT TALCHER FERTILIZERS LIMITED, ANGUL, ODISHA	PC-183/ E-8003/ S-III	0	
		DOC. NO.	REV.	
		Page 28 of 142		

29.2 A substantially responsive Bid is one which conforms to all the terms, conditions and specifications of the Bidding Documents without material deviations or reservations or omissions for this purpose employer defines the foregoing terms below:

- a) "Deviation" is departure from the requirement specified in the tender documents.
- b) "Reservation" is the setting of limiting conditions or withholding from complete acceptance of the requirement in the tender documents.
- c) "Omission" is the failure to submit part or all of the information or documentation required in the tender document for evaluation of bid.

29.3 A material deviation, reservation or omission is one that,



- a) If accepted would,
 - i) Affect in any substantial way the scope, quality, or performance of the job as specified in tender documents.
 - ii) Limit, in any substantial way, inconsistent with the Tender Document, the Employer's rights or the tenderer's obligations under the proposed Contract.
- b) If rectified, would unfairly affect the competitive position of other bidders presenting substantially responsive bids.

29.4 The employer shall examine all aspects of the bid to confirm that all requirements have been met without any material deviation, reservation or omission.

29.5 Tenders that do not meet the basic requirements specified in the bid documents are to be treated as unresponsive {both during Techno-commercial evaluation and Financial Evaluation incase of Two Bid System) and will be ignored. All tenders received will first be scrutinized to see whether the tenders meet the basic requirements as incorporated in the Bid document and to identify unresponsive tenders, if any. Unresponsive offers may not subsequently be made responsive by correction or withdrawal of the non-conforming stipulation. Some important points on the basis of which a tender may be declared as unresponsive and be ignored during the initial scrutiny are:

- i) The tender is not in the prescribed format or is unsigned or not signed as per the stipulations in the bid document;
- ii) The required EMD has not been provided or exemption from EMD is claimed without acceptable proof of exemption;
- iii) The bidder is not eligible to participate in the bid as per laid down eligibility criteria
- iv) The bid departs from the essential requirements specified in the bidding document (for example, the tenderer has not agreed to give the required contract performance security); or
- v) Against a schedule in the list of requirements in the tender enquiry, the tenderer has not quoted for the entire requirement as specified in that schedule (example: in a

Date of Issue: 9th March'23

	COMPOSITE SUPPLY CUM ERECTION OF ELECTRICAL & INSTRUMENTATION WORKS FOR OSBL FACILITIES ON ITEM RATE BASIS AT TALCHER FERTILIZERS LIMITED, ANGUL, ODISHA	PC-183/ E-8003/ S-III	0	
		DOC. NO.	REV.	
		Page 29 of 142		

schedule, it has been stipulated that the tenderer will supply the equipment, install and commission it and also train the TFL's personnel for operating the equipment. The tenderer has, however, quoted only for supply of the equipment).

30 CORRECTION OF ERRORS-

Arithmetic Correction of Errors (if any) in multiplication to derive the total cost of an individual item shall be done by the Consultant based on the quoted Unit Price by the Bidder. If the bidder does not accept the corrected amount of bid, its bid will be rejected.

31 CONVERSION TO SINGLE CURRENCY FOR COMPARISON OF BIDS

Not Applicable. All bids submitted must be in the currency specified at clause 14 of ITB.

32 EVALUATION AND COMPARISON OF BIDS

Bid shall be evaluated as per evaluation criteria mentioned in Section-II of bidding documents on lowest bid basis.

In case of a tie at the lowest bid (L1) position between two or more bidders, the order/LoA will be placed on the bidder who has higher/ highest turnover in last audited financial year.

In case there is a tie at the lowest bid (L1) position between only startup bidders and none of them has past turnover, the order/FOA will be placed on the startup who is registered earlier with Department for Promotion of Industry and Internal Trade (wherever applicable).

33 COMPENSATION FOR EXTENDED STAY



Not Applicable

34 PURCHASE PREFERENCE

Purchase Preference as per Policy to Provide Purchase Preference as per Public Procurement (Preference to Make in India), Order 2017 shall be allowed as per Government instructions in vogue, as applicable from time to time

The Policy to Provide Purchase Preference as per Public Procurement (Preference to Make in India), Order 2017 is enclosed as Annexure V to ITB herewith.

Evaluation and applicability of purchase preference policy will be based on the confirmations & documents submitted by the bidder in their bid.

	COMPOSITE SUPPLY CUM ERECTION OF ELECTRICAL & INSTRUMENTATION WORKS FOR OSBL FACILITIES ON ITEM RATE BASIS AT TALCHER FERTILIZERS LIMITED, ANGUL, ODISHA	PC-183/ E-8003/ S-III	0	
		DOC. NO.	REV.	
		Page 30 of 142		

[F] – AWARD OF CONTRACT

35 AWARD

Subject to "ITB: Clause-29", Owner will award the Contract to the successful Bidder whose Bid has been determined to be substantially responsive and has been determined as the lowest provided that bidder, is determined to be qualified to satisfactorily perform the Contract.



“TFL intends to place the contract directly on the address from where Goods are produced / dispatched or Services are rendered. In case, bidder wants contract at some other address or supply of Goods/ Services from multiple locations, bidder is required to provide in their bid address on which order is to be placed.”

TFL will place the Contract directly on the successful bidder from whom the bid has been received & evaluated and will not place order on other entities such as subsidiary, business associate or partner, dealer/distributor etc. of the Bidder.

36 NOTIFICATION OF AWARD / FAX OF ACCEPTANCE

- 36.1 Prior to the expiry of 'Period of Bid Validity', Notification of Award for acceptance of the Bid will be intimated to the successful Bidder by TFL either by E-mail /Letter or like means defined as the "Fax of Acceptance (FOA)". The Contract shall enter into force on the date of FOA and the same shall be binding on TFL and successful Bidder (i.e. Contractor). The Notification of Award/FOA will constitute the formation of a Contract. The detailed Letter of Acceptance shall be issued thereafter incorporating terms & conditions of Tender Document, Corrigendum, Clarification(s), Bid and agreed variation(s)/acceptable deviation(s), if any. TFL may choose to issue Notification of Award in form of detailed Letter of Acceptance without issuing FOA and in such case the Contract shall enter into force on the date of Detailed Letter of Acceptance only.
- 36.2 Contract period shall commence from the date of "Notification of Award" or as mentioned in the Notification of Award. The "Notification of Award" will constitute the formation of a Contract, until the Contract has been effected pursuant to signing of Contract as per "ITB: Clause-37".
- 36.3 Upon the successful Bidder's / Contractor's furnishing of 'Contract Performance Security / Security Deposit', pursuant to "ITB: Clause-38", TFL will promptly discharge his 'Earnest Money Deposit / Bid Security (if applicable)', pursuant to "ITB: Clause-16".
- 36.4 The Order/ contract value mentioned above is subject to PRS clause.

Date of Issue: 9th March'23

	COMPOSITE SUPPLY CUM ERECTION OF ELECTRICAL & INSTRUMENTATION WORKS FOR OSBL FACILITIES ON ITEM RATE BASIS AT TALCHER FERTILIZERS LIMITED, ANGUL, ODISHA	PC-183/ E-8003/ S-III	0	
		DOC. NO.	REV.	
		Page 31 of 142		

36.5 TFL will award the Contract to the successful Bidder, who, within 'fifteen [15] days' of receipt of the same, shall sign and return the acknowledged copy to TFL.

37 SIGNING OF AGREEMENT

The successful Bidder/Contractor shall be required to execute an 'Agreement' (in case the individual contract value as specified in Notification of Award is more than INR 10 Lakhs exclusive of GST) in the proforma given in this Bidding Document) on a 'non-judicial stamp paper' of appropriate value [cost of the 'stamp-paper' shall be borne by the successful Bidder/Contractor] and of 'state of India' specified in Bidding Data Sheet (BDS) only, within 'fifteen [15] days' of receipt of the " Fax of Acceptance (FOA)" of the Tender by the successful Bidder/Contractor failure on the part of the successful Bidder/Contractor to sign the 'Agreement' within the above stipulated period, shall constitute sufficient grounds for forfeiture of EMD/Security Deposit / Action as per Bid Security declaration.

38 CONTRACT PERFORMANCE SECURITY / SECURITY DEPOSIT ((CPS/SD)

38.1 Within 30 days of the receipt of the notification of Award/ Fax of Acceptance (FOA) by from TFL, the successful bidder shall furnish the Contract Performance Security (CPS) in accordance with of General Conditions of the Contract. The CPS shall be in the form of either Banker's Cheque or Demand Draft or Insurance Surety Bond or Fixed Deposit Receipt or Bank Guarantee or Letter of Credit and shall be in the currency of the Contract. However, CPS shall not be applicable in cases wherein the individual ~~order~~ contract value as specified in Notification of Award is less than INR 5 Lakh (exclusive of GST).



If contractor has failed to submit CPS/ SD within specified time, a penal interest of Marginal Cost of Fund based Lending Rate (MCLR) for one year charged by SBI (applicable on due date of submission of CPBG/SD i.e. 30th day after issuance of FOA/ Notification of award) plus 4.0% p.a (on CPBG/SD amount) shall be charged for delay beyond 30 days i.e. from 31st days after issuance of FOA.

The first payment to contractor/ vendor/supplier is to be released only after submission of Contract Performance Security (CPS)/ Security Deposit (SD) & deduction of applicable interest OR deduction of Contract Performance Security (CPS)/ Security Deposit (SD) along with applicable interest from the due payment as mentioned herein above.

38.2 The CONTRACT PERFORMANCE SECURITY shall be for an amount equal specified in Bidding Data Sheet (BDS) towards faithful performance of the contractual obligations and performance of equipment. For the purpose of CPS, Contract/order value shall be exclusive of **GST (CGST & SGST/UTGST or IGST)**.

Bank Guarantee towards CPS shall be from any Indian scheduled bank (excluding Co-operative banks and Regional Rural bank) or a branch of an International bank situated in India and registered with Reserve Bank of India as scheduled foreign bank. However, in



Date of Issue: 9th March'23

	COMPOSITE SUPPLY CUM ERECTION OF ELECTRICAL & INSTRUMENTATION WORKS FOR OSBL FACILITIES ON ITEM RATE BASIS AT TALCHER FERTILIZERS LIMITED, ANGUL, ODISHA	PC-183/ E-8003/ S-III	0	
		DOC. NO.	REV.	
		Page 32 of 142		

case of bank guarantees from banks other than the Nationalized Indian banks, the bank must be a commercial bank having net worth in excess of Rs 100 crores and a declaration to this effect should be made by such commercial bank either in the Bank Guarantee itself or separately on its letterhead.

- 38.3 Failure of the successful bidder to comply with the requirements of this article shall constitute sufficient grounds for consideration of the annulment of the award and Forefeiture of EMD/action as per declaration of Bid Security.
- 38.4 The CPS has to cover the entire contract value including extra works/services also. As long as the CPS submitted at the time of award take cares the extra works/services executed and total executed value are within the awarded contract price, there is no need for additional CPS. As soon as the total executed value is likely to burst the ceiling of awarded contract price, the contractor should furnish additional CPS.
- 38.5 Deleted.
- 38.6 In addition to existing specified form (i.e. Demand Draft (DD)/ Banker's Cheque/ Bank Guarantee/Letter of Credit) mentioned in tender documents for submission of **EMD/ Security Deposit/ Contract Performance Security**, the successful bidder can also submit the **EMD/ Security Deposit/ Contract Performance Security** through online banking transaction i.e. IMPS/NEFT/RTGS/SWIFT etc. For this purpose, the detail of TFL's Bank Account is mentioned in BDS. Further, in case a successful Bidder is willing to furnish CPS through SWIFT, the details may be obtained from Purchase Officer immediately after receipt of FOA.
- While remitting such online transaction, the bidder must indicate "**EMD/ Security Deposit/ Contract Performance Security against FOA/DLOA no. __ (contractor to specify the FOA/DLOA No.)**" under remarks column of such transaction of respective bank portal. The contractor/vendor shall be required to submit the successful transaction details to the dealing officer immediately through email/letter and necessarily within 30 days from the date of Fax of Acceptance.
- 38.7 In case of forfeiture of Contract Performance Security/ Security Deposit in terms of GCC, the forfeited amount will be considered inclusive of tax and tax invoice will be issued by TFL. The forfeiture amount will be subject to final decision of TFL based on other terms and conditions of order/ contract.
- 38.8 The Contractor will also submit covering letter along with CPS as per format at F-4.
- 38.9 CPBG/Security Deposit will not be accepted in case the same has reference of 'remitter'/financer' other than bidder on the aforementioned financial instrument of CPBG/ Security Deposit submitted by the Contractor.
- 38.10 The first payment to vendor is to be released only after submission of CPS / Security Deposit (SD).

Date of Issue: 9th March'23

	COMPOSITE SUPPLY CUM ERECTION OF ELECTRICAL & INSTRUMENTATION WORKS FOR OSBL FACILITIES ON ITEM RATE BASIS AT TALCHER FERTILIZERS LIMITED, ANGUL, ODISHA	PC-183/ E-8003/ S-III	0	
		DOC. NO.	REV.	
		Page 33 of 142		

38.11 Before the CPS / Security Deposit (SD) is released a "No Claim Certificate" is to be submitted by the supplier/vendor.

39 PROCEDURE FOR ACTION IN CASE CORRUPT/FRAUDULENT/COLLUSIVE/COERCIVE PRACTICES

39.1 Procedure for action in case Corrupt/ Fraudulent/Collusive/Coercive Practices is enclosed at Annexure-I.

39.4 NON-APPLICABILITY OF ARBITRATION CLAUSE IN CASE OF BANNING OF VENDORS/ SUPPLIERS / CONTRACTORS/ BIDDERS/ CONSULTANTS INDULGED IN FRAUDULENT/ COERCIVE PRACTICES

Notwithstanding anything contained contrary in GCC and other "CONTRACT DOCUMENTS", in case it is found that the Contractors/Bidders indulged in fraudulent/coercive practices at the time of bidding, during execution of the contract etc. and/or on other grounds as mentioned in OWNER's "Procedure for action in case Corrupt/Fraudulent/Collusive/Coercive Practices" (Annexure-I to Section-III), the contractor/bidder shall be banned (in terms of aforesaid procedure) from the date of issuance of such order by TFL, to such Contractors/Bidders.

The Contractor/ Bidder understands and agrees that in such cases where Contractor/ Bidder has been banned (in terms of aforesaid procedure) from the date of issuance of such order by TFL, such decision of TFL shall be final and binding on such Contractor/ Bidder and the 'Arbitration clause' in the GCC and other "CONTRACT DOCUMENTS" shall not be applicable for any consequential issue /dispute arising in the matter.

40 PUBLIC PROCUREMENT POLICY FOR MICRO AND SMALL ENTERPRISES

40.1 Government of India, vide Gazette of India No. 503 dated 26.03.2012 proclaimed the Public Procurement Policy for Micro and Small Enterprises (MSEs). The following benefit is available in case of work contract also:



- i) Issue of tender document to MSEs free of cost.
- ii) Exemption to MSEs from payment of EMD/Bid Security.

40.2 In case Bidder is a Micro or Small Enterprise, the Bidder shall submit Udyam Registration Certificate for availing benefit under Public Procurement Policy for MSEs-2012.

Vide Gazette notification dated 18.10.2022 of Ministry of MSME, the following is notified:

"In case of an upward change in terms of investment in plant and machinery or equipment or turnover or both, and consequent re-classification, an enterprise shall continue to avail of all nontax benefits of the category (micro or small or medium) it was in before the re-classification, for a period of three years from the date of such upward change"

Date of Issue: 9th March'23

	COMPOSITE SUPPLY CUM ERECTION OF ELECTRICAL & INSTRUMENTATION WORKS FOR OSBL FACILITIES ON ITEM RATE BASIS AT TALCHER FERTILIZERS LIMITED, ANGUL, ODISHA	PC-183/ E-8003/ S-III	0	
		DOC. NO.	REV.	
		Page 34 of 142		

Accordingly, in case of upward change in status, MSE bidder is required to submit the previous certificate also to get the MSE benefit.

The above documents submitted by the bidder shall be duly certified by the Chartered Accountant (not being an employee or a Director or not having any interest in the bidder's company/firm) and notary public with legible stamp.

If the bidder does not provide the above confirmation or appropriate document or any evidence, then it will be presumed that they do not qualify for any preference admissible in the Public Procurement Policy (PPP) 2012.

Further, MSEs who are availing the benefits of the Public Procurement Policy (PPP) 2012 get themselves registered with MSME Data Bank being operated by NSIC, under SME Division, M/o MSME, in order to create proper data base of MSEs which are making supplies to CPSUs.

- 40.3 If against an order placed by TFL , successful bidder(s) (other than Micro/Small Enterprise) is procuring material/services from their sub-vendor who is a Micro or Small Enterprise as per provision mentioned at clause no. 40.2 with prior consent in writing of the purchasing authority/Engineer-in-charge, the details like Name, Registration No., Address, Contact No. details of material & value of procurement made, etc. of such Enterprises shall be furnished by the successful bidder at the time of submission of invoice/Bill.
- 40.4 The benefit of policy are not extended to the traders/dealers/ Distributors /Stockiest/Wholesalers.
- 40.5 NSIC has initiated a scheme of "Consortia and Tender Marketing Scheme" under which they are assisting the Micro & Small enterprises to market their products and services through tender participation on behalf of the individual unit or through consortia.



Accordingly, if the MSEs or the consortia, on whose behalf the bid is submitted by NSIC, is meeting the BEC and other terms and conditions of tender their bid will be considered for further evaluation. Further, in such cases a declaration is to be submitted by MSE/ consortia on their letter head (s) that all the terms and conditions of tender document shall be acceptable to them.

- 40.6 Interest payment on delayed payments to MSME is payable in line with Micro, Small and Medium Enterprises Development Act, 2006

41 AHR ITEMS

In item rate contract where the quoted rates for the items exceed 50% of the estimate rates, such items will be considered as Abnormally High Rates (AHR) items and payment of AHR items beyond the SOR stipulated quantities shall be made at the lowest amongst the following rates:

Date of Issue: 9th March'23

	COMPOSITE SUPPLY CUM ERECTION OF ELECTRICAL & INSTRUMENTATION WORKS FOR OSBL FACILITIES ON ITEM RATE BASIS AT TALCHER FERTILIZERS LIMITED, ANGUL, ODISHA	PC-183/ E-8003/ S-III	0	
		DOC. NO.	REV.	
		Page 35 of 142		

- i) Rates as per SOR, quoted by the Contractor/Bidder.
- ii) Rate of the item, which shall be derived as follows:
 - a. Based on rates of Machine and labour as available from the contract (which includes contractor's supervision, profit, overheads and other expenses).
 - b. In case rates are not available in the contract, rates will be calculated based on prevailing market rates of machine, material and labour /latest DSR and plus 15% to cover contractor's supervision profit, overhead & other expenses

.42 VENDOR PERFORMANCE EVALUATION

Shall be as stipulated Annexure II to ITB herewith.

43 INCOME TAX & CORPORATE TAX

43.1 Income tax deduction shall be made from all payments made to the contractor as per the rules and regulations in force and in accordance with the Income Tax Act prevailing from time to time.

43.2 Corporate Tax liability, if any, shall be to the contractor's account.

43.3 TDS

- (i) TDS, wherever applicable, shall be deducted as per applicable act/law/rule.
- (ii) **Higher rate of TDS for non-filers of ITR**



As per Section 206AB of Income Tax Act, 1961, in case of any vendor/customer who does not filed their Income Tax Return for both of the two previous years preceding to current year and aggregate amount of TDS is more than or equal to 50,000/- in each of those previous two years (or limit defined by Govt. from time to time), then TDS will be deducted at the higher of following rates:

- (I) Twice the rate mentioned in relevant TDS section.
- (II) Twice the rate or rates in force
- (III) 5%

43.4 MENTIONING OF PAN NO. IN INVOICE/BILL

As per CBDT Notification No. 95/2015 dated 30.12.2015, mentioning of PAN no. is mandatory for procurement of goods / services/works/consultancy services exceeding Rs. 2 Lacs per transaction or as amended from time to time.

Date of Issue: 9th March'23

	COMPOSITE SUPPLY CUM ERECTION OF ELECTRICAL & INSTRUMENTATION WORKS FOR OSBL FACILITIES ON ITEM RATE BASIS AT TALCHER FERTILIZERS LIMITED, ANGUL, ODISHA	PC-183/ E-8003/ S-III	0	
		DOC. NO.	REV.	
		Page 36 of 142		

Accordingly, contractor should mention their PAN no. in their invoice/ bill for any transaction exceeding Rs. 2 lakhs or as amended from time to time. As provided in the notification, in case contractors do not have PAN no., they have to submit declaration in Form 60 along with invoice/ bill for each transaction.

Payment of contractor shall be processed only after fulfillment of above requirement.

44. DISPUTE RESOLUTION MECHANISM

44.1 QUARTERLY CLOSURE OF THE CONTRACT

During execution of orders, various issues may arise. In order to timely detect and to address the contractual issue(s) during the execution of contracts, TFL has introduced a mechanism of Quarterly Closure of the contract, under which all the related issues /disputes will be monitored and addressed on quarterly basis for resolution. Vendor (hereinafter referred 'Vendor') should first refer any issues/disputes to Engineer-in-Charge (EIC) for LOA/contracts/ Dealing C&P Executive for Purchase Orders and co-operate them for smooth execution of the contract and to timely address the issues, if any. For applicability of 'Quarterly Closure', please refer BDS.

44.2 ARBITRATION

All issue(s)/dispute(s) excluding the matters that have been specified as excepted matters and listed at clause no. 2.6 and which cannot be resolved through Conciliation, such issue(s)/dispute(s) shall be referred to arbitration for adjudication by Sole Arbitrator.

The party invoking the Arbitration shall have the option to either opt for Ad-hoc Arbitration as provided at Clause 2.1 below or Institutionalized Arbitration as provided at Clause 2.2 below, the remaining clauses from 2.3 to 2.7 shall apply to both Ad-hoc and Institutional Arbitration:-

2.1 On invocation of the Arbitration clause by either party, TFL shall suggest a panel of three independent and distinguished persons (Retd Supreme Court & High Court Judges only) to the other party from the Panel of Arbitrators maintained by 'Delhi International Arbitration Centre (DIAC) to select any one among them to act as the Sole Arbitrator. In the event of failure of the other party to select the Sole Arbitrator within 30 days from the receipt of the communication from TFL suggesting the panel of arbitrators, the right of selection of the sole arbitrator by the other party shall stand forfeited and TFL shall appoint the Sole Arbitrator from the suggested panel of three Arbitrators for adjudication of dispute(s). The decision of TFL on the appointment of the sole arbitrator shall be final and binding on the other party. The fees payable to Sole Arbitrator shall be governed by the fee Schedule of "Delhi International Arbitration Centre".

OR

2.2 If a dispute arises out of or in connection with this contract, the party invoking the

Date of Issue: 9th March'23



**COMPOSITE SUPPLY CUM ERECTION OF
ELECTRICAL & INSTRUMENTATION WORKS FOR
OSBL FACILITIES ON ITEM RATE BASIS
AT
TALCHER FERTILIZERS LIMITED, ANGUL,
ODISHA**

PC-183/ E-8003/ S-III

0

DOC. NO.

REV.

Page 37 of 142



Arbitration shall submit that dispute to any one of the Arbitral Institutions i.e ICADR/ICA/DIAC/SFCA and that dispute shall be adjudicated in accordance with their respective Arbitration Rules. The matter shall be adjudicated by a Sole Arbitrator who shall necessarily be a Retd. Supreme Court/High Court Judge to be appointed/nominated by the respective institution. The cost/expenses pertaining to the said Arbitration shall also be governed in accordance with the Rules of the respective Arbitral Institution. The decision of the party invoking the Arbitration for reference of dispute to a specific Arbitral institution for adjudication of that dispute shall be final and binding on both the parties and shall not be subject to any change thereafter. The institution once selected at the time of invocation of dispute shall remain unchanged.

- 2.3 The cost of arbitration proceedings shall be shared equally by the parties.
- 2.4 The Arbitration proceedings shall be in English language and the seat, venue and place of Arbitration shall be New Delhi, India only.
- 2.5 Subject to the above, the provisions of Arbitration & Conciliation Act 1996 and any amendment thereof shall be applicable. All matter relating to this Contract and arising out of invocation of Arbitration clause are subject to the exclusive jurisdiction of the Court(s) situated at New Delhi.
- 2.6 List of Excepted matters:
- Dispute(s)/issue(s) involving claims below Rs 25 lakhs and above Rs 25 crores.
 - Dispute(s)/issue(s) relating to indulgence of Contractor/Vendor/Bidder in corrupt/fraudulent/collusive/coercive practices and/or the same is under investigation by CBI or Vigilance or any other investigating agency or Government.
 - Dispute(s)/issue(s) wherein the decision of Engineer-In-Charge/owner/TFL has been made final and binding in terms of the Contract.
- 2.7. Disputes involving claims below Rs 25 Lakhs and above Rs. 25 crores:- Parties mutually agree that dispute(s)/issue(s) involving claims below Rs 25 Lakhs and above Rs 25 crores shall not be subject matter of Arbitration and are subject to the exclusive jurisdiction of the Court(s) situated at New Delhi.

44.3 GOVERNING LAW AND JURISDICTION:

The Contract shall be governed by and construed in accordance with the laws in force in India. The Parties hereby submit to the exclusive jurisdiction of the Courts situated at New Delhi for adjudication of disputes, injunctive reliefs, actions and proceedings, if any, arising out of this Contract.

Date of Issue: 9th March'23



**COMPOSITE SUPPLY CUM ERECTION OF
ELECTRICAL & INSTRUMENTATION WORKS FOR
OSBL FACILITIES ON ITEM RATE BASIS
AT
TALCHER FERTILIZERS LIMITED, ANGUL,
ODISHA**

PC-183/ E-8003/ S-III

0

DOC. NO.

REV.

Page 38 of 142



45. DISPUTES BETWEEN CPSE'S/ GOVERNMENT DEPARTMENT'S / ORGANIZATIONS

Subject to conciliation as provided above, in the event of any dispute (other than those related to taxation matters) or difference relating to the interpretation and application of the provisions of commercial contract(s) between Central Public Sector Enterprises (CPSEs)/ Port Trusts inter se and also between CPSEs and Government Departments /Organizations , such dispute or difference shall be taken up by either party for resolution only through AMRCD as mentioned in OPE OM No. 4(1)/2013-DPE(GM)/FTS-1835 dated 22-05-2018.

Any party aggrieved with the decision of the Committee at the First level (tier) may prefer an appeal before the Cabinet Secretary at the Second level (tier) within 15 days from the date of receipt of decision of the Committee at First level, through it's administrative Ministry/Department, whose decision will be final and binding on all concerned.

The above provisions mentioned at clause no. 44 & 45 shall supersede provisions relating to Conciliation, Arbitration, Governing Law & Jurisdiction and Disputes between CPSE's/ Government Department's/ Organizations mentioned in General Conditions of Contract (GCC) and elsewhere in tender document.

46. INAM-PRO (PLATFORM FOR INFRASTRUCTURE AND MATERIALS PROVIDERS)

INAM-Pro (Platform for infrastructure and materials providers) is a web based platform for infrastructure provides and materials suppliers and was developed by Ministry of Road Transport and Highways (MoRT&H) with a view to reduce project execution delays on account of supply shortages and inspire greater confidence in contractors to procure cement to start with directly from the manufacturers. Presently, numerous cement companies are registered in the portal and offering cement for sale on the portal with a commitment period of 3 years. These companies have bound themselves by ceiling rates for the entire commitment period, wherein they are allowed to reduce or increase their cement rates any number of times within the ceiling rate, but are not permitted to exceed the said ceiling rate.

MoRT&H is expanding the reach of this web-portal by increasing both the product width as well as the product depth. They are working on incorporating 60 plus product categories. The product range will span from large machineries like Earth Movers and Concrete Mixers, to even the smallest items like road studs. MoRT&H intend to turn it into a portal which services every infrastructure development related need of a modern contractor.

TFL's contractors may use this innovative platform, wherever applicable. The usage of web – Portal is a completely voluntary exercise. The platform, however, can serve as a benchmark for comparison of offered prices and products.

47. PROMOTION OF PAYMENT THROUGH CARDS AND DIGITAL MEANS

To promote cashless transactions, the onward payments by Contractors to their employees, service providers, sub-contractors and suppliers may be made through Cards

Date of Issue: 9th March'23



**COMPOSITE SUPPLY CUM ERECTION OF
ELECTRICAL & INSTRUMENTATION WORKS FOR
OSBL FACILITIES ON ITEM RATE BASIS
AT
TALCHER FERTILIZERS LIMITED, ANGUL,
ODISHA**

PC-183/ E-8003/ S-III

0

DOC. NO.

REV.

Page 39 of 142



and Digital means to the extent possible.

48 CONTRACTOR TO ENGAGE CONTRACT MANPOWER BELONGING TO SCHEDULED CASTES AND WEAKER SECTIONS OF THE SOCIETY

While engaging the contractual manpower, Contractors are required to make efforts to provide opportunity of employment to the people belonging to Scheduled Castes and weaker sections of the society also in order to have a fair representation of these sections.

49 PROVISIONS FOR STARTUPS (AS DEFINED IN GAZETTENOTIFICATION NO. D.L-33004/99 DATED 18.02.2016 AND 23.05.2017 OF MINISTRY OF COMMERCE AND INDUSTRY AND AS AMENDED FROM TIME TO TIME)

As mentioned in Section-II, Technical and Financial BEC shall be applicable for all Startups [whether Micro & Small Enterprises (MSEs) or otherwise].

Further, the Startups are also exempted from submission of EMDs.

If a Startup emerge lowest bidder, the LoA on such Startup shall be placed for entire tendered quantity/group/item/part (as the case may be). However, during the Kick of Meeting monthly milestones/ check points would be drawn. Further, the performance of such contractor/ service provider will be reviewed more carefully and action to be taken as per provision of contract in case of failure/ poor performance.



50 PROVISION REGARDING INVOICE FOR REDUCED VALUE OR CREDIT NOTE TOWARDS PRS

PRS is the reduction in the consideration / contract value for the / services covered under this contract. In case of delay in execution of service provider should raise invoice for reduced value as per Price Reduction Schedule Clause (PRS clause). If service provider has raised the invoice for full value, then service provider should issue Credit Note towards the applicable PRS amount with applicable taxes.

In such cases if service provider fails to submit the invoice with reduced value or does not issue credit note as mentioned above, TFL will release the payment to service provider after giving effect of the PRS clause with corresponding reduction of taxes charged on service provider's invoice, to avoid delay in payment.

In case any financial implication arises on TFL due to issuance of invoice without reduction in price or non-issuance of Credit Note, the same shall be to the account of service provider. TFL shall be entitled to deduct / setoff / recover such GST amount (CGST & SGST/UTGST or IGST) together with penalties and interest, if any, against any amounts paid or becomes payable by OWNER in future to the service provider's under this contract

Date of Issue: 9th March'23

	COMPOSITE SUPPLY CUM ERECTION OF ELECTRICAL & INSTRUMENTATION WORKS FOR OSBL FACILITIES ON ITEM RATE BASIS AT TALCHER FERTILIZERS LIMITED, ANGUL, ODISHA	PC-183/ E-8003/ S-III	0	
		DOC. NO.	REV.	
		Page 40 of 142		

or under any other contract.

51. UNIQUE DOCUMENT IDENTIFICATION NUMBER BY PRACTICING CHARTERED ACCOUNTANTS

Practicing Chartered Accountants shall generate Unique Document Identification Number (UDIN) for all certificates issued by them as per provisions of Tender Document.

However, UDIN may not be required for documents being attested by Chartered Accountants in terms of provisions of Tender Document

52. DOCUMENTS FOR PAYMENT:

Payment terms shall be as mentioned in GCC-Works/SCC.

However, for release of payment, Contractor is required to submit invoice along with other documents as mentioned in SCC. The final bill is to be submitted within one month after completion.



s

53. SUB-LETTING OF WORKS

The following is added to the Clause no. 37 of General Conditions of Contract (GCC)-Works:

- (i) Procurement of material, hire of equipment or engagement of labour will not mean sub-contracting.
- (ii) Sub-contracting by the contractor without the approval of TFL shall be a breach of contract, unless explicitly permitted in the contract.
- (iii) However, If specified in SCC Sub-contracting for Specialized Items of Work is allowed upto certain percentage of work

Date of Issue: 9th March'23

	COMPOSITE SUPPLY CUM ERECTION OF ELECTRICAL & INSTRUMENTATION WORKS FOR OSBL FACILITIES ON ITEM RATE BASIS AT TALCHER FERTILIZERS LIMITED, ANGUL, ODISHA	PC-183/ E-8003/ S-III	0	
		DOC. NO.	REV.	
		Page 41 of 142		

Annexure-I to Section-III



PROCEDURE FOR ACTION IN CASE CORRUPT/ FRAUDULENT/COLLUSIVE/COERCIVE PRACTICES

Annexure-I

A Definitions:

- A.1 "Corrupt Practice" means the offering, giving, receiving or soliciting, directly or indirectly, anything of value to improperly influence the actions in selection process or in contract execution.
"Corrupt Practice" also includes any omission for misrepresentation that may mislead or attempt to mislead so that financial or other benefit may be obtained or an obligation avoided.
- A.2 "Fraudulent Practice" means and include any act or omission committed by a agency or with his connivance or by his agent by misrepresenting/ submitting false documents and/ or false information or concealment of facts or to deceive in order to influence a selection process or during execution of contract/ order.
- A.3 "Collusive Practice amongst bidders (prior to or after bid submission)" means a scheme or arrangement designed to establish bid prices at artificial non-competitive levels and to deprive the Employer of the benefits of free and open competition.
- A.4 "Coercive practice" means impairing or harming or threatening to impair or harm directly or indirectly, any agency or its property to influence the improperly actions of an agency, obstruction of any investigation or auditing of a procurement process.
- A.5 "Vendor/Supplier/Contractor/Consultant/Bidder" is herein after referred as "Agency"
- A.6 "Appellate Authority" shall mean Committee of Directors consisting of Director (Finance) and Director (BD) for works centers under Director (Projects). For all other cases committee of Directors shall consist of Director (Finance) & Director (Projects).
- A.7 "Competent Authority" shall mean the authority, who is competent to take final decision for Suspension of business dealing with an Agency/ (ies) and Banning of business dealings with Agency/ (ies) and shall be the "Director" concerned.
- A.8 "Allied Agency" shall mean all concerns which come within the sphere of effective influence of the banned/suspended agency shall be treated as allied agency. In determining this, the following factors may be taken into consideration:
- Whether the management is common;
 - Majority interest in the management is held by the partners or directors of banned/ suspended agency;
 - Substantial or majority shares are owned by the banned/ suspended agency and by virtue of this it has a controlling voice.
 - Directly or indirectly controls, or is controlled by or is under common control with another bidder.
 - All successor agency will also be considered as allied agency.

Date of Issue: 9th March'23

	COMPOSITE SUPPLY CUM ERECTION OF ELECTRICAL & INSTRUMENTATION WORKS FOR OSBL FACILITIES ON ITEM RATE BASIS AT TALCHER FERTILIZERS LIMITED, ANGUL, ODISHA	PC-183/ E-8003/ S-III	0	
		DOC. NO.	REV.	
		Page 42 of 142		

A.9 “Investigating Agency” shall mean any department or unit of TFL investigating into the conduct of Agency/ party and shall include the Vigilance Department of the TFL, Central Bureau of Investigation, State Police or any other agency set up by the Central or state government having power to investigate.

A.10 "Obstructive practice": materially impede the procuring entity's investigation into allegations of one or more of the above mentioned practices either by deliberately destroying, falsifying, altering; or by concealing of evidence material to the investigation; or by making false statements to investigators and/ or by threatening, harassing or intimidating any party to prevent it from disclosing its knowledge of matters relevant to the investigation or from pursuing the investigation; or by impeding TFL's rights of audit or access to information.

B Actions against bidder(s) indulging in corrupt /fraudulent/ collusive/ coercive practice

B.1 Irregularities noticed during the evaluation of the bids:

If it is observed during bidding process/ bids evaluation stage that a bidder has indulged in corrupt/fraudulent /collusive/coercive practice, the bid of such Bidder (s) shall be rejected and its Earnest Money Deposit (EMD) shall be forfeited.

Further, such agency shall be banned for future business with TFL for a period specified in para B 2.2 below from the date of issue of banning order.

B.2 Irregularities noticed after award of contract

(i) During execution of contract:

If an agency, is found to have indulged in corrupt/fraudulent/ collusive/coercive practices, action shall be initiated for putting the agency on banning list.



After conclusion of process and issuance of Speaking order for putting party on banning list, the order (s)/ contract (s) where it is concluded that such irregularities have been committed shall be terminated and Contract cum Performance Bank Guarantee (CPBG) submitted by agency against such order (s)/ contract (s) shall also be forfeited. Further such order/ contract will be closed following the due procedure in this regard.

The amount that may have become due to the contractor on account of work already executed by him shall be payable to the contractor and this amount shall be subject to adjustment against any amounts due from the contractor under the terms of the contract. No risk and cost provision will be enforced in such cases.

Suspension of order/ contract:

Further, only in the following situations, the concerned order (s)/ contract(s) (where Corrupt/Fraudulent/ Collusive/ Coercive Practices are observed) and payment shall

Date of Issue: 9th March'23

	COMPOSITE SUPPLY CUM ERECTION OF ELECTRICAL & INSTRUMENTATION WORKS FOR OSBL FACILITIES ON ITEM RATE BASIS AT TALCHER FERTILIZERS LIMITED, ANGUL, ODISHA	PC-183/ E-8003/ S-III	0	
		DOC. NO.	REV.	
		Page 43 of 142		

be suspended after issuance of Suspension cum Show Cause Notice:

- (i) Head of Corporate Vigilance Department/CVO based on the investigation by them, recommend for specific immediate action against the agency.
- (ii) Head of Corporate Vigilance Department/CVO based on the input from investigating agency, forward for specific immediate action against the agency.

Suspension cum Show Cause Notice being issued in above cases after approval of the competent authority (as per provisions mentioned under Clause no. D) shall also include the provision for suspension of Order (s)/ Contract (s) and payment. Accordingly, after issuance of Suspension cum Show Cause Notice, the formal communication for suspension of Order (s)/ Contract (s) and payment with immediate effect will be issued by the concerned person of TFL.

During suspension, Contractor/ Service Providers will be allowed to visit the plant/ site for upkeep of their items/ equipment, TFL's issued materials (in case custody of same is not taken over), demobilizing the site on confirmation of EIC, etc.

In addition to above, Recovery of payments (other than due payments) including balance advance payments, if any, made by along with interest thereon at the prevailing rate shall be recovered.

(ii) After execution of contract and during Defect liability period (DLP)/ Warranty/Guarantee Period:

If an agency is found to have indulged in corrupt/fraudulent/ collusive/coercive practices, after execution of contract and during DLP/ Warranty/Guarantee Period, the agency shall be banned for future business with TFL for a period specified in para B 2.2 below from the date of issue of banning order.

Further, the Contract cum Performance Bank Guarantee (CPBG)/Contract Performance Security (CPS) submitted by agency against such order (s)/ contract (s) shall be forfeited.

(iii) After expiry of Defect liability period (DLP)/ Warranty/Guarantee Period

If an agency is found to have indulged in corrupt/fraudulent/ collusive/coercive practices, after expiry of Defect liability period (DLP)/ Warranty/Guarantee Period, the agency shall be banned for future business with TFL for a period specified in para B 2.2 below from the date of issue of banning order.

B.2.2 Period of Banning

The period of banning of agencies indulged in Corrupt/Fraudulent/Collusive/Coercive Practices shall be as under and to be reckoned from the date of banning order:

Date of Issue: 9th March'23



**COMPOSITE SUPPLY CUM ERECTION OF
ELECTRICAL & INSTRUMENTATION WORKS FOR
OSBL FACILITIES ON ITEM RATE BASIS
AT
TALCHER FERTILIZERS LIMITED, ANGUL,
ODISHA**

PC-183/ E-8003/ S-III

0

DOC. NO.

REV.

Page 44 of 142





S. No.	Description	Period of banning from the date of issuance of Banning order
1	Misrepresentation/False information other than pertaining to BEC of tender but having impact on the selection process. For example, if an agency confirms not being in holiday in TFL/PSU's PMC or banned by PSUs/ Govt. Dept., liquidation, bankruptcy & etc. and subsequently it is found otherwise, such acts shall be considered in this category.	06 Months
2	Corrupt/Fraudulent (except mentioned sl. no. 1 above) /Collusive/Coercive Practices If an agency again commits Corrupt/Fraudulent (except mentioned sl. no. 1 above) /Collusive/ Coercive Practices in subsequent cases after their banning, such situation of repeated offense to be dealt with more severity	01 year 2 years (in addition to the period already served)
3	Indulged in unauthorized disposal of materials provided by TFL	2 years
4	If act of vendor/ contractor is a threat to the National Security	2 years

C Effect of banning on other ongoing contracts/ tenders

- C.1 If an agency is put on Banning, such agency should not be considered in ongoing tenders/future tenders.
- C.2 However, if such an agency is already executing other order (s)/ contract (s) where no corrupt/fraudulent/ collusive/coercive practice is found, the agency should be allowed to continue till its completion without any further increase in scope except those incidental to original scope mentioned in the contract.
- C.3 If an agency is put on the Banning List during tendering and no irregularity is found in the case under process:
- C.3.1 after issue of the enquiry /bid/tender but before opening of Technical bid, the bid submitted by the agency shall be ignored.
- C.3.2 after opening Technical bid but before opening the Price bid, the Price bid of the agency shall not be opened and BG/EMD submitted by the agency shall be returned to the agency.

Date of Issue: 9th March'23

	COMPOSITE SUPPLY CUM ERECTION OF ELECTRICAL & INSTRUMENTATION WORKS FOR OSBL FACILITIES ON ITEM RATE BASIS AT TALCHER FERTILIZERS LIMITED, ANGUL, ODISHA	PC-183/ E-8003/ S-III	0	
		DOC. NO.	REV.	
		Page 45 of 142		

C.3.3 after opening of price, BG/EMD made by the agency shall be returned; the offer of the agency shall be ignored & will not be further evaluated. . In case such agency is lowest (L-1), next lowest bidder shall be considered as L-1

D. Procedure for Suspension of Bidder

D.1 Initiation of Suspension

Action for suspension business dealing with any agency/(ies) shall be initiated by Corporate C&P Department when

- (i) Corporate Vigilance Department based on the fact of the case gathered during investigation by them recommend for specific immediate action against the agency.
- (ii) Corporate Vigilance Department based on the input from Investigating agency, forward for specific immediate action against the agency.
- (iii) Non performance of Vendor/Supplier/Contractor/Consultant leading to termination of Contract/ Order.

D.2 Suspension Procedure:



- D.2.1 The order of suspension would operate initially for a period not more than six months and is to be communicated to the agency and also to Corporate Vigilance Department. Period of suspension can be extended with the approval of the Competent Authority by one month at a time with a ceiling of six months pending a conclusive decision to put the agency on banning list.
- D.2.2 During the period of suspension, no new business dealing may be held with the agency.
- D.2.3 Period of suspension shall be accounted for in the final order passed for banning of business with the agency.
- D.2.4 The decision regarding suspension of business dealings should also be communicated to the agency.
- D.2.5 If a prima-facie, case is made out that the agency is guilty on the grounds which can result in banning of business dealings, proposal for issuance of suspension order and show cause notice shall be put up to the Competent Authority. The suspension order and show cause notice must include that (i) the agency is put on suspension list and (ii) why action should not be taken for banning the agency for future business from TFL. The competent authority to approve the suspension will be same as that for according approval for banning.

D 3 Effect of Suspension of business:

Effect of suspension on other on-going/future tenders will be as under:

- D.3.1 No enquiry/bid/tender shall be entertained from an agency as long as the name of agency appears in the Suspension List.

Date of Issue: 9th March'23



	COMPOSITE SUPPLY CUM ERECTION OF ELECTRICAL & INSTRUMENTATION WORKS FOR OSBL FACILITIES ON ITEM RATE BASIS AT TALCHER FERTILIZERS LIMITED, ANGUL, ODISHA	PC-183/ E-8003/ S-III	0	
		DOC. NO.	REV.	
		Page 46 of 142		

- D.3.2 If an agency is put on the Suspension List during tendering:
- D.3.2.1 after issue of the enquiry /bid/tender but before opening of Technical bid, the bid submitted by the agency shall be ignored.
- D.3.2.2 after opening Technical bid but before opening the Price bid, the Price bid of the agency shall not be opened and BG/EMD submitted by the agency shall be returned to the agency.
- D.3.2.3 after opening of price, BG/EMD made by the agency shall be returned; the offer of the agency shall be ignored & will not be further evaluated. In case such agency is lowest (L-1), next lowest bidder shall be considered as L-1.
- D.3.3 The existing contract (s)/ order (s) under execution shall continue.
- D.3.4 Tenders invited for procurement of goods, works and services shall have provision that the bidder shall submit a undertaking to the effect that (i) neither the bidder themselves nor their allied agency/(ies) are on banning list of TFL and(ii) bidder is not banned by any Government department/ Public Sector.

F. Appeal against the Decision of the Competent Authority:

- F.1 The agency may file an appeal against the order of the Competent Authority for putting the agency on banning list. The appeal shall be filed to Appellate Authority. Such an appeal shall be preferred within one month from the of receipt of banning order.
- F.2 Appellate Authority would consider the appeal and pass appropriate order which shall be communicated to the party as well as the Competent Authority.
- F.3 Appeal process may be completed within 45 days of filing of appeal with the Appellate Authority.

- G.** Wherever there is contradiction with respect to terms of 'Integrity pact' , GCC and 'Procedure for action in case of Corrupt/Fraudulent/ Collusive/Coercive Practice', the provisions of 'Procedure for action in case of Corrupt/Fraudulent/ Collusive/Coercive Practice' shall prevail.

	COMPOSITE SUPPLY CUM ERECTION OF ELECTRICAL & INSTRUMENTATION WORKS FOR OSBL FACILITIES ON ITEM RATE BASIS AT TALCHER FERTILIZERS LIMITED, ANGUL, ODISHA	PC-183/ E-8003/ S-III	0	
		DOC. NO.	REV.	
		Page 47 of 142		

Annexure-II to Section III

PROCEDURE FOR EVALUATION OF PERFORMANCE OF VENDORS/ SUPPLIERS/ CONTRACTORS/ CONSULTANTS

1.0 GENERAL

A system for evaluation of Vendors/ Suppliers/Contractors/ Consultants and their performance is a key process and important to support an effective purchasing & contracting function of an organization.

Performance of all participating Vendors/ Suppliers/Contractors/ Consultants need to be closely monitored to ensure timely receipt of supplies from a Vendor, completion of an assignment by a Consultant or complete execution of order by a contractor within scheduled completion period. For timely execution of projects and meeting the operation & maintenance requirement of operating plants, it is necessary to monitor the execution of order or contracts right from the award stage to completion stage and take corrective measures in time.

2.0 OBJECTIVE

The objective of Evaluation of Performance aims to recognize, and develop reliable Vendors/ Suppliers/Contractors/ Consultants so that they consistently meet or exceed expectations and requirements.

The purpose of this procedure is to put in place a system to monitor performance of Vendors/ Suppliers/Contractors/ Consultants associated with TFL so as to ensure timely completion of various projects, timely receipt of supplies including completion of works & services for operation and maintenance of operating plants and quality standards in all respects.



3.0 METHODOLOGY

i) Preparation of Performance Rating Data Sheet

Performance rating data Sheet for each and every Vendor/ Supplier/Contractor/Consultant for all orders/Contracts with a value of Rs. 50 Lakhs and above is recommended to be drawn up. Further, Performance rating data Sheet for orders/contracts of Vendor/Supplier/Contractor/ Consultant who are on watch list/holiday list/ banning list shall be prepared irrespective of order/ contract value. These data sheets are to be separately prepared for orders/ contracts related to Projects and O&M. Format, Parameters, Process, responsibility for preparation of Performance Rating Data Sheet are separately mentioned.

ii) Measurement of Performance

Date of Issue: 9th March'23

	COMPOSITE SUPPLY CUM ERECTION OF ELECTRICAL & INSTRUMENTATION WORKS FOR OSBL FACILITIES ON ITEM RATE BASIS AT TALCHER FERTILIZERS LIMITED, ANGUL, ODISHA	PC-183/ E-8003/ S-III	0	
		DOC. NO.	REV.	
		Page 48 of 142		

Based on the parameters defined in Data Sheet, Performance of concerned Vendor/ Supplier/Contractor/ Consultant would be computed and graded accordingly. The measurement of the performance of the Party would be its ability to achieve the minimum scoring of 60% points in the given parameters.

iii) Initiation of Measures:

Depending upon the Grading of Performance, corrective measures would be initiated by taking up the matter with concerned Vendor/ Supplier/Contractor/ Consultant. Response of Vendor/ Supplier/Contractor/ Consultant would be considered before deciding further course of action.

iv) Implementation of Corrective Measures:

Based on the response of Vendor/ Supplier/Contractor/ Consultant, concerned Engineer-in-Charge for the Projects and/or OIC in case of O&M would recommend for continuation or discontinuation of such party from the business of TFL.

v) Orders/contracts placed on Proprietary/OEM basis for O&M will be evaluated and, if required, corrective action will be taken for improvement in future.

4.0 EXCLUSIONS:

The following would be excluded from the scope of evaluation of performance of Vendors/ Suppliers/Contractors/ Consultants:

- i) Orders/Contracts below the value of Rs. 50 Lakhs if Vendor/ Supplier/Contractor/ Consultant is not on watch list/ holiday list/ banning list.
- ii) Orders for Misc./Administrative items/ Non stock Non valued items (PO with material code ending with 9).



However, concerned Engineer-in-Charge /OICs will continue to monitor such cases so as to minimize the impact on Projects/O&M plants due to non performance of Vendors/ Suppliers/Contractors/ Consultants in all such cases.

5.0 PROCESS OF EVALUATION OF PERFORMANCE OF VENDORS/ SUPPLIERS/ CONTRACTORS/ CONSULTANTS

5.1 FOR PROJECTS

- i) Evaluation of performance of Vendors/ Suppliers/Contractors/ Consultants in case of PROJECTS shall be done immediately with commissioning of any Project.
- ii) On commissioning of any Project, EIC (Engineer-in-charge)/ Project-in-charge shall prepare a Performance Rating Data Sheet (Format at Annexure-1) for all Orders and Contracts.

Date of Issue: 9th March'23

	COMPOSITE SUPPLY CUM ERECTION OF ELECTRICAL & INSTRUMENTATION WORKS FOR OSBL FACILITIES ON ITEM RATE BASIS AT TALCHER FERTILIZERS LIMITED, ANGUL, ODISHA	PC-183/ E-8003/ S-III	0	
		DOC. NO.	REV.	
		Page 49 of 142		

- iii) Depending upon the Performance Rating, following action shall be initiated by Engineer-in-charge/Project-in-charge:

Sl.No.	Performance Rating	Action
1	POOR	Seek explanation for Poor performance
2	FAIR	Seek explanation for Fair performance
3	GOOD	Letter to the concerned for improving performance in future
4	VERY GOOD	No further action

- iv) Reply from concerned Vendor/ Supplier/Contractor/ Consultant shall be examined. In case of satisfactory reply, Performance Rating data Sheet to be closed with a letter to the concerned for improving performance in future.
- v) When no reply is received or reasons indicated are unsatisfactory, the following actions need to be taken:

- A) Where performance rating is "POOR" (as per Performance Rating carried out after execution of Order/ Contract and where no reply/ unsatisfactory reply is received from party against the letter seeking the explanation from Vendor/Supplier/Contractor/ Consultant along with sharing the performance rating)

Recommend such defaulting Vendor / Supplier / Contractor / Consultant for the following action:



1. Poor Performance on account of Quality (if marks obtained against Quality parameter is less than 20):

- (a) **First Instance: Holiday (Red Card) for One Year**
(b) **Subsequent instance (s) in other ongoing order (s)/ contract (s) or new order (s) /contact (s) on such Vendor/ Supplier/ Contractor/ Consultant: Holiday (Red Card) for Two Years**

2. Poor Performance on account of other than Quality (if marks obtained against Quality parameter is more than 20):

- (a) **First such instance: Advisory notice (Yellow Card)** shall be issued and Vendor/Supplier/Contractor/ Consultant shall be put on watch list for a period of Two (2) Years.
(b) **Second such instance in other ongoing order (s)/ contract (s) or new order (s) /contact (s) on such Vendor/ Supplier/ Contractor/ Consultant: Putting on Holiday (Red Card) for a period of One Year**
(c) **Subsequent instances (more than two) in other ongoing order (s)/ contract (s) or new order (s) /contact (s) on such Vendor/ Supplier/ Contractor/ Consultant: Putting**

Date of Issue: 9th March'23

	COMPOSITE SUPPLY CUM ERECTION OF ELECTRICAL & INSTRUMENTATION WORKS FOR OSBL FACILITIES ON ITEM RATE BASIS AT TALCHER FERTILIZERS LIMITED, ANGUL, ODISHA	PC-183/ E-8003/ S-III	0	
		DOC. NO.	REV.	
		Page 50 of 142		

on Holiday (Red Card) for a period of Two Years.

B) Where Poor/Non-Performance leading to termination of contract or Offloading of contract due to poor performance attributable to Vendor/Supplier/ Contractor/Consultant (under clause no. 34.2.3 of GCC)

(a) **First instance: Advisory notice (Yellow Card)** shall be issued and Vendor/Supplier/Contractor /Consultant shall be put on watch list for a period of Two (2) Years.

Further such vendor will not be allowed to participate in the re-tender of the same supply/work/services of that location which has terminated / offloaded. Moreover, it will be ensured that all other action as per provision of contract including forfeiture of Contract Performance Security (CPS) etc. are undertaken.

However, such vendor will be allowed to participate in all other tenders and to execute other ongoing order/ contract (s) or new contract/ order (s).

The Yellow card will be automatically revoked after a period of two years unless the same is converted into Red Card due to subsequent instances of poor/ non-performance in other ongoing order (s)/ contract (s) or new order (s) /contact (s) on such Vendor/ Supplier/ Contractor/ Consultant.

(b) **Second instances** in other ongoing order (s)/ contract (s) or new order (s) /contact (s) on such Vendor/ Supplier/ Contractor/ Consultant: **Holiday (Red Card)** for period of One Year and they shall also to be considered for Suspension.

(c) **Subsequent instances (more than two)** in other ongoing order (s)/ contract (s) or new order (s) /contact (s) on such Vendor/ Supplier/ Contractor/ Consultant: **Holiday (Red Card) for period of Two Years and they shall also to be considered for Suspension.**



(C) Where Performance rating is "FAIR":

Issuance of warning to such defaulting Vendor/ Supplier/Contractor/ Consultant to improve their performance.

5.2 FOR CONSULTANCY JOBS

Monitoring and Evaluation of consultancy jobs will be carried out in the same way as described in para 5.1 for Projects.

Date of Issue: 9th March'23

	COMPOSITE SUPPLY CUM ERECTION OF ELECTRICAL & INSTRUMENTATION WORKS FOR OSBL FACILITIES ON ITEM RATE BASIS AT TALCHER FERTILIZERS LIMITED, ANGUL, ODISHA	PC-183/ E-8003/ S-III	0	
		DOC. NO.	REV.	
		Page 51 of 142		

5.3 FOR OPERATION & MAINTENANCE

- i) Evaluation of performance of Vendors/ Suppliers/Contractors/ Consultants in case of Operation and Maintenance shall be done immediately after execution of order/ contract.
- ii) After execution of orders a Performance Rating Data Sheet (Format at Annexure-2) shall be prepared for Orders by Site C&P and for Contracts/Services by respective Engineer-In-Charge.
- iii) Depending upon Performance Rating, following action shall be initiated by EIC:

Sl. No.	Performance Rating	Action
1	POOR	Seek explanation for Poor performance
2.	FAIR	Seek explanation for Fair performance
3	GOOD	Letter to the concerned for improving performance in future.
4	VERY GOOD	No further action



- iv) Reply from concerned Vendor/ Supplier/Contractor/ Consultant shall be examined. In case of satisfactory reply, Performance Rating data Sheet to be closed with a letter to the concerned for improving performance in future.
- v) When no reply is received or reasons indicated are unsatisfactory, the following actions need to be taken:

- A) Where performance rating is "POOR" (as per Performance Rating carried out after execution of Order/ Contract and where no reply/ unsatisfactory reply is received from party against the letter seeking the explanation from Vendor/Supplier/Contractor/ Consultant along with sharing the performance rating)

Recommend such defaulting Vendor / Supplier / Contractor / Consultant for the following action:

1. Poor Performance on account of Quality (if marks obtained against Quality parameter is less than 20):
 - (a) **First Instance: Holiday (Red Card) for Two One Years**
 - (b) **Subsequent instance (s) in other ongoing order (s)/ contract (s) or new order (s) /contact (s) on such Vendor/ Supplier/ Contractor/ Consultant: Holiday (Red Card) for Three TwoYears**
2. Poor Performance on account of other than Quality (if marks obtained against Quality parameter is more than 20):
 - (a) **First such instance:Advisory notice(Yellow Card)** shall be issued and Vendor/Supplier/Contractor/ Consultantshall be put on watch list for a period of Two(2) Years.

Date of Issue: 9th March'23

	COMPOSITE SUPPLY CUM ERECTION OF ELECTRICAL & INSTRUMENTATION WORKS FOR OSBL FACILITIES ON ITEM RATE BASIS AT TALCHER FERTILIZERS LIMITED, ANGUL, ODISHA	PC-183/ E-8003/ S-III	0	
		DOC. NO.	REV.	
		Page 52 of 142		

- (b) Second such instance in other ongoing order (s)/ contract (s) or new order (s) /contact (s) on such Vendor/ Supplier/ Contractor/ Consultant: Putting on Holiday (Red Card) for a period of One Year
- (c) Subsequent instances (more than two) in other ongoing order (s)/ contract (s) or new order (s) /contact (s) on such Vendor/ Supplier/ Contractor/ Consultant: Putting on Holiday (Red Card) for a period of TwoYears.

B) Where Poor/Non-Performance leading to termination of contract or Offloading of contract due to poor performance attributable to Vendor/Supplier/ Contractor/Consultant (under clause no. 34.2.3 of GCC)

(a) **First instance: Advisory notice (Yellow Card)** shall be issued and Vendor/Supplier/Contractor /Consultant shall be put on watch list for a period of Two(2) Years.

Further such vendor will not be allowed to participate in the re-tender of the same supply/work/services of that location which has terminated / offloaded. Moreover, it will be ensured that all other action as per provision of contract including forfeiture of Contract Performance Security (CPS) etc. are undertaken.

However, such vendor will be allowed to participate in all other tenders and to execute other ongoing order/ contract (s) or new contract/ order (s).

The Yellow card will be automatically revoked after a period of two years unless the same is converted into Red Card due to subsequent instances of poor/ non-performance in other ongoing order (s)/ contract (s) or new order (s) /contact (s) on such Vendor/ Supplier/ Contractor/ Consultant.

(b) **Second instances** in other ongoing order (s)/ contract (s) or new order (s) /contact (s) on such Vendor/ Supplier/ Contractor/ Consultant: **Holiday (Red Card)** for period of One Year and they shall also to be considered for Suspension.



(c) **Subsequent instances (more than two)** in other ongoing order (s)/ contract (s) or new order (s) /contact (s) on such Vendor/ Supplier/ Contractor/ Consultant: **Holiday (Red Card) for period of TwoYears and they shall also to be considered for Suspension.**

(C) Where Performance rating is "FAIR"

Issuance of warning to such defaulting Vendors/Contractors/Consultants to improve their performance.

6.0 REVIEW & RESTORATION OF PARITES PUT ON HOLIDAY

Date of Issue: 9th March'23

	COMPOSITE SUPPLY CUM ERECTION OF ELECTRICAL & INSTRUMENTATION WORKS FOR OSBL FACILITIES ON ITEM RATE BASIS AT TALCHER FERTILIZERS LIMITED, ANGUL, ODISHA	PC-183/ E-8003/ S-III	0	
		DOC. NO.	REV.	
		Page 53 of 142		

- 6.1 An order for Holiday passed for a certain specified period shall deemed to have been automatically revoked on the expiry of that specified period and it will not be necessary to issue a specific formal order of revocation.

Further, in case Vendor/ Supplier/Contractor/ Consultant is put on holiday due to quality, and new order is placed on bidder after restoration of Vendor/ Supplier/Contractor/ Consultant, such order will be properly monitored during execution stage by the concerned site.

7.0 EFFECT OF HOLIDAY

- 7.1 If a Vendor/ Supplier/Contractor/ Consultant is put on Holiday, such Vendor/ Supplier/Contractor/ Consultant shall not be considered in ongoing tenders/future tenders.

- 7.2 However, if such Vendor/ Supplier/Contractor/ Consultant is already executing any other order/ contract and their performance is satisfactory in terms of the relevant contract, should be allowed to continue till its completion without any further increase in scope except those incidental to original scope mentioned in the contract. In such a case CPBG will not be forfeited and payment will be made as per provisions of concerned contract. However, this would be without prejudice to other terms and conditions of the contract.

- 7.3. Effect on other ongoing tendering:

- 7.3.1 After issue of the enquiry /bid/tender but before opening of Technical bid, the bid submitted by the party shall be ignored.



- 7.3.2 After opening Technical bid but before opening the Price bid, the Price bid of the party shall not be opened and BG/EMD submitted by the party shall be returned to the party.

- 7.3.3 After opening of price, BG/EMD made by the party shall be returned; the offer of the party shall be ignored & will not be further evaluated. In case such agency is lowest (L-1), next lowest bidder shall be considered as L-1.

- 8.0** While putting the Vendor/ Supplier/Contractor/ Consultant on holiday as per the procedure, the holding company, subsidiary, joint venture, sister concerns, group division of the errant Vendor/ Supplier/Contractor/ Consultant shall not be considered for putting on holiday list. Any bidder, put on holiday, will not be allowed to bid through consortium route also in new tender during the period of holiday.

- 9.0** If an unsuccessful bidder makes any vexatious, frivolous or malicious complaint against the tender process with the intention of delaying or defeating any procurement or causing loss to TFL or any other bidder, such bidder will be put on holiday for a period of six months, if such complaint is proved to be vexatious, frivolous or malicious, after following the due procedure.

Date of Issue: 9th March'23

	COMPOSITE SUPPLY CUM ERECTION OF ELECTRICAL & INSTRUMENTATION WORKS FOR OSBL FACILITIES ON ITEM RATE BASIS AT TALCHER FERTILIZERS LIMITED, ANGUL, ODISHA	PC-183/ E-8003/ S-III	0	
		DOC. NO.	REV.	
		Page 54 of 142		

10. APPEAL AGAINST THE DECISION OF THE COMPETENT AUTHORITY:

- (a) The party may file an appeal against the order of the Competent Authority for putting the party on Holiday list. The appeal shall be filed to Appellate Authority. Such an appeal shall be preferred within one month from the of receipt of Holiday order.
- (b) Appellate Authority would consider the appeal and pass appropriate order which shall be communicated to the party as well as the Competent Authority.
- (c) Appeal process may be completed within 45 days of filing of appeal with the Appellate Authority.
- (d) "Appellate Authority" shall mean Committee of Directors consisting of Director (Finance) and Director (BD) for works centers under Director (Projects). For all other cases committee of Directors shall consist of Director (Finance) & Director (Projects).

11. ERRANT BIDDER

In case after price bid opening the lowest evaluated bidder (L1) is not awarded the job for any mistake committed by him in bidding or withdrawal of bid or modification of bid or varying any term in regard thereof leading to re-tendering, TFL shall forfeit EMD if paid by the bidder and such bidders shall be debarred from participation in retendering of the same job(s)/item(s).



Further, such bidder will be put on Watch List (Yellow Card) for a period of two years after following the due procedure. However, during the period in watch list such vendor will be allowed to participate in all other tenders and to execute other ongoing order/ contract (s) or new contract/ order (s).

In case of subsequent instances of default in other tender(s) during aforesaid watch list period, the action shall be initiated as per provision of sl. no. 2 of para A of Clause no. 5.1 (v) and 5.3 (v).

The Yellow card will be automatically revoked after specified period unless the same is converted into Red Card

12. In case CBIC (Central Board of Indirect Taxes and Customs)/ any tax authority / any equivalent government agency brings to the notice of TFL that the Supplier has not remitted the amount towards GST (CGST & SGST/UTGST or IGST) collected from TFL to the government exchequer, then, that Supplier shall be put under Holiday list of TFL for period of six months after following the due procedure. This action will be in addition to the right of recovery of financial implication arising on TFL.

Date of Issue: 9th March'23

	COMPOSITE SUPPLY CUM ERECTION OF ELECTRICAL & INSTRUMENTATION WORKS FOR OSBL FACILITIES ON ITEM RATE BASIS AT TALCHER FERTILIZERS LIMITED, ANGUL, ODISHA	PC-183/ E-8003/ S-III	0	
		DOC. NO.	REV.	
		Page 55 of 142		

Annexure-1

**TALCHER FERTILIZERS LIMITED
PERFORMANCE RATING DATA SHEET
(FOR PROJECTS/ CONSULTANCY JOBS)**

- i) Project/Work Centre :
ii) Order/ Contract No. & date :
iii) Brief description of Items :
Works/Assignment :
iv) Order/Contract value (Rs.) :
v) Name of Vendor/Supplier/ :
Contractor/ Consultant :
vi) Contracted delivery/ :
Completion Schedule :
vii) Actual delivery/ :
Completion date :

Performance Parameter	Delivery/ Completion Performance	Quality Performance	Reliability Performance#	Total
Maximum Marks	40	40	20	100
Marks Allocated				

Note:

Remarks (if any)

PERFORMANCE RATING (**)

Note :



(#) Vendor/Supplier/Contractor/Consultant who seek repeated financial assistance or deviation beyond contract payment term or seeking direct payment to the sub-vendor/sub-contractor due to financial constraints, then '0' marks should be allotted against Reliability Performance.

(*) Allocation of marks should be as per enclosed instructions

(**) Performance rating shall be classified as under :

Sl. No.	Range (Marks)	Rating
1	60 & below	POOR
2	61-75	FAIR
3	76-90	GOOD
4	More than 90	VERY GOOD

Date of Issue: 9th March'23

	COMPOSITE SUPPLY CUM ERECTION OF ELECTRICAL & INSTRUMENTATION WORKS FOR OSBL FACILITIES ON ITEM RATE BASIS AT TALCHER FERTILIZERS LIMITED, ANGUL, ODISHA	PC-183/ E-8003/ S-III	0	
		DOC. NO.	REV.	
		Page 56 of 142		

Signature of
Authorised Signatory:

Name:

Designation:

Instructions for allocation of marks

1. Marks are to be allocated as under:

1.1	DELIVERY/ COMPLETION PERFORMANCE	40 Marks
Marks	Delivery Period/ Completion Schedule	Delay in Weeks
	a) Upto 3 months	Before CDD
		Delay upto 4 weeks
		" 8 weeks
		" 10 weeks
		" 12 weeks
		" 16 weeks
		More than 16 weeks
		40
		35
		30
		25
		20
		15
		0
	b) Above 3 months	Before CDD
		Delay upto 4 weeks
		" 8 weeks
		" 10 weeks
		" 16 weeks
		" 20 weeks
		" 24 weeks
		More than 24 weeks
		40
		35
		30
		25
		20
		15
		10
		0

Date of Issue: 9th March'23



**COMPOSITE SUPPLY CUM ERECTION OF
ELECTRICAL & INSTRUMENTATION WORKS FOR
OSBL FACILITIES ON ITEM RATE BASIS
AT
TALCHER FERTILIZERS LIMITED, ANGUL,
ODISHA**

PC-183/ E-8003/ S-III

0

DOC. NO.

REV.

Page 57 of 142



1.2 QUALITY PERFORMANCE

40 Marks

For Normal Cases : No Defects/ No Deviation/ No failure: 40 marks

i) Rejection/Defects Marks to be allocated on prorata basis for acceptable quantity as compared to total quantity for normal cases 10 marks

ii) When quality Failure of severe nature 0

marks

failure endanger system integration and safety of the system - Moderate nature 5 marks
- low severe nature 10-25 marks

iii) Number of deviations 1. No deviation 5 marks
2. No. of deviations ≤ 2 2 marks
3. No. of deviations > 2 0 marks

1.3 RELIABILITY PERFORMANCE

20 Marks

A.	FOR WORKS/CONTRACTS	
i)	Submission of order acceptance, agreement, PBG, Drawings and other documents within time	4 marks
ii)	Mobilization of resources as per Contract and in time	4 marks
iii)	Liquidation of Check-list points	4 marks
iv)	Compliance to statutory and HS&E requirements or Reliability of Estimates/Design/Drawing etc. in case of Consultancy jobs	4 marks

Date of Issue: 9th March'23



**COMPOSITE SUPPLY CUM ERECTION OF
ELECTRICAL & INSTRUMENTATION WORKS FOR
OSBL FACILITIES ON ITEM RATE BASIS
AT
TALCHER FERTILIZERS LIMITED, ANGUL,
ODISHA**

PC-183/ E-8003/ S-III

0

DOC. NO.



REV.

Page 58 of 142



v)	Timely submission of estimates and other documents for Extra, Substituted & AHR items	4 marks
B.	FOR SUPPLIES	
i)	Submission of order acceptance, PBG, Drawings and other documents within time	5 marks
ii)	Attending complaints and requests for after sales service/ warranty repairs and/ or query/ advice (upto the evaluation period).	5 marks
iii)	Response to various correspondence and conformance to standards like ISO	5 marks
iv)	Submission of all required documents including Test Certificates at the time of supply	5 marks

Date of Issue: 9th March'23

	COMPOSITE SUPPLY CUM ERECTION OF ELECTRICAL & INSTRUMENTATION WORKS FOR OSBL FACILITIES ON ITEM RATE BASIS AT TALCHER FERTILIZERS LIMITED, ANGUL, ODISHA	PC-183/ E-8003/ S-III	0	
		DOC. NO.	REV.	
		Page 59 of 142		

Annexure-2

**TALCHER FERTILIZERS LIMITED
PERFORMANCE RATING DATA SHEET
(FOR O&M)**

- i) Location :
- ii) Order/ Contract No. & date :
- iii) Brief description of Items :
Works/Assignment :
- iv) Order/Contract value (Rs.) :
- v) Name of Vendor/Supplier/ :
Contractor/ Consultant :
- vi) Contracted delivery/ :
Completion Schedule :
- vii) Actual delivery/ :
Completion date :

Performance Parameter	Delivery Performance	Quality Performance	Reliability Performance#	Total
Maximum Marks	40	40	20	100
Marks Allocated (*)				

Remarks (if any)

PERFORMANCE RATING (**)

Note :

(#) Vendor/Supplier/Contractor/Consultant who seek repeated financial assistance or deviation beyond contract payment term or seeking direct payment to the sub-vendor/sub-contractor due to financial constraints, then '0' marks should be allotted against Reliability Performance

(*) Allocation of marks should be as per enclosed instructions

(**) Performance rating shall be classified as under :

Sl. No.	Range (Marks)	Rating
1	60 & below	POOR
2	61-75	FAIR
3	76-90	GOOD
4	More than 90	VERY GOOD

Signature of
Authorised Signatory:

Date of Issue: 9th March'23



**COMPOSITE SUPPLY CUM ERECTION OF
ELECTRICAL & INSTRUMENTATION WORKS FOR
OSBL FACILITIES ON ITEM RATE BASIS
AT
TALCHER FERTILIZERS LIMITED, ANGUL,
ODISHA**

PC-183/ E-8003/ S-III

0

DOC. NO.

REV.

Page 60 of 142



Name:

Designation:

Instructions for allocation of marks (For O&M)

1. Marks are to be allocated as under :

1.1 DELIVERY/ COMPLETION PERFORMANCE 40 Marks

Marks	Delivery Period/ Completion Schedule	Delay in Weeks	
	a) Upto 3 months	Before CDD	40
		Delay upto 4 weeks	35
		" 8 weeks	30
		" 10 weeks	25
		" 12 weeks	20
		" 16 weeks	15
		More than 16 weeks	0
	b) Above 3 months	Before CDD	40
		Delay upto 4 weeks	35
		" 8 weeks	30
		" 10 weeks	25
		" 16 weeks	20
		" 20 weeks	15
		" 24 weeks	10
		More than 24 weeks	0

1.2 QUALITY PERFORMANCE 40 Marks

	For Normal Cases : No Defects/ No Deviation/ No failure:		40 marks
i) Rejection/Defects	Marks to be allocated on prorata basis for acceptable quantity as compared to total quantity for normal cases		10 marks
ii) When quality failure endanger system integration and safety of the system	Failure of severe nature - Moderate nature - low severe nature		0 marks 5 marks 10-25 marks

Date of Issue: 9th March'23



**COMPOSITE SUPPLY CUM ERECTION OF
ELECTRICAL & INSTRUMENTATION WORKS FOR
OSBL FACILITIES ON ITEM RATE BASIS
AT
TALCHER FERTILIZERS LIMITED, ANGUL,
ODISHA**

PC-183/ E-8003/ S-III

0

DOC. NO.

REV.

Page 61 of 142



iii) Number of
deviations

1. No deviation
2. No. of deviations ≤ 2
3. No. of deviations > 2

5 marks
2 marks
0 marks

1.3 RELIABILITY PERFORMANCE

20 Marks

A.	FOR WORKS/CONTRACTS	
i)	Submission of order acceptance, agreement, PBG, Drawings and other documents within time	4 marks
ii)	Mobilization of resources as per Contract and in time	4 marks
iii)	Liquidation of Check-list points	4 marks
iv)	Compliance to statutory and HS&E requirements or Reliability of Estimates/Design/Drawing etc. in case of Consultancy jobs	4 marks
v)	Timely submission of estimates and other documents for Extra, Substituted & AHR items	4 marks
B.	FOR SUPPLIES	
i)	Submission of order acceptance, PBG, Drawings and other documents within time	5 marks
ii)	Attending complaints and requests for after sales service/ warranty repairs and/ or query/ advice (upto the evaluation period).	5 marks
iii)	Response to various correspondence and conformance to standards like ISO	5 marks
iv)	Submission of all required documents including Test Certificates at the time of supply	5 marks

Date of Issue: 9th March'23



**COMPOSITE SUPPLY CUM ERECTION OF
ELECTRICAL & INSTRUMENTATION WORKS FOR
OSBL FACILITIES ON ITEM RATE BASIS
AT
TALCHER FERTILIZERS LIMITED, ANGUL,
ODISHA**

PC-183/ E-8003/ S-III

0



DOC. NO.

REV.

Page 62 of 142



Date of Issue: 9th March'23

	COMPOSITE SUPPLY CUM ERECTION OF ELECTRICAL & INSTRUMENTATION WORKS FOR OSBL FACILITIES ON ITEM RATE BASIS AT TALCHER FERTILIZERS LIMITED, ANGUL, ODISHA	PC-183/ E-8003/ S-III	0	
		DOC. NO.	REV.	
		Page 63 of 142		

Annexure-III

INSTRUCTIONS FOR SUBMISSION OF BID ONLINE THROUGH CPP PORTAL



1. The bidders are required to submit soft copies of their bids electronically on the CPP Portal, using valid Digital Signature Certificates. The instructions given below are meant to assist the bidders in registering on the CPP Portal, prepare their bids in accordance with the requirements and submitting their bids online on the CPP Portal.
More information useful for submitting online bids on the CPP Portal may be obtained at: <https://eprocure.gov.in/eprocure/app>.

2. REGISTRATION

- i. Bidders are required to enroll on the e-Procurement module of the Central Public Procurement Portal (URL: <https://eprocure.gov.in/eprocure/app>) by clicking on the link "Online bidder Enrollment" on the CPP Portal which is free of charge.
- ii. As part of the enrollment process, the bidders will be required to choose a unique username and assign a password for their accounts.
- iii. Bidders are advised to register their valid email address and mobile numbers as part of the registration process. These would be used for any communication from the CPP Portal.
- iv. Bidders are advised to make ensure the accessibility & availability of java software in their system (PC) either download & install the latest version of java software or click on the below link to install the java in their system prior to proceed further.
<https://www.oracle.com/technetwork/java/javase/downloads/index.html>
- v. Upon enrollment, the bidders will be required to register their valid Digital Signature Certificate (Class III Certificates with signing key usage) issued by any Certifying Authority recognized by CCA India (e.g. Sify / nCode / eMudhra etc.), with their profile.
- vi. Only one valid DSC should be registered by a bidder. Please note that the bidders are responsible to ensure that they do not lend their DSC's to others which may lead to misuse.
- vii. Bidder then logs in to the site through the secured log-in by entering their user ID / password and the password of the DSC / e-Token.

3. SEARCHING FOR TENDER DOCUMENTS

Date of Issue: 9th March'23

	COMPOSITE SUPPLY CUM ERECTION OF ELECTRICAL & INSTRUMENTATION WORKS FOR OSBL FACILITIES ON ITEM RATE BASIS AT TALCHER FERTILIZERS LIMITED, ANGUL, ODISHA	PC-183/ E-8003/ S-III	0	
		DOC. NO.	REV.	
		Page 64 of 142		

- i) There are various search options built in the CPP Portal, to facilitate bidders to search active tenders by several parameters. These parameters could include Tender ID, Organization Name, Location, Date, Value, etc. There is also an option of advanced search for tenders, wherein the bidders may combine a number of search parameters such as Organization Name, Form of Contract, Location, Date, Other keywords etc. to search for a tender published on the CPP Portal.
- ii) Once the bidders have selected the tenders they are interested in, they may download the required documents / tender schedules. These tenders can be moved to the respective 'My Tenders' folder. This would enable the CPP Portal to intimate the bidders through SMS / email in case there is any corrigendum issued to the tender document.
- iii) The bidder should make a note of the unique Tender ID assigned to each tender, in case they want to obtain any clarification / help from the Helpdesk.



4. PREPARATION OF BIDS

- i) Bidder should take into account any corrigendum published on the tender document before submitting their bids.
- ii) Please go through the tender advertisement and the tender document carefully to understand the documents required to be submitted as part of the bid. Please note the number of covers in which the bid documents have to be submitted, the number of documents - including the names and content of each of the document that need to be submitted. Any deviations from these may lead to rejection of the bid.
- iii) Bidder, in advance, should get ready the bid documents to be submitted as indicated in the tender document / schedule and generally, they can be in PDF / XLS / RAR / DWF/JPG formats. Bid documents may be scanned with 100 dpi with black and white option which helps in reducing size of the scanned document.
- iv) To avoid the time and effort required in uploading the same set of standard documents which are required to be submitted as a part of every bid, a provision of uploading such standard documents (e.g. PAN card copy, annual reports, auditor certificates etc.) has been provided to the bidders. Bidders can use "My Space" or "Other Important Documents" area available to them to upload such documents. These documents may be directly submitted from the "My Space" area while submitting a bid, and need not be uploaded again and again. This will lead to a reduction in the time required for bid submission process.



Note: My Documents space is only a repository given to the Bidders to ease the uploading process. If Bidder has uploaded his Documents in My Documents space, this does not automatically ensure these Documents being part of Technical Bid.

5. SUBMISSION OF BIDS

Date of Issue: 9th March'23

	COMPOSITE SUPPLY CUM ERECTION OF ELECTRICAL & INSTRUMENTATION WORKS FOR OSBL FACILITIES ON ITEM RATE BASIS AT TALCHER FERTILIZERS LIMITED, ANGUL, ODISHA	PC-183/ E-8003/ S-III	0	
		DOC. NO.	REV.	
		Page 65 of 142		



- i. Bidder should log into the site well in advance for bid submission so that they can upload the bid in time i.e. on or before the bid submission time. Bidder will be responsible for any delay due to other issues.
- ii. The bidder has to digitally sign and upload the required bid documents one by one as indicated in the tender document.
- iii. Bidder should submit Declaration for Bid security strictly as per format Form F-2B provided in the NIT. Otherwise the uploaded bid will be rejected.
- iv. Bidders are requested to note that they should necessarily submit their financial bids in the format provided and no other format is acceptable. If the price bid has been given as a standard SOR format with the tender document, then the same is to be downloaded and to be filled by all the bidders. Bidders are required to download the SOR file, open it and complete the white coloured (unprotected) cells with their respective financial quotes and other details (such as name of the bidder). No other cells should be changed. Once the details have been completed, the bidder should save it and submit it online, without changing the filename. If the SOR file is found to be modified by the bidder, the bid will be rejected.
- v. The server time (which is displayed on the bidders' dashboard) will be considered as the standard time for referencing the deadlines for submission of the bids by the bidders, opening of bids etc. The bidders should follow this time during bid submission.
- vi. All the documents being submitted by the bidders would be encrypted using PKI encryption techniques to ensure the secrecy of the data. The data entered cannot be viewed by unauthorized persons until the time of bid opening. The confidentiality of the bids is maintained using the secured Socket Layer 128 bit encryption technology. Data storage encryption of sensitive fields is done. Any bid document that is uploaded to the server is subjected to symmetric encryption using a system generated symmetric key. Further this key is subjected to asymmetric encryption using buyers/bid opener's public keys. Overall, the uploaded tender documents become readable only after the tender opening by the authorized bid openers.
- vii. The uploaded tender documents become readable only after the tender opening by the authorized bid openers.
- viii. Upon the successful and timely submission of bids (i.e. after Clicking "Freeze Bid Submission" in the portal), the portal will give a successful bid submission message & a bid summary will be displayed with the bid no. and the date & time of submission of the bid with all other relevant details.
- ix. The bid summary has to be printed and kept as an acknowledgement of the submission of the bid. This acknowledgement may be used as an entry pass for any bid opening meetings.

	COMPOSITE SUPPLY CUM ERECTION OF ELECTRICAL & INSTRUMENTATION WORKS FOR OSBL FACILITIES ON ITEM RATE BASIS AT TALCHER FERTILIZERS LIMITED, ANGUL, ODISHA	PC-183/ E-8003/ S-III	0	
		DOC. NO.	REV.	
		Page 66 of 142		

6. ASSISTANCE TO BIDDERS

- x. Any queries relating to the tender document and the terms and conditions contained therein should be addressed to the Tender Inviting Authority for a tender or the relevant contact person indicated in the tender.
- xi. Any queries relating to the process of online bid submission or queries relating to CPP Portal in general may be directed to the 24x7 CPP Portal Helpdesk.

-----X-----

	COMPOSITE SUPPLY CUM ERECTION OF ELECTRICAL & INSTRUMENTATION WORKS FOR OSBL FACILITIES ON ITEM RATE BASIS AT TALCHER FERTILIZERS LIMITED, ANGUL, ODISHA	PC-183/ E-8003/ S-III	0	
		DOC. NO.	REV.	
		Page 67 of 142		



ANNEXURE-IV

BIDDING DATA SHEET (BDS)

ITB TO BE READ IN CONJUNCTION WITH THE FOLLOWING:



A. GENERAL					
ITB clause	Description				
1.1	The Employer/Owner is: The Employer/Owner is: Talcher Fertilizers Limited				
2.1	The name of the Works/Services to be performed is: COMPOSITE SUPPLY CUM ERECTION OF ELECTRICAL & INSTRUMENTATION WORKS" FOR OSBL FACILITIES on item Rate basis				
3	BIDS FROM CONSORTIUM/ JOINT VENTURE: <table border="1" style="margin-left: 40px;"> <tr> <td>APPLICABLE</td> <td align="center">✘</td> </tr> <tr> <td>NOT APPLICABLE</td> <td align="center">✔</td> </tr> </table>	APPLICABLE	✘	NOT APPLICABLE	✔
APPLICABLE	✘				
NOT APPLICABLE	✔				
B. BIDDING DOCUMENT					
ITB clause	Description				
8.1	<p>For <u>clarification purposes</u> only, the communication address is: Projects & Development India Limited, (Project Management Department) P.D.I.L Bhawan, A-14, Sector-1, Noida , (India) Fax no.:0120-2529801</p> <p>Kind Attention: 1) Mr. Kailash Joshi- Project Manager Tel no. : +91-120-2529842/43/47/51/53/54 Extn. 314 Fax no. : +91-120-2529801 E-mail : kjoshi@pdilin.com</p> <p>2) Mr. Abhilesh Kumar- Project Co-ordinator Tel no. : +91-120-2529842/43/47/51/53/54 Extn. 316 Mob. No. : 8178085434 Fax no. : +91-120-2529801 E-mail : abhilesh@pdilin.com</p>				

Date of Issue: 9th March'23

	COMPOSITE SUPPLY CUM ERECTION OF ELECTRICAL & INSTRUMENTATION WORKS FOR OSBL FACILITIES ON ITEM RATE BASIS AT TALCHER FERTILIZERS LIMITED, ANGUL, ODISHA	PC-183/ E-8003/ S-III	0	
		DOC. NO.	REV.	
		Page 68 of 142		

C. PREPARATION OF BIDS									
ITB clause	Description								
11.1.1 (r)	Additional documents to be submitted by the Bidder with its Part-I (Techno-commercial/ Unpriced bid) : as per SCC/Scope of Work.								
12 & 13	<p>Details of Buyer:</p> <table border="1" style="width: 100%; border-collapse: collapse;"> <tr> <td style="width: 50%; padding: 5px;">Services to be rendered at</td> <td style="padding: 5px;">M/s Talcher Fertilizers Ltd. (TFL), Administrative Building, Talcher, Post: Vikrampur, Dist: Angul, Pincode-759106, Odisha</td> </tr> <tr> <td style="padding: 5px;">PAN No.</td> <td style="padding: 5px;">AAFCT8667A</td> </tr> <tr> <td style="padding: 5px;">GST no.</td> <td style="padding: 5px;">21AAFCT8667A1ZH</td> </tr> <tr> <td style="padding: 5px;">TFL Bank details</td> <td style="padding: 5px;">Account No.: 41256023769 Bank & Branch Name: SBI, CAG-II, New Delhi IFSC Code: SBIN0017313</td> </tr> </table>	Services to be rendered at	M/s Talcher Fertilizers Ltd. (TFL), Administrative Building, Talcher, Post: Vikrampur, Dist: Angul, Pincode-759106, Odisha	PAN No.	AAFCT8667A	GST no.	21AAFCT8667A1ZH	TFL Bank details	Account No.: 41256023769 Bank & Branch Name: SBI, CAG-II, New Delhi IFSC Code: SBIN0017313
Services to be rendered at	M/s Talcher Fertilizers Ltd. (TFL), Administrative Building, Talcher, Post: Vikrampur, Dist: Angul, Pincode-759106, Odisha								
PAN No.	AAFCT8667A								
GST no.	21AAFCT8667A1ZH								
TFL Bank details	Account No.: 41256023769 Bank & Branch Name: SBI, CAG-II, New Delhi IFSC Code: SBIN0017313								
14	The currency of the Bid shall be INR								
15	The bid validity period shall be 60 Days from 'Bid Due Date'.								

Date of Issue: 9th March'23

	COMPOSITE SUPPLY CUM ERECTION OF ELECTRICAL & INSTRUMENTATION WORKS FOR OSBL FACILITIES ON ITEM RATE BASIS AT TALCHER FERTILIZERS LIMITED, ANGUL, ODISHA	PC-183/ E-8003/ S-III	0	
		DOC. NO.	REV.	
		Page 69 of 142		



16.1, 16.10 and 38.6	<p>In case 'Earnest Money / Bid Security' or "Contract Performance Security" is in the form of 'Demand Draft' or 'Banker's Cheque', or 'Insurance Surety Bond' / 'Fixed Deposit Receipt', the same should be favor of "Talcher Fertilizers Limited, payable at New Delhi</p> <p>In case of submission through online banking transaction i.e. IMPS / NEFT / RTGS / SWIFT, etc, the details of TFL 's Bank account are as under:</p> <p>Account Holder's Name: Talcher Fertilizers Limited Account No.: 41256023769 Bank & Branch Name: SBI, CAG-II, New Delhi IFSC Code: SBIN0017313 Bidder to mention reference no. "EMD/CPS/....." in narration while remitting the CPS amount in TFL's Bank Account.</p>
---------------------------------	---

D. SUBMISSION AND OPENING OF BIDS

ITB clause	Description
18	In addition to the original of the Bid, the number of copies required is one. Not applicable in case of e-tendering.
4.0 of IFB	<p>The submission of physical document as per clause no. 4.0 of IFB shall at following address: :</p> <p>Projects & Development India Limited, (Project Management Department) P.D.I.L Bhawan, A-14, Sector-1, Noida , (India) Fax no.:0120-2529801</p> <p>Kind Attention:</p> <p>1) Mr. Kailash Joshi- Project Manager Tel no. : +91-120-2529842/43/47/51/53/54 Extn. 314 Fax no. : +91-120-2529801 E-mail : kjoshi@pdilin.com</p> <p>1) Mr. Abhilesh Kumar- Project Co-ordinator Tel no. : +91-120-2529842/43/47/51/53/54 Extn. 316 Mob. No. : 8178085434 Fax no. : +91-120-2529801 E-mail : abhilesh@pdilin.com</p>

E. EVALUATION, AND COMPARISON OF BIDS

Date of Issue: 9th March'23

	COMPOSITE SUPPLY CUM ERECTION OF ELECTRICAL & INSTRUMENTATION WORKS FOR OSBL FACILITIES ON ITEM RATE BASIS AT TALCHER FERTILIZERS LIMITED, ANGUL, ODISHA	PC-183/ E-8003/ S-III	0	
		DOC. NO.	REV.	
		Page 70 of 142		

ITB clause	Description				
32	Evaluation Methodology is mentioned in Section-II.				
33	Compensation for Extended Stay: <table border="1" style="margin-left: 20px;"> <tr> <td>APPLICABLE</td> <td style="text-align: center;">✘</td> </tr> <tr> <td>NOT APPLICABLE</td> <td style="text-align: center;">✓</td> </tr> </table>	APPLICABLE	✘	NOT APPLICABLE	✓
APPLICABLE	✘				
NOT APPLICABLE	✓				
34	The following Purchase Preference Policy will be applicable as per provisions mentioned in tender: i) Policy to Provide Purchase Preference as per Public Procurement (Preference to Make in India), Order 2017				
F. AWARD OF CONTRACT					
ITB clause	Description				
37	State of India of which stamp paper is required for Contract Agreement: Uttar Pradesh.				
38	Contract Performance Security/ Security Deposit <table border="1" style="margin-left: 20px;"> <tr> <td>APPLICABLE</td> <td style="text-align: center;">✓</td> </tr> <tr> <td>NOT APPLICABLE</td> <td style="text-align: center;">✘</td> </tr> </table> <p>The value/ amount of Contract Performance Security/ Security Deposit:</p> <p>Rate Contract for procurement of Works: CPS/SD @ 3% of Annualized Order / Contract value (excluding GST).</p>	APPLICABLE	✓	NOT APPLICABLE	✘
APPLICABLE	✓				
NOT APPLICABLE	✘				
41	Provision of AHR Item : <table border="1" style="margin-left: 20px;"> <tr> <td>APPLICABLE</td> <td style="text-align: center;">✓</td> </tr> <tr> <td>NOT APPLICABLE</td> <td style="text-align: center;">✘</td> </tr> </table>	APPLICABLE	✓	NOT APPLICABLE	✘
APPLICABLE	✓				
NOT APPLICABLE	✘				

Date of Issue: 9th March'23



**COMPOSITE SUPPLY CUM ERECTION OF
ELECTRICAL & INSTRUMENTATION WORKS FOR
OSBL FACILITIES ON ITEM RATE BASIS
AT
TALCHER FERTILIZERS LIMITED, ANGUL,
ODISHA**

PC-183/ E-8003/ S-III

0

DOC. NO.



REV.

Page 71 of 142



44.1	Quarterly Closure of Contract:	
	APPLICABLE	X
	NOT APPLICABLE	✓
49	Applicability of BEC relaxation relating to Startups:	
	APPLICABLE	X
	NOT APPLICABLE	✓

Date of Issue: 9th March'23

 <p>पी डी आई एल PDIL</p>	COMPOSITE SUPPLY CUM ERECTION OF ELECTRICAL & INSTRUMENTATION WORKS FOR OSBL FACILITIES ON ITEM RATE BASIS AT TALCHER FERTILIZERS LIMITED, ANGUL, ODISHA	PC-183/ E-8003/ S-III	0	
		DOC. NO.	REV.	
		Page 72 of 142		

Annexure-V

**PUBLIC PROCUREMENT
(PREFERENCE TO MAKE IN INDIA), ORDER 2017**

Date of Issue: 9th March'23

No. P-45021/2/2017-PP (BE-II)
Government of India
Ministry of Commerce and Industry
Department for Promotion of Industry and Internal Trade
(Public Procurement Section)

Udyog Bhawan, New Delhi
Dated: 16th September, 2020

To

All Central Ministries/Departments/CPSUs/All concerned

ORDER

Subject: Public Procurement (Preference to Make in India), Order 2017– Revision; regarding.

Department for Promotion of Industry and Internal Trade, in partial modification [Paras 2, 3, 5, 10 & 13] of Order No.P-45021/2/2017-B.E.-II dated 15.6.2017 as amended by Order No.P-45021/2/2017-B.E.-II dated 28.05.2018, Order No.P-45021/2/2017-B.E.-II dated 29.05.2019 and Order No.P-45021/2/2017-B.E.-II dated 04.06.2020, hereby issues the revised 'Public Procurement (Preference to Make in India), Order 2017' dated 16.09.2020 effective with immediate effect.

Whereas it is the policy of the Government of India to encourage 'Make in India' and promote manufacturing and production of goods and services in India with a view to enhancing income and employment, and

Whereas procurement by the Government is substantial in amount and can contribute towards this policy objective, and

Whereas local content can be increased through partnerships, cooperation with local companies, establishing production units in India or Joint Ventures (JV) with Indian suppliers, increasing the participation of local employees in services and training them,

Now therefore the following Order is issued:

1. This Order is issued pursuant to Rule 153 (iii) of the General Financial Rules 2017.
2. **Definitions:** For the purposes of this Order:

'Local content' means the amount of value added in India which shall, unless otherwise prescribed by the Nodal Ministry, be the total value of the item procured (excluding net domestic indirect taxes) minus the value of imported content in the item (including all customs duties) as a proportion of the total value, in percent.

'Class-I local supplier' means a supplier or service provider, whose goods, services or works offered for procurement, meets the minimum local content as prescribed for 'Class-I local supplier' under this Order.

.....Contd. p/2

'Class-II local supplier' means a supplier or service provider, whose goods, services or works offered for procurement, meets the minimum local content as prescribed for 'Class-II local supplier' but less than that prescribed for 'Class-I local supplier' under this Order.

'Non - Local supplier' means a supplier or service provider, whose goods, services or works offered for procurement, has local content less than that prescribed for 'Class-II local supplier' under this Order.

'L1' means the lowest tender or lowest bid or the lowest quotation received in a tender, bidding process or other procurement solicitation as adjudged in the evaluation process as per the tender or other procurement solicitation.

'Margin of purchase preference' means the maximum extent to which the price quoted by a "Class-I local supplier" may be above the L1 for the purpose of purchase preference.

'Nodal Ministry' means the Ministry or Department identified pursuant to this order in respect of a particular item of goods or services or works.

'Procuring entity' means a Ministry or department or attached or subordinate office of, or autonomous body controlled by, the Government of India and includes Government companies as defined in the Companies Act.

'Works' means all works as per Rule 130 of GFR- 2017, and will also include 'turnkey works'.

3. Eligibility of 'Class-I local supplier'/ 'Class-II local supplier'/ 'Non-local suppliers' for different types of procurement

(a) In procurement of all goods, services or works in respect of which the Nodal Ministry / Department has communicated that there is sufficient local capacity and local competition, only 'Class-I local supplier', as defined under the Order, shall be eligible to bid irrespective of purchase value.

(b) Only 'Class-I local supplier' and 'Class-II local supplier', as defined under the Order, shall be eligible to bid in procurements undertaken by procuring entities, except when Global tender enquiry has been issued. In global tender enquiries, 'Non-local suppliers' shall also be eligible to bid along with 'Class-I local suppliers' and 'Class-II local suppliers'. In procurement of all goods, services or works, not covered by sub-para 3(a) above, and with estimated value of purchases less than Rs. 200 Crore, in accordance with Rule 161(iv) of GFR, 2017, Global tender enquiry shall not be issued except with the approval of competent authority as designated by Department of Expenditure.

(c) For the purpose of this Order, works includes Engineering, Procurement and Construction (EPC) contracts and services include System Integrator (SI) contracts.

.....Contd. p/3

3A. Purchase Preference

(a) Subject to the provisions of this Order and to any specific instructions issued by the Nodal Ministry or in pursuance of this Order, purchase preference shall be given to 'Class-I local supplier' in procurements undertaken by procuring entities in the manner specified here under.

(b) In the procurements of goods or works, which are covered by para 3(b) above and which are divisible in nature, the 'Class-I local supplier' shall get purchase preference over 'Class-II local supplier' as well as 'Non-local supplier', as per following procedure:

- i. Among all qualified bids, the lowest bid will be termed as L1. If L1 is 'Class-I local supplier', the contract for full quantity will be awarded to L1.
- ii. If L1 bid is not a 'Class-I local supplier', 50% of the order quantity shall be awarded to L1. Thereafter, the lowest bidder among the 'Class-I local supplier' will be invited to match the L1 price for the remaining 50% quantity subject to the Class-I local supplier's quoted price falling within the margin of purchase preference, and contract for that quantity shall be awarded to such 'Class-I local supplier' subject to matching the L1 price. In case such lowest eligible 'Class-I local supplier' fails to match the L1 price or accepts less than the offered quantity, the next higher 'Class-I local supplier' within the margin of purchase preference shall be invited to match the L1 price for remaining quantity and so on, and contract shall be awarded accordingly. In case some quantity is still left uncovered on Class-I local suppliers, then such balance quantity may also be ordered on the L1 bidder.

(c) In the procurements of goods or works, which are covered by para 3(b) above and which are not divisible in nature, and in procurement of services where the bid is evaluated on price alone, the 'Class-I local supplier' shall get purchase preference over 'Class-II local supplier' as well as 'Non-local supplier', as per following procedure:

- i. Among all qualified bids, the lowest bid will be termed as L1. If L1 is 'Class-I local supplier', the contract will be awarded to L1.
- ii. If L1 is not 'Class-I local supplier', the lowest bidder among the 'Class-I local supplier', will be invited to match the L1 price subject to Class-I local supplier's quoted price falling within the margin of purchase preference, and the contract shall be awarded to such 'Class-I local supplier' subject to matching the L1 price.
- iii. In case such lowest eligible 'Class-I local supplier' fails to match the L1 price, the 'Class-I local supplier' with the next higher bid within the margin of purchase preference shall be invited to match the L1 price and so on and contract shall be awarded accordingly. In case none of the 'Class-I local supplier' within the margin of purchase preference matches the L1 price, the contract may be awarded to the L1 bidder.

.....Contd. p/4

(d) "Class-II local supplier" will not get purchase preference in any procurement, undertaken by procuring entities.

3B. Applicability in tenders where contract is to be awarded to multiple bidders - In tenders where contract is awarded to multiple bidders subject to matching of L1 rates or otherwise, the 'Class-I local supplier' shall get purchase preference over 'Class-II local supplier' as well as 'Non-local supplier', as per following procedure:

a) In case there is sufficient local capacity and competition for the item to be procured, as notified by the nodal Ministry, only Class I local suppliers shall be eligible to bid. As such, the multiple suppliers, who would be awarded the contract, should be all and only 'Class I Local suppliers'.

b) In other cases, 'Class II local suppliers' and 'Non local suppliers' may also participate in the bidding process along with 'Class I Local suppliers' as per provisions of this Order.

c) If 'Class I Local suppliers' qualify for award of contract for at least 50% of the tendered quantity in any tender, the contract may be awarded to all the qualified bidders as per award criteria stipulated in the bid documents. However, in case 'Class I Local suppliers' do not qualify for award of contract for at least 50% of the tendered quantity, purchase preference should be given to the 'Class I local supplier' over 'Class II local suppliers' / 'Non local suppliers' provided that their quoted rate falls within 20% margin of purchase preference of the highest quoted bidder considered for award of contract so as to ensure that the 'Class I Local suppliers' taken in totality are considered for award of contract for at least 50% of the tendered quantity.

d) First purchase preference has to be given to the lowest quoting 'Class-I local supplier', whose quoted rates fall within 20% margin of purchase preference, subject to its meeting the prescribed criteria for award of contract as also the constraint of maximum quantity that can be sourced from any single supplier. If the lowest quoting 'Class-I local supplier', does not qualify for purchase preference because of aforesaid constraints or does not accept the offered quantity, an opportunity may be given to next higher 'Class-I local supplier', falling within 20% margin of purchase preference, and so on.

e) To avoid any ambiguity during bid evaluation process, the procuring entities may stipulate its own tender specific criteria for award of contract amongst different bidders including the procedure for purchase preference to 'Class-I local supplier' within the broad policy guidelines stipulated in sub-paras above.

4. Exemption of small purchases: Notwithstanding anything contained in paragraph 3, procurements where the estimated value to be procured is less than Rs. 5 lakhs shall be exempt from this Order. However, it shall be ensured by procuring entities that procurement is not split for the purpose of avoiding the provisions of this Order.

5. Minimum local content: The 'local content' requirement to categorize a supplier as 'Class-I local supplier' is minimum 50%. For 'Class-II local supplier', the 'local content' requirement is minimum 20%. Nodal Ministry/ Department may prescribe only a higher

.....Contd. p/5

percentage of minimum local content requirement to categorize a supplier as 'Class-I local supplier'/ 'Class-II local supplier'. For the items, for which Nodal Ministry/ Department has not prescribed higher minimum local content notification under the Order, it shall be 50% and 20% for 'Class-I local supplier'/ 'Class-II local supplier' respectively.

6. **Margin of Purchase Preference:** The margin of purchase preference shall be 20%.
7. **Requirement for specification in advance:** The minimum local content, the margin of purchase preference and the procedure for preference to Make in India shall be specified in the notice inviting tenders or other form of procurement solicitation and shall not be varied during a particular procurement transaction.
8. **Government E-marketplace:** In respect of procurement through the Government E-marketplace (GeM) shall, as far as possible, specifically mark the items which meet the minimum local content while registering the item for display, and shall, wherever feasible, make provision for automated comparison with purchase preference and without purchase preference and for obtaining consent of the local supplier in those cases where purchase preference is to be exercised.
9. **Verification of local content:**
 - a. The 'Class-I local supplier'/ 'Class-II local supplier' at the time of tender, bidding or solicitation shall be required to indicate percentage of local content and provide self-certification that the item offered meets the local content requirement for 'Class-I local supplier'/ 'Class-II local supplier', as the case may be. They shall also give details of the location(s) at which the local value addition is made.
 - b. In cases of procurement for a value in excess of Rs. 10 crores, the 'Class-I local supplier'/ 'Class-II local supplier' shall be required to provide a certificate from the statutory auditor or cost auditor of the company (in the case of companies) or from a practicing cost accountant or practicing chartered accountant (in respect of suppliers other than companies) giving the percentage of local content.
 - c. Decisions on complaints relating to implementation of this Order shall be taken by the competent authority which is empowered to look into procurement-related complaints relating to the procuring entity.
 - d. Nodal Ministries may constitute committees with internal and external experts for independent verification of self-declarations and auditor's/ accountant's certificates on random basis and in the case of complaints.
 - e. Nodal Ministries and procuring entities may prescribe fees for such complaints.
 - f. False declarations will be in breach of the Code of Integrity under Rule 175(1)(i)(h) of the General Financial Rules for which a bidder or its successors can be debarred for up to two years as per Rule 151 (iii) of the General Financial Rules along with such other actions as may be permissible under law.

- g. A supplier who has been debarred by any procuring entity for violation of this Order shall not be eligible for preference under this Order for procurement by any other procuring entity for the duration of the debarment. The debarment for such other procuring entities shall take effect prospectively from the date on which it comes to the notice of other procurement entities, in the manner prescribed under paragraph 9h below.
- h. The Department of Expenditure shall issue suitable instructions for the effective and smooth operation of this process, so that:
 - i. The fact and duration of debarment for violation of this Order by any procuring entity are promptly brought to the notice of the Member-Convenor of the Standing Committee and the Department of Expenditure through the concerned Ministry /Department or in some other manner;
 - ii. on a periodical basis such cases are consolidated and a centralized list or decentralized lists of such suppliers with the period of debarment is maintained and displayed on website(s);
 - iii. in respect of procuring entities other than the one which has carried out the debarment, the debarment takes effect prospectively from the date of uploading on the website(s) in the such a manner that ongoing procurements are not disrupted.

10. Specifications in Tenders and other procurement solicitations:

- a. Every procuring entity shall ensure that the eligibility conditions in respect of previous experience fixed in any tender or solicitation do not require proof of supply in other countries or proof of exports.
- b. Procuring entities shall endeavour to see that eligibility conditions, including on matters like turnover, production capability and financial strength do not result in unreasonable exclusion of 'Class-I local supplier'/ 'Class-II local supplier' who would otherwise be eligible, beyond what is essential for ensuring quality or creditworthiness of the supplier.
- c. Procuring entities shall, within 2 months of the issue of this Order review all existing eligibility norms and conditions with reference to sub-paragraphs 'a' and 'b' above.

d. Reciprocity Clause

- i. When a Nodal Ministry/Department identifies that Indian suppliers of an item are not allowed to participate and/ or compete in procurement by any foreign government, due to restrictive tender conditions which have direct or indirect effect of barring Indian companies such as registration in the procuring country, execution of projects of specific value in the procuring country etc., it shall provide such details to all its procuring entities including CMDs/CEOs of PSEs/PSUs, State Governments and other procurement agencies under their administrative control and GeM for appropriate reciprocal action.

.....Contd. p/7

- ii. Entities of countries which have been identified by the nodal Ministry/Department as not allowing Indian companies to participate in their Government procurement for any item related to that nodal Ministry shall not be allowed to participate in Government procurement in India for all items related to that nodal Ministry/ Department, except for the list of items published by the Ministry/ Department permitting their participation.
 - iii. The stipulation in (ii) above shall be part of all tenders invited by the Central Government procuring entities stated in (i) above. All purchases on GeM shall also necessarily have the above provisions for items identified by nodal Ministry/ Department.
 - iv. State Governments should be encouraged to incorporate similar provisions in their respective tenders.
 - v. The term 'entity' of a country shall have the same meaning as under the FDI Policy of DPIIT as amended from time to time.
- e. Specifying foreign certifications/ unreasonable technical specifications/ brands/ models in the bid document is restrictive and discriminatory practice against local suppliers. If foreign certification is required to be stipulated because of non-availability of Indian Standards and/or for any other reason, the same shall be done only after written approval of Secretary of the Department concerned or any other Authority having been designated such power by the Secretary of the Department concerned.
- f. "All administrative Ministries/Departments whose procurement exceeds Rs. 1000 Crore per annum shall notify/ update their procurement projections every year, including those of the PSEs/PSUs, for the next 5 years on their respective website."

10A. Action for non-compliance of the Provisions of the Order: In case restrictive or discriminatory conditions against domestic suppliers are included in bid documents, an inquiry shall be conducted by the Administrative Department undertaking the procurement (including procurement by any entity under its administrative control) to fix responsibility for the same. Thereafter, appropriate action, administrative or otherwise, shall be taken against erring officials of procurement entities under relevant provisions. Intimation on all such actions shall be sent to the Standing Committee.

11. Assessment of supply base by Nodal Ministries: The Nodal Ministry shall keep in view the domestic manufacturing / supply base and assess the available capacity and the extent of local competition while identifying items and prescribing the higher minimum local content or the manner of its calculation, with a view to avoiding cost increase from the operation of this Order.

12. Increase in minimum local content: The Nodal Ministry may annually review the local content requirements with a view to increasing them, subject to availability of sufficient local competition with adequate quality.

13. Manufacture under license/ technology collaboration agreements with phased indigenization: While notifying the minimum local content, Nodal Ministries may make special provisions for exempting suppliers from meeting the stipulated local content if the product is being manufactured in India under a license from a foreign manufacturer who holds intellectual property rights and where there is a technology collaboration agreement / transfer of technology agreement for indigenous manufacture of a product developed abroad with clear phasing of increase in local content.

13A. In procurement of all goods, services or works in respect of which there is substantial quantity of public procurement and for which the nodal ministry has not notified that there is sufficient local capacity and local competition, the concerned nodal ministry shall notify an upper threshold value of procurement beyond which foreign companies shall enter into a joint venture with an Indian company to participate in the tender. Procuring entities, while procuring such items beyond the notified threshold value, shall prescribe in their respective tenders that foreign companies may enter into a joint venture with an Indian company to participate in the tender. The procuring Ministries/Departments shall also make special provisions for exempting such joint ventures from meeting the stipulated minimum local content requirement, which shall be increased in a phased manner.

14. Powers to grant exemption and to reduce minimum local content: The administrative Department undertaking the procurement (including procurement by any entity under its administrative control), with the approval of their Minister-in-charge, may by written order, for reasons to be recorded in writing,

- a. reduce the minimum local content below the prescribed level; or
- b. reduce the margin of purchase preference below 20%; or
- c. exempt any particular item or supplying entities from the operation of this Order or any part of the Order.

A copy of every such order shall be provided to the Standing Committee and concerned Nodal Ministry / Department. The Nodal Ministry / Department concerned will continue to have the power to vary its notification on Minimum Local Content.

15. Directions to Government companies: In respect of Government companies and other procuring entities not governed by the General Financial Rules, the administrative Ministry or Department shall issue policy directions requiring compliance with this Order.

16. Standing Committee: A standing committee is hereby constituted with the following membership:

Secretary, Department for Promotion of Industry and Internal Trade—Chairman
Secretary, Commerce—Member
Secretary, Ministry of Electronics and Information Technology—Member
Joint Secretary (Public Procurement), Department of Expenditure—Member
Joint Secretary (DPIIT)—Member-Convenor

.....Contd. p/9

The Secretary of the Department concerned with a particular item shall be a member in respect of issues relating to such item. The Chairman of the Committee may co-opt technical experts as relevant to any issue or class of issues under its consideration.

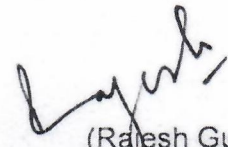

17. **Functions of the Standing Committee:** The Standing Committee shall meet as often as necessary, but not less than once in six months. The Committee
- a. shall oversee the implementation of this order and issues arising therefrom, and make recommendations to Nodal Ministries and procuring entities.
 - b. shall annually assess and periodically monitor compliance with this Order
 - c. shall identify Nodal Ministries and the allocation of items among them for issue of notifications on minimum local content
 - d. may require furnishing of details or returns regarding compliance with this Order and related matters
 - e. may, during the annual review or otherwise, assess issues, if any, where it is felt that the manner of implementation of the order results in any restrictive practices, cartelization or increase in public expenditure and suggest remedial measures
 - f. may examine cases covered by paragraph 13 above relating to manufacture under license/ technology transfer agreements with a view to satisfying itself that adequate mechanisms exist for enforcement of such agreements and for attaining the underlying objective of progressive indigenization
 - g. may consider any other issue relating to this Order which may arise.
18. **Removal of difficulties:** Ministries /Departments and the Boards of Directors of Government companies may issue such clarifications and instructions as may be necessary for the removal of any difficulties arising in the implementation of this Order.
19. **Ministries having existing policies:** Where any Ministry or Department has its own policy for preference to local content approved by the Cabinet after 1st January 2015, such policies will prevail over the provisions of this Order. All other existing orders on preference to local content shall be reviewed by the Nodal Ministries and revised as needed to conform to this Order, within two months of the issue of this Order.
20. **Transitional provision:** This Order shall not apply to any tender or procurement for which notice inviting tender or other form of procurement solicitation has been issued before the issue of this Order.



(Rajesh Gupta)
Director

Tel: 23063211

rajesh.gupta66@gov.in

	COMPOSITE SUPPLY CUM ERECTION OF ELECTRICAL & INSTRUMENTATION WORKS FOR OSBL FACILITIES ON ITEM RATE BASIS AT TALCHER FERTILIZERS LIMITED, ANGUL, ODISHA	PC-183/ E-8003/ S-III	0	
		DOC. NO.	REV.	
		Page 73 of 142		

FORM – I of ANNEXURE V

**CERTIFICATE FROM STATUTORY AUDITOR OR COST AUDITOR OF THE COMPANY (IN
THE CASE OF COMPANIES) OR FROM A PRACTICING COST ACCOUNTANT OR
PRACTICING CHARTERED ACCOUNTANT (IN RESPECT OF SUPPLIERS OTHER THAN
COMPANIES) TOWARDS MINIMUM LOCAL CONTENT**

(FOR SUPPLY OF GOODS/ SERVICES / WORKS / EPC / LSTK)

To,
M/s Talcher Fertilizers Limited

SUB:

TENDER NO:

Dear Sir



- A. We..... the Statutory Auditor / Cost Auditor / Practicing Cost Accountant / Practicing Chartered Accountant) have verified relevant records of M/s **(Name of the bidder)** and certify that M/s **(Name of the bidder)** meets the following:

Sl. No.	Description	Confirmation
a	Bidder meets the mandatory minimum Local content requirement of 20% for participating in the Bidding process under Public Procurement (Preference to Make in India) Policy. (In case bidder does not meet the minimum Local content requirement of 20%, such bidders are not allowed to participate in the Bidding process)	Confirmed.
b	The bidder meets mandatory minimum Local content requirement of 50% for claiming purchase preference under Public Procurement (Preference to Make in India) Policy	Confirmed / Not Confirmed

- B. The **details of the location** at which the local value addition is made as follows:

Sl. No.	Item Description	Details of the Location(s) where the local value addition is made
1.		
2.		

Date of Issue: 9th March'23

	COMPOSITE SUPPLY CUM ERECTION OF ELECTRICAL & INSTRUMENTATION WORKS FOR OSBL FACILITIES ON ITEM RATE BASIS AT TALCHER FERTILIZERS LIMITED, ANGUL, ODISHA	PC-183/ E-8003/ S-III	0	
		DOC. NO.	REV.	
		Page 74 of 142		

3.		
-----------	--	--

Name of Audit Firm / Chartered Accountant: [Signature of Authorized Signatory]

Name:

Date:



Designation:

Seal:

Membership No.:

UDIN:

Date of Issue: 9th March'23



	COMPOSITE SUPPLY CUM ERECTION OF ELECTRICAL & INSTRUMENTATION WORKS FOR OSBL FACILITIES ON ITEM RATE BASIS AT TALCHER FERTILIZERS LIMITED, ANGUL, ODISHA	PC-183/ E-8003/ S-III	0	
		DOC. NO.	REV.	
		Page 75 of 142		

FORM-II of ANNEXURE-V

Salient Points of Public Procurement (Preference to Make in India) Policy

Sr. No.	Description	Parameter / Document
1	Minimum Local Content (LC) for Availing Preference under this Policy	50%
2	Margin of Purchase Preference	20%
3	Local Content (LC) % declared by bidder (Documents to be submitted as per Sr. No. 4 below)	<p align="center">[Tick (<input type="checkbox"/>) whichever is applicable]</p> <p>a) LC Equal to or more than 50% <input type="checkbox"/></p> <p>b) LC More than 20% but less than 50% <input type="checkbox"/></p>
4	Documents to be submitted by bidder under this Policy	Certificate from the statutory auditor or cost auditor of the company (in case of companies) or from a practicing cost accountant or practicing chartered accountant as per <u>Form-I</u> to be submitted by bidder.
5	Whether tender is divisible or not divisible	Not Divisible; Clause No. 3A (c) of revised Policy dated 16.09.2020 shall be applicable

Date of Issue: 9th March'23

	COMPOSITE SUPPLY CUM ERECTION OF ELECTRICAL & INSTRUMENTATION WORKS FOR OSBL FACILITIES ON ITEM RATE BASIS AT TALCHER FERTILIZERS LIMITED, ANGUL, ODISHA	PC-183/ E-8003/ S-III	0	
		DOC. NO.	REV.	
		Page 76 of 142		

FORM-III of ANNEXURE-V

(Not Applicable for this Tender)

**DECLARATION BY BIDDER TOWARDS MINIMUM LOCAL CONTENT
(FOR SUPPLY OF GOODS / SERVICES / WORKS / EPC / LSTK)**

To,
M/s Talcher Fertilizers Limited

SUB:

TENDER NO:

Dear Sir,



A. We M/s (**Name of Bidder**) hereby confirm/certify that the goods / services offered vide our offer no..... dated meets the following-

Sl. No.	Description	Confirmation
A	Bidder meets the mandatory minimum Local content requirement of 20% for participating in the Bidding process under Public Procurement (Preference to Make in India) Policy. (In case bidder does not meet the minimum Local content requirement of 20%, such bidders are not allowed to participate in the Bidding process)	Confirmed.
B	The bidder meets mandatory minimum Local content requirement of 50% for claiming purchase preference under Public Procurement (Preference to Make in India) Policy	Confirmed / Not Confirmed

B. The **details of the location** at which the local value addition is made as follows:

Sl. No.	Item Description	Details of the Location(s) where the local value addition is made
1.		

Date of Issue: 9th March'23

	COMPOSITE SUPPLY CUM ERECTION OF ELECTRICAL & INSTRUMENTATION WORKS FOR OSBL FACILITIES ON ITEM RATE BASIS AT TALCHER FERTILIZERS LIMITED, ANGUL, ODISHA	PC-183/ E-8003/ S-III	0	
		DOC. NO.	REV.	
		Page 77 of 142		

2.		
----	--	--

Place:

[Signature of Authorized Signatory of Bidder]

Date:

Name:



Designation:

Seal:

Note:

- i. The Authorized Signatory of Bidder shall be the person in whose name Power of Attorney has been issued.

Date of Issue: 9th March'23



	COMPOSITE SUPPLY CUM ERECTION OF ELECTRICAL & INSTRUMENTATION WORKS FOR OSBL FACILITIES ON ITEM RATE BASIS AT TALCHER FERTILIZERS LIMITED, ANGUL, ODISHA	PC-183/ E-8003/ S-III	0	
		DOC. NO.	REV.	
		Page 78 of 142		

Annexure-VI

PREAMBLE TO SCHEDULE OF RATES



- The "Bill of Quantity (BOQ)" will be in Excel format (password protected) and will be uploaded during tender creation. This will be downloaded by the bidder and bidder will quote Price on this Excel file for entire scope of work as per NIT. Thereafter, the bidder will upload the same Excel file during bid submission.
- The BOQ format is provided in a spread sheet file (BoQ_xxxx.xls). The rates offered should be entered in the allotted space only and uploaded after filling the relevant columns. The BOQ template must not be modified / replaced by the bidder; else the bid submitted shall be rejected.
- Bidder shall quote all Prices in INR only.
- BOQ consists of following one sheets:
 - Schedule of Rates containing Item Rates & GST
- It is mandatory to quote prices in BOQ and fill up as listed in Para 4. It will be the responsibility of the contractor to quote for all Materials/ Equipments /Services/Civil & Structural Works etc. as per scope of work defined in NIT.
- BIDDER shall be responsible for payment of all taxes, duties and levies as applicable on performance of WORK under CONTRACT and shall be included in the quoted price.
- A copy of SOR, with prices/figures completely blanked out but with the word "QUOTED" in all columns is to be uploaded along with the un-priced bid, as a confirmation of price/data quoted against each head.
- The plans and Tender drawings have been evolved tentatively based on information available with Owner / Consultant but the dimensions and details etc. are liable to changes. The Tenderers shall not be entitled to claim any higher rate or compensation on this account. The tender drawings are intended mainly to give an indication of the probable type ofwork..Detail engineering and fabrication drawings are in the Contractor's scope as per the technical requirement. The same shall be approved by the Owner/PMC. Owner reserves the right to add / delete any of the works mentioned in the N.I.T., during the currency of the contract.
- The Tenderers shall note that the quantities of the different Items, as given in the "Schedule of Rates" are tentative based on tentative tender drawings and are subject to variation and they shall not be entitled to claim any higher rate or compensation on this account. Owner / Consultant reserve the right to change / modify the size and type of sections at any time. Owner / Consultant do not guarantee work under each item of the Schedule of Quantities. Quantity of some or all the items may increase or decrease up to any extent at the time of actual execution. **For variation in value of contract, please refers relevant clause of GCC.**

Date of Issue: 9th March'23

	COMPOSITE SUPPLY CUM ERECTION OF ELECTRICAL & INSTRUMENTATION WORKS FOR OSBL FACILITIES ON ITEM RATE BASIS AT TALCHER FERTILIZERS LIMITED, ANGUL, ODISHA	PC-183/ E-8003/ S-III	0	
		DOC. NO.	REV.	
		Page 79 of 142		

10. The Tenderers shall be fully responsible for the correct setting out and execution of the work. All tools, tackles, construction equipments etc., required for the successful execution / construction of the complete work shall be responsibility of the Tenderers.
11. Payments on bills shall, however, be made on actual measurements of quantities of work done as per approved scope of work. Unless otherwise specified in Tender Documents, measurements of quantities shall be taken as per Indian Standards IS: 1200.
12. The rates to be inserted in the "Schedule of Rates" are to be inclusive of the value of the work described under several items including all costs and expenses which may be required for the detail design and construction of the work described together with all taxes, general risks, liabilities and obligations such as temporary buildings / hutments, fencing, watching, lighting, insurance, labour regulations, indemnity, maintenance and the like. The prices shall be inclusive of Supply of materials, construction, erection, all labors, materials, tools and tackles, plants, equipment, hoists, scaffoldings, the sundries, etc., as may be necessary for the completion of the work in all respects.
13. In case of any discrepancy between the description of items given in the "Schedule of Rates" and Specifications, Tender drawings and other documents, the decision of the Owner / Consultant in writing shall be final, binding and conclusive for the purpose of this contract.
14. Only good earth shall be stacked in within the plant & Township leads & the spaces/locations shall also be undertaken during the execution of the contract as per site requirement.
15. The CONTRACTOR shall dispose-off all surplus and unserviceable earth (if any), outside the plant in accordance to local Governing authority, Disposal shall be done at a place outside the plant, with the consent of the OWNER. Location of disposal area shall be decided by the CONTRACTOR and the required necessary approvals from the local bodies shall be the CONTRACTOR's responsibility.
16. Quantities mentioned in SOR are indicative and not exhaustive in nature. Payment shall be made as per actual quantity used/certified at site.
17. Unit rates shall include the cost of Detail Engineering, labour, supervision and consumables, cost towards providing necessary tools and tackles, detail engineering and providing all the required facilities for execution and inspection, testing, guarantees etc. as per scope of work and Technical specification and other relevant sections / sub sections etc. listed in ITB. Minor repair and touch painting work towards providing all required facilities for execution shall be in bidder's scope.
18. Owner reserve their right to execute any additional works / extra works, during the execution of work, either by themselves or by appointing any other agency, even though such works are incidental to and necessary for the completion of works awarded to the Contractor. In the event of such decisions taken by Owner, Contractor is required to extend necessary cooperation, and act as per the instructions of Engineer-in-Charge.



Date of Issue: 9th March'23

	COMPOSITE SUPPLY CUM ERECTION OF ELECTRICAL & INSTRUMENTATION WORKS FOR OSBL FACILITIES ON ITEM RATE BASIS AT TALCHER FERTILIZERS LIMITED, ANGUL, ODISHA	PC-183/ E-8003/ S-III	0	
		DOC. NO.	REV.	
		Page 80 of 142		

19. The Contractor must visit TFL sites to assess the quantum and nature of work before quoting. However, the Contractor shall inform PDIL / TFL, 1 week prior to their visit to the site.

20. The Contractor must visit TFL sites to assess the quantum and nature of work before quoting. However, the Contractor shall inform PDIL / TFL, 1 week prior to their visit to the site.

Date of Issue: 9th March'23

	COMPOSITE SUPPLY CUM ERECTION OF ELECTRICAL & INSTRUMENTATION WORKS FOR OSBL FACILITIES ON ITEM RATE BASIS AT TALCHER FERTILIZERS LIMITED, ANGUL, ODISHA	PC-183/ E-8003/ S-III	0	
		DOC. NO.	REV.	
		Page 81 of 142		

Annexure-VII



PROCUREMENT FROM A BIDDER WHICH SHARES A LAND BORDER WITH INDIA

1. Order (Public Procurement No. 1) dated 23.07.2020, Order (Public Procurement No.2) dated 23.07.2020 and Order (Public Procurement No. 3) dated 24.07.2020, Department of Expenditure, Ministry of Finance, Govt. of India refers. The same are available at web-site <https://doe.gov.in/procurement-policy-divisions>.
2. Any bidder from a country which shares a land border with India will be eligible to bid in this tender only if the bidder is registered with the Competent Authority. For details of competent authority refer to Annexure I of Order (Public Procurement No. 1) dated 23.07.2020.

Further the above will not apply to bidders from those countries (even if sharing a land border with India) to which the Government of India has extended lines of credit or in which the Government of India is engaged in development projects. Updated lists of countries to which lines of credit have been extended or in which development projects are undertaken are given in the website of the Ministry of External Affairs, Govt. of India

3. "Bidder" (including the term 'tenderer', 'consultant' 'vendor' or 'service provider' in certain contexts) for purpose of this provision means any person or firm or company, including any member of a consortium or joint venture (that is an association of several persons, or firms or companies), every artificial juridical person not falling in any of the descriptions of bidders stated hereinbefore, including any agency, branch or office controlled by such person, participating in a procurement process.
4. "Bidder from a country which shares a land border with India" for the purpose of this:
 - a) An entity incorporated, established or registered in such a country; or
 - b) A subsidiary of an entity incorporated, established or registered in such a country; or
 - c) An entity substantially controlled through entities incorporated, established or registered in such a country; or

Date of Issue: 9th March'23

	COMPOSITE SUPPLY CUM ERECTION OF ELECTRICAL & INSTRUMENTATION WORKS FOR OSBL FACILITIES ON ITEM RATE BASIS AT TALCHER FERTILIZERS LIMITED, ANGUL, ODISHA	PC-183/ E-8003/ S-III	0	
		DOC. NO.	REV.	
		Page 82 of 142		

- d) An entity whose beneficial owner is situated in such a country; or
- e) An Indian (or other) agent of such an entity; or
- f) A natural person who is a citizen of such a country; or
- g) A consortium or joint venture where any member of the consortium or joint venture falls under any of the above

5. "Beneficial owner" for the purpose of above (4) will be as under:



- i) In case of a company or Limited Liability Partnership, the beneficial owner is the natural person(s), who, whether acting alone or together, or through one or more juridical person(s), has a controlling ownership interest or who exercises control through other means.

Explanation-

- a) "Controlling ownership interest" means ownership of, or entitlement to, more than twenty-five per cent of shares or capital or profits of the company;
- b) "Control" shall include the right to appoint the majority of the directors or to control the management or policy decisions, including by virtue of their shareholding or management rights or shareholders agreements or voting agreements;
- ii) In case of a partnership firm, the beneficial owner is the natural person(s) who, whether acting alone or together, or through one or more juridical person, has ownership of entitlement to more than fifteen percent of capital or profits of the partnership;
- iii) In case of an unincorporated association or body of individuals, the beneficial owner is the natural person(s), who, whether acting alone or together, or through one or more juridical person, has ownership of or entitlement to more than fifteen percent of the property or capital or profits of such association or body of individuals;
- iv) Where no natural person is identified under (i) or (ii) or (iii) above, the beneficial owner is the relevant natural person who holds the position of senior managing official;
- v) In case of a trust, the identification of beneficial owner(s) shall include identification of the author of the trust, the trustee, the beneficiaries with fifteen percent or more interest in the trust and any other natural person exercising ultimate effective control over the trust through a chain of control or ownership.

6. "Agent" for the purpose of this Order is a person employed to do any act for

Date of Issue: 9th March'23

	COMPOSITE SUPPLY CUM ERECTION OF ELECTRICAL & INSTRUMENTATION WORKS FOR OSBL FACILITIES ON ITEM RATE BASIS AT TALCHER FERTILIZERS LIMITED, ANGUL, ODISHA	PC-183/ E-8003/ S-III	0	
		DOC. NO.	REV.	
		Page 83 of 142		

another, or to represent another in dealings with third persons

7. SUBMISSION OF CERTIFICATE IN BIDS:



Bidder shall submit a certificate in this regard as Form-I to Annexure-VII.

If such certificate given by a bidder whose bid is accepted is found to be false, this would be a ground for immediate rejection of the bid/termination and further action as per "Procedure for Action in case of Corrupt/Fraudulent/ Collusive / Coercive Practices" of tender document.

8. The registration, wherever applicable, should be valid at the time of submission of bids and at the time of acceptance of bids. In respect of supply otherwise than by tender, registration should be valid at the time of placement of order. If the bidder was validly registered at the time of acceptance / placement of order, registration shall not be a relevant consideration during contract execution.

9. PROVISION FOR WORKS CONTRACTS, INCLUDING TURNKEY CONTRACTS:

The successful bidder shall not be allowed to sub-contract works to any contractor from a country which shares a land border with India unless such contractor is registered with the Competent Authority. The definition of "contractor from a country which shares a land border with India" shall be as in Para 4 herein above. A Certificate to this regard is to be submitted by bidder is placed at Form-II.

	COMPOSITE SUPPLY CUM ERECTION OF ELECTRICAL & INSTRUMENTATION WORKS FOR OSBL FACILITIES ON ITEM RATE BASIS AT TALCHER FERTILIZERS LIMITED, ANGUL, ODISHA	PC-183/ E-8003/ S-III	0	
		DOC. NO.	REV.	
		Page 84 of 142		

Form-I to Annexure-VII

UNDERTAKING ON LETTERHEAD

To,
M/s Talcher Fertilizers LIMITED

SUB:

TENDER NO:

Dear Sir

We have read the clause regarding Provisions for Procurement from a Bidder of a country which shares a land border with India and on sub-contracting to contractors from such countries; we certify that, bidder M/s _____ (**Name of Bidder**) is:

(i) not from such a country []

(ii) if from such a country, has been registered []

with the Competent Authority.
(Evidence of valid registration by the
Competent Authority shall be attached)

(Bidder is to tick appropriate option (✓ or X) above).

We further certify that bidder M/s _____ (**Name of Bidder**) will not sub-contract any work to a contractor from such countries unless such contractor is registered with the Competent Authority.

We hereby certify that bidder M/s _____ (**Name of Bidder**) fulfills all requirements in this regard and is eligible to be considered.

Place:

Date:

[Signature of Authorized Signatory of Bidder]

Name:

Designation:

Seal:

Date of Issue: 9th March'23



**COMPOSITE SUPPLY CUM ERECTION OF
ELECTRICAL & INSTRUMENTATION WORKS FOR
OSBL FACILITIES ON ITEM RATE BASIS
AT
TALCHER FERTILIZERS LIMITED, ANGUL,
ODISHA**

PC-183/ E-8003/ S-III

0

DOC. NO.

REV.

Page 85 of 142



FORMS & FORMATS

Date of Issue: 9th March'23



**COMPOSITE SUPPLY CUM ERECTION OF
ELECTRICAL & INSTRUMENTATION WORKS FOR
OSBL FACILITIES ON ITEM RATE BASIS
AT
TALCHER FERTILIZERS LIMITED, ANGUL,
ODISHA**

PC-183/ E-8003/ S-III

0



DOC. NO.

REV.

Page 86 of 142





Date of Issue: 9th March'23

	COMPOSITE SUPPLY CUM ERECTION OF ELECTRICAL & INSTRUMENTATION WORKS FOR OSBL FACILITIES ON ITEM RATE BASIS AT TALCHER FERTILIZERS LIMITED, ANGUL, ODISHA	PC-183/ E-8003/ S-III	0	
		DOC. NO.	REV.	
		Page 87 of 142		

LIST OF FORMS & FORMATS



Form No.	Description
F-1	BIDDER'S GENERAL INFORMATION
F-2A	PROFORMA OF "BANK GUARANTEE"FOR "EARNEST MONEY / BID SECURITY"
F-2B	FORMAT OF " DECLARATION FOR BID SECURITY "
F-3	LETTER OF AUTHORITY
F-4	PROFORMA OF "BANK GUARANTEE" FOR "CONTRACT PERFORMANCE SECURITY / SECURITY DEPOSIT"
F-4 (a)	MATTER TO BE MENTIONED IN COVERING LETTER TO BE SUBMITTED BY VENDOR ALONG WITH BANK GUARANTEE (BG)
F-5	AGREED TERMS & CONDITIONS
F-6	ACKNOWLEDGEMENT CUM CONSENT LETTER
F-7	BIDDER'S EXPERIENCE
F-8	CHECKLIST
F-8(B)	CHECKLIST FOR BID EVALUATION CRITERIA (BEC) QUALIFYING DOCUMENTS
F-9	FORMAT FOR CERTIFICATE FROM BANK IF BIDDER'S WORKING CAPITAL IS INADEQUATE
F-10	FORMAT FOR CHARTERED ACCOUNTANT CERTIFICATE FOR FINANCIAL CAPABILITY OF THE BIDDER
F-11	FORMAT FOR CONSORTIUM AGREEMENT(ON NON- JUDICIAL STAMP PAPER OF APPROPRIATE VALUE) CONSORTIUM/ JV AGREEMENT- NOT APPLICABLE
F-12	BIDDER'S QUERIES FOR PRE BID MEETING
F-13	E-BANKING FORMAT
F-14	INTEGRITY PACT
F-15	INDEMNITY BOND
F-16	FREQUENTLY ASKED QUESTIONS (FAQS)
F-17	PROFORMA OF BANK GUARANTEE FOR MOBILISATIONS ADVANCE PAYMENT NOT APPLICABLE
F-18	PROFORMA OF BANK GUARANTEE FOR PAYMENTS TOWARDS PLACEMENT OF ALL PURCHASE ORDERS OF MAJOR TAGGED ITEMS NOT APPLICABLE
F-19	Deleted

Date of Issue: 9th March'23

	COMPOSITE SUPPLY CUM ERECTION OF ELECTRICAL & INSTRUMENTATION WORKS FOR OSBL FACILITIES ON ITEM RATE BASIS AT TALCHER FERTILIZERS LIMITED, ANGUL, ODISHA	PC-183/ E-8003/ S-III	0	
		DOC. NO.	REV.	
		Page 88 of 142		

F-20	FORMAT FOR POWER OF ATTORNEY
F-21	UNDERTAKING REGARDING SUBMISSION OF ELECTRONIC INVOICE(E-INVOICE AS PER GST LAW)
F-22	UNDERTAKING REGARDING SUBMISSION CONTRACT PERFORMANCE SECURITY (CPS) / SECURITY DEPOSIT (SD) WITHIN STIPULATED TIME LINE
F-23	PROFORMA FOR CONTRACT AGREEMENT
F-24	NO CLAIM CERTIFICATE

Date of Issue: 9th March'23

	COMPOSITE SUPPLY CUM ERECTION OF ELECTRICAL & INSTRUMENTATION WORKS FOR OSBL FACILITIES ON ITEM RATE BASIS AT TALCHER FERTILIZERS LIMITED, ANGUL, ODISHA	PC-183/ E-8003/ S-III	0	
		DOC. NO.	REV.	
		Page 89 of 142		

F-1



BIDDER'S GENERAL INFORMATION

To,
**M/s TALCHER FERTILIZERS LIMITED,
NOIDA**

TENDER NO:



1	Bidder Name:	M/s.....
2	Status of Firm	Proprietorship Firm/Partnership firm/ Public Limited/ Pvt. Limited/ Govt. Dept. / PSU/ Others If Others Specify: _____ [Enclose relevant certificates / partnership deed/certificate of Registration, as applicable]
3	Name of Proprietor/ Partners/ Directors of the firm/company	1. 2. 3.
4	Name of Power of Attorney holders of bidder	
5	No. of Years in Operation	
6	Address of Registered Office	City: _____ District: _____ State: _____ PIN/ZIP : _____
7	Bidder's address where order/contract is to be placed	City: _____ District: _____ State: _____ PIN/ZIP : _____

Date of Issue: 9th March'23

	COMPOSITE SUPPLY CUM ERECTION OF ELECTRICAL & INSTRUMENTATION WORKS FOR OSBL FACILITIES ON ITEM RATE BASIS AT TALCHER FERTILIZERS LIMITED, ANGUL, ODISHA	PC-183/ E-8003/ S-III	0	
		DOC. NO.	REV.	
		Page 90 of 142		

8	Office responsible for executing the contract with GST no.(In case supply of works are from multiple locations, addresses and GST no. of all such locations are to be provided)	City: District: State: PIN/ZIP: GST No.:
9	Telephone Number & Contact Information of address where order is to be placed	(Country Code) (Area Code) (Telephone Number) FAX No. : e-mail ID:
10	E-mail Address	
11	Deleted	
12	PAN No	[Enclose copy of relevant document]
13	GST No. (refer sl. no. 8 above)	[Enclose copy of relevant document]
14	EPF Registration No.	[Enclose copy of relevant document]
15	ESI code No.	[Enclose copy of relevant document]
16	Whether Micro or Small Enterprise	Yes / No (If Yes, Bidder to submit requisite documents as specified in ITB: Clause No. 40)
	Whether MSE is owned by SC/ST Entrepreneur(s)	Yes / No (If Yes, Bidder to submit requisite documents as specified in ITB: Clause No. 40)
	Whether MSE is owned by Women	Yes / No (If Yes, Bidder to submit requisite documents as specified in ITB: Clause No. 40)
17	Whether Bidder is Startups or not	Yes / No (If Yes, Bidder to submit requisite documents as specified in ITB: Clause No. 49)
18	In case of Start-up confirm the following: (i) Date of its incorporation/ registration (ii) Whether turnover for any financial years since incorporation/ registration has	

Date of Issue: 9th March'23

	COMPOSITE SUPPLY CUM ERECTION OF ELECTRICAL & INSTRUMENTATION WORKS FOR OSBL FACILITIES ON ITEM RATE BASIS AT TALCHER FERTILIZERS LIMITED, ANGUL, ODISHA	PC-183/ E-8003/ S-III	0	
		DOC. NO.	REV.	
		Page 91 of 142		

	exceeded Rs.100 Crores.	
--	-------------------------	--



Note: * TFL intent to place the contract directly on the address from where Works are to be supplied. In case, bidder wants contract at some other address or Worksare to supplied from multiple locations, bidder is required to provide in their bid, the address on which contract is to be placed.

Place:
Date:

[Signature of Authorized Signatory of Bidder]

Name:
Designation:
Seal:

Date of Issue: 9th March'23

	COMPOSITE SUPPLY CUM ERECTION OF ELECTRICAL & INSTRUMENTATION WORKS FOR OSBL FACILITIES ON ITEM RATE BASIS AT TALCHER FERTILIZERS LIMITED, ANGUL, ODISHA	PC-183/ E-8003/ S-III	0	
		DOC. NO.	REV.	
		Page 92 of 142		

FORMAT F-2A
PROFORMA OF "BANK GUARANTEE"
FOR "EARNEST MONEY / BID SECURITY"
(To be stamped in accordance with the Stamp Act)

To, Talcher Fertilizers Limited (TFL) _____	Bank Guarantee No.	
	Date of BG	
	BG Valid up to (Expiry date)	
	Claim period up to (indicate date of expiry of claim period which includes minimum three months from the expiry date)	
	Stamp Sl. No./e-Stamp Certificate No.	

Dear Sir(s),

In accordance with Letter Inviting Tender under your reference No _____ M/s.

_____ having their Registered / Head Office at _____ (hereinafter called the Tenderer), wish to participate in the said tender for _____

As an irrevocable Bank Guarantee against Earnest Money for the amount of _____ is required to be submitted by the Tenderer as a condition precedent for participation in the said tender which amount is liable to be forfeited on the happening of any contingencies mentioned in the Tender Document.

We, _____ the _____ having _____ our _____ Head Office _____ (Local Address) guarantee and undertake to pay immediately on demand without any recourse to the tenderers by Talcher Fertilizers Limited, the amount _____ without any reservation, protest, demur and recourse. Any such demand made by TFL, shall be conclusive and binding on us irrespective of any dispute or difference raised by the Tenderer.

This guarantee shall be irrevocable and shall remain valid up to _____ [this date should be two (02) months beyond the validity of the bid]. If any further extension of this guarantee is required, the same shall be extended to such required period on receiving instructions from M/s. _____ whose behalf this guarantee is issued.

Notwithstanding anything contained herein:

Date of Issue: 9th March'23



**COMPOSITE SUPPLY CUM ERECTION OF
ELECTRICAL & INSTRUMENTATION WORKS FOR
OSBL FACILITIES ON ITEM RATE BASIS
AT
TALCHER FERTILIZERS LIMITED, ANGUL,
ODISHA**

PC-183/ E-8003/ S-III	0
DOC. NO.	REV.
Page 93 of 142	

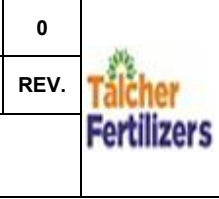

- a) The Bank's liability under this Guarantee shall not exceed (currency in figures)
. (currency in words only)
- b) This Guarantee shall remain in force upto _____ (this expiry date of BG should be two months beyond the validity of bid) and any extension(s) thereof; and
- c) The Bank shall be released and discharged from all liability under this Guarantee unless a written claim or demand is issued to the Bank on or before the midnight of(indicate date of expiry of claim period which includes minimum three months from the expiry of this Bank Guarantee) and if extended, the date of expiry of the last extension of this Guarantee. If a claim has been received by us within the said date, all the rights of TFL under this Guarantee shall be valid and shall not cease until we have satisfied that claim.

In witness whereof the Bank, through its authorized officer, has set its hand and stamp on this _____ day of _____ 20__ at _____.

Details of next Higher Authority of the Officials who have issued the Bank Guarantee:

Name
Designation



WITNESS:

(SIGNATURE)
(NAME)

(SIGNATURE)
(NAME)
Designation with Bank Stamp

(OFFICIAL ADDRESS)



Attorney as per
Power of Attorney No. _____
Date: _____

	COMPOSITE SUPPLY CUM ERECTION OF ELECTRICAL & INSTRUMENTATION WORKS FOR OSBL FACILITIES ON ITEM RATE BASIS AT TALCHER FERTILIZERS LIMITED, ANGUL, ODISHA	PC-183/ E-8003/ S-III	0	
		DOC. NO.	REV.	
		Page 94 of 142		

INSTRUCTIONS FOR FURNISHING "BID SECURITY / EARNEST MONEY" BY "BANK GUARANTEE"

1. The Bank Guarantee by Bidders will be given on non-judicial stamp paper as per "Stamp Duty" applicable. The non-judicial stamp paper should be in the name of the issuing Bank.
2. The expiry date should be arrived at in accordance with "ITB: Clause-16.1".
3. The Bank Guarantee by bidders will be given from Bank as specified in "ITB Clause-16.2".
4. A letter from the issuing Bank of the requisite Bank Guarantee confirming that said Bank Guarantee / all future communication relating to the Bank Guarantee shall be forwarded to the Employer at its address as mentioned at "ITB".
5. Bidders must indicate the full postal address of the Bank along with the Bank's E-mail / Fax / Phone from where the Earnest Money Bond has been issued as per proforma provided below.
6. If a Bank Guarantee is issued by a commercial Bank, then a letter to Employer confirming its net worth is more than Rs. 1,000,000,000.00 [Rupees One Hundred Crores] or equivalent along with documentary evidence in the Bank Guarantee itself.



Date of Issue: 9th March'23

	COMPOSITE SUPPLY CUM ERECTION OF ELECTRICAL & INSTRUMENTATION WORKS FOR OSBL FACILITIES ON ITEM RATE BASIS AT TALCHER FERTILIZERS LIMITED, ANGUL, ODISHA	PC-183/ E-8003/ S-III	0	
		DOC. NO.	REV.	
		Page 95 of 142		

**MATTER TO BE MENTIONED IN COVERING LETTER TO BE SUBMITTED BY VENDOR
ALONG WITH BANK GUARANTEE**

1	BANK GUARANTEE NO	:				
2	VENDOR NAME	:				
3	BANK GUARANTEE AMOUNT	:				
4	TENDER NO	:				
5	NATURE OF BANK GUARANTEE	:				
	(Please Tick (√) Whichever is Applicable		PERFORMANCE BANK GUARANTEE	SECURITY DEPOSIT	EMD	ADVANCE
6	BG ISSUED BANK DETAILS	(A)	EMAIL ID	:		
		(B)	ADDRESS	:		
		(C)	PHONE NO	:		

Date of Issue: 9th March'23

	COMPOSITE SUPPLY CUM ERECTION OF ELECTRICAL & INSTRUMENTATION WORKS FOR OSBL FACILITIES ON ITEM RATE BASIS AT TALCHER FERTILIZERS LIMITED, ANGUL, ODISHA	PC-183/ E-8003/ S-III	0	
		DOC. NO.	REV.	
		Page 96 of 142		

FORMAT F-2B

DECLARATION FOR BID SECURITY

(To be submitted on Letter head of Bidder)

To,

M/s TALCHER FERTILIZERS LIMITED

SUB:

TENDER NO:

Dear Sir,

After examining / reviewing provisions of above referred tender documents (including all corrigendum/ Addenda), we M/s _____ (Name of Bidder) have submitted our offer/ bid no. _____.

We, M/s _____ (Name of Bidder) hereby understand that, according to your conditions, we are submitting this Declaration for Bid Security.

We understand that we will be put on watch list/holiday/ banning list (as per policies of TALCHER FERTILIZERS LIMITED in this regard), if we are in breach of our obligation(s) as per following:

- (a) have withdrawn/modified/amended, impairs or derogates from the tender, my/our Bid during the period of bid validity specified in the form of Bid; or
- (b) having been notified of the acceptance of our Bid by the TALCHER FERTILIZERS LIMITED during the period of bid validity:
 - (i) fail or refuse to execute the Contract, if required, or
 - (ii) fail or refuse to furnish the Contract Performance Security, in accordance provisions of tender document.
 - (iii) fail or refuse to accept 'arithmetical corrections' as per provision of tender document.
- (c) having indulged in corrupt/fraudulent /collusive/coercive practice as per procedure.

Place:



Date:

[Signature of Authorized Signatory of Bidder]

Name:



Designation:

Date of Issue: 9th March'23

	COMPOSITE SUPPLY CUM ERECTION OF ELECTRICAL & INSTRUMENTATION WORKS FOR OSBL FACILITIES ON ITEM RATE BASIS AT TALCHER FERTILIZERS LIMITED, ANGUL, ODISHA	PC-183/ E-8003/ S-III	0	
		DOC. NO.	REV.	
		Page 97 of 142		

Seal

Date of Issue: 9th March'23

	COMPOSITE SUPPLY CUM ERECTION OF ELECTRICAL & INSTRUMENTATION WORKS FOR OSBL FACILITIES ON ITEM RATE BASIS AT TALCHER FERTILIZERS LIMITED, ANGUL, ODISHA	PC-183/ E-8003/ S-III	0	
		DOC. NO.	REV.	
		Page 98 of 142		

F-3

LETTER OF AUTHORITY

[Pro forma for Letter of Authority for Attending 'Pre-Bid Meetings' /'Un-priced Bid Opening' / 'Price Bid Opening']

Ref:

Date:

To,
**M/s TALCHER FERTILIZERS LIMITED,
NOIDA**

SUB:
TENDER NO:

Dear Sir,

I/We, _____ hereby authorize the following representative(s) for attending any 'Meetings [Pre-Bid Meeting]', 'Un-priced Bid Opening' and 'Price Bid Opening' against the above Tender Documents:

[1] Name & Designation _____ Signature _____
Phone/Cell: _____

E-mail: @

[2] Name & Designation _____ Signature _____
Phone/Cell: _____



E-mail: @

We confirm that we shall be bound by all commitments made by aforementioned authorised representative(s).

Place: _____ [Signature of Authorized Signatory of Bidder]
Date: _____ Name:
Designation:
Seal:

- (i) Note: This "Letter of Authority" should be on the **"letter head"** of the Bidder and should be signed by a person competent and having the 'Power of Attorney' to bind the Bidder. Not more than 'two [02] persons per Bidder' are permitted to attend 'Pre-Bid Meetings' /'Un-priced Bid Opening' / 'Price Bid Opening'..
- (ii) Bidder's authorized representative is required to carry a copy of this authority letter while attending the 'Pre-Bid Meetings' /'Un-priced Bid Opening' .

Date of Issue: 9th March'23

	COMPOSITE SUPPLY CUM ERECTION OF ELECTRICAL & INSTRUMENTATION WORKS FOR OSBL FACILITIES ON ITEM RATE BASIS AT TALCHER FERTILIZERS LIMITED, ANGUL, ODISHA	PC-183/ E-8003/ S-III	0	
		DOC. NO.	REV.	
		Page 99 of 142		

F-4

**PROFORMA OF "BANK GUARANTEE" FOR "CONTRACT PERFORMANCE SECURITY /
SECURITY DEPOSIT"
(ON NON-JUDICIAL STAMP PAPER OF APPROPRIATE VALUE)**

To, M/s Talcher Fertilizers Limited, Noida	Bank Guarantee No.	
	Date of BG	
	BG Valid up to	
	Claim period up to (There should be three months gap between expiry date of BG & Claim period)	
	Stamp Sl. No./e-Stamp Certificate No.	

Dear Sir(s),

M/s. _____ having registered office at _____ (herein after called the "contractor" which expression shall wherever the context so require include its successors and assignees) have been placed/ awarded the job/work of _____ vide LOA /FOA No. _____ dated _____ for Talcher Fertilizers Limited having registered office at Plot 2/H, Kalpana Area, BJB Nagar, Khorda, Bhubaneswar-751014, Odisha (herein after called the "TFL" which expression shall wherever the context so require include its successors and assignees).

The Contract conditions provide that the CONTRACTOR shall pay a sum of Rs. _____ (Rupees _____) as full Contract Performance Guarantee in the form therein mentioned. The form of payment of Contract Performance Guarantee includes guarantee executed by Nationalized Bank/Scheduled Commercial Bank, undertaking full responsibility to indemnify Talcher Fertilizers Limited, in case of default.

The said M/s. _____ has approached us and at their request and in consideration of the premises we having our office at _____ have agreed to give such guarantee as hereinafter mentioned.

1. We _____ hereby undertake to give the irrevocable & unconditional guarantee to you that if default shall be made by M/s.

Date of Issue: 9th March'23



**COMPOSITE SUPPLY CUM ERECTION OF
ELECTRICAL & INSTRUMENTATION WORKS FOR
OSBL FACILITIES ON ITEM RATE BASIS
AT
TALCHER FERTILIZERS LIMITED, ANGUL,
ODISHA**

PC-183/ E-8003/ S-III

0

DOC. NO.

REV.

Page 100 of 142



_____ in performing any of the terms and conditions of the tender/order/contract or in payment of any money payable to Talcher Fertilizers Limited we shall on first demand pay without demur, contest, protest and/ or without any recourse to the contractor to TFL in such manner as TFL may direct the said amount of Rupees _____ only or such portion thereof not exceeding the said sum as you may require from time to time.

2. You will have the full liberty without reference to us and without affecting this guarantee, postpone for any time or from time to time the exercise of any of the powers and rights conferred on you under the order/contract with the said _____ M/s. _____ and to enforce or to forbear from endorsing any powers or rights or by reason of time being given to the said M/s. _____ and such postponement forbearance would not have the effect of releasing the bank from its obligation under this debt.
3. Your right to recover the said sum of Rs. _____ (Rupees _____) from us in manner aforesaid is absolute & unequivocal and will not be affected or suspended by reason of the fact that any dispute or disputes have been raised by the said M/s. _____ and/or that any dispute or disputes are pending before any officer, tribunal or court or arbitrator or any other authority/forum and any demand made by you in the bank shall be conclusive and binding. The bank shall not be released of its obligations under these presents by any exercise by you of its liberty with reference to matter aforesaid or any of their or by reason or any other act of omission or commission on your part or any other indulgence shown by you or by any other matter or changed what so ever which under law would, but for this provision, have the effect of releasing the bank.
4. The guarantee herein contained shall not be determined or affected by the liquidation or winding up dissolution or changes of constitution or insolvency of the said contractor but shall in all respects and for all purposes be binding and operative until payment of all money due to you in respect of such liabilities is paid.
5. The bank undertakes not to revoke this guarantee during its currency without your previous consent and further agrees that the guarantee shall continue to be enforceable until it is discharged by TFL in writing. However, if for any reason, the contractor is unable to complete the work within the period stipulated in the order/contract and in case of extension of the date of delivery/completion resulting extension of defect liability period/guarantee period of the contractor fails to perform the work fully, the bank hereby agrees to further extend this guarantee at the instance of the contractor till such time as may be determined by TFL. If any further extension of this guarantee is required, the same shall be extended to such required period on receiving instruction from M/s. _____ (contractor) on whose behalf this guarantee is issued.
6. Bank also agrees that TFL at its option shall be entitled to enforce this Guarantee against the bank (as principal debtor) in the first instant, without proceeding against the contractor and notwithstanding any security or other guarantee that TFL may have in relation to the

Date of Issue: 9th March'23



**COMPOSITE SUPPLY CUM ERECTION OF
ELECTRICAL & INSTRUMENTATION WORKS FOR
OSBL FACILITIES ON ITEM RATE BASIS
AT
TALCHER FERTILIZERS LIMITED, ANGUL,
ODISHA**

PC-183/ E-8003/ S-III	0
DOC. NO.	REV.
Page 101 of 142	

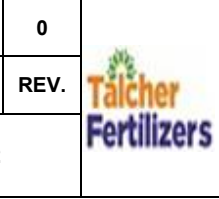

/contractor's liabilities.

7. The amount under the Bank Guarantee is payable forthwith without any delay by Bank upon the written demand raised by TFL. Any dispute arising out of or in relation to the said Bank Guarantee shall be subject to the exclusive jurisdiction of courts at New Delhi.
8. Therefore, we hereby affirm that we are guarantors and responsible to you on behalf of the Contractor up to a total amount of _____ (amount of guarantees in words and figures) and we undertake to pay you, upon your first written demand declaring the Contractor to be in default under the order/contract and without caveat or argument, any sum or sums within the limits of (amounts of guarantee) as aforesaid, without your needing to prove or show grounds or reasons for your demand or the sum specified therein.
9. We have power to issue this guarantee in your favor under Memorandum and Articles of Association and the undersigned has full power to do under the Power of Attorney, dated _____ granted to him by the Bank.
10. Notwithstanding anything contained herein:
 - a) The Bank's liability under this Guarantee shall not exceed (currency in figures) _____ (currency in words only) _____
 - b) This Guarantee shall remain in force upto _____ (this date should be expiry date of defect liability period of the Contract) and any extension(s) thereof; and
 - c) The Bank shall be released and discharged from all liability under this Guarantee unless a written claim or demand is issued to the Bank on or before the midnight of _____ (indicate date of expiry of claim period which includes minimum three months from the expiry of this Bank Guarantee) and if extended, the date of expiry of the last extension of this Guarantee. If a claim has been received by us within the said date, all the rights of TFL under this Guarantee shall be valid and shall not cease until we have satisfied that claim.

Details of next Higher Authority of the Officials who have issued the Bank Guarantee:

Name



Designation

Yours faithfully,

Bank by its Constituted Attorney

Signature of a person duly
Authorized to sign on behalf of the Bank



Date of Issue: 9th March'23

	COMPOSITE SUPPLY CUM ERECTION OF ELECTRICAL & INSTRUMENTATION WORKS FOR OSBL FACILITIES ON ITEM RATE BASIS AT TALCHER FERTILIZERS LIMITED, ANGUL, ODISHA	PC-183/ E-8003/ S-III	0	
		DOC. NO.	REV.	
		Page 102 of 142		

**INSTRUCTIONS FOR FURNISHING
"CONTRACT PERFORMANCE SECURITY / SECURITY DEPOSIT" BY "BANK GUARANTEE"**

1. The Bank Guarantee by successful Bidder(s) will be given on non-judicial stamp paper as per 'stamp duty' applicable. The non-judicial stamp paper should be in name of the issuing bank..
2. The Bank Guarantee by Bidders will be given from bank as specified in Cl no. 38.3 of ITB [Section-III] of Tender Document .
3. A letter from the issuing bank of the requisite Bank Guarantee confirming that said Bank Guarantee and all future communication relating to the Bank Guarantee shall be forwarded to Employer.
4. If a Bank Guarantee is issued by a commercial bank, then a letter to Employer and copy to Consultant (if applicable) confirming its net worth is more than Rs. 100,00,00,000.00 [Rupees One Hundred Crores] or its equivalent in foreign currency alongwith documentary evidence OR in the Bank Guarantee itself.
5. Contractor shall submit attached cover letter (Annexure) while submitting Contract Performance Security.

Date of Issue: 9th March'23



	COMPOSITE SUPPLY CUM ERECTION OF ELECTRICAL & INSTRUMENTATION WORKS FOR OSBL FACILITIES ON ITEM RATE BASIS AT TALCHER FERTILIZERS LIMITED, ANGUL, ODISHA	PC-183/ E-8003/ S-III	0	
		DOC. NO.	REV.	
		Page 103 of 142		

Form-4 (a)

**MATTER TO BE MENTIONED IN COVERING LETTER TO BE SUBMITTED BY VENDOR
ALONG WITH BANK GUARANTEE (BG)**

1	BANK GUARANTEE NO	:				
2	VENDOR NAME	:				
3	BANK GUARANTEE AMOUNT	:				
4	TENDER NO	:				
5	NATURE OF BANK GUARANTEE	:				
	(Please Tick (√) Whichever is Applicable		PERFORMANCE BANK GUARANTEE	SECURITY DEPOSIT	EMD	ADVANCE
6	BG ISSUED BANK DETAILS	(A)	EMAIL ID	:		
		(B)	ADDRESS	:		
		(C)	PHONE NO	:		

Date of Issue: 9th March'23

	COMPOSITE SUPPLY CUM ERECTION OF ELECTRICAL & INSTRUMENTATION WORKS FOR OSBL FACILITIES ON ITEM RATE BASIS AT TALCHER FERTILIZERS LIMITED, ANGUL, ODISHA	PC-183/ E-8003/ S-III	0	
		DOC. NO.	REV.	
		Page 104 of 142		

F-5
AGREED TERMS & CONDITIONS

To,
M/s TALCHER FERTILIZERS LIMITED
NOIDA

SUB:
TENDER NO:

This Questionnaire duly filled in, signed & stamped must form part of Bidder's Bid and should be returned along with Un-priced Bid. Clauses confirmed hereunder need not be repeated in the Bid.

Sl.	DESCRIPTION	BIDDER'S CONFIRMATION
1	Bidder's name, Vendor Code of TFL (If any) and address	Bidder's Name: Address:
2.	Bidder confirms the currency of quoted prices is in Indian Rupees	
3.	Bidder confirms quoted prices will remain firm and fixed till complete execution of the order (except where price escalation/variation is allowed in the Tender).	
4.	Bidder confirms that they have quoted GST (CGST & SGST/ UTGST or IGST) in Price Schedule / Schedule of Rates (SOR) of Price bid.	Confirmed
4.1	Whether in the instant tender services/works are covered in reverse charge rule of GST (CGST & SGST/UTGST or IGST) If yes, Bidder confirms that they have quoted rate of applicable GST (CGST & SGST/ UTGST or IGST) in Price Schedule / Schedule of Rates of Price Bid	
4.2	Indicate Harmonized System of Nomenclature (HSN)/Service Accounting Codes (SAC).	HSN/SAC Code (as applicable):
4.3	Bidder hereby confirms that the quoted prices are in compliance with the Section 171 of CGST Act/ SGST Act as mentioned as clause no. 13.10 of ITB (Anti-profiteering clause).	
4.4	a. Whether bidder is liable to raise E-Invoice as per GST Act. b. If yes, bidder will raise E-Invoice and confirm compliance to provision of tender in this regard.	a. _____ b. _____
5.	Bidder confirms acceptance of relevant Terms of Payment specified in the Bid Document.	
6.	Bidder confirms that Contract Performance Security will be	

Date of Issue: 9th March'23



**COMPOSITE SUPPLY CUM ERECTION OF
ELECTRICAL & INSTRUMENTATION WORKS FOR
OSBL FACILITIES ON ITEM RATE BASIS
AT
TALCHER FERTILIZERS LIMITED, ANGUL,
ODISHA**

PC-183/ E-8003/ S-III

0

DOC. NO.



REV.

Page 105 of 142





SI.	DESCRIPTION	BIDDER'S CONFIRMATION				
	furnished as per Bid Document within 30 days of FOA in case of successful bidder..					
7.	Bidder confirms that Contract Performance Security shall be from any Indian scheduled bank (excluding Co-operative banks and Regional Rural bank) or a branch of an International bank situated in India and registered with Reserve bank of India as scheduled foreign bank. However, in case of bank guarantees from banks other than the Nationalised Indian banks, the bank must be a commercial bank having net worth in excess of Rs 100 crores and a declaration to this effect shall be made by such commercial bank either in the Bank Guarantee itself or separately on its letterhead.					
8.	Bidder confirms compliance to Completion Schedule as specified in Bid document and the same shall be reckoned from the date of Fax of Acceptance.					
9.	(i) Bidder confirms acceptance of Price Reduction Schedule for delay in completion schedule specified in Bid document. (ii) In case of delay, the bills/invoices shall be submitted after reducing the price reduction due to delay (refer PRS Clause).					
10.	a) Bidder confirms acceptance of all terms and conditions of Bid Document (all sections). b) Bidder confirms that printed terms and conditions of bidder are not applicable.					
11.	Bidder confirms that their offer is valid for period specified in BDS from Final/Extended due date of opening of Techno-commercial Bids.					
12.	Bidder have furnished Bid security Declaration					
13.	As per requirement of tender, bidder (having status as Pvt. Ltd. or Limited company) must upload bid duly digitally signed on e-portal through class-3B digital signature (DS). In case, class of DS or name of employee or name of employer is not visible in the digitally signed documents, the bid digitally signed as submitted by the person shall be binding on the bidder.					
14.	Bidder confirms that (i) none of Directors (in Board of Director) of bidder is a relative of any Director (in Board of Director) of TFL or (ii) the bidder is not a firm in which any Director (in Board of Director) of TFL or their relative is a partner.	<table border="1"><tr><td>Confirmed</td><td></td></tr><tr><td>Not confirmed</td><td></td></tr></table>	Confirmed		Not confirmed	
Confirmed						
Not confirmed						
15.	All correspondence must be in ENGLISH language only					

Date of Issue: 9th March'23

	COMPOSITE SUPPLY CUM ERECTION OF ELECTRICAL & INSTRUMENTATION WORKS FOR OSBL FACILITIES ON ITEM RATE BASIS AT TALCHER FERTILIZERS LIMITED, ANGUL, ODISHA	PC-183/ E-8003/ S-III	0	
		DOC. NO.	REV.	
		Page 106 of 142		



SI.	DESCRIPTION	BIDDER'S CONFIRMATION
16.	Bidder confirms the contents of this Tender Document have not been modified or altered by them. In case, it is found that the tender document has been modified / altered by the bidder, the bid submitted by them shall be liable for rejection.	
17.	Bidder confirms that all Bank charges associated with Bidder's Bank regarding release of payment etc. shall be borne by Bidder.	
18.	<p><u>No Deviation Confirmation:</u></p> <p>It may be note that any 'deviation / exception' in any form may result in rejection of Bid. Therefore, Bidder confirms that they have not taken any 'exception / deviation' anywhere in the Bid. In case any 'deviation / exception' is mentioned or noticed, Bidder's Bid may be rejected.</p>	
19.	<p>If Bidder becomes a successful Bidder pursuant to the provisions of the Tender Document, the following Confirmation shall be automatically become enforceable:</p> <p>"We agree and acknowledge that the Employer is entering into the Contract/Agreement solely on its own behalf and not on behalf of any other person or entity. In particular, it is expressly understood & agreed that the Government of India is not a party to the Contract/Agreement and has no liabilities, obligations or rights thereunder. It is expressly understood and agreed that the Purchaser is authorized to enter into Contract/Agreement, solely on its own behalf under the applicable laws of India. We expressly agree, acknowledge and understand that the Purchaser is not an agent, representative or delegate of the Government of India. It is further understood and agreed that the Government of India is not and shall not be liable for any acts, omissions, commissions, breaches or other wrongs arising out of the Agreement. Accordingly, we hereby expressly waive, release and forego any and all actions or claims, including cross claims, VIP claims or counter claims against the Government of India arising out of the Agreement and covenants not to sue to Government of India as to any manner, claim, cause of action or things whatsoever arising of or under the Agreement."</p>	
20.	Bidder to ensure all documents as per tender including clause 11 of Section III and all Formats are included in their bid.	
21.	Bidder understands that Tender Document is not exhaustive. In case any activity though specifically not covered in description of 'Schedule of Rates' but is required to complete the work as per Scope of Work, Conditions of Contract, or any other part of Bidding document, the quoted rates will deemed to be inclusive of cost incurred for such activities unless otherwise specifically	

Date of Issue: 9th March'23

	COMPOSITE SUPPLY CUM ERECTION OF ELECTRICAL & INSTRUMENTATION WORKS FOR OSBL FACILITIES ON ITEM RATE BASIS AT TALCHER FERTILIZERS LIMITED, ANGUL, ODISHA	PC-183/ E-8003/ S-III	0	
		DOC. NO.	REV.	
		Page 107 of 142		

SI.	DESCRIPTION	BIDDER'S CONFIRMATION
	excluded. Bidder confirms to perform for fulfilment of the contract and completeness of the supplies in all respect within the scheduled time frame and quoted price.	
22.	<p>Bidder hereby confirms that they are not on 'Holiday' by OWNER or any of the JV partners of TFL (viz. GAIL, RCF, CIL, FCIL) or Public Sector Project Management Consultant (like PDIL, EIL, Mecon only due to "poor performance" or "corrupt and fraudulent practices") or banned by Government department/ Public Sector on due date of submission of bid.</p> <p>Further, Bidder confirms that neither they nor their allied agency/(ies) (as defined in the Procedure for Action in case of Corrupt/Fraudulent/Collusive/ Coercive Practices) are on banning list of TFL or any of the JV partner of TFL viz. GAIL, RCF, CIL, FCIL.</p> <p>Bidder also confirms that they are not under any liquidation, court receivership or similar proceedings or 'bankruptcy'.</p> <p>In case it comes to the notice of TFL/PDIL that the bidder has given wrong declaration in this regard, the same shall be dealt as 'fraudulent practices' and action shall be initiated as per the Procedure for action in case of Corrupt/Fraudulent/Collusive/Coercive Practices.</p> <p>Further, Bidder also confirms that in case there is any change in status of the declaration prior to award of contract, the same will be promptly informed to TFL/PDIL by them.</p>	
23	<p>Bidder certifies that they would adhere to the Fraud Prevention Policy of TFL [available on TFL's website (www.https://tflonline.co.in/)] and shall not indulge themselves or allow others (working in TFL) to indulge in fraudulent activities and that they would immediately apprise TFL of the fraud/suspected fraud as soon as it comes to their notice.</p> <p>Concealment of facts regarding their involvement in fraudulent activities in connection with the business transaction(s) of TFL is liable to be treated as crime and dealt with by the procedures of TFL as applicable from time to time.</p>	
24	<p>Bidder confirms that (i) any variation in GST at the time of supplies for any reasons, other than statutory, including variations due to turnover, shall be borne by them and (ii) any error of interpretation of applicability of rate of GST (CGST & SGST/ UTGST or IGST) on components of an item and/or various items of tender by them shall be dealt as per clause no.</p>	

Date of Issue: 9th March'23



	COMPOSITE SUPPLY CUM ERECTION OF ELECTRICAL & INSTRUMENTATION WORKS FOR OSBL FACILITIES ON ITEM RATE BASIS AT TALCHER FERTILIZERS LIMITED, ANGUL, ODISHA	PC-183/ E-8003/ S-III	0	
		DOC. NO.	REV.	
		Page 108 of 142		

Sl.	DESCRIPTION	BIDDER'S CONFIRMATION
	13.13 of Section-III.	
25	Bidders confirm to submit signed copy of Integrity Pact (wherever included in tender). If Bidder is a partnership concern or a consortium, this agreement must be signed by all partners or consortium members.	
26.	Bidder confirms that there is no conflict of interest with other bidders, as per clause no.4.2 of Section-III (ITB) of Tender Document.	
27.	Bidder confirms that, in case of contradiction between the confirmations provided in this format and to the terms & conditions mentioned elsewhere in the offer, the confirmations given in this format shall prevail.	

Place:
Date:

[Signature of Authorized Signatory of Bidder]
Name:
Designation:
Seal:

Date of Issue: 9th March'23

	COMPOSITE SUPPLY CUM ERECTION OF ELECTRICAL & INSTRUMENTATION WORKS FOR OSBL FACILITIES ON ITEM RATE BASIS AT TALCHER FERTILIZERS LIMITED, ANGUL, ODISHA	PC-183/ E-8003/ S-III	0	
		DOC. NO.	REV.	
		Page 109 of 142		

F-6

ACKNOWLEDGEMENT CUM CONSENT LETTER

(On receipt of tender document/information regarding the tender, Bidder shall acknowledge the receipt and confirm his intention to bid or reason for non-participation against the enquiry /tender through e-mail to concerned executive in TFL/PDIL issued the tender, by filling up the Format)

To,
M/s TALCHER FERTILIZERS LIMITED
NOIDA

SUB:
TENDER NO:

Dear Sir,

We hereby acknowledge receipt of a complete set of bidding documents along with enclosures for subject item/job and/or the information regarding the subject tender.

- We intend to bid as requested for the subject item/job and furnish following details with respect to our quoting office:

Postal Address with Pin Code :

Telephone Number :

Contact Person :

E-mail Address :

Mobile No. :

Date :

Seal/Stamp :

- We are unable to bid for the reason given below:

Reasons for non-submission of bid:

Agency's Name :

Signature :

Name :

Designation :

Date :

Seal/Stamp :

Date of Issue: 9th March'23



**COMPOSITE SUPPLY CUM ERECTION OF
ELECTRICAL & INSTRUMENTATION WORKS FOR
OSBL FACILITIES ON ITEM RATE BASIS
AT
TALCHER FERTILIZERS LIMITED, ANGUL,
ODISHA**

PC-183/ E-8003/ S-III

0

DOC. NO.

REV.

Page 110 of 142



**F-7
BIDDER'S EXPERIENCE**

To,

**M/s TALCHER FERTILIZERS LIMITED
NOIDA**

SUB:

TENDER NO:

Sl. No	Detailed Description of Job	LOA/WO No. and date	Full Postal Address & phone nos. of Client. Name, designation and address of Engineer/ Officer-in-Charge	Capacity	Value of Contract/ Order (Specify Currency Amount)	Date of Commencement	Scheduled Completion Time (Months)	Date of Actual Completion	Reasons for delay in execution, if any	Details of satisfactory operation from the date of Acceptance
(1)	(2)	(3)	(4)	(5)	(6)	(7)	(8)	(9)	(10)	(11)

Place:

Date:



[Signature of Authorized Signatory of Bidder]

Name:

Designation:

Seal:

Date of Issue: 9th March'23

	COMPOSITE SUPPLY CUM ERECTION OF ELECTRICAL & INSTRUMENTATION WORKS FOR OSBL FACILITIES ON ITEM RATE BASIS AT TALCHER FERTILIZERS LIMITED, ANGUL, ODISHA	PC-183/ E-8003/ S-III	0	
		DOC. NO.	REV.	
		Page 111 of 142		

F-8(A)



CHECK LIST

Bidders are requested to duly fill in the checklist. This checklist gives only certain important items to facilitate the bidder to make sure that the necessary data/information as called for in the bid document has been submitted by them along with their offer. This, however, does not relieve the bidder of his responsibilities to make sure that his offer is otherwise complete in all respects.

Please ensure compliance and tick (√) against following points:

S. No.	DESCRIPTION	CHECK BOX
1.0	Digitally Signing (in case of e-bidding)/ Signing and Stamping (in case of manual bidding) on each sheet of offer, original bidding document including SCC, ITB,GCC, SOR DRAWINGS Corrigendum (if any)	
2.0	Confirm that the following details have been submitted in the Un-priced part of the bid	
i	Covering Letter, Letter of Submission	
ii	EMD / Declaration for Bid Security as per provisions of Tender	
iii.	Digitally signed (in case of e-tendering) or 'signed & stamped (in case of Manual tender) tender document along with drawings and addendum (if any)	
iv	Power of Attorney in the name of person signing the bid.	
v	Confirm submission of document alongwith un-priced bid as per bid requirement (including cl.no.11.1.1 of Section-III).	
3.0	Confirm that all format duly filled in are enclosed with the bid duly Digitally Signed (in case of e-bidding)/ / Signed and Stamped (in case of manual bidding) by authorised person(s)	
4.0	Confirm that the price part as per Price Schedule format submitted with Bidding Document/uploaded in case of e-bid.	
5.0	Confirm that Undertaking as per <i>Form-II to Annexure-V to Section-III</i> and Certification from the statutory auditor or cost auditor of the company (in the case of companies) or from a practicing cost accountant or practicing chartered accountant (in respect of other than companies) as per <i>Form-I to Annexure-V to Section-III</i> are submitted. (Applicable for all bidders)	
6.0	Confirm that Undertaking as per <i>Form-1 to Annexure-VII</i> have been submitted by the bidder (Guidelines from Procurement from a Country sharing a Land Border with India)	

Date of Issue: 9th March'23

	COMPOSITE SUPPLY CUM ERECTION OF ELECTRICAL & INSTRUMENTATION WORKS FOR OSBL FACILITIES ON ITEM RATE BASIS AT TALCHER FERTILIZERS LIMITED, ANGUL, ODISHA	PC-183/ E-8003/ S-III	0	
		DOC. NO.	REV.	
		Page 112 of 142		



7.0	Confirm submission of Checklist against Bid Evaluation Criteria as per format F-8(B)	
-----	--	--

Place:
Date:

[Signature of Authorized Signatory of Bidder]

Name:
Designation:

Date of Issue: 9th March'23

	COMPOSITE SUPPLY CUM ERECTION OF ELECTRICAL & INSTRUMENTATION WORKS FOR OSBL FACILITIES ON ITEM RATE BASIS AT TALCHER FERTILIZERS LIMITED, ANGUL, ODISHA	PC-183/ E-8003/ S-III	0	
		DOC. NO.	REV.	
		Page 113 of 142		

F-8(B)

CHECKLIST FOR BID EVALUATION CRITERIA (BEC) QUALIFYING DOCUMENTS
(refer Section II of Tender document)

BEC Clause No.	Description	Documents required for qualification	Documents Submitted by Bidder	Documents attested as per Section-II of Tender	Reference Page No. of the Bid submitted
Technical BEC					
1.	Experience	<p>(a) To meet the criteria A.1 above, Bidder must submit Copy of Detailed Letter of Acceptance (DLOA) / Work Order / relevant extract of work Order/ Contract Agreement along with detailed scope of work and Completion / Acceptance Certificate.</p> <p>The Detailed Letter of Acceptance (DLOA) / Work Order / Contract Agreement must clearly indicate nature of Work, period and contract value. Similarly, the Completion Certificate/ Acceptance Certificate must clearly indicate reference of relevant work order/ DLOA/ Contract Agreement, Name of Work, Contract Value, Completed order value and date of completion.</p>		Yes/No	
2	Experience of bidder acquired as a subcontractor	Certificate from End User			
3.	Job executed for Subsidiary / Fellow subsidiary/ Holding company.	Tax paid invoice(s) duly certified by statutory auditor of the bidder towards payment of statutory tax in support of the job executed for Subsidiary / Fellow subsidiary/ Holding company.		Yes/No	

Date of Issue: 9th March'23



**COMPOSITE SUPPLY CUM ERECTION OF
ELECTRICAL & INSTRUMENTATION WORKS FOR
OSBL FACILITIES ON ITEM RATE BASIS
AT
TALCHER FERTILIZERS LIMITED, ANGUL,
ODISHA**

PC-183/ E-8003/ S-III

0

DOC. NO.



REV.



Page 114 of 142

4.	Any other technical criteria in BEC			Yes/No	
	Financial BEC				
1.	Average Annual Turn Over	Audited Financial Statements [including Auditor's Report, Balance sheet, Profit & Loss Accounts statements, Notes & schedules etc.] for preceding three Audited Financial Years	Submitted	Yes/No	
2.	Net Worth	Audited Financial Statements [including Auditor's Report, Balance sheet, Profit & Loss Accounts statements, Notes & schedules etc.] for last Audited Financial Year.	Submitted (Mention specific year)	Yes/No	
3.	Working Capital	Audited Financial Statements [including Auditor's Report, Balance sheet, Profit & Loss Accounts statements, Notes & schedules etc.] for last Audited Financial Year. <i>If the bidder's working capital is negative or inadequate, the bidder shall submit a letter (in prescribed format) from their bank having net worth not less than Rs.100 Crores, confirming the availability of line of credit for at least working capital requirement as stated above.</i>	Submitted (Mention specific year.....) Submitted/ Not Applicable (Bidder to tick appropriate option)	Yes/No	
4.	Format for Details of financial capability of Bidder	Bidder shall submit "Details of financial capability of Bidder" in prescribed format duly signed and stamped by a chartered accountant / Certified Public Accountant (CPA).	Submitted		

Date of Issue: 9th March'23

	COMPOSITE SUPPLY CUM ERECTION OF ELECTRICAL & INSTRUMENTATION WORKS FOR OSBL FACILITIES ON ITEM RATE BASIS AT TALCHER FERTILIZERS LIMITED, ANGUL, ODISHA	PC-183/ E-8003/ S-III	0	
		DOC. NO.	REV.	
		Page 115 of 142		

Place:
Date:

[Signature of Authorized Signatory of Bidder]
Name:
Designation:
Seal

Date of Issue: 9th March'23

F-9

**FORMAT FOR CERTIFICATE FROM BANK
IF BIDDER'S WORKING CAPITAL IS INADEQUATE/NEGATIVE**

(To be provided on Bank's letter head)

Date:

To,
**M/s. TALCHER FERTILIZERS LIMITED
NOIDA**

Dear Sir,

This is to certify that M/s (name of the bidder with address)
(hereinafter referred to as Customer) is an existing customer of our Bank.

The Customer has informed that they wish to bid for TFL's RFQ/Tender no.
..... dated for(Name of
the supply/work/services/consultancy) and as per the terms of the said RFQ/Tender they have
to furnish a certificate from their Bank confirming the availability of line of credit.

Accordingly M/s (name of the Bank with address) confirms availability
of line of credit to M/s (name of the bidder) for at least an amount of Rs.

It is also confirmed that the net worth of the Bank is more than Rs. 100 Crores (or Equivalent
USD) and the undersigned is authorized to issue this certificate.

Yours truly

for (Name & address of Bank)

(Authorized signatory)

Name of the signatory:

Designation :

Stamp

Note:

This Declaration Letter for line of credit shall be from single bank only. Letters from multiple
banks shall not be applicable. However, banking syndicate will be acceptable wherein a group of
banks can jointly provide line of credit to the bidder.



**BALANCE JOB FOR 36" PERMANENT RAW
WATER PIPELINE
AT
TALCHER FERTILIZERS LIMITED,
ANGUL, ODISHA**

PC-183/ E-8003/ S-III 0
DOC. NO. REV.
Page 117 of 142



F-10

**FORMAT FOR CHARTERED ACCOUNTANT CERTIFICATE/ CERTIFIED PUBLIC
ACCOUNTANT (CPA) FOR FINANCIAL CAPABILITY OF THE BIDDER**

We have verified the Audited Financial Statements and other relevant records of M/s..... (Name of the bidder) and certify the following:

A. AUDITED ANNUAL TURNOVER* OF PRECEDING THREE FINANCIAL YEARS:

Year	Amount (Currency)
Year 1:	
Year 2:	
Year 3:	

B. NETWORTH* AS PER AUDITED FINANCIAL STATEMENT OF PRECEDING FINANCIAL YEAR:

Description	Year _____
	Amount (Currency)
1. Net Worth	

C. WORKING CAPITAL* AS PER AUDITED FINANCIAL STATEMENT OF PRECEDING FINANCIAL YEAR:

Description	Year _____
	Amount (Currency)
1. Current Assets	
2. Current Liabilities	
3. Working Capital (Current Assets-Current liabilities)	

****Refer Instructions***

Notes:

- (i) It is further certified that the above mentioned applicable figures are matching with the returns filed with Registrar of Companies (ROC) [Applicable only in case of Indian Companies]
- (ii) We confirm the above figures after referring instructions at page 2 of 2 of format F-10.
- (iii) Practicing Chartered Accountants shall generate Unique Document identification Number (UDIN) for all certificates issued by them.

Name of Audit Firm:
Chartered Accountant/CPA
Date:
Membership No.:

[Signature of Authorized Signatory]
Name:
Designation:
Seal:
UDIN:

(Page 1 of 2)

Date of Issue: 9th March'23



**BALANCE JOB FOR 36" PERMANENT RAW
WATER PIPELINE
AT
TALCHER FERTILIZERS LIMITED,
ANGUL, ODISHA**

PC-183/ E-8003/ S-III

0

DOC. NO.

REV.

Page 118 of 142



Instructions for Format F-10:

1. The Separate Pro-forma shall be used for each member in case of JV/ Consortium (If applicable).
2. The financial year would be the same as one normally followed by the bidder for its Annual Report.
3. The bidder shall provide the audited annual financial statements as required for this Tender document. Failure to do so would result in the Proposal being considered as non-responsive.
4. For the purpose of this Tender document:
 - (i) **Annual Turnover** shall be "Sale Value/ Operating Income"
 - (ii) **Working Capital** shall be "Current Assets less Current liabilities" and
 - (iii) **Net Worth** shall be Aggregate value of the paid-up share capital and all reserves created out of the profits and securities premium account, after deducting the aggregate value of the accumulated losses, deferred expenditure and miscellaneous expenditure not written off, if any, but does not include reserves created out of revaluation of assets, write back of depreciation and amalgamation.

In case the date of constitution/incorporation of the bidder is less than 3 years old, the average turnover in respect of the completed financial years after the date of constitution/ incorporation shall be taken into account for minimum Average Annual Financial Turnover criteria.

5. **Above figures shall be calculated after considering the qualification, if any, made by the statutory auditor on the audited financial statements of the bidder including quantified financial implication.**
6. This certificate is to be submitted on the letter head of Chartered Accountant/CPA.

(Page 2 of 2)

Date of Issue: 9th March'23



**BALANCE JOB FOR 36" PERMANENT RAW
WATER PIPELINE
AT
TALCHER FERTILIZERS LIMITED,
ANGUL, ODISHA**

PC-183/ E-8003/ S-III

0

DOC. NO.

REV.

Page 119 of 142



F-11

**FORMAT FOR CONSORTIUM AGREEMENT
(ON NON- JUDICIAL STAMP PAPER OF APPROPRIATE VALUE)
CONSORTIUM/JV AGREEMENT-**

Not Applicable

Date of Issue: 9th March'23



**BALANCE JOB FOR 36" PERMANENT RAW
WATER PIPELINE
AT
TALCHER FERTILIZERS LIMITED,
ANGUL, ODISHA**

PC-183/ E-8003/ S-III

0

DOC. NO.

REV.



Page 120 of 142

F-12

BIDDER'S QUERIES FOR PRE BID MEETING

To,

M/s TALCHER FERTILIZERS LIMITED
NOIDA

SUB:

TENDER NO:

SI. NO.	REFERENCE OF TENDER DOCUMENT				BIDDER'S QUERY	OWNER'S REPLY
	SEC. NO.	Page No.	Clause No	Subject		

NOTE: The Pre-Bid Queries may be sent by e-mail before due date for receipt of Bidder's queries.

SIGNATURE OF BIDDER: _____

NAME OF BIDDER: _____

Date of Issue: 9th March'23



**BALANCE JOB FOR 36" PERMANENT RAW
WATER PIPELINE
AT
TALCHER FERTILIZERS LIMITED,
ANGUL, ODISHA**

PC-183/ E-8003/ S-III

0

DOC. NO.

REV.

Page 121 of 142



F-13

E-Banking Mandate Form

(To be issued on vendors letter head)

1. Vendor/customer Name :
2. Vendor/customer Code:
3. Vendor /customer Address:
4. Vendor/customer e-mail id:
5. Particulars of bank account
 - a) Name of Bank
 - b) Name of branch
 - c) Branch code:
 - d) Address:
 - e) Telephone number:
 - f) Type of account (current/saving etc.)
 - g) Account Number:
 - h) RTGS IFSC code of the bank branch
 - i) NEFT IFSC code of the bank branch
 - j) 9 digit MICR code

I/We hereby authorize TFL to release any amount due to me/us in the bank account as mentioned above. I/We hereby declare that the particulars given above are correct and complete. If the transaction is delayed or lost because of incomplete or incorrect information, we would not hold the TFL responsible.

(Signature of vendor/customer)

BANK CERTIFICATE

We certify that ----- has an Account no. ----- with us and we confirm that the details given above are correct as per our records.

Bank stamp

Date

(Signature of authorized officer of bank)

Date of Issue: 9th March'23



**BALANCE JOB FOR 36" PERMANENT RAW
WATER PIPELINE
AT
TALCHER FERTILIZERS LIMITED,
ANGUL, ODISHA**

PC-183/ E-8003/ S-III

0

DOC. NO.

REV.

Page 122 of 142



**F-14
INTEGRITY PACT**

Pre-signed Integrity Pact

Date of Issue: 9th March'23

INTEGRITY PACT

INTEGRITY PACT

INTRODUCTION:

TFL as one of its endeavour to maintain and foster most ethical and corruption free business environment, have decided to adopt the Integrity Pact, a tool developed by the Transparency International, to ensure that all activities and transactions between the Company (TFL) and its Counterparties (Bidders, Contractors, Vendors, Suppliers, Service Providers/Consultants etc.) are handled in a fair and transparent manner, completely free of corruption.

Considering the above, the details mentioned at attached Annexure-1 are applicable as stated in Instruction to Bidders of Bid Document in addition to the existing stipulation regarding Corrupt and Fraudulent Practices.

The attached copy of the Integrity Pact at Annexure - 2 shall be included in the Bid submitted by the bidder (to be executed by the bidder for all tenders of value Rs. 1 (One) crore and above). In case a bidder does not sign the Integrity Pact, his bid shall be liable for rejection.



ANNEXURE-1

Bidder is required to sign the Integrity Pact with TFL as per format & terms and conditions enclosed with tender. In case a bidder does not sign the Integrity Pact, his bid shall be liable for rejection.

I COMMITMENTS AND OBLIGATIONS OF THE “COUNTERPARTY”

- a) The Counterparty, directly or indirectly (through agent, consultant, advisor, etc.), shall not pay any bribe/ influence or give undue/ unlawful benefit to anyone to gain undue advantage in dealing with TFL.
- b) The Counterparty will not engage in collusion of any kind including price fixation etc. with other Counterparts.
- c) The counterparty will not pass TFL's confidential information to any third party unless specifically authorized by TFL in writing.
- d) The Counterparties shall promote and observe best ethical practices within their respective organizations.
- e) The Counterparty shall inform the Independent External Monitor.
 - i) If it received any demand, directly or indirectly, for a bribe/ favour or any illegal gratification/ payment / benefit;
 - ii) If it comes to know of any unethical or illegal payment / benefit;
 - iii) If it makes any payment to any TFL associate.
- f) The Counterparty shall not make any false or misleading allegations against TFL or its associates.

II VIOLATIONS & CONSEQUENCES:

- a) If a Counterparty commits a violation of its Commitments and Obligations under the Integrity Pact Programme during bidding process, their entire Earnest Money Deposit/ Bid Security, would be forfeited and in addition, action shall be taken as per “Procedure for action in case Corrupt /Fraudulent/ Collusive/Coercive Practices”
- b) In case of violation of the Integrity pact by Counterparty after award of the Contract, TFL shall be entitled to terminate the Contract. Further, TFL would forfeit the security deposits/ Contract Performance Bank Guarantee and in addition, action shall be taken as per “Procedure for action in case Corrupt /Fraudulent/ Collusive/Coercive Practices”



INDEPENDENT EXTERNAL MONITORS (IEMS)

Presently the panel consisting of the following Independent External Monitors (IEMs) have been appointed by TFL, in terms of Integrity Pact (IP) which forms part of TFL Tenders / Contracts.

- i) Shri Sanjeev Prasad Narain Singh (Email ID: spns108@gmail.com)
- ii)

This panel is authorised to examine / consider all references made to it under this tender. The bidder(s), in case of any dispute(s) / complaint(s) pertaining to this tender may raise the issue either with the designated tender issuing officer or Nodal Officer (presently Sh. Manna Paul, DGM (C&P) – Email: mannapaul@gail.co.in) in TFL or directly with the IEMs on the panel or IEM c/o Chief Vigilance Officer, Rashtriya Chemicals and Fertilizers Ltd., Priyadarshini Building, Eastern Express Highway, Sion, Mumbai Maharashtra, 400022.



INTEGRITY PACT

(To be executed on plain paper)

Between Talcher Fertilizers Limited (TFL) [here-in-after referred to as “Principal”].

AND

_____ (here-in-after referred to as “The Bidder/ Contractor”).

(Principal and the Bidder / Contractor are here-in-after are referred to individually as “Party” or collectively as “Parties”).

PREAMBLE

The Principal intends to award under laid down organizational procedures, contract/s for _____. The Principal values full compliance with all relevant laws of land rules, regulations, and economic use of resources and of fairness /transparency in its relations with its Bidder (s) and/or Contractor (s).

In order to achieve these goals, the Principal will appoint Independent External Monitors (IEMs) who will monitor the tender process and the execution of the contract for compliance with the principles mentioned above.

Section 1 – Commitments of the Principal

1. The Principal commits itself to take all measures necessary to prevent corruption and to observe the following Principles:-
 - i) No employee of the Principal, personally or through family members, will in connection with the tender for, or the execution of a contract, demand, take a promise for or accept, for self or for a third person, any material or immaterial benefit which the person is not legally entitled to.
 - ii) The Principal will, during the tender process treat all Bidder(s) with equity and reasons. The Principal will in particular, before and during the tender process, provide to all Bidder(s) the same information and will not provide to any Bidder(s) confidential / additional information through which the Bidder(s) could obtain an advantage in relation to the tender process or the contract execution.

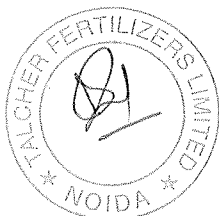

- iii) The Principal will exclude from the process all known prejudiced persons.
2. If the Principal obtains information on the conduct of any of its employees which is a criminal offence under the Indian Penal Code (IPC) / Prevention of Corruption Act (PC Act), or if there be a substantive suspicion in this regard, the Principal will inform the Chief Vigilance Officers and in addition can initiate disciplinary actions.

Section 2 – Commitments of the Bidder (s)/Contractor (s)

1. The Bidder(s) / Contractor(s) commits themselves to take all measures necessary to prevent corruption. The Bidder(s) / Contractor(s) commits themselves to observe the following principles during participation in the tender process and during the contract execution:
- i) The Bidder (s) / Contractor (s) will not, directly or through any other person or firm, offer, promise or give to any of the Principal's employees involved in the tender process or the execution of the contract or to any third person any material or other benefit which he / she is not legally entitled to, in order to obtain in exchange any advantage of any kind whatsoever during the tender process or during the execution of the contract.
 - ii) The Bidder (s) / Contractor (s) will not enter with other Bidders into any undisclosed agreement or understanding, whether formal or informal. This applies in particular to prices, specifications, certifications, subsidiary contracts, submission or non-submission of bids or any other action to restrict competitiveness or to introduce cartelisation in the bidding process.
 - iii) The Bidder (s) / Contractor (s) will not commit any offence under the relevant IPC/PC Act; further, the Bidder (s) / Contractor (s) will not use improperly, for purposes of competition or personal gain, or pass on to others, any information or document provided by the Principal as part of the business relationship, regarding plans, technical proposals and business details, including information contained or transmitted electronically.
 - iv) The Bidder (s)/ Contractor (s) of foreign origin shall disclose the name and address of the Agents/ representatives in India, if any. Similarly, the Bidder (s)/ Contractor (s) of Indian Nationality shall furnish the name and address of the foreign principals, if any. Further, all the payments made to the Indian agent/ representative have to be in India Rupees only.
 - v) The Bidder (s) / Contractor (s) will, when presenting their bid, disclose any and all payments made, is committed to or intends to make to agents,

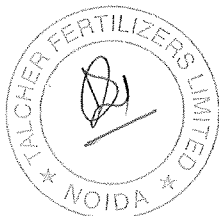

brokers or any other intermediaries in connection with the award of the contract.

- vi) Bidder(s) / Contractor(s) who have signed the Integrity Pact shall not approach the Courts while representing the matter to IEMs and shall wait for their decision in the matter.
2. The Bidder(s)/ Contractor(s) shall not instigate third person to commit offences outlined above or be an accessory to such offences.

Section 3 – Disqualification from tender process and exclusion from future contracts

If the Bidder (s) / Contractor (s), before award or during execution has committed a transgression through a violation of Section 2, above or in any other form such as to put their reliability or credibility in question, the Principal is entitled to disqualify the Bidder (s) / Contractor (s) from the tender process or take action as per provisions of “Procedure for action in case Corrupt /Fraudulent/ Collusive/Coercive Practices”.

Section 4 – Compensation for Damages

1. If the Principal has disqualified the Bidder (s) from the tender process prior to the award according to Section 3, the Principal is entitled to demand and recover the damages equivalent to Earnest Money Deposit / Bid Security.
2. If the Principal has terminated the contract according to Section 3, or if the Principal is entitled to terminate the contract according to Section 3, the Principal shall be entitled to demand and recover from the Contractor liquidated damages equal to the Contract Value or the amount equivalent to Performance Bank Guarantee.

Section 5 – Previous transgression

1. The Bidder declares that no previous transgression occurred in the last three years, with any other Company in any country conforming to the anti-corruption approach or with any Public Sector Enterprise in India that could justify his exclusion from the tender process.
2. If the Bidder makes incorrect statement on this subject, he can be disqualified from the tender process or actions can be taken as per provisions of “Procedure for action in case Corrupt /Fraudulent/ Collusive/Coercive Practices”



Section 6 – Equal treatment to all Bidders / Contractors / Subcontractors

1. In case of sub-contracting, the Principal contractor shall take the responsibility of the adoption of IP by the sub-contractor. It is to be ensured by him that all sub-contractors also sign the IP.
2. The Principal will enter into agreements with identical conditions as this one with all Bidders and Contractors.
3. The Principal will disqualify from the tender process all bidders who do not sign this Pact or violate its provisions.

Section 7 – Criminal charges against violating Bidder (s) / Contractor (s) / Sub-contractor (s)

If the Principal obtains knowledge of conduct of a Bidder, Contractor or Subcontractor, or of an employee or a representative or an associate of a Bidder, Contractor or Subcontractor which constitutes corruption, or if the Principal has substantive suspicion in this regard, the Principal will inform the same to the Chief Vigilance Officer.

Section 8 –Independent External Monitor / Monitors

1. The Principal appoints competent and credible Independent External Monitor for this Pact after approval by Central Vigilance Commission. The task of the Monitor is to review independently and objectively, whether and to what extent the parties comply with the obligations under this agreement.
2. The Monitor is not subject to instructions by the representatives of the parties and performs his/her functions neutrally and independently. The Monitor would have access to all documents / records pertaining to the contract for which a complaint or issue is raised before them, as and when warranted. However, the documents / records / information having National Security implications and those documents which have been classified as Secret/Top Secret are not to be disclosed. It will be obligatory for him/her to treat the information and documents of the Bidders / Contractors as confidential. He / she reports to MD, TFL.
3. The Bidder (s)/ Contractor (s) accepts that the Monitor has the right to access without restriction to all Project documentation of the Principal including that provided by the Contractor. The Contractor will also grant the Monitor, upon his/her request and demonstration of a valid interest, unrestricted and unconditional access to their project documentation. The same is applicable to Sub-contractors.
4. The Principal will provide to the Monitor sufficient information about all meetings among the parties related to the Project provided such meetings could have an

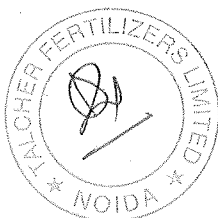

impact on the contractual relations between the Principal and the Contractor. The parties offer to the Monitor the option to participate in such meetings.

5. As soon as the Monitor notices, or believes to notice, a violation of this agreement, he/she will so inform the Management of the Principal and request the Management to discontinue or to take corrective action, or to take other relevant action. The monitor can in this regard submit non-binding recommendations. Beyond this, the Monitor has no right to demand from the parties that they act in a specific manner, refrain from action or tolerate action.
6. The Monitor will submit a written report to MD, TFL within 30 days from the date of reference or intimation to him by the 'Principal' and, should the occasion arise, submit proposals for correcting problematic situations.
7. If the Monitor has reported to MD, TFL, a substantiated suspicion of an offence under relevant IPC/PC Act, and MD, TFL has not, within reasonable time, taken visible action to proceed against such offence or reported it to the Chief Vigilance Officer, then, only in case of very serious issue having a specific verifiable Vigilance angle, the matter should be reported directly to the Central Vigilance Commission.
8. The word 'Monitor' would include both singular and plural.
9. In case of any complaints referred under IP Program, the role of IEMs is advisory and would not be legally binding and it is restricted to resolving the issues raised by an intending bidder regarding any aspect of the tender which allegedly restricts competition or bias towards some bidder.
10. After award of contract, the IEMs shall look into any issue relating to execution of contract, if specifically raised before them. As an illustrative example, if a contractor who has been awarded the contract, during the execution of contract, raises issue of delayed payment etc. before the IEMs, the same shall be examined by the panel of IEMs.

Section 9 – Pact Duration

This Pact begins when both parties have legally signed it. It expires for the Contractor 12 months after the last payment under the respective contract, and for all other Bidders 6 months after the contract has been awarded. Any violation to the same would entail disqualification of the bidders and exclusion from future business dealing.

If any claim is made / lodged during this time, the same shall be binding and continue to be valid despite the lapse of this pact as specified above, unless it is discharged/determined by MD, TFL.

Section 10 – Miscellaneous provisions

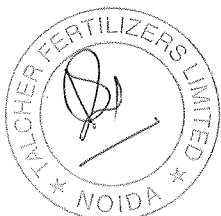

1. This agreement is subject to Indian Law. Place of performance and exclusive jurisdiction is the Registered Office of the Principal, i.e. New Delhi.
2. Changes and supplements as well as termination notices, if any, need to be made in writing. Side agreements have not been made.
3. If the Contractor/Bidder is a Joint Venture or a partnership concern or a consortium, this agreement must be signed by all partners or consortium members.
4. Should one or several of the provisions of this agreement turn out to be invalid, the remainder of this agreement shall remain valid. In this case, the parties will strive to come to an agreement to their original intentions in such a case.
5. Issues like warranty / guarantee, etc. shall be outside the purview of IEMs.
6. In the event of any contradiction between the Integrity Pact and its Annexure, the Clause in Integrity Pact will prevail.



 (For & on Behalf of Principal)

मन्ना पॉल/MANNA PAUL
 उप महाप्रबन्धक (संविदा एवं क्रय)/Dy. General Manager (C&P)
 तालचर फर्टिलाइजर्स लिमिटेड/Talcher Fertilizers Ltd.
 जीएटी पार्क बिल्डिंग/GTI PARC Building
 प्लॉट नं.- 24, सेक्टर-16ए, नोएडा-201 301 (उ.प्र.)
 Plot No. 24, Sec.-16A, Noida-201 301 (U.P.)

(Office Seal)

 (For & on Behalf of Bidder/Contractor)

(Office Seal)

Place -----

Date -----

Witness 1:
 (Sign, Name & Address)
 [FOR PRINCIPAL]

S. Deoam
 (SURA DEOYAM, DM (C&P)]
 TALCHER FERTILIZERS LIMITED (TFL),
 PLOT NO. 24, SECTOR-16A, NOIDA (U.P.)-201301

Witness 2:
 (Sign, Name & Address)
 [FOR BIDDER / CONTRACTOR]

.....



**BALANCE JOB FOR 36" PERMANENT RAW
WATER PIPELINE
AT
TALCHER FERTILIZERS LIMITED,
ANGUL, ODISHA**

PC-183/ E-8003/ S-III

0

DOC. NO.

REV.

Page 123 of 142



**F-15
INDEMNITY BOND**

WHEREAS TALCHER FERTILIZERS LIMITED (hereinafter referred to as "TFL") which expression shall, unless repugnant to the context include its successors and assigns, having its registered office at Plot 2/H, Kalpana Area, BJB Nagar, Khorda, Bhubaneswar – 751014 has entered into a contract with M/s*..... (hereinafter referred to as the "Contractor") which expression shall unless repugnant to the context include its representatives, successors and assigns, having its registered office at *..... and on the terms and conditions as set out, inter-alia in the [**mention the work order/LOA/Tender No.**] and various documents forming part thereof, hereinafter collectively referred to as the 'CONTRACT' which expression shall include all amendments, modifications and / or variations thereto.

TFL has also advised the Contractor to execute an Indemnity Bond in general in favour of TFL indemnifying TFL and its employees and Directors including Independent Directors from all consequences which may arise out of any prospective litigation or proceedings filed or may be initiated by any third party, including any Banker / financial institution / worker(s) / vendor(s) / subcontractor(s) etc. who may have been associated or engaged by the Contractor directly or indirectly with or without consent of TFL for above works.

NOW, THEREFORE, in consideration of the promises aforesaid, the Contractor hereby irrevocably and unconditionally undertakes to indemnify and keep indemnified TFL and all its employees, Directors, including Independent Directors, from and against all/any claim(s), damages, loss, which may arise out of any litigations/ liabilities that may be raised by the Contractor or any third party against TFL under or in relation to this contract. The Contractor undertakes to compensate and pay to TFL and/or any of its employees, Directors including Independent Directors, forth with on demand without any protest the amount claimed by TFL for itself and for and on behalf of its employees, Directors including Independent Directors together with direct/indirect expenses including all legal expenses incurred by them or any of them on account of such litigation or proceedings.

AND THE CONTRACTOR hereby further agrees with TFL that:

- (i) This Indemnity shall remain valid and irrevocable for all claims of TFL and/or any of its employees and Directors including Independent Directors arising out of said contract with respect to any such litigation / court case for which TFL and/or its employees and Directors including Independent Directors has been made party until now or here-in-after.
- (ii) This Indemnity shall not be discharged/ revoked by any change/ modification/ amendment/ assignment of the contract or any merger of the Contractor with other entity or any change in the constitution/structure of the Contractor's firm/ Company or any conditions thereof including insolvency etc. of the Contractor, but shall be in all respects and for all purposes binding and operative until any/ all claims for payment of TFL are settled by the Contractor and/or TFL discharges the Contractor in writing from this Indemnity.

Date of Issue: 9th March'23



**BALANCE JOB FOR 36" PERMANENT RAW
WATER PIPELINE
AT
TALCHER FERTILIZERS LIMITED,
ANGUL, ODISHA**

PC-183/ E-8003/ S-III

0

DOC. NO.

REV.

Page 124 of 142



The undersigned has full power to execute this Indemnity Bond for and on behalf of the Contractor and the same stands valid.

SIGNED BY :

For [Contractor]

Authorised Representative

Place:

Dated:

Witnesses:1.

2.

Date of Issue: 9th March'23



**BALANCE JOB FOR 36" PERMANENT RAW
WATER PIPELINE
AT
TALCHER FERTILIZERS LIMITED,
ANGUL, ODISHA**

PC-183/ E-8003/ S-III

0

DOC. NO.

REV.

Page 125 of 142



**F-16
FREQUENTLY ASKED QUESTIONS (FAQs)**

SL.NO.	QUESTION	ANSWER
1.0	Can any vendor quote for subject Tender?	Yes. A Vendor has to meet Bid Evaluation Criteria given under Section II of Tender document in addition to other requirements.
2.0	Should the Bid Evaluation Criteria documents be attested?	Yes. Please refer Section II of Tender document
3.0	Is attending Pre Bid Meeting mandatory.	No. Refer Clause No. 17 of Instruction to Bidders of Tender Document. However attending Pre Bid Meeting is recommended to sort out any issue before submission of bid by a Bidder.
4.0	Can a vendor submit more than 1 offer?	No. Please refer Clause No. 4 of Instruction to Bidders of Tender Document.
5.0	Is there any Help document available for e-Tender.	Refer FAQs as available on CPP Portal e-Procurement).
6.0	Are there are any MSE (Micro & Small Enterprises) benefits available?	Refer Clause No. 40 of Instructions to Bidders of Tender Document.
7.0	Are there are any benefits available to Startups?	Refer Clause No. 49 of Instructions to Bidders of Tender Document.

All the terms and conditions of Tender remain unaltered.

Date of Issue: 9th March'23



**BALANCE JOB FOR 36" PERMANENT RAW
WATER PIPELINE
AT
TALCHER FERTILIZERS LIMITED,
ANGUL, ODISHA**

PC-183/ E-8003/ S-III

0

DOC. NO.

REV.

Page 126 of 142



**Form F-17
(Not Applicable for this Tender)**

**PROFORMA OF BANK GUARANTEE FOR MOBILISATION ADVANCE
(ON NON-JUDICIAL PAPER OF APPROPRIATE VALUE)**

To, M/s Talcher Fertilizers Limited, Noida	Bank Guarantee No.	
	Date of BG	
	BG Valid up to	
	Claim period up to (There should be three months gap between expiry date of BG & Claim period)	
	Stamp Sl. No. / e-Stamp Certificate No.	

Dear Sir(s),

In consideration of the Talcher Fertilizers Limited, hereinafter called the "Owner" which expression shall unless repugnant to the context or meaning thereof include its successors, executors, administrators and assignees, having awarded to M/s..... having its registered office at hereinafter referred as the 'CONTRACTOR', which expression shall unless repugnant to the context or meaning thereof, include its successors, administrators, executors and assignees, a contract hereinafter referred to as the 'Contract' for related works..... referred to as the 'WORK' on terms and conditions set out, inter-alia in the Owner's Contract / DLOA / FOA No.....dated..... valued at..... (in words & figures) and as the Owner having agreed to make an advance payment (herein after referred as Mobilization advance) for the performance of the above contract to the CONTRACTOR amounting to.....(in words & figures) as an advance against Bank Guarantee to be furnished by the CONTRACTOR.

We..... hereinafter referred to as the BANK which expression shall, unless repugnant to the context or meaning thereof, include its successors, administrators, executors and assignees having our office at..... do hereby undertake to give the irrevocable and unconditional guarantee and do hereby undertake to pay the OWNER on first demand without any demur, reservation, contest, recourse, protest and without reference to the CONTRACTOR any and all monies payable by the CONTRACTOR by reason of any breach by the said CONTRACTOR of any of the terms and conditions of the said Contract to the extent of..... till the said advance is adjusted as aforesaid at any time upto..... We agree that the guarantee herein contained shall continue to be enforceable till the sum due

Date of Issue: 9th March'23



**BALANCE JOB FOR 36" PERMANENT RAW
WATER PIPELINE
AT
TALCHER FERTILIZERS LIMITED,
ANGUL, ODISHA**

PC-183/ E-8003/ S-III

0

DOC. NO.

REV.



Page 127 of 142

to the Owner on account of the said advance is adjusted/ recovered in full as aforesaid or till the Owner discharges this guarantee **in writing**.

The OWNER shall have the fullest liberty without affecting in any way the liability of the BANK under this guarantee, from time to time to vary the advance or to extend the time for performance of the works by the CONTRACTOR. The BANK shall not be released from its liability under these presents by any exercise of the Owner of the liberty with reference to the matter aforesaid.

The Owner shall have the fullest liberty, without reference to CONTRACTOR and without affecting this guarantee to postpone for any time or from time to time the exercise of any powers vested in them or of any right which they might have against the CONTRACTOR, and to exercise the same at any time in any manner, and either to enforce or to forebear to enforce any power, covenants contained or implied in the Contract between the OWNER and the CONTRACTOR or any other course or remedy or security available to the OWNER and the BANK shall not be released of its obligations under these presents by any exercise by the OWNER of its liberty with reference to matters aforesaid or other acts of omission or commission on the part of the OWNER or any other law would, but for this provision, have the effect of releasing the BANK.

The right of the OWNER to recover the outstanding sum of advance upto Rs.....from the BANK in the manner aforesaid **is absolute and unequivocal and** will not be affected or suspended by reason of the fact that any dispute or disputes has or have been raised by the CONTRACTOR and/or that any dispute or disputes is or are pending before any officer, tribunal or court **or arbitrator or any other authority/forum** and any demand made by OWNER on the BANK shall be conclusive and binding.

The BANK further undertakes not to revoke this guarantee during its currency without previous consent of the OWNER and further agrees that the guarantee contained shall continue to be enforceable **until it is discharged by TFL in writing**.

The BANK also agrees that the OWNER shall at its option be entitled to enforce this guarantee against the BANK as a principal debtor, in the first instance, notwithstanding any other security or guarantee that OWNER may have in relation to the CONTRACTOR's liabilities towards the said advance.

The amount under the Bank Guarantee is payable forthwith without any delay by Bank upon the written demand raised by TFL. Any dispute arising out of or in relation to the said Bank Guarantee shall be subject to the exclusive jurisdiction of courts at New Delhi.

Therefore, we hereby affirm that we are guarantors and responsible to you on behalf of the Contractor up to a total amount of _____ (amount of guarantees in words and figures) and we undertake to pay you, upon your first written demand declaring the Contractor to be in default under the contract and without caveat or argument, any sum or sums within the limits of _____ (amount of guarantee) as aforesaid, without your needing to prove or show grounds or reasons for your demand or the sum specified therein.

We have power to issue this guarantee in your favour under Memorandum and Articles of Association and the undersigned has full power to do so under the Power of Attorney/ resolution of the Board of Directors dated..... accorded to him by the BANK.

Date of Issue: 9th March'23



**BALANCE JOB FOR 36" PERMANENT RAW
WATER PIPELINE
AT
TALCHER FERTILIZERS LIMITED,
ANGUL, ODISHA**

PC-183/ E-8003/ S-III

0

DOC. NO.

REV.

Page 128 of 142



Notwithstanding anything contained herein:

- a) The Bank's liability under this Guarantee shall not exceed (currency in figures) _____ (currency in words only) _____
- b) This Guarantee shall remain in force upto _____ (three months beyond Completion Period) and any extension(s) thereof; and
- c) The Bank shall be released and discharged from all liability under this Guarantee unless a written claim or demand is issued to the Bank on or before the midnight of _____ (indicate date of expiry of claim period which includes minimum three months from the expiry of this Bank Guarantee) and if extended, the date of expiry of the last extension of this Guarantee. If a claim has been received by us within the said date, all the rights of TFL under this Guarantee shall be valid and shall not cease until we have satisfied that claim.

Dated.....this.....day of.....20

Signed by

(Person duly authorised by Bank)

Place:

WITNESS :

1..... (Signature)

..... (Printed Name)

..... (Designation)

2..... (Signature)

..... (Printed Name)

..... (Designation)

(Common Seal)

Date of Issue: 9th March'23



**BALANCE JOB FOR 36" PERMANENT RAW
WATER PIPELINE
AT
TALCHER FERTILIZERS LIMITED,
ANGUL, ODISHA**

PC-183/ E-8003/ S-III

0

DOC. NO.

REV.

Page 129 of 142



F-17 (A)

**MATTER TO BE MENTIONED IN COVERING LETTER TO BE SUBMITTED BY
VENDOR ALONG WITH BANK GUARANTEE (BG)**

1. Bank Guarantee No.					
2. Vendor Name					
3. Nature of Bank Guarantee [Please Tick () whichever is applicable]	<table border="1"><tr><td>Contract Performance</td><td rowspan="3">Advance</td></tr><tr><td>Security (CPS)</td></tr><tr><td></td></tr></table>	Contract Performance	Advance	Security (CPS)	
Contract Performance	Advance				
Security (CPS)					
Purchase Order (PO) / Fax of Acceptance (FOA) / Detailed Letter of Acceptance (DLOA) No.					
Details of Bank issuing Bank Guarantee (BG)					
A. Name					
B. E-mail ID					
C. Address					
D. Phone No. / Mobile No.					

Date of Issue: 9th March'23



**BALANCE JOB FOR 36" PERMANENT RAW
WATER PIPELINE
AT
TALCHER FERTILIZERS LIMITED,
ANGUL, ODISHA**

PC-183/ E-8003/ S-III

0

DOC. NO.

REV.

Page 130 of 142



Date of Issue: 9th March'23



**BALANCE JOB FOR 36" PERMANENT RAW
WATER PIPELINE
AT
TALCHER FERTILIZERS LIMITED,
ANGUL, ODISHA**

PC-183/ E-8003/ S-III

0

DOC. NO.

REV.

Page 131 of 142



F-18

(Not Applicable for this Tender)

**PROFORMA FOR BANK GUARANTEE FOR PAYMENTS TOWARDS PLACEMENT OF ALL
PURCHASE ORDERS OF MAJOR TAGGED ITEMS.**

(To be submitted on Rs. 500/-(five hundred) non judicial stamp paper)

Ref.....

Bank Guarantee No.-----

Date.....

To,
M/s Talcher Fertilizers Limited

Dear Sir(s),

In consideration of the Talcher Fertilizers Limited, hereinafter called the "Owner" which expression shall unless repugnant to the context or meaning thereof include its successors, executors, administrators and assignees, having awarded to M/s..... having its registered office at hereinafter referred as the 'CONTRACTOR', which expression shall unless repugnant to the context or meaning thereof, include its successors, administrators, executors and assignees, a contract hereinafter referred to as the 'Contract' for related works..... referred to as the 'WORK' on terms and conditions set out, inter-alia in the Owner's Contract / DLOA / FOA No.....dated..... valued at..... (in words & figures) and as the Owner having agreed to make milestone payments (for the performance of the above contract to the CONTRACTOR amounting to.....(in words & figures) against Bank Guarantee to be furnished by the CONTRACTOR.

We..... hereinafter referred to as the BANK which expression shall, unless repugnant to the context or meaning thereof, include its successors, administrators, executors and assignees having our office at..... do hereby undertake to give the irrevocable and unconditional guarantee and do hereby undertake to pay the OWNER on first demand without any demur, reservation, contest, recourse, protest and without reference to the CONTRACTOR any and all monies payable by the CONTRACTOR by reason of any breach by the said CONTRACTOR of any of the terms and conditions of the said Contract to the extent of.....We agree that the guarantee herein contained shall continue to be enforceable till the Owner discharges this guarantee **in writing.**

The OWNER shall have the fullest liberty without affecting in any way the liability of the BANK under this guarantee, from time to time to vary the amount or to extend the time for performance of the works by the CONTRACTOR. The BANK shall not be released from its liability under these presents by any exercise of the Owner of the liberty with reference to the matter aforesaid.

Date of Issue: 9th March'23



**BALANCE JOB FOR 36" PERMANENT RAW
WATER PIPELINE
AT
TALCHER FERTILIZERS LIMITED,
ANGUL, ODISHA**

PC-183/ E-8003/ S-III

0

DOC. NO.

REV.



Page 132 of 142

The Owner shall have the fullest liberty, without reference to CONTRACTOR and without affecting this guarantee to postpone for any time or from time to time the exercise of any powers vested in them or of any right which they might have against the CONTRACTOR, and to exercise the same at any time in any manner, and either to enforce or to forebear to enforce any power, covenants contained or implied in the Contract between the OWNER and the CONTRACTOR or any other course or remedy or security available to the OWNER and the BANK shall not be released of its obligations under these presents by any exercise by the OWNER of its liberty with reference to matters aforesaid or other acts of omission or commission on the part of the OWNER or any other law would, but for this provision, have the effect of releasing the BANK.

The right of the OWNER to recover the outstanding sum upto Rs..... from the BANK in the manner aforesaid is **absolute and unequivocal and** will not be affected or suspended by reason of the fact that any dispute or disputes has or have been raised by the CONTRACTOR and/or that any dispute or disputes is or are pending before any officer, tribunal or court or **arbitrator or any other authority/forum** and any demand made by OWNER on the BANK shall be conclusive and binding.

The BANK further undertakes not to revoke this guarantee during its currency without previous consent of the OWNER and further agrees that the guarantee contained shall continue to be enforceable **until it is discharged by TFL in writing.**

The BANK also agrees that the OWNER shall at its option be entitled to enforce this guarantee against the BANK as a principal debtor, in the first instance, notwithstanding any other security or guarantee that OWNER may have in relation to the CONTRACTOR's liabilities towards the said milestone payment .

The amount under the Bank Guarantee is payable forthwith without any delay by Bank upon the written demand raised by TFL. Any dispute arising out of or in relation to the said Bank Guarantee shall be subject to the exclusive jurisdiction of courts at New Delhi.

Therefore, we hereby affirm that we are guarantors and responsible to you on behalf of the Contractor up to a total amount of _____ (amount of guarantees in words and figures) and we undertake to pay you, upon your first written demand declaring the Contractor to be in default under the contract and without caveat or argument, any sum or sums within the limits of _____ (amount of guarantee) as aforesaid, without your needing to prove or show grounds or reasons for your demand or the sum specified therein.

Notwithstanding anything contained hereinabove, our liability under this guarantee is restricted to _____ and it will remain in force upto and including _____ (this date shall be initially 15 months from date of FOA) and shall be extended from time to time for such periods as may be advised by M/s _____ on whose behalf this guarantee has been given.

We have power to issue this guarantee in your favour under Memorandum and Articles of Association and the undersigned has full power to do so under the Power of Attorney/ resolution of the Board of Directors dated..... accorded to him by the BANK.

Notwithstanding anything contained herein:

9.

Date of Issue: 9th March'23



**BALANCE JOB FOR 36" PERMANENT RAW
WATER PIPELINE
AT
TALCHER FERTILIZERS LIMITED,
ANGUL, ODISHA**

PC-183/ E-8003/ S-III

0

DOC. NO.

REV.

Page 133 of 142



- a) The Bank's liability under this Guarantee shall not exceed (currency in figures) _____ (currency in words only) _____
- b) This Guarantee shall remain in force upto _____ (this date shall be initially 15 months from date of FOA) and any extension(s) thereof; and
- c) The Bank shall be released and discharged from all liability under this Guarantee unless a written claim or demand is issued to the Bank on or before the midnight of _____ (indicate date of expiry of claim period which includes minimum three months from the expiry of this Bank Guarantee) and if extended, the date of expiry of the last extension of this Guarantee. If a claim has been received by us within the said date, all the rights of TFL under this Guarantee shall be valid and shall not cease until we have satisfied that claim.

Dated.....this.....day of.....20

Signed by

(Person duly authorised by Bank)

Place:

WITNESS :

1..... (Signature)
..... (Printed Name)
..... (Designation)

2..... (Signature)
..... (Printed Name)
..... (Designation)

(Common Seal)

Date of Issue: 9th March'23



**BALANCE JOB FOR 36" PERMANENT RAW
WATER PIPELINE
AT
TALCHER FERTILIZERS LIMITED,
ANGUL, ODISHA**

PC-183/ E-8003/ S-III

0

DOC. NO.

REV.

Page 134 of 142



F-19

**FORMAT OF LETTER OF NO DEVIATIONS
(ON BIDDER'S LETTERHEAD)**

(NIT NO : DATED)

We *_____ hereby agree to fully comply with, abide by and accept without variation, deviation or reservation all technical, commercial and other condition whatsoever of the Bidding Documents and all Addenda / Corrigenda / Amendment/ Clarifications issued by OWNER.

We further hereby confirm that the bid is submitted in accordance of Tender Document and contains no deviation and the price bid submitted may be treated to conform to, in all respects, with the terms and conditions of the said tender documents including all Addenda / Corrigenda/ Amendment /Clarifications.

For and on behalf of* :

Stamp & Signature** :

Name :

Designation :

Date :

*Here fill in the name of bidder.

**The Letter of *No Deviation* must be signed by the person (s) authorized to sign as per POA.

Date of Issue: 9th March'23



**BALANCE JOB FOR 36" PERMANENT RAW
WATER PIPELINE
AT
TALCHER FERTILIZERS LIMITED,
ANGUL, ODISHA**

PC-183/ E-8003/ S-III

0

DOC. NO.

REV.

Page 135 of 142



**F-20
POWER OF ATTORNEY (POA)**

(To be submitted on the Non-Judicial stamp paper / Company's Letter Head)

TENDER NO:

Description of work:

Name of Bidder: _____

"The undersigned _____ (Name of LEGAL PERSON, i.e. CEO/C&MD/Company Secretary/Partners) is lawfully authorized to issue this POA* on behalf of the company M/s _____ (Name of bidder) whose registered address is _____ and does hereby appoint Mr./Ms _____ (name of authorized person signing the bid document) _____ (Designation) of M/s _____ (Name of bidder) whose signature appears below to be the true and lawful attorney/(s) and authorize him/her to sign the bid (both physically & digitally on CPP Portal), conduct negotiation, sign contracts and execute all the necessary matter related thereto, in the name and on behalf of the company in connection with the tender no. _____.

The signature of the authorized person/(s) herein constitutes unconditional obligations of M/s _____ (Name of bidder).

This Power of Attorney (POA) shall remain valid and in full force and effect before we withdraw it in writing (by fax, or mail or post). All the documents signed (within the period of validity of the Power of Attorney) by the authorized person herein shall not be invalid because of such withdrawal.

(* In case of a single Bidder, the Power of Attorney shall be issued as per the constitution of the bidder as below.

- a) **In case of Proprietorship:** By Proprietor
- b) **In case of Partnership:** by all Partners or Managing Partner.
- c) **In case of Limited Liability Partnership:** by any bidder's employee authorized in terms of Deed of LLP.
- d) **In case of Public /Limited Company:** POA in favour of authorized employee(s) by Board of Directors through Board Resolution or by the designated officer authorized by Board to do so. Such Board Resolution should be duly countersigned by Company Secretary / MD / CMD / CEO.

SIGNATURE OF THE LEGAL PERSON

(Name of person with Company seal)

Date of Issue: 9th March'23



**BALANCE JOB FOR 36" PERMANENT RAW
WATER PIPELINE
AT
TALCHER FERTILIZERS LIMITED,
ANGUL, ODISHA**

PC-183/ E-8003/ S-III

0

DOC. NO.

REV.

Page 136 of 142



SIGNATURE OF THE AUTHORIZED PERSON
(FOR SIGNING THE BID)

(Signature)

Name of person: _____

E-mail id: _____

DSC (Digital Signature Certificate) No.: _____

Date of Issue: 9th March'23



**BALANCE JOB FOR 36" PERMANENT RAW
WATER PIPELINE
AT
TALCHER FERTILIZERS LIMITED,
ANGUL, ODISHA**

PC-183/ E-8003/ S-III

0

DOC. NO.

REV.

Page 137 of 142



F-21
**UNDERTAKING REGARDING SUBMISSION OF ELECTRONIC INVOICE (E-INVOICE AS
PER GST LAWS)**

(to be submitted on letter head along with documents for release of payment)

To,
M/s TALCHER FERTILIZERS LIMITED

SUB:
LOA NO:
Dear Sir,

We _____ (Name of the Supplier/Contractor/Service Provider/ Consultant)
hereby confirm that E-Invoice provision as per the GST Law is

- (i) Applicable to us []
- (ii) Not Applicable to us []

**(Supplier/Contractor/Service Provider/ Consultant is to tick appropriate option (✓ or X)
above).**

In case, same is applicable to us, we confirm that we will submit E-Invoice after complying with all the requirements of GST Laws. If the invoice issued without following this process, such invoice can-not be processed for payment by TFL as no ITC is allowed on such invoices. We also confirm that If input tax credit is not available to TFL for any reason attributable to Supplier/Contractor/Service Provider/ Consultant (both for E-invoicing cases and non-E-invoicing cases), then TFL shall not be obligated or liable to pay or reimburse GST (CGST & SGST/UTGST or IGST) claimed in the invoice(s) and shall be entitled to deduct / setoff / recover such GST amount (CGST & SGST/UTGST or IGST) or Input Tax Credit amount together with penalties and interest, if any, by adjusting against any amounts paid or becomes payable in future to the Supplier/Contractor/Service Provider/ Consultant under this contract or under any other contract.

Place: [Signature of Authorized Signatory of Bidder]

Date: Name:
Designation:
Bidder Name:
Seal:

Date of Issue: 9th March'23



**BALANCE JOB FOR 36" PERMANENT RAW
WATER PIPELINE
AT
TALCHER FERTILIZERS LIMITED,
ANGUL, ODISHA**

PC-183/ E-8003/ S-III

0

DOC. NO.

REV.

Page 138 of 142



Form F-22

**UNDERTAKING REGARDING SUBMISSION OF CONTRACT PERFORMANCE SECURITY
(CPS)/ SECURITY DEPOSIT (SD) WITHIN STIPULATED TIME LINE
(to be submitted on letter head of bidder)**

To,
M/s Talcher Fertilizers Limited

SUB:
TENDER NO:

Dear Sir,

We hereby confirm that we have clearly understood the requirement of Contract Performance Security (CPS) / Security Deposit (SD) specified in the tender document.

We also hereby confirm that in case of award of contract / order, we will submit Contract Performance Security (CPS) / Security Deposit (SD) within 30 days from the date of issuance of Fax of Acceptance.

Place:
Date:

[Signature of Authorized Signatory of Bidder]
Name:
Designation:
Bidder Name:
Seal:

Date of Issue: 9th March'23



**BALANCE JOB FOR 36" PERMANENT RAW
WATER PIPELINE
AT
TALCHER FERTILIZERS LIMITED,
ANGUL, ODISHA**

PC-183/ E-8003/ S-III

0

DOC. NO.

REV.

Page 139 of 142



F-23

PROFORMA FOR CONTRACT AGREEMENT

(To be executed on non-judicial stamp paper of appropriate value)

DLOA No. dated

TFL's PAN No.

Contract Agreement for the work of ----- of TALCHER FERTILIZERS LIMITED made on ----- between (Name and Address)-----, hereinafter called the "CONTRACTOR" (which term shall unless excluded by or repugnant to the subject or context include its successors and permitted assignees) of the one part and TALCHER FERTILIZERS LIMITED hereinafter called the "EMPLOYER" (which term shall, unless excluded by or repugnant to the subject or context include its successors and assignees) of the other part.

WHEREAS

- A. The EMPLOYER being desirous of having provided and executed certain work mentioned, enumerated or referred to in the Tender Documents including Letter Inviting Tender, General Tender Notice, General Conditions of Contract, Special Conditions of Contract, Specifications, Drawings, Plans, Time Schedule of completion of jobs, Schedule of Rates, Agreed Variations, other documents has called for Tender.
- B. The CONTRACTOR has inspected the SITE and surroundings of WORK specified in the Tender Documents and has satisfied himself by careful examination before submitting his tender as to the nature of the surface, strata, soil, sub-soil and ground, the form and nature of site and local conditions, the quantities, nature and magnitude of the work, the availability of labour and materials necessary for the execution of work, the means of access to SITE, the supply of power and water thereto and the accommodation he may require and has made local and independent enquiries and obtained complete information as to the matters and thing referred to, or implied in the tender documents or having any connection therewith and has considered the nature and extent of all probable and possible situations, delays, hindrances or interferences to or with the execution and completion of the work to be carried out under the CONTRACT, and has examined and considered all other matters, conditions and things and probable and possible contingencies, and generally all matters incidental thereto and ancillary thereof affecting the execution and completion of the WORK and which might have influenced him in making his tender.
- C. The Tender Documents including the Notice Letter Inviting Tender, General Conditions of Contract, Special Conditions of Contract, Schedule of Rates, General Obligations, SPECIFICATIONS, DRAWINGS, PLANS, Time Schedule for completion of Jobs, Letter of Acceptance of Tender and any statement of agreed variations with its enclosures copies of which are hereto annexed form part of this CONTRACT though separately set out herein and are included in the expression "CONTRACT" wherever herein used.

Date of Issue: 9th March'23



**BALANCE JOB FOR 36" PERMANENT RAW
WATER PIPELINE
AT
TALCHER FERTILIZERS LIMITED,
ANGUL, ODISHA**

PC-183/ E-8003/ S-III

0

DOC. NO.

REV.

Page 140 of 142



AND WHEREAS

The EMPLOYER accepted the Tender of the CONTRACTOR for the provision and the execution of the said WORK at the rates stated in the schedule of quantities of the work and finally approved by EMPLOYER (hereinafter called the "Schedule of Rates") upon the terms and subject to the conditions of CONTRACT.

NOW THIS AGREEMENT WITNESSETH AND IT IS HEREBY AGREED AND DECLARED AS FOLLOWS:-

1. In consideration of the payment to be made to the CONTRACTOR for the WORK to be executed by him, the CONTRACTOR hereby covenants with EMPLOYER that the CONTRACTOR shall and will duly provide, execute and complete the said work and shall do and perform all other acts and things in the CONTRACT mentioned or described or which are to be implied there from or may be reasonably necessary for the completion of the said WORK and at the said times and in the manner and subject to the terms and conditions or stipulations mentioned in the contract.
2. In consideration of the due provision execution and completion of the said WORK, EMPLOYER does hereby agree with the CONTRACTOR that the EMPLOYER will pay to the CONTRACTOR the respective amounts for the WORK actually done by him and approved by the EMPLOYER at the Schedule of Rates and such other sum payable to the CONTRACTOR under provision of CONTRACT, such payment to be made at such time in such manner as provided for in the CONTRACT.

A N D

3. In consideration of the due provision, execution and completion of the said WORK the CONTRACTOR does hereby agree to pay such sums as may be due to the EMPLOYER for the services rendered by the EMPLOYER to the CONTRACTOR, such as power supply, water supply and others as set for in the said CONTRACT and such other sums as may become payable to the EMPLOYER towards the controlled items of consumable materials or towards loss, damage to the EMPLOYER'S equipment, materials construction plant and machinery, such payments to be made at such time and in such manner as is provided in the CONTRACT.

It is specifically and distinctly understood and agreed between the EMPLOYER and the CONTRACTOR that the CONTRACTOR shall have no right, title or interest in the SITE made available by the EMPLOYER for execution of the works or in the building, structures or work executed on the said SITE by the CONTRACTOR or in the goods, articles, materials etc., brought on the said SITE (unless the same specifically belongs to the CONTRACTOR) and the CONTRACTOR shall not have or deemed to have any lien whatsoever charge for unpaid bills will not be entitled to assume or retain possession or control of the SITE or structures and the EMPLOYER shall have an absolute and unfettered right to take full possession of SITE and to remove the CONTRACTOR, their servants, agents and materials belonging to the CONTRACTOR and lying on the SITE.

Date of Issue: 9th March'23



**BALANCE JOB FOR 36" PERMANENT RAW
WATER PIPELINE
AT
TALCHER FERTILIZERS LIMITED,
ANGUL, ODISHA**

PC-183/ E-8003/ S-III

0

DOC. NO.

REV.



Page 141 of 142

The CONTRACTOR shall be allowed to enter upon the SITE for execution of the WORK only as a licensee simpliciter and shall not have any claim, right, title or interest in the SITE or the structures erected thereon and the EMPLOYER shall be entitled to terminate such license at any time without assigning any reason.

The materials including sand, gravel, stone, loose, earth, rock etc., dug up or excavated from the said SITE shall, unless otherwise expressly agreed under this CONTRACT, exclusively belong to the EMPLOYER and the CONTRACTOR shall have no right to claim over the same and such excavation and materials should be disposed off on account of the EMPLOYER according to the instruction in writing issued from time to time by the ENGINEER-IN-CHARGE.

In Witness whereof the parties have executed these presents in the day and the year first above written.

Signed and Delivered for and on behalf of EMPLOYER

Signed and Delivered for and on behalf of the CONTRACTOR.

TALCHER FERTILIZERS LIMITED

NAME OF CONTRACTOR

Date : _____

Date : _____

Place: _____

Place: _____

IN PRESENCE OF TWO WITNESSES

1. _____

1. _____

2. _____

2. _____

Date of Issue: 9th March'23



**BALANCE JOB FOR 36" PERMANENT RAW
WATER PIPELINE
AT
TALCHER FERTILIZERS LIMITED,
ANGUL, ODISHA**

PC-183/ E-8003/ S-III

0

DOC. NO.

REV.

Page 142 of 142



F-24

**NO CLAIM CERTIFICATE
(TO BE SUBMITTED BEFORE RELEASE OF CPS/SECURITY DEPOSIT)**

[On the Letter-head of Supplier/Vendor]

We, _____, a company incorporated under the laws of India/ a Consortium between *____ and *____ (*name of Consortium partners to be inserted*)/ a Partnership Firm consisting of *____ and *____ (*name of Partners to be inserted*)/ a Sole Proprietorship (as the case may be), having its registered office at _____ and carrying on business under the name and style M/s. _____ were awarded the contract by TFL in reference to Tender No. _____ dated _____ ("Order/Contract").

After completion of the above-said items/job under the Order/Contract, we have scrutinized all our claims, contentions, disputes, issues and we hereby confirm that after adjusting all payments received by us against our R.A. Bills and final bill, we have no claims, dues, issues and contentions from TFL.

We further absolve TFL from all liabilities present or future arising directly or indirectly out of the Contract.

There is no economic duress or any other compulsion on us for submission of this no claim certificate.

Signature with Seal of Supplier/Vendor

Dated:

Date of Issue: 9th March'23



PROJECTS & DEVELOPMENT INDIA LIMITED

PC-183/ E-8003/ S-IV

0

DOC. NO.

REV.

Page 1 of 68



GENERAL CONDITIONS OF CONTRACT

Date of Issue: 9th March'23



**COMPOSITE SUPPLY CUM ERECTION OF
ELECTRICAL & INSTRUMENTATION WORKS FOR
OSBL FACILITIES ON ITEM RATE BASIS
AT
TALCHER FERTILIZERS LIMITED, ANGUL, ODISHA
GENERAL CONDITION OF CONTRACT**

PC-183/ E-8003/ S-IV

0

DOC. NO.

REV.



Page 2 of 68

TABLE OF CONTENTS

Sl.No.	Description
(i)	TABLE OF CONTENTS
(II)	SUBMISSION OF TENDER
SECTION-I (DEFINITIONS)	
1.0	Definition of Terms
SECTION-II (GENERAL INFORMATIONS)	
2.0	General Information
2.1	(a) Location of Site (b) Access by Road
2.2	Scope of Work
2.3	Water Supply
2.4	Power Supply
2.5	Land for Contractor's field office, Godown and Workshop
2.6	Land for Residential Accommodation
SECTION-III (GENERAL INSTRUCTIONS TO TENDERERS)	
3.0	Submission of Tender
4.0	Documents
4.1	General
4.2	All pages to be initialed
4.3	Rates to be in figures and words
4.4	Corrections and Erasures
4.5	Signature of Tenderer
4.6	Witness
4.7	Details of Experience
4.8	Liability of Government of India
5.0	Transfer of Tender Documents
6.0	Earnest Money
7.0	Validity
8.0	Addenda/Corrigenda
9.0	Right of Employer to Accept or Reject Tender
10.0	Time Schedule
11.0	Tenderer's Responsibility
12.0	Retired Government or Company Officers
13.0	Signing of the Contract
14.0	Field Management & Controlling/Coordinating Authority
15.0	Note to Schedule of Rates
16.0	16.1 Policy for Tenders under consideration 16.2 Zero Deviation
17.0	Award of Contract
18.0	Clarification of Tender Document
19.0	Local Conditions

Date of Issue: 9th March'23



**COMPOSITE SUPPLY CUM ERECTION OF
ELECTRICAL & INSTRUMENTATION WORKS FOR
OSBL FACILITIES ON ITEM RATE BASIS
AT
TALCHER FERTILIZERS LIMITED, ANGUL, ODISHA
GENERAL CONDITION OF CONTRACT**

PC-183/ E-8003/ S-IV

0

DOC. NO.

REV.



Page 3 of 68

20.0 Abnormal Rates

SECTION-IV (GENERAL OBLIGATIONS)

- 21.1 Priority of Contract Documents
21.2 Headings & Marginal Notes
21.3 Singular and Plural
21.4 Interpretation
22.0 Special Conditions of Contract
23.0 Contractor to obtain his own information
24.0 Contract Performance Security
25.0 Time of Performance
25.1 Time for Mobilization
25.2 Time Schedule of Construction
26.0 Force Majeure
26.1 Conditions for Force Majeure
26.2 Outbreak of War
27.0 Price Reduction Schedule
27.3 Bonus for Early Completion
28.0 Rights of Employer to forfeit Contract Performance Security
29.0 Failure by the Contractor to comply with the provisions of the contract
30.0 Contractor remains liable to pay compensation if action not taken under clause 29.0
31.0 Change in Constitution
32.0 -A Termination of Contract for Death
32.0-B Termination of Contract for Liquidation, Bankruptcy etc.
32.0-C Termination of Contract for Non-Performance and subsequently putting the Contractor on Holiday
33.0 Members of the Employer not individually liable
34.0 Employer not bound by personal representations
35.0 Contractor's office at site
36.0 Contractor's subordinate staff and their conduct
37.0 Sub letting of Works
i) Sub contracts for Temporary works etc.
ii) List of sub-contractors to be supplied
iii) Contractor's liability not limited by Sub-Contractors
iv) Employer may terminate sub contracts
v) No remedy for action taken under this clause
38.0 Power of Entry
39.0 Contractor's responsibility with Mechanical, Electrical, Intercommunication System, Air Conditioning Contractors and other agencies
40.0 Other Agencies at site
41.0 Notices
41.1 To the Contractor
41.2 To the Employer
42.0 Rights of various Interests
43.0 Patents and Royalties
44.0 Liens
45.0 Delays by Employer or his authorized agents
46.0 Payments if Contract is terminated
47.0 No waiver of Rights

Date of Issue: 9th March'23



**COMPOSITE SUPPLY CUM ERECTION OF
ELECTRICAL & INSTRUMENTATION WORKS FOR
OSBL FACILITIES ON ITEM RATE BASIS
AT
TALCHER FERTILIZERS LIMITED, ANGUL, ODISHA
GENERAL CONDITION OF CONTRACT**

PC-183/ E-8003/ S-IV

0

DOC. NO.

REV.



Page 4 of 68

48.0	Certificate not to affect Right of Employer and Liability of Contractor
49.0	Languages & Measures
50.0	Transfer of Title
51.0	Release of Information
52.0	Brand Names
53.0	Completion of Contract
54.0	Spares

SECTION-V (PERFORMANCE OF WORK)

55.0	Execution of Work
56.0	Co-ordination and Inspection of work
57.0	Work in Monsoon & Dewatering
58.0	Work on Sundays & Holidays
59.0	General Conditions for construction & Erection Work
60.0	Alterations in specification, Design & Extra Work
61.0	Drawings to be supplied by the Employer
62.0	Drawings to be supplied by the Contractor
63.0	Setting out works
64.0	Responsibility for Levels and Alignment
65.0	Materials to be supplied by contractor
66.0	Stores supplied by Employer
67.0	Conditions for issue of material
68.0	Materials Procured with assistance of Employer/Return of surplus
69.0	Materials obtained from dismantling
70.0	Articles of Value found
71.0	Discrepancies between instructions
72.0	Action where no specification is issued
73.0	Inspection of Works
74.0	Tests for Quality of Works
75.0	Samples for approval
76.0	Action and Compensation in case of bad work
77.0	Suspension of Work
78.0	Employer may do part of work
79.0	Possession prior to completion
80.0	Twelve months period of liability from the date of issue of completion certificate
80.3	Limitation of Liability
81.0	Care of Works
81.1	Defects prior to taking over
81.2	Defects after taking over
82.0	Guarantee/Transfer of Guarantee
83.0	Training of Employer's personnel
84.0	Replacement of Defective parts & materials
85.0	Indemnity
86.0	Construction Aids, Equipments, Tools & Tackles

SECTION-VI (CERTIFICATES AND PAYMENTS)

87.0	Schedule of Rates and Payments
	i) Contractor's Remuneration
	ii) Schedule of Rates to be inclusive
	iii) Schedule of Rates to cover construction equipment, materials, labour etc.

Date of Issue: 9th March'23



**COMPOSITE SUPPLY CUM ERECTION OF
ELECTRICAL & INSTRUMENTATION WORKS FOR
OSBL FACILITIES ON ITEM RATE BASIS
AT
TALCHER FERTILIZERS LIMITED, ANGUL, ODISHA
GENERAL CONDITION OF CONTRACT**

PC-183/ E-8003/ S-IV

0

DOC. NO.

REV.



Page 5 of 68

	iv)	Schedule of Rates to cover Royalties, Rents and claims.
	v)	Schedule of Rates to cover taxes & duties
	vi)	Schedule of Rates to cover risks of delay
	vii)	Schedule of Rates cannot be altered
88.0		Procedure for Measurement and billing of works in progress
88.1		Billing Procedure
88.2		Secured Advance on materials
88.3		Dispute in mode of measurement
88.4		Rounding of Amounts
89.0		Lumpsum in Tender
90.0		Running Account Payments to be regarded as advances
91.0		Notices of Claims for Additional Payments
92.0		Payment of Contractor's bills
93.0		Receipt for Payment
94.0		Completion Certificate
94.1		Application for Completion Certificate
94.2		Completion Certificate
94.3		Completion Certificate Documents
95.0		Final Decision & Final Certificate
96.0		Certificate and Payments No evidence of completion
97.0		Deduction from Contract Price

SECTION-VII (TAXES AND INSURANCE)

98.0		Taxes, Duties, Octroi etc.
99.0		Sales Tax/Turnover Tax
100.0		Statutory Variations
101.0		Insurance
101.1		General
	i)	Employees State Insurance Act
	ii)	Workmen Compensation and Employee's Liability Insurance
	iii)	Accident or injury to workmen
	iv)	Transit Insurance
	v)	Automobile
	vi)	General Liability
	vii)	Any other Insurance required under law or regulations by Employer
102.0		Damage to Property or to any Person or any Third Party

SECTION-VIII (LABOUR LAWS)

103.0		Labour laws
104.0		Implementation of Apprentices Act 1961
105.0		Contractor to indemnify the Employer
106.0		Health and Sanitary Arrangement for worker

SECTION-IX (APPLICABLE LAWS AND SETTLEMENT OF DISPUTES)

107.0		Arbitration
108.0		Jurisdiction

SECTION-X (SAFETY CODES)



**COMPOSITE SUPPLY CUM ERECTION OF
ELECTRICAL & INSTRUMENTATION WORKS FOR
OSBL FACILITIES ON ITEM RATE BASIS
AT
TALCHER FERTILIZERS LIMITED, ANGUL, ODISHA
GENERAL CONDITION OF CONTRACT**

PC-183/ E-8003/ S-IV

0



DOC. NO.

REV.



Page 6 of 68

109.0	General
110.0	Safety Regulations
111.0	First Aid and Industrial Injuries
112.0	General Rules
113.0	Contractor's barricades
114.0	Scaffolding
115.0	Excavation and Trenching
116.0	Demolition/General Safety
117.0	Care in Handling Inflammable Gas
118.0	Temporary Combustible Structures
119.0	Precautions Against Fire
120.0	Explosives
121.0	Mines Act
122.0	Preservation of Places
123.0	Outbreak of Infectious diseases
124.0	Use of intoxicants

	COMPOSITE SUPPLY CUM ERECTION OF ELECTRICAL & INSTRUMENTATION WORKS FOR OSBL FACILITIES ON ITEM RATE BASIS AT TALCHER FERTILIZERS LIMITED, ANGUL, ODISHA GENERAL CONDITION OF CONTRACT	PC-183/ E-8003/ S-IV	0	
		DOC. NO.	REV.	
		Page 7 of 68		

General Conditions of Contract

Section- I. Definitions

1. Definition of Terms:

- 1.1 In this CONTRACT (as here-in-after defined) the following words and expressions shall have the meanings hereby assigned to them except where the context otherwise required.
- 1.1.1 The OWNER/EMPLOYER/COMPANY/TFL means Talcher Fertilizers Ltd. (a joint venture of four major Public Sector Units – M/s GAIL (India) Limited, M/s Rastriya Chemicals & Fertilizers Ltd., M/s Coal India Ltd. and M/s Fertilizers Corporation of India Ltd.) and having its Registered office at Plot 2/H, Kalpana Area, BJB Nagar, Khurda, Bhubaneswar-751 014 and includes its successors and assigns.
- 1.1.2 The "CONTRACTOR" means the person or the persons, firm or Company or corporation whose tender has been accepted by the EMPLOYER and includes the CONTRACTOR's legal Representatives his successors and permitted assigns.
- 1.1.3 The "ENGINEER/ENGINEER-IN-CHARGE" shall mean the person designated from time to time by the TFL and shall include those who are expressly authorized by him to act for and on his behalf for operation of this CONTRACT.
- 1.1.4 The "WORK" shall mean and include all items and things to be supplied/ done and services and activities to be performed by the CONTRACTOR in pursuant to and in accordance with CONTRACT or part thereof as the case may be and shall include all extra, additional, altered or substituted works as required for purpose of the CONTRACT.
- 1.1.5 The "PERMANENT WORK" means and includes works which will be incorporated in and form a part of the work to be handed over to the EMPLOYER by the CONTRACTOR on completion of the CONTRACT.
- 1.1.6 "CONSTRUCTION EQUIPMENT" means all appliances/equipment and things whatsoever nature for the use in or for the execution, completion, operation, or maintenance of the work or temporary works (as hereinafter defined) but does not include materials or other things intended to form or to be incorporated into the WORK, or camping facilities.
- 1.1.7 "CONTRACT DOCUMENTS" means collectively the Tender Documents, Designs, Drawings, Specification, Schedule of Quantities and Rates, Letter of Acceptance and agreed variations if any, and such other documents constituting the tender and acceptance thereof.
- 1.1.8 CONSULTANT: means Projects & Development India Ltd. (PDIL) who are the consulting engineer to the Employer for this project and having registered office at PDIL Bhawan, A-14, Sector 1, Noida - 201301 (U.P.)
- 1.1.9 The "SUB-CONTRACTOR" means any person or firm or Company (other than the CONTRACTOR) to whom any part of the work has been entrusted by the CONTRACTOR, with the written consent of the ENGINEER-IN-CHARGE, and the legal representatives, successors and permitted assigns of such person, firm or company.

Date of Issue: 9th March'23



**COMPOSITE SUPPLY CUM ERECTION OF
ELECTRICAL & INSTRUMENTATION WORKS FOR
OSBL FACILITIES ON ITEM RATE BASIS
AT
TALCHER FERTILIZERS LIMITED, ANGUL, ODISHA
GENERAL CONDITION OF CONTRACT**

PC-183/ E-8003/ S-IV

0

DOC. NO.

REV.



Page 8 of 68

- 1.1.10 The "CONTRACT" shall mean the Agreement between the EMPLOYER and the CONTRACTOR for the execution of the works including therein all contract documents.
- 1.1.11 The "SPECIFICATION" shall mean all directions the various technical specifications, provisions attached and referred to the Tender Documents which pertain to the method and manner of performing the work or works to the quantities and qualities of the work or works and the materials to be furnished under the CONTRACT for the work or works, as may be amplified or modified by the TFL or ENGINEER-IN-CHARGE during the performance of CONTRACT in order to provide the unforeseen conditions or in the best interests of the work or works. It shall also include the latest edition of relevant Standard Specifications including all addenda/corrigenda published before entering into CONTRACT.
- 1.1.12 The "DRAWINGS" shall include maps, plans and tracings or prints or sketches thereof with any modifications approved in writing by the ENGINEER-IN-CHARGE and such other drawing as may, from time to time, be furnished or approved in writing by the ENGINEER-IN-CHARGE.
- 1.1.13 The "TENDER" means the proposal along with supporting documents submitted by the CONTRACTOR for consideration by the EMPLOYER.
- 1.1.14 The "CHANGE ORDER" means an order given in writing by the ENGINEER-IN-CHARGE to effect additions to or deletion from and alteration in the works.
- 1.1.15 The "COMPLETION CERTIFICATE" shall mean the certificate to be issued by the ENGINEER-IN-CHARGE when the works have been completed entirely in accordance with CONTRACT DOCUMENT to his satisfaction.
- 1.1.16 The "FINAL CERTIFICATE" in relation to a work means the certificate regarding the satisfactory compliance of various provision of the CONTRACT by the CONTRACTOR issued by the ENGINEER-IN-CHARGE/EMPLOYER after the period of liability is over.
- 1.1.17 "DEFECT LIABILITY PERIOD" in relation to a work means the specified period from the date of COMPLETION CERTIFICATE upto the date of issue of FINAL CERTIFICATE during which the CONTRACTOR stands responsible for rectifying all defects that may appear in the works executed by the CONTRACTOR in pursuance of the CONTRACT and includes warranties against Manufacturing/Fabrication/ Erection/Construction defects covering all materials plants, equipment, components, and the like supplied by the CONTRACTOR, works executed against workmanship defects.
- 1.1.18 The "APPOINTING AUTHORITY" for the purpose of arbitration shall be the CHAIRMAN and MANAGING DIRECTOR or any other person so designated by the EMPLOYER.
- 1.1.19 "TEMPORARY WORKS" shall mean all temporary works of every kind required in or about the execution, completion or maintenance of works.
- 1.1.20 "PLANS" shall mean all maps, sketches and layouts as are incorporated in the CONTRACT in order to define broadly the scope and specifications of the work or works, and all reproductions thereof.
- 1.1.21 "SITE" shall mean the lands and other places on, under, in or through which the permanent works are to be carried out and any other lands or places provided by

Date of Issue: 9th March'23



**COMPOSITE SUPPLY CUM ERECTION OF
ELECTRICAL & INSTRUMENTATION WORKS FOR
OSBL FACILITIES ON ITEM RATE BASIS
AT
TALCHER FERTILIZERS LIMITED, ANGUL, ODISHA
GENERAL CONDITION OF CONTRACT**

PC-183/ E-8003/ S-IV

0

DOC. NO.

REV.



Page 9 of 68

the EMPLOYER for the purpose of the CONTRACT.

- 1.1.22 "NOTICE IN WRITING OR WRITTEN NOTICE" shall mean a notice in written, typed or printed characters sent (unless delivered personally or otherwise proved to have been received by the addressee) by registered post to the latest known private or business address or registered office of the addressee and shall be deemed to have been received in the ordinary course of post it would have been delivered.
- 1.1.23 "APPROVED" shall mean approved in writing including subsequent written confirmation of previous verbal approval and "APPROVAL" means approval in writing including as aforesaid.
- 1.1.24 "LETTER OF INTENT/FAX OF INTENT" shall mean intimation by a Fax/Letter to Tenderer(s) that the tender has been accepted in accordance with the provisions contained in the letter.
- 1.1.25 "DAY" means a day of 24 hours from midnight to midnight irrespective of the number of hours worked in that day.
- 1.1.26 "WORKING DAY" means any day which is not declared to be holiday or rest day by the EMPLOYER.
- 1.1.27 "WEEK" means a period of any consecutive seven days.
- 1.1.28 "METRIC SYSTEM" - All technical documents regarding the construction of works are given in the metric system and all work in the project should be carried out according to the metric system. All documents concerning the work shall also be maintained in the metric system.
- 1.1.29 "VALUE OF CONTRACT" or "TOTAL CONTRACT PRICE" shall mean the sum accepted or the sum calculated in accordance with the prices accepted in tender and/or the CONTRACT rates as payable to the CONTRACTOR for the entire execution and full completion of the work, including change order.
- 1.1.30 "LANGUAGE FOR DRAWINGS AND INSTRUCTION" All the drawings, titles, notes, instruction, dimensions, etc. shall be in English Language.
- 1.1.31 "MOBILIZATION" shall mean establishment of sufficiently adequate infrastructure by the CONTRACTOR at "SITE" comprising of construction equipments, aids, tools tackles including setting of site offices with facilities such as power, water, communication etc. establishing manpower organization comprising of Resident Engineers, Supervising personnel and an adequate strength of skilled, semi-skilled and un-skilled workers, who with the so established infrastructure shall be in a position to commence execution of work at site(s), in accordance with the agreed Time Schedule of Completion of Work. "MOBILISATION" shall be considered to have been achieved, if the CONTRACTOR is able to establish infrastructure as per Time Schedule, where so warranted in accordance with agreed schedule of work implementation to the satisfaction of ENGINEER-IN-CHARGE/ EMPLOYER.
- 1.1.32 "COMMISSIONING" shall mean pressing into service of the system including the plant(s), equipment(s), vessel(s), pipeline, machinery(ies), or any other section or sub-section of installation(s) pertaining to the work of the CONTRACTOR after successful testing and trial runs of the same.
- "COMMISSIONING" can be either for a completed system or a part of system of a combination of systems or sub-systems and can be performed in any sequence as desired by EMPLOYER and in a manner established to be made

Date of Issue: 9th March'23



**COMPOSITE SUPPLY CUM ERECTION OF
ELECTRICAL & INSTRUMENTATION WORKS FOR
OSBL FACILITIES ON ITEM RATE BASIS
AT
TALCHER FERTILIZERS LIMITED, ANGUL, ODISHA
GENERAL CONDITION OF CONTRACT**

PC-183/ E-8003/ S-IV

0

DOC. NO.

REV.



Page 10 of 68

suiting according to availability of pre-requisites. Any such readjustments made by EMPLOYER in performance of "COMMISSIONING" activity will not be construed to be violating CONTRACT provisions and CONTRACTOR shall be deemed to have provided for the same.

Section-II General Information

2. General Information

2.1 a) Location of Site: The proposed location of Project site is defined in the Special Conditions of Contract.

b) Access by Road: CONTRACTOR, if necessary, shall build other temporary access roads to the actual site of construction for his own work at his own cost. The CONTRACTOR shall be required to permit the use of the roads so constructed by him for vehicles of any other parties who may be engaged on the project site. The CONTRACTOR shall also facilitate the construction of the permanent roads should the construction there of start while he is engaged on this work. He shall make allowance in his tender for any inconvenience he anticipates on such account.

Non-availability of access roads, railway siding and railway wagons for the use of the CONTRACTOR shall in no case condone any delay in the execution of WORK nor be the cause for any claim for compensation against the EMPLOYER.

2.2 Scope of Work: The scope of WORK is defined in the Technical Part of the tender document. The CONTRACTOR shall provide all necessary materials, equipment, labour etc. for the execution and maintenance of the WORK till completion unless otherwise mentioned in the Tender Document.

2.3 Water Supply: Contractor will have to make his own arrangements for supply of water to his labour camps and for works. All pumping installations, pipe network and distribution system will have to be carried out by the Contractor at his own risk and cost.

Alternatively the Employer at his discretion may endeavour to provide water to the Contractor at the Employer's source of supply provided the Contractor makes his own arrangement for the water meter which shall be in custody of the Employer and other pipe net works from source of supply and such distribution pipe network shall have prior approval of the Engineer-in-Charge so as not to interfere with the layout and progress of the other construction works. In such case, the rate for water shall be deducted from the running account bills.

However, the Employer does not guarantee the supply of water and this does not relieve the Contractor of his responsibility in making his own arrangement and for the timely completion of the various works as stipulated.

2.4 Power Supply:

2.4.1 Subject to availability, EMPLOYER will supply power at 400/440 V at only one point at the nearest sub-station, from where the CONTRACTOR will make his own arrangement for temporary distribution. The point of supply will not be more than 500 m away from the CONTRACTOR'S premises. All the works will be done as per the applicable regulations and passed by the ENGINEER-IN-CHARGE. The temporary line will be removed forthwith after the completion of work or if there is any hindrance caused to the other works due

Date of Issue: 9th March'23



**COMPOSITE SUPPLY CUM ERECTION OF
ELECTRICAL & INSTRUMENTATION WORKS FOR
OSBL FACILITIES ON ITEM RATE BASIS
AT
TALCHER FERTILIZERS LIMITED, ANGUL, ODISHA
GENERAL CONDITION OF CONTRACT**

PC-183/ E-8003/ S-IV

0

DOC. NO.

REV.



Page 11 of 68

to the alignment of these lines, the CONTRACTOR will re-route or remove the temporary lines at his own cost. The CONTRACTOR at his cost will also provide suitable electric meters, fuses, switches, etc. for purposes of payment to the EMPLOYER which should be in the custody and control of the EMPLOYER. The cost of power supply shall be payable to the EMPLOYER every month for Construction Works power which would be deducted from the running account bills. The EMPLOYER shall not, however, guarantee the supply of electricity nor have any liability in respect thereof. No claim for compensation for any failure or short supply of electricity will be admissible.

- 2.4.2 It shall be the responsibility of the CONTRACTOR to provide and maintain the complete installation on the load side of the supply with due regard to safety requirement at site. All cabling, equipment, installations etc. shall comply in all respects with the latest statutory requirements and safety provisions i.e., as per the Central/State Electricity Acts and Rules etc. The CONTRACTOR will ensure that his equipment and Electrical Wiring etc., are installed, modified, maintained by a licensed Electrician/Supervisor. A test certificate is to be produced to the ENGINEER-IN-CHARGE for his approval, before power is made available.
- 2.4.3 At all times, IEA regulations shall be followed failing which the EMPLOYER has a right to disconnect the power supply without any reference to the CONTRACTOR. No claim shall be entertained for such disconnection by the ENGINEER-IN-CHARGE. Power supply will be reconnected only after production of fresh certificate from authorized electrical supervisors.
- 2.4.4 The EMPLOYER is not liable for any loss or damage to the CONTRACTOR's equipment as a result of variation in voltage or frequency or interruption in power supply or other loss to the CONTRACTOR arising therefrom.
- 2.4.5 The CONTRACTOR shall ensure that the Electrical equipment installed by him are such that average power factors does not fall below 0.90 at his premises. In case power factor falls below 0.90 in any month, he will reimburse to the EMPLOYER at the penal rate determined by the EMPLOYER for all units consumed during the month.
- 2.4.6 The power supply required for CONTRACTOR's colony near the plant site will be determined by the EMPLOYER and shall be as per State Electricity Board's Rules and other statutory provisions applicable for such installations from time to time. In case of power supply to CONTRACTOR's colony, the power will be made available at a single point and the CONTRACTOR shall make his own arrangement at his own cost for distribution to the occupants of the colony as per Electricity Rules and Acts. The site and colony shall be sufficiently illuminated to avoid accidents.
- 2.4.7 The CONTRACTOR will have to provide and install his own lights and power meters which will be governed as per Central/State Government Electricity Rules. The meters shall be sealed by the EMPLOYER.
- 2.4.8 In case of damage of any of the EMPLOYER's equipment on account of fault, intentional or unintentional on the part of the CONTRACTOR, the EMPLOYER reserves the right to recover the cost of such damage from the CONTRACTOR's bill. Cost of HRC Fuses replaced at the EMPLOYER's terminals due to any fault in the CONTRACTOR's installation shall be to CONTRACTOR's account at the rates decided by the ENGINEER-IN-CHARGE.
- 2.4.9 Only motors upto 3 HP will be allowed to be started direct on line. For motors above 3 HP and upto 100 HP a suitable Starting device approved by the ENGINEER- IN-CHARGE shall be provided by the CONTRACTOR. For motors

Date of Issue: 9th March'23



**COMPOSITE SUPPLY CUM ERECTION OF
ELECTRICAL & INSTRUMENTATION WORKS FOR
OSBL FACILITIES ON ITEM RATE BASIS
AT
TALCHER FERTILIZERS LIMITED, ANGUL, ODISHA
GENERAL CONDITION OF CONTRACT**

PC-183/ E-8003/ S-IV

0

DOC. NO.

REV.



Page 12 of 68

above 100 HP slipping induction motors with suitable starting devices as approved by the ENGINEER- IN-CHARGE shall be provided by the CONTRACTOR.

2.4.10 The CONTRACTOR shall ensure at his cost that all electrical lines and equipment and all installations are approved by the State Electricity Inspector before power can be supplied to the EMPLOYER.

2.4.11 The total requirement of power shall be indicated by the tenderer alongwith his tender.

2.5 Land for Contractor's Field Office, Godown and Workshop: The EMPLOYER will, at his own discretion and convenience and for the duration of the execution of the work make available near the site, land for construction of CONTRACTOR's Temporary Field Office, godowns workshops and assembly yard required for the execution of the CONTRACT. The CONTRACTOR shall at his own cost construct all these temporary buildings and provide suitable water supply and sanitary arrangement and get the same approved by the ENGINEER-IN-CHARGE.

On completion of the works undertaken by the CONTRACTOR, he shall remove all temporary works erected by him and have the SITE cleaned as directed by ENGINEER-IN-CHARGE. If the CONTRACTOR shall fail to comply with these requirements, the ENGINEER-IN-CHARGE may at he expenses of the CONTRACTOR remove such surplus, and rubbish materials and dispose off the same as he deems fit and get the site cleared as aforesaid; and CONTRACTOR shall forthwith pay the amount of all expenses so incurred and shall have no claim in respect of any such surplus materials disposed off as aforesaid. But the EMPLOYER reserves the right to ask the CONTRACTOR any time during the pendency of the CONTRACT to vacate the land by giving 7 days notice on security reasons or on national interest or otherwise. Rent may be charged for the land so occupied from contractor by the Employer.

The CONTRACTOR shall put up temporary structures as required by them for their office, fabrication shop and construction stores only in the area allocated to them on the project site by the EMPLOYER or his authorized representative. No tea stalls/canteens should be put up or allowed to be put up by any CONTRACTOR in the allotted land or complex area without written permission of the EMPLOYER.

No unauthorized buildings, constructions or structures should be put up by the CONTRACTOR anywhere on the project site.

For uninterrupted fabrication work, the CONTRACTOR shall put up temporary covered structures at his cost within Area in the location allocated to them in the project site by the EMPLOYER or his authorized representative.

No person except for authorized watchman shall be allowed to stay in the plant area/CONTRACTOR's area after completion of the day's job without prior written permission from ENGINEER-IN-CHARGE.

2.6 Land for Residential Accommodation:-No Land shall be made available for residential accommodation for staff and labour of CONTRACTOR.

Section-III. General Instructions to Tenderers

3. Submission of Tender:

3.1 TENDER must be submitted without making any additions, alterations, and as per details given in other clauses hereunder. The requisite details shall be filled in by the TENDERER at space provided under "Submission of Tender" at the beginning of GCC of Tender Document. The rate shall be filled only in the schedule given in this Tender Document.

Date of Issue: 9th March'23



**COMPOSITE SUPPLY CUM ERECTION OF
ELECTRICAL & INSTRUMENTATION WORKS FOR
OSBL FACILITIES ON ITEM RATE BASIS
AT
TALCHER FERTILIZERS LIMITED, ANGUL, ODISHA
GENERAL CONDITION OF CONTRACT**

PC-183/ E-8003/ S-IV

0

DOC. NO.

REV.



Page 13 of 68

- 3.2 Addenda/ Corrigenda to this Tender Document, if issued, must be signed, submitted along with the Tender Document. the tenderer should write clearly the revised quantities in Schedule of Rates of Tender Document and should price the WORK based on revised quantities when amendments of quantities are issued in addenda.
- 3.3 Covering letter along with its enclosures accompanying the Tender Document and all further correspondence shall be submitted in duplicate.
- 3.4 Tenderers are advised to submit quotations based strictly on the terms and conditions and specifications contained in the Tender Documents and not to stipulate any deviations.
- 3.5 ~~Tenders should always be placed in double sealed covers, super scribing ["QUOTATION DO NOT OPEN" Tender for _____ Project of Talcher Fertilizers Ltd. due for opening on _____]. The Full Name, Address and Telegraphic Address, Fax No. of the Tenderers shall be written on the bottom left hand corner of the sealed cover.~~

4. Documents:

4.1 General:

The tenders as submitted, will consist of the following:

- i) Complete set of Tender Documents (Original) as sold duly filled in and signed by the tenderer as prescribed in different clauses of the Tender Documents.
- ii) Earnest money in the manner specified in Clause 6 hereof.
- iii) Power of Attorney or a true copy thereof duly attested by a Gazetted Officer in case an authorized representative has signed the tender, as required by Clause 14 hereof.
- iv) Information regarding tenderers in the proforma enclosed.
- v) Details of work of similar type and magnitude carried out by the Tenderer in the proforma provided in the tender document.
- vi) Organization chart giving details of field management at site, the tenderer proposes to have for this job.
- vii) Details of construction plant and equipments available with the tenderer for using in this work.
- viii) Solvency Certificate from Scheduled Bank to prove the financial ability to carry out the work tendered for.
- ix) Latest Balance Sheet and Profit & Loss Account duly audited.
- x) Details of present commitment as per proforma enclosed to tender.
- xi) Data required regarding SUB-CONTRACTOR(s)/ Supplier/ Manufacturers and other technical information the tenderer wish to furnish.
- xii) Provident fund registration certificate
- xiii) List showing all enclosures to tender.

4.2 All pages are to be Initiated: All signatures in Tender Documents shall be dated, as well

Date of Issue: 9th March'23



**COMPOSITE SUPPLY CUM ERECTION OF
ELECTRICAL & INSTRUMENTATION WORKS FOR
OSBL FACILITIES ON ITEM RATE BASIS
AT
TALCHER FERTILIZERS LIMITED, ANGUL, ODISHA
GENERAL CONDITION OF CONTRACT**

PC-183/ E-8003/ S-IV

0

DOC. NO.

REV.



Page 14 of 68

as, all the pages of all sections of Tender Documents shall be initialed at the lower right hand corner and signed wherever required in the tender papers by the TENDERER or by a person holding power of attorney authorizing him to sign on behalf of the tenderer before submission of tender.

- 4.3 Rates to be in Figures and Words: The tender should quote in English both in figures as well as in words the rates and amounts tendered by him in the Schedule of Rates of Tender submitted by the CONTRACTOR for each item and in such a way that interpolation is not possible. The amount for each item should be worked out and entered and requisite total given of all items, both in figures and in words. The tendered amount for the work shall be entered in the tender and duly signed by the Tenderer.

If some discrepancies are found between the RATES in FIGURES and WORDS or the AMOUNT shown in the tender, the following procedure shall be followed:

- When there is difference between the rates in figures and words, the rate which corresponds to the amount worked out by the tenderer shall be taken as correct.
- When the rate quoted by the tenderer in figures and words tally but the amount is incorrect the rate quoted by the tenderer shall be taken as correct.
- When it is not possible to ascertain the correct rate by either of above methods, the rate quoted in words shall be taken as correct.

- 4.4 Corrections and Erasures: All correction(s) and alteration(s) in the entries of tender paper shall be signed in full by the TENDERER with date. No erasure or over writing is permissible.

4.5 Signature of Tenderer:

- 4.5.1 The TENDERER shall contain the name, residence and place of business of person or persons making the tender and shall be signed by the TENDERER with his usual signature. Partnership firms shall furnish the full names of all partners in the tender. It should be signed in the partnership's name by all the partners or by duly authorized representatives followed by the name and designation of the person signing. Tender by a corporation shall be signed by an authorized representative, and a Power of Attorney in that behalf shall accompany the tender. A copy of the constitution of the firm with names of all partners shall be furnished.

- 4.5.2 When a tenderer signs a tender in a language other than English, the total amount tendered should, in addition, be written in the same language. The signature should be attested by at least one witness.

- 4.6 Witness: Witness and sureties shall be persons of status and property and their names, occupation and address shall be stated below their signature.

- 4.7 Details of Experience: The tenderer should furnish, along with his tender, details of previous experience in having successfully completed in the recent past works of this nature, together with the names of Employers, location of sites and value of contract, date of commencement and completion of work, delays if any, reasons of delay and other details along with documentary evidence(s).

- 4.8 Liability of Government of India: It is expressly understood and agreed by and between Bidder or/Contractor and M/s Talcher Fertilizers Ltd., and that M/s Talcher Fertilizers Ltd., is entering into this agreement solely on its own behalf and not on behalf of any other person or entity. In particular, it is expressly understood and agreed that the Government of India is not a party to this agreement and has no liabilities, obligations or rights hereunder. It is expressly understood and agreed that M/s Talcher Fertilizers Ltd. is an independent legal entity with power and authority

Date of Issue: 9th March'23



**COMPOSITE SUPPLY CUM ERECTION OF
ELECTRICAL & INSTRUMENTATION WORKS FOR
OSBL FACILITIES ON ITEM RATE BASIS
AT
TALCHER FERTILIZERS LIMITED, ANGUL, ODISHA
GENERAL CONDITION OF CONTRACT**

PC-183/ E-8003/ S-IV

0

DOC. NO.

REV.



Page 15 of 68

to enter into contracts solely on its own behalf under the applicable Laws of India and general principles of Contract Law. The Bidder/Contractor expressly agrees, acknowledges and understands that M/s Talcher Fertilizers Ltd. is not an agent, representative or delegate of the Government of India. It is further understood and agreed that the Government of India is not and shall not be liable for any acts, omissions, commissions, breaches or other wrongs arising out of the contract. Accordingly, Bidder/Contractor hereby expressly waives, releases and foregoes any and all actions or claims, including cross claims, impleader claims or counter claims against the Government of India arising out of this contract and covenants not to sue to Government of India as to any manner, claim, cause of action or thing whatsoever arising of or under this agreement.

5. Transfer of Tender Documents:

5.1 Transfer of Tender Documents purchased by one intending tenderer to another is not permissible.

6. Earnest Money:

6.1 The bidder must pay Earnest Money as given in the letter /notice inviting tenders and attach the official receipt with the tender failing which the tender is liable to be rejected and representatives of such tenderers will not be allowed to attend the tender opening. Earnest Money can be paid in Demand Drafts or Bank Guarantee or Banker's Cheque or Letter of Credit from any Indian scheduled bank or a branch of an International bank situated in India and registered with Reserve Bank of India as scheduled foreign bank. However, other than the Nationalized Indian Banks, the banks whose BGs are furnished, must be commercial banks having net worth in excess of Rs. 100 crores and a declaration to this effect should be made by such commercial bank either in the bank guarantee itself or separately on a letter head.

The bid guarantee shall be submitted in the prescribed format.

Note: The Bank Guarantee so furnished by the tenderer shall be in the proforma prescribed by the EMPLOYER. No interest shall be paid by the EMPLOYER on the Earnest Money deposited by the tenderer. The Bank Guarantee furnished in lieu of Earnest Money shall be kept valid for a period of "SIX MONTHS" from the date of opening of tender.(TWO MONTHS beyond the bid due date).

The Earnest Money deposited by successful tenderer shall be forfeited if the Contractor fails to furnish the requisite Contract Performance Security as per clause 24 hereof and /or fails to start work within a period of 15 days or fails to execute the AGREEMENT within 15 days of the receipt by him of the Notification of Acceptance of Tender.

Note: The Earnest Money of the unsuccessful bidder will be returned by EMPLOYER/CONSULTANT, directly to the tenderer(s), within a reasonable period of time but not later than 30 days after the expiration of the period of bid validity prescribed by EMPLOYER.

7 Validity:

7.1 Tender submitted by tenderers shall remain valid for acceptance for a period of "4 MONTHS" from the date of opening of the tender. The tenderers shall not be entitled during the said period of 4 months, without the consent in writing of the EMPLOYER, to revoke or cancel his tender or to vary the tender given or any term thereof. In case of tender revoking or canceling his tender or varying any term in regard thereof without the consent of EMPLOYER in writing, the EMPLOYER shall forfeit Earnest Money paid by him alongwith tender.

8 Addenda/Corrigenda

8.1 Addenda/ Corrigenda to the Tender Documents will be issued in duplicate prior to the date of opening of the tenders to clarify documents or to reflect modification in

Date of Issue: 9th March'23



**COMPOSITE SUPPLY CUM ERECTION OF
ELECTRICAL & INSTRUMENTATION WORKS FOR
OSBL FACILITIES ON ITEM RATE BASIS
AT
TALCHER FERTILIZERS LIMITED, ANGUL, ODISHA
GENERAL CONDITION OF CONTRACT**

PC-183/ E-8003/ S-IV

0

DOC. NO.

REV.



Page 16 of 68

design or CONTRACT terms.

8.2 Each addenda/ corrigendum issued will be issued in duplicate to each person or organization to whom set of Tender Documents has been issued. Recipient will retain tenderer's copy of each Addendum/ Corrigendum and attach original copy duly signed along with his offer. All Addenda/ Corrigenda issued shall become part of Tender Documents.

9 Right of Employer to Accept or Reject Tender:

9.1 The right to accept the tender will rest with the EMPLOYER. The EMPLOYER, however, does not bind himself to accept the lowest tender, and reserves to itself the authority to reject any or all the tenders received without assigning any reason whatsoever. At the option of the Employer, the work for which the tender had been invited, may be awarded to one Contractor or split between more than one bidders, in which case the award will be made for only that part of the work, in respect of which the bid has been accepted. The quoted rates should hold good for such eventualities.

Tenders in which any of the particulars and prescribed information are missing or are incomplete in any respect and/or the prescribed conditions are not fulfilled are liable to be rejected. The Tender containing uncalled for remarks or any additional conditions are liable to be rejected.

Canvassing in connection with tenders is strictly prohibited and tenders submitted by the Tenderers who resort to canvassing will be liable to rejection.

10 Time Schedule

10.1 The WORK shall be executed strictly as per the TIME SCHEDULE specified in TENDER/ CONTRACT Document. The period of construction given in Time Schedule includes the time required for mobilization as well as testing, rectifications if any, retesting and completion in all respects to the entire satisfaction of the ENGINEER-IN- CHARGE.

10.2 A joint program of execution of the WORK will be prepared by the ENGINEER-IN-CHARGE and CONTRACTOR based on priority requirement of this project. This program will take into account the time of completion mentioned in 10.1 above and the time allowed for the priority works by the ENGINEER-IN-CHARGE.

10.3 Monthly/ Weekly construction program will; be drawn up by the ENGINEER-IN-CHARGE jointly with the CONTRACTOR, based on availability of work fronts and the joint construction program as per 10.2 above. The CONTRACTOR shall scrupulously adhere to these targets/ programs by deploying adequate personnel, construction tools and tackles and he shall also supply himself all materials of his scope of supply in good time to achieve the targets/program. In all matters concerning the extent of targets set out in the weekly and monthly programs and the degree of achievements the decision of the ENGINEER-IN-CHARGE will be final and binding on the CONTRACTOR.

11 Tenderer's Responsibility

11.1 The intending tenderers shall be deemed to have visited the SITE and familiarized submitting the tender. Non-familiarity with the site conditions will not be considered a reason either for extra claims or for not carrying out the works in strict conformity with the DRAWINGS and SPECIFICATIONS or for any delay in performance.

12 Retired Government or Company Officers

12.1 No Engineer of Gazetted rank or other Gazetted Officer employed in Engineering or Administrative duties in an Engineering Department of the States/ Central Government or of the EMPLOYER is allowed to work as a CONTRACTOR for a period of two years after his retirement from Government Service, or from the

Date of Issue: 9th March'23



**COMPOSITE SUPPLY CUM ERECTION OF
ELECTRICAL & INSTRUMENTATION WORKS FOR
OSBL FACILITIES ON ITEM RATE BASIS
AT
TALCHER FERTILIZERS LIMITED, ANGUL, ODISHA
GENERAL CONDITION OF CONTRACT**

PC-183/ E-8003/ S-IV

0

DOC. NO.

REV.



Page 17 of 68

employment of the EMPLOYER without the previous permission of the EMPLOYER. The CONTRACT, if awarded, is liable to be cancelled if either the CONTRACTOR or any of his employees is found at any time to be such a person, who has not obtained the permission of the State/ Central Government or of the EMPLOYER as aforesaid before submission of tender, or engagement in the CONTRACTOR'S service as the case may be.

- 13 Signing of the Contract:**
- 13.1 The successful tenderer shall be required to execute an AGREEMENT in the proforma attached with TENDER DOCUMENT within 15 days of the receipt by him of the Notification of Acceptance of Tender. In the event of failure on the part of the successful tenderer to sign the AGREEMENT within the above stipulated period, the Earnest Money or his initial deposit will be forfeited and the acceptance of the tender shall be considered as cancelled.
- 14 Field Management & Controlling/Coordinating Authority:**
- 14.1 The field management will be the responsibility of the ENGINEER-IN-CHARGE, who will be nominated by the EMPLOYER. The ENGINEER-IN-CHARGE may also authorize his representatives to assist in performing his duties and functions.
- 14.2 The ENGINEER-IN-CHARGE shall coordinate the works of various agencies engaged at site to ensure minimum disruption of work carried out by different agencies. It shall be the responsibility of the CONTRACTOR to plan and execute the work strictly in accordance with site instructions to avoid hindrance to the work being executed by other agencies.
- 15 Note to Schedule of Rates:**
- 15.1 The Schedule of Rates should be read in conjunction with all the other sections of the tender.
- 15.2 The tenderer shall be deemed to have studied the DRAWINGS, SPECIFICATIONS and details of work to be done within TIME SCHEDULE and to have acquainted himself of the condition prevailing at site.
- 15.3 Rates must be filled in the Schedule of Rates of original Tender Documents. If quoted in separate typed sheets no variation in item description or specification shall be accepted. Any exceptions taken by the tenderer to the Schedule of Rates shall be brought out in the terms and conditions of the offer.
- 15.4 The quantities shown against the various items are only approximate. Any increase or decrease in the quantities shall not form the basis of alteration of the rates quoted and accepted.
- 15.5 The EMPLOYER reserves the right to interpolate the rates for such items of work falling between similar items of lower and higher magnitude.
- 16 Policy for Tenders Under Consideration:**
- 16.1 Only Those Tenders which are complete in all respects and are strictly in accordance with the Terms and Conditions and Technical Specifications of Tender Document, shall be considered for evaluation. Such Tenders shall be deemed to be under consideration immediately after opening of Tender and until such time an official intimation of acceptance/ rejection of Tender is made by TFL to the Bidder.
- 16.2 Zero Deviation: Bidders to note that this is a ZERO DEVIATION TENDER. TFL will appreciate submission of offer based on the terms and conditions in the enclosed General Conditions of Contract (GCC), Special Conditions of Contract (SCC), Instructions to Bidders (ITB), Scope of Work, technical specifications etc. to avoid wastage of time and money in seeking clarifications on technical/commercial aspects of the offer. Bidder may note that no technical and commercial clarifications will be sought for after the receipt of the bids. In case of any deviation/ nonconformity observed in the bid, it will be liable for

Date of Issue: 9th March'23



**COMPOSITE SUPPLY CUM ERECTION OF
ELECTRICAL & INSTRUMENTATION WORKS FOR
OSBL FACILITIES ON ITEM RATE BASIS
AT
TALCHER FERTILIZERS LIMITED, ANGUL, ODISHA
GENERAL CONDITION OF CONTRACT**

PC-183/ E-8003/ S-IV

0

DOC. NO.

REV.



Page 18 of 68

rejection.

- 17 Award of Contract:**
- 17.1 The Acceptance of Tender will be intimated to the successful Tenderer by TFL either by Telex/ Telegram/ Fax or by Letter or like means-defined as LETTER OF ACCEPTANCE OF TENDER.
- 17.2 TFL will be the sole judge in the matter of award of CONTRACT and the decision of TFL shall be final and binding.
- 18 Clarification of Tender Document:**
- 18.1 The Tender is required to carefully examine the Technical Specifications, Conditions of Contract, Drawings and other details relating to WORK and given in Tender Document and fully inform himself as to all conditions and matters which may in any way affect the WORK or the cost thereof. In case the Tenderer is in doubt about the completeness or correctness of any of the contents of the Tender Documents he should request in writing for an interpretation/ clarification to TFL in triplicate. TFL will then issue interpretation/ clarification to Tenderer in writing. Such clarifications and or interpretations shall form part of the Specifications and Documents and shall accompany the tender which shall be submitted by tenderer within time and date as specified in invitations to tender.
- 18.2 Verbal clarification and information given by TFL or its employee(s) or its representatives shall not in any way be binding on TFL.
- 19 Local Conditions:**
- 19.1 It will be imperative on each tenderer to inform himself of all local conditions and factors which may have any effect on the execution of WORK covered under the Tender Document. In their own interest, the tenderer are requested to familiarize themselves with the Indian Income Tax Act 1961, Indian Companies Act 1956, Indian Customs Act 1962 and other related Acts and Laws and Regulations of India with their latest amendments, as applicable TFL shall not entertain any requests for clarifications from the tenderer regarding such local conditions.
- 19.2 It must be understood and agreed that such factors have properly been investigated and considered while submitting the tender. No claim for financial or any other adjustments to VALUE OF CONTRACT, on lack of clarity of such factors shall be entertained.
- 20 Abnormal Rates:**
- 20.1 The tenderer is expected to quote rate for each item after careful analysis of cost involved for the performance of the completed item considering all specifications and Conditions of Contract. This will avoid loss of profit or gain in case of curtailment or change of specification for any item. In case it is noticed that the rates quoted by the tenderer for any item are unusually high or unusually low, it will be sufficient cause for the rejection of the tender unless the EMPLOYER is convinced about the reasonableness after scrutiny of the analysis for such rate(s) to be furnished by the tenderer (on demand).

Section-IV. General Obligations

- 21 Priority of Contract Documents**
- 21.1 Except if and the extent otherwise provided by the Contract, the provisions of the General Conditions of Contract and Special Conditions shall prevail over those of any other documents forming part of the CONTRACT. Several documents forming the CONTRACT are to be taken as mutually explanatory of one another, but in case of ambiguities or discrepancies the same shall be explained and adjusted by the ENGINEER-IN-CHARGE who shall thereupon issue to the Contractor instructions thereon and in such event, unless otherwise provided in the Contract, the priority of the documents forming the Contract shall be as follows :
- 1) The Contract Agreement ;
 - 2) The Letter of Acceptance;

Date of Issue: 9th March'23



**COMPOSITE SUPPLY CUM ERECTION OF
ELECTRICAL & INSTRUMENTATION WORKS FOR
OSBL FACILITIES ON ITEM RATE BASIS
AT
TALCHER FERTILIZERS LIMITED, ANGUL, ODISHA
GENERAL CONDITION OF CONTRACT**

PC-183/ E-8003/ S-IV

0

DOC. NO.

REV.



Page 19 of 68

- 3) The Instructions to Bidders (ITB);
- 4) Special Conditions of Contract (SCC);
- 5) General Conditions of Contract (GCC)
- 6) Any other document forming part of the Contract.

Works shown in the DRAWING but not mentioned in the SPECIFICATIONS OR described in the SPECIFICATIONS without being shown in the DRAWINGS shall nevertheless be deemed to be included in the same manner as if they had been specifically shown upon the DRAWINGS and described in the SPECIFICATIONS.

21.2 Headings and Marginal Notes: All headings and marginal notes to the clauses of these General Conditions of Contract or to the SPECIFICATIONS or to any other Tender Document are solely for the purpose of giving a concise indication and not a summary of the contents thereof, and they shall never be deemed to be part thereof or be used in the interpretation or construction thereof the CONTRACT.

21.3 Singular and Plural: In CONTRACT DOCUMENTS unless otherwise stated specifically, the singular shall include the plural and vice versa wherever the context so requires.

21.4 Interpretation: Words implying 'Persons' shall include relevant 'Corporate Companies / Registered Associations/ Body of Individuals/ Firm of Partnership' as the case may be.

22 Special Conditions of Contract:

22.1 Special Conditions of Contract shall be read in conjunction with the General Conditions of Contract, specification of Work, Drawings and any other documents forming part of this CONTRACT wherever the context so requires.

22.2 Notwithstanding the sub-division of the documents into these separate sections and volumes every part of each shall be deemed to be supplementary to and complementary of every other part and shall be read with and into the CONTRACT so far as it may be practicable to do so.

22.3 Where any portion of the General Condition of Contract is repugnant to or at variance with any provisions of the Special Conditions of Contract, unless a different intention appears the provisions of the Special Conditions of Contract shall be deemed to over-ride the provisions of the General Conditions of Contract and shall to the extent of such repugnancy, or variations, prevail.

22.4 Wherever it is mentioned in the specifications that the CONTRACTOR shall perform certain WORK or provide certain facilities, it is understood that the CONTRACTOR shall do so at his cost and the VALUE OF CONTRACT shall be deemed to have included cost of such performance and provisions, so mentioned.

22.5 The materials, design and workmanship shall satisfy the relevant INDIAN STANDARDS, the JOB SPECIFICATIONS contained herein and CODES referred to. Where the job specification stipulate requirements in addition to those contained in the standard codes and specifications, these additional requirements shall also be satisfied.

23 Contractor to obtain his own Information:

23.1 The CONTRACTOR in fixing his rate shall for all purpose whatsoever reason may be, deemed to have himself independently obtained all necessary information for the purpose of preparing his tender and his tender as accepted shall be deemed to have taken into account all contingencies as may arise due to such information or lack of same. The correctness of the details, given in the Tender Document to help the CONTRACTOR to make up the tender is not guaranteed.

Date of Issue: 9th March'23



**COMPOSITE SUPPLY CUM ERECTION OF
ELECTRICAL & INSTRUMENTATION WORKS FOR
OSBL FACILITIES ON ITEM RATE BASIS
AT
TALCHER FERTILIZERS LIMITED, ANGUL, ODISHA
GENERAL CONDITION OF CONTRACT**

PC-183/ E-8003/ S-IV

0

DOC. NO.

REV.



Page 20 of 68

The CONTRACTOR shall be deemed to have examined the CONTRACT DOCUMENTS, to have generally obtained his own information in all matters whatsoever that might affect the carrying out of the works at the schedules rates and to have satisfied himself to the sufficiency of his tender. Any error in description of quantity or omission there from shall not vitiate the CONTRACT or release the CONTRACTOR from executing the work comprised in the CONTRACT according to DRAWINGS and SPECIFICATIONS at the scheduled rates. He is deemed to have known the scope, nature and magnitude of the WORKS and the requirements of materials and labour involved etc., and as to what all works he has to complete in accordance with the CONTRACT documents whatever be the defects, omissions or errors that may be found in the DOCUMENTS. The CONTRACTOR shall be deemed to have visited surroundings, to have satisfied himself to the nature of all existing structures, if any, and also as to the nature and the conditions of the Railways, Roads, Bridges and Culverts, means of transport and communication, whether by land, water or air, and as to possible interruptions thereto and the access and egress from the site, to have made enquiries, examined and satisfied himself as to the sites for obtaining sand, stones, bricks and other materials, the sites for disposal of surplus materials, the available accommodation as to whatever required, depots and such other buildings as may be necessary for executing and completing the works, to have made local independent enquiries as to the sub-soil, subsoil water and variations thereof, storms, prevailing winds, climatic conditions and all other similar matters effecting these works. He is deemed to have acquainted himself as to his liability of payment of Government Taxes, Customs duty and other charges, levies etc.

Any neglect or omission or failure on the part of the CONTRACTOR in obtaining necessary and reliable information upon the foregoing or any other matters affecting the CONTRACT shall not relieve him from any risks or liabilities or the entire responsibility from completion of the works at the scheduled rates and times in strict accordance with the CONTRACT.

It is, therefore, expected that should the CONTRACTOR have any doubt as to the meaning of any portion of the CONTRACT DOCUMENT he shall set forth the particulars thereof in writing to EMPLOYER in duplicate, before submission of tender. The EMPLOYER may provide such clarification as may be necessary in writing to CONTRACT, such clarifications as provided by EMPLOYER shall form part of CONTRACT DOCUMENTS.

No verbal agreement or inference from conversation with any effect or employee of the EMPLOYER either before, during or after the execution of the CONTRACT agreement shall in any way affect or modify and of the terms or obligations herein contained.

Any change in layout due to site conditions or technological requirement shall be binding on the CONTRACTOR and no extra claim on this account shall be entertained.

**24 Contract Performance
Security:**

24.1 The CONTRACTOR shall furnish to the EMPLOYER, within 30 days from the date of notification of award, a security in the sum of 3% of the accepted value of the tender or the actual value of work to be done whichever is applicable due to any additional work or any other reasons, in the form of a Bank draft/Banker's cheque or Bank Guarantee or irrevocable Letter of credit (as per proforma enclosed) as Contract Performance Security with the EMPLOYER which will be refunded after the expiry of DEFECTS LIABILITY PERIOD.

24.2 CONTRACTOR can furnish the Contract Performance Security in the form of Demand Draft or through a Bank Guarantee or through an irrevocable Letter of Credit from any Indian scheduled bank or a branch of an International bank

Date of Issue: 9th March'23



**COMPOSITE SUPPLY CUM ERECTION OF
ELECTRICAL & INSTRUMENTATION WORKS FOR
OSBL FACILITIES ON ITEM RATE BASIS
AT
TALCHER FERTILIZERS LIMITED, ANGUL, ODISHA
GENERAL CONDITION OF CONTRACT**

PC-183/ E-8003/ S-IV

0

DOC. NO.

REV.



Page 21 of 68

situated in India and registered with Reserve Bank of India as scheduled foreign bank. However, other than the Nationalized Indian Banks, the banks whose BGs are furnished, must be commercial banks having net worth in excess of Rs. 100 crores and a declaration to this effect should be made by such commercial bank either in the bank guarantee itself or separately on a letter head.

The bank guarantee or the Letter of Credit shall be submitted in the prescribed format.

- 24.3 If the CONTRACTOR/SUB-CONTRACTOR or their employees or the CONTRACTOR's agents and representatives shall damage, break, deface or destroy any property belonging to the EMPLOYER or others during the execution of the CONTRACT, the same shall be made good by the CONTRACTOR at his own expenses and in default thereof, the ENGINEER-IN-CHARGE may cause the same to be made good by other agencies and recover expenses from the CONTRACTOR (for which the certificate of the ENGINEER- IN-CHARGE shall be final).
- 24.4 All compensation or other sums of money payable by the CONTRACTOR to the EMPLOYER under terms of this CONTRACT may be deducted from or paid by the encashment or sale of a sufficient part of his Contract Performance Security or from any sums which may be due or may become due to the CONTRACTOR by the EMPLOYER of any account whatsoever and in the event of his Contract Performance Security being reduced by reasons of any such deductions or sale of aforesaid, the CONTRACTOR shall within ten days thereafter make good in cash, bank drafts as aforesaid any sum or sums which may have been deducted from or realized by sale of his Contract Performance Security, or any part thereof. No interest shall be payable by the EMPLOYER for sum deposited as Contract Performance Security.
- 24.5 Failure of the successful bidder to comply with the requirements of this Clause shall constitute sufficient grounds for the annulment of the award and the forfeiture of bid security.

25 Time of Performance:

25.1 Time for Mobilization

The work covered by this CONTRACT shall be commenced within fifteen (15) days, the date of letter/Fax of Intent and be completed in stages on or before the dates as mentioned in the TIME SCHEDULE OF COMPLETION OF WORK. The CONTRACTOR should bear in mind that time is the essence of this agreement. Request for revision of construction time after tenders are opened will not receive consideration. The above period of fifteen (15) days is included within the overall COMPLETION SCHEDULE, not over and above the completion time to any additional work or any other reasons.

25.2 Time Schedule of Construction:

25.2.1 The general Time Schedule of construction is given in the TENDER DOCUMENT. CONTRACTOR should prepare a detailed monthly or weekly construction program jointly with the ENGINEER-IN-CHARGE within 15 days of receipt of LETTER/FAX OF INTENT or ACCEPTANCE OF TENDER. The WORK shall be executed strictly as per the Time Schedule given in the CONTRACT DOCUMENT. The period of construction given includes the time required for mobilization testing, rectifications, if any, retesting and completion in all respects in accordance with CONTRACT DOCUMENT to the entire satisfaction of the ENGINEER-IN-CHARGE.

25.2.2 The CONTRACTOR shall submit a detailed PERT network within the time frame agreed above consisting of adequate number of activities covering various key

Date of Issue: 9th March'23



**COMPOSITE SUPPLY CUM ERECTION OF
ELECTRICAL & INSTRUMENTATION WORKS FOR
OSBL FACILITIES ON ITEM RATE BASIS
AT
TALCHER FERTILIZERS LIMITED, ANGUL, ODISHA
GENERAL CONDITION OF CONTRACT**

PC-183/ E-8003/ S-IV

0

DOC. NO.

REV.



Page 22 of 68

phases of the WORK such as design, procurement, manufacturing, shipment and field erection activities within fifteen (15) days from the date of LETTER/FAX OF INTENT. This network shall also indicate the interface facilities to be provided by the EMPLOYER and the dates by which such facilities are needed.

25.2.3 CONTRACTOR shall discuss the network so submitted with the EMPLOYER and the agreed network which may be in the form as submitted with the EMPLOYER or in revised form in line with the outcome of discussions shall form part of the CONTRACT, to be signed within fifteen (15) days from the date of LETTER OF ACCEPTANCE OF TENDER. During the performance of the CONTRACT, if in the opinion of the EMPLOYER proper progress is not maintained suitable changes shall be made in the CONTRACTOR's operation to ensure proper progress.

The above PERT network shall be reviewed periodically and reports shall be submitted by the CONTRACTOR as directed by EMPLOYER.

26 Force Majeure:

26.1 CONDITIONS FOR FORCE MAJEURES

In the event of either party being rendered unable by Force Majeure to perform any obligations required to be performed by them under the CONTRACT the relative obligation of the party affected by such Force Majeures shall upon notification to the other party be suspended for the period during which Force Majeures event lasts. The cost and loss sustained by the either party shall be borne by the respective parties.

The term "Force Majeures" as employed herein shall mean acts of God, earthquake, war (declared or undeclared), revolts, riots, fires, floods, rebellions, explosions, hurricane, sabotage, civil commotions and acts and regulations of respective Government of the two parties, namely the EMPLOYER and the CONTRACTOR.

Upon the occurrence of such cause(s) and upon its termination, the party alleging that it has been rendered unable as aforesaid thereby, shall notify the other party in writing immediately but not later than 72 (Seventy-two) hours of the alleged beginning and ending thereof giving full particulars and satisfactory evidence in support of its claim.

Time for performance of the relative obligation suspended by the Force Majeures shall then stand extended by the period for which such cause lasts.

If deliveries of bought out items and/or works to be executed by the CONTRACTOR are suspended by Force Majeure conditions lasting for more than 2 (two) months the EMPLOYER shall have the option to terminate the CONTRACT or re-negotiate the contract provisions.

26.2 OUTBREAK OF WAR

26.2.1 If during the currency of the CONTRACT there shall be an out-break of war whether declared or not, in that part of the World which whether financially or otherwise materially affect the execution of the WORK the CONTRACTOR shall unless and until the CONTRACT is terminated under the provisions in this clause continue to use his best Endeavour to complete the execution of the WORK, provided always that the EMPLOYER shall be entitled, at any time after such out-break of war to terminate or re-negotiate the CONTRACT by giving notice in writing to the CONTRACTOR and upon such notice being given the CONTRACT shall, save as to the rights of the parties under this clause and to the operation of the clauses entitled settlement of Disputes and Arbitration hereof, be

Date of Issue: 9th March'23



**COMPOSITE SUPPLY CUM ERECTION OF
ELECTRICAL & INSTRUMENTATION WORKS FOR
OSBL FACILITIES ON ITEM RATE BASIS
AT
TALCHER FERTILIZERS LIMITED, ANGUL, ODISHA
GENERAL CONDITION OF CONTRACT**

PC-183/ E-8003/ S-IV

0

DOC. NO.

REV.



Page 23 of 68

terminated but without prejudice to the right of either party in respect of any antecedent breach thereof.

26.2.2 If the CONTRACT shall be terminated under the provisions of the above clause, the CONTRACTOR shall with all reasonable diligence remove from the SITE all the CONTRACTOR's equipment and shall give similar facilities to his SUB-CONTRACTORS to do so.

27 Price reduction schedule:

27.1 Time is the essence of the CONTRACT. In case the CONTRACTOR fails to complete the WORK within the stipulated period, then, unless such failure is due to Force Majeure as defined in Clause 26 here above or due to EMPLOYER's defaults, the Total Contract price shall be reduced by ½ % of the total Contract Price per complete week of delay or part thereof subject to a maximum of 5 % of the Total Contract Price, by way of reduction in price for delay and not as penalty. The said amount will be recovered from amount due to the Contractor/ Contractor's Contract Performance Security payable on demand.

The decision of the OWNER in regard to applicability of Price Reduction Schedule shall be final and binding on the CONTRACTOR.

27.2 All sums payable under this clause is the reduction in price due to delay in completion period at the above agreed rate.

27.3 BONUS FOR EARLY COMPLETION

**Bonus For Early Completion
27.3 (*)**

If the Contractor achieves completion of Works in all respect prior to the time schedule stipulated in the SCC, the Employer shall pay to the Contractor the relevant sum, if mentioned specifically in SCC, as bonus for early completion. The bonus for early completion, if provided specifically in SCC, shall be payable to the maximum ceiling of 2 ½ % of the total contract price.

(Clause not applicable for this
Tender)

(*) Partial earlier completion may not always produce net benefits to the Employer, for example where utilization of the completed Works requires (a) the fulfillment of all parts of the Contract (e.g. the training of personnel); or (b) the completion of all Sections (e.g. in pipeline laying, where early completion of the laying of pipeline would not be useful if the compressor is still under installation); or (c) certain seasonal effects to take place (e.g. onset of the rainy season, for impounding a reservoir); or (d) other circumstances. Also a more rapid drawdown of budgeted funds may be required. All such factors should be considered prior to the inclusion of a bonus clause in the Contract.

**28 Rights of the employer to
forfeit contract performance
security:**

28.1 Whenever any claim against the CONTRACTOR for the payment of a sum of money arises out or under the CONTRACT, the EMPLOYER shall be entitled to recover such sum by appropriating in part or whole the Contract Performance Security of the CONTRACTOR. In the event of the security being insufficient or if no security has been taken from the CONTRACTOR, then the balance or the total sum recoverable, as the case may be shall be deducted from any sum then due or which at any time thereafter may become due to the CONTRACTOR. The CONTRACTOR shall pay to the EMPLOYER on demand any balance remaining due.

28.2 In .case of forfeiture of Contract Performance Security/ Security Deposit, the forfeited amount will be considered inclusive of tax and tax invoice will be issued by TFL. The forfeiture amount will be subject to final decision of TFL based on other terms and conditions of order/ contract.

29 Failure by the contractor to

29.1 If the CONTRACTOR refuses or fails to execute the WORK or any separate part

Date of Issue: 9th March'23



**COMPOSITE SUPPLY CUM ERECTION OF
ELECTRICAL & INSTRUMENTATION WORKS FOR
OSBL FACILITIES ON ITEM RATE BASIS
AT
TALCHER FERTILIZERS LIMITED, ANGUL, ODISHA
GENERAL CONDITION OF CONTRACT**

PC-183/ E-8003/ S-IV

0

DOC. NO.

REV.



Page 24 of 88

**comply with the provisions
of the contract:**

thereof with such diligence as will ensure its completion within the time specified in the CONTRACT or extension thereof or fails to perform any of his obligation under the CONTRACT or in any manner commits a breach of any of the provisions of the CONTRACT it shall be open to the EMPLOYER at its option by written notice to the CONTRACTOR:

a) TO DETERMINE THE CONTRACT in which event the CONTRACT shall stand terminated and shall cease to be in force and effect on and from the date appointed by the EMPLOYER on that behalf, whereupon the CONTRACTOR shall stop forthwith any of the CONTRACTOR's work then in progress, except such WORK as the EMPLOYER may, in writing, require to be done to safeguard any property or WORK, or installations from damage, and the EMPLOYER, for its part, may take over the work remaining unfinished by the CONTRACTOR and complete the same through a fresh contractor or by other means, at the risk and cost of the CONTRACTOR, and any of his sureties if any, shall be liable to the EMPLOYER for any excess cost occasioned by such work having to be so taken over and completed by the EMPLOYER over and above the cost at the rates specified in the schedule of quantities and rate/prices.

b) WITHOUT DETERMINING THE CONTRACT to take over the work of the CONTRACTOR or any part thereof and complete the same through a fresh contractor or by other means at the risk and cost of the CONTRACTOR. The CONTRACTOR and any of his sureties are liable to the EMPLOYER for any excess cost over and above the cost at the rates specified in the Schedule of Quantities/ rates, occasioned by such works having been taken over and completed by the EMPLOYER.

29.2 In such events of Clause 29.1(a) or (b) above.

a) The whole or part of the Contract Performance Security furnished by the CONTRACTOR is liable to be forfeited without prejudice to the right of the EMPLOYER to recover from the CONTRACTOR the excess cost referred to in the sub-clause aforesaid, the EMPLOYER shall also have the right of taking possession and utilizing in completing the works or any part thereof, such as materials equipment and plants available at work site belonging to the CONTRACTOR as may be necessary and the CONTRACTOR shall not be entitled for any compensation for use or damage to such materials, equipment and plant.

b) The amount that may have become due to the CONTRACTOR on account of work already executed by him shall not be payable to him until after the expiry of Six (6) calendar months reckoned from the date of termination of CONTRACT or from the taking over of the WORK or part thereof by the EMPLOYER as the case may be, during which period the responsibility for faulty materials or workmanship in respect of such work shall, under the CONTRACT, rest exclusively with the CONTRACTOR. This amount shall be subject to deduction of any amounts due from the CONTRACT to the EMPLOYER under the terms of the CONTRACT authorized or required to be reserved or retained by the EMPLOYER.

29.3 Before determining the CONTRACT as per Clause 29.1(a) or (b) provided in the judgment of the EMPLOYER, the default or defaults committed by the CONTRACTOR is/are curable and can be cured by the CONTRACTOR if an opportunity given to him, then the EMPLOYER may issue Notice in writing

Date of Issue: 9th March'23



**COMPOSITE SUPPLY CUM ERECTION OF
ELECTRICAL & INSTRUMENTATION WORKS FOR
OSBL FACILITIES ON ITEM RATE BASIS
AT
TALCHER FERTILIZERS LIMITED, ANGUL, ODISHA
GENERAL CONDITION OF CONTRACT**

PC-183/ E-8003/ S-IV

0

DOC. NO.

REV.



Page 25 of 68

calling the CONTRACTOR to cure the default within such time specified in the Notice.

- 29.4 The EMPLOYER shall also have the right to proceed or take action as per 29.1(a) or (b) above, in the event that the CONTRACTOR becomes bankrupt, insolvent, compounds with his creditors, assigns the CONTRACT in favour of his creditors or any other person or persons, or being a company or a corporation goes into voluntary liquidation, provided that in the said events it shall not be necessary for the EMPLOYER to give any prior notice to the CONTRACTOR.
- 29.5 Termination of the CONTRACT as provided for in sub- clause 29.1(a) above shall not prejudice or affect their rights of the EMPLOYER which may have accrued upto the date of such termination.
- 30 Contractor remains liable to pay compensation if action not taken under clause 29:**
- 30.1 In any case in which any of the powers conferred upon the EMPLOYER BY CLAUSE 29.0 thereof shall have become exercisable and the same had not been exercised, the non-exercise thereof shall not constitute a waiver of any of the conditions hereof and such powers shall notwithstanding be exercisable in the event of any further case of default by the CONTRACTOR for which by any clause or clauses hereof he is declared liable to pay compensation amounting to the whole of his Contract Performance Security, and the liability of the CONTRACTOR for past and future compensation shall remain unaffected. In the event of the EMPLOYER putting in force the power under above sub-clause (a), (b) or (c) vested in him under the preceding clause he may, if he so desired, take possession of all or any tools, and plants, materials and stores in or upon the works or the site thereof belonging to the CONTRACTOR or procured by him and intended to be used for the execution of the WORK or any part thereof paying or allowing for the same in account at the CONTRACT rates or in case of these not being applicable at current market rates to be certified by the ENGINEER-IN-CHARGE whose certificate thereof shall be final, otherwise the ENGINEER-IN- CHARGE may give notice in writing to the CONTRACTOR or his clerk of the works, foreman or other authorized agent, requiring him to remove such tools, plant, materials or stores from the premises (within a time to be specified in such notice), and in the event of the CONTRACTOR failing to comply with any such requisition, the ENGINEER-IN-CHARGE may remove them at the CONTRACTOR's expense or sell them by auction or private sale on account of the CONTRACTOR and at his risk in all respects without any further notice as to the date, time or place of sale and the certificate of the ENGINEER-IN-CHARGE as to the expenses of any such removal and the amount of the proceeds and expenses of any such sale shall be final and conclusive against the CONTRACTOR.
- 31 Change in constitution:**
- 31.1 Where the CONTRACTOR is a partnership firm, the prior approval of the EMPLOYER shall be obtained in writing, before any change is made in the constitution of the firm. Where the CONTRACTOR is an individual or a Hindu undivided family business concern, such approval as aforesaid shall, likewise be obtained before such CONTRACTOR enters into any agreement with other parties, where under, the reconstituted firm would have the right to carry out the work hereby undertaken by the CONTRACTOR. In either case if prior approval as aforesaid is not obtained, the CONTRACT shall be deemed to have been allotted in contravention of clause 37 hereof and the same action may be taken and the same consequence shall ensure as provided in the said clause.
- 32 Termination of contract**
- 32(A) **TERMINATION OF CONTRACT FOR DEATH:**
If the CONTRACTOR is an individual or a proprietary concern and the individual or the proprietor dies or if the CONTRACTOR is a partnership concern and one of the partner dies then unless, the EMPLOYER is satisfied that the legal representative of the individual or the proprietary concern or the

Date of Issue: 9th March'23



**COMPOSITE SUPPLY CUM ERECTION OF
ELECTRICAL & INSTRUMENTATION WORKS FOR
OSBL FACILITIES ON ITEM RATE BASIS
AT
TALCHER FERTILIZERS LIMITED, ANGUL, ODISHA
GENERAL CONDITION OF CONTRACT**

PC-183/ E-8003/ S-IV

0

DOC. NO.

REV.



Page 26 of 68

surviving partners are capable of carrying out and completing CONTRACT, he (the EMPLOYER) is entitled to cancel the CONTRACT for the uncompleted part without being in any way liable for any compensation payment to the estate of the deceased CONTRACTOR and/or to the surviving partners of the CONTRACTOR'S firm on account of the cancellation of CONTRACT. The decision of the EMPLOYER in such assessment shall be final and binding on the parties. In the event of such cancellation, the EMPLOYER shall not hold the estate of the deceased CONTRACTOR and/or the surviving partners of the CONTRACTOR'S firm liable for any damages for non-completion of CONTRACT.

32(B) TERMINATION OF CONTRACT IN CASE OF LIQUIDATION / BANKRUPTCY ETC.

If the Contractor shall dissolve or become bankrupt or insolvent or cause or suffer any receiver to be appointed of his business or any assets thereof compound with his Creditors, or being a corporation commence to be wound up, not being a member's voluntary winding up for the purpose of amalgamation or reconstruction, or carry on its business under a Receiver for the benefits of its Creditors any of them, EMPLOYER shall be at liberty :-

To terminate the contract forthwith upon coming to know of the happening of any such event as aforesaid by notice in writing to the Contractor or to give the Receiver or liquidator or other person, the option of carrying out the contract subject to his providing a guarantee up to an amount to be agreed upon by EMPLOYER for due and faithful performance of the contract.

32 (C) In case of termination of CONTRACT herein set forth (under clause 29.0) except under conditions of Force Majeure and termination after expiry of contract, the CONTRACTOR shall be put under holiday [i.e. neither any enquiry will be issued to the party by Talcher Fertilizers Ltd. against any type of tender nor their offer will be considered by TFL against any ongoing tender (s) where contract between TFL and that particular CONTRACTOR (as a bidder) has not been finalized] for three years from the date of termination by Talcher Fertilizers Ltd. to such CONTRACTOR.

- 33 Members of the employer not individually liable :** 33.1 No Director, or official or employee of the EMPLOYER/ CONSULTANT shall in any way be personally bound or liable for the acts or obligations of the EMPLOYER under the CONTRACT or answerable for any default or omission in the observance or performance of any of the acts, matters or things which are herein contained.
- 34 Employer not bound by personal representations:** 34.1 The CONTRACTOR shall not be entitled to any increase on the scheduled rates or any other right or claim whatsoever by reason of any representation, explanation statement or alleged representation, promise or guarantees given or alleged to have been given to him by any person.
- 35 Contractor's office at site:** 35.1 The CONTRACTOR shall provide and maintain an office at the site for the accommodation of his agent and staff and such office shall be open at all reasonable hours to receive instructions, notice or other communications. The CONTRACTOR at all time shall maintain a site instruction book and compliance of these shall be communicated to the ENGINEER-IN CHARGE from time to time and the whole document to be preserved and handed over after completion of works.
- 36 Contractor's subordinate** 36.1 The CONTRACTOR, on or after award of the WORK shall name and depute a

Date of Issue: 9th March'23



**COMPOSITE SUPPLY CUM ERECTION OF
ELECTRICAL & INSTRUMENTATION WORKS FOR
OSBL FACILITIES ON ITEM RATE BASIS
AT
TALCHER FERTILIZERS LIMITED, ANGUL, ODISHA
GENERAL CONDITION OF CONTRACT**

PC-183/ E-8003/ S-IV

0

DOC. NO.

REV.



Page 27 of 68

staff and their conduct

qualified engineer having sufficient experience in carrying out work of similar nature, to whom the equipments, materials, if any, shall be issued and instructions for works given. The CONTRACTOR shall also provide to the satisfaction of the ENGINEER-IN-CHARGE sufficient and qualified staff to superintend the execution of the WORK, competent sub-agents, foremen and leading hands including those specially qualified by previous experience to supervise the types of works comprised in the CONTRACT in such manner as will ensure work of the best quality, expeditious working. Whenever in the opinion of the ENGINEER-IN-CHARGE additional properly qualified supervisory staff is considered necessary, they shall be employed by the CONTRACTOR without additional charge on accounts thereof. The CONTRACTOR shall ensure to the satisfaction of the ENGINEER-IN-CHARGE that SUB-CONTRACTORS, if any, shall provide competent and efficient supervision, over the work entrusted to them.

36.2 If and whenever any of the CONTRACTOR's or SUB- CONTRACTOR'S agents, sub-agents, assistants, foremen, or other employees shall in the opinion of ENGINEER-IN- CHARGE be guilty of any misconduct or be incompetent or insufficiently qualified or negligent in the performance of their duties of that in the opinion of the EMPLOYER or the ENGINEER-IN-CHARGE, it is undesirable for administrative or any other reason for such person or persons to be employed in the works, the CONTRACTOR, is so directed by the ENGINEER-IN-CHARGE, shall at once remove such person or persons from employment thereon. Any person or persons so removed from the works shall not again be employed in connection with the WORKS without the written permission of the ENGINEER-IN- CHARGE. Any person so removed from the WORK shall be immediately re-placed at the expense of the CONTRACTOR by a qualified and competent substitute. Should the CONTRACTOR be requested to repatriate any person removed from the works he shall do so and shall bear all costs in connection herewith.

36.3 The CONTRACTOR shall be responsible for the proper behavior of all the staff, foremen, workmen, and others, and shall exercise a proper degree of control over them and in particular and without prejudice to the said generality, the CONTRACTOR shall be bound to prohibit and prevent any employees from trespassing or acting in any way detrimental or prejudicial to the interest of the community or of the properties or occupiers of land and properties in the neighborhood and in the event of such employee so trespassing, the CONTRACTOR shall be responsible therefore and relieve the EMPLOYER of all consequent claims or actions for damages or injury or any other grounds whatsoever. The decision of the ENGINEER-IN-CHARGE upon any matter arising under this clause shall be final. The CONTRACTOR shall be liable for any liability to EMPLOYER on account of deployment of CONTRACTOR's staff etc. or incidental or arising out of the execution of CONTRACT.

The CONTRACTOR shall be liable for all acts or omissions on the part of his staff, Foremen and Workmen and others in his employment, including misfeasance or negligence of whatever kind in the course of their work or during their employment, which are connected directly or indirectly with the CONTRACT.

36.4 If and when required by the EMPLOYER and CONTRACTOR's personnel entering upon the EMPLOYER's premises shall be properly identified by badges of a type acceptable to the EMPLOYER which must be worn at all times on EMPLOYER's premises. CONTRACTOR may be required to obtain daily entry passes for his staff/employees from EMPLOYER to work within operating areas. These being safety requirements, no relaxations on this account shall be given to CONTRACTOR.

Date of Issue: 9th March'23



**COMPOSITE SUPPLY CUM ERECTION OF
ELECTRICAL & INSTRUMENTATION WORKS FOR
OSBL FACILITIES ON ITEM RATE BASIS
AT
TALCHER FERTILIZERS LIMITED, ANGUL, ODISHA
GENERAL CONDITION OF CONTRACT**

PC-183/ E-8003/ S-IV

0

DOC. NO.

REV.



Page 28 of 68

37 Sub-letting of works:

37.1

No part of the CONTRACT nor any share or interest therein shall in any manner or degree be transferred, assigned or sublet by the CONTRACTOR directly or indirectly to any person, firm or corporation whatsoever without the consent in writing, of the ENGINEER/ EMPLOYER except as provided for in the succeeding sub-clause.

i) **SUB-CONTRACTS FOR TEMPORARY WORKS ETC.:**

The EMPLOYER may give written consent to Sub- contract for the execution of any part of the WORK at the site, being entered in to by CONTRACTOR provided each individual Sub- contract is submitted to the ENGINEER-IN-CHARGE before being entered into and is approved by him.

ii) **LIST OF SUB-CONTRACTORS TO BE SUPPLIED:**

At the commencement of every month the CONTRACTOR shall furnish to the ENGINEER-IN- CHARGE list of all SUB-CONTRACTORS or other persons or firms engaged by the CONTRACTOR and working at the SITE during the previous month with particulars of the general nature of the Subcontract or works done by them.

iii) **CONTRACTOR'S LIABILITY NOT LIMITED BY SUB-CONTRACTORS:**

Notwithstanding any sub-letting with such approval as aforesaid and notwithstanding that the ENGINEER-IN-CHARGE shall have received copies of any Subcontracts, the contractor shall be and shall remain solely responsible for the quality, proper and expeditious execution of the Contract in all respects as if such sub-letting or Subcontracting had not taken place, and as if such work had been done directly by the CONTRACTOR. The CONTRACTOR shall bear all responsibility for any act or omission on the part of sub-contractors in regard to work to be performed under the CONTRACT.

iv) **EMPLOYER MAY TERMINATE SUB-CONTRACTS:**

If any SUB-CONTRACTOR engaged upon the works at the site executes any works which in the opinion of the ENGINEER-IN-CHARGE is not in accordance with the CONTRACT documents, the EMPLOYER may by written notice to the CONTRACTOR request him to terminate such subcontract and the CONTRACTOR upon the receipt of such notice shall terminate such Subcontract and dismiss the SUB-CONTRACTOR(S) and the later shall forthwith leave the works, failing which the EMPLOYER shall have the right to remove such SUB- CONTRACTOR(S) from the site.

v) **NO REMEDY FOR ACTION TAKEN UNDER THIS CLAUSE:**

No action taken by the EMPLOYER under the clause shall relieve the CONTRACTOR of any of his liabilities under the CONTRACT or give rise to any right or compensation, extension of time or otherwise failing which the EMPLOYER shall have the right to remove such SUB-CONTRACTOR(S) from the site.

Date of Issue: 9th March'23



**COMPOSITE SUPPLY CUM ERECTION OF
ELECTRICAL & INSTRUMENTATION WORKS FOR
OSBL FACILITIES ON ITEM RATE BASIS
AT
TALCHER FERTILIZERS LIMITED, ANGUL, ODISHA
GENERAL CONDITION OF CONTRACT**

PC-183/ E-8003/ S-IV

0

DOC. NO.

REV.



Page 29 of 68

38 Power of entry:

38.1

If the CONTRACTOR shall not commence the WORK in the manner previously described in the CONTRACT documents or if he shall at any time in the opinion of the ENGINEER-IN-CHARGE.

- i) fail to carry out the WORK in conformity with the CONTRACT documents, or
- ii) fail to carry out the WORK in accordance with the Time Schedule, or
- iii) substantially suspend work or the WORK for a period of fourteen days without authority from the ENGINEER-IN-CHARGE, or
- iv) fail to carry out and execute the WORK to the satisfaction of the ENGINEER-IN-CHARGE, or
- v) fail to supply sufficient or suitable construction plant, temporary works, labour, materials or things, or
- vi) Commit, suffer, or permit any other breach of any of the provisions of the CONTRACT on his part to be performed or observed or persist in any of the above mentioned breaches of the CONTRACT for fourteen days, after notice in writing shall have been given to the CONTRACTOR by the ENGINEER-IN-CHARGE requiring such breach to be remedied, or
- vii) if the CONTRACTOR shall abandon the WORK or
- viii) If the CONTRACTOR during the continuance of the CONTRACT shall become bankrupt, make any arrangement or composition with his creditors, or permit any execution to be levied or go into liquidation whether compulsory or voluntary not being merely a voluntary liquidation for the purpose of amalgamation or reconstruction

then in any such case, the EMPLOYER shall have the power to enter upon the WORK and take possession thereof and of the materials, temporary WORK, construction plant, and stock thereon, and to revoke the CONTRACTOR's license to use the same, and to complete the WORK by his agents, other CONTRACTORS or workmen or to relate the same upon any terms and to such other person, firm or corporation as the EMPLOYER in his absolute discretion may think proper to employ and for the purpose aforesaid to use or authorize the use of any materials, temporary work, CONSTRUCTION PLANT, and stock as aforesaid, without making payment or allowance to the CONTRACTOR for the said materials other than such as may be certified in writing by the ENGINEER-IN-CHARGE to be reasonable, and without making any payment or allowance to the CONTRACTOR for the use of the temporary said works, construction plant and stock or being liable for any loss or damage thereto, and if the EMPLOYER shall by reason of his taking possession of the WORK or of the WORK being completed by other CONTRACTOR (due account being taken of any such extra work or works which may or be omitted) then the amount of such excess as certified by the ENGINEER-IN- CHARGE shall be deducted from any money which may be due for work done by the CONTRACTOR under the CONTRACT and not paid for. Any deficiency shall forthwith be made good and

Date of Issue: 9th March'23



**COMPOSITE SUPPLY CUM ERECTION OF
ELECTRICAL & INSTRUMENTATION WORKS FOR
OSBL FACILITIES ON ITEM RATE BASIS
AT
TALCHER FERTILIZERS LIMITED, ANGUL, ODISHA
GENERAL CONDITION OF CONTRACT**

PC-183/ E-8003/ S-IV

0

DOC. NO.

REV.



Page 30 of 68

paid to the EMPLOYER by the CONTRACTOR and the EMPLOYER shall have power to sell in such manner and for such price as he may think fit all or any of the construction plant, materials etc. constructed by or belonging to and to recoup and retain the said deficiency or any part thereof out of proceeds of the sale.

39 Contractor's responsibility with the mechanical, electrical, intercommunication system, air-conditioning contractors and other agencies:

39.1 Without repugnance of any other condition, it shall be the responsibility of the CONTRACTOR executing the work of civil construction, to work in close cooperation and coordinate the WORK with the Mechanical, Electrical, Air-conditioning and Intercommunication Contractor's and other agencies or their authorized representatives, in providing the necessary grooves, recesses, cuts and opening etc., in wall, slabs beams and columns etc. and making good the same to the desired finish as per specification, for the placement of electrical, intercommunication cables, conduits, air-conditioning inlets and outlets grills and other equipments etc. where required. For the above said requirements in the false ceiling and other partitions, the CONTRACTOR before starting-up the work shall in consultation with the Electrical, Mechanical, Intercommunication, Air-conditioning contractor and other agencies prepare and put-up a joint scheme, showing the necessary openings, grooves, recesses, cuts, the methods of fixing required for the WORK of the aforesaid, and the finishes therein, to the ENGINEER-IN-CHARGE and get the approval. The CONTRACTOR before finally submitting the scheme to the ENGINEER-IN-CHARGE, shall have the written agreement of the other agencies. The ENGINEER- IN-CHARGE, before communicating his approval to the scheme, with any required modification, shall get the final agreement of all the agencies, which shall be binding. No claim shall be entertained on account of the above.

The CONTRACTOR shall confirm in all respects with provision of any statutory regulations, ordinances or byelaws of any local or duly constituted authorities or public bodies which may be applicable from time to time to the WORK or any temporary works. The CONTRACTOR shall keep the EMPLOYER indemnified against all penalties and liabilities of every kind, arising out of non- adherence to such stains, ordinances, laws, rules, regulations, etc.

40 Other agencies at site:

40.1 The CONTRACTOR shall have to execute the WORK in such place and conditions where other agencies will also be engaged for other works such as site grading, filling, and leveling, electrical and mechanical engineering works, etc. No claim shall be entertained due to WORK being executed in the above circumstances.

41 Notice:

41.1 TO THE CONTRACTOR:

Any notice hereunder may be served on the CONTRACTOR or his duly authorized representative at the job site or may be served by registered mail direct to the address furnished by the CONTRACTOR. Proof of issue of any such notice could be conclusive of the CONTRACTOR having been duly informed of all contents therein.

41.2 TO THE EMPLOYER:

Any notice to be given to the EMPLOYER under the terms of the CONTRACTOR shall be served by sending the same by Registered mail to or delivering the same at the respective site offices of M/s Talcher Fertilizers Ltd. addressed to the HEAD/SITE-IN-CHARGE.

42 Right of various interests:

i) The EMPLOYER reserves the right to distribute the work between more than one agency(ies). The CONTRACTOR shall cooperate and afford other agency(ies) reasonable opportunity for

Date of Issue: 9th March'23



**COMPOSITE SUPPLY CUM ERECTION OF
ELECTRICAL & INSTRUMENTATION WORKS FOR
OSBL FACILITIES ON ITEM RATE BASIS
AT
TALCHER FERTILIZERS LIMITED, ANGUL, ODISHA
GENERAL CONDITION OF CONTRACT**

PC-183/ E-8003/ S-IV

0

DOC. NO.

REV.



Page 31 of 68

access to the WORK for the carriage and storage of materials and execution of their works.

- ii) Wherever the work being done by any department of the EMPLOYER or by other agency(ies) employed by the EMPLOYER is contingent upon WORK covered by this CONTRACT, the respective rights of the various interests involved shall be determined by the ENGINEER-IN-CHARGE to secure the completion of the various portions of the work in general harmony.

43 Patents and royalties:

- 43.1 The CONTRACTOR, if licensed under any patent covering equipment, machinery, materials or compositions of matter to be used or supplied or methods and process to be practiced or employed in the performance of this CONTRACT, agrees to pay all royalties and license fees which may be due with respect thereto. If any equipment, machinery, materials, composition of matters, be used or supplied or methods and processes to be practiced or employed in the performance of this CONTRACT, is covered by a patent under which the CONTRACTOR is not licensed then the CONTRACTOR before supplying or using the equipment, machinery materials, composition method or processes shall obtain such licenses and pay such royalties and license fees as may be necessary for performance of this CONTRACT. In the event the CONTRACTOR fails to pay any such royalty or obtain any such license, any suit for infringement of such patents which is brought against the CONTRACTOR or the EMPLOYER as a result such failure will be defended by the CONTRACTOR at his own expense and the CONTRACTOR will pay any damages and costs awarded in such suit. The CONTRACTOR shall promptly notify the EMPLOYER if the CONTRACTOR has acquired the knowledge of any plant under which a suit for infringement could be reasonably brought because of the use by the EMPLOYER of any equipment, machinery, materials, process, methods to be supplied hereunder. The CONTRACTOR agrees to and does hereby grant to EMPLOYER, together with the right to extend the same to any of the subsidiaries of the EMPLOYER as irrevocable, royalty free license to use in any country, any invention made by the CONTRACTOR or his employee in or as result of the performance of the WORK under the CONTRACT.
- 43.2 All charges on account of royalty, toilage, rent, octroi terminal or sales tax and/ or other duties or any other levy on materials obtained for the work or temporary work or part thereof (excluding materials provided by the EMPLOYER) shall be borne by the CONTRACTOR.
- 43.3 The CONTRACTOR shall not sell or otherwise dispose of or remove except for the purpose of this CONTRACT, the sand, stone, clay, ballast, earth, rock or other substances, or materials obtained from any excavation made for the purpose of the WORK or any building or produce upon the site at the time of delivery of the possession thereof, but all such substances, materials, buildings and produce shall be the property of the EMPLOYER provided that the CONTRACTOR may with the permission of the ENGINEER-IN-CHARGE, use the same for the purpose of the work by payment of cost of the same at such a rate as may be determined by the ENGINEER-IN- CHARGE.
- 43.4 The EMPLOYER shall indemnify and save harmless the CONTRACTOR from any loss on account of claims against CONTRACTOR for the contributory infringement of patent rights arising out and based upon the claim that the use of the EMPLOYER of the process included in the design prepared by the EMPLOYER and used in the operation of the plant infringes on any patent right. With respect to any subcontract entered into by CONTRACTOR pursuant to the provisions of the relevant clause hereof, the CONTRACTOR shall obtain from the SUB-CONTRACTOR an undertaking to provide the EMPLOYER with the same

Date of Issue: 9th March'23



**COMPOSITE SUPPLY CUM ERECTION OF
ELECTRICAL & INSTRUMENTATION WORKS FOR
OSBL FACILITIES ON ITEM RATE BASIS
AT
TALCHER FERTILIZERS LIMITED, ANGUL, ODISHA
GENERAL CONDITION OF CONTRACT**

PC-183/ E-8003/ S-IV

0

DOC. NO.

REV.



Page 32 of 68

patent protection that CONTRACTOR is required to provide under the provisions of this clause.

- 44 Liens:**
- 44.1 If, at any time there should be evidence or any lien or claim for which the EMPLOYER might have become liable and which is chargeable to the CONTRACTOR, the EMPLOYER shall have the right to retain out of any payment then due or thereafter to become due an amount sufficient to completely indemnify the EMPLOYER against such lien or claim and if such lien or claim be valid, the EMPLOYER may pay and discharge the same and deduct the amount so paid from any money which may be or may become due and payable to the CONTRACTOR. If any lien or claim remain unsettled after all payments are made, the CONTRACTOR shall refund or pay to the EMPLOYER all money that the latter may be compelled to pay in discharging such lien or claim including all costs and reasonable expenses. EMPLOYER reserves the right to do the same.
- 44.2 The EMPLOYER shall have lien on all materials, equipments including those brought by the CONTRACTOR for the purpose of erection, testing and commissioning of the WORK.
- 44.3 The final payment shall not become due until the CONTRACTOR delivers to the ENGINEER-IN-CHARGE a complete release or waiver of all liens arising or which may arise out of his agreement or receipt in full or certification by the CONTRACTOR in a form approved by ENGINEER-IN-CHARGE that all invoices for labour, materials, services have been paid in lien thereof and if required by the ENGINEER-IN-CHARGE in any case an affidavit that so far as the CONTRACTOR has knowledge or information the releases and receipts include all the labour and material for which a lien could be filled.
- 44.4 CONTRACTOR will indemnify and hold the EMPLOYER harmless, for a period of two years after the issue of FINAL CERTIFICATE, from all liens and other encumbrances against the EMPLOYER on account of debts or claims alleged to be due from the CONTRACTOR or his SUB-CONTRACTOR to any person including SUB- CONTRACTOR and on behalf of EMPLOYER will defend at his own expense, any claim or litigation brought against the EMPLOYER or the CONTRACTOR in connection therewith. CONTRACTOR shall defend or contest at his own expense any fresh claim or litigation by any person including his SUB-CONTRACTOR, till its satisfactory settlement even after the expiry of two years from the date of issue of FINAL CERTIFICATE.
- 45 Delays by employer or his authorized agents:**
- 45.1 In case the CONTRACTOR's performance is delayed due to any act or omission on the part of the EMPLOYER or his authorized agents, then the CONTRACTOR shall be given due extension of time for the completion of the WORK, to the extent such omission on the part of the EMPLOYER has caused delay in the CONTRACTOR's performance of his WORK.
- 45.2 No adjustment in CONTRACT PRICE shall be allowed for reasons of such delays and extensions granted except as provided in TENDER DOCUMENT, where the EMPLOYER reserves the right to seek indulgence of CONTRACTOR to maintain the agreed Time Schedule of Completion.
- In such an event the CONTRACTOR shall be obliged for working by CONTRACTOR's personnel for additional time beyond stipulated working hours as also Sundays and Holidays and achieve the completion date/interim targets.
- 46 Payment if the contract is terminated:**
- 46.1 If the CONTRACT shall be terminated as per Tender pursuant to Clause no. 29 of GCC, the CONTRACTOR shall be paid by the EMPLOYER in so far as such amounts or items shall not have already been covered by payments of amounts made to the CONTRACTOR for the WORK executed and accepted by

Date of Issue: 9th March'23



**COMPOSITE SUPPLY CUM ERECTION OF
ELECTRICAL & INSTRUMENTATION WORKS FOR
OSBL FACILITIES ON ITEM RATE BASIS
AT
TALCHER FERTILIZERS LIMITED, ANGUL, ODISHA
GENERAL CONDITION OF CONTRACT**

PC-183/ E-8003/ S-IV

0

DOC. NO.

REV.



Page 33 of 68

ENGINEER-IN-CHARGE prior to the date of termination at the rates and prices provided for in the CONTRACT and in addition to the following:

a) The amount payable in respect of any preliminary items, so far as the Work or service comprised therein has been carried out or performed and an appropriate portion as certified by ENGINEER-IN-CHARGE of any such items or service comprised in which has been partially carried out or performed.

b) Any other expenses which the CONTRACTOR has expended for performing the WORK under the CONTRACT subject to being duly recommended by ENGINEER-IN-CHARGE and approved by EMPLOYER for payment, based on documentary evidence of his having incurred such expenses.

46.2 The CONTRACTOR will be further required to transfer the title and provide the following in the manner and as directed by the EMPLOYER.

a) Any and all completed works.

b) Such partially completed WORK including drawings, information's and CONTRACT rights as the CONTRACTOR has specially performed, produced or acquired for the performance of the CONTRACTOR.

47 No waiver of rights: 47.1 Neither the inspection by the EMPLOYER or any of their officials, employees, or agents nor any order by the EMPLOYER for payment of money or any payment for or acceptance of the whole or any part of the Work by the EMPLOYER nor any extension of time, nor any possession taken by EMPLOYER shall operate as a waiver of any provision of the CONTRACT, or of any power herein reserved to the EMPLOYER, or any right to damages herein provided, nor shall any waiver of any breach in the CONTRACT be held to be a waiver of any other subsequent breach.

48 Certificate not to affect right of employer and liability of contractor: 48.1 No interim payment certificate(s) issued by the Engineer-in-Charge of the EMPLOYER, nor any sum paid on account by the EMPLOYER, nor any extension of time for execution of the work granted by EMPLOYER shall affect or prejudice the rights of the Employer against the CONTRACTOR or relieve the CONTRACTOR of his obligations for the due performance of the CONTRACT, or be interpreted as approval of the WORK done or of the equipment supplied and no certificate shall create liability for the EMPLOYER to pay for alterations, amendments, variations or additional works not ordered, in writing, by EMPLOYER or discharge the liability of the CONTRACTOR for the payment of damages whether due, ascertained, or certified or not or any sum against the payment of which he is bound to indemnify the EMPLOYER.

49 Language and measures: 49.1 All documents pertaining to the CONTRACT including Specifications, Schedules, Notices, Correspondence, operating and maintenance Instructions, DRAWINGS, or any other writing shall be written in English language. The Metric System of measurement shall be used in the CONTRACT unless otherwise specified.

50 Transfer of title: 50.1 The title of Ownership of supplies furnished by the CONTRACTOR shall not pass on to the EMPLOYER for all Supplies till the same are finally accepted by the EMPLOYER after the successful completion of PERFORMANCE TEST and GUARANTEE TEST and issue of FINAL CERTIFICATE.

Date of Issue: 9th March'23



**COMPOSITE SUPPLY CUM ERECTION OF
ELECTRICAL & INSTRUMENTATION WORKS FOR
OSBL FACILITIES ON ITEM RATE BASIS
AT
TALCHER FERTILIZERS LIMITED, ANGUL, ODISHA
GENERAL CONDITION OF CONTRACT**

PC-183/ E-8003/ S-IV

0

DOC. NO.

REV.



Page 34 of 68

- 50.2 However, the EMPLOYER shall have the lien on all such works performed as soon as any advance or progressive payment is made by the EMPLOYER to the CONTRACTOR and the CONTRACTOR shall not subject these works for use other than those intended under this CONTRACT.
- 51 Release of information:** 51.1 The CONTRACTOR shall not communicate or use in advertising, publicity, sales releases or in any other medium, photographs, or other reproduction of the Work under this CONTRACT or description of the site dimensions, quantity, quality or other information, concerning the Work unless prior written permission has been obtained from the EMPLOYER.
- 52 Brand names:** 52.1 The specific reference in the SPECIFICATIONS and documents to any material by trade name, make or catalogue number shall be construed as establishing standard or quality and performance and not as limited competition. However, TENDERER may offer other similar equipments provided it meets the specified standard design and performance requirements.
- 53 Completion of contract:** 53.1 Unless otherwise terminated under the provisions of any other relevant clause, this CONTRACT shall be deemed to have been completed at the expiration of the PERIOD OF LIABILITY as provided for under the CONTRACT.
- 54 Spares:** 54.1 The CONTRACTOR shall furnish to the EMPLOYER all spares required for COMMISSIONING of the plants, recommendatory and/or mandatory spares, which are required essential by the manufacturer/supplier. The same shall be delivered at SITE, 3(Three) months before COMMISSIONING.
- Also the CONTRACTOR should furnish the manufacturing drawings for fast wearing spares.
- 54.2 The CONTRACTOR guarantees the EMPLOYER that before the manufacturers of the equipments, plants and machineries go out of production of spare parts for the equipment furnished and erected by him, he shall give at least twelve (12) months' advance notice to the EMPLOYER, so that the latter may order his requirement of spares in one lot, if he so desires.

SECTION-V Performance of Work

- 55 Execution of work:** 55.1 All the Works shall be executed in strict conformity with the provisions of the CONTRACT Documents and with such explanatory detailed drawings, specification and instructions as may be furnished from time to time to the CONTRACTOR by the ENGINEER-IN-CHARGE whether mentioned in the CONTRACT or not. The CONTRACTOR shall be responsible for ensuring that works throughout are executed in the most substantial, proper and workmanlike manner with the quality of material and workmanship in strict accordance with the SPECIFICATIONS and to the entire satisfaction of the ENGINEER-IN-CHARGE. The CONTRACTOR shall provide all necessary materials equipment labour etc. for execution and maintenance of WORK till completion unless otherwise mentioned in the CONTRACT.
- 56 Co-ordination and inspection of work:** 56.1 The coordination and inspection of the day-to-day work under the CONTRACT shall be the responsibility of the ENGINEER-IN-CHARGE. The written instruction regarding any particular job will normally be passed by the ENGINEER-IN-CHARGE or his authorized representative. A work order book will be maintained by the CONTRACTOR for each sector in which the aforesaid written instructions will be entered. These will be signed by the CONTRACTOR or his authorized representative by way of acknowledgement within 12 hours.

Date of Issue: 9th March'23



**COMPOSITE SUPPLY CUM ERECTION OF
ELECTRICAL & INSTRUMENTATION WORKS FOR
OSBL FACILITIES ON ITEM RATE BASIS
AT
TALCHER FERTILIZERS LIMITED, ANGUL, ODISHA
GENERAL CONDITION OF CONTRACT**

PC-183/ E-8003/ S-IV

0

DOC. NO.

REV.



Page 35 of 68

- 57 Work in monsoon and dewatering:**
- 57.1 Unless otherwise specified elsewhere in the tender, the execution of the WORK may entail working in the monsoon also. The CONTRACTOR must maintain a minimum labour force as may be required for the job and plan and execute the construction and erection according to the prescribed schedule. No extra rate will be considered for such work in monsoon.
- 57.2 During monsoon and other period, it shall be the responsibility of the CONTRACTOR to keep the construction work site free from water at his own cost.
- 58 Work on sundays and holidays:**
- 58.1 For carrying out Work on Sundays, and Holidays, the CONTRACTOR will approach the ENGINEER-IN-CHARGE or his representative at least two days in advance and obtain permission in writing. The CONTRACTOR shall observe all labour laws and other statutory rules and regulations in force. In case of any violations of such laws, rules and regulations, consequence if any, including the cost thereto shall be exclusively borne by the CONTRACTOR and the EMPLOYER shall have no liability whatsoever on this account.
- 59 General conditions for construction and erection work:**
- 59.1 The working time at the site of work is 48 hours per week. Overtime work is permitted in cases of need and the EMPLOYER will not compensate the same. Shift working at 2 or 3 shifts per day will become necessary and the CONTRACTOR should take this aspect into consideration for formulating his rates for quotation. No extra claims will be entertained by the EMPLOYER on this account. For carrying out work beyond working hours the CONTRACTOR will approach the ENGINEER-IN-CHARGE or his authorized representative and obtain his prior written permission.
- 59.2 The CONTRACTOR must arrange for the placement of workers in such a way that the delayed completion of the WORK or any part thereof for any reason whatsoever will not affect their proper employment. The EMPLOYER will not entertain any claim for idle time payment whatsoever.
- 59.3 The CONTRACTOR shall submit to the EMPLOYER/ ENGINEER-IN-CHARGE reports at regular intervals regarding the state and progress of WORK. The details and proforma of the report will mutually be agreed after the award of CONTRACT. The CONTRACTOR shall provide display boards showing progress and labour strengths at worksite, as directed by the ENGINEER-IN-CHARGE.
- 60 Alterations in specifications, design and extra works:**
- 60.1 The WORK covered under this CONTRACT having to be executed by the CONTRACTOR on a lumpsum firm price/item rate quoted by him, the EMPLOYER will not accept any proposals for changes in VALUE OF CONTRACT or extension in time on account of any such changes which may arise to the CONTRACTOR's scope of WORK as a result of detailed Engineering and thereafter during the execution of WORK. The only exception to this will be a case where the EMPLOYER requests in writing to the CONTRACTOR to upgrade the SPECIFICATIONS or the size of any major pieces of equipments, plant or machinery beyond what is normally required to meet the scope of WORK as defined in the CONTRACT DOCUMENT.
- In such cases, a change order will be initialled by the CONTRACTOR at the appropriate time for the EMPLOYER's prior approval giving the full back-up data for their review and for final settlement of any impact on price within 30 (thirty) days thereafter.
- 60.2 The ENGINEER-IN-CHARGE shall have to make any alterations in, omission from, additions to or substitutions for, the Schedule of Rates, the original specifications, drawings, designs and instructions that may appear to him to be

Date of Issue: 9th March'23



**COMPOSITE SUPPLY CUM ERECTION OF
ELECTRICAL & INSTRUMENTATION WORKS FOR
OSBL FACILITIES ON ITEM RATE BASIS
AT
TALCHER FERTILIZERS LIMITED, ANGUL, ODISHA
GENERAL CONDITION OF CONTRACT**

PC-183/ E-8003/ S-IV

0

DOC. NO.

REV.



Page 36 of 68

necessary or advisable during the progress of the WORK and the CONTRACTOR shall be bound to carry out the such altered/ extra/ new items of WORK in accordance with any instructions which may be given to him in writing signed by the ENGINEER-IN- CHARGE, and such alterations, omissions, additions or substitutions shall not invalidate the CONTRACT and any altered, additional or substituted work which the CONTRACTOR may be directed to do in the manner above specified as part of the WORK shall be carried out by the CONTRACTOR on the same conditions in all respects on which he agreed to do the main WORK. The time of completion of WORK may be extended for the part of the particular job at the discretion of the ENGINEER-IN- CHARGE, for only such alterations, additions or substitutions of the WORK, as he may consider as just and reasonable. The rates for such additional, altered or substituted WORK under this clause shall be worked out in accordance with the following provisions:-

I. For Item Rate Contract

- a) If the rates for the additional, altered or substituted WORK are specified in the CONTRACT for the WORK, the CONTRACTOR is bound to carry on the additional, altered or substituted WORK at the same rates as are specified in the CONTRACT.
- b) If the rates for the additional, altered or substituted WORK are not specifically provided in the CONTRACT for the WORK, the rates will be derived from the rates for similar class of WORK as are specified in the CONTRACT for the WORK. The opinion of the ENGINEER-IN- CHARGE, as to whether or not the rates can be reasonably so derived from the items in this CONTRACT will be final and binding on the CONTRACTOR.
- c) If the rates for the altered, additional or substituted WORK cannot be determined in the manner specified in sub-clause(s) (a) and (b) above, then the CONTRACTOR shall, within 7 days of the date of receipt of order to carry out the WORK, inform the ENGINEER-IN-CHARGE of the rates which it is his intention to charge for such class of WORK, supported by analysis of the rate or rates claimed, and the ENGINEER-IN-CHARGE shall determine the rate or rates on the basis of the prevailing market rates, labour cost at schedule of labour rates plus 10% to cover contractor's supervision, overheads and profit and pay the CONTRACTOR accordingly. The opinion of the ENGINEER- IN-CHARGE as to current market rates of materials and the quantum of labour involved per unit of measurement will be final and binding on the CONTRACTOR.
- d) Where the item of work will be executed through nominated specialist agency as approved by the ENGINEER-IN-CHARGE, then the actual amount paid to such nominated agency supported by documentary evidence and as certified by ENGINEER-IN-CHARGE shall be considered plus 10% (ten percent) to cover all contingencies, overhead, profits to arrive at the rates.
- e) Provisions contained in the Sub-clause (a) & (d) above shall, however, not apply for the following:-

Date of Issue: 9th March'23



**COMPOSITE SUPPLY CUM ERECTION OF
ELECTRICAL & INSTRUMENTATION WORKS FOR
OSBL FACILITIES ON ITEM RATE BASIS
AT
TALCHER FERTILIZERS LIMITED, ANGUL, ODISHA
GENERAL CONDITION OF CONTRACT**

PC-183/ E-8003/ S-IV

0

DOC. NO.

REV.



Page 37 of 68

Where the value of additions of new items together with the value of alterations, additions/ deletions or substitutions does not exceed by or is not less than plus/minus (±)25% of the VALUE OF CONTRACT. The item rates in the Schedule of Rates shall hold good for all such variations between the above mentioned limits, irrespective of any increase/decrease of quantities in the individual items of Schedule of Rates.

Where the value of addition of new items together with the value of alterations, additions/ deletions or substitutions reduces more than 25% of the contract value but is within the following limits the tenderer shall be paid compensation for decrease in the value of work, as follows:

S.No.	Range of Variation	Percentage compensation for decrease in the value of work in the respective range.
a)	Beyond (+) 25% upto & inclusive of (+) 50%	No increase and/ or decrease shall be applicable for the Schedule of Rates (The rates quoted for this increase shall be valid).
b)	Beyond (-) 25% upto & inclusive of (-) 50%	For reduction beyond 25% contractor shall be compensated by an amount equivalent to 10% of the reduction in value of the contract as awarded. For example if the actual contract value is 70% of awarded value then compensation shall be 10% of (75-70) i.e. 0.5% of awarded contract value.

II. For Lumpsum Contracts

CONTRACTOR shall, within 7 days of the date of receipt of order to carry out the WORK, inform the ENGINEER-IN- CHARGE of the rates which it is his intention to charge for such class of WORK, supported by analysis of the rate or rates claimed, and the ENGINEER-IN-CHARGE shall determine the rate or rates on the basis of the prevailing market rates, labour cost at schedule of labour rates plus 10% to cover contractor's supervision, overheads and profit and pay the CONTRACTOR accordingly. The opinion of the ENGINEER-IN-CHARGE as to current market rates of materials and the quantum of labour involved per unit of measurement will be final and binding on the CONTRACTOR.

- 60.3 If, the executed contract value decreases by more than 10% of the original contract value and vendor/contractor request for reduction in Contract Performance Security (CPS)/ Security Deposit (SD) the same is allowed after certification of EIC. In case the CPS/SD is submitted in form of DD or online transfer or deducted from payment CPS/SD amount in excess of required CPS/SD is to be released/returned to contractor/ vendor. In case Contract Performance Security (CPS) is submitted in the form of Bank Guarantee/FDR/ Insurance Surety Bond the Vendor/ Contractor can reduce the Bank Guarantee/FDR/ Insurance Surety Bond and submit amended Bank Guarantee/FDR/ Insurance Surety Bond accordingly. TFL will provide the necessary communication for the same to issuing bank/Insurance company if

Date of Issue: 9th March'23



**COMPOSITE SUPPLY CUM ERECTION OF
ELECTRICAL & INSTRUMENTATION WORKS FOR
OSBL FACILITIES ON ITEM RATE BASIS
AT
TALCHER FERTILIZERS LIMITED, ANGUL, ODISHA
GENERAL CONDITION OF CONTRACT**

PC-183/ E-8003/ S-IV

0

DOC. NO.

REV.



Page 38 of 68

required. Alternatively Vendor/ Contractor has option to submit the new Bank Guarantee/FDR/ Insurance Surety Bond of requisite value and upon receipt & confirmation of same the earlier Bank Guarantee/FDR/ Insurance Surety Bond can be returned.

61 Drawings to be supplied by the employer

- 61.1 The drawings attached with tender are only for the general guidance to the CONTRACTOR to enable him to visualize the type of work contemplated and scope of work involved. The CONTRACTOR will be deemed to have studied the DRAWINGS and formed an idea about the WORK involved.
- 61.2 Detailed working drawings on the basis of which actual execution of the WORK is to proceed, will be furnished from time to time during the progress of the work. The CONTRACTOR shall be deemed to have gone through the DRAWINGS supplied to him thoroughly and carefully and in conjunction with all other connected drawings and bring to the notice of the ENGINEER-IN-CHARGE discrepancies, if any, therein before actually carrying out the Work.
- 61.3 Copies of all detailed working drawings relating to the WORK shall be kept at the CONTRACTOR's office on the site and shall be made available to the ENGINEER-IN-CHARGE at any time during the CONTRACT. The drawings and other documents issued by the EMPLOYER shall be returned to the EMPLOYER on completion of the WORK.

62 Drawings to be supplied by the contractor:

- 62.1 The drawings/date which are to be furnished by the CONTRACTOR are enumerated in the special conditions of contract, and shall be furnished within the specified time.
- 62.2 Where approval/review of drawings before manufacture/ construction/fabrication has been specified, it shall be CONTRACTOR's responsibility to have these drawings prepared as per the directions of ENGINEER-IN-CHARGE and got approved before proceeding with manufacture/construction/fabrication as the case may be. Any change that may have become necessary in these drawings during the execution of the work shall have to be carried out by the CONTRACTOR to the satisfaction of ENGINEER-IN-CHARGE at no extra cost. All final drawings shall bear the certification stamp as indicated below duly signed by both the CONTRACTOR and ENGINEER-IN-CHARGE.

"Certified true for _____ (Name of Work)

Agreement No. _____

Signed: _____
(CONTRACTOR) (ENGINEER-IN-CHARGE)

- 62.3 The DRAWINGS submitted by the CONTRACTOR shall be reviewed by the ENGINEER-IN-CHARGE as far as practicable within 3 (Three) weeks and shall be modified by the CONTRACTOR, if any modifications and/or corrections are required by the ENGINEER-IN-CHARGE. The CONTRACTOR shall incorporate such modifications and/or corrections and submit the final drawings for approval. Any delays arising out of failure by the CONTRACTOR to rectify the drawing in good time shall not alter the Contract Completion Time.

- 62.4 As built drawings showing all corrections, adjustments etc. shall be furnished by the CONTRACTOR in six copies and one transparent for record purposed to the EMPLOYER.

63 Setting out works:

- 63.1 The ENGINEER-IN-CHARGE shall furnish the CONTRACTOR with only the four corners of the Works site and a level bench mark and the CONTRACTOR

Date of Issue: 9th March'23



**COMPOSITE SUPPLY CUM ERECTION OF
ELECTRICAL & INSTRUMENTATION WORKS FOR
OSBL FACILITIES ON ITEM RATE BASIS
AT
TALCHER FERTILIZERS LIMITED, ANGUL, ODISHA
GENERAL CONDITION OF CONTRACT**

PC-183/ E-8003/ S-IV

0

DOC. NO.

REV.



Page 39 of 68

shall set out the Works and shall provide an efficient staff for the purpose and shall be solely responsible for the accuracy of such setting out.

- 63.2 The CONTRACTOR shall provide, fix and be responsible for the maintenance of all stakes, templates, level marks, profiles and other similar things and shall take all necessary precautions to prevent their removal or disturbance and shall be responsible for the consequence of such removal or disturbance should the same take place and for their efficient and timely reinstatement. The CONTRACTOR shall also be responsible for the maintenance of all existing survey marks, boundary marks, distance marks and center line marks, either existing or supplied and fixed by the CONTRACTOR. The work shall be set out to the satisfaction of the ENGINEER-IN-CHARGE. The approval there of joining with the CONTRACTOR by the ENGINEER- IN-CHARGE in setting out the work, shall not relieve the CONTRACTOR of any of his responsibility.
- 63.3 Before beginning the Works, the CONTRACTOR shall at his own cost, provide all necessary reference and level posts, pegs, bamboos, flags, ranging rods, strings and other materials for proper layout of the works in accordance with the schemes for bearing marks acceptable to the ENGINEER-IN-CHARGE. The center, longitudinal or face lines and cross lines shall be marked by means of small masonry pillars. Each pillar shall have distinct mark at the centre to enable theodolite to be set over it. No work shall be started until all these points are checked and approved by the ENGINEER-IN-CHARGE in writing but such approval shall not relieve the CONTRACTOR of any of his responsibilities. The CONTRACTOR shall also provide all labour, material and other facilities, as necessary, for the proper checking of layout and inspection of the points during construction.
- 63.4 Pillars bearing geodetic marks located at the sites of units of WORKS under construction should be protected and fenced by the CONTRACTOR.
- 63.5 On completion of WORK, the CONTRACTOR must submit the geodetic documents according to which the WORK was carried out.
- 64 Responsibility for level and alignment:**
- 64.1 The CONTRACTOR shall be entirely and exclusively responsible for the horizontal and vertical alignment, the levels and correctness of every part of the WORK and shall rectify effectively any errors or imperfections therein, such rectifications shall be carried out by the CONTRACTOR, at his own cost, when instructions are issued to that effect by the ENGINEER- IN-CHARGE.
- 65 Materials to be supplied by contractor:**
- 65.1 The CONTRACTOR shall procure and provide within the VALUE OF CONTRACT the whole of the materials required for the construction including steels, cement and other building materials, tools, tackles, construction plant and equipment for the completion and maintenance of the WORK except the materials which will be issued by the EMPLOYER and shall make his own arrangement for procuring such materials and for the transport thereof. The EMPLOYER may give necessary recommendation to the respective authority if so desired by the CONTRACTOR but assumes no further responsibility of any nature. The EMPLOYER will insist on the procurement of materials which bear ISI stamp and/or which are supplied by reputed suppliers.
- 65.2 The CONTRACTOR shall properly store all materials either issued to him or brought by him to the SITE to prevent damages due to rain, wind, direct exposure to sun, etc. as also from theft, pilferage, etc. for proper and speedy execution of his works. The CONTRACTOR shall maintain sufficient stocks of all materials required by him.
- 65.3 No material shall be dispatched from the CONTRACTOR's stores before

Date of Issue: 9th March'23



**COMPOSITE SUPPLY CUM ERECTION OF
ELECTRICAL & INSTRUMENTATION WORKS FOR
OSBL FACILITIES ON ITEM RATE BASIS
AT
TALCHER FERTILIZERS LIMITED, ANGUL, ODISHA
GENERAL CONDITION OF CONTRACT**

PC-183/ E-8003/ S-IV

0

DOC. NO.

REV.



Page 40 of 68

obtaining the approval in writing of the ENGINEER-IN-CHARGE.

66 Stores supplied by the employer:

(Clause not applicable for this Tender)

66.1 If the SPECIFICATION of the WORK provides for the use of any material of special description to be supplied from the EMPLOYER's stores or it is required that the CONTRACTOR shall use certain stores to be provided by the ENGINEER-IN-CHARGE, such materials and stores, and price to be charged there for as hereinafter mentioned being so far as practicable for the convenience of the CONTRACTOR, but not so as in any way to control the meaning or effect of the CONTRACT, the CONTRACTOR shall be bound to purchase and shall be supplied such materials and stores as are from time to time required to be used by him for the purpose of the CONTRACT only. The sums due from the CONTRACTOR for the value of materials supplied by the EMPLOYER will be recovered from the running account bill on the basis of the actual consumption of materials in the works covered and for which the running account bill has been prepared. After the completion of the WORK, however, the CONTRACTOR has to account for the full quantity of materials supplied to him as per relevant clauses in this document.

66.2 The value of the stores/materials as may be supplied to the CONTRACTOR by the EMPLOYER will be debited to the CONTRACTOR's account at the rates shown in the schedule of materials and if they are not entered in the schedule, they will be debited at cost price, which for the purpose of the CONTRACT shall include the cost of carriage and all other expenses whatsoever such as normal storage supervision charges which shall have been incurred in obtaining the same at the EMPLOYER's stores. All materials so supplied to the CONTRACTOR shall remain the absolute property of the EMPLOYER and shall not be removed on any account from the SITE of the WORK, and shall be at all times open for inspection to the ENGINEER-IN-CHARGE. Any such materials remaining unused at the time of the completion or termination of the CONTRACT shall be returned to the EMPLOYER's stores or at a place as directed by the ENGINEER-IN-CHARGE in perfectly good condition at CONTRACTOR's cost.

67 Conditions for issue of materials:

(Clause not applicable for this Tender)

- 67.1
- i) Materials specified as to be issued by the EMPLOYER will be supplied to the CONTRACTOR by the EMPLOYER from his stores. It shall be responsibility of the CONTRACTOR to take delivery of the materials and arrange for its loading, transport and unloading at the SITE of WORK at his own cost. The materials shall be issued between the working hours and as per the rules of the EMPLOYER as framed from time to time.
 - ii) The CONTRACTOR shall bear all incidental charges for the storage and safe custody of materials at site after these have been issued to him.
 - iii) Materials specified as to be issued by the EMPLOYER shall be issued in standard sizes as obtained from the manufacturers.
 - iv) The CONTRACTOR shall construct suitable Godowns at the SITE of WORK for storing the materials safe against damage by rain, dampness, fire, theft etc. He shall also employ necessary watch and ward establishment for the purpose.
 - v) It shall be duty of the CONTRACTOR to inspect the materials supplied to him at the time of taking delivery and satisfy himself that they are in good condition. After the materials have been delivered by the EMPLOYER, it shall be the responsibility of the CONTRACTOR to keep them in good condition and if the materials are damaged or lost, at any time, they shall be repaired and/or replaced by him at his own cost according to the instructions of the ENGINEER-IN-CHARGE.

Date of Issue: 9th March'23



**COMPOSITE SUPPLY CUM ERECTION OF
ELECTRICAL & INSTRUMENTATION WORKS FOR
OSBL FACILITIES ON ITEM RATE BASIS
AT
TALCHER FERTILIZERS LIMITED, ANGUL, ODISHA
GENERAL CONDITION OF CONTRACT**

PC-183/ E-8003/ S-IV

0

DOC. NO.

REV.



Page 41 of 68

- vi) The EMPLOYER shall not be liable for delay in supply or non-supply of any materials which the EMPLOYER has undertaken to supply where such failure or delay is due to natural calamities, act of enemies, transport and procurement difficulties and any circumstances beyond the control of the EMPLOYER. In no case, the CONTRACTOR shall be entitled to claim any compensation or loss suffered by him on this account.
- vii) It shall be responsibility of the CONTRACTOR to arrange in time all materials required for the WORK other than those to be supplied by the EMPLOYER. If, however, in the opinion of the ENGINEER-IN-CHARGE the execution of the WORK is likely to be delayed due to the CONTRACTOR's inability to make arrangements for supply of materials which normally he has to arrange for, the ENGINEER-IN-CHARGE shall have the right at his own discretion to issue such materials, if available with the EMPLOYER or procure the materials from the market or as elsewhere and the CONTRACTOR will be bound to take such materials at the rates decided by the ENGINEER-IN-CHARGE. This, however, does not in any way absolve the CONTRACTOR from responsibility of making arrangements for the supply of such materials in part or in full, should such a situation occur nor shall this constitute a reason for the delay in the execution of the WORK.
- viii) None of the materials supplied to the CONTRACTOR will be utilized by the CONTRACTOR for manufacturing item which can be obtained as supplied from standard manufacturer in finished form.
- ix) The CONTRACTOR shall, if desired by the ENGINEER-IN-CHARGE, be required to execute an Indemnity Bond in the prescribed form for safe custody and accounting of all materials issued by the EMPLOYER.
- x) The CONTRACTOR shall furnish to the ENGINEER-IN-CHARGE sufficiently in advance a statement showing his requirement of the quantities of the materials to be supplied by the EMPLOYER and the time when the same will be required by him for the works, so as to enable the ENGINEER-IN-CHARGE to make necessary arrangements for procurement and supply of the material.
- xi) Account of the materials issued by the EMPLOYER shall be maintained by CONTRACTOR indicating the daily receipt, consumption and balance in hand. This account shall be maintained in a manner prescribed by the ENGINEER-IN-CHARGE along with all connected papers viz. requisitions, issues, etc., and shall be always available for inspection in the CONTRACTOR's office at SITE.
- xii) The CONTRACTOR should see that only the required quantities of materials are got issued. The CONTRACTOR shall not be entitled to cartage and incidental charges for returning the surplus materials, if any, to the stores wherefrom they were issued or to the place as directed by the ENGINEER-IN-CHARGE.
- xiii) Materials/ Equipment(s) supplied by EMPLOYER shall not be utilized for any purpose(s) than issued for.



**COMPOSITE SUPPLY CUM ERECTION OF
ELECTRICAL & INSTRUMENTATION WORKS FOR
OSBL FACILITIES ON ITEM RATE BASIS
AT
TALCHER FERTILIZERS LIMITED, ANGUL, ODISHA
GENERAL CONDITION OF CONTRACT**

PC-183/ E-8003/ S-IV

0

DOC. NO.

REV.



Page 42 of 68

**assistance of employer/
return of surplus:**

*(Clause not applicable for this
Tender)*

CONTRACT where any materials for the execution of the CONTRACT are procured with the assistance of the EMPLOYER either by issue from EMPLOYER's stock or purchases made under order or permits or licenses issued by Government, the CONTRACTOR shall hold the said materials as trustee for the EMPLOYER and use such materials economically and solely for the purpose of the CONTRACT and not dispose them off without the permission of the EMPLOYER and return, if required by the ENGINEER-IN-CHARGE, shall determine having due regard to the condition of the materials. The price allowed to the CONTRACTOR, however, shall not exceed the amount charged to him excluding the storage charges, if any. The decision of the ENGINEER-IN-CHARGE shall be final and conclusive in such matters. In the event of breach of the aforesaid condition, the CONTRACTOR shall, in terms of the licenses or permits and/or criminal breach of trust, be liable to compensate the EMPLOYER at double rate or any higher rate, in the event of those materials at that time having higher rate or not being available in the market, then any other rate to be determined by the ENGINEER-IN-CHARGE and his decision shall be final and conclusive.

- | | | |
|--|------|--|
| 69 Materials obtained from dismantling: | 69.1 | If the CONTRACTOR in the course of execution of the WORK is called upon to dismantle any part for reasons other than those stipulated in Clauses 74 and 77 hereunder, the materials obtained in the WORK of dismantling etc., will be considered as the EMPLOYER's property and will be disposed off to the best advantage of the EMPLOYER. |
| 70 Articles of value found: | 70.1 | All gold, silver and other minerals of any description and all precious stones, coins, treasure relics, antiquities and other similar things which shall be found in, under or upon the SITE, shall be the property of the EMPLOYER and the CONTRACTOR shall duly preserve the same to the satisfaction of the ENGINEER-IN-CHARGE and shall from time to time deliver the same to such person or persons indicated by the EMPLOYER. |
| 71 Discrepancies between instructions: | 71.1 | Should any discrepancy occur between the various instructions furnished to the CONTRACTOR, his agent or staff or any doubt arises as to the meaning of any such instructions or should there be any misunderstanding between the CONTRACTOR's staff and the ENGINEER-IN-CHARGE's staff, the CONTRACTOR shall refer the matter immediately in writing to the ENGINEER-IN-CHARGE whose decision thereon shall be final and conclusive and no claim for losses alleged to have been caused by such discrepancies between instructions, doubts, or misunderstanding shall in any event be admissible. |
| 72 Action where no specification is issued: | 72.1 | In case of any class of WORK for which there is no SPECIFICATION supplied by the EMPLOYER as mentioned in the Tender Documents such WORK shall be carried out in accordance with Indian Standard Specifications and if the Indian Standard Specifications do not cover the same, the WORK should be carried out as per standard Engineering Practice subject to the approval of the ENGINEER-IN-CHARGE. |
| 73 Inspection of works: | 73.1 | The ENGINEER-IN-CHARGE will have full power and authority to inspect the WORK at any time wherever in progress either on the SITE or at the CONTRACTOR's premises/workshops wherever situated, premises/ workshops of any person, firm or corporation where WORK in connection with the CONTRACT may be in hand or where materials are being or are to be supplied, and the CONTRACTOR shall afford or procure for the ENGINEER-IN-CHARGE every facility and assistance to carry out such inspection. The CONTRACTOR shall, at all time during the usual working hours and at all other time at which reasonable notice of the intention of the ENGINEER-IN-CHARGE or his representative to visit the WORK shall have been given to the CONTRACTOR, either himself be present or receive orders and instructions, or |

Date of Issue: 9th March'23



**COMPOSITE SUPPLY CUM ERECTION OF
ELECTRICAL & INSTRUMENTATION WORKS FOR
OSBL FACILITIES ON ITEM RATE BASIS
AT
TALCHER FERTILIZERS LIMITED, ANGUL, ODISHA
GENERAL CONDITION OF CONTRACT**

PC-183/ E-8003/ S-IV

0

DOC. NO.

REV.



Page 43 of 68

have a responsible agent duly accredited in writing, present for the purpose. Orders given to the CONTRACTOR's agent shall be considered to have the same force as if they had been given to the CONTRACTOR himself. The CONTRACTOR shall give not less than seven days notice in writing to the ENGINEER-IN-CHARGE before covering up or otherwise placing beyond reach of inspection and measurement of any work in order that the same may be inspected and measured. In the event of breach of above the same shall be uncovered at CONTRACTOR's expense for carrying out such measurement or inspection.

73.2 No material shall be dispatched from the CONTRACTOR's stores before obtaining the approval in writing of the Engineer-in-Charge.

The CONTRACTOR is to provide at all time during the progress of the WORK and the maintenance period, proper means of access with ladders, gangways etc. and the necessary attendance to move and adopt as directed for inspection or measurements of the WORK by the ENGINEER- IN-CHARGE.

73.3 The CONTRACTOR shall make available to the ENGINEER-IN- CHARGE free of cost all necessary instruments and assistance in checking or setting out of WORK and in the checking of any WORK made by the CONTRACTOR for the purpose of setting out and taking measurements of WORK.

74 Tests for quality of work:

74.1 All workmanship shall be of the respective kinds described in the CONTRACT DOCUMENTS and in accordance with the instructions of the ENGINEER-IN-CHARGE and shall be subjected from time to time to such test at CONTRACTOR's cost as the ENGINEER-IN-CHARGE may direct at the place of manufacture or fabrication or on the site or at all or any such places. The CONTRACTOR shall provide assistance, instruments, labour and materials as are normally required for examining, measuring and testing any workmanship as may be selected and required by the ENGINEER-IN-CHARGE.

74.2 All the tests that will be necessary in connection with the execution of the WORK as decided by the ENGINEER- IN-CHARGE shall be carried out at the field testing laboratory of the EMPLOYER by paying the charges as decided by the EMPLOYER from time to time. In case of non- availability of testing facility with the EMPLOYER, the required test shall be carried out at the cost of CONTRACTOR at Government or any other testing laboratory as directed by ENGINEER-IN-CHARGE.

74.3 If any tests are required to be carried out in conjunction with the WORK or materials or workmanship not supplied by the CONTRACTOR, such tests shall be carried out by the CONTRACTOR as per instructions of ENGINEER-IN-CHARGE and cost of such tests shall be reimbursed by the EMPLOYER.

75 Samples for approval:

75.1 The CONTRACTOR shall furnish to the ENGINEER-IN-CHARGE for approval, when requested or if required by the specifications, adequate samples of all materials and finished to be used in the WORK. Such samples shall be submitted before the WORK is commenced and in ample time to permit tests and examinations thereof. All materials furnished and finishes applied in actual WORK shall be fully equal to the approved samples.

76 Action and compensation in case of bad work:

76.1 If it shall appear to the ENGINEER-IN-CHARGE that any work has been executed with unsound, imperfect or unskilled workmanship, or with materials of any inferior description, or that any materials or articles provided by the CONTRACTOR for the execution of the WORK are unsound, or of a quality inferior to that contracted for, or otherwise not in accordance with the

Date of Issue: 9th March'23



**COMPOSITE SUPPLY CUM ERECTION OF
ELECTRICAL & INSTRUMENTATION WORKS FOR
OSBL FACILITIES ON ITEM RATE BASIS
AT
TALCHER FERTILIZERS LIMITED, ANGUL, ODISHA
GENERAL CONDITION OF CONTRACT**

PC-183/ E-8003/ S-IV

0

DOC. NO.

REV.



Page 44 of 68

CONTRACT, the CONTRACTOR shall on demand in writing from the ENGINEER-IN-CHARGE or his authorized representative specifying the WORK, materials or articles complained of notwithstanding that the same may have been inadvertently passed, certified and paid for, forthwith rectify or remove and reconstruct the WORK so specified and provide other proper and suitable materials or articles at his own cost and in the event of failure to do so within the period specified by the ENGINEER-IN-CHARGE in his demand aforesaid, the CONTRACTOR shall be liable to pay compensation at the rate of 1% (One percent) of the estimated cost of the whole WORK, for every week limited to a maximum of 10% (ten percent) of the value of the whole WORK, while his failure to do so shall continue and in the case of any such failure the ENGINEER-IN-CHARGE may on expiry of notice period rectify or remove and re-execute the WORK or remove and replaced with others, the materials or articles complained of to as the case may be at the risk and expense in all respects of the CONTRACTOR. The decision of the Engineering-in-charge as to any question arising under this clause shall be final and conclusive.

- 77 Suspension of works:** 77.1 i) Subject to the provisions of sub-para (ii) of this clause, the CONTRACTOR shall, if ordered in writing by the ENGINEER-IN-CHARGE, or his representative, temporarily suspend the WORKS or any part thereof for such written order, proceed with the WORK therein ordered to be suspended until, he shall have received a written order to proceed therewith. The CONTRACTOR shall not be entitled to claim compensation for any loss or damage sustained by him by reason of temporary suspension of the WORKS aforesaid. An extension of time for completion, corresponding with the delay caused by any such suspension of the WORKS as aforesaid will be granted to the CONTRACTOR should he apply for the same provided that the suspension was not consequent to any default or failure on the part of the CONTRACTOR.
- ii) In case of suspensions of entire WORK, ordered in writing by ENGINEER-IN-CHARGE, for a period of more than two months, the CONTRACTOR shall have the option to terminate the CONTRACT.
- 78 Employer may do part of work:** 78.1 Upon failure of the CONTRACTOR to comply with any instructions given in accordance with the provisions of this CONTRACT the EMPLOYER has the alternative right, instead of assuming charge of entire WORK, to place additional labour force, tools, equipments and materials on such parts of the WORK, as the EMPLOYER may designate or also engage another CONTRACTOR to carry out the WORK. In such cases, the EMPLOYER shall deduct from the amount which otherwise might become due to the CONTRACTOR, the cost of such work and material with ten percent (10%) added to cover all departmental charges and should the total amount thereof exceed the amount due to the CONTRACTOR, the CONTRACTOR shall pay the difference to the EMPLOYER.
- 79 Possession prior to completion:** 79.1 The ENGINEER-IN-CHARGE shall have the right to take possession of or use any completed or partially completed WORK or part of the WORK. Such possession or use shall not be deemed to be an acceptance of any work completed in accordance with the CONTRACT agreement. If such prior possession or use by the ENGINEER-IN-CHARGE delays the progress of WORK, equitable adjustment in the time of completion will be made and the CONTRACT agreement shall be deemed to be modified accordingly.
- 80 (Defects liability period) twelve months period of liability from the date of completion:** 80.1 The CONTRACTOR shall guarantee the installation/WORK for a period of 12 months from the date of completion of WORK as certified by the ENGINEER-IN-CHARGE which is indicated in the Completion Certificate. Any

Date of Issue: 9th March'23



**COMPOSITE SUPPLY CUM ERECTION OF
ELECTRICAL & INSTRUMENTATION WORKS FOR
OSBL FACILITIES ON ITEM RATE BASIS
AT
TALCHER FERTILIZERS LIMITED, ANGUL, ODISHA
GENERAL CONDITION OF CONTRACT**

PC-183/ E-8003/ S-IV

0

DOC. NO.

REV.



Page 45 of 68

**issue of completion
certificate:**

damage or defect that may arise or lie undiscovered at the time of issue of Completion Certificate, connected in any way with the equipment or materials supplied by him or in the workmanship, shall be rectified or replaced by the CONTRACTOR at his own expense as deemed necessary by the ENGINEER-IN-CHARGE or in default, the ENGINEER- IN-CHARGE may carry out such works by other work and deduct actual cost incurred towards labour, supervision and materials consumables or otherwise plus 100% towards overheads (of which the certificate of ENGINEER-IN-CHARGE shall be final) from any sums that may then be or at any time thereafter, become due to the CONTRACTOR or from his Contract Performance Security, or the proceeds of sale thereof or a sufficient part on thereof.

80.2 If the CONTRACTOR feels that any variation in WORK or in quality of materials or proportions would be beneficial or necessary to fulfil the guarantees called for, he shall bring this to the notice of the ENGINEER- IN-CHARGE in writing.

If during the period of liability any portion of the WORK/equipment, is found defective and is rectified/ replaced, the period of liability for such equipment/ portion of WORK shall be operative from the date such rectification/ replacement are carried out and Contract Performance Guarantee shall be furnished separately for the extended period of liability for that portion of WORK/ equipment only. Notwithstanding the above provisions the supplier's, guarantees/warrantees for the replaced equipment shall also be passed on to the EMPLOYER.

80.3 LIMITATION OF LIABILITY

Notwithstanding anything contrary contained herein, the aggregate total liability of CONTRACTOR under the Agreement or otherwise shall be limited to 100% of Agreement / Contract Value. However, neither party shall be liable to the other party for any indirect and consequential damages, loss of profits or loss of production.

81 Care of works:

81.0 From the commencement to completion of the WORK, the CONTRACTOR shall take full responsibility for the care for all works including all temporary works and in case any damages, loss or injury shall happen to the WORK or to any part thereof or to any temporary works from any cause whatsoever, shall at his own cost repair and make good the same so that at completion the WORK shall be in good order and in conformity in every respects with the requirement of the CONTRACT and the ENGINEER-IN-CHARGE's instructions.

81.1 DEFECTS PRIOR TO TAKING OVER:

If at any time, before the WORK is taken over, the ENGINEER-IN-CHARGE shall:

- a) Decide that any works done or materials used by the CONTRACTOR or by any SUB-CONTRACTOR is defective or not in accordance with the CONTRACT, or that the works or any portion thereof are defective, or do not fulfill the requirements of CONTRACT (all such matters being hereinafter, called 'Defects' in this clause), and
- b) As soon as reasonably practicable, gives to the CONTRACTOR notice in writing of the said decision, specifying particulars of the defects alleged to exist or to have occurred, then the CONTRACTOR shall at his own expenses and with all speed make good the defects so specified.

In case CONTRACTOR shall fail to do so, the EMPLOYER may take, at the cost of the CONTRACTOR, such steps as may in all circumstances, be reasonable to

Date of Issue: 9th March'23



**COMPOSITE SUPPLY CUM ERECTION OF
ELECTRICAL & INSTRUMENTATION WORKS FOR
OSBL FACILITIES ON ITEM RATE BASIS
AT
TALCHER FERTILIZERS LIMITED, ANGUL, ODISHA
GENERAL CONDITION OF CONTRACT**

PC-183/ E-8003/ S-IV

0

DOC. NO.

REV.



Page 46 of 68

make good such defects. The expenditure so incurred by the EMPLOYER will be recovered from the amount due to the CONTRACTOR. The decision of the ENGINEER-IN-CHARGE with regard to the amount to be recovered from the CONTRACTOR will be final and binding on the CONTRACTOR. As soon as the WORK has been completed in accordance with the CONTRACT (except in minor respects that do not affect their use for the purpose for which they are intended and except for maintenance there of provided in clause 80.1 of General Conditions of Contract) and have passed the tests on completion, the ENGINEER-IN-CHARGE shall issue a certificate (hereinafter called Completion Certificate) in which he shall certify the date on which the WORK have been so completed and have passed the said tests and the EMPLOYER shall be deemed to have taken over the WORK on the date so certified. If the WORK has been divided into various groups in the CONTRACT, the EMPLOYER shall be entitled to take over any group or groups before the other or others and there upon the ENGINEER-IN-CHARGE shall issue a Completion Certificate which will, however, be for such group or groups so taken over only. In such an event if the group /section/ part so taken over is related, to the integrated system of the work, not withstanding date of grant of Completion Certificate for group/ section/ part. The period of liability in respect of such group/ section/ part shall extend 12 (twelve) months from the date of completion of WORK.

81.2 DEFECTS AFTER TAKING OVER:

In order that the CONTRACTOR could obtain a COMPLETION CERTIFICATE he shall make good, with all possible speed, any defect arising from the defective materials supplied by the CONTRACTOR or workmanship or any act or omission of the CONTRACTOR or that may have been noticed or developed, after the works or groups of the works has been taken over, the period allowed for carrying out such WORK will be normally one month. If any defect be not remedied within a reasonable time, the EMPLOYER may proceed to do the WORK at CONTRACTOR's risk and expense and deduct from the final bill such amount as may be decided by the EMPLOYER.

If by reason of any default on the part of the CONTRACTOR a COMPLETION CERTIFICATE has not been issued in respect of any portion of the WORK within one month after the date fixed by the CONTRACT for the completion of the WORK, the EMPLOYER shall be at liberty to use the WORK or any portion thereof in respect of which a completion certificate has not been issued, provided that the WORK or the portion thereof so used as aforesaid shall be afforded reasonable opportunity for completing these works for the issue of Completion Certificate.

82 **Guarantee/transfer of guarantee:**

82.1

For works like water-proofing, acid and alkali resisting materials, pre-construction soil treatment against termite or any other specialized works etc. the CONTRACTOR shall invariably engage SUB-CONTRACTORS who are specialists in the field and firms of repute and such a SUB-CONTRACTOR shall furnish guarantees for their workmanship to the EMPLOYER, through the CONTRACTOR. In case such a SUB-CONTRACTOR/ firm is not prepared to furnish a guarantee to the EMPLOYER, the CONTRACTOR shall give that guarantee to the EMPLOYER directly.

83 **Training of employer's personnel:**

83.1

The CONTRACTOR undertakes to provide training to Engineering personnel selected and sent by the EMPLOYER at the works of the CONTRACTOR without any cost to the EMPLOYER. The period and the nature of training for the individual personnel shall be agreed upon mutually between the CONTRACTOR and the EMPLOYER. These engineering personnel shall be given special training at the shops, where the equipment will be manufactured and/ or in their

(Clause not applicable)

Date of Issue: 9th March'23



**COMPOSITE SUPPLY CUM ERECTION OF
ELECTRICAL & INSTRUMENTATION WORKS FOR
OSBL FACILITIES ON ITEM RATE BASIS
AT
TALCHER FERTILIZERS LIMITED, ANGUL, ODISHA
GENERAL CONDITION OF CONTRACT**

PC-183/ E-8003/ S-IV

0

DOC. NO.

REV.



Page 47 of 68

collaborator's works and where possible, in any other plant where equipment manufactured by the CONTRACTOR or his collaborators is under installation or test to enable those personnel to become familiar with the equipment being furnished by the CONTRACTOR. EMPLOYER shall bear only the to and fro fare of the said engineering personnel.

84 Replacement of defective parts and materials:

84.1 If during the progress of the WORK, EMPLOYER shall decide and inform in writing to the CONTRACTOR, that the CONTRACTOR has manufactured any plant or part of the plant unsound or imperfect or has furnished plant inferior to the quality specified, the CONTRACTOR on receiving details of such defects or deficiencies shall at his own expenses within 7 (seven) days of his receiving the notice, or otherwise within such time as may be reasonably necessary for making it good, proceed to alter, re-construct or remove such work and furnish fresh equipments up to the standards of the specifications. In case the CONTRACTOR fails to do so, EMPLOYER may on giving the CONTRACTOR 7 (seven) day's notice in writing of his intentions to do so, proceed to remove the portion of the WORK so complained of and at the cost of CONTRACTOR's, perform all such works or furnish all such equipments provided that nothing in the clause shall be deemed to deprive the EMPLOYER of or affect any rights under the CONTRACT, the EMPLOYER may otherwise have in respect of such defects and deficiencies.

84.2 The CONTRACTOR's full and extreme liability under this clause shall be satisfied by the payments to the EMPLOYER of the extra cost, of such replacements procured including erection/installation as provided for in the CONTRACT; such extra cost being the ascertained difference between the price paid by the EMPLOYER for such replacements and the CONTRACT price portion for such defective plants and repayments of any sum paid by the EMPLOYER to the CONTRACTOR in respect of such defective plant. Should the EMPLOYER not so replace the defective plant the CONTRACTOR's extreme liability under this clause shall be limited to the repayment of all such sums paid by the EMPLOYER under the CONTRACT for such defective plant.

85 Indemnity

85.1 If any action is brought before a Court, Tribunal or any other Authority against the Employer or an officer or agent of the EMPLOYER, for the failure, omission or neglect on the part of the CONTRACTOR to perform any acts, matters, covenants or things under the CONTRACT, or damage or injury caused by the alleged omission or negligence on the part of the CONTRACTOR, his agents, representatives or his SUB- CONTRACTOR's, or in connection with any claim based on lawful demands of SUB-CONTRACTOR's workmen suppliers or employees, the CONTRACTOR, shall in such cases indemnify and keep the EMPLOYER and/or their representatives harmless from all losses, damages, expenses or decrees arising out of such action.

86 Construction aids, equipments, tools & tackles:

86.1 CONTRACTOR shall be solely responsible for making available for executing the WORK, all requisite CONSTRUCTION EQUIPMENTS, Special Aids, Barges, Cranes and the like, all Tools, Tackles and Testing Equipment and Appliances, including imports of such equipment etc. as required. In case of import of the same the rates applicable for levying of Custom Duty on such Equipment, Tools, & Tackles and the duty drawback applicable thereon shall be ascertained by the CONTRACTOR from the concerned authorities of Government of India. It shall be clearly understood that EMPLOYER shall not in any way be responsible for arranging to obtain Custom Clearance and/or payment of any duties and/or duty draw backs etc. for such equipments so imported by the CONTRACTOR and the CONTRACTOR shall be fully responsible for all taxes, duties and documentation with regard to the same. Tenderer in his own interest may contact, for any clarifications in the matter, concerned agencies/Dept./Ministries of Govt. of India. All clarifications so obtained and

Date of Issue: 9th March'23



**COMPOSITE SUPPLY CUM ERECTION OF
ELECTRICAL & INSTRUMENTATION WORKS FOR
OSBL FACILITIES ON ITEM RATE BASIS
AT
TALCHER FERTILIZERS LIMITED, ANGUL, ODISHA
GENERAL CONDITION OF CONTRACT**

PC-183/ E-8003/ S-IV

0

DOC. NO.

REV.



Page 48 of 68

interpretations thereof shall be solely the responsibility of the CONTRACTOR.

SECTION-VI Certificates and Payments

87 Schedule of rates and payments:

87.1 i) CONTRACTOR'S REMUNERATION:

The price to be paid by the EMPLOYER to CONTRACTOR for the whole of the WORK to be done and for the performance of all the obligations undertaken by the CONTRACTOR under the CONTRACT DOCUMENTS shall be ascertained by the application of the respective Schedule of Rates (the inclusive nature of which is more particularly defined by way of application but not of limitation, with the succeeding sub-clause of this clause) and payment to be made accordingly for the WORK actually executed and approved by the ENGINEER-IN-CHARGE. The sum so ascertained shall (excepting only as and to the extent expressly provided herein) constitute the sole and inclusive remuneration of the CONTRACTOR under the CONTRACT and no further or other payment whatsoever shall be or become due or payable to the CONTRACTOR under the CONTRACT.

ii) SCHEDULE OF RATES TO BE INCLUSIVE:

The prices/rates quoted by the CONTRACTOR shall remain firm till the issue of FINAL CERTIFICATE and shall not be subject to escalation. Schedule of Rates shall be deemed to include and cover all costs, expenses and liabilities of every description and all risks of every kind to be taken in executing, completing and handing over the WORK to the EMPLOYER by the CONTRACTOR. The CONTRACTOR shall be deemed to have known the nature, scope, magnitude and the extent of the WORK and materials required though the CONTRACT DOCUMENT may not fully and precisely furnish them. Tenderer's shall make such provision in the Schedule of Rates as he may consider necessary to cover the cost of such items of WORK and materials as may be reasonable and necessary to complete the WORK. The opinion of the ENGINEER-IN-CHARGE as to the items of WORK which are necessary and reasonable for COMPLETION OF WORK shall be final and binding on the CONTRACTOR, although the same may not be shown on or described specifically in CONTRACT DOCUMENTS.

Generality of this present provision shall not be deemed to cut down or limit in any way because in certain cases it may and in other cases it may not be expressly stated that the CONTRACTOR shall do or perform a work or supply articles or perform services at his own cost or without addition of payment or without extra charge or words to the same effect or that it may be stated or not stated that the same are included in and covered by the Schedule of Rates.

iii) SCHEDULE OF RATES TO COVER CONSTRUCTION EQUIPMENTS, MATERIALS, LABOUR ETC.:

Without in any way limiting the provisions of the preceding sub-clause the Schedule of Rates shall be deemed to include and cover the cost of all construction equipment, temporary WORK (except as provided for herein), pumps, materials, labour, insurance, fuel, consumables, stores and appliances to be supplied by the CONTRACTOR and all other matters in connection with each item in the Schedule of Rates and the execution of the WORK or any portion thereof finished, complete in

Date of Issue: 9th March'23



**COMPOSITE SUPPLY CUM ERECTION OF
ELECTRICAL & INSTRUMENTATION WORKS FOR
OSBL FACILITIES ON ITEM RATE BASIS
AT
TALCHER FERTILIZERS LIMITED, ANGUL, ODISHA
GENERAL CONDITION OF CONTRACT**

PC-183/ E-8003/ S-IV

0

DOC. NO.

REV.



Page 49 of 68

every respect and maintained as shown or described in the CONTRACT DOCUMENTS or as may be ordered in writing during the continuance of the CONTRACT.

iv) SCHEDULE OF RATES TO COVER ROYALTIES, RENTS AND CLAIMS:

The Schedule of Rates (i.e., VALUE OF CONTRACT) shall be deemed to include and cover the cost of all royalties and fees for the articles and processes, protected by letters, patent or otherwise incorporated in or used in connection with the WORK, also all royalties, rents and other payments in connection with obtaining materials of whatsoever kind for the WORK and shall include an indemnity to the EMPLOYER which the CONTRACTOR hereby gives against all actions, proceedings, claims, damages, costs and expenses arising from the incorporation in or use on the WORK of any such articles, processes or materials, octroi or other municipal or local Board Charges, if levied on materials, equipment or machineries to be brought to site for use on WORK shall be borne by the CONTRACTOR.

v) SCHEDULE OF RATES TO COVER TAXES AND DUTIES:

No exemption or reduction of Customs Duties, Excise Duties, Sales Tax, Sales Tax on works Contract quay or any port dues, transport charges, stamp duties or Central or State Government or local Body or Municipal Taxes or duties, taxes or charges (from or of any other body), whatsoever, will be granted or obtained, all of which expenses shall be deemed to be included in and covered by the Schedule or Rates. The CONTRACTOR shall also obtain and pay for all permits or other privileges necessary to complete the WORK.

vi) SCHEDULE OF RATES TO COVER RISKS OF DELAY:

The Schedule of Rates shall be deemed to include and cover the risk of all possibilities of delay and interference with the CONTRACTOR's conduct of WORK which occur from any causes including orders of the EMPLOYER in the exercise of his power and on account of extension of time granted due to various reasons and for all other possible or probable causes of delay.

vii) SCHEDULE OF RATES CANNOT BE ALTERED:

For WORK under unit rate basis, no alteration will be allowed in the Schedule of Rates by reason of works or any part of them being modified, altered, extended, diminished or committed. The Schedule of Rates are fully inclusive of rates which have been fixed by the CONTRACTOR and agreed to by the EMPLOYER and cannot be altered.

For lumpsum CONTRACTS, the payment will be made according to the WORK actually carried out, for which purpose an item wise, or work wise Schedule of Rates shall be furnished, suitable for evaluating the value of WORK done and preparing running account bill.

Payment for any additional work which is not covered in the Schedule of Rates, shall only be released on issuance of change order.



**COMPOSITE SUPPLY CUM ERECTION OF
ELECTRICAL & INSTRUMENTATION WORKS FOR
OSBL FACILITIES ON ITEM RATE BASIS
AT
TALCHER FERTILIZERS LIMITED, ANGUL, ODISHA
GENERAL CONDITION OF CONTRACT**

PC-183/ E-8003/ S-IV

0

DOC. NO.

REV.



Page 50 of 68

**and billing of work in
progress:**

Following procedures shall be adopted for billing of works executed by the CONTRACTOR.

88.1.1 All measurements shall be recorded in sixuplicate on standard measurement sheets supplied by EMPLOYER and submitted to EMPLOYER/CONSULTANT for scrutiny and passing.

88.1.2 EMPLOYER/CONSULTANT shall scrutinize and check the measurements recorded on the sheets and shall certify correctness of the same on the measurement sheets.

88.1.3 ENGINEER-IN-CHARGE shall pass the bills after carrying out the comprehensive checks in accordance with the terms and conditions of the CONTRACTS, within 7 days of submission of the bills, complete in all respects and send the same to the Employer to effect payment to the CONTRACTOR.

88.1.4 TFL shall make all Endeavour to make payments of undisputed amount of the bills submitted based on the joint measurements within 15 (Fifteen) days from the date of certification by the Engineer-in-Charge.

88.1.5 Measurements shall be recorded as per the methods of measurement spelt out in EMPLOYER/CONSULTANT SPECIFICATIONS / CONTRACT DOCUMENT. EMPLOYER/CONSULTANT shall be fully responsible for checking the measurements quantitatively and qualitatively as recorded in the Measurement Books/ Bills.

88.1.6 While preparing the final bills overall measurements will not be taken again. Only volume of work executed since the last measured bill along with summary of final measurements will be considered for the final bill. However, a detailed check shall be made as to missing measurements and in case there are any missing items or measurements the same shall be recorded.

88.2 SECURED ADVANCE ON MATERIAL:

Unless otherwise provided elsewhere in the tender, no 'Secured Advance' on security of materials brought to site for execution of contracted items(s) shall be paid to the Contractor whatsoever.

88.3 DISPUTE IN MODE OF MEASUREMENT:

In case of any dispute as to the mode of measurement not covered by the CONTRACT to be adopted for any item of WORK, mode of measurement as per latest Indian Standard Specifications shall be followed.

88.4 ROUNDING OF AMOUNTS:

In calculating the amount of each item due to the CONTRACTOR in every certificate prepared for payment, sum of less than 50 paise shall be omitted and the total amount on each certificate shall be rounded off to the nearest rupees, i.e., sum of less than 50 paise shall be omitted and sums of 50 paise and more upto one rupee shall be reckoned as one rupee.

89 Lumpsum in tender:

89.1 The payment against any Lumpsum item shall be made only on completion of that item as per the provision of the CONTRACT after certification by ENGINEER-IN-CHARGE.

90 Running account payments

90.1 All running account payments shall be regarded as payment by way of advance

Date of Issue: 9th March'23



**COMPOSITE SUPPLY CUM ERECTION OF
ELECTRICAL & INSTRUMENTATION WORKS FOR
OSBL FACILITIES ON ITEM RATE BASIS
AT
TALCHER FERTILIZERS LIMITED, ANGUL, ODISHA
GENERAL CONDITION OF CONTRACT**

PC-183/ E-8003/ S-IV

0

DOC. NO.

REV.



Page 51 of 68

to be regarded as advance:

against the final payment only and not as payments for WORK actually done and completed and shall not preclude the requiring of bad, unsound and imperfect or unskilled work to be removed and taken away and reconstructed or re-erected or be considered as an admission of the due performance of the CONTRACT, or any part thereof, in this respect, or of the accruing of any claim by the CONTRACTOR, nor shall it conclude, determine or affect in any way the powers of the EMPLOYER under these conditions or any of them as to the final settlement and adjustment of the accounts or otherwise, or in any other way vary or affect the CONTRACT. The final bill shall be submitted by the CONTRACTOR within one month of the date of physical completion of the WORK, otherwise, the ENGINEER-IN-CHARGE's certificate of the measurement and of total amount payable for the WORK accordingly shall be final and binding on all parties

**91 Notice of claims for
additional payments:**

91.1

Should the CONTRACTOR consider that he is entitled to any extra payment for any extra/additional WORKS or MATERIAL change in original SPECIFICATIONS carried out by him in respect of WORK he shall forthwith give notice in writing to the ENGINEER-IN-CHARGE that he claims extra payment. Such notice shall be given to the ENGINEER-IN-CHARGE upon which CONTRACTOR bases such claims and such notice shall contain full particulars of the nature of such claim with full details of amount claimed. Irrespective of any provision in the CONTRACT to the contrary, the CONTRACTOR must intimate his intention to lodge claim on the EMPLOYER within 10 (ten) days of the commencement of happening of the event and quantify the claim within 30 (thirty) days, failing which the CONTRACTOR will lose his right to claim any compensation/reimbursement/damages etc. or refer the matter to arbitration. Failure on the part of CONTRACTOR to put forward any claim without the necessary particulars as above within the time above specified shall be an absolute waiver thereof. No omission by EMPLOYER to reject any such claim and no delay in dealing therewith shall be waiver by EMPLOYER of any of this rights in respect thereof.

91.2

ENGINEER-IN-CHARGE shall review such claims within a reasonably period of time and cause to discharge these in a manner considered appropriate after due deliberations thereon. However, CONTRACTOR shall be obliged to carry on with the WORK during the period in which his claims are under consideration by the EMPLOYER, irrespective of the outcome of such claims, where additional payments for WORKS considered extra are justifiable in accordance with the CONTRACT provisions, EMPLOYER shall arrange to release the same in the same manner as for normal WORK payments. Such of the extra works so admitted by EMPLOYER shall be governed by all the terms, conditions, stipulations and specifications as are applicable for the CONTRACT. The rates for extra works shall generally be the unit rates provided for in the CONTRACT. In the event unit rates for extra works so executed are not available as per CONTRACT, payments may either be released on day work basis for which daily/hourly rates for workmen and hourly rates for equipment rental shall apply, or on the unit rate for WORK executed shall be derived by interpolation/extrapolation of unit rates already existing in the CONTRACT. In all the matters pertaining to applicability of rate and admittance of otherwise of an extra work claim of CONTRACTOR the decision of ENGINEER-IN-CHARGE shall be final and binding.

92 Payment of contractor's bill:

92.1

No payment shall be made for works estimated to cost less than Rs.10,000/- till the whole of the work shall have been completed and a certificate of completion given. But in case of works estimated to cost more than Rs.10,000/-, that CONTRACTOR on submitting the bill thereof be entitled to receive a monthly payment proportionate to the part thereof approved and passed by the

Date of Issue: 9th March'23



**COMPOSITE SUPPLY CUM ERECTION OF
ELECTRICAL & INSTRUMENTATION WORKS FOR
OSBL FACILITIES ON ITEM RATE BASIS
AT
TALCHER FERTILIZERS LIMITED, ANGUL, ODISHA
GENERAL CONDITION OF CONTRACT**

PC-183/ E-8003/ S-IV

0

DOC. NO.

REV.



Page 52 of 68

ENGINEER-IN-CHARGE, whose certificate of such approval and passing of the sum so payable shall be final and conclusive against the CONTRACTOR. This payment will be made after making necessary corrections/deductions as stipulated elsewhere in the CONTRACT DOCUMENT for materials, Contract Performance Security, taxes etc.

92.2 Payment due to the CONTRACTOR shall be made by the EMPLOYER by Account Payee cheque forwarding the same to registered office or the notified office of the CONTRACTOR. In no case will EMPLOYER be responsible if the cheque is mislaid or misappropriated by unauthorized person/persons. In all cases, the CONTRACTOR shall present his bill duly pre-receipted on proper revenue stamp payment shall be made in Indian Currency.

92.3 In general payment of final bill shall be made to CONTRACTOR within 60 days of the submission of bill on joint measurements, after completion of all the obligations under the CONTRACT.

93 Receipt for payment:

93.1 Receipt for payment made on account of work when executed by a firm, must be signed by a person holding due power of attorney in this respect on behalf of the CONTRACTOR, except when the CONTRACTOR's are described in their tender as a limited company in which case the receipts must be signed in the name of the company by one of its principal officers or by some other person having authority to give effectual receipt for the company.

94 Completion certificate:

94.1 APPLICATION FOR COMPLETION CERTIFICATE:

When the CONTRACTOR fulfils his obligation under Clause 81.1 he shall be eligible to apply for COMPLETION CERTIFICATE.

The ENGINEER-IN-CHARGE shall normally issue to the CONTRACTOR the COMPLETION CERTIFICATE within one month after receiving any application therefore from the CONTRACTOR after verifying from the completion documents and satisfying himself that the WORK has been completed in accordance with and as set out in the construction and erection drawings, and the CONTRACT DOCUMENTS.

The CONTRACTOR, after obtaining the COMPLETION CERTIFICATE, is eligible to present the final bill for the WORK executed by him under the terms of CONTRACT.

94.2 COMPLETION CERTIFICATE:

Within one month of the completion of the WORK in all respects, the CONTRACTOR shall be furnished with a certificate by the ENGINEER-IN-CHARGE of such completion, but no certificate shall be given nor shall the WORK be deemed to have been executed until all scaffolding, surplus materials and rubbish is cleared off the SITE completely nor until the WORK shall have been measured by the ENGINEER-IN-CHARGE whose measurement shall be binding and conclusive. The WORKS will not be considered as complete and taken over by the EMPLOYER, until all the temporary works, labour and staff colonies are cleared to the satisfaction of the ENGINEER-IN-CHARGE.

If the CONTRACTOR fails to comply with the requirements of this clause on or before the date fixed for the completion of the WORK, the ENGINEER-IN-CHARGE may at the expense of the CONTRACTOR remove such scaffolding, surplus materials and rubbish and dispose off the same as he thinks fit and clean off such dirt as aforesaid, and the CONTRACTOR shall

Date of Issue: 9th March'23



**COMPOSITE SUPPLY CUM ERECTION OF
ELECTRICAL & INSTRUMENTATION WORKS FOR
OSBL FACILITIES ON ITEM RATE BASIS
AT
TALCHER FERTILIZERS LIMITED, ANGUL, ODISHA
GENERAL CONDITION OF CONTRACT**

PC-183/ E-8003/ S-IV

0

DOC. NO.

REV.



Page 53 of 68

forthwith pay the amount of all expenses so incurred and shall have no claim in respect of any such scaffolding or surplus materials as aforesaid except for any sum actually realized by the sale thereof.

94.3 COMPLETION CERTIFICATE DOCUMENTS:

For the purpose of Clause 94.0 the following documents will be deemed to form the completion documents:

- i) The technical documents according to which the WORK was carried out.
- ii) Six (6) sets of construction drawings showing therein the modification and correction made during the course of execution and signed by the ENGINEER-IN-CHARGE.
- iii) COMPLETION CERTIFICATE for 'embedded' and 'covered' up work.
- iv) Certificates of final levels as set out for various works.
- v) Certificates of tests performed for various WORKS.
- vi) Material appropriation, Statement for the materials issued by the EMPLOYER for the WORK and list of surplus materials returned to the EMPLOYER's store duly supported by necessary documents.

95 Final decision and final certificate:

95.1 Upon expiry of the period of liability and subject to the ENGINEER-IN-CHARGE being satisfied that the WORKS have been duly maintained by the CONTRACTOR during monsoon or such period as hereinbefore provided in Clause 80 & 81 and that the CONTRACTOR has in all respect duly made-up any subsidence and performed all his obligations under the CONTRACT, the ENGINEER-IN- CHARGE shall (without prejudice to the rights of the EMPLOYER to retain the provisions of relevant Clause hereof) otherwise give a certificate herein referred to as the FINAL CERTIFICATE to that effect and the CONTRACTOR shall not be considered to have fulfilled the whole of his obligations under CONTRACT until FINAL CERTIFICATE shall have been given by the ENGINEER-IN- CHARGE notwithstanding any previous entry upon the WORK and taking possession, working or using of the same or any part thereof by the EMPLOYER.

96 Certificate and payments on evidence of completion:

96.1 Except the FINAL CERTIFICATE, no other certificates or payments against a certificate or on general account shall be taken to be an admission by the EMPLOYER of the due performance of the CONTRACT or any part thereof or of occupancy or validity of any claim by the CONTRACTOR.

97 Deductions from the contract price:

97.1 All costs, damages or expenses which EMPLOYER may have paid or incurred, which under the provisions of the CONTRACT, the CONTRACTOR is liable/will be liable, will be claimed by the EMPLOYER. All such claims shall be billed by the EMPLOYER to the CONTRACTOR regularly as and when they fall due. Such claims shall be paid by the CONTRACTOR within 15 (fifteen) days of the receipt of the corresponding bills and if not paid by the CONTRACTOR within the said period, the EMPLOYER may, then, deduct the amount from any moneys due i.e., Contract Performance Security or becoming due to the CONTRACTOR under the CONTRACT or may be recovered by actions of law or otherwise, if the CONTRACTOR fails to satisfy the EMPLOYER of such claims.

Date of Issue: 9th March'23



**COMPOSITE SUPPLY CUM ERECTION OF
ELECTRICAL & INSTRUMENTATION WORKS FOR
OSBL FACILITIES ON ITEM RATE BASIS
AT
TALCHER FERTILIZERS LIMITED, ANGUL, ODISHA
GENERAL CONDITION OF CONTRACT**

PC-183/ E-8003/ S-IV

0

DOC. NO.

REV.



Page 54 of 68

SECTION-VII Taxes and Insurance

- 98 Taxes, Duties, Octroi etc:** 98.1 The CONTRACTOR agrees to and does hereby accept full and exclusive liability for the payment of any and all Taxes, Duties, including Excise duty, octroi etc. now or hereafter imposed, increased, modified, all the sales taxes, duties, octrois etc. now in force and hereafter increased, imposed or modified, from time to time in respect of WORKS and materials and all contributions and taxes for unemployment compensation, insurance and old age pensions or annuities now or hereafter imposed by any Central or State Government authorities which are imposed with respect to or covered by the wages, salaries, or other compensations paid to the persons employed by the CONTRACTOR and the CONTRACTOR shall be responsible for the compliance of all SUB-CONTRACTORS, with all applicable Central, State, Municipal and local law and regulation and requirement of any Central, State or local Government agency or authority. CONTRACTOR further agrees to defend, indemnify and hold EMPLOYER harmless from any liability or penalty which may be imposed by the Central, State or Local authorities by reason or any violation by CONTRACTOR or SUB-CONTRACTOR of such laws, suits or proceedings that may be brought against the EMPLOYER arising under, growing out of, or by reason of the work provided for by this CONTRACT, by third parties, or by Central or State Government authority or any administrative sub-division thereof.

Tax deductions will be made as per the rules and regulations in force in accordance with acts prevailing from time to time.

- 99 Sales tax/turnover tax:** 99.1 Tenderer should quote all inclusive prices including the liability of Sales Tax/Turnover Tax whether on the works contract as a whole or in respect of bought out components used by the CONTRACTOR in execution of the CONTRACT. EMPLOYER shall not be responsible for any such liability of the CONTRACTOR in respect of this CONTRACT.

- 100 Statutory variations** 100.1 Tenderer should quote prices inclusive of excise-duty and sales tax applicable on finished product. Any statutory variations in Excise Duty and sales tax on finished product during the contractual completion period, shall be to the Employer's account for which the Contractor will furnish documentary evidence(s) in support of their claims to TFL. However, any increase in the rate of these taxes and duties (E.D. and S.T.) beyond the contractual completion period shall be to Contractor's account and any decrease shall be passed on to TFL.

- 101 Insurance:** 101.1 GENERAL

CONTRACTOR shall at his own expense arrange secure and maintain insurance with reputable insurance companies to the satisfaction of the EMPLOYER as follows:

CONTRACTOR at his cost shall arrange, secure and maintain insurance as may be necessary and to its full value for all such amounts to protect the WORKS in progress from time to time and the interest of EMPLOYER against all risks as detailed herein. The form and the limit of such insurance, as defined here in together with the under works thereof in each case should be as acceptable to the EMPLOYER. However, irrespective of work acceptance the responsibility to maintain adequate insurance coverage at all times during the period of CONTRACT shall be that of CONTRACTOR alone. CONTRACTOR's failure in this regard shall not relieve him of any of his responsibilities and obligations under CONTRACT.

Any loss or damage to the equipment, during ocean transportation, port/custom

Date of Issue: 9th March'23



**COMPOSITE SUPPLY CUM ERECTION OF
ELECTRICAL & INSTRUMENTATION WORKS FOR
OSBL FACILITIES ON ITEM RATE BASIS
AT
TALCHER FERTILIZERS LIMITED, ANGUL, ODISHA
GENERAL CONDITION OF CONTRACT**

PC-183/ E-8003/ S-IV

0

DOC. NO.

REV.



Page 55 of 68

clearance, inland and port handling, inland transportation, storage, erection and commissioning till such time the WORK is taken over by EMPLOYER, shall be to the account of CONTRACTOR. CONTRACTOR shall be responsible for preferring of all claims and make good for the damage or loss by way of repairs and/or replacement of the parts of the Work damaged or lost. CONTRACTOR shall provide the EMPLOYER with a copy of all insurance policies and documents taken out by him in pursuance of the CONTRACT. Such copies of document shall be submitted to the EMPLOYER immediately upon the CONTRACTOR having taken such insurance coverage. CONTRACTOR shall also inform the EMPLOYER at least 60(Sixty) days in advance regarding the expiry cancellation and/or changes in any of such documents and ensure revalidation/renewal etc., as may be necessary well in time.

Statutory clearances, if any, in respect of foreign supply required for the purpose of replacement of equipment lost in transit and/or during erection, shall be made available by the EMPLOYER. CONTRACTOR shall, however, be responsible for obtaining requisite licenses, port clearances and other formalities relating to such import. The risks that are to be covered under the insurance shall include, but not be limited to the loss or damage in handling, transit, theft, pilferage, riot, civil commotion, weather conditions, accidents of all kinds, fire, war risk (during ocean transportation only) etc. The scope of such insurance shall cover the entire value of supplies of equipments, plants and materials to be imported from time to time.

All costs on account of insurance liabilities covered under CONTRACT will be to CONTRACTOR's account and will be included in VALUE OF CONTRACT. However, the EMPLOYER may from time to time, during the currency of the CONTRACT, ask the CONTRACTOR in writing to limit the insurance coverage risk and in such a case, the parties to the CONTRACT will agree for a mutual settlement, for reduction in VALUE OF CONTRACT to the extent of reduced premium amounts.

CONTRACTOR as far as possible shall cover insurance with Indian Insurance Companies, including marine Insurance during ocean transportation.

i) EMPLOYEES STATE INSURANCE ACT:

The CONTRACTOR agrees to and does hereby accept full and exclusive liability for the compliance with all obligations imposed by the Employee State Insurance Act 1948 and the CONTRACTOR further agrees to defend, indemnify and hold EMPLOYER harmless for any liability or penalty which may be imposed by the Central, State or Local authority by reason of any asserted violation by CONTRACTOR or SUB-CONTRACTOR of the Employees' State Insurance Act, 1948, and also from all claims, suits or proceeding that may be brought against the EMPLOYER arising under, growing out of or by reasons of the work provided for by this CONTRACTOR, by third parties or by Central or State Government authority or any political sub- division thereof.

The CONTRACTOR agrees to fill in with the Employee's State Insurance Corporation, the Declaration Forms, and all forms which may be required in respect of the CONTRACTOR's or SUB-CONTRACTOR's employees, who are employed in the WORK provided for or those covered by ESI from time to time under the Agreement. The CONTRACTOR shall deduct and secure the agreement of the SUB- CONTRACTOR to deduct the employee's contribution as per the first schedule of the Employee's State Insurance Act from wages and affix the Employees Contribution Card at wages payment intervals. The CONTRACTOR shall remit and secure the

Date of Issue: 9th March'23



**COMPOSITE SUPPLY CUM ERECTION OF
ELECTRICAL & INSTRUMENTATION WORKS FOR
OSBL FACILITIES ON ITEM RATE BASIS
AT
TALCHER FERTILIZERS LIMITED, ANGUL, ODISHA
GENERAL CONDITION OF CONTRACT**

PC-183/ E-8003/ S-IV

0

DOC. NO.

REV.



Page 56 of 68

agreement of SUB-CONTRACTOR to remit to the State Bank of India, Employee's State Insurance Corporation Account, the Employee's contribution as required by the Act. The CONTRACTOR agrees to maintain all cards and Records as required under the Act in respect of employees and payments and the CONTRACTOR shall secure the agreement of the SUB- CONTRACTOR to maintain such records. Any expenses incurred for the contributions, making contributions or maintaining records shall be to the CONTRACTOR's or SUB-CONTRACTOR's account.

The EMPLOYER shall retain such sum as may be necessary from the total VALUE OF CONTRACT until the CONTRACTOR shall furnish satisfactory proof that all contributions as required by the Employees State Insurance Act, 1948, have been paid. This will be pending on the CONTRACTOR when the ESI Act is extended to the place of work.

ii) WORKMEN COMPENSATION AND EMPLOYER'S LIABILITY INSURANCE:

Insurance shall be effected for all the CONTRACTOR's employees engaged in the performance of this CONTRACT. If any of the work is sublet, the CONTRACTOR shall require the SUB-CONTRACTOR to provide workman's Compensation and employer's liability insurance for the later's employees if such employees are not covered under the CONTRACTOR's Insurance.

iii) ACCIDENT OR INJURY TO WORKMEN:

The EMPLOYER shall not be liable for or in respect of any damages or compensation payable at law in respect or in consequence of any accident or injury to any workman or other person in the Employment of the CONTRACTOR or any SUB-CONTRACTOR save and except an accident or injury resulting from any act or default of the EMPLOYER, his agents or servants and the CONTRACTOR shall indemnify and keep indemnified the EMPLOYER against all such damages and compensation (save and except and aforesaid) and against all claims, demands, proceeding, costs, charges and expenses, whatsoever in respect or in relation thereto.

iv) TRANSIT INSURANCE

In respect of all items to be transported by the CONTRACTOR to the SITE of WORK, the cost of transit insurance should be borne by the CONTRACTOR and the quoted price shall be inclusive of this cost.

v) COMPREHENSIVE AUTOMOBILE INSURANCE

This insurance shall be in such a form as to protect the Contractor against all claims for injuries, disability, disease and death to members of public including EMPLOYER's men and damage to the property of others arising from the use of motor vehicles during on or off the 'site' operations, irrespective of the Employership of such vehicles.

VI) COMPREHENSIVE GENERAL LIABILITY INSURANCE

a) This insurance shall protect the Contractor against all claims

Date of Issue: 9th March'23



**COMPOSITE SUPPLY CUM ERECTION OF
ELECTRICAL & INSTRUMENTATION WORKS FOR
OSBL FACILITIES ON ITEM RATE BASIS
AT
TALCHER FERTILIZERS LIMITED, ANGUL, ODISHA
GENERAL CONDITION OF CONTRACT**

PC-183/ E-8003/ S-IV

0

DOC. NO.

REV.



Page 57 of 68

arising from injuries, disabilities, disease or death of member of public or damage to property of others due to any act or omission on the part of the Contractor, his agents, his employees, his representatives and Sub-Contractor's or from riots, strikes and civil commotion.

- b) Contractor shall take suitable Group Personal Accident Insurance Cover for taking care of injury, damage or any other risks in respect of his Engineers and other Supervisory staff who are not covered under Employees State Insurance Act.
- c) The policy shall cover third party liability. The third party (liability shall cover the loss/ disablement of human life (person not belonging to the Contractor) and also cover the risk of damage to others materials/ equipment/ properties during construction, erection and commissioning at site. The value of third party liability for compensation for loss of human life or partial/full disablement shall be of required statutory value but not less than Rs. 2 lakhs per death, Rs. 1.5 lakhs per full disablement and Rs. 1 lakh per partial disablement and shall nevertheless cover such compensation as may be awarded by Court by Law in India and cover for damage to others equipment/ property as approved by the Purchaser. However, third party risk shall be maximum to Rs. 10(ten) lakhs to death.
- d) The Contractor shall also arrange suitable insurance to cover damage, loss, accidents, risks etc., in respect of all his plant, equipments and machinery, erection tools & tackles and all other temporary attachments brought by him at site to execute the work.
- e) The Contractor shall take out insurance policy in the joint name of EMPLOYER and Contractor from one or more nationalized insurance company from any branch office at Project site.
- f) Any such insurance requirements as are hereby established as the minimum policies and coverage which Contractor must secure and keep in force must be complied with, Contractor shall at all times be free to obtain additional or increased coverage at Contractor's sole expenses.

vii) ANY OTHER INSURANCE REQUIRED UNDER LAW OR REGULATIONS OR BY EMPLOYER:

CONTRACTOR shall also carry and maintain any and all other insurance(s) which he may be required under any law or regulation from time to time without any extra cost to EMPLOYER. He shall also carry and maintain any other insurance which may be required by the EMPLOYER.

102 Damage to Property or to any Person or any Third Party

102.1 i)

CONTRACTOR shall be responsible for making good to the satisfaction of the EMPLOYER any loss or any damage to structures and properties belonging to the EMPLOYER or being executed or procured or being procured by the EMPLOYER or of other agencies within in the premises of all the work of the EMPLOYER, if such loss or damage is due to fault and/or the negligence or willful acts or

Date of Issue: 9th March'23



**COMPOSITE SUPPLY CUM ERECTION OF
ELECTRICAL & INSTRUMENTATION WORKS FOR
OSBL FACILITIES ON ITEM RATE BASIS
AT
TALCHER FERTILIZERS LIMITED, ANGUL, ODISHA
GENERAL CONDITION OF CONTRACT**

PC-183/ E-8003/ S-IV

0

DOC. NO.

REV.



Page 58 of 68

omission of the CONTRACTOR, his employees, agents, representatives or SUB-CONTRACTORS.

- ii) The CONTRACTOR shall take sufficient care in moving his plants, equipments and materials from one place to another so that they do not cause any damage to any person or to the property of the EMPLOYER or any third party including overhead and underground cables and in the event of any damage resulting to the property of the EMPLOYER or of a third party during the movement of the aforesaid plant, equipment or materials the cost of such damages including eventual loss of production, operation or services in any plant or establishment as estimated by the EMPLOYER or ascertained or demanded by the third party shall be borne by the CONTRACTOR. Third party liability risk shall be Rupees One lakh for single accident and limited to Rupees Ten lakhs.
- iii) The CONTRACTOR shall indemnify and keep the EMPLOYER harmless of all claims for damages to property other than EMPLOYER's property arising under or by reason of this agreement, if such claims result from the fault and/or negligence or willful acts or omission of the CONTRACTOR, his employees, agents, representative of SUB-CONTRACTOR.

SECTION-VIII Labour Laws

103 Labour laws:

- 103.1 i) No labour below the age of 18 (eighteen) years shall be employed on the WORK.
- ii) The CONTRACTOR shall not pay less than what is provided under law to labourers engaged by him on the WORK.
- iii) The CONTRACTOR shall at his expense comply with all labour laws and keep the EMPLOYER indemnified in respect thereof.
- iv) The CONTRACTOR shall pay equal wages for men and women in accordance with applicable labour laws.
- v) If the CONTRACTOR is covered under the Contract labour (Regulation and Abolition) Act, he shall obtain a licence from licensing authority (i.e. office of the labour commissioner) by payment of necessary prescribed fee and the deposit, if any, before starting the WORK under the CONTRACT. Such fee/deposit shall be borne by the CONTRACTOR.
- vi) The CONTRACTOR shall employ labour in sufficient numbers either directly or through SUB- CONTRACTOR's to maintain the required rate of progress and of quality to ensure workmanship of the degree specified in the CONTRACT and to the satisfaction of the ENGINEER-IN-CHARGE.
- vii) The CONTRACTOR shall furnish to the ENGINEER-IN- CHARGE the distribution return of the number and description, by trades of the work people employed on the works. The CONTRACTOR shall also submit on the 4th and 19th of every month to the ENGINEER-IN-CHARGE a true statement showing in respect of the second half of the preceding month and the first half of the current month (1) the accidents that occurred during the said fortnight showing

Date of Issue: 9th March'23



**COMPOSITE SUPPLY CUM ERECTION OF
ELECTRICAL & INSTRUMENTATION WORKS FOR
OSBL FACILITIES ON ITEM RATE BASIS
AT
TALCHER FERTILIZERS LIMITED, ANGUL, ODISHA
GENERAL CONDITION OF CONTRACT**

PC-183/ E-8003/ S-IV

0

DOC. NO.

REV.



Page 59 of 68

the circumstances under which they happened and the extent of damage and injury caused by them and (2) the number of female workers who have been allowed Maternity Benefit as provided in the Maternity Benefit Act 1961 on Rules made there under and the amount paid to them.

- viii) The CONTRACTOR shall comply with the provisions of the payment of Wage Act 1936, Employee Provident Fund Act 1952, Minimum Wages Act 1948. Employers Liability Act 1938. Workmen's Compensation Act 1923, Industrial Disputes Act 1947, the Maternity Benefit Act 1961 and Contract Labour Regulation and Abolition Act 1970, Employment of Children Act 1938 or any modifications thereof or any other law relating thereto and rules made there under from time to time.
- ix) The ENGINEER-IN-CHARGE shall on a report having been made by an Inspecting Officer as defined in Contract Labour (Regulation and Abolition) Act 1970 have the power to deduct from the money due to the CONTRACTOR any sum required or estimated to be required for making good the loss suffered by a worker or workers by reason of non-fulfillment of the Conditions of the Contract for the benefit of workers, non-payment of wages or of deductions made from his or their wages which are not justified by the terms of the Contract or non-observance of the said regulations.
- x) The CONTRACTOR shall indemnify the EMPLOYER against any payments to be made under and for the observance of the provisions of the aforesaid Acts without prejudice to his right to obtain indemnity from his SUB-CONTRACTOR's. In the event of the CONTRACTOR committing a default or breach of any of the provisions of the aforesaid Acts as amended from time to time, of furnishing any information or submitting or filling and Form/ Register/ Slip under the provisions of these Acts which is materially incorrect then on the report of the inspecting Officers, the CONTRACTOR shall without prejudice to any other liability pay to the EMPLOYER a sum not exceeding Rs.50.00 as Liquidated Damages for every default, breach or furnishing, making, submitting, filling materially incorrect statement as may be fixed by the ENGINEER-IN- CHARGE and in the event of the CONTRACTOR's default continuing in this respect, the Liquidated Damages may be enhanced to Rs.50.00 per day for each day of default subject to a maximum of one percent of the estimated cost of the WORK put to tender. The ENGINEER-IN-CHARGE shall deduct such amount from bills or Contract Performance Security of the CONTRACTOR and credit the same to the Welfare Fund constitute under these acts. The decision of the ENGINEER-IN-CHARGE in this respect shall be final and binding.

**104 Implementation of
apprentices act, 1961:**

104.1

The CONTRACTOR shall comply with the provisions of the Apprentices Act, 1961 and the Rules and Orders issued there under from time to time. If he fails to do so, his failure will be a breach of the CONTRACT and the ENGINEER-IN-CHARGE may, at his discretion, cancel the CONTRACT. The CONTRACTOR shall also be liable for any pecuniary liability arising on account of any violation by him of the provisions, of the Act.

**105 Contractor to indemnify the
employer:**

105.1 i)

The CONTRACTOR shall indemnify the EMPLOYER and every member, office and employee of the EMPLOYER, also the

Date of Issue: 9th March'23



**COMPOSITE SUPPLY CUM ERECTION OF
ELECTRICAL & INSTRUMENTATION WORKS FOR
OSBL FACILITIES ON ITEM RATE BASIS
AT
TALCHER FERTILIZERS LIMITED, ANGUL, ODISHA
GENERAL CONDITION OF CONTRACT**

PC-183/ E-8003/ S-IV

0

DOC. NO.

REV.



Page 60 of 68

ENGINEER-IN-CHARGE and his staff against all actions, proceedings, claims, demands, costs and expenses whatsoever arising out of or in connection with the matters referred to in Clause 102.0 and elsewhere and all actions, proceedings, claims, demands, costs and expenses which may be made against the EMPLOYER for or in respect of or arising out of any failure by the CONTRACTOR in the performance of his obligations under the CONTRACT DOCUMENT. The EMPLOYER shall not be liable for or in respect of or arising out of any failure by the CONTRACTOR in the performance of his obligations under the CONTRACT DOCUMENT. The EMPLOYER shall not be liable for or in respect of any demand or compensation payable by law in respect or in consequence of any accident or injury to any workmen or other person. In the employment of the CONTRACTOR or his SUB-CONTRACTOR the CONTRACTOR shall indemnify and keep indemnified the EMPLOYER against all such damages and compensations and against all claims, damages, proceedings, costs, charges and expenses whatsoever in respect thereof or in relation thereto.

ii) PAYMENT OF CLAIMS AND DAMAGES:

Should the EMPLOYER have to pay any money in respect of such claims or demands as aforesaid the amount so paid and the costs incurred by the EMPLOYER shall be charged to and paid by the CONTRACTOR and the CONTRACTOR shall not be at liberty to dispute or question the right of the EMPLOYER to make such payments notwithstanding the same, may have been made without the consent or authority or in law or otherwise to the contrary.

iii) In every case in which by virtue of the provisions of Section 12, Sub-section (i) of workmen's compensation Act, 1923 or other applicable provision of Workmen Compensation Act or any other Act, the EMPLOYER is obliged to pay compensation to a workman employed by the CONTRACTOR in execution of the WORK, the EMPLOYER will recover from the CONTRACTOR the amount of the compensation so paid, and without prejudice to the rights of EMPLOYER under Section 12, Sub-section (2) of the said act, EMPLOYER shall be at liberty to recover such amount or any part thereof by deducting it from the Contract Performance Security or from any sum due to the CONTRACTOR whether under this CONTRACT or otherwise. The EMPLOYER shall not be bound to contest any claim made under Section 12, Sub-section (i) of the said act, except on the written request of the CONTRACTOR and upon his giving to the EMPLOYER full security for all costs for which the EMPLOYER might become liable in consequence of contesting such claim.

**106 Health and sanitary
arrangements for workers:**

- 106.1 In respect of all labour directly or indirectly employed in the WORKS for the performance of the CONTRACTOR's part of this agreement, the CONTRACTOR shall comply with or cause to be complied with all the rules and regulations of the local sanitary and other authorities or as framed by the EMPLOYER from time to time for the protection of health and sanitary arrangements for all workers.
- 106.2 The CONTRACTOR shall provide in the labour colony all amenities such as electricity, water and other sanitary and health arrangements. The CONTRACTOR shall also provide necessary surface transportation to the place of work and back to the colony for their personnel accommodated in the labour colony.

Date of Issue: 9th March'23



**COMPOSITE SUPPLY CUM ERECTION OF
ELECTRICAL & INSTRUMENTATION WORKS FOR
OSBL FACILITIES ON ITEM RATE BASIS
AT
TALCHER FERTILIZERS LIMITED, ANGUL, ODISHA
GENERAL CONDITION OF CONTRACT**

PC-183/ E-8003/ S-IV

0

DOC. NO.

REV.



Page 61 of 68

SECTION-IX Applicable Laws and Settlement of Disputes

107 Arbitration:

107.1 Unless otherwise specified, the matters where decision of the Engineer-in-Charge is deemed to be final and binding as provided in the Agreement and the issues/disputes which cannot be mutually resolved within a reasonable time, all disputes shall be referred to arbitration by Sole Arbitrator.

The Employer [Talcher Fertilizers Ltd.] shall suggest a panel of three independent and distinguished persons to the bidder/contractor/supplier/buyer (as the case may be) to select any one among them to act as the Sole Arbitrator.

In the event of failure of the other parties to select the Sole Arbitrator within 30 days from the receipt of the communication suggesting the panel of arbitrators, the right of selection of the sole arbitrator by the other party shall stand forfeited and the EMPLOYER (TFL) shall have discretion to proceed with the appointment of the Sole Arbitrator. The decision of Employer on the appointment of the sole arbitrator shall be final and binding on the parties.

The award of sole arbitrator shall be final and binding on the parties and unless directed/awarded otherwise by the sole arbitrator, the cost of arbitration proceedings shall be shared equally by the parties. The Arbitration proceedings shall be in English language and venue shall be New Delhi, India.

Subject to the above, the provisions of (Indian) Arbitration & Conciliation ACT 1996 and the Rules framed there under shall be applicable. All matter relating to this contract are subject to the exclusive jurisdiction of the court situated in the state of Delhi.

Bidders/suppliers/contractors may please note that the Arbitration & Conciliation Act 1996 was enacted by the Indian Parliament and is based on United Nations Commission on International Trade Law (UNCITRAL model law), which were prepared after extensive consultation with Arbitral Institutions and centers of International Commercial Arbitration. The United Nations General Assembly vide resolution 31/98 adopted the UNCITRAL Arbitration rules on 15 December 1976.

107.2 FOR THE SETTLEMENT OF DISPUTES BETWEEN GOVERNMENT DEPARTMENT AND ANOTHER AND ONE GOVERNMENT DEPARTMENT AND PUBLIC ENTERPRISE AND ONE PUBLIC ENTERPRISE AND ANOTHER THE ARBITRATION SHALL BE AS FOLLOWS:

"In the event of any dispute or difference between the parties hereto, such dispute or difference shall be resolved amicably by mutual consultation or through the good offices of empowered agencies of the Government. If such resolution is not possible, then, the unresolved dispute or difference shall be referred to arbitration of an arbitrator to be nominated by Secretary, Department of Legal Affairs ("Law Secretary") in terms of the Office Memorandum No.55/3/1/75-CF, dated the 19th December 1975 issued by the Cabinet Secretariat (Department of Cabinet Affairs), as modified from time to time. The Arbitration Act 1940 (10 of 1940) shall not be applicable to the arbitration under this clause. The award of the Arbitrator shall be binding upon parties to the dispute. Provided, however, any party aggrieved by such award may make a further reference for setting aside or revision of the award to Law Secretary whose decision shall bind the parties finally and conclusively.

Date of Issue: 9th March'23



**COMPOSITE SUPPLY CUM ERECTION OF
ELECTRICAL & INSTRUMENTATION WORKS FOR
OSBL FACILITIES ON ITEM RATE BASIS
AT
TALCHER FERTILIZERS LIMITED, ANGUL, ODISHA
GENERAL CONDITION OF CONTRACT**

PC-183/ E-8003/ S-IV

0

DOC. NO.

REV.



Page 62 of 68

108 Jurisdiction:

The CONTRACT shall be governed by and constructed according to the laws in force in INDIA. The CONTRACTOR hereby submits to the jurisdiction of the Courts situated at DELHI for the purposes of disputes, actions and proceedings arising out of the CONTRACT, the courts at DELHI only will have the jurisdiction to hear and decide such disputed, actions and proceedings.

SECTION-X Safety Codes

109 General:

109.1 CONTRACTOR shall adhere to safe construction practice and guard against hazardous, and unsafe working conditions and shall comply with EMPLOYER's safety rules as set forth herein. Prior to start of construction, CONTRACTOR will be furnished copies of EMPLOYER's "Safety Code" for information and guidance, if it has been prepared.

110 Safety regulations:

- 110.1 i) In respect of all labour, directly employed in the WORK for the performance of CONTRACTOR's part of this agreement, the CONTRACTOR shall at his own expense arrange for all the safety provisions as per safety codes of C.P.W.D., Indian Standards Institution. The Electricity Act, The Mines Act and such other acts as applicable.
- ii) The CONTRACTOR shall observe and abide by all fire and safety regulations of the EMPLOYER. Before starting construction work CONTRACTOR shall consult with EMPLOYER's safety Engineers or ENGINEER- IN-CHARGE and must make good to the satisfaction of the EMPLOYER any loss or damage due to fire to any portion of the work done or to be done under this agreement or to any of the EMPLOYER's existing property.

111 First aid and industrial injuries:

- 111.0 i) CONTRACTOR shall maintain first aid facilities for its employees and those of its SUB-CONTRACTOR.
- ii) CONTRACTOR shall make outside arrangements for ambulance service and for the treatment of industrial injuries. Names of those providing these services shall be furnished to EMPLOYER prior to start of construction and their telephone numbers shall be prominently posted in CONTRACTOR's field office.
- iii) All critical industrial injuries shall be reported promptly to EMPLOYER, and a copy of CONTRACTOR's report covering each personal injury requiring the attention of a physician shall be furnished to the EMPLOYER.

112 General rules:

112.0 Smoking within the battery area, tank farm or dock limits is strictly prohibited. Violators of the no smoking rules shall be discharged immediately.

113 Contractor's barricades:.

- 113.0 i) CONTRACTOR shall erect and maintain barricades required in connection with his operation to guard or protect:-
- a) Excavations
- b) Hoisting Areas.
- c) Areas adjudged hazardous by CONTRACTOR's or EMPLOYER's inspectors.

Date of Issue: 9th March'23



**COMPOSITE SUPPLY CUM ERECTION OF
ELECTRICAL & INSTRUMENTATION WORKS FOR
OSBL FACILITIES ON ITEM RATE BASIS
AT
TALCHER FERTILIZERS LIMITED, ANGUL, ODISHA
GENERAL CONDITION OF CONTRACT**

PC-183/ E-8003/ S-IV

0

DOC. NO.

REV.



Page 63 of 68

d) EMPLOYER's existing property subject to damage by CONTRACTOR's Operations.

e) Rail Road unloading spots.

ii) CONTRACTOR's employees and those of his SUB-CONTRACTOR's shall become acquainted with EMPLOYER's barricading practice and shall respect the provisions thereof.

iii) Barricades and hazardous areas adjacent to, but not located in normal routes of travel shall be marked by red flasher lanterns at nights.

114 Scaffolding:

114.1 i)

Suitable scaffolding should be provided for workmen for all works that cannot safely be done from the ground or from solid construction except such short period work as can be done safely from ladders. When a ladder is used an extra Mazdoor shall be engaged for holding the ladder and if the ladder is used for carrying material as well, suitable footholds and handholds shall be provided on the ladder and the ladder shall be given an inclination not steeper than 1 in 4 (1 horizontal and 4 vertical).

ii) Scaffolding or staging more than 4 metres above the ground or floor, swing suspended from an overhead support or erected with stationary support shall have a guard rail properly attached, bolted, braced and otherwise retarded at least one metre high above the floor or platform of such scaffolding or staging and extending along the entire length of the outside and ends thereof with only such openings as may be necessary for the delivery of materials. Such scaffolding or staging shall be so fastened as to prevent it from swaying from the building or structure.

iii) Working platform, gangway and stairway should be so constructed that they should not sag unduly or unequally and if the height of platform of the gangway or the stairway is more than 4 metres above the ground level or floor level, they should be closely boarded, should have adequate width and should be suitably fastened as in ii) above.

iv) Every opening in the floor of a building or in a working platform shall be provided with suitable means to prevent the fall of persons or materials by providing suitable fencing or railing whose minimum heights shall be 1 metre.

v) Safe-means of access shall be provided to all working platforms and other working places, every ladder shall be securely fixed. No portable single ladder shall be over 9 metres in length while the width between side rails in rung ladder shall in no case be less than 30 cms for ladder upto and including 3 metres in length. For longer ladder this width should be increased 5mm for each additional foot of length. Uniform steps spacing shall not exceed 30 cms. Adequate precautions shall be taken to prevent danger from electrical equipment. No materials on any of the sites or work shall be so stacked or placed to cause danger or inconvenience to any person or public. The CONTRACTOR shall also provide all necessary fencing and lights to protect the workers and staff from accidents, and shall be bound to bear the expenses of defense of every suit, action or other proceeding of law that may be brought by any person for injury sustained owing to neglect of the above precautions and pay any damages and costs which may be awarded in any such suit or action or proceeding to any such person or which may with the consent of the CONTRACTOR be paid to compromise any claim by

Date of Issue: 9th March'23



**COMPOSITE SUPPLY CUM ERECTION OF
ELECTRICAL & INSTRUMENTATION WORKS FOR
OSBL FACILITIES ON ITEM RATE BASIS
AT
TALCHER FERTILIZERS LIMITED, ANGUL, ODISHA
GENERAL CONDITION OF CONTRACT**

PC-183/ E-8003/ S-IV

0

DOC. NO.

REV.



Page 64 of 68

any such person.

115 Excavation and trenching: 115.1 All trenches 1.2 metres or more in depth, shall at all times be supplied with at least one ladder for each 50 metres length or fraction thereof.

Ladder shall be extended from bottom of the trenches to atleast 1 metre above the surface of the ground. The sides of the trenches which are 1.5M in depth shall be stepped back to give suitable slope or securely held by timber bracing, so as to avoid the danger of sides to collapse. The excavated materials shall not be placed within 1.5 metres of the edge of the trench or half of the trench width whichever is more. Cutting shall be done from top to bottom. Under no circumstances undermining or under-cutting shall be done.

116 Demolition/general safety: 116.1

i) Before any demolition work is commenced and also during the progress of the demolition work

a) All roads and open areas adjacent to the work site shall either be closed or suitably protected.

b) No electric cable or apparatus which is liable to be a source of danger shall remain electrically charged.

c) All practical steps shall be taken to prevent danger to persons employed from risk of fire or explosion or flooding. No floor, roof or other part of the building shall be so overloaded with debris or materials as to render it unsafe.

ii) All necessary personal safety equipment as considered adequate by the ENGINEER-IN-CHARGE, should be kept available for the use of the persons employed on the SITE and maintained in condition suitable for immediate use, and the CONTRACTOR shall take adequate steps to ensure proper use of equipment by those concerned.

a) Workers employed on mixing asphaltic materials, cement and lime mortars shall be provided with protective footwear and protective gloves.

b) Those engaged in white washing and mixing or stacking or cement bags or any material which are injurious to the eyes be provided with protective goggles.

c) Those engaged in welding and cutting works shall be provided with protective face & eye shield, hand gloves, etc.

d) Stone breakers shall be provided with protective goggles and protective clothing and seated at sufficiently safe intervals.

e) When workers are employed in sewers and manholes, which are in use, the CONTRACTOR shall ensure that the manhole covers are opened and are ventilated atleast for an hour before the workers are allowed to get into the manholes, and the manholes so opened shall be cordoned off with suitable railing and provided with warning signals or board to prevent accident to the public.

f) The CONTRACTOR shall not employ men below the age of 18 years and women on the work of painting with products

Date of Issue: 9th March'23



**COMPOSITE SUPPLY CUM ERECTION OF
ELECTRICAL & INSTRUMENTATION WORKS FOR
OSBL FACILITIES ON ITEM RATE BASIS
AT
TALCHER FERTILIZERS LIMITED, ANGUL, ODISHA
GENERAL CONDITION OF CONTRACT**

PC-183/ E-8003/ S-IV

0

DOC. NO.

REV.



Page 65 of 68

containing lead in any form. Wherever men above the age of 18 years are employed on the work of lead painting, the following precautions should be taken.

- 1) No paint containing lead or lead product shall be used except in the form of paste or readymade paint.
 - 2) Suitable face masks should be supplied for use by the workers when paint is applied in the form of spray or a surface having lead paint dry rubbed and scrapped.
 - 3) Overalls shall be supplied by the CONTRACTOR to the workmen and adequate facilities shall be provided to enable the working painters to wash them during and on cessation of work.
- iii) When the work is done near any place where there is risk of drowning, all necessary safety equipment should be provided and kept ready for use and all necessary steps taken for prompt rescue of any person in danger and adequate provision should be made for prompt first aid treatment of all injuries likely to be sustained during the course of the work.
- iv) Use of hoisting machines and tackles including their attachments, anchorage and supports shall conform to the following standards or conditions:
- a) These shall be of good mechanical construction, sound materials and adequate strength and free from patent defect and shall be kept in good working order.
 - b) Every rope used in hoisting or lowering materials or as means of suspension shall be of durable quality and adequate strength and free from patent defects.
 - c) Every crane driver or hoisting appliance operator shall be properly qualified and no person under the age of 21 years should be in charge of any hoisting machine including any scaffolding, winch or give signals to the operator.
 - d) In case of every hoisting machine and of every chain ring hook, shackle, swivel, and pulley block used in hoisting or lowering or as means of suspension, the safe working load shall be ascertained by adequate means. Every hoisting machine and all gears referred to above shall be plainly marked with the safe working load of the conditions under which it is applicable and the same shall be clearly indicated. No part of any machine or any gear referred to above in this paragraph shall be loaded beyond safe working load except for the purpose of testing.
 - e) In case of departmental machine, the safe working load shall be notified by the ENGINEER- IN-CHARGE. As regards CONTRACTOR's machines, the CONTRACTOR shall notify the safe working load of the machine to the ENGINEER-IN-CHARGE whenever he brings any machinery to SITE of WORK and get it verified by the Engineer concerned.

Date of Issue: 9th March'23



**COMPOSITE SUPPLY CUM ERECTION OF
ELECTRICAL & INSTRUMENTATION WORKS FOR
OSBL FACILITIES ON ITEM RATE BASIS
AT
TALCHER FERTILIZERS LIMITED, ANGUL, ODISHA
GENERAL CONDITION OF CONTRACT**

PC-183/ E-8003/ S-IV

0

DOC. NO.

REV.



Page 66 of 68

- v) Motors, gears, transmission lines, electric wiring and other dangerous parts of hoisting appliances should be provided with efficient safeguards. Hoisting appliances should be provided with such means as to reduce to minimum the accidental descent of the load, adequate precautions should be taken to reduce the minimum risk of any part or parts of a suspended load becoming accidentally displaced. When workers are employed on electrical installations which are already energized, insulating mats, wearing apparel, such as gloves, sleeves, and boots as may be necessary should be provided. The workers shall not wear any rings, watches and carry keys or other materials which are good conductors of electricity.
- vi) All scaffolds, ladders and other safety devices mentioned or described herein shall be maintained in safe conditions and no scaffolds, ladder or equipment shall be altered or removed while it is in use. Adequate washing facilities should be provided at or near places of work.
- vii) These safety provisions should be brought to the notice of all concerned by displaying on a notice board at a prominent place at the work-spot. The person responsible for compliance of the safety code shall be named therein by the CONTRACTOR.
- viii) To ensure effective enforcement of the rules and regulations relating to safety precautions, the arrangements made by the CONTRACTOR shall be open to inspection by the Welfare Officer, ENGINEER-IN-CHARGE or safety Engineer of the Administration or their representatives.
- ix) Notwithstanding the above clauses there is nothing in these to exempt the CONTRACTOR for the operations of any other Act or rules in force in the Republic of India. The work throughout including any temporary works shall be carried out in such a manner as not to interfere in any way whatsoever with the traffic on any roads or footpath at the site or in the vicinity thereto or any existing works whether the property of the Administration or of a third party.

In addition to the above, the CONTRACTOR shall abide by the safety code provision as per C.P.W.D. Safety code and Indian Standard Safety Code from time to time.

- 117 Care in handling inflammable gas:** 117.1 The CONTRACTOR has to ensure all precautionary measures and exercise utmost care in handling the inflammable gas cylinder/inflammable liquids/paints etc. as required under the law and/or as advised by the fire Authorities of the EMPLOYER
- 118 Temporary combustible structures:** 118.1 Temporary combustible structures will not be built near or around work site.
- 119 Precautions against fire:** 119.1 The CONTRACTOR will have to provide Fire Extinguishers, Fire Buckets and drums at worksite as recommended by ENGINEER-IN-CHARGE. They will have to ensure all precautionary measures and exercise utmost care in handling the inflammable gas cylinders/ inflammable liquid/ paints etc. as advised by ENGINEER-IN-CHARGE. Temporary combustible structures will not be built near or around the work-site.

Date of Issue: 9th March'23



**COMPOSITE SUPPLY CUM ERECTION OF
ELECTRICAL & INSTRUMENTATION WORKS FOR
OSBL FACILITIES ON ITEM RATE BASIS
AT
TALCHER FERTILIZERS LIMITED, ANGUL, ODISHA
GENERAL CONDITION OF CONTRACT**

PC-183/ E-8003/ S-IV

0

DOC. NO.

REV.



Page 67 of 68

- 120 Explosives:** 120.1 Explosives shall not be stored or used on the WORK or on the SITE by the CONTRACTOR without the permission of the ENGINEER-IN-CHARGE in writing and then only in the manner and to the extent to which such permission is given. When explosives are required for the WORK they will be stored in a special magazine to be provided at the cost of the CONTRACTOR in accordance with the Explosives Rules. The CONTRACTOR shall obtain the necessary licence for the storage and the use of explosives and all operations in which or for which explosives are employed shall be at sole risk and responsibility of the CONTRACTOR and the CONTRACTOR shall indemnify the EMPLOYER against any loss or damage resulting directly or indirectly therefrom.
- 121 Mines act:** 121.1 SAFETY CODE: The CONTRACTOR shall at his own expense arrange for the safety provisions as required by the ENGINEER-IN-CHARGE in respect of all labour directly employed for performance of the WORKS and shall provide all facilities in connection therewith. In case the CONTRACTOR fails to make arrangements and provides necessary facilities as aforesaid, the ENGINEER-IN-CHARGE shall be entitled to do so and recover the costs thereof from the CONTRACTOR.
- 121.2 Failure to comply with Safety Code or the provisions relating to report on accidents and to grant of maternity benefits to female workers shall make the CONTRACTOR liable to pay Company Liquidated Damages an amount not exceeding Rs.50/- for each default or materially incorrect statement. The decision of the ENGINEER-IN-CHARGE in such matters based on reports from the Inspecting Officer or from representatives of ENGINEER-IN-CHARGE shall be final and binding and deductions for recovery of such Liquidated Damages may be made from any amount payable to the CONTRACTOR from all the provisions of the Mines Act, 1952 or any statutory modifications or re-enactment thereof of the time being in force and any Rules and Regulations made there under in respect of all the persons employed by him under this CONTRACT and shall indemnify the EMPLOYER from and against any claim under the Mines Act or the rules and regulations framed there under by or on behalf of any persons employed by him or otherwise.
- 122 Preservation of place:** 122.1 The CONTRACTOR shall take requisite precautions and use his best endeavors to prevent any riotous or unlawful behavior by or amongst his worker and others employed or the works and for the preservation of peace and protection of the inhabitants and security of property in the neighborhood of the WORK. In the event of the EMPLOYER requiring the maintenance of a Special Police Force at or in the vicinity of the site during the tenure of works, the expenses thereof shall be borne by the CONTRACTOR and if paid by the EMPLOYER shall be recoverable from the CONTRACTOR.
- 123 Outbreak of infectious diseases:** 123.1 The CONTRACTOR shall remove from his camp such labour and their facilities who refuse protective inoculation and vaccination when called upon to do so by the ENGINEER-IN-CHARGE's representative. Should Cholera, Plague or other infectious diseases break out the CONTRACTOR shall burn the huts, beddings, clothes and other belongings or used by the infected parties and promptly erect new huts on healthy sites as required by the ENGINEER-IN-CHARGE failing which within the time specified in the Engineer's requisition, the work may be done by the EMPLOYER and the cost thereof recovered from the CONTRACTOR.
- 124 Use of intoxicants:** 124.1 The unauthorized sale of spirits or other intoxicants, beverages upon the work in any of the buildings, encampments or tenements owned, occupied by or within the control of the CONTRACTOR or any of his employee is forbidden and the CONTRACTOR shall exercise his influence and authority to the utmost extent to

Date of Issue: 9th March'23



**COMPOSITE SUPPLY CUM ERECTION OF
ELECTRICAL & INSTRUMENTATION WORKS FOR
OSBL FACILITIES ON ITEM RATE BASIS
AT
TALCHER FERTILIZERS LIMITED, ANGUL, ODISHA
GENERAL CONDITION OF CONTRACT**

PC-183/ E-8003/ S-IV

0

DOC. NO.

REV.



Page 68 of 68

secure strict compliance with this condition.

In addition to the above, the CONTRACTOR shall abide by the safety code provision as per C.P.W.D. safety code and Indian Standard Code framed from time to time.

Date of Issue: 9th March'23

 पी डी आई एल PDIL	PROJECTS & DEVELOPMENT INDIA LIMITED	PC-183/ E-8003/S-V	0	 Talcher Fertilizers
		DOC. NO.	REV.	
		Page 1 of 32		

SECTION-V

SPECIAL CONDITIONS OF CONTRACT

Date of Issue: 9th March'23







	COMPOSITE SUPPLY CUM ERECTION OF ELECTRICAL & INSTRUMENTATION WORKS FOR OSBL FACILITIES ON ITEM RATE BASIS AT TALCHER FERTILIZERS LTD., ANGUL, ODISHA SPECIAL CONDITIONS OF CONTRACT	PC-183/ E-8003/ S-V	0	
		DOC. NO.	REV	
		Page 2 of 32		

TABLE OF CONTENTS

1.0 INTRODUCTION:	4
2.0 LOCATION OF THE PROJECT SITE	4
3.0 GENERAL	4
4.0 GENERAL PROVISION WITH REGARD TO MATERIALS	5
5.0 OWNER'S OBLIGATIONS:	8
6.0 POWER & WATER FOR CONSTRUCTION AND OTHER PURPOSES	8
7.0 RATES	8
8.0 SPECIFICATIONS	9
9.0 GATE PASSES	9
10.0 TIME SCHEDULE	10
11.0 ISSUE OF WORKING DRAWINGS	10
12.0 SERVING OF NOTICES	11
13.0 NOTHING EXTRA FOR ADVERSE SUB-SOIL CONDITION	11
14.0 CONTRACTOR'S RESPONSIBILITY FOR THE MANNER OF EXECUTION OF WORK	11
15.0 NO WORK SHALL BE UNDERTAKEN WITHOUT APPROVED WORKING DRAWINGS	12
16.0 CONTRACTOR SHALL KEEP FOUNDATION PITS/TRENCHES DRY	12
17.0 NOTHING EXTRA FOR INTRICATE CONCRETE SHUTTERING OR REINFORCEMENT WORK	12
18.0 NOTHING EXTRA FOR REBATING ETC.	12
19.0 CONSTRUCTION JOINTS	12
20.0 SUBMISSION OF BILL	13
21.0 CLAIMS BY THE CONTRACTOR	14
22.0 PROVISION FOR MULTIFARIOUS CHECKING OF WORK	15
23.0 DEFECT LIABILITY PERIOD	15
24.0 CLEARING, FILLING AND LEVELING OF SITE	15
25.0 CONTRACTOR TO COMPLY ALL LAWS	15
26.0 CONTRACTOR TO USE THE MATERIALS ONLY AFTER THE APPROVAL OF OWNER	15
27.0 COMPLIANCE OF ENTIRE PROVISIONS IS OBLIGATORY TO CONTRACTOR	16
28.0 DELIVERY AND DOCUMENTS	16
29.0 WEATHER CONDITIONS	16
30.0 INSTRUCTIONS, DIRECTIONS AND CORRESPONDENCE	16
31.0 QUALITY ASSURANCE / QUALITY CONTROL	17
32.0 HEALTH SAFETY AND ENVIRONMENT (HSE) MANAGEMENT	17
33.0 SUSPENSION OF WORKS	17
34.0 INCOMING MATERIAL REPORT/ INSPECTION	18
35.0 THIRD PARTY INSPECTION	19

	COMPOSITE SUPPLY CUM ERECTION OF ELECTRICAL & INSTRUMENTATION WORKS FOR OSBL FACILITIES ON ITEM RATE BASIS AT TALCHER FERTILIZERS LTD., ANGUL, ODISHA SPECIAL CONDITIONS OF CONTRACT	PC-183/ E-8003/ S-V	0	
		DOC. NO.	REV	
		Page 3 of 32		

36.0	SECURITIES OF MATERIALS / EQUIPMENTS	19
37.0	CONTRACTOR'S PERSONNEL AT SITE:	20
38.0	SETTING OUT THE WORKS	21
39.0	COMPLIANCE WITH LABOUR/ INDUSTRIAL LAWS	21
40.0	TERMS OF PAYMENT	23
41.0	DISPATCH, TRANSPORTATION/SHIPPING	27
42.0	WORK CONTRACT SERVICES	27
43.0	CONSTRUCTION EQUIPMENT, TOOLS AND TACKLES DEPLOYMENT.....	29
44.0	BOCW (BUILDING AND OTHER CONSTRUCTION WORKS)	30
45.0	DELETED.....	30
46.0	SUB-CONTRACTOR/VENDOR AND MANUFACTURER WARRANTIES	30
47.0	CONTRACTOR's LIABILITY FOR APPROVED SUB CONTRACTOR :	31
48.0	STATUTORY VARIATION IN TAXES AND DUTIES	30

	COMPOSITE SUPPLY CUM ERECTION OF ELECTRICAL & INSTRUMENTATION WORKS FOR OSBL FACILITIES ON ITEM RATE BASIS AT TALCHER FERTILIZERS LTD., ANGUL, ODISHA SPECIAL CONDITIONS OF CONTRACT	PC-183/ E-8003/ S-V	0	
		DOC. NO.	REV	
		Page 4 of 32		

SPECIAL CONDITIONS OF CONTRACT

1.0 INTRODUCTION:

- 1.1. Talcher Fertilizers Ltd. (TFL), hereinafter also referred to as "OWNER", A joint venture company of four major Public Sector Units – M/s. Gas Authority India Limited (GAIL), M/s. Rastriya Chemicals & Fertilizers Ltd. (RCF), M/s. Coal India Ltd. (CIL) and M/s. Fertilizers Corporation of India Ltd. (FCIL) has decided to build a world class Coal based fertilizer complex. The fertilizer complex is to be built at **Talcher, Angul District, Odisha (India)** and will consist of Coal Gasification Plant, Ammonia Plant and Urea Plant, along with Offsite and Utility Plants. Talcher Fertilizers Ltd. intend to invite quotations from eligible Contractors for **COMPOSITE SUPPLY CUM ERECTION OF ELECTRICAL & INSTRUMENTATION WORKS" FOR OSBL FACILITIES ON ITEM RATE BASIS AT TALCHER FERTILIZERS LIMITED, TALCHER, ODISHA.**
- 1.2 Projects & Development India Ltd. (PDIL) has been retained as Consultant for providing Engineering Consultancy Services and Project Management Services for the aforesaid project.



2.0 LOCATION OF THE PROJECT SITE

A brief description of infrastructure at Talcher Fertilizer Plant Site is furnished below:

- The proposed project will be located within the premises of existing closed coal based Ammonia-Urea complex of FCI Ltd. Talcher Unit.
- The total land area of the site is 904.53 acres out of which lease hold land from Government of Odisha is 894.207 acres and land purchased from private parties is 10.33 acres.
- The area is not falling under coal bearing zone up to a depth of 200-250 meter.
- Talcher site is located at Vikrampur in Angul district of Odisha on the Cuttack-Sambalpur National Highway NH-42. NH-42 is passing at about 8 km from the site. The nearest railway station is Talcher at about 7 km from the site. Nearest air port Bhubaneswar is 150 km, 3 hours journey by road/ rail. Nearest sea port is Paradeep, 200 km by rail/road from the site. Talcher is situated at 21° 10" N Latitude and 82° 5" E Longitude.

3.0 GENERAL



- 3.1 Special Conditions of Contract shall be read in Conjunction with the General conditions of Contract, specification of work, Drawings and any other documents forming part of this Contract wherever the context so requires.
- 3.2 Notwithstanding the sub-division of the documents into these separate sections and volumes, every part of each shall be deemed to be supplementary to and complementary of every other part and shall be read with and into the Contract so far as it may be practicable to do so.

	COMPOSITE SUPPLY CUM ERECTION OF ELECTRICAL & INSTRUMENTATION WORKS FOR OSBL FACILITIES ON ITEM RATE BASIS AT TALCHER FERTILIZERS LTD., ANGUL, ODISHA SPECIAL CONDITIONS OF CONTRACT	PC-183/ E-8003/ S-V	0	
		DOC. NO.	REV	
		Page 5 of 32		

- 3.3 Where any portion of the General Condition of Contract is repugnant to or at variance with any provisions of the Special Conditions of Contract, unless a different intention appears, the provisions of the Special Conditions of Contract shall be deemed to override the provisions of the General Conditions of Contract and shall to the extent of such repugnancy, or variations, prevail.
- 3.4 Wherever it is mentioned in the specifications that the Contractor shall perform certain work or provide certain facilities, it is understood that the Contractor shall do so at his cost and the value of contract shall be deemed to have included cost of such performance and provisions, so mentioned.
- 3.5 The materials, design, and workmanship shall satisfy the relevant Indian Standards and CPWD specifications, the Job Specifications contained herein and Codes referred to. Where the job specification stipulate requirements in addition to those contained in the standard codes and specifications, these additional requirements shall also be satisfied.
- 3.6 It will be the Contractor's responsibility to bring to the notice of Engineer-in-Charge/Project Manager any irreconcilable conflict in the contract documents before starting the work (s) or making the supply with reference which the conflict exists.
- 3.7 In the absence of any Specifications covering any material, design of work (s) the same shall be performed / supplies / executed in accordance with Standard Engineering Practice as per the instructions / directions of the Engineer-in-Charge/Project Manager, which will be binding on the Contractor.



4.0 GENERAL PROVISION WITH REGARD TO MATERIALS

- 4.1 The CONTRACTOR shall, within the scope of work, undertake the following activities and responsibilities with respect to and in addition and without prejudice to the activities and responsibilities under Clause 4.1 and associated clauses there under in respect of materials:
- i) The CONTRACTOR shall in taking delivery, ensure compliance of any condition for delivery applicable to deliveries from the concerned authority or carrier, and shall be exclusively responsible to pay and bear any detention, demurrage or penalty or other charges payable by virtue of any delay or failure by the CONTRACTOR in lifting the materials or in observing any of the conditions aforesaid, and shall keep the OWNER indemnified from and against all consequences there of
 - ii) The CONTRACTOR shall maintain a day-to-day account of all materials indicating the daily receipt(s), consumption(s) and balance of each material and category thereof. Such account shall be in the format, if any, prescribed by the ENGINEER-IN-CHARGE and shall be supported by all documents necessary to verify the correctness of the entries in the account. Such account shall be maintained at the CONTRACTOR MANAGER's office and site(s) and shall be open for inspection and verification (by verification of documents in support of the entry as also by feasible verification of the stock) at all times by the ENGINEER-IN-CHARGE with authority at all times without obstruction to enter into or upon any godown or other place(s) or premise(s) where the materials or any part of them are lying or stored and to inspect the same

	COMPOSITE SUPPLY CUM ERECTION OF ELECTRICAL & INSTRUMENTATION WORKS FOR OSBL FACILITIES ON ITEM RATE BASIS AT TALCHER FERTILIZERS LTD., ANGUL, ODISHA SPECIAL CONDITIONS OF CONTRACT	PC-183/ E-8003/ S-V	0	
		DOC. NO.	REV	
		Page 6 of 32		

himself and or through his representative(s).

- iii) All materials shall be taken delivery of, held, stored and utilised by the CONTRACTOR as Trustee of the OWNER, and delivery of the material to the CONTRACTOR shall constitute an entrustment thereof to the CONTRACTOR, with the intent that any utilization, application or disposal thereof by the CONTRACTOR otherwise than for permanent incorporation in the contractual works in terms of the contract shall constitute a breach of trust by the CONTRACTOR.
- iv) The CONTRACTOR shall at all times be exclusively responsible for any and all losses, damages, deterioration, misuse, wastage, theft, or other application or misapplication or disposal of the materials or any of them contrary to the provisions hereof and shall keep the OWNER indemnified from and against the same and shall forthwith at its own cost and expenses replace any such material, lost, damaged, deteriorated, misused, wasted, stolen, applied, misapplied and/or disposed as aforesaid with other material of equivalent quality and quantity delivered to site at the CONTRACTOR's risks and costs in all respects.
- v) The CONTRACTOR shall take out, at his own cost and keep in force at all times, during transit, handling, storage, and erection upto completion in all respect of the work, policy (ies) with Insurance Company (ies) approved by the OWNER for the full replacement value of the materials at site against the risks specified in the CONTRACT. Such policies shall be in the joint names of the OWNER and the CONTRACTOR, with exclusive right in the OWNER to receive all monies due in respect of such policy (ies) and with right in the OWNER (but without obligation to do so) to take out and pay the premia for any such policy (ies) and deduct the premia and any other costs and expense in this behalf from the monies for the time being due or in future becoming due to the CONTRACTOR. In case of Insurance claim, the GST leviable on the transfer of the claim money from OWNER to CONTRACTOR shall be over and above the GST cap indicated in the CONTRACT and shall be borne by OWNER.
- vi) If the CONTRACTOR shall default in replacing at the job SITE, without any additional cost to the OWNER, any material lost, damaged, deteriorated, misused, wasted, short, stolen, misapplied or disposed of within the provisions hereof above, the CONTRACTOR shall be liable to pay to the OWNER the cost of such materials.
- a) Notwithstanding anything herein provided, the CONTRACTOR shall be and remain solely and exclusively liable to repair, restore or replace, as the case may be, the materials damaged or destroyed as a result of any act or omission, notwithstanding the existence or otherwise of any policy(ies) of insurance aforesaid, with the intent that any policy(ies) of insurance aforesaid taken out by the CONTRACTOR or by the OWNER, on default by the CONTRACTOR, shall not anyway absolve the CONTRACTOR from his full liability up to and until issue of the Preliminary Acceptance Certificate as provided for herein in respect of the works, the work(s) and all materials incorporated therein shall be and remain at the risks of the CONTRACTOR in all respects, including (but not limited to) accident, lightning, earth-quake, fire, storm, flood, tempest,



	COMPOSITE SUPPLY CUM ERECTION OF ELECTRICAL & INSTRUMENTATION WORKS FOR OSBL FACILITIES ON ITEM RATE BASIS AT TALCHER FERTILIZERS LTD., ANGUL, ODISHA SPECIAL CONDITIONS OF CONTRACT	PC-183/ E-8003/ S-V	0	
		DOC. NO.	REV	
		Page 7 of 32		

riot, civil commotion and/or war or otherwise with respect to the materials, but shall constitute merely an additional security and not a substitution of liability.

- b) It shall be the exclusive responsibility of the CONTRACTOR to lodge and pursue any or all claims in respect of the insurance aforesaid.
 - c) The CONTRACTOR shall, as a condition to the certification of any Running Account Bill, satisfy the OWNER/ Engineer-In-Charge of the existence of one or more policy(ies) of insurance, covering the materials as specified herein. The policy(ies) of insurance aforesaid shall cover all insurable risks, including but not limited to, any loss or damage commencing from the supplier's ware house in handling, transit, storage and during erection, theft, pilferage, riot, civil commotion, force majeure (including earth quake, flood, storm, cyclone, tidal wave, lightening and other adverse weather conditions), accidents of kinds, fire, war risks and explosion.
- vii) If the CONTRACTOR shall default in replacing at the job site, free of any cost to the OWNER, any material lost, damaged, deteriorated, misused, wasted, short, stolen, misapplied or disposed of within the provisions hereof above, the CONTRACTOR shall be liable to pay to the OWNER the cost of such materials.

4.2 SUPPLY OF MATERIALS

- 4.2.1 The CONTRACTOR shall supply the materials required to be supplied within the Contractor's scope of supply for incorporation in the permanent works in accordance with and to meet the requirements in quality, quantity and other particulars of the descriptions, specifications, plans, drawings, designs and other documents applicable thereto, and the CONTRACTOR shall be deemed to have undertaken that all materials selected, procured and supplied by the CONTRACTOR within the scope of supply shall be of the best quality and workmanship and shall be capable of producing the designed desired results and to perform the designed and desired functions to meet the contractual requirements in all respects for the project.
- 4.2.2 The CONTRACTOR shall undertake and complete the supply of materials within the scope of supply to meet the scheduled progress and requirements of the WORK within the scope of work.
- 4.2.3 All materials shall be deemed to have been accepted only when the material is received at the project SITE and accepted by the ENGINEER-IN-CHARGE. Such acceptance shall however be subject to the terms and conditions of CONTRACT, including the right of rejection and/or replacement as elsewhere herein specified.
- 4.2.4 Without prejudice to any other terms of the contract, it is clarified that the mere agreement, acceptance or prescription of a Delivery or other Schedule containing an extended time of commencement or completion in respect of the entire delivery(ies) or any of them shall not anyway constitute an extension of time in a terms of the CONTRACT so as to bind the OWNER or relieve the CONTRACTOR of all or any of his liabilities under CONTRACT, nor shall constitute a promise on behalf of the OWNER or a waiver by the OWNER of any of its rights in terms of the contract relative to the performance of the CONTRACT within the time specified or otherwise, but shall be deemed only (at the most) to be a guidance to the CONTRACTOR for better organising his work on a recognition that the CONTRACTOR has failed to organise his supplies and/or make the same within the time specified in the Delivery Schedule.

	COMPOSITE SUPPLY CUM ERECTION OF ELECTRICAL & INSTRUMENTATION WORKS FOR OSBL FACILITIES ON ITEM RATE BASIS AT TALCHER FERTILIZERS LTD., ANGUL, ODISHA SPECIAL CONDITIONS OF CONTRACT	PC-183/ E-8003/ S-V	0	
		DOC. NO.	REV	
		Page 8 of 32		

4.2.5 If the CONTRACTOR fails to supply the materials in accordance with the dates in this behalf specified in the Delivery Schedule which has an impact on the critical path of the schedule, the CONTRACTOR shall provide the OWNER with a suitable plan to recover the delay, but without prejudice to any other rights, discount or remedy available to the OWNER in respect of such delay or failure.

4.2.6 MAKE OF MATERIALS

- i) All equipment and materials to be supplied under this CONTRACT shall be from approved vendors as indicated in the Bidding Document or as otherwise approved by the PMC / OWNER.
- ii) Where the makes of materials are not indicated in the Bidding document, the CONTRACTOR shall furnish details of proposed makes and supplies and supply the same after obtaining the OWNER's/PMC approval.

5.0 OWNER'S OBLIGATIONS:

The OWNER'S obligations are limited to the following:



- a) Handing over the site in sections/ stages progressively.
- b) Approval of Construction drawings supplied by the Contractor.
- c) Payment to the contractor for performance of work under the contract as per the terms and conditions specified therein.
- d) A piece of land for setting up temporary office, Godown, etc., if available.

6.0 POWER & WATER FOR CONSTRUCTION AND OTHER PURPOSES

Availability of water & power at site is very limited. Contractor shall have to make his own arrangements for Construction work.

7.0 RATES

- 7.1 OWNER shall pay to contractor the total rates quoted by them for the due and faithful performance of contractor's obligation under the contract. The rates quoted by the contractor in SOR shall remain fixed and firm and not subject to any escalation unless and otherwise specified in the tender.
- 7.2 The rates shall be deemed to allow for all minor extras and constructional details which are not specifically shown on drawings or given in the specifications but are essential in the opinion of the Owner/ Consultant to the execution of work to conform to good workmanship and sound engineering practice. The Owner / Consultant reserve the right to make any minor changes during the execution without any extra payment.
- 7.3 The Owner / Consultant decision to classify any item 'minor changes', 'minor extras' and 'constructional details' shall be final conclusive and binding on the Contractor.
- 7.4 Rates quoted shall include for payment of royalties for obtaining earth, morrum, sand, aggregates, stones, etc. Nothing extra shall be paid to the Contractor on this account.
- 7.5 Contractor shall be responsible for making all necessary approach roads to the sites of execution for taking his rigs, cranes & equipments. No extra claim in this regard shall be entertained.

	COMPOSITE SUPPLY CUM ERECTION OF ELECTRICAL & INSTRUMENTATION WORKS FOR OSBL FACILITIES ON ITEM RATE BASIS AT TALCHER FERTILIZERS LTD., ANGUL, ODISHA SPECIAL CONDITIONS OF CONTRACT	PC-183/ E-8003/ S-V	0	
		DOC. NO.	REV	
		Page 9 of 32		

- 7.6 Schedule of rates submitted by the Tenderer shall be the true copy of the schedule of rates enclosed with the tender documents
- 7.7 The quantities and items of work given in the Schedule of Rates are tentative and approximate. The OWNER reserves the right to order variation of work during the currency of the contract of its original contract value within the stipulated variation as per clause no. 60.2 of GCC.

The quantity shown against the various items are only approximate and may vary to any extent individually or may be deleted all together, subject to conditions given in General Conditions of Contract in Bidding Document. No claim shall be entertained during currency of this Contract towards any items due to the above.



The contractor shall not be entitled to any **increase** whatsoever **on the SOR rates** on account of any variation in the quantities and/or omission/addition of items **vis-à-vis the quantities mentioned** in the “Schedule of Rates **(Section VII)**” as long as the contract value finally determined on the basis of the certified final quantities and the contract item rates is within the stipulated variation as per clause no. 60.2 of GCC.

8.0 SPECIFICATIONS

- 8.1 If specification for an item of work is not covered by CPWD/ BIS specifications or Technical Specifications, the same shall be decided by the Owner/ Consultant and shall be binding on the Contractor.
- 8.2 The Owner/ Consultant shall have the right to cause the Contractor to purchase and use such materials of particular make or from a particular source which may in his opinion be necessary for proper and reasonable compliance with the specifications and execution of work.
- 8.3 (a) As and when required by the Owner/ Consultant, the Contractor shall provide all facilities at site or at manufacture’s works or in approved laboratory for testing of materials and/or workmanship. All the expenditure in respect of this shall be borne by the Contractor. The Contractor shall, when required to do so by the Owner/Consultant, confirm that the materials have been tested in accordance with requirements of the specifications.
- (b) Neither the omission by the Owner/ Consultant to test the materials nor the production of manufacturer(s) certificate, etc. shall affect the right of the Owner/Consultant to reject, after delivery, the materials found not in accordance with the specifications.

9.0 GATE PASSES

All tools, plant and materials shall be brought by the Contractor to the works site through a covering note to be submitted in 3 copies. One copy of the covering note will be delivered to the security staff and one copy to the Owner/Consultant. The third copy shall be retained by the Contractor. The Contractor shall follow all rules and regulations for entry / exit of their men and materials in/from project site as framed by Owner/Consultant.

	COMPOSITE SUPPLY CUM ERECTION OF ELECTRICAL & INSTRUMENTATION WORKS FOR OSBL FACILITIES ON ITEM RATE BASIS AT TALCHER FERTILIZERS LTD., ANGUL, ODISHA SPECIAL CONDITIONS OF CONTRACT	PC-183/ E-8003/ S-V	0	
		DOC. NO.	REV	
		Page 10 of 32		

10.0 TIME SCHEDULE

10.1 Bidder shall be required to complete the WORK under the CONTRACT so as to achieve the GUARANTEED COMPLETION DATE in accordance with the following:

Completion Period/ Completion Schedule	14 (Fourteen) Months from date of issuance of FOA (Fax of Acceptance)
---	--

10.2 The basic consideration and essence of the Contract is the strict adherence to the Time schedules for performing the specified works as stipulated in the Contract.

10.3 If at any time, the Owner/Consultant is of opinion that the Contractor has fallen behind the approved construction schedule, the Owner/ Consultant may, without any cost to Owner/ Consultant, require the Contractor to take such steps as may be necessary to improve his progress, especially require him to employ overtime operations, increase the number of shifts, work on holidays and Sundays or increase the capacity of his construction plant and equipment and require him to submit evidence demonstrating the manner in which the Contractor proposes to comply with the construction schedule. Failure of the Contractor to comply with the above will be considered a failure to execute the work with due diligence.

10.4 Time schedule network/ bar chart.

10.4.1 Together with the Work Order/ Contract confirmation, Contractor shall submit to Owner/ Consultant, his time schedule regarding the documentation, supply of materials as well as information about of his Subcontracts to be placed with their parties, including the dates on which Contractor intends to issue such Subcontracts.

10.4.2 The time schedule will be in the form of a network or a bar chart clearly indicating all main or key events regarding documentation, supply of materials, delivery and site fabrication, erection, inspection, testing and completion.

10.4.3 The original issue and subsequent revisions of Contractor's time schedule and or Sub-contractor's time schedules shall be sent to Consultant in two copies (of which one shall be in Soft copy) and two copies to Owner.

10.4.4 The time schedule network/bar chart shall be updated at least every fortnight.

10.5 Progress Trend Chart/ Monthly Report

10.5.1 Contractor shall report weekly to Owner/ Consultant the progress of the execution of Work Order/ Contract and achievement of targets set out in time bar chart.



10.5.2 The progress will be expressed in percentages shown in the progress trend chart.

10.5.3 The first issue of the progress trend chart will be forwarded together with the time bar chart along with the Work Order confirmation.

10.5.4 The fortnightly reporting will bear the updating of the progress trend chart.

10.5.5 All reports shall be submitted through e-mail. Monthly reports to be also submitted in hard copy.

11.0 ISSUE OF WORKING DRAWINGS

	COMPOSITE SUPPLY CUM ERECTION OF ELECTRICAL & INSTRUMENTATION WORKS FOR OSBL FACILITIES ON ITEM RATE BASIS AT TALCHER FERTILIZERS LTD., ANGUL, ODISHA SPECIAL CONDITIONS OF CONTRACT	PC-183/ E-8003/ S-V	0	
		DOC. NO.	REV	
		Page 11 of 32		

All Working drawings shall be issued by the CONTRACTOR for review/approval by the OWNER/ PMC before issuance at work site. Working drawings shall be submitted by the CONTRACTOR during the period of the contract and shall be MARKED AS “Good for execution/ construction”. The same shall be having sign & stamp of the CONTRACTOR. The Contractor shall not be entitled to put forth any claim whatsoever on account of delay in getting approval of the drawings to the Owner/ Consultant, if contractor fails to incorporate the OWNERS/PMC comments timely.

Fabrication drawing, if any shall be prepared by the contractor itself and submitted to the Owner/PMC for information

12.0 SERVING OF NOTICES

The Contractor shall furnish to the Owner/ Consultant the name, designation and address of his authorized Agent for the purpose of serving of notice(s) regarding all complaints, communications and references and shall be deemed to have been duly given to the Contractor if delivered to the Contractor or his authorized agent or left at or posted to the address so given and shall be deemed to have reached such address in the ordinary course of post or on the day on which they were so delivered or left. In the case of contract by partnership firm, any change in the constitution of the firm shall be forthwith informed by the Contractor to the Owner/ Consultant.



- All correspondence from the CONTRACTOR to the OWNER shall be as per the correspondence distribution schedule. All communications including technical-commercial clarifications and/ or comments shall be addressed to OWNER/ CONSULTANT and shall always bear reference of DLOA number.
- Correspondence on technical and commercial matters shall be dealt with in separate letters and each copy of the letter shall be complete with all Annexures, if any.
- Any notice to the CONTRACTOR under the terms of the CONTRACT shall be served by registered e-mail/Speed Post, fax or courier.
- Any notice to the OWNER shall be served from the CONTRACTOR's Principal office in the same manner.
- Any written order or instruction of OWNER or his duly authorised representative, communicated to authorised representative of the CONTRACTOR at site office shall be deemed to have been communicated to the CONTRACTOR at his legal address.

13.0 NOTHING EXTRA FOR ADVERSE SUB-SOIL CONDITION

There may be variation in nature of sub-soil both horizontally and vertically. The Contractor shall have to take necessary precaution during excavation against any happening like collapsing of sides etc. Any slip or fall in excavation shall have to be cleared by the Contractor at his own cost. In case of excessive heaving, it shall have to be cut and refilled with lean concrete by the Contractor at his own cost. The Contractor shall have to adopt underwater work in case of occurrence of piping/quick conditions without any cost to Owner/Consultant.

14.0 CONTRACTOR'S RESPONSIBILITY FOR THE MANNER OF EXECUTION OF WORK

Date of Issue: 9th March'23

	COMPOSITE SUPPLY CUM ERECTION OF ELECTRICAL & INSTRUMENTATION WORKS FOR OSBL FACILITIES ON ITEM RATE BASIS AT TALCHER FERTILIZERS LTD., ANGUL, ODISHA SPECIAL CONDITIONS OF CONTRACT	PC-183/ E-8003/ S-V	0	
		DOC. NO.	REV	
		Page 12 of 32		

The Contractor shall be responsible for the manner and the method of executing the work. The work shall be subject to the approval of Owner/ Consultant from time to time for purposes of determination of the question whether the work is executed by the Contractor in accordance with the contract.

15.0 NO WORK SHALL BE UNDERTAKEN WITHOUT APPROVED WORKING DRAWINGS

No work shall be undertaken at Site by the Contractor until detailed approved working drawings are marked "Good for execution/ construction" by Owner/ Consultant. Any work done without the aforesaid approved working drawing shall be at the Contractor's own risk and costs.

16.0 CONTRACTOR SHALL KEEP FOUNDATION PITS/TRENCHES DRY

The Contractor, during the pendency of contract, shall keep in dry condition of pits, trenches, which are not yet back filled due to technical reasons, if not shall be Bail-out/Pump-out all accumulation at his own cost for the safety of the structure / element. During pumping, the Contractor shall have to ensure that 'Loss of Ground' does not occur. Other approved methods shall be undertaken by the Contractor to avoid 'Loss of Ground' if occurred, at his own cost.

17.0 NOTHING EXTRA FOR INTRICATE CONCRETE SHUTTERING OR REINFORCEMENT WORK

Nothing extra shall be paid for any intricate concrete, shuttering or reinforcement work for foundations of equipment and machinery and for other foundation/superstructure works or for any delay inherent in concreting in small and thin sections in concrete or RCC works etc.



18.0 NOTHING EXTRA FOR REBATING ETC.

Nothing extra shall be paid in concrete/RCC works for all rebating, chamfering, grooving, sinking, trotting weathering, moulding, etc. to accord with the details shown on the working drawings.

19.0 CONSTRUCTION JOINTS

19.1 In case of execution of massive concrete elements both in foundation and in superstructure and in some other locations as would be permitted except where specified in the working drawings, the work shall be carried out in one single operation without any break in concreting within time limit that would be specified by the Owner / Consultant without any additional cost to Owner/ Consultant.

19.2 All specified construction joints, either horizontal or vertical, in any element of concrete member shall be provided with shear keys of such dimensions as would be determined by the Owner/Consultant. Before adopting the next operation for the other half of the element these shear keys along with the entire surface of the joint shall be roughened and

	COMPOSITE SUPPLY CUM ERECTION OF ELECTRICAL & INSTRUMENTATION WORKS FOR OSBL FACILITIES ON ITEM RATE BASIS AT TALCHER FERTILIZERS LTD., ANGUL, ODISHA SPECIAL CONDITIONS OF CONTRACT	PC-183/ E-8003/ S-V	0	
		DOC. NO.	REV	
		Page 13 of 32		

deepened to above 20 mm by chipping, washing and cleaning thoroughly. The Contractor shall provide cement slurry in sufficient quantity over the cleaned surface for proper bond as per the direction of Owner/Consultant. The Contractor shall not be entitled to any extra/payment; on this account.

20.0 SUBMISSION OF BILL

Contractor is to submit the bills and record of measurements in three (3) copies for works executed by him.

20.1 FOR R/A BILLS:

Contractor is to submit the bills and record of measurements to EIC complete in all respect for certification by Owner/Consultant in three copies for works executed by him progressively.

20.2 MEASUREMENT OF WORKS

In addition to the provisions of relevant Clause of GCC, following shall also apply:



Measurement of work shall be made in the units mentioned in the schedule of rates. The abbreviations used in the schedule of rates are mentioned in Schedule of Rates.

The Engineer-in-Charge shall, except as otherwise stated ascertain and determine by measurement the value of Work done, in accordance with the Contract and as per actual Work done. The Engineer-in-Charge shall, when he requires any part or parts of the Works to be measured, give notices to the Contractor's authorized agent or representative who shall forthwith attend or send a qualified agent to assist the Engineer-in-Charge in making such measurement and shall furnish all particulars required by either of them. Should the Contractor not attend or neglect or omit to send such representative then the measurement made by the Engineer-in-Charge shall be taken to be the correct measurement of the Work. For all measurements, figured dimensions given in the drawings shall be followed. Measurement of all hidden items shall be carried out by the Engineer-in-Charge. The Contractor or his representative who attends may at the time of measurement take such notes and measurements as he may desire.

The measurements for excavations shall be restricted and limited to minimum excavation line as per drawing for payment purposes.

20.3 DISPUTE IN MODE OF MEASUREMENT

Where Works have to be measured for any purpose whatsoever, it shall be in accordance with item specifications as per relevant Indian Standards unless otherwise specifically indicated in the Contract Specifications. All measurements will be recorded in metric units only. In case of absence of mode of measurement of any item not covered by both the methods mentioned above, the Engineer-in-Charge's decision shall be final and binding. The required number of bills, registers, bill forms, level/field books, materials/ account registers, testing registers, site order books and any other stationary item pertaining to this contract shall be printed and provided for by the contractor, at his own cost in the format prescribed and approved by the Engineer-in-Charge in writing. The Measurement Sheet will have three

	COMPOSITE SUPPLY CUM ERECTION OF ELECTRICAL & INSTRUMENTATION WORKS FOR OSBL FACILITIES ON ITEM RATE BASIS AT TALCHER FERTILIZERS LTD., ANGUL, ODISHA SPECIAL CONDITIONS OF CONTRACT	PC-183/ E-8003/ S-V	0	
		DOC. NO.	REV	
		Page 14 of 32		

copies in different colour pages and will be printed so that proper referring and record of complete measurement is maintained. Original sheet will be retained in the book and will be returned to Owner on completion of Work.

20.4 SUBMISSION OF FINAL BILL

The final bill complete in all respect shall be submitted after certified completion of work.

20.4.1 On the basis of the rates provided in the CONTRACT and subsequent Change Order(s)/Amendment(s), if any, the CONTRACTOR shall prepare the Final Bill as per GST norms. Additions claimed on account of CHANGE ORDER(s) shall be separately indicated in the Final Bill with reference to the relative CHANGE ORDERS(s).

20.4.2 The Final Bill shall, in addition to the payment entitlements arrived at according to the provisions of Clause 20.4.1 hereof shall separately state and include therein all claims of the CONTRACTOR, if any, with full particulars of the nature of such claim and grounds on which it is based and the amount claimed.

20.4.3 The Final Bill drawn in accordance with Clause 20.4.1 shall be submitted (together with the COMPLETION CERTIFICATE along with other documents as stipulated at Clause No. 39.8 of SCC, to the ENGINEER-IN-CHARGE for certification, who shall certify the Final Bill, if drawn in accordance with Clause 20.4.1. After certification of the ENGINEER-IN-CHARGE, the Final Bill shall be submitted in quadruplicate (or in such other number of copies as the OWNER may prescribe) to the OWNER for payment.



20.4.4 All monies payable under the CONTRACT for WORKS to be performed and MATERIALS to be supplied up to and including successful completion shall become due and payable to the CONTRACTOR only after submission to the OWNER of the Final Bill prepared in accordance with the provisions of Clause 20.4.1 hereof and associated provisions there under accompanied by the COMPLETION CERTIFICATE in respect of the WORKS.

20.4.5 Payments of the amount(s) due on the Final Bill to the extent certified by the ENGINEER-IN-CHARGE, shall be made within 30 (Thirty) days from the due date as specified in Clause 20.4.4 hereof, subject to the deductions provided in Clause 20.4.5.1.

20.4.5.1 All payments due to the CONTRACTOR on the Final Bill shall be subject to tax deductions and any other deductions provided in the CONTRACT or required to be made under any law, rule or regulation having the force of law for the time being applicable, or elsewhere provided for in the CONTRACT documents.

21.0 CLAIMS BY THE CONTRACTOR

21.1 No claim(s) shall on any account be made by the CONTRACTOR after submission of the Final Bill, with the intent that the Final Bill prepared by the CONTRACTOR shall reflect any and all claims whatsoever of the CONTRACTOR against the OWNER arising out of or in connection with the CONTRACT or any supply made or work performed by the CONTRACTOR there under or in relation thereto, and notwithstanding any enabling provision in any law or CONTRACT and notwithstanding any claim that the CONTRACTOR could have with respect thereto, the CONTRACTOR hereby waives and relinquishes any and all such claims not included in the Final Bill and absolves and discharges the OWNER from and against the same, even if in not including the same as

	COMPOSITE SUPPLY CUM ERECTION OF ELECTRICAL & INSTRUMENTATION WORKS FOR OSBL FACILITIES ON ITEM RATE BASIS AT TALCHER FERTILIZERS LTD., ANGUL, ODISHA SPECIAL CONDITIONS OF CONTRACT	PC-183/ E-8003/ S-V	0	
		DOC. NO.	REV	
		Page 15 of 32		

aforsaid, the CONTRACTOR shall have acted under a mistake of law or of fact, or shall claim to have acted under economic compulsion or necessity.

- 21.2 If required by the OWNER, the ENGINEER-IN-CHARGE shall be authorised to require the CONTRACTOR to furnish, and the CONTRACTOR shall, upon the request of the ENGINEER-IN-CHARGE /OWNER, furnish all invoices, vouchers and accounting records as may be deemed necessary by the ENGINEER-IN-CHARGE /OWNER for the purpose of verifying any CONTRACTOR's claim.

22.0 PROVISION FOR MULTIFARIOUS CHECKING OF WORK

Before commencement of the actual concreting operation the position and layout of foundations, pedestals, inserts, pockets, recess, reinforcement and form work shall be checked repeatedly by Owner/Consultant. No claim whatsoever shall be entertained on this account. The level of foundations shall be accurately maintained as shown in the drawings or as directed by the Owner/Consultant. No padding, plastering or chipping shall be allowed for achieving the results.

23.0 DEFECT LIABILITY PERIOD

Defect Liability Period shall be 12 months from the date of completion of works in all respects as declared by EIC/PROJECT MANAGER.

24.0 CLEARING, FILLING AND LEVELING OF SITE



The site shown on the layout plan shall be cleared by the Contractor of all obstructions, loose stones, materials, rubbish of all kinds of bushes, trees, grass as well as brush wood. All holes/hollow, whether originally existing or produced by removal of loose stones or brush wood, shall be carefully filled up with earth, well rammed and levelled off as directed by the Owner/ Consultant. The Contractor will not be entitled to any payment in his regard.

25.0 CONTRACTOR TO COMPLY ALL LAWS

- 25.1 The contract shall be governed by the law in force in the Republic of India.
- 25.2 The Contractor shall comply with all laws etc. The Contractor shall be responsible to secure compliance with the Central and States Laws as well as the Rules, Regulations, by-laws and orders of the legal authorities and statutory bodies which are in force or as may be in force from time to time. He shall give to the Municipal Corporation Committees, police and other relevant authorities all such notices, etc. as may be required by law and obtain all requisite license for temporary constructions, enclosures, etc. and pay all fees, taxes and such other dues or charges which may be leviable on account of any of his operations in executing the works under this contract. Owner/Consultant shall not pay anything extra to the Contractor on this account. The Contractor shall also make good at his own cost, any damage done by him to any adjoining property, during execution of work.

26.0 CONTRACTOR TO USE THE MATERIALS ONLY AFTER THE APPROVAL OF OWNER

The Contractor shall use the materials only after the approval of Owner/ Consultant, before incorporation of the same in the works.

	COMPOSITE SUPPLY CUM ERECTION OF ELECTRICAL & INSTRUMENTATION WORKS FOR OSBL FACILITIES ON ITEM RATE BASIS AT TALCHER FERTILIZERS LTD., ANGUL, ODISHA SPECIAL CONDITIONS OF CONTRACT	PC-183/ E-8003/ S-V	0	
		DOC. NO.	REV	
		Page 16 of 32		

27.0 COMPLIANCE OF ENTIRE PROVISIONS IS OBLIGATORY TO CONTRACTOR

It shall always prevail, unless otherwise specifically stated, that the entire provisions of the Tender Document have been accepted for compliance by the Contractor without any reservation.

28.0 DELIVERY AND DOCUMENTS

Delivery of the Goods shall be made by the Contractor in accordance with the terms specified by the Owner/Consultant in the schedule of requirements in Technical Specifications and the special conditions of Contract.

29.0 WEATHER CONDITIONS



Owner/Consultant may order Contractor to suspend any work which in the opinion of Owner/Consultant may be subject to damage by prevailing weather conditions. No claim whatsoever on this account shall be entertained.

It is presumed that the Contractor has familiarized himself with the weather conditions prevailing in the area therefore in such weather parameters if it appears to the Engineer –in –charge (EIC) that certain weather condition may damage the work or specified quality of the work can be achieved without stoppage of the work, the EIC in such conditions may require the Contractor to stop the work till such time as he thinks fit and appropriate. It is understood by the contractor that no compensation will be admissible on this count.

30.0 INSTRUCTIONS, DIRECTIONS AND CORRESPONDENCE

30.1 The work described in Contract is to be executed according to the standards, data sheets, tables, Specifications and Drawings and according to all conditions both general and specific enclosed with the Tender document, unless any or all of them shall have been modified or cancelled in writing as a whole or in part.

- i) All instructions and orders to Contractor shall, except what is herein provided, given by Owner/Consultant.
- ii) All the work shall be carried out under the direction of and to the satisfaction of Owner/Consultant.
- iii) All communications including technical/commercial clarifications and/or comments shall bear reference to the DLOA/ Contract.
- iv) Invoice for payment against DLOA/ Contract shall be addressed to Owner/ Consultant.
- v) The DLOA number shall be shown on all invoices, communications, packing lists, containers and bills of lading etc.

	COMPOSITE SUPPLY CUM ERECTION OF ELECTRICAL & INSTRUMENTATION WORKS FOR OSBL FACILITIES ON ITEM RATE BASIS AT TALCHER FERTILIZERS LTD., ANGUL, ODISHA SPECIAL CONDITIONS OF CONTRACT	PC-183/ E-8003/ S-V	0	
		DOC. NO.	REV	
		Page 17 of 32		

- 30.2 Correspondence on technical and commercial matters shall be dealt with in separate letters and each copy of the letter shall be complete with all Annexures. Wherever possible, correspondence should be through e-mails.
- 30.3 Correspondence for expediting and Third Party Inspection (TPI), if applicable, shall be done directly with inspector with a copy to consultant & owner.

31.0 QUALITY ASSURANCE / QUALITY CONTROL



- 31.1 After the award of the contract detailed quality assurance programme shall be prepared by the Contractor for the execution of contract for various works which will be mutually discussed and agreed to.
- 31.2 The Contractor shall establish document and maintain an effective quality assurance system outlined in recognized codes.
- 31.3 Quality Assurance System plans/procedures of the Contractor shall be furnished in the form of a QA manual after award of job. This document should cover details of the personnel responsible for the Quality Assurance, plans or procedures to be followed for quality control in respect of Design, Engineering, Procurement, Supply, Installation, Testing and completion in all respect till final acceptance by Owner. The quality assurance system should indicate organizational approach for quality control and quality assurance of the construction activities, at all stages of work at site.
- 31.4 The Owner/ Consultant or their representative shall reserve the right to inspect/ witness, review any or all stages of work at shop/site as deemed necessary for quality assurance.
- 31.5 The Contractor has to ensure the deployment of quality Assurance and Quality Control Engineer(s) depending upon the quantum of work. This QA/QC group shall be fully responsible to carry out the work as per standards and all code requirements. In case Engineer-in-charge feels that Contractor's QA/QC Engineer(s) are incompetent or insufficient, Contractor has to deploy other experienced Engineer(s) as per site requirement and to the full satisfaction of Engineer-In-Charge.
- 31.6 In case Contractor fails to follow the instructions of Engineer-in-charge with respect to above clauses, next payment due to him shall not be released unless until he complies with the instructions to the full satisfaction of Engineer-in-charge.
- 31.7 The Contractor shall adhere to the approved quality assurance system

32.0 HEALTH SAFETY AND ENVIRONMENT (HSE) MANAGEMENT

The Contractor, during entire duration of the Contract, shall adhere to HSE requirement as per Specification enclosed in the Bidding Document as per **Annexure - I (Annexure to Special Conditions of Contract)**

33.0 SUSPENSION OF WORKS

- 33.1 The OWNER reserves the right to suspend and reinstate execution of the whole or any part of the WORK without invalidating the provisions of the CONTRACT. Orders for suspension or reinstatement of the WORKS will be issued by the OWNER to the CONTRACTOR in

	COMPOSITE SUPPLY CUM ERECTION OF ELECTRICAL & INSTRUMENTATION WORKS FOR OSBL FACILITIES ON ITEM RATE BASIS AT TALCHER FERTILIZERS LTD., ANGUL, ODISHA SPECIAL CONDITIONS OF CONTRACT	PC-183/ E-8003/ S-V	0	
		DOC. NO.	REV	
		Page 18 of 32		

writing. The time for completion of the WORKS will be extended for a period equal to the duration of the suspension along with mutually agreed remobilization period.

33.2 If such suspension of WORK by OWNER delays or is likely to delay the progress of WORK or the carrying out of WORK under CONTRACT resulting in additional expenses or increased liability to CONTRACTOR, the OWNER shall pay to the CONTRACTOR all reasonable expenses, mutually agreed between OWNER and CONTRACTOR, arising from suspension of the work by an order in writing of the OWNER provided that such suspensions of work is more than a cumulative period of Sixty days (60) days and provided that such suspension is not due to some fault on the part of the CONTRACTOR or a SUB-CONTRACTOR.

33.3 If the OWNER has;

- (i) failed to pay the CONTRACTOR any sum due under the CONTRACT within the period specified in the Contract; or
- (ii) failed to approve invoice or supporting document without just cause within the period specified in the Contract; or
- (iii) committed substantial breach of the Contract:



Then, CONTRACTOR may give a notice requesting OWNER to remedy aforesaid default within 30 days. If OWNER fails to remedy it within the said period, CONTRACTOR may suspend the performance of its obligations under the CONTRACT.

33.4 If the CONTRACTOR's performance of its obligations is suspended under the CONTRACT pursuant to clause 33.3 as above, then the COMPLETION TIME shall be extended and all reasonable additional costs or expenses incurred by the CONTRACTOR and mutually agreed between OWNER and CONTRACTOR, as a result of such suspension shall be paid by the OWNER to the CONTRACTOR provided that such suspension is not due to fault on the part of CONTRACTOR or its SUB CONTRACTOR.

34.0 INCOMING MATERIAL REPORT/ INSPECTION

All material entering the site shall be properly recorded by contractor's representative with detail of challan, bill and quantity.

- a) All equipment shall be inspected and tested as per an agreed Quality Assurance Plan before the same is packed and dispatched from the Contractor's/ Vendor's Works. The Contractor shall carry out tests as specified/ directed by Engineer.
- b) Contractor shall perform all such tests as may be necessary to meet requirements of Local Authorities, Municipal or other statutory laws/ bye-laws in force. No extra shall be paid for these.
- c) The OWNER/ CONSULTANT may, at his sole discretion, carry out inspection at different stages during manufacturing and final testing after manufacturing.
- d) Approvals or passing of any inspection by the OWNER/ CONSULTANT or his authorized representative shall not however, prejudice the right of the OWNER/

	COMPOSITE SUPPLY CUM ERECTION OF ELECTRICAL & INSTRUMENTATION WORKS FOR OSBL FACILITIES ON ITEM RATE BASIS AT TALCHER FERTILIZERS LTD., ANGUL, ODISHA SPECIAL CONDITIONS OF CONTRACT	PC-183/ E-8003/ S-V	0	
		DOC. NO.	REV	
		Page 19 of 32		

CONSULTANT to reject the plan if it does not comply with the specification when erected or give complete satisfaction in service.

- e) All materials and equipment found defective shall be replaced and the whole work again tested to meet the requirements of the specifications, at the cost of the contractor. Contractor has to obtain a performance certificate/approval for the complete layout of piping/equipment erected.



35.0 THIRD PART INSPECTION

- i. A Third Party Inspection Agency (TPIA), shall be engaged to carryout inspection of equipment/ materials at manufacturer/ supplier works, prior to dispatch, unless the TPI is explicitly waived off (in writing) by the OWNER/ CONSULTANT.
- ii. The TPI shall be carried out by any of the below mentioned approved agencies only:
 - Bureau Veritas (Ind.) Pvt. Ltd. (BVIS)
 - Lloyd's Register (LRIS)
 - Indian Register of Shipping (IRS)/
 - DNV GL
 - TUV India Pvt. Ltd. (TUV)
- iii. Third Party Inspection Release Note clearly indicating that material has been inspected and accepted as per QAP approved by OWNER shall be submitted for OWNER/ CONSULTANT review prior to dispatch.
- iv. Approvals or passing of any inspection by the TPIA shall not however, prejudice the right of the OWNER/ CONSULTANT to reject the plan if it does not comply with the specification when erected or give complete satisfaction in service.
- v. The entire Cost for engagement of TPIA and the necessary modification/ rectifications (if any) prior to dispatch, shall be borne by the Contractor and no extra claim whatsoever shall be admissible on this account.
- vi. The OWNER/ CONSULTANT's Engineer may, at his sole discretion, carry out inspection at different stages during manufacturing and final testing after manufacturing. Testing performed in the presence of the Purchaser's representatives shall not relieve the supplier of their own responsibilities and guarantees and any other contractual obligations.

36.0 SECURITIES OF MATERIALS / EQUIPMENTS

Contractor shall be solely responsible for the security of the material at site and TFL/ Consultant shall not be responsible for any loss/theft of the materials.

- a) Materials required for the works, whether brought by the Contractor shall be stored by the Contractor only at places approved by the Engineer-in-Charge, as storage and safe custody of material shall be responsibility of the Contractor.

	COMPOSITE SUPPLY CUM ERECTION OF ELECTRICAL & INSTRUMENTATION WORKS FOR OSBL FACILITIES ON ITEM RATE BASIS AT TALCHER FERTILIZERS LTD., ANGUL, ODISHA SPECIAL CONDITIONS OF CONTRACT	PC-183/ E-8003/ S-V	0	
		DOC. NO.	REV	
		Page 20 of 32		

- b) TFL,'s officials concerned with the Contract shall be entitled at any time to inspect and examine any materials intended to be used in or on the works, either on the site or at factory or workshop or other place(s) where such materials are assembled, fabricated, manufactured or at any place(s) where these are lying or from which these are being obtained and the Contractor shall give such facilities as may be required for such inspection and examination.
- c) The contractor shall be the OWNER of all bought out items and materials and shall be responsible for the safety, security, insurance and care and custody of all the materials lying at site. TFL will have lien on all the items including those brought by the contractor for the purpose of Erection, testing, and commissioning of the work. For all Equipments/Materials, the title of Ownership shall pass on to the OWNER at the time of acceptance of entire work.

However, in case of termination of contract the transfer of title shall pass automatically to OWNER.

- d) CONSTRUCTION EQUIPMENT used by the CONTRACTOR and its SUB-CONTRACTORS in connection with the execution of works shall remain the property of CONTRACTOR or its SUB-CONTRACTORS. All duties, levies, taxes etc. payable on account of CONSTRUCTION EQUIPMENT shall be borne by the CONTRACTOR. CONTRACTOR shall indemnify the OWNER on this count.

37.0 CONTRACTOR'S PERSONNEL AT SITE:

List of persons employed by Contractor for the subject work mentioning their residential address shall be submitted to TFL. In case of any revision, the same shall be informed to TFL from time-to-time. If required necessary verification from Police / Gram Pradhan shall have to be submitted by the contractor.



The Contractor shall be directly responsible for any/all disputes arising between him and his personnel and keep indemnified against all losses, damage and claims arising thereof.

Within the TFL's premises, the Contractor's personnel shall not do any private work other than their normal duties.

The personnel engaged by the Contractor shall be subject to security check by the TFL's security staff while entering/leaving the premises. The contractor & his personnel shall be required to follow the rules and regulations of TFL in force from time-to-time. The contractor may also be required to provide photo passes to the personnel required by him, for security and safety reasons and furnished the details of the same when asked for.

No other person except Contractor's authorized representative shall be allowed to enter TFL premises Contractor shall also not entertain any outsider or extend any service beyond TFL's premises. Entry of Contractor's persons shall be regulated with proper identity/gate pass.

Contractor shall be fully responsible for theft, burglary, fire or any mischievous deeds by his staff and any loss to TFL shall be recovered from the immediate bill of the Contractor.

	COMPOSITE SUPPLY CUM ERECTION OF ELECTRICAL & INSTRUMENTATION WORKS FOR OSBL FACILITIES ON ITEM RATE BASIS AT TALCHER FERTILIZERS LTD., ANGUL, ODISHA SPECIAL CONDITIONS OF CONTRACT	PC-183/ E-8003/ S-V	0	
		DOC. NO.	REV	
		Page 21 of 32		

Contractor shall provide all necessary tools and tackles, equipments, safety belt, wheel burrow, scaffolding, ladders, drilling m/c & safety equipment etc. required to carry out job at his cost and material used by Contractor shall be of standard make and approval of Engineer-In-Charge shall be taken for the same.

TFL also reserves the right to ask the Contractor to remove particular person(s) from site with immediate effect if in the opinion of TFL, his behaviour/ performance is not up to the mark and/or found indulging in unlawful activities, Contractor shall immediately comply with such instructions.

It will be the responsibility of contractor's engineer to ensure that their personnel behave in a proper manners and behaviour and not to undergo the argument with the employees. It will be the responsibility of the Contractor's Engineer to deal with such complaints or co-ordinate with the TFL Engineer.



38.0 SETTING OUT THE WORKS

The CONTRACTOR shall supply dimensioned drawings, levels and other information necessary to set out the works and the Contractor shall set out the works and be responsible for the accuracy of the same. He shall rectify at his own cost and to the satisfaction of the Engineer-in-Charge any error found at any stage which may arise through in accurate setting out. The Contractor shall protect and preserve all bench marks used in setting out the works till end of the Defects Liability Period unless the Engineer-in-Charge direct their earlier removal.



39.0 COMPLIANCE WITH LABOUR/ INDUSTRIAL LAWS

RESPONSIBILITIES OF THE CONTRACTOR AND COMPLIANCE WITH LABOUR/ INDUSTRIAL LAWS:

- a. The contractor shall have his own PF code no. with the RPFC as required under Employee PF & Miscellaneous Provisions Act, 1952 and ESI code No. required under Employee State Insurance Act 1948 before commencement of work.
- b. The contractors shall periodically submit the challans / receipts / proof for the depositing PF contribution with RPFC and ESIC.
- c. The contractor is require to obtain labour license under the provisions of Contract Labour (R&A) Act, 1970 from the office of ALC (Central), Ministry of Labour, Govt. of India.
- d. The contractor is liable to abide by all necessary licenses / permissions from the concerned authorities as provided under the various labor legislations
- e. The contractor shall discharge obligations as provided under various statutory enactment including the employees Provident Fund and Miscellaneous Provisions Act, 1952, Contract Labour (R&A) Act, 1970, Minimum Wages Act, 1948, Payment of wages act 1936, Workman Compensation Act 1923, Employees' State Insurance Act 1948 and other relevant acts, rules and regulations enforced from time to time.
- f. The contractor shall be solely responsible for the payment of wages and other dues to the personnel, if any, deployed by him latest by 7th day of the subsequent month.

	COMPOSITE SUPPLY CUM ERECTION OF ELECTRICAL & INSTRUMENTATION WORKS FOR OSBL FACILITIES ON ITEM RATE BASIS AT TALCHER FERTILIZERS LTD., ANGUL, ODISHA SPECIAL CONDITIONS OF CONTRACT	PC-183/ E-8003/ S-V	0	
		DOC. NO.	REV	
		Page 22 of 32		

- g. The contractor shall be solely responsible and indemnify the TFL against all charges, dues, claim etc. arising out of the disputes relating to the dues and employment of personnel, if any, deployed by him.
- h. The contractor shall indemnify TFL against all losses or damages, if any, caused to it on account of acts of the personnel, if any, deployed by him.
- i. All personnel deployed by the contractor should be on the rolls of the contractor.
- j. The contractor shall ensure regular and effective supervision and control of the personnel, if any, deployed by him and gives suitable direction for undertaking the contractual obligations.
- k. The personnel to be deputed by the contractor shall observe all security, fire and safety rules of TFL while at the site. His Work/Services will be supervised by the supervisors of contractor. Contractor has to be strictly adhere to guidance, instruction when required.
- l. Contractor shall provide proper identification cards for his employees to be deputed by him for Work/Services, duly signed by the contractor or authorized person on behalf of contractor. Also the contractor should obtain entry passes from Security Dept. through OPERATION-IN-CHARGE for his employees.
- m. Contractor has to deploy the personnel with no past criminal records. Reformed people, names of such persons should be clearly indicated in case of. Also the contractor has to provide police verification for all the persons deployed by him.
- n. While confirming to any of these conditions, the contractor should ensure that no law of state regarding labour, their welfare, conduct etc, is violated. The contractor shall indemnify TFL for any action brought against him for violation, non-compliance of any act, rules & regulation of centre / state / local statutory authorities.
- o. All existing and amended safety / fire rules of TFL are to be followed at the work site.
- p. Contractor shall ensure payment of wages to the personnel employed and meet all statutory obligations of payment as per Minimum Wages act 1948 and payment of wages Act 1936.
- q. Special safety equipment e.g. safety belts, helmets, hand gloves, goggles, safety shoes etc shall be provided to the personnel engaged by the contractor.
- r. Suitable site office space may be provided by TFL if required and available.
- s. In case of accident, injury and death caused to the employee of the contractor while executing the Work under the contract, the contractor shall be solely responsible for payment of adequate compensation, insurance money etc. to the next kith & kin of injured / diseased. Contractor shall indemnify TFL from such liabilities.
- t. The contractor shall also undertake to obtain necessary group insurance coverage covering all risks connected with the job to be undertaken by him under the contract from insurance company and pay the premium accordingly.

	COMPOSITE SUPPLY CUM ERECTION OF ELECTRICAL & INSTRUMENTATION WORKS FOR OSBL FACILITIES ON ITEM RATE BASIS AT TALCHER FERTILIZERS LTD., ANGUL, ODISHA SPECIAL CONDITIONS OF CONTRACT	PC-183/ E-8003/ S-V	0	
		DOC. NO.	REV	
		Page 23 of 32		

- u. The contractor shall not employ or permit to be employed any person suffering from any contagious, loathsome or infectious disease. The contractor shall get examined his employees / persons deployed from a civil govt. doctor.
- v. No employees or person of contractor (including contractor) be allowed to consume alcoholic drinks or any narcotics within the plant premises. If found under the influence of above, the owner / TFL will terminate the contract immediately and may refer the case to police.
- w. The contractor hereby agrees to indemnify owner/ TFL and harmless from all claims, demands, actions, cost and charges etc brought by any court, competent authority/ statutory authorities against owner/ TFL.

40.0 TERMS OF PAYMENT

Payment shall be released after submitting valid Tax Invoice. GST no. of Contractor as well as Owner should be mentioned by the Contractor on Invoice.

Following terms of payment shall be applicable:

40.1 **Mobilization Advance:** Not Applicable

40.2 **Running on Account Payment**

Contractor shall raise the invoice for the 100% completed job against the RA bill and payment shall be release as per following manner:

a) For Civil, Structural & Architectural works:



95% against the value of actual work done shall be paid against running bills certified by OWNER/CONSULTANT after recovery of following payments:

- a) Value of chargeable materials issued by OWNER/CONSULTANT, if any
- b) Mobilization advances if any.
- c) Statutory deductions like income tax, etc. as applicable.
- d) Any other recovery if becomes due.
- e) Value of Chargeable Service provided by owner/Consultant, if any

Payment shall not be released against 1st R/A bill until submission of following documents by contractor to the indenting department.

1. Financial Guarantee for Performance
2. Labour License (as per statutory requirements)
3. EPF Code Registration number
4. Insurance Contractor All Risk (CAR) Policy
5. Workmen compensation policy

Balance 5% (Retention Money) shall be released along with final bill.

	COMPOSITE SUPPLY CUM ERECTION OF ELECTRICAL & INSTRUMENTATION WORKS FOR OSBL FACILITIES ON ITEM RATE BASIS AT TALCHER FERTILIZERS LTD., ANGUL, ODISHA SPECIAL CONDITIONS OF CONTRACT	PC-183/ E-8003/ S-V	0	
		DOC. NO.	REV	
		Page 24 of 32		

B) ELECTRICAL / INSTRUMENTATION WORK

i. For Only Supply Items

- 80% upon receipt of material at site and acceptance of equipment/materials
- 10% after completion of the erection
- 5 % after Inspection and Testing
- Balance 5% (Retention Money) shall be released along with final bill

ii. For Only Erection Items

- 80% on completion of erection / Installation
- 15% after inspection/testing
- Balance 5% (Retention Money) shall be released along with final bill

iii. For Items involving both Supply & Erection



- 60% on receipt and acceptance of material at site.
- 30% on completion of erection / Installation.
- 5% on Inspection & testing.
- Balance 5% (Retention Money) shall be released along with final bill

c) For Lumpsum Item:

- 60% shall be paid after material receipt at site
- 30 % shall be paid after completion of erection / Installation.
- 5% on Inspection & testing.
- Balance 5% (Retention Money) shall be released along with final bill.

40.3 Payment shall be released for supply of materials (wherever applicable) on submission of the following documents:

1. Signed Invoice(s)
2. Delivery Challan
3. Manufacturer's certificate of inspection for shipment in one original and one photocopy / Manufacturer's test certificate (wherever applicable)

	COMPOSITE SUPPLY CUM ERECTION OF ELECTRICAL & INSTRUMENTATION WORKS FOR OSBL FACILITIES ON ITEM RATE BASIS AT TALCHER FERTILIZERS LTD., ANGUL, ODISHA SPECIAL CONDITIONS OF CONTRACT	PC-183/ E-8003/ S-V	0	
		DOC. NO.	REV	
		Page 25 of 32		

4. Third Party Inspection Release Note clearly indicating that material has been inspected and accepted as per QAP approved by OWNER, or waiver certificate issued by OWNER (wherever applicable).
5. Railway Receipt/LR (wherever applicable)
6. Insurance Certificate/Intimation
7. Guarantee/ Warranty certificate (wherever applicable)
8. Operation & Maintenance manual (wherever applicable)

Note :

The amount of CGST & SGST or IGST and GST cess, if any will be released when the same will appear in the GSTR-2A of OWNER, in the common portal of GST and supplier has filed the valid return in accordance with the provisions of the GST Act and the rules made there under. If, input tax credit is not available to OWNER for any reason attributable to the bidder, then OWNER shall not be obligatory or liable to pay or reimburse GST claimed in invoice and shall be entitled to deduct /setoff/ recover such GST together with all the penalty and interest if any, against any paid or payable to bidder. Further in this case, OWNER reserves the right to upload the name of such defaulter on the Company website and may also consider for giving Holiday or debarred from participation in future tender.

40.4 PAYING AUTHORITY

Director (Finance),
Talcher Fertilizers Ltd.,
C/o GAIL Training Institute, PARC Building,
Plot No. 24, Sector – 16A, Film City, NOIDA (U. P.)



- 40.5 Payment in R.A. bills shall based on quantity of work executed at site (as per the item of work) & verified by Owner/ Consultant as per the Contract. Owner/ Consultant is authorized to allow part rate/ reduced rate for any item as mentioned in Contract. The engineer in charge shall specify the reason for the part rate payment in the R.A. bill. Payment has been made in R.A. bill for any item but later on, if some defect is noticed by the Owner/ Consultant, then Owner/ Consultant shall disallow the payment in successive R.A. bill till rectification of the work has been done.

40.6 RELEASE OF 1st R/A BILL

Payment will be released against 1st R/A bill only on submission of following documents by contractor to the EIC/ OWNER:

- i. Contract Performance Security
- ii. Labour License (as per statutory requirements)
- iii. EPF Code Registration number with RPFC/ARPF
- iv. Insurance Contractor All Risk (CAR) Policy
- v. Workmen compensation policy

- 40.7 Balance 5% (Retention Money) shall be released along with final bill subject to the following:

	COMPOSITE SUPPLY CUM ERECTION OF ELECTRICAL & INSTRUMENTATION WORKS FOR OSBL FACILITIES ON ITEM RATE BASIS AT TALCHER FERTILIZERS LTD., ANGUL, ODISHA SPECIAL CONDITIONS OF CONTRACT	PC-183/ E-8003/ S-V	0	
		DOC. NO.	REV	
		Page 26 of 32		

If the amount recoverable exceeds the amount payable in final bill, the balance amount shall be recovered by the Owner, from the retention money and or performance bank guarantee/any other moneys or bank guarantees available with the owner for any other job being done by the contractor. The contractor shall restore the performance guarantee to the requisite value to the extent of 3% of contract price in such case where recovery is required to be affected by the encashment of full amount or a part of the performance bank guarantee as soon as the contractor receives such intimation from the owner/ consultant.

- 40.8 The contractor shall raise invoices on fortnightly basis. Bidder shall enclose all documents as per check list issued by CONSULTANT/TFL. However, EIC/Project Manager may authorize payments for bills more frequently i.e. periodicity of less than fortnight, depending on site requirements.

After receipt of complete R.A. Bill as per terms and conditions of the contract and duly certified by Engineer-in-Charge (EIC), on-account payment equivalent to seventy percent (70%) of the net payable certified amount of the R.A. Bill will be released to the Contractor within a period of seven (07) working days from submission of certified bill by EIC to OWNER. The balance amount will be released within a period of 15 days from submission of certified bill by EIC to OWNER.

However, in addition of Running Account Bill, the contractor has to submit the Monthly Progress Report. This report will acts as a mandatory document for submission of the bill. Failing in submission of the report, the invoice will not be processed further for payment



- 40.9 The final bill complete in all respect shall be submitted by the contractor within three (3) months of certified completion of work. The bill should be accompanied along with the following documents.

1. Job completion certificate.
2. No claim certificate on Owner's prescribed proforma.
3. Site clearance certificate.
4. Contract Performance Security duly amended to cover Defect Liability Period.
5. Material reconciliation statement (statement of material issued by Owner or consultant to be got certified from stores dept.).
6. Indemnity certificate towards labour payment and all statutory payments.

No claim shall be entertained after receipt of final bill. Settlement of final bill shall be made subject to settlement of all disputes and furnishing of all required documents/clarifications and grant of extension of time, if any, by Owner's competent authority.

In case any claim with regard to the wages of any labour employed by Contractor for the subject job is pending/ reported, TFL shall be fully entitled to withhold payment of final bill pending finalisation of such claims.

- 40.10 The status of the contractor as L-1 bidder shall be ensured keeping in view the final executed Bill of Quantity. All the valid tenders considered in evaluation at the time of award of work shall be re-evaluated at the respective quoted rate with a view to assess whether L-1 contractor's price of completed works continues to be the lowest. In case after such re-evaluation, final contract value is not the lowest, the contractor shall reimburse to Owner the difference in the amount between the re-evaluated tender and the lowest tendered amount. This difference of amount shall be adjusted from their final bill.

	COMPOSITE SUPPLY CUM ERECTION OF ELECTRICAL & INSTRUMENTATION WORKS FOR OSBL FACILITIES ON ITEM RATE BASIS AT TALCHER FERTILIZERS LTD., ANGUL, ODISHA SPECIAL CONDITIONS OF CONTRACT	PC-183/ E-8003/ S-V	0	
		DOC. NO.	REV	
		Page 27 of 32		

However, if the amount recoverable exceeds the amount payable in final bill, the balance amount shall be recovered by the Owner, from the retention money and or performance bank guarantee / any other moneys or bank guarantees available with the Owner for any other job being done by the contractor. The contractor shall restore the performance guarantee to the requisite value to the extent of 10% of contract price in such case where recovery is required to be affected by the encashment as soon as the contractor receives such intimation from the owner / consultant.

41.0 DISPATCH, TRANSPORTATION/SHIPPING

CONTRACTOR shall be responsible for dispatch of EQUIPMENT by sea/ rail/ road/ air after proper packing and protection. The consignment shall be dispatched after inspection by Third Party Inspection Agency as specified in the Tender document, unless otherwise agreed to in writing however such inspection shall not constitute waiver of the CONTRACTOR's obligations, responsibilities for the EQUIPMENT including care, safety and preservation in any way and manner and the CONTRACTOR's responsibility and obligation in this behalf shall continue till ACCEPTANCE OF ENTIRE WORK.



The Consignee for all bought-out material shall be CONTRACTOR.

42.0 WORK CONTRACT SERVICES

42.1 The award of work shall be on 'Work Contract Service' basis. The contractor shall be responsible for payment of any tax levied on the transfer of property and goods involved with relevant GST act and rules made there under including amendments, if any. The contractor shall be liable to ensure to have registered with the respective tax authorities and to submit self-attested copy of such registration certificate(s) and any taxes/ duties/ levies being charged by the Contractor would be claimed by issuing proper tax invoice/ challan indicating details/ elements of all taxes charged and necessary requirements as prescribed under the respective tax laws and also to mention correct and valid registration number(s) on all tax invoices raised to TFL.



42.2 Irrespective of single or separate insurances, the CONTRACTOR shall take the same in the joint name of OWNER and CONTRACTOR, with OWNER as Primary Beneficiary and CONTRACTOR as Joint Beneficiary, to cover all risk including marine cum erection insurance (MCE), workmen compensation / Employees State Insurance (ESI) under ESI Act 1948 for Contractor's personnel, fire risk policy etc. till handing over of PLANT to OWNER duly commissioned and tested. However, for CONTRACTOR's EQUIPMENT, CONTRACTOR can be the sole beneficiary. Further, OWNER shall have the first right over the claim amount for all insurance claims, where owner has made part or full payment to the contractor.

42.3 CONTRACTOR shall be fully responsible for pursuing and settling all claims under the underwriters. In the event of accident, injury, damage or loss likely to form a claim under the above insurance policies, CONTRACTOR shall, as quickly as possible submit the insurance claims by underwriters under intimation to OWNER. CONTRACTOR shall also keep OWNER fully informed about progress of each such case. CONTRACTOR shall undertake immediate repair and replacement of the equipment lost in transit, storage,

	COMPOSITE SUPPLY CUM ERECTION OF ELECTRICAL & INSTRUMENTATION WORKS FOR OSBL FACILITIES ON ITEM RATE BASIS AT TALCHER FERTILIZERS LTD., ANGUL, ODISHA SPECIAL CONDITIONS OF CONTRACT	PC-183/ E-8003/ S-V	0	
		DOC. NO.	REV	
		Page 28 of 32		

assembly, erection and COMMISSIONING of PLANT pending settlement of claim thereafter by the underwriters.

- 42.4 The CONTRACTOR at his cost shall arrange, secure and maintain all insurance as may be pertinent to the works and obligatory in terms of law to protect his interest and interest of OWNER in the project, against all perils detailed herein. The Form and the limit of such insurance as defined herein together with the under-writer in each case shall be acceptable to the OWNER and OWNER's acceptance shall not be unreasonably withheld. However, irrespective of such acceptance, the responsibility to maintain adequate insurance coverage at all times including third party liability during the period of contract shall be as of CONTRACTOR alone. The contractor's failure in this regard shall not relieve him of any of his contractual responsibilities and obligations. The insurance covers to be taken by the CONTRACTOR shall be in the joint names of OWNER and the CONTRACTOR. The CONTRACTOR shall, however, be authorized to deal directly with insurance company or companies and shall be responsible in regard to maintenance of all insurance covers.
- 42.5 Any loss or damage to the equipment during handling, transportation, storage, erection, putting the equipment into satisfactory operation and all activities to be performed till the successful completion of trial operation of the plant shall be to the account of the CONTRACTOR. The CONTRACTOR shall be responsible for reference of all claims and make good the damages or loss by way of repairs and/or replacement of the equipment, damaged or lost. The transfer of title shall not in any way relieve the CONTRACTOR of the above responsibility during the period of CONTRACT. The CONTRACTOR shall provide the OWNER with copies of all insurance policies and documents taken out by him in pursuance of the CONTRACT. Such copies of documents shall be submitted to the OWNER immediately after such insurance coverage. However, if Marine cargo insurance or Third party liability Insurance is a part of their global policies; insurer certificate (including the main terms of policy) shall be submitted by CONTRACTOR. The CONTRACTOR shall also inform the OWNER in the writing at least thirty (30) days in advance regarding the expiry/ cancellation and/or change in any of such documents and ensure revalidation, renewal etc. as may be necessary well in time. However adequacy, credibility and maintenance of Insurance policies is the sole responsibility of CONTRACTOR and CONTRACTOR shall keep the OWNER indemnified against any such failure.
- 42.6 If the material/ equipment or any portion thereof is damaged or lost during transit and handling, storage, erection, commissioning at site, the replacements of such material / equipment shall be effected by the CONTRACTOR within a reasonable time to avoid unnecessary delay in the COMMISSIONING of the EQUIPMENT and without waiting for realization of cost of damages from the insurance company, appointed by him for this purpose. This will not alter the schedule of commissioning & guarantee tests in any way.
- 42.7 All works and operations necessary to lift and to remove the material from port, warehouse, railway or other siding, factory or other places of delivery, loading, handling, transporting and unloading and safely stacking, placing or storing the same at approved godowns, yards or other place(s) of storage including lashing or other-wise securing or protecting the same in transit and during and in storage.
- 42.8 The CONTRACTOR shall maintain a day-to-day account of all materials indicating the daily receipt(s), consumption(s) and balance of each material and category thereof. Such account shall be in the format, if any, prescribed by the Engineer-in-Charge and shall be

	COMPOSITE SUPPLY CUM ERECTION OF ELECTRICAL & INSTRUMENTATION WORKS FOR OSBL FACILITIES ON ITEM RATE BASIS AT TALCHER FERTILIZERS LTD., ANGUL, ODISHA SPECIAL CONDITIONS OF CONTRACT	PC-183/ E-8003/ S-V	0	
		DOC. NO.	REV	
		Page 29 of 32		

supported by all documents necessary to verify the correctness of the entries in the account. Such account shall be maintained at the CONTRACTOR MANAGER's office and site(s) and shall be open for inspection and verification (by verification of documents in support of the entry as also by feasible verification of the stock) at all times by the Engineer-in-Charge with authority at all times without obstruction to enter into or upon any godown or other place(s) or premise(s) where the materials or any part of them are lying or stored and to inspect the same himself and or through his representative(s).

42.9 The CONTRACTOR shall at all times be exclusively responsible for any and all losses, damages, deterioration, misuse, wastage, theft, or other application or misapplication or disposal of the materials or any of them contrary to the provisions hereof and shall keep the OWNER indemnified from and against the same and shall forthwith at its own cost and expenses replace any such material, lost, damaged, deteriorated, misused, wasted, stolen, applied, mis-applied and/or disposed as aforesaid with other material of equivalent quality and quantity delivered to site at the CONTRACTOR's risks and costs in all respects.



42.10 Notwithstanding anything herein provided, the CONTRACTOR shall be and remain solely and exclusively liable to repair, restore or replace, as the case may be, the materials damaged or destroyed as a result of any act or omission, notwithstanding the existence or otherwise of any policy(ies) of insurance aforesaid, with the intent that any policy(ies) of insurance aforesaid taken out by the CONTRACTOR or by the OWNER, on default by the CONTRACTOR, shall not anyway absolve the CONTRACTOR from his full liability up to and until issue of the Completion Certificate as provided for herein in respect of the works, the work(s) and all materials incorporated therein shall be and remain at the risks of the CONTRACTOR in all respects, including (but not limited to) accident, lightning, earth-quake, fire, storm, flood, tempest, riot, civil commotion and/or war or otherwise with respect to the materials, but shall constitute merely an additional security and not a substitution of liability.

42.11 If the CONTRACTOR shall default in replacing at the job site, free of any cost to the OWNER, any material lost, damaged, deteriorated, misused, wasted, short, stolen, misapplied or disposed of within the provisions hereof above, or shall fail to return to the OWNER any surplus material or empties within the provision hereof above, the CONTRACTOR shall be liable to pay to the OWNER the cost of such materials or empties delivered at OWNER's stockpile/ godown.

43.0 CONSTRUCTION EQUIPMENT, TOOLS AND TACKLES DEPLOYMENT

i. The details of key construction equipment in good condition, required to be mobilized by the contractor, to complete the work within the schedule is listed below (not limited to only the following) :

Sl. No.	Equipment Description
1	Hydraulic Telescopic Boom Pick & Carry Crane of suitable capacity
2	Hydraulic Excavator
3	Dumper
4	Tractor Trailer
5	Water Tanker

	COMPOSITE SUPPLY CUM ERECTION OF ELECTRICAL & INSTRUMENTATION WORKS FOR OSBL FACILITIES ON ITEM RATE BASIS AT TALCHER FERTILIZERS LTD., ANGUL, ODISHA SPECIAL CONDITIONS OF CONTRACT	PC-183/ E-8003/ S-V	0	
		DOC. NO.	REV	
		Page 30 of 32		

6	Total Station
7	Dumpy level
8	Welding Machine
9	Dewatering Pump
10	Concrete Mixer
11	Electrical tool Kit
12	Breaker
13	Manual/ Electrical Lifting Equipment/ Hoists/ Pullers of suitable capacity
14	Any, other equipments to complete the job

- ii. Contractor to confirm that the above equipments are available with him in good working condition and shall be timely mobilized on this project site. Contractor has the option to hire some these equipment from equipment hiring agencies also, however contractor shall be responsible for all the machinery deployed at site.
- iii. In addition to above, Contractor shall be required to deploy all the machinery/ tools & tackles at site as required for the successful completion of the job/ as directed by the Engineer-in-charge.
- iv. Owner/ consultant reserve the right to physically check & verify the availability of these equipments prior to award of work
- v. Contractor shall replace any defective/ damaged equipment promptly to complete the work without any time & cost implication to the owner/ consultant
- vi. The actual deployment of equipments shall be finalized or approved by Engineer-in-charge.



44.0 BOCW (BUILDING AND OTHER CONSTRUCTION WORKS)

Applicable BOCW shall be included in the quoted TOTAL CONTRACT PRICE. The contractor shall pay the cess under BOCW Act for subject works and submit proof of submission of cess to owner before submitting the next R.A. bill. In case, contractor does not submit the said proof, applicable BOCW shall be deducted at source by the OWNER from the contractor's invoice and deposit the deducted amount to the concerned authority. OWNER does not undertake any further responsibility in this regard.

45.0 DELETED

46.0 SUB-CONTRACTOR/VENDOR AND MANUFACTURER WARRANTIES

- (a) CONTRACTOR shall ensure that all equipment and other items used in connection with the performance of the WORK or incorporated in the PLANT (other than minor items) will be purchased in compliance with CONTRACT Technical Specifications and requirements in order to allow the PLANT to achieve the Guarantee and Warrantee as provided for in the CONTRACT, unless otherwise agreed with OWNER. Any residual warranty from sub-contractor/vendor shall be passed to the OWNER after expiry of DEFECT LIABILITY PERIOD.
- (b) Neither CONTRACTOR nor its SUB-CONTRACTORS/SUB-VENDORS nor any person under the control of either thereof, shall take any action which could



	COMPOSITE SUPPLY CUM ERECTION OF ELECTRICAL & INSTRUMENTATION WORKS FOR OSBL FACILITIES ON ITEM RATE BASIS AT TALCHER FERTILIZERS LTD., ANGUL, ODISHA SPECIAL CONDITIONS OF CONTRACT	PC-183/ E-8003/ S-V	0	
		DOC. NO.	REV	
		Page 31 of 32		

release, void, impair or waive any Guarantee or Warranty on EQUIPMENT or services relating to the PROJECT or the WORK. Any residual warranty from sub-contractor/sub-vendor shall be passed to the OWNER after expiry of DEFECT LIABILITY PERIOD.

- (c) Nothing in this clause shall derogate from the obligations of CONTRACTOR to provide the Guarantees and Warranties described in and to comply with the provisions hereinabove.
- (d) CONTRACTOR shall, based on its past professional judgement, enforce all guarantees and warranties provided hereunder to the fullest extent thereof till such time they are transferred to the OWNER pursuant to sub-clause (g) below.
- (e) Upon the expiration or termination of any of the guarantees or warranties provided by CONTRACTOR pursuant to the CONTRACT, the CONTRACTOR shall assign, and hereby assigns, effective as of such date, or otherwise make available, to OWNER all of CONTRACTOR's rights under all such SUBCONTRACTOR's residual Guarantees and warranty as per 45.0 (a) & (b) (except to the extent CONTRACTOR has thereof provided warranty services to OWNER and is enforcing CONTRACTOR's rights with respect to such services under the applicable guarantee or warranty) and shall deliver to OWNER copies of all contracts providing for such guarantees and warranties.
- (f) CONTRACTOR, in accordance with the CONTRACT, shall require all SUB-CONTRACTORS/ SUB-VENDORS to be covered by the insurance covers specified in the CONTRACT, during the time in which they are engaged in performing WORK.
- (g) CONTRACTOR shall require all SUB-CONTRACTORS/ SUB-VENDORS to release and waive any and all rights of recovery against OWNER including its affiliates, subsidiaries, employees, successors, permitted assigns, insurers and underwriters) and against CONTRACTOR and all other SUB-CONTRACTORS/ VENDORS which the releasing SUB-CONTRACTOR/ VENDOR may otherwise have or acquire, in or from or in any way connected with any loss covered by policies of insurance maintained or required to be maintained pursuant to this the CONTRACT (other than third party liability insurance policies) or because of deductible clauses in or inadequacy of limits of any such policies of insurance. CONTRACTOR shall further require all SUB-CONTRACTORS/VENDORS to include in all policies of insurance maintained by the SUB-CONTRACTORS/ VENDORS clauses providing that each underwriter shall release and waive all of its rights of recovery, under subrogation or otherwise, against OWNER, its promoters, affiliates, subsidiaries, employees, successors, permitted assigns, insurers and underwriters, and against CONTRACTOR and all other SUB-CONTRACTORS/VENDORS.
- (h) OWNER shall not be deemed by virtue of the CONTRACT to have any contractual obligation to or relationship with any SUB-CONTRACTOR/ VENDOR.

47.0 CONTRACTOR's LIABILITY FOR APPROVED SUB CONTRACTOR :

The review by and approval and consent of OWNER as to the approved SUB-CONTRACTORS list or as to CONTRACTOR entering into any SUB-CONTRACT with any approved SUB-CONTRACTOR or as to any WORK done or supply made or services provided by any such approved SUB-CONTRACTOR/ SUB-VENDOR shall not relieve CONTRACTOR of any of his duties, liabilities or obligations under this CONTRACT, and CONTRACTOR shall be liable hereunder to the same extent as if any such SUB-

	COMPOSITE SUPPLY CUM ERECTION OF ELECTRICAL & INSTRUMENTATION WORKS FOR OSBL FACILITIES ON ITEM RATE BASIS AT TALCHER FERTILIZERS LTD., ANGUL, ODISHA SPECIAL CONDITIONS OF CONTRACT	PC-183/ E-8003/ S-V	0	
		DOC. NO.	REV	
		Page 32 of 32		

CONTRACT had not been entered into. Any inspection review or approval by OWNER permitted under this CONTRACT of any portion of the work or of any work in progress by CONTRACTOR or SUB-CONTRACTORS/ SUB-V ENDORS shall not relieve CONTRACTOR of any duties, liabilities or obligations under this CONTRACT.

48.0 STATUTORY VARIATION IN TAXES AND DUTIES

- 48.1 No variation on account of taxes and duties, statutory or otherwise, (other than due to change in turnover) shall be payable by OWNER to CONTRACTOR, except for GST. Any statutory variation in GST, shall be payable up to COMPLETION PERIOD against documentary evidence. Any reduction in the amount of GST resulting from a reduction in the rate of GST or remission or exemption from GST with respect to Goods and Services provided to the OWNER shall be refundable to the OWNER at actuals within the COMPLETION PERIOD and also during the delayed contractual Project completion, if any. The CONTRACTOR shall submit a copy of the 'Government Notification' to evidence the rate as applicable on the Bid due date and on the date of revision.
- 48.2 Any new taxes, duties, cess, levies notified or imposed after the submission of Price Bid but before COMPLETION PERIOD shall be to OWNER's Account.
- 48.3 In case of delayed completion beyond the COMPLETION PERIOD, even though extension of completion time is allowed by OWNER, for reasons solely attributable to Contractor, all extra costs on account of changes of statutory regulations/ acts shall not apply to the Contract price and shall be borne by the CONTRACTOR.

However, any decrease in taxes and duties during the delayed period shall be passed on to the OWNER.

In case the COMPLETION PERIOD is extended for reasons solely attributable to OWNER, then any increase on account of statutory changes in GST until the extended period shall be borne by OWNER. Further, any new taxes, duties, cess, levies notified or imposed after the submission of Price Bid during such extended COMPLETION PERIOD shall be to OWNER's Account.

- 48.4 Claim for payment of GST (CGST & SGST/UTGST or IGST)/ Statutory variation, should be raised within two [02] months from the date of issue of 'Government Notification' for payment of differential (in %) GST (CGST & SGST/UTGST or IGST), otherwise claim in respect of above shall not be entertained for payment of arrears.
The base date for the purpose of applying statutory variation shall be the Bid Due Date.

 पी डी आई एल PDIL	PROJECTS & DEVELOPMENT INDIA LIMITED	PC-183/ E-8003/ S-V	0	 Talcher Fertilizers
		DOC. NO.	REV.	
		Page 1 of 18		

ANNEXURE - I
TO
SPECIAL CONDITIONS OF CONTRACT

SPECIFICATION
FOR
HEALTH, SAFETY AND
ENVIRONMENT (HSE) MANAGEMENT





	COMPOSITE SUPPLY CUM ERECTION OF ELECTRICAL & INSTRUMENTATION WORKS FOR OSBL FACILITIES ON ITEM RATE BASIS AT TALCHER FERTILIZERS LTD., ANGUL, ODISHA HEALTH, SAFETY AND ENVIRONMENT (HSE) MANAGEMENT	PC-183/ E-8003/ S-V	0	
		DOC. NO.	REV	
		Page 2 of 18		

TABLE OF CONTENTS

1.0	SCOPE.....	3
2.0	REFERENCES.....	3
3.0	REQUIREMENTS OF HEALTH, SAFETY & ENVIRONMENT (HSE) MANAGEMENT SYSTEM TO BE COMPILED BY BIDDERS	3
4.0	DETAILS OF HSE MANAGEMENT SYSTEM BY CONTRACTOR.....	7

ANNEXURES: -

1. ANNEXURE-1 A : RELEVANT I.S. CODES
2. ANNEXURE-1 B : REPORTING FORMATS

	COMPOSITE SUPPLY CUM ERECTION OF ELECTRICAL & INSTRUMENTATION WORKS FOR OSBL FACILITIES ON ITEM RATE BASIS AT TALCHER FERTILIZERS LTD., ANGUL, ODISHA HEALTH, SAFETY AND ENVIRONMENT (HSE) MANAGEMENT	PC-183/ E-8003/ S-V	0	
		DOC. NO.	REV	
		Page 3 of 18		

1.0 SCOPE

This Specification establishes the Health, Safety and Environment (HSE) management requirement to be complied with by the Contractors during construction. Requirements stipulated in this specification shall supplement the requirements of HSE Management given in relevant Act (s)/ legislations. General Conditions of Contract (GCC), Special Conditions of Contract (SCC), and Job Specifications. Where different documents stipulate for different requirements, the most stringent shall be adopted.

2.0 REFERENCES

This document should be read in conjunction with following:

- General Conditions of Contract (GCC)
- Special Condition of Contract (SCC)
- Job Specifications
- Relevant IS Codes (Refer Annexure-IA)
- Reporting Formats (Refer Annexure-IB)

3.0 REQUIREMENTS OF HEALTH, SAFETY & ENVIRONMENT (HSE) MANAGEMENT SYSTEM TO BE COMPILED BY BIDDERS

3.1 MANAGEMENT RESPONSIBILITY

The contractor should have a documented HSE policy to cover commitment of their organization to ensure health, safety and environment aspects in their line of operation.

3.1.2 The HSE management system of the Contractor shall cover the HSE requirements including but not limited to what is specified under Para 1.0 and Para 2.0 above.



3.1.3 Contractor shall be fully responsible for planning and implementing HSE requirements. Contractor as a minimum requirement shall designate/deploy the following to coordinate the above.

No. of workers deployed
Upto 250

- Deploy one qualified and experienced safety Engineer/Officer

Above 250 & Upto 500

- One additional safety engineer/officer, as above



	COMPOSITE SUPPLY CUM ERECTION OF ELECTRICAL & INSTRUMENTATION WORKS FOR OSBL FACILITIES ON ITEM RATE BASIS AT TALCHER FERTILIZERS LTD., ANGUL, ODISHA HEALTH, SAFETY AND ENVIRONMENT (HSE) MANAGEMENT	PC-183/ E-8003/ S-V	0	
		DOC. NO.	REV	
		Page 4 of 18		

Above 500
(For every 500 or less)

- One additional safety engineer/officer,
for each 200 workers.

Contractor shall indemnify & hold harmless Owner/Consultant & their representatives free from any and all liabilities arising out of non-fulfillment of HSE requirements.

- 3.1.4 The Contractor shall ensure that the Health, Safety and Environment (HSE) requirements are clearly understood & faithfully implemented at all levels at site.
- 3.1.5 The Contractor shall promote and develop consciousness for Health Safety and Environment among all personnel working for the Contractor. Regular awareness programs and fabrication shop/work site meetings shall be arranged on HSE activities to cover hazards involved in various operations during construction.
- 3.1.6 Arrange suitable First-Aid measures such as First Aid Box, trained personnel to First Aid, Standby Ambulance or Vehicle and install fire protection measures such as adequate number of steel buckets with sand and water and adequate extinguishers to the satisfaction of Consultant/Owner.
- 3.1.7 The Contractor shall evolve a comprehensive planned and documented system for implementation and monitoring of the HSE requirements. This shall be submitted to Consultant/Owner for approval. The monitoring for implementation shall be done by regular inspections and compliance to the observations thereof. The Contractor shall get similar HSE requirements implemented at his sub-contractor(s) work site/office. However, compliance of HSE requirements shall be the sole responsibility of Contractor. Any review/approval by Consultant/Owner shall not absolve contractor of his responsibility / liability in relation to all HSE requirements.
- 3.1.8 Non-Conformance on HSE by Contractor (including his Sub-contractors) as brought out during review/audit by Consultant/Owner representative shall be resolved forthwith by Contractor. Compliance report shall be provided to Consultant/Owner.
- 3.1.9 The Contractor shall ensure participation of his Resident Engineer/ Site-in-Charge in the Safety Committee / HSE Committees. Meetings arranged by Consultant/Owner. The compliance of any observations shall be arranged urgently. He shall assist Consultant/Owner to achieve the targets set by them on HSE during the project implementation.
- 3.1.10 The Contractor shall adhere consistently to all provisions of HSE requirements. In case of non-compliance or continuous failure in implementation of any of HSE provisions; Consultant/Owner may impose stoppage of work without any Cost & time implication to Owner and/or impose a suitable penalty for noncompliance with a notice of suitable period upto a cumulative limit of 1.0% (one percent) of Contract Value with a ceiling of Rs 10 lakhs. This penalty shall be in addition to all other penalties specified else where in the contract. The decision of imposing stoppage

	COMPOSITE SUPPLY CUM ERECTION OF ELECTRICAL & INSTRUMENTATION WORKS FOR OSBL FACILITIES ON ITEM RATE BASIS AT TALCHER FERTILIZERS LTD., ANGUL, ODISHA HEALTH, SAFETY AND ENVIRONMENT (HSE) MANAGEMENT	PC-183/ E-8003/ S-V	0	
		DOC. NO.	REV	
		Page 5 of 18		

work, its extent & monetary penalty shall rest with Consultant/Owner & binding on the Contractor.

3.1.11 However **fatal accident** may lead to termination of the Contract. The personnel accidents shall be investigated by a team of Contractor's senior personnel for root cause & recommend corrective and preventive actions. Findings shall be documented and suitable actions taken to avoid recurrences shall be communicated to Consultant/Owner. Owner/Consultant shall have the liberty to independently investigate such occurrences and Contractor shall extend all necessary help and co-operation in this regard.



3.2.0 HOUSE KEEPING

3.2.1 Contractor shall ensure that a high degree of house keeping is maintained and shall ensure inter-racial the followings:

- a. All surplus earth and debris are removed/disposed off from the working areas to identified location(s).
- b. Unused / Surplus Cables different places within location(s). Steel items and steel scrap lying scattered at the working areas are removed to identified
- c. All wooden scrap, empty wooden cable drums and other combustible packing materials, shall be removed from work place to indemnified location(s).
- d. Roads shall be kept clear and materials like pipes steel sand, boulders concrete, chips and bricks etc shall not be allowed on the roads to obstruct free movement of men & machineries.
- e. Fabricated steel structural, pipes & piping materials shall be stacked properly for erection.
- f. Water logging on roads shall not be allowed.
- g. No parking of trucks/trolleys, cranes and trailers etc shall be allowed on roads which may obstruct the traffic movement.
- h. Utmost care shall be taken to ensure over all cleanliness and proper upkeep of the working areas.
- i. Trucks carrying sand, earth and pulverized materials etc shall be covered while moving within the plant area.



3.3.0 HEALTH, SAFETY AND ENVIRONMENT

3.3.1 The Contractor shall provide safe means of access to any working place including provisions of suitable and sufficient scaffolding at various stages during all operations

	COMPOSITE SUPPLY CUM ERECTION OF ELECTRICAL & INSTRUMENTATION WORKS FOR OSBL FACILITIES ON ITEM RATE BASIS AT TALCHER FERTILIZERS LTD., ANGUL, ODISHA HEALTH, SAFETY AND ENVIRONMENT (HSE) MANAGEMENT	PC-183/ E-8003/ S-V	0	
		DOC. NO.	REV	
		Page 6 of 18		

of the work for the safety of his workmen, and, Consultant/Owner. Contractor shall ensure deployment of appropriate equipment and appliances for adequate safety and health of the workmen and protection of surrounding areas.

- 3.3.2 The Contractor shall ensure that all their staff and workers including their subcontractor(s) shall wear Safety Helmet and Safety shoes. Contractor shall also ensure, use of safety belt protective goggles, gloves etc. by the personnel as per job requirements. All these gadgets shall conform to relevant IS specifications or equivalent.
- 3.3.3 Contractor shall ensure that a proper Safety Net System shall be used at appropriate locations. The safety net shall be located not more than 30 feet (9.0 meters) below the working surface at site to arrest or to reduce the consequences of a possible fall of persons working at different heights.
- 3.3.4 Contractor shall ensure that flash back arrester shall be used while using Gas Cylinders at site. Cylinders shall be mounted on trolleys.
- 3.3.5 The Contractor shall assign to his workmen tasks commensurate with their qualification experience and state of health for driving of vehicles, handling and erection of materials and equipments. All lifting equipments shall test certified for its capacity before use. Adequate and suitable lighting at every work place and approach there to, shall be provided by the contractor before starting the actual operations at night.
- 3.3.6 Hazardous and/or toxic materials such as solvent coating or thinners shall be stored in appropriate containers.
- 3.3.7 All hazardous materials shall be labeled with the name of materials the hazards associated with its use and necessary precautions to be taken.
- 3.3.8 Contractor shall ensure that during performance of the work, all hazards to the health of personnel have been indemnified, assessed and eliminated.
- 3.3.9 Chemical spills shall be contained & cleaned up immediately to prevent further, contamination.
- 3.3.10 All personnel exposed to physical agents such as ionizing or non-ionizing radiations ultraviolet rays or similar other physical agents shall be provided with adequate shielding or protection commensurate with the type of exposure involved.
- 3.3.11 Where contact or exposure of hazardous materials could exceed limits or could otherwise have harmful affects, appropriate personal protective equipments such as gloves, goggles, aprons chemical resistant clothing and respirator shall be used.
- 3.3.12 Suitable facilities for toilet, drinking water, proper lighting shall be provided at site and labor camps, commensurate with applicable Laws/Legislation.

	COMPOSITE SUPPLY CUM ERECTION OF ELECTRICAL & INSTRUMENTATION WORKS FOR OSBL FACILITIES ON ITEM RATE BASIS AT TALCHER FERTILIZERS LTD., ANGUL, ODISHA HEALTH, SAFETY AND ENVIRONMENT (HSE) MANAGEMENT	PC-183/ E-8003/ S-V	0	
		DOC. NO.	REV	
		Page 7 of 18		

3.3.13 Contractor shall ensure storage and utilization methodology of materials that are not detrimental to environment. Where required, Contractor shall ensure that only the environment friendly materials are selected.

3.3.15 All persons deployed at site shall be knowledgeable of and comply with the environment laws, rules & regulations relating to the hazardous materials substances and wastes. Contractor shall not dump release or otherwise discharge or dispose off any such materials without the express authorization of Consultant / Owner.

4.0 DETAILS OF HSE MANAGEMENT SYSTEM BY CONTRACTOR

4.1 On Award of Contract



The Contractor shall prior to start of work submit his Health, Safety and Environment Manual or procedure and HSE Plans for approval by Consultant/Owner. The contractor shall participate in the pre-start meeting with Consultant/Owner to finalize HSE Plans including the following.

- Job procedure to be followed by Contractor for activities covering handling of equipments, Scaffolding, Electric Installation, describing the risks involved, actions to be taken and methodology for monitoring each activity.
- Consultant/Owner review /audit requirements.
- Organization structure along with responsibility and authority records/ reports etc on HSE activities.

4.2 During job execution



4.2.1 Implement approved Health, Safety and Environment management procedure including but not limited to as brought out under Para 3.0. Contractor shall also ensure to:

- Arrange workmen compensation insurance registration under ESI Act third party liability insurance etc, as applicable:
- Arrange all HSE permits before start of activities (as applicable) like hot work, confined space, work at heights, storage of chemicals/explosive materials and its use and implement all precautions mentioned their in.
- Submit timely the completed checklist on HSE activities, Monthly HSE reports, accident reports, and investigation reports etc as per Consultant/Owner requirements. Compliance of instructions on HSE shall be done by contractor and informed urgently to Consultant /Owner.
- Ensure that resident Engineer/Site-In-Charge of the Contractor shall attend all the Safety Committee/HSE meetings arranged by Consultant/Owner. Only in

	COMPOSITE SUPPLY CUM ERECTION OF ELECTRICAL & INSTRUMENTATION WORKS FOR OSBL FACILITIES ON ITEM RATE BASIS AT TALCHER FERTILIZERS LTD., ANGUL, ODISHA HEALTH, SAFETY AND ENVIRONMENT (HSE) MANAGEMENT	PC-183/ E-8003/ S-V	0	
		DOC. NO.	REV	
		Page 8 of 18		

case of his absence from site that a second senior most person shall be nominated by him in advance and communicated to Consultant/Owner.

- Display at site office and work locations caution boards list of hospitals emergency services available.
- Provide posters, banners for safe working to promote safety consciousness.
- Carry out audits/inspection at sub-contractor works as per approved HSE document & submit the reports for Consultant/Owner review.
- Assist in HSE audits by Consultant /Owner and submit compliance reports
- Generate & submit HSE records/report as per HSE Plan.
- Appraise Consultant /Owner on HSE activities at site.

	COMPOSITE SUPPLY CUM ERECTION OF ELECTRICAL & INSTRUMENTATION WORKS FOR OSBL FACILITIES ON ITEM RATE BASIS AT TALCHER FERTILIZERS LTD., ANGUL, ODISHA HEALTH, SAFETY AND ENVIRONMENT (HSE) MANAGEMENT	PC-183/ E-8003/ S-V	0	
		DOC. NO.	REV	
		Page 9 of 18		

ANNEXURE -1A

RELEVANT IS - CODES FOR PERSONAL PROTECTION

IS: 2925 - 1984	Industrial Safety Helmets
IS: 4770 - 1968	Rubber gloves for electrical purposes
IS: 6994 - 1973 (Part-I)	Industrial Safety Gloves (Leather & Conon Gloves)
IS: 1989 - 1986 (Part -I & III)	Leather safety boots and shoes
IS: 3738 - 1975	Rubber knee boots
IS: 5557 - 1969	Industrial and Safety rubber knee boots
IS: 6519 - 1971	Code of practice for selections, care and repair of Safety footwear
IS: 11226 - 1985	Leather Safety footwear having direct moulding sole
IS: 5983 - 1978	Eye protectors
IS: 9167 -1979	Ear protectors
IS: 3521 -1983	Industrial Safety belts and harness



NOTE:

For necessary Codes for safety/Environmental requirement, concerned statutory authorities may be consulted.

ANNEXURE –1B

1.0 HEALTH SAFETY & ENVIRONMENT (HSE) PLAN

<p><u>HEALTH SAFETY & ENVIRONMENT (HSE) PLAN</u></p> <p>Project: Contractor: Date: Owner: (To be prepared by each construction Agency)</p>						
Activity description	Procedure /with guide lines	Code of Conformance	Performing function			Audit function
			Performer	Checker	Approver	

	COMPOSITE SUPPLY CUM ERECTION OF ELECTRICAL & INSTRUMENTATION WORKS FOR OSBL FACILITIES ON ITEM RATE BASIS AT TALCHER FERTILIZERS LTD., ANGUL, ODISHA HEALTH, SAFETY AND ENVIRONMENT (HSE) MANAGEMENT	PC-183/ E-8003/ S-V	0	
		DOC. NO.	REV	
		Page 11 of 18		

2.0 MONTHLY HSE CHECKLIST CUM COMPLIANCE REPORT (1/6)

PROJECT:

CONTRACTOR:



DATE:

OWNER:

INSPECTION BY:



NOTE: Write N.A. where the item is not applicable.

ITEM	Yes	No	Remarks	Action
HOUSEKEEPING				
Waste containers provided and used				
Sanitary facilities adequate and clean				
Passageways and walkways clear				
General neatness of working areas				
Other				
PERSONAL PROTECTIVE EQUIPMENTS				
Goggles, Shields				
Face protection				
Hearing protection				
Safety shoes provided				
Hand protection				
Respiratory mask etc.				
Safety belts				
Other				
EXCAVATION / OPENINGS				
Opening properly covered or barricaded				
Excavation shored				
Excavation barricaded				
Overnight lightening provided				
Other				

	COMPOSITE SUPPLY CUM ERECTION OF ELECTRICAL & INSTRUMENTATION WORKS FOR OSBL FACILITIES ON ITEM RATE BASIS AT TALCHER FERTILIZERS LTD., ANGUL, ODISHA HEALTH, SAFETY AND ENVIRONMENT (HSE) MANAGEMENT	PC-183/ E-8003/ S-V	0	
		DOC. NO.	REV	
		Page 12 of 18		

MONTHLY HSE CHECKLIST CUM COMPLIANCE REPORT (2/6)



ITEM	Yes	No	Remarks	Action
WELDING ,CUTTING				
Gas cylinders chained upright				
Cables and hoses not obstructing				
Screens or shields used				
Flammable materials protected				
Fire extinguisher (s) accessible				
other				
SCAFFOLDING				
Fully decked platforms				
Guard and intermediate rails in place				
Toe boards in place				
Adequate shoring				
Adequate access				
Other				
LADDERS				
Extension side rails 1 m above				
Top of landing				
Properly secured				
Angle $\pm 70^\circ$ from horizontal				

	COMPOSITE SUPPLY CUM ERECTION OF ELECTRICAL & INSTRUMENTATION WORKS FOR OSBL FACILITIES ON ITEM RATE BASIS AT TALCHER FERTILIZERS LTD., ANGUL, ODISHA HEALTH, SAFETY AND ENVIRONMENT (HSE) MANAGEMENT	PC-183/ E-8003/ S-V	0	
		DOC. NO.	REV	
		Page 13 of 18		

Other				
-------	--	--	--	--

MONTHLY HSE CHECKLIST CUM COMPLIANCE REPORT (Contd. 3/6)

ITEM	Yes	No	Remarks	Action
HOISTS, CRANES AND DERRICKS				
Condition of cables and sheaves OK				
Condition of slings, chains hooks and eyes O.K.				
Inspection and maintenance logs maintained				
Outriggers used				
Sign/l barricades provided				
signals observed and understood				
Qualified operators				
Other				
MACHINERY, TOOLS AND EQUIPMENT				
Proper instruction				
Safety devices				
Proper cords				
Inspection and maintenance				
Other				
VEHICLE AND TRAFFIC				
Rules and regulations observed				
Inspection and maintenance				



	COMPOSITE SUPPLY CUM ERECTION OF ELECTRICAL & INSTRUMENTATION WORKS FOR OSBL FACILITIES ON ITEM RATE BASIS AT TALCHER FERTILIZERS LTD., ANGUL, ODISHA HEALTH, SAFETY AND ENVIRONMENT (HSE) MANAGEMENT	PC-183/ E-8003/ S-V	0	
		DOC. NO.	REV	
		Page 14 of 18		

Licensed drivers				
Others				

MONTHLY HSE CHECKLIST CUM COMPLIANCE REPORT (Contd. 4/6)



ITEM	Yes	No	Remarks	Action
TEMPORARY FACILITIES				
Emergency instructions posted				
Fire extinguisher provided				
Fire-aid equipment available				
Secured against storm damage				
General neatness				
In accordance with electrical requirements				
Other				
FIRE PREVENTION				
Personnel instructed				
Fire extinguishers checked				
No smoking in prohibited areas.				
Hydrants Clear				
Other				
ELECTRICAL				
Proper wiring				
ELCB's provided				
Ground fault circuit interrupters				
Protection against damage				
Prevention of tripping hazards				
Other				

MONTHLY HSE CHECKLIST CUM COMPLIANCE REPORT (Contd. 5/6)

	COMPOSITE SUPPLY CUM ERECTION OF ELECTRICAL & INSTRUMENTATION WORKS FOR OSBL FACILITIES ON ITEM RATE BASIS AT TALCHER FERTILIZERS LTD., ANGUL, ODISHA HEALTH, SAFETY AND ENVIRONMENT (HSE) MANAGEMENT	PC-183/ E-8003/ S-V	0	
		DOC. NO.	REV	
		Page 15 of 18		



ITEM	Yes	No	Remarks	Action
HANDLING AND STORAGE OF MATERIALS				
Properly Stored or stacked				
Passageways clear				
Other				
FLAMMABLE GASES AND LIQUIDS				
Container clearly identified				
Proper storage				
Fire extinguishers nearby				
Other				
WORKING AT HEIGHT				
Erection plan				
Safety nets				
Safety belts and lanyards: chute lines				
Other				
ENVIRONMENT				
Chemical and other Effluents properly disposed				
Cleaning liquid of pipes disposed off properly				
Sea water used for hydro-testing disposed off as per agreed procedure				
Lubricant waste/Engine oils properly disposed				
Waste from Canteen, offices, sanitation etc disposed properly				
Disposal of surplus earth stripping materials Oily rags and combustible materials done properly				
Green belt protection				

MONTHLY HSE CHECK LIST CUM COMPLIANCE REPORT (Contd. 6/6)

	COMPOSITE SUPPLY CUM ERECTION OF ELECTRICAL & INSTRUMENTATION WORKS FOR OSBL FACILITIES ON ITEM RATE BASIS AT TALCHER FERTILIZERS LTD., ANGUL, ODISHA HEALTH, SAFETY AND ENVIRONMENT (HSE) MANAGEMENT	PC-183/ E-8003/ S-V	0	
		DOC. NO.	REV	
		Page 16 of 18		

ITEM	Yes	No	Remarks	Action
HEALTH CHECKS				
Hygienic conditions at labour camps O.K.				
Availability of first Aid facilities				
Proper sanitation at site ,office and labour camps				
Arrangement of medical facilities				
Measures for dealing with illness				
Availability of potable drinking water for working and staff				
Provision of crèches for children				

(Signature of Resident Engineer with Seal)

	COMPOSITE SUPPLY CUM ERECTION OF ELECTRICAL & INSTRUMENTATION WORKS FOR OSBL FACILITIES ON ITEM RATE BASIS AT TALCHER FERTILIZERS LTD., ANGUL, ODISHA HEALTH, SAFETY AND ENVIRONMENT (HSE) MANAGEMENT	PC-183/ E-8003/ S-V	0	
		DOC. NO.	REV	
		Page 17 of 18		



3.0 **ACCIDENT CUM FIRE REPORT**

STANDARD TFL FORMAT SHALL BE SUPPLIED AT SITE

4.0 **SUPPLEMENTRY ACCIDENT & INVESTIGATION REPORT**

STANDARD TFL FORMAT SHALL BE SUPPLIED AT SITE

5.0 MONTHLY HEALTH, SAFETY & ENVIRONMENT (HSE) REPORT
 (To be submitted by each Contractor)

	COMPOSITE SUPPLY CUM ERECTION OF ELECTRICAL & INSTRUMENTATION WORKS FOR OSBL FACILITIES ON ITEM RATE BASIS AT TALCHER FERTILIZERS LTD., ANGUL, ODISHA HEALTH, SAFETY AND ENVIRONMENT (HSE) MANAGEMENT	PC-183/ E-8003/ S-V	0	
		DOC. NO.	REV	
		Page 18 of 18		

Actual work start Date:
Project:
Name of the Contractor:
Name of work:

For the Month of:
Report No:
Status as on:
Name of safety officer:

ITEM	THIS MONTH	CUMMULATIVE
Total Strength (Staff + Workmen)		
Number of HSE meetings organized at site		
Number of HSE awareness programs conducted at site		
Whether workmen compensation policy taken		
Whether workmen compensation policy is valid		
Whether workmen registered under ESI Act		
No. of fatal accidents		
Number of Loss time accidents(other than fatal)		
Other accidents (Non Loss Time)		
Total No. of Accidents		
Total man-hours worked		
Man-hour loss due to fire and accidents		
Compensation cases raised with Insurance		
Compensation cases resolved and paid to workmen		
Remarks		

Date:

Safety Officer / Resident Engineer

(Signature and name)

To:

OWNER..... 1 Copy
RCM/SITE-IN-Charge (CONSULTANT) 1 Copy

 PROJECTS & DEVELOPMENT INDIA	PC183/E-8003/SEC- VI	0	
	DOCUMENT NO.	REV.	
	SHEET 1 OF 1		

TALCHER FERTILIZER LIMITED

TENDER DOCUMENT OF

ELECTRICAL & INSTRUMENTATION SUPPLY CUM ERECTION WORKS

SECTION-VI

**PROJECT: INTEGRATED COAL BASED FERTILISER COMPLEX
AT TALCHER, ANGUL DISTRICT, ODISHA (INDIA)**

0	07.03.2023	07.03.2023	ISSUED FOR TENDER	RK	SKB	SKB
REV	REV DATE	EFF DATE	PURPOSE	PREPD	REVWD	APPD

 पी डी आई एल PDIL	PROJECTS & DEVELOPMENT INDIA LTD.	PC183/E/8003_Master Index	0	
		DOC. NO.	REV.	
		Page 1 of 1		



MASTER INDEX

NIT NO. : PNP/PC183/E/8003

NIT DESCRIPTION: ELECTRICAL & INSTRUMENTATION SUPPLY CUM
ERECTION WORKS

SECTION VI

PART II: TECHNICAL		
SECTIONS	TECHNICAL SPECIFICATIONS	DOCUMENT NUMBER
1	PROJECT DESCRIPTION & SCOPE OF WORK	PC183/E/8003/SecVI-1.0
2	TECHNICAL SPECIFICATION – ELECTRICAL	PC183/E/8003/SecVI-2.0
3	TECHNICAL SPECIFICATION – INSTRUMENTATION	PC183/E/8003/SecVI-3.0
4	DRAWINGS & DOCUMENTS	PC183/E8003/SecVI-4.0
5	Vendor List	PC183/E/8003/SecVI-5.0
SCHEDULE OF RATE		
1	SCHEDULE OF RATE	PC183/E/8003/Sec-VII



 PROJECTS & DEVELOPMENT INDIA LTD	PC183/E/8003/S-VI/1.0	0	
	DOCUMENT NO	REV	
	SHEET 1 OF 4		

SECTION-VI-1.0

PROJECT DESCRIPTION & SCOPE OF WORK

PLANT: COMPOSITE SUPPLY CUM ERECTION OF ELECTRICAL & INSTRUMENTATION WORKS FOR OSBL FACILITIES

PROJECT: INTEGRATED COAL BASED FERTILISER COMPLEX AT TALCHER, ANGUL DISTRICT, ODISHA (INDIA)

 COMPOSITE SUPPLY CUM ERECTION OF ELECTRICAL & INSTRUMENTATION WORKS FOR OSBL FACILITIES AT TFL, TALCHER	PC183/E/8003/S-VI/1.0	0	
	DOCUMENT NO	REV	
	SHEET 2 OF 4		

1. PROJECT DESCRIPTION

Talcher Fertilizers Ltd. (TFL), a joint venture company of four major Public Sector Units – M/s GAIL (India) Limited (GAIL), M/s Rastriya Chemicals & Fertilizers Ltd. (RCF), M/s Coal India Ltd. (CIL) and M/s Fertilizers Corporation of India Ltd. (FCIL) is in the process of establishing a world class Coal based fertilizer complex at Talcher, Angul District, Odisha (India).

The plant will be consisting Coal Gasification Plant, Ammonia Plant and Urea Plant, along with Offsite and Utility facilities, various offices for functional & administrative requirements etc. Besides above plants & facilities, TFL shall also have its own township complex.



This tender document is intended to cover the activities and services in respect of all the work relates to Electrical and Instrumentation supply cum Erection for OSBL facilities, at Talcher Fertilizer Limited Orissa, India.

2. GENERAL SPECIFICATIONS

The Contractor shall inspect and examine the site and its surrounding and shall satisfy himself before submitting his bid as to the nature of the ground and subsoil, the form and nature of the site, the quantum and the nature of work and material necessary for successful completion of the works and the means of access to site and in general shall himself obtain all necessary information as to risks, contingencies and other circumstances which may influence or affect his Tender. Under no circumstances, extra payment consequent on any misunderstanding or otherwise on the part of the Contractor shall be allowed.

The Contractor shall have to take all safety precaution to protect all the existing equipment, structures, facilities and buildings etc. from damage. In case, any damage occurs due to the activities of the Contractor on account of negligence, ignorance, accidental or any other reasons whatsoever, the damage shall be made good by the Contractor at his own cost to the satisfaction of the Owner / Consultant. The Contractor shall have to take also all necessary safety measure, at his own cost, to avoid any harm/ injury to his workers and staff and facilities of the existing plant.

The work to be performed under the Scope of Work consists of providing all labour, materials except if indicated in Schedule of Rates, supervision, scaffolding,

 COMPOSITE SUPPLY CUM ERECTION OF ELECTRICAL & INSTRUMENTATION WORKS FOR OSBL FACILITIES AT TFL, TALCHER	PC183/E/8003/S-VI/1.0	0	
	DOCUMENT NO	REV	
	SHEET 3 OF 4		

construction equipment, tools, tackles and plants, supplies, transportation, all incidental items though not indicated or specified, but reasonably implied or necessary for successful completion of the work including Contractor's supervision.



Sampling & testing of material & equipment shall be done as per relevant clauses of BIS & shall not be paid extra. The contractor shall preferably establish a laboratory at site for all relevant site tests as per BIS requirements.

3.0 BROAD SCOPE OF WORK

“Scope of work of the Contractor shall include Procurement, Supply, Fabrication, Erection, Inspection by Third Party Inspection Agency (TPIA), Insurance, Transportation of all Electrical & Instrumentation materials to work site, Storage, erection, testing at site and commissioning of complete electrical system required for ‘Electrical & Instrumentation Supply Cum Erection Works.

The brief details of work (but not limited to) are summarized hereunder-

- a. Design, manufacture, testing of equipment/ cables/ cable trays/ earthing and other erection materials etc at manufacturer’s works, submission of documents with manufacturer’s test reports/ type test reports to Owner/ Consultant prior to inspection call..
- b. Quality Assurance at each stage of manufacture including procurement of raw materials/ bought out items and arranging inspections by Owner/ Consultant/Third
- c. Packing, loading, forwarding, delivery at site/ store, loading/ unloading, storage as per manufacturer’s recommendation; shifting from stores and handling in store as well as at site for erection
- d. Arrangement of testing/ checking instruments/ kits/ sets/ apparatus with valid calibration certificates issued by duly accredited laboratories/ institutions, to carry out tests stipulated in specification and documents referred therein/ other applicable standards)
- e. Installations of equipment/ cables/ materials
- f. Conducting pre-energisation tests to ensure that installation is fit to be energized
- g. Conducting functional/ pre-commissioning checks/ Cold trial runs; no-load & load tests.
- h. Installation and Commissioning.
- i. Conducting Performance Guarantee tests and taking corrective steps (inclusive of replacement of equipment/ materials if required) till results are satisfactory/ acceptable.

 COMPOSITE SUPPLY CUM ERECTION OF ELECTRICAL & INSTRUMENTATION WORKS FOR OSBL FACILITIES AT TFL, TALCHER	PC183/E/8003/S-VI/1.0	0	
	DOCUMENT NO	REV	
	SHEET 4 OF 4		

- j. Conducting Pre-Acceptance Tests/ checks and tabulating the results/ observations
- k. The scope of work shall also include digging of earth and refilling for directly buried cables, earth strips, cable protection pipes, earth pits, ground mounted lighting pole foundations; civil works such as making earth pit inspection chambers with covers, grouting of equipment base plate, channels, supports and foundation bolts, chipping of concrete or in brick work for earth strips, pipes or other minor chipping for foundation preparation, if required, cutting holes in walls for racks, risers, light fitting brackets, sealing of cable entries and making good the same after installation of the equipment and levelling, and other minor similar jobs as per directions of Owner / Engineer-in-Charge.
- l. Minor civil work (like cutting, chipping, grouting, making opening in floor / wall etc. for equipment foundation and cabling work) pertaining to electrical equipment are in the scope of work of the contractor.

The detailed scope of work shall be as per NIT document.

4.00 TENDER DRAWINGS

The drawings listed in the NIT forming part of the specification shall supplement the requirements specified herein. These drawings are preliminary drawings for bidding purpose only and subject to changes that may be necessary during the detailed engineering. In case of any conflict's contradiction among various volumes/sections/annexure/chapters / appendices / tender drawings of bid documents, the same shall be referred to the Owner/PMC for clarifications whose decision shall be final and binding. No extra claims shall be allowed on this account.



 पी डी आई एल PDIL	PROJECTS & DEVELOPMENT INDIA LIMITED	PC183/E/8003/SecVI-2.0	0	 Talcher Fertilizers
		Document No.	Rev	
		Sheet 1 of 109		

SECTION VI- 2.0
TECHNICAL SPECIFICATION
ELECTRICAL WORKS (SUPPLY & ERECTION)

**PLANT : ELECRTICAL & INSTRUMENTATION SUPPLY
CUM ERECTION WORKS**



**PROJECT : INTEGRATED COAL BASED FERTILISER
COMPLEX, AT TALCHER, ANGUL DISTRICT,
ODISHA (INDIA)**

0	06.03.2023	06.03.2023	Issued for Tender	RK	SKB	SKB
REV	REV DATE	EFF DATE	PURPOSE	PREPD	REVWD	APPD

	ELECTRICAL & INSTRUMENTATION SUPPLY CUM ERECTION WORKS TECHNICAL SPECIFICATION ELECTRICAL WORKS (SUPPLY & ERECTION)	PC183/E/8003/SecVI-2.0	0	
		Document No.	Rev	
		Sheet 2 of 109		

CONTENTS



SECTION NUMBER	DESCRIPTION
1.0	Scope
2.0	Basis of Design
3.0	Area Classification
4.0	System Details and Utilization Voltages
5.0	Power Supply and Distribution
6.0	Sub Station
7.0	Protection & Metering
8.0	Control and Monitoring
9.0	Equipment Specification
10.0	Cabling
11.0	Illumination System
12.0	Earthing and Lightning Protection
13.0	Cable Tray
14.0	Capacitor Banks
15.0	Structure
16.0	Spares
17.0	Vendor's Services
18.0	Testing & Inspection
19.0	Documentation
20.0	Tools & Tackles
21.0	Review of Drawings & Documents by Owner/ Consultant
22.0	Vendor List
23.0	Quality Assurance
24.0	Coordination with Other Contractors
	SS & TP of Electrical Equipment and Items.
	Erection Testing & Commissioning specification

	ELECTRICAL & INSTRUMENTATION SUPPLY CUM ERECTION WORKS TECHNICAL SPECIFICATION ELECTRICAL WORKS (SUPPLY & ERECTION)	PC183/E/8003/SecVI-2.0	0	
		Document No.	Rev	
		Sheet 3 of 109		



LIST OF ATTACHMENTS

Technical Specification No.	Description
PC183-TS-0801	PA System
PC183-TS-0803	High Voltage Switchboards
PC183-TS-0805	Medium Voltage Switch Boards
PC183-TS-0805	Medium Voltage Switch Boards
PC183-TS-0807	Bus Duct
PC183-TS-0808	Sheet Steel Distribution Boards
PC183-TS-0809	Lighting Sub Distribution Boards
PC183-TS-0811	Interlocking Sw. Socket and Plug
PC183-TS-0815	Cables
PC183-TS-0816	Prefabricated Ladder Type Cable Racks
PC183-TS-0817	Local Control Stations
PC183-TS-0818	Junction Box
PC183-TS-0822	Capacitor Bank & Associated Equipment
PC183-TS-0829	Auxiliary Service Transformer
PC183-TS-0843	Electrical erection, testing & commissioning

Drg. No	Description
PC183-1251	Single Line Diagram
PC183-1252	Single Line Diagram
PC183-1253	Single Line Diagram
PC183-1254	Single Line Diagram



	ELECTRICAL & INSTRUMENTATION SUPPLY CUM ERECTION WORKS TECHNICAL SPECIFICATION ELECTRICAL WORKS (SUPPLY & ERECTION)	PC183/E/8003/SecVI-2.0	0	
		Document No.	Rev	
		Sheet 4 of 109		

Electrical Sketches	Description
PC183-PDS:E 113	Foundation Details of 11/0.433kV Transformers
PC183-PDS:E 115	Typical Details of Transformer Room Door
PC183-PDS:E 116	Sump Pit for Transformer Oil
PC183-PDS:E 119	Typical Foundation Arrangement for Panels in Sub-Station
PC183-PDS:E 120	Typical Foundation Details for HT/LT Circuit Breaker Panels
PC183-PDS:E 203	Steel Tubular Lighting Pole
PC183-PDS:E 207	Details of Bracket Arm for Street Lighting Pole
PC183-PDS:E 208	Installation Arrangement Area Lighting Fixtures
PC183-PDS:E 210	Junction Box for Street Lighting Pole
PC183-PDS:E 213	Typical Street Lighting Pole
PC183-PDS:E 510	Details of Concrete Cable Trench
PC183-PDS:E 511	Cable Rack Arrangement in Trenches
PC183-PDS:E 516	Typical Arrangement of Cables buried in slit
PC183-PDS:E 530	Pre-Fabricated Cable Tray Straight Run
PC183-PDS:E 531	Pre-Fabricated Cable Tray Horizontal Tee
PC183-PDS:E 532	Pre-Fabricated Cable Tray Horizontal Cross
PC183-PDS:E 533	Pre-Fabricated Cable Tray 900 Horizontal Bends
PC183-PDS:E 534	Pre-Fabricated Cable Tray 900 Vertical Bend Bending Rad. 1000 mm
PC183-PDS:E 535	Pre-Fabricated Cable Tray 900 Vertical Bend Bending Radius 600 mm
PC183-PDS:E 536	Pre-Fabricated Cable Tray Coupling Arrangement
PC183-PDS:E 537	Pre-Fabricated Cable Tray Fixing Arrangement
PC183-PDS:E 538	Pre-Fabricated Cable Tray Reducing Coupler Plate
PC183-PDS:E 601	General Notes on Earthing and Lightning Protection
PC183-PDS:E 602	Earthing Conductor Details
PC183-PDS:E 603	Arrangement of Connections of Earth Conductors
PC183-PDS:E 604	Typical Details of Connection in Earth Pit
PC183-PDS:E 605	Earth Pit Details
PC183-PDS:E 606	Typical Arrangement of Earthing for Motor and Start Stop Push Button
PC183-PDS:E 611	GI/Al Accessories for Earth Electrode
PC183-PDS:E 613	Earthing of storage tank & vessel
PC183-PDS:E 615	GI Earth Bus
PC183-PDS:E 617	Typical Arrangement for Neutral and Equipment Earthing

	ELECTRICAL & INSTRUMENTATION SUPPLY CUM ERECTION WORKS TECHNICAL SPECIFICATION ELECTRICAL WORKS (SUPPLY & ERECTION)	PC183/E/8003/SecVI-2.0	0	
		Document No.	Rev	
		Sheet 5 of 109		

1.0 SCOPE



- 1.1 The scope includes work/service for engineering, manufacture, testing at works, Third Party Inspection, supply of all electrical equipment, dispatch, storage, handling, erection, testing at site and commissioning of complete electrical system required for 'Electrical & Instrumentation Supply Cum Erection Works'.
- 1.2 This specification shall be read in conjunction with all drawing and documents attached and other relevant reference as specified therein.
- 1.3 In this Electrical & Instrumentation Supply Cum Erection Works enquiry, the following works are to be executed as a minimum but not limited to:-
- 1.3.1 Supply of Electrical Equipments and Erection Accessories.
- 1.3.2 Coordination, General Services etc
- a. Preparation of drawings/ document/ to suit Project implementation schedule. Preparation of drawings/ documents/ calculations/ formats/ test reports/ test certificates; Erection, Testing & Commission Manuals/ Operations & maintenance Manuals/ Reports/ QAP etc for approval/ Review/ reference/ record and/ or for any other requirement; submission to Owner/ Consultant in requisite sets, getting approval from Owner/ Consultant, making approved copies available to manufacturers, inspectors, erection & commissioning engineers, supervisors, owner/ Consultant etc as required in requisite sets well before those are actually required by them to fulfil their obligations.
 - b. Design, manufacture, testing of equipment/ cables/ cable trays/ earthing and other erection materials etc at manufacturer's works, submission of documents with manufacturer's test reports/ type test reports to Owner/ Consultant prior to inspection call.
 - c. Quality Assurance at each stage of manufacture including procurement of raw materials/ bought out items and arranging inspections by Owner/ Consultant/ Third Party.
 - d. Obtaining dispatch clearance from Owner in writing.
 - e. Packing, loading, forwarding, delivery at site/ store, loading/ unloading, storage as per manufacturer's recommendation; shifting from stores and handling in store as well as at site for erection.
 - f. Arrangement of testing/ checking instruments/ kits/ sets/ apparatus with valid calibration certificates issued by duly accredited laboratories/ institutions, to carry out tests stipulated in specification and documents referred therein/ other applicable standards.
 - g. Deputing electrical contractors, supervisors electricians, cable jointers etc. on full time basis. for carrying out electrical work.
 - h. Installations of equipment/ cables/ materials. Erection of electrical equipments supplied by the contractor and free issue items (supplied by the owner).
 - a. Conducting pre-energisation tests to ensure that installation is fit to be energized.
 - b. Erection shall not be considered complete unless pre-energisation tests are carried out, results are tabulated & submitted to owner/ consultant and results are found satisfactory.
 - c. Conducting functional/ pre-commissioning checks/ Cold trial runs; no-load & load tests,
 - d. Commissioning the installation.

	ELECTRICAL & INSTRUMENTATION SUPPLY CUM ERECTION WORKS TECHNICAL SPECIFICATION ELECTRICAL WORKS (SUPPLY & ERECTION)	PC183/E/8003/SecVI-2.0	0	
		Document No.	Rev	
		Sheet 6 of 109		

- e. Conducting Performance Guarantee tests and taking corrective steps (inclusive of replacement of equipment/ materials if required) till results are satisfactory/ acceptable.
- f. Conducting Pre-Acceptance Tests/ checks and tabulating the results/ observations
- g. Liquidations of defects/ discrepancies/ observations noted during erection, pre-energisation tests, commissioning, trial runs, performance guarantee tests, Pre-acceptance tests/ checks etc.
- h. Submissions of all final/ 'As built' drawings/ documents after incorporation of changes made in soft as well as hard copies, duly certified by Contractor to the effect that those are 'Final' and/ or 'As built'
- i. Conducting Final Acceptance Tests/ Checks
- j. Co-ordinate with the Owner/ Consultant, other contractors/ agencies working at site as required for proper, smooth and timely execution of work/ implementation of the project
- k. Preparation of drawings/ documents, applications for getting the installation inspected and approved by Electrical Inspectorate of state and/ or Central Electricity Authority and all coordination for getting the installation approved for energisation & use. Carrying out all modifications/ alterations required by statutory authorities. All expenses on these activities shall be carried out and borne by Contractor. The obligation of owner shall be limited to
 - Signing of application as Owner of installation and
 - Payment of fee for inspection of installation.

Approved drawings and certificates shall be submitted to the Owner/Consultants well ahead of schedule so that the actual commissioning of equipment does not get delayed for want of inspection and approval by the Electrical Inspectorate and other statutory bodies. The actual inspection work by the Electrical Inspector shall be arranged by the Contractor and necessary coordination and liaison work in this regard shall be the responsibility of the Contractor.

- 1.3.3 It is an essential requirement that bidder must visit to M/s TFL's plant site for assessment of nature and quantum of work involved including Hook-ups and facilities available at site at their own cost without any commercial implications to Owner before submitting the techno-commercial bid.
- 1.3.4 The scope of work shall also include digging of earth and refilling for directly buried cables, earth strips, cable protection pipes, earth pits, ground mounted lighting pole foundations; civil works such as making earth pit inspection chambers with covers, grouting of equipment base plate, channels, supports and foundation bolts, chipping of concrete or in brick work for earth strips, pipes or other minor chipping for foundation preparation, if required, cutting holes in walls for racks, risers, light fitting brackets, sealing of cable entries and making good the same after installation of the equipment and levelling, and other minor similar jobs as per directions of Owner / Engineer-in-Charge.
- 1.3.4 All minor civil work (like cutting, chipping, grouting, making opening in floor / wall etc. for equipment foundation and cabling work) pertaining to electrical equipment are in the scope of work of the contractor and shall be done as per technical specification and instruction of Engineer-in-charge.
- 1.4 This Technical Specification contains specifications of the major equipments to indicate the basic requirement and serve as a guideline. However, it shall be the responsibility of the contractor to offer a complete quality electrical system of superior quality, even if the specifications of certain items are not given.. The items for which technical specifications

	ELECTRICAL & INSTRUMENTATION SUPPLY CUM ERECTION WORKS TECHNICAL SPECIFICATION ELECTRICAL WORKS (SUPPLY & ERECTION)	PC183/E/8003/SecVI-2.0	0	
		Document No.	Rev	
		Sheet 7 of 109		

are not indicated herein shall be of IS/IEC standard and specifications of these shall be subject to owner's approval in case of order.

- 1.5 The bidder shall offer the best and proven most suitable type of energy efficient equipments manufactured by well known reputed manufacturers having proven performance track record of minimum 2 years , as per vendor list appended in this bid package.

- 1.6 1 No. 415 V Feeder (63 A) at Existing Substation near 132 KV Switchyard shall be made available by Owner for Construction Power. Tapping of Construction Power (on chargeable basis) from this feeder (including supply & erection of all required materials like structural supports for cable tray, cable trays, power cables, control cables, protection & metering, cable termination etc. as well as underground cabling work) and further distribution shall be in Contractor's scope.

In construction Power, Contractor shall ensure that the minimum power factor of 0.9 shall be maintained at their end by providing suitable power factor improvement devices.

Contractor shall have to distribute construction power with adequately rated distribution and sub distribution boards/feeder pillars, power supply cables and other associated materials for feeding loads to carry out construction and fabrication activities at his own cost.

However during non availability of construction power, Contractor shall have to arrange emergency power, if required, through DG set at their own cost.



- 1.7 Contractor shall provide adequate area lighting at site of construction, fabrication yards, storage yard and office etc. by means of suitable lighting fixture, lighting masts, flood lighting poles etc. which are to be supplied and maintained by the contractor as per safety aspect.

- 1.8 For control, monitoring, load management, data logging and printing of status of all important electrical equipment and feeders, a Programmable Logic Controller (PLC)/RTU based Electrical Control and Monitoring System (ECMS) shall be provided by Owner. However, Contractor has to provide the required multifunctional dual channel transducers (Only where Current Data is critical and used in process control) , Digital Multi-function Meters, latest version numerical/Communicable type protective relays with non-volatile memory, comprehensive unit providing protection, metering, control & communication with communication port & interlinked with Online Energy/Load Management System and required microprocessor based devices if any in panels , communicable door mounted Motor Protection Relays in all motor feeders of PMCC & MCC, proper communication facility in supplied UPS, Battery Chargers, VFD, Soft starter , MOV and other critical equipment for proper communication with ECMS / DCS system. The interface of electrical equipments with ECMS / DCS shall be through IEC 61850 communication protocol for Numerical relays and IEC 61850/Modbus for Multifunction Digital Meters, Motor Protection Relay (MPR) and other equipment, Ethernet communication module shall also be used. 100% redundancy shall be provided for communication i.e. the relay should have minimum 2 Nos. IEC-61850 communication port in addition to Front Port.

All connection of numerical relays to Ethernet / Network Switch and looping of MFMs inside the switchboards and Network / Ethernet Switches, as required, for interfacing i.e. all connection / wiring from individual switchboards up to the respective Substation ECMS cabinets and Ethernet / FO cables between the switchboards shall be in Contractor s' scope. However, wiring / connection of Ethernet / FO Cables in I/O Racks shall be in EDS Contractor's scope.

- 1.9 The scope shall also include obtaining all required statutory approvals from all statutory bodies. Contractor shall carry out all modifications/alterations required by statutory bodies.

All approvals for permanent installations shall be obtained in the name of Owner. Approval for equipment & installation for Construction Power shall be in Contractor's name.

	ELECTRICAL & INSTRUMENTATION SUPPLY CUM ERECTION WORKS TECHNICAL SPECIFICATION ELECTRICAL WORKS (SUPPLY & ERECTION)	PC183/E/8003/SecVI-2.0	0	
		Document No.	Rev	
		Sheet 8 of 109		

- 1.10 Quantities indicated in the Schedule of Rates (SOR) are approximate and these may increase or decrease or some items may even be deleted at the time of actual execution.
- 1.11 Successful Bidder shall submit Procedure, Job Method Statement (JMS) and job Safety Analysis (JSA) for approval before starting the work and incorporate all comments / modifications suggested by Owner / Consultant.
- 1.12 Bidder shall depute experienced scheduling engineer to prepare, monitor and update the day to day program and progress of works in the form of Bar chart using software such as Primavera / MS Project etc. as well as to prepare the progress review MOM. The same shall be submitted to PDIL / TFL for review and circulation.
- 1.13 In case of any discrepancies between Technical Specification – Electrical and Technical Specification of equipment/item/work in respect of description of equipment/ item/work, the details indicated in the Technical Specification – Electrical shall prevail.
- 1.14 Final location of equipments as well as route of cable trays shall be finalised during detailed engineering.

2.0 BASIS OF DESIGN



2.1 General

- 2.1.1 Contractor while performing design and engineering activities shall adhere to following guidelines.
- Contractor shall obtain approval from all statutory authorities such as Electrical Inspectorate, CPCB etc. for all electrical facilities including electrical switchboards & panels supplied and installed by contractor.
 - Contractor shall Liaison and in all interface coordination with contractors of other units of project at construction, erection, testing & commissioning phase for any common facility and for smooth execution.
 - Contractor shall clearly specify in their purchase specifications the requirement of conducting special tests/type tests, which are envisaged for various electrical equipment which shall have no impact on cost and time.
 - Bidder shall must visit the site and collect all relevant information required for designing of complete system before quoting. Bidder shall make themselves familiar with the work actually involved and actual site conditions. Failure to do so shall not absolve the Bidder of their responsibilities based on adverse site conditions.

2.2 Statutory requirement Codes and Standards

- 2.3.1 The design, installation, testing & commissioning shall conform to compliance of following statutory requirements :
- Indian Electricity Act
 - Indian Electricity Rules
 - The Indian Factories Act
 - The Indian Explosives Act.
 - Statutory requirement of Govt of Odisha and Govt. of India.
 - Guidelines, instructions, directions issued by Pollution control Boards of state as well as central government. Guidelines, instructions, directions issued by Chief Controller of Explosives (CCoE), CPCB, CMRI, DGMS, CEA etc.
 - Guidelines of Tariff Advisory Committee
 - Guidelines of Insurance Companies Association.
 - Any other applicable Rules/Acts/Regulations.

The design, installation, testing & commissioning shall be in accordance with established codes, good engineering practices and latest versions of following documents valid/ applicable on the date of acceptance of bid. The stipulations in these documents shall be considered as minimum requirements:

	ELECTRICAL & INSTRUMENTATION SUPPLY CUM ERECTION WORKS TECHNICAL SPECIFICATION ELECTRICAL WORKS (SUPPLY & ERECTION)	PC183/E/8003/SecVI-2.0	0	
		Document No.	Rev	
		Sheet 9 of 109		



- Indian Standard Specification or equivalent IEC Standards
- Publications of IEEE
- API Standards
- National Electrical safety Code(NESC)
- Standards of Underwrites laboratory(UL)
- American Society for Testing Material (ASTM)
- American National Standards Institute (ANSI)
- Other International Standards

The CEA clearance for electrical equipment and components thereof shall be obtained by the contractor.



Contractor shall carry out all modifications / alterations required by all statutory bodies. However, necessary statutory fee shall be deposited by the Owner.

2.3 Some of the bare minimum relevant Indian Standards are as listed below. However, system/equipment design shall be in line with latest edition of all applicable standards.

IS: 325, IEC:60034	Three phase induction motors
IS: 335	New insulating oil for transformers and switchgears
IS: 722	AC electricity meters
IS: 732	Code of practice for electrical wiring installations system voltages not exceeding 650V
IS: 737	Specification for wrought aluminum and aluminum alloys, sheet and strip (for engineering purpose)
IS: 996, IEC:60034	Single phase AC motors
IS:1248	Direct acting analogue electrical measuring instruments and their accessories:
IS: 1367 Part-13	Hot dip galvanised coatings on threaded fasteners.
IS: 1646	Code of practice for fire safety of buildings and electrical installations
IS: 1913	General and safety requirements for Luminaries (Tubular fluorescent Lamp)
IS: 2071	Method of high voltage testing
IS: 2099	High voltage porcelain bushings
IEC:62305	Code of practice for the protection of buildings and allied structures against lightning
IS/IEC60079	Electrical apparatus for Explosive gas atmosphere
IS: 2544	Porcelain post Insulators for system with normal voltage greater than 1000 volts
IS: 2633	Methods of testing uniformity of coating on zinc coated articles
IS: 2705	Current Transformers
IS: 3034	Code of practice for fire safety of industrial buildings, electrical generating distributing stations.
IS: 3043	Code of practice for earthing

	ELECTRICAL & INSTRUMENTATION SUPPLY CUM ERECTION WORKS TECHNICAL SPECIFICATION ELECTRICAL WORKS (SUPPLY & ERECTION)	PC183/E/8003/SecVI-2.0	0	
		Document No.	Rev	
		Sheet 10 of 109		

IEC 61869-1	Instrument transformers — General requirements
IS: 11171	Specification for dry type transformers.
IEC 61869-2	Additional requirements for current transformers
IEC 61869-3	Additional requirements for inductive voltage transformers
IS: 3177 IEC60034	Crane duty motors
IS: 3347	Dimensions for porcelain transformer bushings
IS: 3637	Gas operated relays
IS: 3639	Fittings and accessories for power transformers
IS: 3646	Interior illumination: Part I & Part II
IS: 3716	Application guide for insulation co-ordination
IS/IEC:60529	Degree of protection provided by enclosure for rotating electrical machinery
IS: 4722	DC motors
IS: 4759	Hot dip zinc coating on structural steel and allied products
IS: 5082	Specification for wrought Aluminum alloys bars, rods, tubes and sections for electrical purposes
IS: 5561	Electric power connectors
IS: 5571	Guide for selection of electrical equipment for hazardous areas
IS: 5572	Hazardous areas other than mines for electrical insulations area having flammable gases and vapours
IS: 5578	Guide for marking of insulated conductors (1st rev)
IS: 6362	Designation of methods of cooling of rotating electrical machines
IS: 6600	Guide for loading of oil immersed transformers
IS: 6665	Code of practice for Industrial lighting
IS: 7689	Guide for control of undesirable static electricity
IS: 8084	Interconnecting Bus bars for AC voltage above 1 KV upto and including 36 KV
IS: 9676	Reference ambient temperature for electrical equipment
IS: 10028	Code of practice for selection, installation and maintenance of transformers
IS: 10322-1	Specification for Luminaries,Part-1,General requirements
IS: 11353	Guide for uniform system of marking & identification of conductor & apparatus terminals
IS: 11448	Application Guide for AC electricity meters
IS: 12360	Voltage bands for electrical installations including preferred voltage and Frequency
IS: 12459	Code of practice for fire protection of cable runs

	ELECTRICAL & INSTRUMENTATION SUPPLY CUM ERECTION WORKS TECHNICAL SPECIFICATION ELECTRICAL WORKS (SUPPLY & ERECTION)	PC183/E/8003/SecVI-2.0	0	
		Document No.	Rev	
		Sheet 11 of 109		

IS: 12615	Energy efficient motors
IS: 13234	Guide for short circuit calculations
IS: 13346	General requirements for electrical apparatus for explosive gas atmosphere.
IS: 13408	Code of practice for the selection, installation and maintenance of electrical apparatus for use in potentially explosive atmospheres
IEC: 60255	Electrical Relays
ISIEC: 60947	Low voltage switchgear and control gear
IS: 60034-5	Degree of protection provided by Integral design of rotating electrical machines
IS: 60079-0	Explosive atmospheres, Equipment General Requirements
IS: 60079-1	Explosive gas atmospheres – Part-1 Equipment protection by Flame proof enclosures “d”.
IS: 60079-7	Equipment protection by increased safety “e”
SP: 30	National Electrical Codes (NEC) - BIS Publication
IS/IEC 62271	HV Switchboard.
IEC 61439-1/2	LV switchboard (PCC/PMCC/MCC) for TOTAL TYPE TESTED (TTA). Type Test Certificates for short circuit withstand of 50kA for 1 sec. along with ACB mounted in the Switchboards shall apply.
IEC 61641	Switch Board with INTERNAL ARC CONTAINMENT test.
ANSI C-37:23	Metal enclosed bus
ANSI C-37:24	Effect of Solar radiation on metal enclosed bus.
IEC 60034	Rotating Electrical Machinery
IEC 61131	Programmable controllers
IEC 60871-1 /IS 13925	Shunt Capacitors for AC power Systems Specifications



Any other standard may be followed provided it is equivalent or more stringent than the standards specified above.

2.4 In case of any conflict/deviation amongst various documents the order of precedence shall be as follows:

- Statutory rules/regulation
- Technical Specification – Electrical
- Data sheets
- Technical specification – Equipment /Installation Standards, etc.
- Applicable IS/IES standards

In case of contradiction / conflict among documents and statutory requirement, Contractor shall refer to Owner for clarification. However, most stringent specification shall be followed with Owner’s approval. Owner decision shall be considered as final.

2.5 Site Conditions

	ELECTRICAL & INSTRUMENTATION SUPPLY CUM ERECTION WORKS TECHNICAL SPECIFICATION ELECTRICAL WORKS (SUPPLY & ERECTION)	PC183/E/8003/SecVI-2.0	0	
		Document No.	Rev	
		Sheet 12 of 109		

The equipment shall be designed for the following site conditions:-



- Minimum ambient Temperature 1 deg.C
- Maximum ambient Temperature 46 deg.C
- Design Reference Temperature 50 deg.C
- Relative Humidity 100%
- Altitude above mean sea level Lower than 1000 Mtrs.
- Atmospheric pollution Dusty due to presence of Coal Dust & Urea Dust and corrosive due to presence vapours of Ammonia.

Equipment to be installed in MCC rooms/ Electrical Rooms/ Control rooms shall be designed for + 50° C so that in case of failure of Air-conditioning System / Ventilation facilities, the operation/ functioning of equipment is not be affected.

3.0 SYSTEM DETAILS AND UTILIZATION VOLTAGES

3.1 The various voltage levels for in plant power distribution shall be as follows:

A. Normal Power	11KV ± 10%, 50Hz ± 5%, 3Ph, 3 W
B. Emergency Power	Voltage Variation ± 5%, 50Hz ± 3%, 3Ph, 3 W
C. Distribution Equipment	a) 415V±10%, 3 Ph, 4 W/240V ± 10%, 1 Ph, 2W, 50 Hz ± 5% solidly grounded neutral.
Combined variation in voltage & frequency	± 10%
Control Supply for: - 415V motors - Switch Gear Breaker controlled feeders: a. Closing, tripping & spring charging motor b. Auxiliary power	AC 240V ± 10%, 50 Hz ± 5%, 1Ph (For contactor controlled motors)- Electrical UPS located in Substation. DC 110V ± 5% (For breaker controlled motors) – DC 110V ± 5%, 2 W - AC 240V ± 10%, 50 Hz ± 5%, 1Ph, 2W
- Instrumentation and Automation, DCS & Auxiliaries	AC 115 V ± 10%, 50 Hz ± 3% 1Ph, 2W – Instrumentation UPS located at Control Room
Voltage Ratings - Motors above 150 KW up to 1000 KW. -Motors up to150 KW	3.3 KV, 3 Ph AC 415 V, 3 Ph AC
- Space heaters	240V, 1 Ph AC

	ELECTRICAL & INSTRUMENTATION SUPPLY CUM ERECTION WORKS TECHNICAL SPECIFICATION ELECTRICAL WORKS (SUPPLY & ERECTION)	PC183/E/8003/SecVI-2.0	0	
		Document No.	Rev	
		Sheet 13 of 109		

- Lighting	415V/240V AC
- Panic Lights	110V DC
- Power Sockets/Receptacle	415V, 3 Ph AC/240V, 1 Ph AC

3.2 The fault level for 11kV switchboards shall be 40kA for 3 sec.

3.3 The fault level for 415V switchboards shall be 50kA for 1 sec.

3.4 System Earthing

The neutral of 415V supply system shall be solidly earthed.

4.0 PROTECTION & METERING

4.1 Selection and co-ordination of protection and metering system shall be such as to ensure:

- Selective, sensitive and reliable protection of equipment against damage due to internal or external faults or atmospheric discharge.
- Isolation of fault in the shortest possible time.
- Simplicity of the scheme with maximum protection.
- Uninterrupted operation of healthy system.
- Personnel & plant safety.

4.2 Protective relays shall be of latest version, numerical / communicable type with non-volatile memory, comprehensive unit providing protection, metering, control and communicable with communication port for interlinking with online energy/Load Management System. 100% redundancy shall be provided for communication i.e. the Relay should have minimum 2 Nos. IEC-61850 communication port in addition to Front Port.. Numerical Relay shall have communication on IEC-61850 protocol in redundant mode and meters shall have communication on MODBUS protocol. Relay shall have 4 CT input for O/C and E/F protection. There should be option for derivation of E/F internally.

Relay shall meet the requirement for withstanding electromagnetic interference according to relevant parts of IEC 60255 / IEC 61850. Failure of single component within the equipment shall neither cause unwanted operation nor lead to a complete system breakdown.



The relay should support (tested for) IEC 61850 Edition 2 with parallel redundancy protocol as per IEC 62439-3 with two nos. of port and one additional port at front for local communication. Use of any type of converter is not acceptable.

4.3 The Numerical relay shall be provided with integral (no separate unit) arc flash protection system based on both current & light detection method. Relay should have provision of 3 nos. arc sensor, each for cable chamber, busbar chamber & circuit breaker chamber. Sensor shall cover any flash over occurring in the respective chambers. Facility should be there to adapt selective logic schemes for tripping only respective breaker or Incomer breaker.

4.4 The relay should support (tested for) IEC 61850 Edition 2 with parallel redundancy protocol as per IEC 62439-3 with two nos. of port and one additional port at front for local communication. Use of any type of converter is not acceptable.

4.5 Numerical relay shall indicate MWH, MVAR, MVA, V, A, Hz, PF. It shall have future provision for connecting with substation HMI. Separate multifunction meter with communication (for centralized energy monitoring) shall be used and shall not be part of protective device.

4.6 Relays shall support features like remote relay parameterization, disturbance recorder etc. It shall be possible to set/operate the relay from the front facia. Lock out relay shall be conventional type with hand reset facility.



	ELECTRICAL & INSTRUMENTATION SUPPLY CUM ERECTION WORKS TECHNICAL SPECIFICATION ELECTRICAL WORKS (SUPPLY & ERECTION)	PC183/E/8003/SecVI-2.0	0	
		Document No.	Rev	
		Sheet 14 of 109		

- 4.7 Special protection if required for any feeder such as differential, restricted earth fault, directional distance power relays etc. shall also be through numerical relay having serial port for monitoring.
- 4.8 In general all protection shall be through microprocessor based numerical relay. However high speed tripping relay shall be separate.
- 4.9 All Auto-changeover logic to be built in Numerical Relay. Numerical Relays shall have sufficient I/O to cater the same and there should be minimum 10 % spare I/O for future use. External I/O Card/ Module are not acceptable.
- 4.10 All Process Stop and other important Parameters shall be routed through Numerical relays for recording and Time-stamping. Hardware Annunciator is not required. Common Audio Visual Alarm for each Bus section of Switchboard shall be provided through Numerical relays.
- 4.11 Bare minimum protection for power distribution system shall be as indicated below. However, Contractor shall provide any other necessary protection required for complete protection of system..
- 4.12 Protection devices for power distribution system shall be as indicated below (Figure inside bracket refers to note below) (YES – Applicable)



Sl. No.	Relay Description	Relay No.	HV Tr. Fdr. Sec Wdg. Volt=> 3.3 KV	HV Tr. Fdr. Sec Wdg. Volt< 3.3 KV	HV /LV Motor Fdr., HV Breaker controlled contactor controlled	O/G Bkr. HV Plant Fdr.	O/G Bkr. MV PMCC	I/C HV	I/C MV PMCC
1.	IDMTL Over-Current Relay	51	YES	YES	-----	YES	YES	YES (2)	YES
2.	IDMTL Earth-Fault Relay	51N	YES (4)	YES	-----	YES	YES	YES (2)	YES
3.	Standby / Backup Earth Fault Relay (earthed neutral)	51G (11)	YES (24)	YES (24)	-----	-----	-----	-----	-----
4.	Motor Protection Relay with (50, 50N, 46, 49, 50L/R, 95)	99	-----	-----	YES	-----	YES	-----	-----
5.	Instantaneous Restricted Earth Fault Relay (Earthed side)	64R (11)	-----	-----	-----	-----	-----	YES (25)	YES
6.	Instantaneous Over current Relay	50	YES	YES	-----	-----	-----	-----	-----
7.	Instantaneous Earth Fault Relay	50N	YES (5)	YES	-----	-----	-----	-----	-----
8.	Differential Protection Relay	87	YES (6)	-----	YES (7)	YES (8)	-----	-----	-----
9.	High speed tripping relay	86 (20)	YES	YES	YES	YES	YES	YES	YES
10.	Trip Circuit Supervision Relay	95 (20)	YES	YES	YES	YES	YES	YES	YES
11.	Transformer Auxiliary Relay	63	YES	YES	-----	-----	-----	-----	-----
12.	Under Voltage Relay with timer	27 / 2	-----	-----	YES	-----	-----	YES (9)	YES (9)
13.	Check Synchronisation Relay	25	-----	-----	-----	-----	-----	YES (10)	YES (10)
14.									

Notes for Relay Protection Philosophy

- All the numerical relays shall be of communicable type and connected to ECMS on IEC 61850 (Ethernet based) communication protocol with time stamping and time synchronization.
-

	ELECTRICAL & INSTRUMENTATION SUPPLY CUM ERECTION WORKS TECHNICAL SPECIFICATION ELECTRICAL WORKS (SUPPLY & ERECTION)	PC183/E/8003/SecVI-2.0	0	
		Document No.	Rev	
		Sheet 15 of 109		

- 3.
4. Instantaneous earth fault (50N) shall be provided only for transformer with delta primary.
5. Directional IDMTL earth fault (67N) shall be provided for transformer with star primary.
- 6.
- 7.
- 8.
9. Wherever auto-transfer feature is provided.
10. For switchgears where continuous or momentary paralleling of Incomers is envisaged, check synchronizing relay shall be provided.
11. 51G and 64R relays for input transformer of VFD system shall be decided by VFD Manufacturer.
12. The bus tie feeders in HV switchboards shall be provided with 51, 51N, 86 and 95 relays.
- 13.
14. The following feeders shall be provided with timers for delayed tripping on bus under voltage while the under voltage relay shall be common for the bus
 - a. HV and MV capacitor feeders.
 - b. HV and MV breaker controlled motor feeders.
 - c. Contactor controlled motor feeders with DC control supply.
 Numerical relays where ever provided for motor and capacitor feeders shall use in built under voltage relay and timer for delayed tripping on bus under voltage.
15. One no. DC supply supervision relay (80) shall be provided for each incoming DC supply to the switchboard.
16. .
17. In case of numerical relays, all relays shall be comprehensive units including all protection, metering and control.
18. Under voltage and over voltage function along with associated timer shall be part of the numerical relays.
19. Auto changeover scheme control & logic between Incomers and bus coupler shall be built in the numerical relay.
20. Tripping relays (86) shall be separate relay. There shall be two nos. high speed tripping relay for motor feeder. One for electrical fault and one for process fault. Electrical fault relay shall be hand reset type and process fault relay shall be self reset.
21. Breaker control switch shall be hardwired type.
22. Stand by earth fault relay 51G shall be provided in the incomer of switchboard fed from transformers where transformer & switchboard both are located remotely from HV substation as well as in same HV substation.
23. For transformers located remotely away from HV Substation, a local power isolating device in the form of breaker panel without any protection relay shall be provided before transformer. A local emergency stop push button (Lockable) shall also be provided in transformer bay for tripping remote breaker.
24. Restricted earth fault relay 64R shall be provided for transformer rating ≥ 1 MVA in the incomer of switchboard fed from transformers having secondary winding star connected. This shall trip the HV side breaker.
25. .
26. Relay 87 and 64R shall be separate numerical relay. Hence shall not be part of main comprehensive numerical relay. CT for 87 and 64R can be clubbed, as two core of single CT.
27. Accuracy class of the current transformers shall be
 - Class PS for differential and special requirements.
 - Class 0.5 / 0.2 S for metering purpose.
 - Class 5P20 for protection purpose

	ELECTRICAL & INSTRUMENTATION SUPPLY CUM ERECTION WORKS TECHNICAL SPECIFICATION ELECTRICAL WORKS (SUPPLY & ERECTION)	PC183/E/8003/SecVI-2.0	0	
		Document No.	Rev	
		Sheet 16 of 109		

All the CTs shall have rated burden of minimum 15 VA and secondary rated current of 1 A.

28. Accuracy class of the potential / voltage transformers shall be
 - Class 5P for protection purpose.
 - Class 0.5 / 0.2 S for metering purpose.



All the PTs shall have secondary voltage 110 V or 110 V / sqrt.3 and rated burden of minimum 50 VA per phase for both metering and protection core.
29. All the incoming, outgoing and tie breaker feeders of any HV & MV Switchboard shall be provided with numerical relays only with communication facility as protection devices. Releases shall not be acceptable in any case.
30. Numerical relays in all HV motor feeders shall be suitable for RTD / BTD inputs.
31. Each bus section shall be provided with separate under voltage relays.
32. Multifunction meter shall be provided to keep a record of power consumption and supervision of all concerned parameters like current, voltage, power, frequency, power factor etc. as specified. All the metering instruments shall be flush mounted.
33. Separate Communicable Digital Multifunctional meters shall be provided in all feeders with Numerical Relays for communication with ECMS system.
34. Motors shall also be provided with Unbalanced (-Ve) Sequence Protection Relay (46), as required.
35. Numerical under voltage relays (27) with time delay relay including VT fuse failure relay shall be provided for Bus VTs.
36. All Motor feeders of PMCC & MCC (irrespective of Rating) shall have door mounted communicable (Modbus / Profibus) type Motor Protection relay (MPR) with display.
37. No Meters, transducers or measuring equipments to be installed in the Protection CT circuit.
38. Cable Differential relays for both the end to be supplied by Downstream user contractor i.e. Contractor. Cable Differential relay will be of Fiber Optic Cable based communication only.
39. All required Alarms and Trips shall be incorporated in the Numerical relays. Sufficient LED shall be available in the Relays.
40. Trip Circuit Supervision relay shall be part of Numerical relay.
41. All Motors above 5.5KW and Outgoing Feeders above 100A shall Earth Fault protection with CBCT and Digital Earth Fault Relay with display.
42. Capacitor Feeder : 59, 27,50, 51, 50N, 51N, 60, CBFP etc.

4.13 Metering instruments shall be provided to keep record of power consumption and supervision of all concerned parameters like current, voltage, power (Active, Apparent and Reactive), frequency, power factor, Energy (Active & Reactive) etc. All the instruments shall be flush mounted. All meters shall be digital multifunctional meters with communication port for Load management at remote location. Additionally digital type ammeter, voltmeter and Hour Meter shall be provided separately for various feeders as indicated below :

The metering devices in HV and MV switchboards shall be as below:

- Type of metering: Analogue/As part of the Numerical relay
(Figure inside bracket refers to note below) (YES - Applicable)

Sl. No.	Feeder type	A	V	Hz	PF	MW	MWH	HM	MVAR	MVAH	MVA
1.	HV Incomer	YES	YES	YES	YES	YES	YES	----	YES	YES	YES (1)
2.	HV Bus Tie	YES	----	----	----	----	----	----	----	----	----
3.	HV Transformer	YES	----	----	----	YES	YES	----	----	----	----

	ELECTRICAL & INSTRUMENTATION SUPPLY CUM ERECTION WORKS TECHNICAL SPECIFICATION ELECTRICAL WORKS (SUPPLY & ERECTION)						PC183/E/8003/SecVI-2.0	0	
							Document No.	Rev	
							Sheet 17 of 109		

4.	HV Bus PT	----	YES	----	----	----	----	----	----	----	----	----
5.	HV Plant Feeder	YES	----	----	----	----	YES	----	----	----	----	----
6.	HV Motor	YES	----	----	----	----	YES (kWh)	YES	----	----	----	----
7.	HV Capacitor	YES	YES	----	----	----	----	----	YES	----	----	----
8.	PMCC Incomer	YES	YES	----	YES	----	YES (kWh)	----	----	----	----	----
9.	PMCC Bus Tie	YES	----	----	----	----	----	----	----	----	----	----
10.	PMCC Bus PT	----	YES	----	----	----	----	----	----	----	----	----
11.	ACB Outgoing (Non Motor)	YES	----	----	----	----	YES (kWh)	----	----	----	----	----
12.	MV Motor (>55 KW)	YES	----	----	----	----	----	----	----	----	----	----
13.	MCC / ASB Incomer	YES	YES	----	----	----	----	----	----	----	----	----
14.	MCCB O/G (250A and above)	YES	----	----	----	----	YES (kWh)	----	----	----	----	----
15.	MLDB Incomer	YES	YES	----	----	----	YES (kWh)	----	----	----	----	----

Notes for Metering:-



1. MVA meter in external power supply incomers shall include maximum demand indication also.
2. Separate analogue type voltmeters with voltmeter selector switch and analogue type ammeters with ammeter selector switch shall be provided for incomers of all switchboards.
3. Ammeter (size 48mm x 48mm) shall be provided in space heater circuit of breaker fed HV & MV motors.
4. Apart from metering which shall be part of the numerical relays, Communicable digital multi-function meters of Accuracy Class 0.5/ 0.2(for Incomers only with suitable Metering CT shall be provided in all the breaker feeders of HV & MV Switchboard i.e. in incomers, bus coupler, outgoing plant feeders, transformer feeders, motor feeders, capacitor bank feeders, etc.
5. Multi function meters with serial communication over RS-485 or fiber optic cable, preferably with IEC protocol shall be provided in all the breaker feeders.
6. Power factor meter shall be provided for synchronous motors in addition to the metering provided for induction motors.
7. For current feedback to DCS/PLC and VFD feeders motor current transducers shall be provided and mounted in switchgear panel.
8. CT operated Ammeter for all motor feeders above 5.5 KW, all MOV and LOPs shall be provided at both LCS and feeder end of switchboard.
9. All ammeters for LV motors shall be connected through CT. Only HV motors shall have 3 ammeters or ammeter selector switch or Voltmeter and Voltmeter Selector Switch.
10. Hour run meter shall be provided in all breaker controlled motor feeder.

5.0 CONTROL AND MONITORING

The following provision shall be made for control and monitoring of following electrical equipments.

5.1 Transformers

- TNC switch in primary & secondary side of switchgear.
- Emergency trip from secondary side for tripping primary side of transformer.

	ELECTRICAL & INSTRUMENTATION SUPPLY CUM ERECTION WORKS TECHNICAL SPECIFICATION ELECTRICAL WORKS (SUPPLY & ERECTION)	PC183/E/8003/SecVI-2.0	0	
		Document No.	Rev	
		Sheet 18 of 109		

- VCB with all required protection to be considered in 11kV switchboards. .
- Lockable 'OFF' push button in transformer room to trip sending end switchgear.
- Indication lamp for 'ON' 'OFF' 'Auto-trip', 'Non-trip' and 'Trip Circuit Healthy', 'Ready to Close' , 'Ready for Service', 'Test', 'Service', 'Space Heater ON'.
- Ammeter and voltmeter on both primary and secondary side.



5.2 Motors Controlled Through Circuit Breakers

- TNC switch, L/R Switch with Ammeter on LCS
- Current monitoring at DCS/PLC through Dual Channel Current Transducer with Display facility installed at switchgear end, where required from process point of view.
- Indication Lamps in switchgear for 'ON', 'OFF', 'Auto-trip' and 'Trip Circuit Healthy', 'Ready to Start', 'Ready for Service', 'Test', 'Service', 'Space Heater ON, 'Space Heater ON for Motors'.
- Emergency trip in switchgear.
- Winding and bearing temperatures of motors shall be available at DCS in control room.
- Process interlock in CCR, where required.
- Control and Feedback for Motor Start & Stop command, Trip Indication, ON Indication, OFF Indication, Local / Remote Indication and Ready to Start Indication in remote (DCS/PLC etc.)
- Motors controlled through Circuit breakers should also be provided with ammeter, KVAh, KWH and running hour counter. Theses shall be incorporated in Numerical relay Or Multi-function Meter.

5.3 Medium Voltage Motors Controlled Through Contactors

- Start & Stop Push Button (Mushroom Stay Put Type) with Ammeter, Local/Remote switch on LCS
- Current monitoring in DCS, where required from process/Instrument point of view.
- Emergency Trip in PCC/MCC.
- Process interlock in CCR, where required shall be wired through separate auxiliary relay.
- Indication lamp for 'ON', 'OFF', 'Ready to Start' and 'Fault' in switchgear.
- Control and Feedback for Motor Start & Stop command, Trip Indication, ON Indication, OFF Indication, Local / Remote Indication and Ready to Start Indication in remote (DCS/PLC etc.)
- Motor space heater & Panel board space heater shall be provided with Ammeter & LED in Switchgear.
- All Motor feeders of PMCC & MCC (irrespective of Rating) shall have door mounted communicable (Modbus / Profibus) type Motor Protection relay (MPR) with Earth fault protection and display.

6.0 EQUIPMENT SPECIFICATION

	ELECTRICAL & INSTRUMENTATION SUPPLY CUM ERECTION WORKS TECHNICAL SPECIFICATION ELECTRICAL WORKS (SUPPLY & ERECTION)	PC183/E/8003/SecVI-2.0	0	
		Document No.	Rev	
		Sheet 19 of 109		

6.1 General Features

6.1.1 The equipment shall be suitable for tropical climate conditions and corrosive and saline atmosphere.

All electrical equipment accessories and wiring shall have fungus protection involving special treatment of insulation and metal against fungus, insects and corrosion.

Fine mesh screen of corrosion resistant material preferably SS shall be furnish on all ventilating openings to prevent entry of insects.

6.1.2 The equipment to be installed in indoor plant area shall be enclosed in dust, damp and vermin proof enclosure equivalent to IP 65 as per relevant Indian Standards/IEC.

6.1.3 The equipment excluding motors to be installed in outdoor plant area shall have IP 65 enclosure. Motors of plant shall have IP 55 enclosure.

6.1.4 4 mm FRP (fire retardant and UV stabilized) canopies shall be provided for all outdoor equipments like motors, starters, LCS, SDBs, sw. sockets etc. PA stations shall have acoustic hood.

6.1.5 For LV switchgear degree of protection shall be IP 52 up to 1600A rating and IP-4X above 1600A rating. Equipment requiring ventilation opening such as battery charger/UPS etc. located in air conditioning room may have IP 43 enclosure however, opening for the ventilation shall be covered with fine wire mesh.

6.1.6 Creepage distance shall be 31mm/kV (for highest system voltage) for all equipment.

6.1.7 The outside surface of all equipment shall be painted after suitable pre-treatment by the application of two coats of anti-rust and corrosion resisting epoxy based paints.

6.2 Power Transformers

6.2.1 The transformers shall be double wound, copper conductor, and Dyn11 type. Transformers shall rated for 11/0.433 kV, as required.

6.2.2 The rating of power transformers shall be selected keeping following into considerations:

- (a) Duty : Continuous
- (b) Outdoor type : ONAN (ONAN rating shall have 25% spare capacity above continuous peak load)
- (c) Indoor type : Dry Type
Epoxy cast resin/ resin encapsulated type
- (d) Maximum loading : 80% when one of the transformers is out of service
- (e) Peak efficiency at : 35% - 40% of load
- (f) Class of Insulation : B or better for oil filled
: F or better for dry type



6.2.3 Maximum temperature rise over ambient of 50 Degree Celsius shall be limited to:

(a) Outdoor transformers:



- Top oil (measured by thermometer) : 50 ° C
- Winding (measured by resistance) : 55 ° C

(b) Indoor transformers:



- Winding (by resistance method) : 90 ° C or lower as permissible for class of insulation offered

	ELECTRICAL & INSTRUMENTATION SUPPLY CUM ERECTION WORKS TECHNICAL SPECIFICATION ELECTRICAL WORKS (SUPPLY & ERECTION)	PC183/E/8003/SecVI-2.0	0	
		Document No.	Rev	
		Sheet 20 of 109		

- 6.2.4 Special consideration shall be given in specifying the percentage impedance of the transformers to suit the switchgear short-circuit capacity available.
- 6.2.5 Bare minimum protection devices for transformer have been as indicated below; however Contractor shall provide any other necessary protection relays required for complete protection of system.
- Primary Side.
- IDMTL Over Current, IDMTL Earth Fault, High Set Over Current, Instantaneous Earth Fault, Standby Earth Fault, Restricted Earth Fault , Differential (for sizes of 5 MVA and above), *Buchholz Alarm and Trip, *Winding Temperature Alarm,* Trip, *Oil Temperature Alarm, *Oil Level Alarm & Trip, *Trip for Winding Temperature and Oil Temperature. All protection except REF shall be provided on secondary side, if the primary side circuit breaker is located in other sub-station. REF protection shall trip the primary Inter-tripping of primary and secondary circuit breaker of transformer shall be provided for all faults through lockout relays.
- CT for Restricted Earth Fault protection shall be provided in the transformer.
- 6.2.6 High Velocity Water Spray (HVWS) System shall be provided for transformers fire protection having oil capacity more than 2000 Liters and rating upto 20MVA.
- 6.2.7 Following Push buttons shall be provided for transformers :
- Lockable 'OFF' push button in transformer room to trip the breakers on primary side.
 - Push button shall be provided on breaker on secondary side for permission to close breaker on primary side
 - Emergency trip PB on breaker on secondary side for tripping breaker on primary side of transformer.
- 6.2.8 The instruments such as OTI/WTI, Buchholz relay and MOG shall have Magnetic Reed Switches. The mercury switch contacts are not acceptable.
- 6.2.9 For all transformers, conservators shall be provided with Magnetic Oil Gauge (MOG) having 1NO contact activated on Low oil level. For transformers above 2000KVA Air cell shall be provided in the conservator.
- 6.2.10 Transformer rooms shall have slab and shall be under shed.
- 6.2.11 All Routine Tests shall be performed in compliance with B.S.171, IEC publication No.60076, IS 2026 (parts I to V), CBIP and IS: 2026 (Part III) before dispatch from Manufacturer's works and at erection site during commissioning or latest editions or any other authoritative standard. Certificates for Type Tests on similar type Transformers shall be submitted.
- 6.2.12 For all other specification refer PC183-TS-0803.
- 6.3 Capacitor Bank And Associated Equipments**
- 6.3.1 Suitable capacitor bank shall be designed and installed at 415 V voltage level in the substation.
- 6.3.2 Capacitor bank at 3.3 kV and 11 kV shall be considered.
- 6.3.3 The capacitor bank shall utilize the Automatic Power Factor Controllers to maintain the power factor of individual plant. Under no circumstances power factor shall become leading (capacitive) and all necessary protections to avoid this shall be used.
- 6.3.4 Refer Attachment Number PC183-TS-0822.
- 6.4 Switchboards**
- 6.4.1 General

	ELECTRICAL & INSTRUMENTATION SUPPLY CUM ERECTION WORKS TECHNICAL SPECIFICATION ELECTRICAL WORKS (SUPPLY & ERECTION)	PC183/E/8003/SecVI-2.0	0	
		Document No.	Rev	
		Sheet 21 of 109		

- 6.4.1.1 There shall be three positions for Breaker/Contactor trolley: - Service, Test and Isolate. In service position, the power connections shall be made; but in test and isolate mode, the power connection of bus bars shall be automatically removed.
- ACB feeder for PMCC & MCC shall be single front for ease of operation & maintenance. Non-ACB feeders for motors or power may be double front type.
- Breaker duty cycle shall be O-0.3sec-CO-3min-CO.
- Separate CT shall be provided for differential/REF protection.
- LV circuit breaker shall be 4 Pole type except for outgoing motor feeders which shall be 3 Pole type.
- 6.4.1.2 Suitable shutter arrangement shall be provided to protect the person from accidental contact with live bus in trolley chamber.
- 6.4.1.3 The degree of protection shall be IP 4X for HV switchboards. The degree of protection shall be IP 52 for LV Switchboard up to 1600A rating and IP-4X for LV switchboards above 1600A rating.
- 6.4.1.4 All HV, MV & LV Switchboards shall be LOTO compliance. 11 kV & 3.3 kV Switchboard shall conform to IS/IEC 62271-200, IAC-A FLR-50KA/40KA 1 Sec, PM, LSC 2B which means that the switchgear panels shall be four side internal arc tested, shall have metal partitions and shall conform to loss of service continuity. LV switchboard shall conform to IEC 60947. All 3 compartments (Busbars, Circuit breaker & Cable compartment) shall be tested for Internal arc for the said rating.
- 6.4.1.5 The switchgear shall have integral making type earth switch with proper Mechanical & Electrical interlock.
- 6.4.1.6 Each cubicle shall be equipped with anti-condensation heater controlled by thermostat.
- 6.4.1.7 LV switchboard (EPMCC/PMCC/MCC) shall be TOTAL TYPE TESTED (TTA) design as per IEC 61439-1/2. Type Test Certificates for short circuit withstand of 50kA for 1 sec along with ACB mounted in the Switchboards shall be provided.
- 6.4.1.8 LV switchboard (EPMCC/PMCC/MCC) shall comply with Internal Arc Containment test as per IEC 61641.
- 6.4.1.9 The busbars and connection shall be made of electrolytic grade copper only. Aluminium busbars are not acceptable.
- 6.4.1.10 The entry of cables in the switchboards shall be from bottom only.
- 6.4.1.11 All switchboards shall be provided with minimum two incoming feeders and one bus tie having auto/manual changeover facility.
- 6.4.1.12 It shall be possible to have momentary paralleling of power sources at 415V PMCC /PCC/MCC and trip the desired circuit breakers.
- 6.4.1.13 The normal operation of the Power & Motor Control Centre (PMCC) and Motor Control Centre (MCC) shall be as under:
- i. Bus-coupler shall be provided between all the sources. Incomer and Bus-coupler breaker rating shall be same for all the switchboards. Each incoming feeder shall independently feed the loads on respective buses with full rated bus tie breaker open and the load on each bus balanced. In order to ensure maximum degree of reliability and continuity, automatic transfer from one incoming feeder to other shall be possible through auto/manual closing of bus tie breaker in case of sustained loss of power on any bus section.
 - ii. The bus tie breaker shall be provided with auto/manual selection. The bus tie breaker shall be independent in manual mode. In auto selection mode, the bus tie

	ELECTRICAL & INSTRUMENTATION SUPPLY CUM ERECTION WORKS TECHNICAL SPECIFICATION ELECTRICAL WORKS (SUPPLY & ERECTION)	PC183/E/8003/SecVI-2.0	0	
		Document No.	Rev	
		Sheet 22 of 109		

breaker is electrically interlocked with incoming circuit breakers, so that it cannot be closed unless one of the incoming breakers is open.

- iii. When one of the incoming feeder trips, the bus tie breaker is closed automatically based on the philosophy described and the total load is transferred to other healthy incoming feeder which is capable of carrying the entire load. Sufficient switchgear capacity is to be provided. Time for changeover is suitably selected based on downstream system requirement of reacceleration of motors etc.
- iv. Auto Change Over scheme shall be provided for incomer feeders and bus coupler feeder of 11kV switchboard, 3.3kV Switchboards and 415V Switchboards. Under normal operating conditions, incomer-1 and incomer-2 breakers shall be closed and bus coupler breaker shall remain open with 'Local-Remote-Off' switch in 'Remote' position. The bus coupler breaker shall close automatically under the following conditions being fulfilled:
 - Either of the incoming breaker trips due to under voltage (70% or below).
 - Voltage on the healthy bus is more than 80% for the set period.
 - Residual voltage on the bus with no power supply comes down to 30% or below.

Required nos. of bus PT, line PT and under voltage relays shall be provided to achieve the desired automatic changeover.

- v. Auto transfer shall take place only on sustained loss of power on either of bus sections. Auto transfer shall be blocked in case of fault on either of bus sections or no power on both incomers.
- vi. Paralleling of two incoming feeders is not foreseen. However, facility for momentary paralleling shall be provided for intentional changeover without interruption of supply with synchro check relay in Bus Coupler panel. There shall also be provision of selective tripping of one feeder out of three feeders with a Delay (two incoming feeders and one Bus Coupler).

6.4.1.14 An electro-mechanical device shall be provided to ensure the auxiliary circuits have been securely connected between the fixed and moving portions of the switchgear, before allowing closing operation of the circuit breaker. The voltage rating of the device shall be the same as the voltage used for the closing circuit.

6.4.1.15 Tripping and closing coils shall be of continuous rated type to ensure longer life.

6.4.1.16 Circuit breakers shall be provided with a mechanically operated visual indicating device to display the circuit breaker switching state and a mechanical operation counter

6.4.1.17 The circuit breaker operations of closing and opening shall be possible with the circuit breaker compartment door closed.



6.4.1.18 Each control circuit shall be protected by a two-pole miniature circuit breaker with auxiliary N/C contact. The auxiliary contacts of all MCB's of the same circuit type, e.g. circuit breaker motor control, disconnect switch motor control, alarm, space heater, trip, etc., shall be wired in series to a group / common alarm terminal.

6.4.1.19 It shall be possible to trip the circuit breaker locally by mechanical means. Voltage Transformer (VT) shall be cast-resin with built-in primary fuses, VT's shall be draw out type.



6.4.1.20 Voltage transformer shall be independent of circuit breaker carriage

6.4.1.21 Electrical interlocks and castle key interlocks shall be provided between Bus-bar Earthing Switches and all Bus-bar Isolators of each Bus-bar Section in such a way that Bus-bar Earthing Switches can not be closed when the Bus-bar Isolator of any circuit in the section is closed.

6.4.1.22 Bus VT Miniature Circuit Breaker (MCB) ON auxiliary contacts and under voltage relay contacts shall be monitored in the interlocking scheme to confirm the dead bus condition.

	ELECTRICAL & INSTRUMENTATION SUPPLY CUM ERECTION WORKS TECHNICAL SPECIFICATION ELECTRICAL WORKS (SUPPLY & ERECTION)	PC183/E/8003/SecVI-2.0	0	
		Document No.	Rev	
		Sheet 23 of 109		

- 6.4.1.23 All CT & PT must be suitable for continuous operation of min. 20 % overload and for service under all rated and fault conditions.
- 6.4.1.24 Current transformers shall be in accordance with IEC 61869-1 & 61869-2. The rated output shall match the requirements of the equipment connected. The secondary current rating shall be 1 A, .Unless otherwise specified, cores for measuring instruments shall have accuracy classes of not more than 0.5 % and saturation factors less than 5.
- 6.4.1.25 Secondary terminals of current transformers shall be wired up to a terminal block with short-circuiting links, located at an accessible place. At this terminal block one side of each transformer shall be connected to earth.
- 6.4.1.26 The CT rating plate and the terminals must be accessible after the Power cables have been installed.
- 6.4.1.27 Tripping and closing coils shall be of continuous rating type.
- 6.4.1.28 Clearance between gland plate to cable termination point in all switchboards shall be adequate but not less than 300mm to ensure proper cable termination.
- 6.4.1.29 FRP supports shall be used for bus bars with adequate clearances and creepage distance to prevent flash over due to effect of dust moisture.
- 6.4.1.30 Protective relays shall be mounted on the front of the switchgear panel.
- 6.4.1.31 All logic like, Auto/Manual changeover etc. shall be built in the Numerical relay. Adequate number of I/Os shall be provided to meet the requirement. 10% spare I/Os shall also be provided. External I/O Card/ Module is not acceptable.
- 6.4.1.32 All relays used for protection shall be microprocessor based numerical type only with latest communication protocol IEC-61850 and shall have large graphical display. All relays shall have coating for protection against harsh environment conditions. All numerical relays shall be of one make only. Selected models of numerical relays shall have metering, control, status and protective functions. It shall be possible to save minimum 5 records of each event. Important functions and features, in addition to the fault measuring capabilities, shall include:
- Programmable scheme logic,
 - Remote communication interface for setting / interrogation from ECMS,
 - Local communication interface (HMI-keypad and / or serial PC communication),
 - Time-tagged events, fault and disturbance records,
 - Display of measured/processed quantities,
 - Self-monitoring (Hardware / Software),
 - Inter-protection communication,
 - Electronic transducer communication.
- 6.4.1.33 All protection relays shall be provided with test plugs and all CT, VT wiring shall be wired through the test plugs LV Switchboards.
- 6.4.1.34 The protection scheme(s) shall include all hardware and software to permit remote setting / interrogation / fault evaluation from the ECMS (engineering) workstation or from the computer monitoring system.
- 6.4.1.35 All protection relays shall be equipped with communication port using IEC protocols to work as an integrated part of the ECMS hierarchy. Should the relay schemes be offered from multiple Bidders / Contractors, all third party user interface software products shall



	ELECTRICAL & INSTRUMENTATION SUPPLY CUM ERECTION WORKS TECHNICAL SPECIFICATION ELECTRICAL WORKS (SUPPLY & ERECTION)	PC183/E/8003/SecVI-2.0	0	
		Document No.	Rev	
		Sheet 24 of 109		

be supplied to the ECMS platform to bring together all types of protective relaying into a unified control system hierarchy.



- 6.4.1.36 Completely separate and isolated circuits shall be used for Switchgear control, tripping / protection, alarms, and auxiliary devices. These circuits shall have separate control power buses and feeders, suitably protected, for each power bus section.
- 6.4.1.37 Each control circuit shall be protected by a two-pole miniature circuit breaker with auxiliary N/C contact. The auxiliary contacts of all MCB's of the same circuit type, e.g. circuit breaker motor control, disconnect switch motor control, alarm, space heater, trip, etc., shall be wired in series to a group / common alarm terminal.
- 6.4.1.38 All meters shall be digital multifunctional meters with backlight LCD display and communication port. Additionally digital type ammeter, voltmeter and Hour Meter shall be provided separately for various feeders as indicated above.
- 6.4.1.39 All the motor / capacitor feeders controlled through vacuum circuit breakers shall be provided with surge arrestors.
- 6.4.1.40 A continuous ground bus shall be provided at the bottom of the switchgear and in cable connection side for grounding the switchgear, breaker trolley as well as to ground the cable glands.
- 6.4.1.41 Control supply bus and space heater supply bus-bars (Copper) of adequate rating shall be provided throughout the length of switchboards with as many sections as sections in power bus-bars.
- 6.4.1.42 Control supply shall be tapped from control bus in each cubicle/ panel itself through DP MCB of suitable rating.
- 6.4.1.43 The minimum thickness of sheet steel used in HV and LV switchgear including charger, UPS, ASPB etc. shall be as under:-
- a) Base Channel minimum 3.0 mm
 - b) Load Bearing Members minimum 2.0 mm
 - c) Doors and covers minimum 1.6 mm
- 6.4.1.44 A bottom channel of not less than 100 mm shall be provided.
- 6.4.1.45 The maximum height of the switchboard and other control panels shall be limited to 2200 MM. Maximum height of component requiring operation shall be limited to 1800MM.
- 6.4.1.46 The 415V switch boards shall have PVC insulated bus bar system suitable for rated voltage. At joints of these bus bars removable shrouds shall be provided.
- 6.4.1.47 For interfacing with DCS system, separate marshalling panels (with 20% spare terminals) shall be provided on each bus section in all HV & MV switchboards in the same panel line-up. The marshalling panels shall be of full height same as that of switchboards. The horizontal bus bar chamber at the top shall be continuous through this marshalling panel also, for future extension of the MV switchboard. All critical control signals for DCS interface shall be hardwired between substations and DCS. Other non-critical data of Electrical system will be sent to DCS with redundant communication facility between DCS and ECMS.

Hardwired signals (with minimum requirement specified below) from various Motor feeders of a bus section for DCS interface shall be wired and terminated in the marshalling cabinet:



- DCS Start permissive
- Process Start command (Auto)
- Remote Start command (Manual)
- Process Stop command
- Process Trip command (for breaker controlled motor feeder)
- Breaker/Contactor 'ON' indication

	ELECTRICAL & INSTRUMENTATION SUPPLY CUM ERECTION WORKS TECHNICAL SPECIFICATION ELECTRICAL WORKS (SUPPLY & ERECTION)	PC183/E/8003/SecVI-2.0	0	
		Document No.	Rev	
		Sheet 25 of 109		

- Breaker/Contactor 'OFF' indication
 - Ready to Start indication
 - Electrical Fault Trip indication
- 6.4.1.48 Following monitoring signals, as a minimum, shall be taken from substation to DCS interface, through redundant MODBUS SERIAL LINK communication from ECMS system.
- Load Data viz. KW, PF, A, etc.
 - L/R indication
 - Process Trip indication
 - Electrical Fault Trip indication
 - Trip Details
- 6.4.1.49 Auto changeover scheme shall be provided for incomers and bus couplers on all PMCCs/PCCs/ MCCs. Under normal operating conditions, incomer-1 and incomer-2 breakers would be closed and bus coupler breaker would remain open with 'auto-manual' switch in 'auto' position. The bus coupler switch would close automatically under the following condition being fulfilled:-
- i. Either of the incoming breaker trips due to under voltage (70% or below).
 - ii. Voltage on the healthy bus is more than 80% for the set period.
 - iii. Residual voltage on the bus with no power supply comes down to 30%.
 - iv. Auto change over shall be locked on loss of power on both the incomers.
- Auto changeover shall also be provided on switchboards catering to emergency loads.
- 6.4.1.50 Paralleling of two incoming feeders is not foreseen. However, facility for momentary paralleling shall be provided for intentional changeover without interruption of supply.
- 6.4.1.51 Every enclosure door that provides access to live parts operating at 240 V AC and above shall be mechanically interlocked with a circuit interrupting device on the supply side such that when the door is open, the equipment is de energised.
- 6.4.1.52 Separate redundant AC and DC control supply shall be provided for each Switchboard.
- 6.4.1.53 Control supply for motor feeders having MCCB in PMCC/MCC/ASB etc. and VFD panels etc. shall be feed from 240V UPS (Electrical) and motor controlled with breaker shall have 110 V DC control supply irrespective of its being HV or LV.
- 6.4.1.54 For motors with auto-starting provision, trip of a running motor shall start standby motor automatically.
- 6.4.1.55 All the LV switchgear shall be fed through two separate transformers, each transformer having capability to take care of 100% load of the associated switchgear and shall have the facility of auto changeover in case of failure of one transformer as well as option of manual changeover for maintenance purpose.
- 6.4.1.56 For more than 3 runs of cable complete dummy/adaptor panel shall be provided.
- 6.4.1.57 The CB ON and OFF lamp shall be provided at rear and front side of 11kV/3.3kV switchboards.
- 6.4.1.58 All breakers service ON/OFF contact multiplier contactors shall be mechanically latched type and independent of control supply. Loss of supply and restoring the supply shall not affect the status of the relay/ contactor.
- 6.4.1.59 All breakers shall be electrically operable and mechanical operation from the breaker shall be possible locally. Manual breakers are not acceptable.
- 6.4.1.60 Separate Ammeter shall be provided for panel and motor feeder Space heater circuit for each panel.



	ELECTRICAL & INSTRUMENTATION SUPPLY CUM ERECTION WORKS TECHNICAL SPECIFICATION ELECTRICAL WORKS (SUPPLY & ERECTION)	PC183/E/8003/SecVI-2.0	0	
		Document No.	Rev	
		Sheet 26 of 109		

- 6.4.1.61 The terminal strips used shall be of stud and nut type and control wiring shall be done with ring tong lugs only.
- 6.4.1.62 Dual channel output with display type current transducer for all HV and LV switchboard feeder shall be provided requiring Ammeter at control panel.
- 6.4.1.63 All motor (LV) power feeders shall have separate earth fault protection through CBCT and earth fault relay. LV motor (above 5.5. KW) and power feeder above 100A shall have CBCT and Digital earth leakage relay with display.
- 6.4.1.64 All external hardware shall be of stainless steel only.
- 6.4.1.65 The control compartment and power compartment shall be separate.
- 6.4.1.66 All LV breakers shall have remote switching facility as well as ON/OFF/TRIP indication at ECMS.
- 6.4.1.67 Following Set of accessories as listed below shall be provided for each 415 V Switchboard :
- a) Breaker lifting and handling trolley : Minimum 2 nos.
 - b) Test cabinet with coupling cables for testing the breaker in draw out position : Minimum 1 No.
 - c) Racking in/out handle for breakers : Minimum 4 nos.
 - d)
- 6.4.1.68 Alarm relays with reverse flag shall be provided to annunciate failure of main incoming A.C. and D.C. power supplies and annunciation D.C. supply in each panel. Lamp indications shall be provided individually for main D.C. supply-1 fail, main D.C. supply-2 fail, and panel annunciation D.C. supply fail. A common A.C. electric bell shall be provided to give an audible alarm in case of failure of D.C. supply-1/D.C. supply-2/annunciation D.C. supply in any panel. A common push-button shall also be provided for cancellation of lamp indications and audible alarm.
- 6.4.1.69 Gland plate for single core cables shall be non-magnetic.
- 6.4.1.70 All Incomers and bus couplers shall be provided with synchronising facility. Synchrocheck relay shall be provided in each bus PT & contacts shall be multiplied and wired in each outgoing feeders of each bus section.
- 6.4.1.71 Supervision of installation, testing and commissioning including testing of Relays of all switchboards shall be done through OEM only.
- 6.4.1.72 All Numerical Relays shall be of same Make and Model (series).
- 6.4.1.73 LV Switchgear design shall be such that the feeder doors should not open in locked out tagged out condition .
- 6.4.1.74 Current transformers shall be in accordance with IEC 61869-1 & 61869-2. The rated output shall match the requirements of the equipment connected. The secondary current rating shall be 1 A. Unless otherwise specified, cores for measuring instruments shall have accuracy classes of not more than 0.5 % and saturation factors less than 5.
- 6.4.1.75 For all other specifications, refer PC183-TS-0805, PC183-TS- 0808 and PC183-TS-0809.
- 6.4.2 Low Voltage Switchgears
- 6.4.2.1 415 V switchboards shall include the following:
- a) Power Control Centre (PCC) / Power-cum-Motor Control Centres (PMCCs) / Emergency PMCC (EPMCC)
 - b) Main Lighting Distribution Boards (MLDBs)
 - c) Auxiliary Services Power Boards (ASPBs)



	ELECTRICAL & INSTRUMENTATION SUPPLY CUM ERECTION WORKS TECHNICAL SPECIFICATION ELECTRICAL WORKS (SUPPLY & ERECTION)	PC183/E/8003/SecVI-2.0	0	
		Document No.	Rev	
		Sheet 27 of 109		

d) Power Distribution Boards (PDBs)

- 6.4.2.2 Low voltage switchboards shall be metal clad, arranged with self supporting units and assembled together in a row.
- 6.4.2.3 Internal physical separation / segregation of 415 V Switchboards shall be 3 B for Non-ACB feeders and 4 B for ACB feeders.
- 6.4.2.4 The switchboards shall be suitable for extension at both the ends.
- 6.4.2.5 Bus bars shall be of uniform cross section and supported on non-hydroscopic FRP insulators with adequate clearances and creepage distance to prevent flash over due to effect of dust/moisture.
- 6.4.2.6 The horizontal busbars as well as vertical droppers of LV switchboards shall have heat shrinkable insulated sleeves.
- 6.4.2.7 Sufficient bus supports shall be given to give adequate mechanical strength during short circuits.
- 6.4.2.8 A continuous ground bus shall be provided at the bottom in the PCC/ PMCC/ EPMCC /MCC for grounding the PCC/PMCC/MCC.
- 6.4.2.9 Rated short circuit breaking capacity shall be 50 KA for 1 sec.
- 6.4.2.10 The PMCC, EPMCC, MCC, Main lighting distribution board and auxiliary services power board shall be provided with withdraw able air circuit breakers for incoming feeders and bus ties.
- 6.4.2.11 All feeders of 415 V switchboards shall be provided with MCCB except feeder rated more than 400A, for which ACB shall be provided. All outgoing feeders shall be draw-out type in all the switchboards.
- 6.4.2.12 All ACBs shall be electrically operated- EDO type only. Manual breakers are not acceptable. Each electrically operated breaker shall be provided with antipumping (94), Breaker fail (52BF) and trip free feature, trip annunciation (30) and lockout (86) relays. Lockout relay shall be hand reset type.
- 6.4.2.13 All ACBs shall be without any internal releases. The required protections shall be wired by means of external numerical relays.
- 6.4.2.14 Motor feeders below 75 KW rating shall be contactor controlled and 75 KW & above, these shall be ACB controlled with combined motor protection relay. All other feeders of 415 V switchboards shall be provided with MCCB except feeder rated more than 400A, for which ACB shall be provided. All outgoing feeders shall be draw-out type in all the switchboards.
- 6.4.2.15 Switchboards shall be provided with thermostatically controlled anti-condensation heaters.
- 6.4.2.16 All units in the MCC shall be completely accessible and removable from front. Both power and control connections shall be stab-in type.
- 6.4.2.17 Bus bar clearances shall conform to relevant Indian Standard/IEC for equipment voltages up to and including 500 V AC.
- 6.4.2.18 The switchboards shall be compartmentalized and individual feeder modules shall be draw-out type. Fixed type modules shall not be acceptable.
- 6.4.2.19 The draw out modules shall be standardized and it shall be possible to interchange any module with a module of same size. The components to control the equipment like MCCB, starter, auxiliary relay etc. shall be wired as a unit on the individual module. Safety shutter shall be provided to prevent direct access to live parts when the chassis is removed.

	ELECTRICAL & INSTRUMENTATION SUPPLY CUM ERECTION WORKS TECHNICAL SPECIFICATION ELECTRICAL WORKS (SUPPLY & ERECTION)	PC183/E/8003/SecVI-2.0	0	
		Document No.	Rev	
		Sheet 28 of 109		

- 6.4.2.20 The entire draw out construction should be designed for safe operation during placement or removal of chassis. An earthing arrangement shall be provided which will make contact first before the power contacts are made and break last. Each module shall control one motor in general.
- 6.4.2.21 The door shall be interlocked so that it cannot be opened unless the isolating switch on that module is OFF. However, it shall be provided with a door defect mechanism for intentional opening when on line for testing and inspection purpose.
- 6.4.2.22 Control switches for breaker control shall be provided in each breaker cubicle. Circuit breaker shall be interlocked to prevent withdrawal of a closed breaker or insertion of a closed breaker. Each breaker shall be provided with anti pumping device.
- 6.4.2.23 Provisions shall be made to manually close/trip circuit breakers on loss of control voltage.
- 6.4.2.24 LV motor and power feeder above 100A shall have CBCT and Digital earth leakage relay.
- 6.4.2.25 All external hardware shall be of stainless steel only.
- 6.4.2.26 The control compartment and power compartment shall be separate.
- 6.4.2.27 The LV PMCC/MCC/PCC control supply shall be 240VAC, 50Hz UPS supply fed from UPS Distribution Board of Separate 240 V AC UPS System dedicated for MCC control supply; Control Room & Substation lights, ECMS Equipment, Fire Detection & Alarm System etc. Breaker control supply shall be 110V DC.
- 6.4.2.28 The timers shall be electronic type only. Pneumatic or synchronous type timers are not acceptable.
- 6.4.2.29 Each outgoing motor feeder shall consist of a number of components mounted in a module duly wired. In general outgoing feeder rated below 75 KW shall consist of:
- a) MCCB.
 - b) Control supply On/Off switch and fuse
 - c) Power Contactor
 - d) Electronic Digital Motor Protection Relay with built-in Earth Fault, Overload, Stalling, Single phase protection, etc. Thermal Overload Relay are not acceptable.
 - e) C.T for metering
 - f) Overload reset button.
 - g) Process Trip / ON / OFF indicating lamp with separate indicator fuse.
 - h) Auxiliary contactors for multiplication / control.
 - i) Test position limit switch and test PB
 - j) CT operated Ammeter for all motor feeders above 1.5 KW, all MOV and LOPs at both LCS and Feeder end.
 - k) Selector switches as per requirement.
- 6.4.2.30 Following potential free contact shall be available for each Motor feeders for indication in ECMS in addition to process requirement:
- Motor ON
 - Motor OFF
 - Ready to Start
 - Motor Process Trip
 - Motor Elect Trip

	ELECTRICAL & INSTRUMENTATION SUPPLY CUM ERECTION WORKS TECHNICAL SPECIFICATION ELECTRICAL WORKS (SUPPLY & ERECTION)	PC183/E/8003/SecVI-2.0	0	
		Document No.	Rev	
		Sheet 29 of 109		

6.4.2.31 Provision for indication of minimum following electrical parameters in 415V PCC / PMCC/ MCC shall be made:

- a) ON OFF, TRIP, TRIP CIRCUIT HEALTHY, TEST, SERVICE Position, Ready to close indication in ACB feeders.
- b) The KWH meters on incomers shall have provisions for sealing for tariff purpose, as required.
- c) MCC shall conform to the following as a minimum :
 - Motor starters rated for utilisation category AC3 and protection equipment with a minimum of type 2 co-ordination.
 - The number of modules per tier shall not exceed 6.
 - MCC incomer sizes and configurations rationalised to minimise spares holdings.

6.4.2.32 In PMCC, MCC and EPMCC Non-ACB feeders for motors or power may be double front type. ASPB, MLDB UPSDB, DCDB shall be single-front type.

6.4.3 Lighting Sub Distribution Boards

6.4.3.1 LSDB shall be provided with incoming and outgoing feeders as indicated in specification sheets of this specification.

6.4.3.2 All MCBs shall be of 10KA breaking capacity conforming to IS/IEC: 60898-1.

6.4.3.3 Two types of LSDB shall be provided, one suitable for safe area and other suitable for hazardous area.

- i) LSDBs for installation in safe area shall be fabricated out of 2.5 mm thick rolled cold sheet steel.
- ii) The enclosure for installation in hazardous area shall be made of Cast Aluminium (LM-6) alloy in flameproof construction conforming to IP65. Both type of LSDB shall be dust, vermin and weather proof construction
- iii) Rain hood fabricated out of 14 SWG aluminium sheet shall be provided as an additional protection. 4 nos. holes suitable for 12mm bolts shall be provided outside the enclosure for fixing the LSDB.

6.4.3.4 The miniature circuit breakers (MCBs) shall be so mounted inside the enclosure that their operating knobs project outside for ease of operation. The cut out for the knobs on the enclosure shall be lined with gaskets. For further protection against ingress of dust, the portion where the knobs have protruded out shall be provided with another external cover, internally hinged at one side and with a knurled knob. The external cover shall be flushed with the main cover. Continuous neoprene gasket shall be provided to make the board completely dust and weatherproof.



6.4.3.5 All external hard ware of diameter less than 8 mm shall be of stainless steel and those of diameter 8 mm and above shall be of mild steel cadmium plated or zinc passivated.

6.4.3.6 The LSDB shall have bottom entry arrangement for all incoming and outgoing cables provided with heavy-duty Ex'd' double compression type rolled aluminum cable glands suitable for 1.1 KV XLPE-A-FRLS PVC outer-sheathed cables for hazardous area and Industrial type double compression Al cable gland for safe area.



6.4.3.7 Three phase and neutral bus bar system of adequate size shall be provided to which all outgoing and incoming MCBs shall be connected.

6.4.3.8 The internal wiring shall be carried out by means of single core PVC insulated 4 sq. mm stranded copper conductor cables.



6.4.3.9 Individual earth terminals shall be provided for the earth conductor of the outgoing cables beside the phase and neutral terminals.

	ELECTRICAL & INSTRUMENTATION SUPPLY CUM ERECTION WORKS TECHNICAL SPECIFICATION ELECTRICAL WORKS (SUPPLY & ERECTION)	PC183/E/8003/SecVI-2.0	0	
		Document No.	Rev	
		Sheet 30 of 109		



- 6.4.3.10 Suitable label inscription consisting of black perspex with engraving for the board and circuit nos. of all outgoing feeders shall be provided. The label inscription of the board shall contain description and code no. as indicated in specification sheet. The circuit nos. of outgoing feeders shall be serially indicated as 1R, 1Y, 1B, 2R, 2Y, 2B.....
- 6.4.3.11 Two earthing terminals outside the board shall be provided.
- 6.4.3.12 The board shall be complete with terminal block, cable glands, cable lugs and other accessories as required.
- 6.4.3.13 Typical SLD is attached for various types of LSDBs with incoming and outgoing feeders with this specification.
- 6.4.3.14 Suitable size Earth bus shall be provided inside the panel at bottom.
- 6.4.3.15 For all other specifications, refer PC183-TS-0809
- 6.4.4 Direct Current Distribution Boards**
- 6.4.4.1 The Direct Current Distribution Boards (DCDBs) shall be single front, floor mounted non-drawout type for supply of 110 V DC control power to switchgears and panic lighting.
- 6.4.5 WALL MOUNTED WELDING SOCKET DISTRIBUTION BOARD (WSDB)**
- 6.4.5.1 Wall mounted type distribution boards such as Welding Socket Distribution Board (WSDB) shall be provided with incoming and outgoing feeder as indicated in single line diagrams.
- 6.4.5.2 These shall be fabricated out of 2.5 mm thick CRCA sheet steel. These shall have dust & vermin proof construction conforming as per IS: 13947. The front cover shall be provided with concealed type hinges. The mating surfaces shall be provided with non-deteriorating neoprene gaskets without any discontinuity.
- 6.4.5.3 The two earthing terminals outside the board shall be provided.
- 6.4.5.4 The board shall be complete with terminal blocks, cable glands, cable lugs and other accessories as required.
- 6.4.5.5 Suitable size Earth bus shall be provided inside the panel at bottom.
- 6.4.6 11 kV Switchboard**
- 6.4.6.1 The 11 KV switchboard shall be indoor, metal enclosed, draw out type, equipped with VCBs, stored energy mechanism working on 110 V DC and shall feed power to the various substations through transformers and other outgoing feeders.
- 6.4.6.2 Degree of protection shall be IP4X as per IS/IEC 60529, IEC 60298. Switchgear sizes and configuration shall be rationalized to minimum spare holding.
- 6.5 EMERGENCY STOP PUSH BUTTON STATION**
- 6.5.1 Emergency Stop push button station shall also conform to the Specification Sheet.
- 6.5.2 The enclosure shall be of Die cast Aluminum alloy and shall be of weatherproof construction. Rain hood fabricated out of 14 SWG Aluminum sheet shall be provided as an additional protection. The enclosure shall be suitable for mounting on wall or on steel structure. 4 Nos. holes suitable for 12 mm bolts shall be provided outside the enclosure for fixing the control stations.
- 6.5.3 All the components shall be mounted on a base plate inside the enclosure. No wiring shall be carried out on the front cover.
- 6.5.4 Each control station shall be provided with minimum 2 mm thick stainless steel nameplates indicating the code number and description of the equipment controlled by it. Similar labels shall be provided for all indication lamps, push buttons, control switches. The nameplate and label shall be fixed with screws only.

	ELECTRICAL & INSTRUMENTATION SUPPLY CUM ERECTION WORKS TECHNICAL SPECIFICATION ELECTRICAL WORKS (SUPPLY & ERECTION)	PC183/E/8003/SecVI-2.0	0	
		Document No.	Rev	
		Sheet 31 of 109		

- 6.5.5 The enclosure shall be provided with two external earthing terminals with studs of 8 mm. dia. and shall be marked with earthing symbol.
- 6.5.6 LCS shall be painted with epoxy paint to shade 631 as per IS: 5.
- 6.6 Local Control Stations**
- 6.6.1 Local Control Stations shall be provided for motors for testing and maintenance purpose when the selection is made is "LOCAL MODE" Operation. The essential features of the LCS shall be as given below:
- 6.6.2 LCS shall be pressure die cast aluminium housing (preferably), dust & vermin proof, weatherproof, suitable for wall or pedestal mounting with equipment mounted on a base plate inside and behind a front cover (bolted type).
- 6.6.3 Provision for pad locking in OFF position shall be provided.
- 6.6.4 Local control stations for breaker controlled HV and LV motors shall be provided with T-N-C switch, Ready to Start Indication, ON indication, Space Heater ON Indication, Trip Indication, Local-OFF-Remote Control switch and ammeter. Moreover, space heater ON indication lamp, trip indication lamp shall also be provided at the switchgear panel.
- 6.6.5 Local control stations for contactor controlled LV motors shall be provided with start/stop push buttons, ammeters and Space Heater ON Indication (for motor rated 30KW and above), ON indication, Local-Remote switch (as required) for the motors having rating 5.5 KW and above. If required from process point of view, ammeter shall be provided for motors below 5.5 KW also.
- 6.6.6 Each element for start and stop shall be provided with 1 NO + 1 NC contact. The push button construction shall be such to avoid mal-operation due to vibrations.
- 6.6.7 All local control stations shall have weather proof IP-65 enclosure. Canopies of suitable size shall be provided with all local control stations.
- 6.6.8 All components shall be completely wired up to terminal block and also provided with earthing terminals.
- 6.6.9 Inscriptions on corrosion resistant metal strips giving drive description, mechanism number and functional requirement shall be provided.
- 6.6.10 Two numbers of LCS shall be provided for the motors, which are installed at elevated platforms. One shall be installed at ground level and the other near the motor.
- 6.6.11 The ammeter shall be flush mounting, moving iron spring controlled type, of accuracy class 1.5 as per IS: 1248, with square face of minimum size 72 mm × 72 mm having scale range 0-90 degree. The ammeter shall be provided with uniform scale up to CT primary current and compressed end scale up to the 8 times the C.T. primary current. Adjustable red pointer shall be provided to indicate the full load current of the motors. Zero adjusters shall be provided for operation from the front of the meter. All ammeters shall be operated through 1 Amp. CTs only.
- 6.6.12 Complete Push Button along with its actuator mounted on the cover with wiring done through flexible cables with proper protection.
- 6.6.13 Preferably Ring Type lug and suitable TB to be used for connection, to avoid loose connection.
- 6.6.14 All spare hole to be plugged with suitable metal plugs.
- 6.6.15 For all other specifications, refer PC183-TS-0817.
- 6.7 EOT crane & hoists**
- 6.7.1 Electrical system of EOT crane shall include supply, installation, testing & commissioning of following items



	ELECTRICAL & INSTRUMENTATION SUPPLY CUM ERECTION WORKS TECHNICAL SPECIFICATION ELECTRICAL WORKS (SUPPLY & ERECTION)	PC183/E/8003/SecVI-2.0	0	
		Document No.	Rev	
		Sheet 32 of 109		

- Squirrel cage induction motors of duty suitable for required crane application
 - Power control panel
 - Control stations
 - Limit switches
 - Electromagnetic brakes
 - Power & control cables with accessories
 - Earthing
 - Any other items, not specified, but required for safe and proper operation.
- 6.7.2 The bidder shall provide one no. 415V feeder from their PMCC/EPMCC for each crane / hoist based on the power requirement (running and peak) of EOT crane, and terminate the feeder cable in an isolator located at one end of the bay at a height of 1.5m from the operating floor. Moreover further distribution of power from this isolator to respective loads of EOT crane system shall also be in bidder scope.
- 6.7.3 Electrical equipments located indoor shall have minimum IP-65 degree of protection.
- 6.7.4 The minimum clearance and creepage distance of M.V. equipment shall be 20 and 28 mm respectively and shall be positively maintained after connections.
- 6.7.5 Enclosure for limit switches, pendant push button, junction boxes and magnets etc. shall be of cast aluminium. Enclosure for control panel, transformer etc may be of sheet steel. The thickness of the sheet steel for the enclosure shall not be less than 2.5 mm. All enclosures shall be suitably painted to withstand atmospheric pollution.
- 6.7.6 The power rating of the motors shall be 25% higher than the design requirement of the driven equipment, under the specified service and duty conditions.
- 6.7.7 All motors shall be of squirrel cage type and so designed that smooth acceleration or deceleration of the load is possible without any jerks. Further a maximum displacement of 2 mm when starting and stopping the motor in quick succession shall be guaranteed.
- 6.7.8 The motors for main hoist and micro hoist shall be suitable for intermittent duty type S4 with 60% C.D.E. and 300 starts / stops per hour. The motors for long travel and cross travel shall be suitable for S2 duty for 60 minutes.
- 6.7.9 Brakes for main and micro hoist motor shall be suitable for S4 duty, while for long and cross travel hoist motor shall be suitable for S2 duty.
- 6.7.10 For other specifications refer ES:8208 and relevant mechanical specifications enclosed elsewhere in ITB
- 6.8 Interlocked Type Switch Sockets**
- 6.8.1 Interlocked type switch socket shall be of the types as specified in specification sheet for of this specification.
- 6.8.2 These shall be complete with heavy duty air break switches, HRC fuses, sockets & plugs. These shall be fully wired and shall be complete with cable glands, lugs, terminals, suitably sized blanking plugs for unused entry etc. for external connection.
- 6.8.3 The switch socket shall be heavy duty flameproof type for hazardous area and heavy duty industrial type for safe area. The interlocking arrangement shall be such that it is not possible to insert or withdraw the plug with the switch in 'ON' position. Switch socket shall also conform to specification sheet of this specification.
- 6.8.4 The switch sockets shall have dust, hose and weather proof construction conforming to IP55 as per IS: 13947 and shall be suitable for outdoor use without any extra protection. All jointing surfaces shall be smoothly machined and of sufficient width to prevent ingress

	ELECTRICAL & INSTRUMENTATION SUPPLY CUM ERECTION WORKS TECHNICAL SPECIFICATION ELECTRICAL WORKS (SUPPLY & ERECTION)	PC183/E/8003/SecVI-2.0	0	
		Document No.	Rev	
		Sheet 33 of 109		

or dust. Further the covers shall be provided with continuous gaskets made of neoprene to prevent ingress of dust and moisture.

- 6.8.5 The enclosure of switch sockets and plugs shall be of Cast Al alloy (LM6) in flameproof & weatherproof execution, suitable for fixing on wall / MS structure. A rain-hood shall be offered as an additional protection. Rain hood shall be of the same material as of the main enclosure. Suitable arrangement for looping of cables from one switch socket to the other shall be provided. Necessary terminals, cable glands and lugs for looping shall be provided. Also one no. threaded plug for each switch socket shall be supplied loose.
- 6.8.6 The Air break switches shall be quick make, quick break rotary type and of utilization category AC-23. Switches shall be hand operated from outside the cover. The switch handle shall remain fixed to the front cover while removing the front cover.
- 6.8.7 The sockets shall be provided with link type HRC fuses. The fuses shall be capable of withstanding a short circuit current of 50kA and shall be delayed action type. These shall be mounted on a shrouded base.
- 6.8.8 The socket outlet shall be located in the lower part of the enclosure and shall be provided with a threaded aluminium cover attached to the body with SS chain, to protect the socket after extraction of the plug. Spring loaded automatic shutter shall not be acceptable.
- 6.8.9 The plugs shall be so constructed that these can be easily fitted in to the socket outlets and shall be provided with knurled knob arrangement for screwing on the body of the socket so that it can be securely fixed on the top. The plug base and cover shall be firmly secured to each other and shall be sufficiently robust in construction to withstand normal usage. The plug and socket contacts shall be self-aligning type with best electrical continuity.
- 6.8.10 The plug shall be provided with cable entry suitable for receiving TRS flexible heavy duty copper conductor cable of specified size. The arrangement shall be such that the conductors are relieved from strain including twisting where they are connected to the terminals and that the outer surface of the cable at the place of entry is not damaged.
- 6.8.11 Following minimum cable sizes to be considered for individual switch sockets, however actual sizes shall be subject to approval satisfying the current and voltage drop criteria.
- i) For 32A Sw. Sockets
Switch sockets: 3Cx25 sq.mm A2XFY cable for incoming and outgoing
Plug: 4Cx2.5 sq.mm. flexible copper conductor cable
- ii) For 63A Sw. Sockets
Switch sockets: 3.5Cx50 sq.mm A2XFY cable for incoming and outgoing
Plug: 4Cx2.5 sq.mm. flexible copper conductor cable
- 6.8.12 For all Other Specifications, Refer PC183-TS-0811.
- 6.9 **Conduits**
- 6.9.1 Conduits shall be of heavy gauge with minimum wall thickness of 1.4 mm (upto 25 mm dia) and 2 mm (above 25 mm dia) rigid steel, hot-dip galvanized, cut square, reamed, threaded and screwed tight at all joints.
- 6.9.2 Conduits entrances to pull boxes and switches shall have double lock nuts & insulating bushings. No running thread shall be used.
- 6.9.3 Flexible metallic conduit shall be used for connection to equipment which are subject to vibration and also for connection to level /limit/pressure switches. Conduit runs shall be supported at an interval of 750 mm for vertical run and 1000 mm for horizontal run.

	ELECTRICAL & INSTRUMENTATION SUPPLY CUM ERECTION WORKS TECHNICAL SPECIFICATION ELECTRICAL WORKS (SUPPLY & ERECTION)	PC183/E/8003/SecVI-2.0	0	
		Document No.	Rev	
		Sheet 34 of 109		

Conduits shall be sized so that conduit fill (ratio of total cable area to conduit area) shall not exceed the following :

One Cable : 53%

Two Cable : 31%

Three Cables & Up : 40%

6.10 **DRY TYPE LIGHTING TRANSFORMERS**

6.10.1 Type test certificate of similar type of dry type lighting transformer shall be furnished by the bidder.

6.10.2 One winding RTD shall be provided in each phase of the windings.

6.10.3 Additional Fitting: The transformer shall be provided with digital temperature scanner unit to monitor the winding temperature. The scanner shall be provided with 2 output contacts for alarm and trip signal. The temperature scanner shall be mounted on enclosure.

6.10.4 Transformers shall be natural air cooled type.

6.10.5 The losses shall be indicated by the vendor and shall be guaranteed, within tolerable limits at rated voltage and frequency as per level 3 of IS: 1180.

6.10.6 Class-H insulating material shall be used.

9.16.1 For all Other Specifications, Refer PC183-TS-0829.

6.11 **Electrical Control & Monitoring System (ECMS)**

6.11.1 Electrical Control & Monitoring System (ECMS) shall be provided for Supervision, control, monitoring, data acquisition, data logging & printing of status of all important electrical equipment & feeders and Load Shedding Scheme as per the recommendations of the system study report as per process requirement and in consultation with Owner/Consultant for entire fertilizer complex, by EDS LSTK Contractor.

Data concentrator Panel and other ECMS System Equipments including PC console, chairs, furniture etc. for 'Dyke & Associated Facility' shall be in EDS LSTK Contractor's scope. However, Contractor has to consider space for same in separate room in Substations, as per NIT.

Contractor shall provide multifunctional dual channel transducers in all the breaker feeders as well as contactor feeders of all important & critical Loads. Also, supply & installation of Network Switches and extend all signals up to Network Switches shall be in the scope of Contractor. Network Switch shall have 20 % spare ports.

Minimum Inputs and Outputs to be considered for ECMS for proper operation/control, effective monitoring and load management shall be inclusive of but not limited to the following:

a. **Transformers:**

Oil Temperature, Winding temperature, Conservator Oil Level and moisture ppm of Oil through 4-20 mA signal / Modbus communication and status of Buchholz Relay.

b. **Incomer /Bus coupler/ Feeder (Power/Motor)**



KW, KVA, KVAR, KWh, PF, VOLTAGE, CURRENT

ON, OFF, TEST, SERVICE, TRIP ON FAULT, TRIP CIRCUIT HEALTHY, CONTROL SUPPLY ON, RELAY WATCH DOG, FAULT DETAILS, DISTURBANCES RECORDER.

Remote ON & OFF Control from ECMS.

c. **LT motor feeder of breaker controlled motors in EPMC/PMCC/MCC**

KW, KVA, KVAR, KWh, PF, VOLTAGE, CURRENT

	ELECTRICAL & INSTRUMENTATION SUPPLY CUM ERECTION WORKS TECHNICAL SPECIFICATION ELECTRICAL WORKS (SUPPLY & ERECTION)	PC183/E/8003/SecVI-2.0	0	
		Document No.	Rev	
		Sheet 35 of 109		

ON, OFF, TEST, SERVICE, TRIP ON FAULT, TRIP CIRCUIT HEALTHY, READY TO START, PROCESS TRIP, EMERGENCY STOP, LOCAL/REMOTE selection on LCS, CONTROL SUPPLY ON, RELAY WATCH DOG, FAULT DETAILS, DISTURBANCES RECORDER.

Remote ON & OFF Control from ECMS.

d. LT motor feeder of Contractor controlled motors in EPMC/PMCC/MCC

ON, OFF, TRIP ON FAULT, READY TO START, PROCESS TRIP.

e. Breaker Controlled Power feeder in PCC/MCC/ASPB

KW, KVA, KVAR, KWh, PF, VOLTAGE, CURRENT

ON, OFF, TEST, SERVICE, TRIP ON FAULT, TRIP CIRCUIT HEALTHY, CONTROL SUPPLY ON, RELAY WATCH DOG, FAULT DETAILS, DISTURBANCES RECORDER.

Remote ON & OFF Control from ECMS.

f. UPS

Load on Inverter, Load on Bypass, Load on Battery, Battery on float/ boost charging mode , Charger failure , Inverter failure ,AC mains failure, DC under voltage, DC Over voltage ,Automatic retransfer of load to inverter inhibited ,

Fan failure ,AC Voltage , current & frequency of each inverter , AC incoming power supply Voltage & voltage , DC current at each rectifier output.

g. Battery & Battery Charger

Status of charging current (float & boost charging) , Battery current ,Incoming voltage, Load Voltage DC, Load current DC, DC under voltage

DC overvoltage , DC earth leakage ,AC incoming power supply failure ,AC input fuse blown-off ,Thyristor/ diode failure ,DC output fuse blown-off ,DC battery fuse blown-off ,Filter Capacitor fuse blown-off ,Load on Battery (using current direction sensing with time delay) ,Battery under voltage/ Disconnected during discharge (using zero current sensing) ,Cubicle fan failure/ cubicle temperature high (for chargers with forced cooling).

All connection/ wiring up to I/O Rack shall be in the scope of Contractor. Connection/wiring from Network Switch to Data Concentrator Panel & Centralized ECMS shall be in Owner's scope. However, cable tray, support for cable trays etc. for Cables from Network Switch to Data concentrator Panel & Centralized ECMS System (within battery limit of Dyke & Associated Facility) shall be in Contractor's scope.

Redundant Power Supply from 240 V UPS Distribution Board to all ECMS equipment, OWSs, EWSs etc. (up to termination to I/O Racks, OWSs, EWSs etc.) shall be in Contractor's scope.



6.11.2 All relays and energy meters shall have communication facility for serial communication (Relays on IEC-61850 protocol and Meters on MODBUS protocol).

6.12 Junction Boxes



6.12.1 Junction boxes shall be of the types as specified in specification sheet of this specification.

6.12.2 Junction boxes shall be used for looping of lighting cables in the lighting circuit of LED Tube Lighting fixtures. Junction boxes shall be made of Cast Al Alloy (LM6) having IP65 degree of protection for hazardous area as per IS: 60079-1 and IP 55 for safe area.

6.12.3 Junction boxes shall be liberally dimensioned having minimum internal dia. of 120 mm.

	ELECTRICAL & INSTRUMENTATION SUPPLY CUM ERECTION WORKS TECHNICAL SPECIFICATION ELECTRICAL WORKS (SUPPLY & ERECTION)	PC183/E/8003/SecVI-2.0	0	
		Document No.	Rev	
		Sheet 36 of 109		

- 6.12.4 The junction boxes shall be 4 way, dome cover type, suitable for mounting on surface, MS structure or wall complete with mounting accessories, 6 nos. 16 A / 63 A terminals fitted on DMC moulded terminal block with shorting links, 3 nos. cable glands suitable for 3X2.5 sq mm² copper / 3.5X50 mm² (Al) conductor XLPE-A-FRLSPVC cable, one no. threaded plug and two external earthing terminals.
- 6.12.5 Cable glands, lugs & blanking plugs shall be of flameproof proof for hazardeous area and industrial for safe area, double compression type and shall be of rolled aluminium.
- 6.12.6 All the hardware used for the junction boxes shall be made of stainless steel.
- 6.12.7 For all other specifications, refer PC183-TS-0818
- 6.13 **Bus-Duct**
- 6.13.1 The bus bars and connection shall be made of electrolytic grade copper only. Aluminium busbars are not acceptable. All busbars shall be insulated with Raychem sleeving.
- 6.13.2 It shall be suitably supported at regular intervals and both bus bars and supports shall be adequately sized and clamped to withstand rated short circuit current without permanent deformation.
- 6.13.3 The bus bar insulators shall be non-hygroscopic, non-inflammable material. Earth bus shall run along the full length of bus duct without any break.
- 6.13.4 Outdoor bus-duct shall be weatherproof to IP-65 and shall be provided with canopy, silica gel breather. Construction of outdoor Bus duct shall be such that water gets drain off easily. Extra thickness shall be provided at the corners where water accumulation is likely to happen.
- 6.13.5 Bus duct shall be supplied with bus bar flexible links for connection at both the ends and expansion joints for every 3M of bus-duct and bus duct support materials.
- 6.13.6 Openings with cover at suitable locations shall be provided on bus duct for accessing the bus bars for maintenance.
- 6.13.7 Silica-gel breather shall be provided on both indoor and outdoor portions of the busduct. (shall not be required for pressurized busduct).
- 6.13.8 Proper sealing shall be done between Outdoor & Indoor section of the Bus Duct.
- 6.13.9 For all other specifications refer, PC150-TS-0807.
- 6.14 **PUBLIC ADDRESS SYSTEM**
- 6.14.1 Public Address system suitable to provide reliable and quick source of communication among operating personnel shall be provided. The system shall be microprocessor based with modular construction for ease of expansion capabilities and capacity. The system shall have speakers, calling points etc. suitable to area of classification for that location.
Substation shall be connected with the PA System.
- 6.14.2 Close talk mode shall be provided for conversation between two or more stations through close talk channel. Speeches from any hand set shall be heard over all the speakers. The system shall have the following facility:-
- i) Alert tone facility
 - ii) Paging facility
 - iii) Private conversation facility
 - iv) Loud speaker mute facility
- Emergency tone facility.

	ELECTRICAL & INSTRUMENTATION SUPPLY CUM ERECTION WORKS TECHNICAL SPECIFICATION ELECTRICAL WORKS (SUPPLY & ERECTION)	PC183/E/8003/SecVI-2.0	0	
		Document No.	Rev	
		Sheet 37 of 109		



- 6.14.3 The system may be centrally located at a particular plant but the location shall in no way affect the performance of system. If required separate but interconnected system shall be provided. The microphone system shall be capable to suppress the environmental noise which will be present in the plant due to machineries.
- 6.14.4 It shall be possible to have automatic testing, monitoring, fault diagnosis etc. through interface PC. The system programming shall be user friendly through interface PC.
- 6.14.5 Separate dedicated UPS with battery back-up of 8 hours shall be considered for PA System. Ni-Cd Battery shall be provided.
- 6.14.6 Paging speakers provided in areas having ambient noise levels shall produce a paging sound level at least 10 dB above the anticipated ambient noise level. Where it is not possible to achieve the sound level of above 10 dB above the ambient, rotating beacons shall be installed such a way that that the operator is alerted in the area. Acoustic hoods shall be provided for call stations located in high noise areas.
- 6.14.7 The design of the system shall be such as to provide two channel communication i.e. Page & Party in each zone. Page & Party system shall comprise of one channel for paging & one channel for party talk.
- 6.14.8 It shall be possible to communicate between two field stations without the interference of the MCS / operator. Also it shall be possible to have direct communication with the MCS.
- 6.14.9 The equipment shall be sturdy, impact resistant, dust & damp proof generally conforming to minimum IP 66 degree of protection. For classified hazardous areas flameproof equipment shall be provided duly certified by recognised certifying authority for the area of installation.
- 6.14.10 Acoustic hood for PA stations in Steam Generation Plant in addition with acoustic hood in noisy area shall be considered.
- 6.14.11 Paging system shall be interfaced with EPABX and Fire Alarm System.
- 6.14.12 PA System shall have 20% spare capacity.
- 6.14.13 Separate Centralised PA System of entire fertiliser complex shall be provided Contractor. Hook-up of PA System of Other Plant of Fertilizer Complex with Centralised PA System shall be in Contractor's scope. All interfacing equipment as well as cabling required for hook-up shall be in scope.
- 6.14.14 All cables (including communication cable) shall be armoured type only.
- 6.14.15 For all other specifications refer PC150-TS-0801.

7.0 CABLING



7.1 Cables

- 7.1.1 All HV & LV power and control cables for HV/LV switchgear shall be supplied and laid by the contractor. Terminations at switchgear end and at the equipment end shall be in contractor's scope. Supporting and laying of these cables shall also be in contractor's scope. Termination of HV/LV cables at HV/LV motor end and HV switch gear end including supply of heat shrink type termination kit for HV cables shall be in contractor's scope. Supply and execution of heat shrink type straight through jointing kits for HV All HV power cables shall be made of stranded aluminium conductor with XLPE insulation, PVC inner sheathed FRLS type, armoured, PVC outer sheathed FRLS type, conductor screen, insulation screen and construction as per IS: 7098 (Part 2). HV cables shall be of unearthed type.

Single core HV Power cable shall be of aluminium conductor. The construction of same shall be as per above.

	ELECTRICAL & INSTRUMENTATION SUPPLY CUM ERECTION WORKS TECHNICAL SPECIFICATION ELECTRICAL WORKS (SUPPLY & ERECTION)	PC183/E/8003/SecVI-2.0	0	
		Document No.	Rev	
		Sheet 38 of 109		

- 7.1.2 All LV power cables shall be with stranded aluminium/copper conductor with XLPE insulation, PVC inner sheathed FRLS type , armoured, PVC outer sheathed FRLS type and construction as per IS: 7098 (Part 1). Power cables with conductor size upto and including 16 sq. mm shall be with copper conductor, conductor size 35 sq. mm and above shall be aluminium conductor.
- Single core LV Power cable shall be of aluminium conductor. The construction of same shall be as per above
- 7.1.3 All control cables shall be with 2.5 sq. mm, stranded copper conductor with XLPE insulation, PVC inner sheathed FRLS type, armoured, PVC outer sheathed FRLS type and construction as per IS: 7098 (Part 1). Control cables shall be twisted pair or shielded wherever electro-magnetic/electrostatic interference is anticipated.
- 7.1.4 All control cables shall have 20 % spare cores. All cores shall be identified with numerical core numbers printed on core in addition to colour coding.
- 7.1.5 All cables shall be armoured and shall have extruded inner and outer sheath.
- 7.1.6 Cables connected in parallel shall be of the same type, cross section and terminations.
- 7.1.7 All power and control cables shall be in continuous lengths (except for very long feeders) without any joints. The cables used for lighting and wires in conduits shall have appropriate junction boxes with adequately sized terminals. Cable joints in hazardous areas shall not be permitted.
- 7.1.8 Cable Reel Drum (Motor operated) shall be provided for Wagon Loader and all other places where the cable travel distance is more than 50 mtrs. .
- 7.1.9 The control cables shall be 2.5 sq. mm (Cu). However, wiring in the panel/switch boards may be by means of 1.5 sq. mm (Cu) cables except for CT wiring which shall be 2.5 sq. mm. All the control and power wiring shall be carried by using FRLS wires only.
- 7.1.10 For all other specifications, refer PC183-TS-0815.
- 7.2 **Cable Laying**
- 7.2.1 The cables shall generally be laid on overhead racks. Pipe racks where available, shall be used to support the cable racks.
- HV power cable shall be laid on cable tray in single layer having 1D spacing between the cables. LV power shall be laid on cable tray in touching formation in single layer. Control cable shall be laid on cable tray in touching formation.
- HV Power, LV Power and Control shall be on separate trays. Instrument and electrical cable trays shall be separate.
- Cables shall be clamped properly on the cable rack in such a way that position and layout of a particular cable shall not change throughout the rack so that it can be easily traced during maintenance jobs.
- Walkway fo 750 MM to be considered for access to Electrical / Instrument cables on pipe rack.
- From substations to various electrical consumers, cable shall be laid overhead. However, wherever overhead cable routing is not feasible Contractor can go for cable trench / slit (Refer PDS attached with the NIT) as per the site requirement.
- Wherever, pipe rack is not available and space for overhead cable laying is possible then dedicated structure for cable shall be made for cable laying and shall be in scope of Contractor
- 7.2.2 All FO cable shall be laid through HDPE pipe with all accessories(Connecting arrangement).

	ELECTRICAL & INSTRUMENTATION SUPPLY CUM ERECTION WORKS TECHNICAL SPECIFICATION ELECTRICAL WORKS (SUPPLY & ERECTION)	PC183/E/8003/SecVI-2.0	0	
		Document No.	Rev	
		Sheet 39 of 109		

- 7.2.3 All cables shall be terminated using suitable cable lugs.
- 7.2.4 All HV terminations and joints shall be of RAYCHEM make only.
- 7.2.5 Bimetallic lugs shall be provided, as required.
- 7.2.6 In Control Room (excluding false ceiling) and Substation, lighting cable shall be laid in concealed conduit.
- 7.2.7 For all other specification of cable racks, refer PC183-TS-0816 & PDS attached.

8.0 ILLUMINATION SYSTEM

8.1 General

- 8.1.1 LED type lighting shall be provided. All the plants and area lighting shall be energy efficient.
- 8.1.2 LED shall conform to the following types and standards:-

Product Type	Safety Standard	Performance Standard
Self ballasted LED lamps for general lighting services > 50 V	IEC 62560 Latest Edition	IEC 62612 / PAS Publicly available specification
Control gear for LED modules	IEC 61347-2-13 Latest Edition	IEC 62384 Latest Edition
LED modules for general lighting	IEC 62031 Latest Edition	IEC / PAS 62717 Latest Edition
LED luminaries	IEC 60598-1 Latest Edition	IEC / PAS 62722-2-1 Latest Edition Luminaries performance – Part 2-1: particular requirements for LED
LEDs and LED modules	IEC TS 62504 Terms and Definitions for LEDs and LED modules in general lighting.	

Maintenance factor for indoor lighting shall be considered as 0.7 and for Outdoor lighting 0.6.



The colour rendering index shall not be less than 80%.

The LED lights shall work satisfactorily at the design temperature of 50 Degree Celsius.

All the LED fittings shall be selected in accordance with Hazardous Area Classification.

The life assessment of LEDs shall include control gears/ driver as well.

- 8.1.3 The fixtures shall be complete with all accessories including the lamps, driver, heat sensor and all other accessories. The lighting fixtures shall also conform to the specification sheet for lighting fixture of this specification.
- 8.1.4 The fixtures shall be provided with cable glands and a terminal block suitable for termination of copper conductor up to 2.5 sq. mm size.
- 8.1.5 The fixture shall be so designed that it shall be possible to maintain or replace different accessories without difficulty, including replacement of lamps.
- 8.1.6 Unused holes in control gear box and junction box shall be packed with blanking plugs.
- 8.1.7 All lighting fixtures shall be provided with suitable double compression Al cable glands alongwith termination lugs and blanking plugs for unused entry.
- 8.1.8 All hardware used in lighting fitting, JB's shall be of Stainless Steel only.
- 8.1.9 Minimum Impact Resistance for outdoor fittings shall be IK-05.

	ELECTRICAL & INSTRUMENTATION SUPPLY CUM ERECTION WORKS TECHNICAL SPECIFICATION ELECTRICAL WORKS (SUPPLY & ERECTION)	PC183/E/8003/SecVI-2.0	0	
		Document No.	Rev	
		Sheet 40 of 109		

8.1.10 The fixture shall be so designed that it shall be possible to maintain or replace the different accessories without difficulty, including the replacement of the lamp

8.1.11 LED CHIPS



- a. LED efficacy shall be greater than 140 Lumens/watt at 350mA driver current. In respect of higher power rating LED, driver current greater than 350 mA can be accepted if LED's LM 80 / IS: 16105 test reports are attached.
- b. LED type can be SMD (surface mounted device) of COB (chip on board) type depending on the application. COB type to be considered only for applications such as Highbays, Flood Lights & Flameproof Light Fittings.
- c. Test report/LM80 report for ambient temperature of 55/85/105 Deg. C at rated and maximum current shall be submitted.
- d. TM 21 life projection calculations along with LM80 for ambient temperature of 55/85/105 Deg. C as per applicable standard shall be submitted to substantiate life of LED. Reported Life span of LEDs shall be greater than 50000 Hrs at a soldering temperature of 85 Deg. C at rated driver current.
- e. Colour temperature of white colour LED shall be from 5700K (5665K+/-355K) to 6500K as per ANSI standard C78.377A.
- f. Colour rendering Index for colour ranges from R1 to R15 shall be greater than 80.
- g. LED shall comply to Photo biological safety norms as per IEC 62471/EN62417/IS: 16108 and should fall in the exempt group for indoor luminaires and in exempt of low risk category for outdoor LED luminaires.

8.1.12 LED DRIVER

- a. Minimum efficiency of LED driver shall be 85% for driver output rating of <= 40W and 87% for driver power output rating of > 40W.
- b. Power factor of complete fitting shall be greater than 0.90.
- c. In built high voltage cut-off for voltage above 290 Volt shall be provided.
- d. Short circuit protection and Open load protection shall be provided.
- e. Surge protection device shall be provided for minimum of 2 KV in indoor luminaires and minimum of 10 KV for outdoor luminaires. SPD should be series type with fail safe.
- f. Total Harmonic distortion (THD) shall be less than 10%.
- g. Isolated LED driver should be used. The input (AC side) and output (LED side) are separated by power transformer for galvanic isolation.
- h. Power supply of LED PCB should be through proper connectors.
- i. Driver shall comply EMI/EMC standards CISPR 15/ IS 6873 (CE, RE, CDN) and IS 61547.
- j. Driver shall comply with safety standards IEC 61347-2-13/EN 61347-2-13/IS: 15885-2-13.
- k. Driver shall comply with performance standards IEC: 62384/IS: 16104.

8.1.13 LUMINAIRE

- a. Circuit boards and electronic components rating/type should be suitable to provide reliable functioning.
- b. Luminaire shall have LM-79/IS: 16106 test report from a NABL accredited laboratory.
- c. Minimum system efficacy of luminaire shall be greater than 100 Lumens/watt.
- d. Potting of LED luminaire along with driver is mandatory.
- e. Average Duty cycle to be 12 hours (Dusk to Dawn).
- f. Working temperature to be in the range of – 5 Deg. C to 60 Deg. C.
- g. Working humidity to be in the range of 10% to 100 % RH
- h. Housing of indoor fixtures to be made of CRCA/PC/Aluminium Extrusion and for outdoor fixtures shall be pressure die cast LM6/ADC12/LM24.
- i. Lumen maintenance of fixtures shall be 50,000 Hrs at L70.
- j. LED luminaires shall be completely glare free.

	ELECTRICAL & INSTRUMENTATION SUPPLY CUM ERECTION WORKS TECHNICAL SPECIFICATION ELECTRICAL WORKS (SUPPLY & ERECTION)	PC183/E/8003/SecVI-2.0	0	
		Document No.	Rev	
		Sheet 41 of 109		

- k. View Angle should be typical 120 Deg.
- l. Cover type of indoor fixtures shall be UV stabilised poly carbonate type and outdoor type fixtures to be Toughened glass or UV stabilised poly carbonate type as applicable
- m. Temperature rise for driver at soldering point should not exceed 85 Deg. C. For Heat shrink temperature rise, maximum of 20 Deg. C over ambient temperature is allowable. Heat shrink to be designed accordingly.
- n. Flameproof light fittings shall be certified for use of hazardous area as per area classification and flameproof certificate shall be submitted along with the offer. Explosion proof certificate from PESO shall be submitted before or along with supply of fittings.
- o. Luminaire should have BIS approval for surface mounted luminaire as applicable.
- p. Housing ingress protection shall be as per table below:

Application Type	Minimum Ingress Protection Required
LED Street Light, Flood Light, Outdoor Industrial	IP66
Industrial Indoor (High Bay, Medium bay)	IP54
Toilet Fixtures	IP44
Domestic & Commercial Indoor type LED	IP20



- q. Approve makes for different LED technologies to be as per table below:

LED Technology/type	Approved make
LED Chips SMD (Surface Mounted) type	Nichia, Osram, Lumileds, CREE
LED Chips COB (Chip on Board) type	Citizen, Bridgelux
Domestic/Decorative	Everlight Taiwan, Edison Taiwan, Samsung Korea
Luminaries	Osram, Nichia, Lumileds, CREE

8.1.14 OTHER CONDITIONS

Type Test Report/Certificate from NABL accredited labs as per relevant standards on selected sample including endurance test as per IS10322 and safety test on drivers as per IS 15885.

- 8.1.15 Plant lighting circuits shall be single phase (Phase & Neutral) rated 240 V AC. Each circuit shall be rated to 16A but not loaded more than 8A. A minimum of 25% of MCBs of each board shall be left as spares. The load on one lighting sub-circuit of lighting sub-distribution board and junction box shall be limited to 1000W approx.
- 8.1.16 The lighting sub-distribution board for control of lighting shall be standardized as 18-way, 15-way, 12-way, 9-way and 6-way type.
- 8.1.17 In plant office rooms, wall mounting boards shall be installed to control the lighting. These boards shall include switches for lights, fans, 15A/5A plug sockets and fan regulators etc.
- 8.1.18 15A plug sockets shall be fed through separate circuit of lighting sub-distribution boards/junction box having ELCB of 30mA.
- 8.1.19 16A plug sockets shall be fed through separate circuit of lighting sub-distribution boards/junction box.
- 8.1.20 Illuminated exit sign shall be provided in substation / Control Room .
- 8.1.21 Power factor of complete fitting shall be 0.95 min. at 230 V.

	ELECTRICAL & INSTRUMENTATION SUPPLY CUM ERECTION WORKS TECHNICAL SPECIFICATION ELECTRICAL WORKS (SUPPLY & ERECTION)	PC183/E/8003/SecVI-2.0	0	
		Document No.	Rev	
		Sheet 42 of 109		

- 8.1.22 Lights from LED's shall be soothing to eye and without any bright spots on the floor/objects illuminated by the luminaries.
- 8.1.23 The driver shall be mounted internally and be replaceable with the aid of commonly available hand tools.
- 8.1.24 The LED module or array shall be designed in such a way that the failure of one LED shall not affect additional LED's.
- 8.1.25 Life expectancy of LED Luminaries shall be minimum of 50000 hrs with greater than 70% of rated lumen output.
- 8.1.26 Short circuit protection /Open load protection shall be required for LED fixtures.
- 8.1.27 Cover type for outdoor type fittings shall be Toughened glass or UV stabilized polycarbonate whereas, whereas, for indoor and non-weather proof items, UV stabilized Poly Carbonate can be used.
- 8.1.28 For more details, refer PDS attached.
- 8.1.29 For lighting fixtures and 16 Amp plug socket circuits, 3 core 2.5 sq. mm (Cu) cable shall be used.

8.2 LED Tube Lighting Fixtures (inside Substations)

- a) High quality LED fluorescent tube twin batten type complete with 2 X 20W tube eco friendly, no UV radiation as per the specification tabulated below:

Sl. No.	Parameter	Technical Specification
1.	Degree of Protection	IP-20
2.	Lumen output per Lamp	≥ 2000
3.	CCT	6500K
4.	Luminous efficacy	≥ 100 lm/watt
5.	CRI	>80
6.	Guaranteed Life	≥ 50000 burning hours
7.	PF	>0.95
8.	THD	<10%

8.3 Street Lighting And Security Lighting

- 8.3.1 63A TPN outlet from outdoor lighting bus of main lighting board shall be taken direct to the TPN junction box to be mounted on pole through cable and looped from pole to pole.

- 8.3.2 FRP poles of suitable mounting height shall be used for street light and plant lighting (platforms/ structures/ access ways/ walk ways/ pump house/ pump bay etc.) steel tubular poles of suitable mounting height shall be used

The poles shall be subjected to min. following tests:



- Thickness of galvanising
- Drop test as per IS: 2713.

Deflection test as per IS: 2713

- 8.3.3 Hot dip galvanized octagonal high mast lighting shall be used for yard and general area lighting. LED type fittings may be used.

8.3.4 LED Street Lighting Fixtures

- a) LED Street Light Fitting with cool white light in Pressure Die Cast Aluminium Housing with UV Stabilized Poly Carbonate Cover with in-built power unit of 3500 lumen suitable for 240V, 50 Hz, System shall be used.



	ELECTRICAL & INSTRUMENTATION SUPPLY CUM ERECTION WORKS TECHNICAL SPECIFICATION ELECTRICAL WORKS (SUPPLY & ERECTION)	PC183/E/8003/SecVI-2.0	0	
		Document No.	Rev	
		Sheet 43 of 109		

b) Lighting fixture shall have 50000 hrs. Life Time, CRI>75, IP-65.

9.0 EARTHING AND LIGHTNING PROTECTION

9.1 Earthing

- 9.1.1 Complete earthing installation shall be done as per IS: 3043, IEEE-80, IE Rules and IEC recommendations. The earthing system shall be designed to:
- (a) Provide a permanent & continuous path from equipment and conductor enclosures to earth from circuits for flow of fault current.
 - (b) Provide sufficient current carrying capacity to conduct safely any current liable to be imposed on it.
 - (c) Provide sufficient low resistance to earth to limit the potential between metalwork and earth within safe limits.
 - (d) Provide equal distribution of potential and minimum potential difference for safety of personnel.
 - (e) Ensure sufficient current in case of fault to facilitate the operation of relays, over current devices, fuses etc. provided in the circuit.
- 9.1.2 Common underground earthing grid shall be provided covering sub-stations and plants which is further connected to overall Earthing Grid. The overall earth resistance (dry) shall be limited to 1 ohm.
- 9.1.3 Earthing rings shall be provided around sub-stations and plants which in turn shall be connected to the common earthing grid. Minimum size of main grid shall be 75mm×12mm.
- 9.1.4 Anti-corrosive bituminous paint shall be provided at each joint of earth flat after necessary finishing and priming treatment .
- 9.1.5 Earthing grid/ring shall comprise of buried GI earth strips and GI pipes/electrodes.
- 9.1.6 Separate earth electrodes shall be provided for system neutral earthing. For equipment earthing, minimum two numbers of electrodes shall be provided around each plant/section. However, all these earth electrodes shall be interconnected.
- 9.1.7 Inter-connecting pits having an earth bus in an enclosed brick chamber without earth electrode shall be provided in the common underground earthing grid for convenience of taking earth conductors inside the plants.
- 9.1.8 As far as possible, the reinforcement rods inside concrete column shall be connected to the earthing grid/ring to reduce the overall earth resistance.
- 9.1.9 Individual electrical equipment shall be earthed by GI strip/GI wire/Cu/Al cable. Earth buses shall be provided in plants for earthing groups of electrical/non-electrical equipment to earthing grid/rings.
- 9.1.10 Size of earthing grid/ring and earth conductors of equipment for generating station and sub-stations shall be as per relevant standards. The fault current magnitude shall be decided based on system fault level. The time duration shall be taken as 1 second for voltage level above 66 kV and 3 seconds for voltage upto 66 kV as per IS -3043.
- 9.1.11 All equipment rated above 250 V shall have two external earth connections and those rated up to 250 V shall have one external earth connection. However, for lighting fixtures, earthing shall be done through 3rd core of the cable in safe as well as in hazardous area.
- 9.1.12 Flameproof equipment, in addition, shall have one internal earth connection. This means that 4 core cables to be used for all the flameproof equipments and 3.5 core cables to be used for all flameproof motors located at hazardous area.

	ELECTRICAL & INSTRUMENTATION SUPPLY CUM ERECTION WORKS TECHNICAL SPECIFICATION ELECTRICAL WORKS (SUPPLY & ERECTION)	PC183/E/8003/SecVI-2.0	0	
		Document No.	Rev	
		Sheet 44 of 109		

9.1.13 All steel structures, tanks, vessels, pipes, pipe joints, valves etc. shall be earthed against static charge accumulation by 50x6 mm GI strip. The no. of earth connections shall be as follows:

Equipment having diameter	Hazardous area	Non hazardous area
30 M	2	2
More than 30 M	3	2

9.1.14 Wherever process equipments are mounted on steel structures, the structures shall be earthed instead of earthing the individual equipment.

9.1.15 The pipe structures shall be earthed at not more than 25M apart.

9.1.16 For all equipment in hazardous area, in addition to external earthing one internal earthing shall be provided.

9.1.17 Minimum sizes of earth conductors to be used shall be as given below.

Sl.No.	Equipment	GI conductor size	Al conductor Size
1.	HV/LV switch board, transformers, HV motors	50mm×8mm	150 sq. mm
2.	Motors rated 75 KW and above	50mm×6mm	150 sq. mm
3.	Motors rated 30 KW to less than 75 KW and vessel earthing	35mm×6mm	95 sq. mm
4.	Motors rated 5.5 KW to less than 30 KW	25mm×6mm	25 sq. mm
5.	Motors less than 5.5 KW	8 SWG	6 sq. mm
6.	All minor equipment rated 250V & above.	10 SWG	6 sq. mm
7.	Earth Grid	75mm x 12 mm.	-

All GI conductors shall meet the galvanizing requirement as per IS.

9.1.18 The main ground grid shall be buried in earth at a minimum depth of 1000 mm below finished grade level unless stated otherwise

9.2 Lightning Protection

9.2.1 All structure shall be protected against lightning strokes by suitable lightning protection system to be designed and installed as per IS/IEC-62305.

9.2.2 The number of down conductors shall be minimum two.



9.2.3 Bare metallic structures shall not have any air termination rods at the top. The earth connections shall be welded to the bottom of structure at 300 mm above floor level. However, tall metallic columns with insulation at top shall be provided with air termination rods. Separate earth electrodes shall be provided for each down conductor of lightning protection. However, these shall be inter-connected with the other electrodes in main grid.

9.2.4 Air Terminal

The vertical air terminal rods shall be installed at the roof of buildings to protect these objects from lightning strokes.

The vertical air terminal shall be made of 20 mm dia galvanized steel rod. The projected length of the rod shall be as required to protect the object (on which the rod is fixed) from lightning stroke.

The air terminal rod shall be properly fixed on the top of the building/structure to withstand very high wind pressure. In case the air terminal rod is embedded at the top of roof of building: the portion embedded inside the concrete shall not touch the reinforcement bars and shall be duly insulated from them.

	ELECTRICAL & INSTRUMENTATION SUPPLY CUM ERECTION WORKS TECHNICAL SPECIFICATION ELECTRICAL WORKS (SUPPLY & ERECTION)	PC183/E/8003/SecVI-2.0	0	
		Document No.	Rev	
		Sheet 45 of 109		

All the vertical air terminal rods shall be electrically connected together by means of horizontal conductors of size 50 x 6 mm galvanized steel flats.

The shielding angle for one vertical air termination shall be 45 degrees. For more than one rod, shielding angle between the rods shall be taken as 60 degrees.

Horizontal air termination (i.e. G.S. Flat conductor) shall be so laid that no part of the rod will be more than nine (9) metres from the nearest roof conductor.

9.2.5 Shielding Masts

The shielding mast for lightning protection shall be installed at the top of steel columns cap plates of power house main building.

The shielding mast shall be made of galvanized steel pipe and the height of the same shall be decided considering the zones to be protected.

Each shielding mast shall be connected to grounding grid by a down conductor 50 x 6 mm. Galvanized steel flat run along the building column. In addition all power house building columns joints shall be electrically bonded.

9.2.6 Down Conductors

The down conductors shall be 50 x 6 mm galvanized steel flats. The connection between each down conductor and earth electrode shall be made via test link located at approximately 1500 mm above ground level.

10.0 CABLE TRAYS

10.1 The cable racks shall be ladder type, pre-fabricated from suitable hot dip galvanised steel. Maximum cable tray size shall be 600mm wide. Maximum supporting span shall be 2 Mtrs. Cable trays shall be designed considering 25% margin for future use.

All cable racks must be provided with GI flat strip of size 75mm X12 mm as running earth all along the tray.

10.2 In paved areas/near the equipment, if required, the cables shall be laid in buried G.I. pipes. Protection shall be provided for rising cable with G.I. pipe for a minimum height of 300 mm above floor level.

10.3 All cables shall have their run nos. marked close to the termination as well as at intervals for proper identification.

10.4 All cables shall be terminated at the equipment by means of rolled aluminium/stainless steel heavy duty double compression type cable glands and crimping type lugs.

10.5 The cable racks shall be designed to avoid any sharp bends in the cable. The corners of cable racks shall be smooth with radius not exceeding six meters.



10.6 In case provision of inserts, grouting pockets and openings are required in floors, ceiling, and walls, the same shall be indicated by the vendor within four week of the placement of order. But in case it is necessary to cut modify these requirements or to furnish requirement beyond the above stipulated time, these shall have to carried out by the vendor at the site without any extra cast.

10.7 All the cable shall be properly laid and suitably clamped at regular interval.

10.8 The width of cable trays shall preferably be 150, 300, 450, 600 mm.

10.9 The no of tiers may be decided keeping a clear head clearance of 2.5 m inside the rooms, 6 m while crossing the main roads and 3 m while crossing the branch road. For multiplier racks the minimum gap between the two tiers and between top tier and ceiling shall be 300 mm.

10.10 The minimum sizes of various structural members used for supporting of cable racks shall be as follows:-

	ELECTRICAL & INSTRUMENTATION SUPPLY CUM ERECTION WORKS TECHNICAL SPECIFICATION ELECTRICAL WORKS (SUPPLY & ERECTION)	PC183/E/8003/SecVI-2.0	0	
		Document No.	Rev	
		Sheet 46 of 109		

Members	Size of structural member	Maximum separating distance
	Channel angle	
Support 100x50	75X75X8	1.5 m.
Runner	50x50x6/75X75X8	As per requirement

10.11 Each straight length and bed shall be supplied with two coupling plates fitted at each side channel at one end. The couplings plates shall be complete with bolts, nuts and washers fitted at other four holes for fixing to adjoining member. Coupling plate shall be designed to permit longitudinal adjustment up to ± 10 mm and skew up to 10° .

11.0 MOUNTING STRUCTURES

Switch sockets, cable trays, DBs etc shall be mounted / supported on suitable structure fabricated out of standard sections of mild steel, i.e. channels, angels, flats etc conforming to IS: 2066.

12.0 SPARES

12.1 Commissioning Spares

The commissioning spares shall form an integral part of the scope of supply. Contractor shall be responsible for the quantification of the commissioning spares for the smooth commissioning start up of the plant/ package system. Item wise list of commissioning spares with recommended quantity shall be furnished for information. The same shall be Part of LSTK price

12.2 2 years operational spares (Mandatory)

Contractor shall supply Mandatory spares for all equipments as per SOR.

12.3 Recommended Spares (Other than Mandatory spare)

Contractor shall provide recommended spares (other than mandatory spare) for all the equipment (item-wise) with recommended quantity.

12.4 All spare parts shall be identical to the parts used in the equipments.

12.5 Any other spare parts or special tools not specified, but required, shall also be provided.

13.0 VENDORS' SERVICES

13.1 The Contractor shall consider the services of major equipment suppliers during installation, testing and commissioning in their scope as required.



13.2 The services of engineers of following equipments' (OEM)manufacturers are envisaged and required during installation, Testing and commissioning. Contractor shall arrange for the same without any additional cost implication:

- Numerical relay
- Power Transformer
- LV Switchboard
- PA System



13.3 Site Testing, parameterization and commissioning of the Numerical relays shall be done by OEM expert only.

14.0 TESTING & INSPECTION



14.1 Testing of all electrical equipments shall be done in accordance with relevant IEC/BIS codes in presence of owner's representative at manufacturer's works before despatch / at site before installation. All such tests shall be arranged by the contractor and testing charges, if any, shall be borne by the contractor.

	ELECTRICAL & INSTRUMENTATION SUPPLY CUM ERECTION WORKS TECHNICAL SPECIFICATION ELECTRICAL WORKS (SUPPLY & ERECTION)	PC183/E/8003/SecVI-2.0	0	
		Document No.	Rev	
		Sheet 47 of 109		



- 14.2 The Contractor shall submit the certificates of type tests performed on identical equipment as evidence of the compliance of the equipment with the type tests. All Type Test Certificates shall not be older more than 7 years.
- 14.3 The Contractor shall submit the certificates of routine and acceptance tests conducted on the purchased equipments.
- 14.4 All the routine/acceptance tests shall be performed at the manufacturer's works in the presence of owner's representative.
- 14.5 Stage Inspection of Electrical Equipment shall be considered. The owner or their representative shall be allowed to visit the manufacturing works for stage inspection during manufacturing stage.
- 14.6 The equipment shall be dispatched from works only after receipt of Owner written approval of the test reports.
- 14.7 The Contractor shall intimate the owner 4 weeks in advance of the tests and submit the detailed schedule of tests.
- 14.8 In addition, the equipment shall be inspected at site for final acceptance.
- 14.9 Certified reports of all the tests carried out at the works shall be furnished in six (6) copies for approval of the Owner.
- 14.10 Electrical installation work shall be subjected to inspection by owner / his authorized representative, statutory bodies like Electrical Inspector, Factory Inspector and where applicable by equipment supplier's engineer. The contractor shall carry out without extra cost to owner rectifications / modifications desired by the above authorities to make the installation conforming to I.E. Rules etc.
- 14.11 The owner may reject any portion of the work considered defective or of poor workmanship and the contractor shall make good these defects without extra cost to owner.
- 15.0 **DOCUMENTATION**
- 15.1 The Contractor shall submit the documents for electrical equipments (MS-word, MS-excel and AutoCAD) as per the drawing and documentation schedule as given in this bid package.
- 15.2 Sizing of Electrical system and Equipments shall be submitted during detailed engineering stage.
- 15.3 Contractor shall ensure that following shall be mentioned in each sheet of drawings/ documents in the order mentioned below:
- (a) Logo and Name of the client
 - (b) Logo and Name of the consultant
 - (c) Logo and Name of the contractor (Contractor)
 - (d) Logo and Name of the Manufacturer on the drawings prepared by manufacturer, if applicable
 - (e) Name of the Project for which drawings are applicable
 - (f) Title of the drawing (Title shall indicate the details shown in the drawing)
 - (g) Drawing/ document number with sheet number and number of total sheets in the drawing (Drawings having different title shall be assigned different drawing number)
 - (h) All sheets of each drawing shall bear same title, same document number and same revision number

	ELECTRICAL & INSTRUMENTATION SUPPLY CUM ERECTION WORKS TECHNICAL SPECIFICATION ELECTRICAL WORKS (SUPPLY & ERECTION)	PC183/E/8003/SecVI-2.0	0	
		Document No.	Rev	
		Sheet 48 of 109		



- 15.4 At the time of handing over of the installation, Contractor shall supply as built drawings taking into consideration the actual execution carried out at site.
- 15.5 Erection, testing/ checking (inclusive of calibration check) prior to energisation/ after energisation and commissioning Manuals shall be in bound book format and shall give step by step procedure for:
- (a) Storage, Handling and Erection
 - (b) Checking/ testing after erection and before energisation.
 - (c) Pre-commissioning tests/ checks and cold trials
 - (d) Commissioning
 - (e) Drawings relevant for erection, operation, maintenance and repair of the equipment.
 - (f) List of instruments/ testing kits/ sets, measuring instruments etc. required for testing/ checking with specification, ratings, ranges etc.
- 15.6 Operation & Maintenance Manuals for each of the equipment/ system being shall be in bound book format and shall be supplied alongwith dispatch of equipment and inclusive of following:
- (a) Log sheets indicating daily/ hourly recordings of parameters to be noted down by customer's operating personnel.
 - (b) Procedure for shut down and energisation.
 - (c) Preventive maintenance schedule.
 - (d) Safety procedures for safe operation of equipment and complete system.
 - (e) Specification of equipment installed. Manufacturer's catalogues operation and maintenance manuals for all types of relays/components used.
 - (f) Test procedures for site tests/ checks.
 - (g) Spares list for each equipment/ system for 2 years operation and maintenance.
 - (h) Relevant calculations and protection relay setting table for the equipment/ system being supplied by him
 - (i) Instructions for Diagnostic trouble shooting / fault location charts
 - (j) Tests for checking of proper functioning/ Operation.
 - (k) Storage and re-conservation Manual
 - (l) Safety Manual
 - (m) Drawings relevant for operation, maintenance and repair of the equipment
 - (n) Instructions for Maintenance and Repair
 - (o) List of spare parts with ordering specifications and manufacturer's catalogues.
 - (p) List of consumables with specifications, brand names and annual consumption figures.
 - (q) Manufacturer's catalogues with ordering specification for all items
 - (r) List of special tools and tackles
 - (s) QAP, Internal Test Certificates and Inspection Certificates
 - (t) Procedure for ordering spares.
 - (u) All as built drawings.
- 15.7 Drawings/ documents to be submitted with inspection call of equipment:

	ELECTRICAL & INSTRUMENTATION SUPPLY CUM ERECTION WORKS TECHNICAL SPECIFICATION ELECTRICAL WORKS (SUPPLY & ERECTION)	PC183/E/8003/SecVI-2.0	0	
		Document No.	Rev	
		Sheet 49 of 109		

- (a) Type test certificate for identical equipment
 - (b) Sub-supplier's/ vendor's catalogue/technical literature
 - (c) Test reports for internal inspection
 - (d) Test certificates of components
 - (e) Technical specification & data sheets of equipment
 - (f) All drawings as applicable of category 'Approved', 'Approved with comments' and drawings 'For information/ Reference' including comments thereon
- 15.8 The details of equipment layout and cable routing will be designed by the Contractor during detail engineering stage and these shall be subject to approval by Owner/Consultant. Changes as required to achieve a neat layout with adequate working space all around, for better aesthetics as well as to meet statutory regulation and codes shall be done without any time and cost implication.
- 16.0 **TOOLS & TACKLES**
- The Contractor shall supply at least one set of all special tools required for maintenance of the equipment supplied by them and price shall be included in the offer.
- 17.0 **REVIEW OF DRAWINGS & DOCUMENTS BY OWNER/ CONSULTANT**
- 17.1 The successful Bidder (herein after referred as contractor), shall submit within one month of placement of LOI; list of drawings/ documents/ Manuals that would be submitted by them. The list shall mention Serial Number, Title of the drawing/ document/ manual, Category (For Approval, For review, For Reference, etc) and tentative date of submission. The list shall be prepared taking in to account into consideration stipulations in respect of submission of drawings/ documents and scheduled date for completion.
- 17.2 The Contractor shall ensure that all sheets of the drawings/ documents and top sheet of manual prepared by manufacturer/ vendor/ supplier & submitted by him or by his consortium member or by manufacturer or his consultant, are checked by him/ leader of consortium and vetted by Contractor / Leader of consortium before submission with stamp ensuring correctness, completeness, suitability of document for subject work and compliance with stipulations of order
- 17.3 The responsibility for delay in approval/ review of drawings/ documents due to
- a. Submission of incomplete drawings/ documents not meeting the requirement of project/ stipulations of order
 - b. Non-compliance of comments made earlier
 - c. Drawings are not submitted in requisite copies;
and consequent delay in project shall be that of contractor.
- 17.4 The contractor shall ensure that in case any model number is mentioned in the drawing, detailed technical catalogue, literature, explanatory notes to describe the model and its technical details in full are also submitted along with the drawing. Such drawings/ documents should be assigned Drawing/ Document Number, Number of sheets in the drawing, Rev number etc (Unique Identification). Reference of such drawing/ document number should be mentioned in the drawing.
- 17.5 The drawings/ documents shall be prepared in such sizes that those can be read easily. Size of font in print submitted shall not less than size 10 Arial or equivalent.
- 17.6 The drawings/ documents shall be submitted in sizes in which those are prepared. Photocopies in reduced sizes shall not be accepted.

	ELECTRICAL & INSTRUMENTATION SUPPLY CUM ERECTION WORKS TECHNICAL SPECIFICATION ELECTRICAL WORKS (SUPPLY & ERECTION)	PC183/E/8003/SecVI-2.0	0	
		Document No.	Rev	
		Sheet 50 of 109		

- 17.7 The contractor shall leave space on each sheet for stamping the drawing by Owner/ consultant to avoid stamping on contents of drawing making them unreadable. Submission of drawings in A4 size shall be avoided.
- 17.8 All sheets of a drawing shall be assigned same title and drawing number. Drawings having different title shall be assigned different drawing numbers.
- 17.9 GA drawings, schematic diagrams, single line diagrams, bill of material, data sheets, characteristics curves, cable schedules and cable termination diagrams shall be assigned separate drawing numbers.
- 17.10 Revision shall be clearly marked on all subsequent issue of drawings and documents.
- 17.11 Inability to incorporate some of the comments shall be clearly stated by contractor with reasons and without delay. However, to accept or reject the non-compliance based on the reasons indicated by contractor shall be discretion of Owner/ their consultant.
- 17.12 In case alterations are considered necessary by the contractor in the drawings already approved, such drawings shall be resubmitted for approval again stating the considerations necessitating changes/ alterations. In case, alterations/ changes proposed by contractor are approved by the consultant/ Owner; all other drawings and data affected by such alterations/ changes shall be duly revised and re-submitted for the approval as stated above.
- 17.13 Contractor shall depute their concerned engineers (with the engineers of suppliers, if required) shall visit consultant after submissions of drawings for discussion, modification of drawings and approval so that project is not delayed for want of approval of drawings.
- 17.14 It will be the responsibility of contractor to submit the drawings and obtain approval to meet the project schedule. Delay in approval of drawings due to following shall be the responsibility of contractor:
- a. non-submission of drawings/ documents/ well before those are actually required and/ or
 - b. delay in incorporation of comments and/ or
 - c. non-incorporation of comments by contractor and/ or
 - d. submission of drawings without checking and ensuring requirement stipulated in contract/ order
- 17.15 Contractor shall note that any approval and/ or clearance accorded by Owner or consultant for manufacture and/ or to proceed further given during discussions or recorded in the minutes of the meetings shall be valid only after the drawings showing relevant details are submitted by contractor and clearance/ approval is accorded by Owner/ Consultant by stamping and signing on the relevant drawings.
- 17.16 Approval of drawings by Owner / his consultant shall not relieve the contractor of his contractual obligations and responsibility for engineering, design, workmanship, materials and performance of the equipment
- 17.17 Contractor shall furnish, if requested, additional drawings, calculations, information to the Owner/ Consultant to enable him to examine/ study the drawings submitted.
- 17.18 Contractor shall note that work shall be carried out exactly as indicated in the approved drawings and no alterations shall be made without the written approval of the Owner/ Consultant.
- 18.0 **TRAINING**
- 18.1 Training shall be imparted to owner's personnel at manufacturer's works as under:
- a) PA System : Two engineers for one week .



	ELECTRICAL & INSTRUMENTATION SUPPLY CUM ERECTION WORKS TECHNICAL SPECIFICATION ELECTRICAL WORKS (SUPPLY & ERECTION)	PC183/E/8003/SecVI-2.0	0	
		Document No.	Rev	
		Sheet 51 of 109		

19.0 VENDOR LIST



- 19.1 Make of all electrical equipment shall be as per Vendor List attached with this bid package.
- 19.2 Any other vendor shall be subject to Owner/Consultant's approval.
- 19.3 Any other item for which vendors are not mentioned in NIT, Contractor shall furnish list of proven suppliers with PTR subject to Owner's/ Consultant's approval during detailed engineering. Document(PTR) shall be in English language only.

20.0 QUALITY ASSURANCE

- 20.1 All equipment, components, materials to be supplied by Contractor shall be procured, manufactured, erected, commissioned and tested as per a comprehensive Quality Assurance Programme (QAP) to be approved by the Owner/ Consultant.
- 20.2 The Successful Bidder shall submit within 1 Month of from order; Quality Assurance Plan (QAP) for all the equipment/ panels/ cables/ motors/ devices etc. under their scope of supply.
- 20.3 All routine and acceptance tests shall be carried out as per relevant IS / IEC/ Other Standards during inspection at manufacturer's works in presence of Owner or his representative.
- 20.4 The Contractor shall submit type test certificates for similar equipment supplied by him elsewhere. In case type test certificates (not more than 5 years old and conducted at duly accredited laboratory) for similar equipment is not available, the type test shall be conducted in presence of Owner or his representative without any financial implications to Owner.
- 20.5 The inspection procedure shall be finalized and approved by Owner and/ or their consultant/ authorized representative.
- 20.6 Inspection will be carried out as per drawings and quality assurance plan approved by the Owner/ Consultant. Inspection shall be carried out either at manufacturer's shop/ works or any other place where facilities for conducting tests/ checks are available.
- 20.7 Owner reserves the right to witness any of the tests and verify the documents of the Contractor, his supplier/ vendor/ manufacturer.
- 20.8 Manufacture test certificate for bought out components shall be submitted during inspection.
- 20.9 No equipment or part items shall be dispatched without final acceptance certificate and dispatch instructions in writing issued by Owner and/or their authorized representatives.
- 20.10 The Contractor shall carry out an inspection and testing programme during manufacture in his works and/ or that of his vendor's works to ensure accuracy/ correctness/ completeness of components, compliance with drawings, conformance to functional and / or performance requirements, identify and acceptability of all materials, parts and equipment. The Contractor shall also carry out all tests/ inspections required to establish that the items/ equipment conform to requirements of the specification and the relevant codes/ standards specified in the specification in addition to carrying out tests as per the approved Quality Plan.
- 20.11 Quality audit/ surveillance/ approval of the results of the tests and inspection, approval of drawings will not, however, prejudice the right of the Owner to reject the equipment at any subsequent stage if it does not comply with the specification or does not give complete satisfaction in service and shall in no way limit the liabilities and responsibilities of the Contractor of ensuring complete conformance of the materials/ equipment supplied to relevant specification, standard, data sheets, drawings etc.

	ELECTRICAL & INSTRUMENTATION SUPPLY CUM ERECTION WORKS TECHNICAL SPECIFICATION ELECTRICAL WORKS (SUPPLY & ERECTION)	PC183/E/8003/SecVI-2.0	0	
		Document No.	Rev	
		Sheet 52 of 109		



- 20.12 The owner or their representative shall be allowed to visit the manufacturing works for stage inspection during manufacturing stage.
- 20.13 The Contractor shall intimate the owner 4 weeks in advance of the tests and submit the detailed schedule of tests.
- 20.14 Contractor shall supply reports of type tests, acceptance tests, all requisite factory tests and site tests in bound volumes.
- 20.15 All the equipment shall be tested at site to know their condition and to prove suitability for energisation and required performance.
- 21.0 **COORDINATION WITH OTHER CONTRACTORS**
- 21.1 Contractor shall coordinate with Owner's other Contractors and shall freely exchange all technical information required for this purpose.

	ELECTRICAL & INSTRUMENTATION SUPPLY CUM ERECTION WORKS TECHNICAL SPECIFICATION ELECTRICAL WORKS (SUPPLY & ERECTION)	PC183/E/8003/SecVI-2.0	0	
		Document No.	Rev	
		Sheet 53 of 109		

**SPECIFICATION SHEET
11 / 0.433 KV DISTRIBUTION TRANSFORMERS**



PROJECT: Coal Based Fertilizer Plant		PLANT: Electrical & Instrumentation Package													
ISSUED FOR : PROPOSAL <input type="checkbox"/>		ENQUIRY <input checked="" type="checkbox"/>													
		ORDER <input type="checkbox"/>													
		FINAL <input type="checkbox"/>													
GENERAL															
Item No. :	Ref. Stds. : IS-1180, IS-2026, IEC-60076														
Quantity :	Encl. Docs. :														
Description : Distribution Transformers	Vendor :														
Code No. :	Vendor's Ref. No. :														
TEST TO BE WITNESSED : Routine : <input checked="" type="checkbox"/>															
Heat Run : <input type="checkbox"/>															
Impulse : <input type="checkbox"/>															
Others : <input type="checkbox"/>															
SERVICE CONDITIONS															
SYSTEM DETAILS (PRI. / SEC.)		AMBIENT CONDITIONS													
Nom. Voltage with \pm % : 11KV \pm 10% / 0.433KV \pm 10%		Temp.- Max./Min./Design Ref. : 46 / 1 / 50°C													
Highest System Voltage : 12 / 0.457 KV		Rel. Humidity : 100 %													
Number of phases : 3 Ph / 3 W + N		Alt. above Sea < 1000M													
Rated Frequency with \pm : 50 Hz \pm 5%		Atmospheric Pollution													
Combined V & F Variation : \pm 10 %		Dusts : Coal Dust & Urea Dust													
Fault MVA : 750 MVA / 36 MVA		Vapour : Ammonia & Highly Corrosive													
Earthing Mode : Solidly Earthed		Location													
		Indoor : <input type="checkbox"/>													
		Outdoor : <input checked="" type="checkbox"/>													
AUX. POWER SUPPLY															
		System Data													
		A.C. : 415V \pm 10%, 3P & N, 50Hz \pm 5%													
		D.C. : 110 V													
		Instrument Contact Rating													
		A.C. : 240 V, 5 Amps													
		D.C. : 110 V, 5 Amps													
BASIC DATA															
RATING		TERMINAL CONFIGURATION													
Rated Capacity : 2000 KVA/ 1600 KVA / 1250 KVA		W													
No Load Voltage Ratio : 11 KV / 0.433 KV		X													
Highest Voltage for Eqpt. : 12 KV / 0.457 KV		Z													
Insulation level		Y													
Impulse : 75 KV / --		Shall be provided later.													
Pri.-/ Sec															
Power Freq. : 28 KV / 3 KV		TERMINAL CONNECTIONS													
Impedance at 75° C: As per IS (without negative tolerance)		<table border="1"> <tr> <td rowspan="2" style="text-align: center;">PRI.</td> <td rowspan="2">Arrangement</td> <td>O/H bushing : <input type="checkbox"/></td> </tr> <tr> <td>Bus Duct : <input type="checkbox"/></td> </tr> <tr> <td rowspan="2">Cable cond.</td> <td>Cable : <input checked="" type="checkbox"/></td> <td>Type : 11 KV XLPE-A-FRLS-PVC (AI) UE</td> </tr> <tr> <td>No. & Size :</td> <td></td> </tr> </table>		PRI.	Arrangement	O/H bushing : <input type="checkbox"/>	Bus Duct : <input type="checkbox"/>	Cable cond.	Cable : <input checked="" type="checkbox"/>	Type : 11 KV XLPE-A-FRLS-PVC (AI) UE	No. & Size :				
PRI.	Arrangement					O/H bushing : <input type="checkbox"/>									
				Bus Duct : <input type="checkbox"/>											
Cable cond.	Cable : <input checked="" type="checkbox"/>			Type : 11 KV XLPE-A-FRLS-PVC (AI) UE											
	No. & Size :														
Vector Group : Dyn 11															
Cooling System : ONAN															
Motor I Start & T Start : Shall be informed later															
TAP CHANGER		<table border="1"> <tr> <td rowspan="3" style="text-align: center;">SEC.</td> <td rowspan="3">Arrangement</td> <td>O/H bushing : <input type="checkbox"/></td> </tr> <tr> <td>Bus Duct : <input checked="" type="checkbox"/></td> </tr> <tr> <td>Cable : <input checked="" type="checkbox"/></td> </tr> <tr> <td rowspan="2">Bus cond.</td> <td>Type :</td> <td></td> </tr> <tr> <td>No. & Size:</td> <td></td> </tr> </table>		SEC.	Arrangement	O/H bushing : <input type="checkbox"/>	Bus Duct : <input checked="" type="checkbox"/>	Cable : <input checked="" type="checkbox"/>	Bus cond.	Type :		No. & Size:			
SEC.	Arrangement					O/H bushing : <input type="checkbox"/>									
						Bus Duct : <input checked="" type="checkbox"/>									
		Cable : <input checked="" type="checkbox"/>													
Bus cond.	Type :														
	No. & Size:														
Type of Taps	On Load : <input type="checkbox"/>														
Range of Taps : -5% TO +5%	Off Ckt. : <input checked="" type="checkbox"/>														
No. of Taps : 5 @ 2.5 %															
C.T. REQUIREMENTS															
Differential Protection	3 nos. on Trf. : <input type="checkbox"/>	<table border="1"> <tr> <td colspan="2" style="text-align: center;">Control Cable</td> <td>Type : 1.1 kV XLPE-A-FRLS PVC (ST2) (AI)</td> </tr> <tr> <td colspan="2" style="text-align: center;">Earth Conductor</td> <td>No. & Size :</td> </tr> <tr> <td colspan="2" style="text-align: center;">Cable Gland Type & Material</td> <td>Body :</td> </tr> <tr> <td colspan="2" style="text-align: center;">ADDITIONAL FITTINGS</td> <td>Neutral :</td> </tr> </table>		Control Cable		Type : 1.1 kV XLPE-A-FRLS PVC (ST2) (AI)	Earth Conductor		No. & Size :	Cable Gland Type & Material		Body :	ADDITIONAL FITTINGS		Neutral :
	Control Cable			Type : 1.1 kV XLPE-A-FRLS PVC (ST2) (AI)											
Earth Conductor				No. & Size :											
Cable Gland Type & Material				Body :											
ADDITIONAL FITTINGS		Neutral :													
3 nos. Loose : <input type="checkbox"/>															
Restricted earth fault Protection	1 no. on Trf. : <input checked="" type="checkbox"/> CI-PS														
3 nos. Loose : <input checked="" type="checkbox"/>															
Standby earth fault Protection	1 no. on Trf. : <input checked="" type="checkbox"/> CI-5P10														
1. LV Neutral terminal box		Primary : } Double													
2. Thermometer pocket with cover		Secondary } compression													
3. Tank magnetic oil level gauge		Control : } Rolled AI													
4. Bi-directional roller															
PAINTING															
Type : EPOXY BASED															
Shade : 631 OF IS : 5															
Reqd. : <input checked="" type="checkbox"/> For a period of 2 Years															

- All unfilled data shall be filled by the Contractor. Completely filled in Specification Sheet duly stamped & signed by the Contractor shall be submitted after award of order.
- Impulse test certificate for similar rating shall be furnished after award of order.
- Losses shall be as per energy efficiency level-2 of latest IS 1180

	ELECTRICAL & INSTRUMENTATION SUPPLY CUM ERECTION WORKS TECHNICAL SPECIFICATION ELECTRICAL WORKS (SUPPLY & ERECTION)	PC183/E/8003/SecVI-2.0	0	
		Document No.	Rev	
		Sheet 54 of 109		

TECHNICAL PARTICULARS TRANSFORMERS



PROJECT: Coal Based Fertilizer Plant		PLANT: Electrical & Instrumentation Package	
ISSUED FOR : PROPOSAL <input type="checkbox"/>		ENQUIRY <input checked="" type="checkbox"/>	ORDER <input type="checkbox"/> FINAL <input type="checkbox"/>
GENERAL			
Item no. :	Ref. Stds. :		
Quantity :	Make :		
Description :	Maker's Type :		
Code no. :			
ELECTRICAL DATA			
Rating / Voltage Ratio			
Rated Current - Primary / Secondary			
Rated No Load Current			
Temp. Rise over Ambient - Oil / Winding			
Load Loss at Rated Current at 75° C			
No Load Loss at Rated Voltage / Copper Loss			
Full Load Efficiency at CosΦ - Unity / 0.8 Laq			
Efficiency at 35%, 50% & 100%			
Max. Efficiency & Load at which it occurs			
Full Load Regulation at CosΦ - Unity / 0.8 Laq			
Short Circuit Withstand Capacity			
B max. at Rated V & F (Tesla)			
Excitation Loss per Kg. at B max.			
X/R Ratio			
INSULATION	Primary		
GRADED / UNIFORM	Secondary		
Induced Over Voltage Withstand Capacity : Pri / Sec.			
OLTC : Rated Voltage / Rated Current			
Total Auxiliary Power Requirement : AC / DC			
CONTROL PANELS	Sheet Metal Thickness		
	Enclosure Type		
	Control Scheme Ref. No.		
Cooling Fans : Qty. / Rating			
Minimum Clearance : H.V. / L.V.	i. Between phases		
	a. In air mm		
	b. In oil mm		
	ii. Between phase & earth		
	a. In air mm		
	b. In oil mm		
Short-circuit Impedance at 75 o C			
MECHANICAL DATA			
Core : Material & Grade			
Winding Type : Pri. / Sec.			
INSULATING MATERIAL	Between Turns		
	Between Primary & Secondary		
	Between Core & Winding		
RADIATORS	Cooling Tubes / Separate Bank		
	Thickness		
	Vacuum Withstand Capacity		
TANK	Material		
	Thickness : Side / Bottom / Cover		
	Vacuum Withstand Capacity		
	Over Pressure Capacity		
DIMENSIONS	Overall (LXBXH)		
	Roller C/L		
	Largest Package (LXBXH)		
Minimum Height required to lift the Core			
WEIGHT	Core & Winding		
	Total		
	Heaviest Package		
Oil Quantity in Litres			
Noise Level			
BUSHING DATA (PRI. / SEC. / NEUTRAL)			
Type & Make			
Ref. Standard			
Rated Voltage			

	ELECTRICAL & INSTRUMENTATION SUPPLY CUM ERECTION WORKS TECHNICAL SPECIFICATION ELECTRICAL WORKS (SUPPLY & ERECTION)	PC183/E/8003/SecVI-2.0	0	
		Document No.	Rev	
		Sheet 55 of 109		

Rated Current	
Creepage Distance	
MAKE & TYPE OF BOUGHT OUT ITEMS	
Temperature Indicators : Winding / Oil	
Buchholz Relay / Magnetic Oil Level Gauge	
Cooling Fans / Current Transformers	
OLTC	
Control Panels	
Pressure Release Device	

NOTE:

- Completely filled in Technical Particulars Sheet for each type and rating of transformer in line with NIT/Contract, shall be submitted after award of order for Owner/Consultant approval, before commencement of manufacturing.

	ELECTRICAL & INSTRUMENTATION SUPPLY CUM ERECTION WORKS TECHNICAL SPECIFICATION ELECTRICAL WORKS (SUPPLY & ERECTION)	PC183/E/8003/SecVI-2.0	0	
		Document No.	Rev	
		Sheet 56 of 109		



**SPECIFICATION SHEET
415 V Switchboard**

PROJECT: Coal Based Fertilizer Plant		PLANT: Electrical & Instrumentation Package		
ISSUED FOR: PROPOSAL <input type="checkbox"/>		ENQUIRY <input checked="" type="checkbox"/>	ORDER <input type="checkbox"/> FINAL <input type="checkbox"/>	
GENERAL		AMBIENT CONDITION		
Ref. Stds. : IS & IEC	Temp. Max./Min./Design Ref.: 47 / 1.7 / 50°C			
Encl. Docs. :	Relative Humidity 100 % Alt. above sea : <1000 M			
Vendor :	Atmospheric Pollution	Dusts : Coal Dust & Urea Dust		
Vendor Ref. No. :		Vapour : Ammonia & Highly Corrosive		
	Location	Indoor <input checked="" type="checkbox"/>	Outdoor <input type="checkbox"/>	
		Gr. Floor <input type="checkbox"/>	1 st floor <input checked="" type="checkbox"/>	
Addl. Scope :	Incoming Bus Duct <input type="checkbox"/>	Tie Bus Duct <input type="checkbox"/>		
	Erection & Comm. <input checked="" type="checkbox"/>	Supervision of Erection Comm. <input type="checkbox"/>		
TESTS:	Routine <input checked="" type="checkbox"/>	Type <input type="checkbox"/>	Others <input type="checkbox"/>	
BASIC DATA				
TAG NO.	Item No.			
	Description	415V SWITCHBOARDS		
	Code No.	--		
REFERENCE DRAWINGS	Single Line Diagram			
	Feeder Details			
SYSTEM DETAILS	Auto Trip Alarm Scheme			
	Non Trip Alarm Scheme			
	Trip Circuit Supervision Scheme			
	Auto C/O Scheme			
	P.T. Bus Arrangement			
	Nominal Voltage with Variation	415V ± 10%		
Rated Frequency with Variation	50Hz ± 5%			
Combined V & F Variation	± 10%			
No. of Phases & Wires	3 Ph & 4W			
Insulation Level	2.5 KV			
Fault Level	36 MVA			
Earthing Mode	Solidly Earthed			
BUS BARS	Rating	Continuous	_____ A	
		Short Time for 1 sec.	50 KA	
	Bare / Insulated	Insulated		
	Type of Insulation	Heat Shrinkable PVC sleeved		
EXECUTION	Breaker	I/C: ST / DT	ST	
	Feeders	Others: ST / DT	DT	
	Other Feeders	Single front / Double front	Double Front	
		Fixed / Drawout	Drawout	
	Cable Entry : Top / Bottom	Bottom		
	Bus Duct Entry : Top / Bottom	--		
Accessibility : Front / Back	Front / Back			
CONTROL SUPPLY	Breaker Feeders	Closing & Indication	110V DC **	
		Tripping	110V DC **	
	Contactors	240V AC		
	Space Heater	240V AC		
MISC. DATA	Painting	Type	Epoxy	
		Shade	631 of IS: 5	
	Period for which Spares required	2 Years		

ST- SINGLE TIER
DT- DOUBLE TIER



NOTE:

- **110V DC Power required for closing, tripping and indication of circuit breaker feeder shall be provided by the vendor through in-built power pack in the feeders having battery back-up of 30 minutes.
- For metering, protection etc. refer SLD.
- All unfilled data shall be filled by the Contractor. Completely filled in Specification Sheet duly stamped & signed by the Contractor shall be submitted after award of order.



	ELECTRICAL & INSTRUMENTATION SUPPLY CUM ERECTION WORKS TECHNICAL SPECIFICATION ELECTRICAL WORKS (SUPPLY & ERECTION)	PC183/E/8003/SecVI-2.0	0	
		Document No.	Rev	
		Sheet 57 of 109		

TECHNICAL PARTICULARS 415V SWITCHBOARDS



PROJECT: Coal Based Fertilizer Plant		PLANT: Electrical & Instrumentation Package	
ISSUED FOR: PROPOSAL <input type="checkbox"/>		ENQUIRY <input checked="" type="checkbox"/>	ORDER <input type="checkbox"/> FINAL <input type="checkbox"/>
GENERAL			
Manufacturer's Type			
Ref. Standards			
Rated Operational Voltage with \pm %			
Rated Insulation Voltage			
Rated Voltage of Aux. Circuits with \pm %			
Rated Current			
Short Circuit Rating			
Degree of Protection of Enclosure			
Service Conditions : Indoor / Outdoor			
DRAWOUT FACILITIES	Circuit Breakers		
	P.Ts.		
	Motor Starters		
	Protective Relays		
SINGLE FRONT / DOUBLE FRONT	Meters		
	C.B. Feeders		
SINGLE FRONT / DOUBLE FRONT	Other Feeders		
	Cable Entry :	Top / Bottom	
Accessibility :	Front / Back		
MAXIMUM NOS. OF FEEDERS IN ONE PANEL	Circuit Breakers		
	Motor Starters		
	Switch Fuse		
SHEET STEEL TYPE & THICKNESS	Load Bearing member		
	Non Load Bearing member		
	Base Channel		
Material of Gaskets			
Material of External Hardware			
Operating Height : Max. / Min.			
Space Heater Rating of each Panel			
PAINTING	Method of Pre-treatment		
	Type		
	Thickness of Paint		
	Finishing Shade		
Dimensions : L X B X H / Dim. Drg. Ref. No.			
Shipping Dimensions of Largest Package			
Weight : Static / Dynamic			
BUS - BARS			
Material			
SIZE	HBB : Phase / Neutral		
	VBB : Phase / Neutral		
	Ground		
	Supporting Calculations Attached		
MINIMUM CLEARANCE	Between Phases		
	Between Phase & Earth		
Minimum Creepage Distance			
Current Rating : Continuous / Short Time			
Temp. Rise for : Cont. Load / Short Time Current			
SUPPORT	Material		
	BIL		
	Arrangement : Separate/Common		
Material of Bus-bar Insulation			
Shrouding Material for Joints			
No. & Type of Bolts			
CIRCUIT BREAKERS			
Make			

	ELECTRICAL & INSTRUMENTATION SUPPLY CUM ERECTION WORKS TECHNICAL SPECIFICATION ELECTRICAL WORKS (SUPPLY & ERECTION)	PC183/E/8003/SecVI-2.0	0	
		Document No.	Rev	
		Sheet 58 of 109		

Maker's Type	
Ref. Standards	
Type of Circuit Breaker	
Short Circuit Category	
Maximum Operating Voltage	
No. of Poles	
CURRENT RATING	Continuous
	1 second RMS
	Momentary (kA Peak)
BREAKING CURRENT	Symmetrical KA
	Asymmetrical KA
	Sym. MVA at Rated Voltage
Making Current (Peak)	
INSULATION LEVEL	1 Min. PF withstand Voltage
	Impulse withstand Voltage
No. of Breaks per Pole	
TYPE AND MATERIAL OF	Main Contacts
	Arcing Contacts
Contact Pressure	
Type of Closing Mechanism	
Type of Tripping Mechanism	
Type of Arc Control Device	
Arc Pumping Features with Details	
Trip Free Features with Details	
Total Closing Time	
Interrupting Time at 10%, 50%, 100% of rated Interrupting Capacity	Total
	Arcing Time
SPRING CHARGING MOTOR	Rating
	Voltage
	Insulation
	Duty
Spring Charging Time	
CONTROL VOLTAGE WITH RANGE	Closing
	Tripping
	Alarm and Indication
POWER/ CURRENT REQUIRED FOR	Closing
	Tripping
AUXILIARY CONTACTS	No. of Spare Contacts : NO / NC
	Contact Rating : AC / DC
	Convertible : Yes / No
Net Weight of Breaker	
Type Testing Authority & Test Report Ref. No.	
CURRENT TRANSFORMERS	
Make / Maker's Type	
Ref. Standard	
Type of Primary Winding	
Ratio	
Rated Burden	
Accuracy Class	
ALF / ISF	
Insulation Class & Material	
Ref. Magnetisation Curve No.	
POTENTIAL TRANSFORMERS	
Make / Maker's Type	
Ref. Standard	
Winding Connection	
Ratio	
Rated Burden	
Accuracy Class	

	ELECTRICAL & INSTRUMENTATION SUPPLY CUM ERECTION WORKS TECHNICAL SPECIFICATION ELECTRICAL WORKS (SUPPLY & ERECTION)	PC183/E/8003/SecVI-2.0	0	
		Document No.	Rev	
		Sheet 59 of 109		



Insulation Class & Material	
SWITCHES	
Make / Maker's Type	
Ref. Standard	
Type of Switch	
Rated Operational Voltage	
Utilisation Category	
Rated Operational Current	
Short Time Withstand Current	
No. of Poles / Break	
Type Test Certificate Ref. No.	
FUSES	
Make / Maker's Type	
Ref. Standard	
Type of HRC Fuse	
Rated Voltage / Current	
Category of Duty	
Prospective Breaking Current	
CURRENT TIME CURVE SHOWING PRE-ARCING AND TOTAL I²T VALUES	Ref. No. Attached
CONTACTORS	
Make / Maker's Type	
Ref. Standard	
Rated Operational Voltage	
Utilisation Category	
Rated Duty	
Rated Thermal Current	
OPERATING VOLTAGE OF COIL	Pick up Max./Min. Drop off Max./Min.
Coil Consumption Pick up / Hold on	
RELAYS	
Make / Maker's Type	
Ref. Standard	
Operating Principle	
Setting Range	
Type of Mounting	
Burden	
Reset : Hand or Self	
Flag Indication Type	
Ref. Characteristic Curve Type	
Ref. Descriptive catalogue	
INSTRUMENTS AND METERS	
Make / Maker's Type	
Ref. Standard	
Operating Principle	
Scale Range	
Accuracy	
Size	
Type of Mounting	
CONTROL SWITCHES	
Make / Maker's Type	
Ref. Standard	
Contact Rating	
Utilisation Category	
PUSH BUTTONS	
Make / Maker's Type	
Ref. Standard	
Contact Rating	
Utilisation Category	
SIGNAL LAMPS	

	ELECTRICAL & INSTRUMENTATION SUPPLY CUM ERECTION WORKS TECHNICAL SPECIFICATION ELECTRICAL WORKS (SUPPLY & ERECTION)	PC183/E/8003/SecVI-2.0	0	
		Document No.	Rev	
		Sheet 60 of 109		

Make / Maker's Type	
Ref. Standard	
Rated Voltage / Watts	
Type of Lamp Holder	
Type of Globe	
MINIATURE CIRCUIT BREAKER	
Make / Maker's Type :	
Ref. Standards	
Rated Current	
Breaking Capacity	
MOULDED CASE CIRCUIT BREAKERS	
Make / Maker's Type	
Ref. Standard	
Current Rating	
Breaking Capacity	
Setting Range of Thermal Release	
Setting Range of Magnetic Release	
CABLE GLANDS	
Material	
Type	
TERMINAL BLOCKS	
Make	
Type	
Current Rating	

NOTE:

- Completely filled in Technical Particulars Sheet in line with NIT/Contract, shall be submitted after award of order for Owner/Consultant approval, before commencement of manufacturing.
- Inter-tripping of primary and secondary of transformer shall be provided for all faults through lockout relays.



	ELECTRICAL & INSTRUMENTATION SUPPLY CUM ERECTION WORKS TECHNICAL SPECIFICATION ELECTRICAL WORKS (SUPPLY & ERECTION)	PC183/E/8003/SecVI-2.0	0	
		Document No.	Rev	
		Sheet 61 of 109		

SPECIFICATION SHEET

FLOOR MOUNTED AUXILIARY SERVICE POWER BOARD / MLDB / PDB



PROJECT: Coal Based Fertilizer Plant		PLANT: Electrical & Instrumentation Package		
ISSUED FOR: PROPOSAL <input type="checkbox"/>		ENQUIRY <input checked="" type="checkbox"/>	ORDER <input type="checkbox"/> FINAL <input type="checkbox"/>	
GENERAL		AMBIENT CONDITION		
Ref. Stds. :	IS & IEC	Temp. Max./Min./Design Ref.:	47 / 1.7 / 50°C	
Encl. Docs. :		Relative Humidity	100 %	
Vendor :		Alt. above sea :	<1000 M	
Vendor Ref. No. :		Atmospheric Pollution	Dusts : Coal Dust & Urea Dust	
			Vapour : Ammonia & Highly Corrosive	
		Location	Indoor <input checked="" type="checkbox"/> Outdoor <input type="checkbox"/>	
			Gr. Floor <input type="checkbox"/> 1 st floor <input checked="" type="checkbox"/>	
Addl. Scope :	Incoming Bus Duct	Tie Bus Duct		
	Erection & Comm.	<input checked="" type="checkbox"/>	Supervision of Erection Comm. <input type="checkbox"/>	
TESTS:	Routine <input checked="" type="checkbox"/>	Type <input type="checkbox"/>	Others <input type="checkbox"/>	
BASIC DATA				
TAG NO.		AUXILIARY SERVICE POWER BOARD		
REFERENCE DRAWINGS	Diagram	Refer SLD attached		
SYSTEM DETAILS	Nominal Voltage with Variation	415V ± 10%		
	Rated Frequency with Variation	50 Hz ± 5%		
	Combined V & F Variation	± 10%		
	No. of Phases & Wires	3 Phase, 4 wire		
	Insulation Level	2.5 KV		
	Fault Level	36 MVA		
	Earthing Mode	Solidly Earthed		
BUS BARS	Rating	Continuous	A	
		Short Time for 1 sec.	50 kA	
	Material of Construction	High Conductivity Copper		
	Bare / Insulated	Insulated		
Type of Insulation	Raychem make Heat Shrinkable PVC Sleeves			
EXECUTION	Single Front / Double Front	Single Front		
	Drawout / Non Drawout	Drawout		
	CABLE ENTRY	Top	Yes	
Bottom				
MISC. DATA	Dummy Panel Reqd. (Yes / No)	No		
	Width of Dummy Panel	--		
	No. of Dummy Panel	--		
	PAINTING	Type	Epoxy Based	
		Shade	RAL: 7032	
Spares Parts Reqd. For a Period of	2 YEARS			

NOTE: All unfilled data shall be filled in and submitted along with the bid and for owner/consultant approval before commencement of manufacturing in line with NIT/PO.

	ELECTRICAL & INSTRUMENTATION SUPPLY CUM ERECTION WORKS TECHNICAL SPECIFICATION ELECTRICAL WORKS (SUPPLY & ERECTION)	PC183/E/8003/SecVI-2.0	0	
		Document No.	Rev	
		Sheet 62 of 109		



**SPECIFICATION SHEET
LIGHTING SUB DISTRIBUTION BOARD**

PROJECT: Coal Based Fertilizer Plant		PLANT: Electrical & Instrumentation Package		
ISSUED FOR : PROPOSAL <input type="checkbox"/> ENQUIRY <input checked="" type="checkbox"/>		ORDER <input type="checkbox"/> FINAL <input type="checkbox"/>		
GENERAL		AMBIENT CONDITION		
Ref. Stds. : IS/IEC		Temp. - Max / Min / Design ref.: 46 / 1 / 50°C		
Encl. Docs. :		Relative Humidity: ≤ 100%; Alt. above sea : <1000 M		
Vendor :		Atmospheric Pollution		
Vendor Ref. No. :		Dusts : Coal Dust & Urea Dust		
SYSTEM DETAILS		Vapour : Ammonia & Highly		
Nominal Voltage with + % : 415V+ 10%,		Area		
Rated Frequency with + % : 50 Hz± 5%,		Safe <input type="checkbox"/> Hazardous <input type="checkbox"/>		
Combined V & F Variation : ± 10%,		Hazardous Area Class		
No. of Phases & Wires : 3-Phase, 4-wire		Zone : Encl. Gr. :		
TESTS TO BE WITNESSED: Routine <input checked="" type="checkbox"/>		Temp. Class : T3		
		Location Indoor <input type="checkbox"/> Outdoor <input checked="" type="checkbox"/>		
		Type <input type="checkbox"/> Others <input type="checkbox"/>		
BASIC DATA				
Item No. :				
Quantity :				
Description :		LSDB		
Code No.		LSDB		
DC LSDB				
Incoming & Outgoing feeders		Refer SLD		
Degree of Protection :		Min IP55		
Addl. Degree of Protection :		--		
Cable Type & size				
Incoming				
Outgoing		1.1 KV, 3x2.5 sq. mm. (Cu) XLPE-A-FRLS PVC		
Painting Type & Shade :		Epoxy based, RAL 7032		
Period for which Spares required :		2 years		
		1.1 KV, 3x2.5 sq. mm. (Cu) XLPE-A-FRLSPVC		
		Epoxy based, RAL 7032		
		2 years		
- All unfilled data shall be filled by the Contractor. Completely filled in Specification Sheet duly stamped & signed by the Contractor shall be submitted after award of order.				
TECHNICAL PARTICULARS				
Completely filled in Technical Particulars Sheet in line with NIT/Contract, shall be submitted after award of order for Owner/ Consultant approval, before commencement of manufacturing.				
General	Item No. :			
	Make & Maker's Type			
	Material & Thickness of Enclosure			
	Gasketing Material			
	COVER TYPE	Internal :		
		External :		
	PAINTING	Pre treatment		
		Shade		
	Material of Ext. Hardware < 8mm / > 8mm			
	Dimensional Drawing Reference No. :			
Weight :				
M.C.B.	Make & Maker's Type			
	Reference Standards			
	Category of Duty :			
	Rated Current :			
	No. of Poles :			
Terminal Block	Type of Neutral :			
	Make & Type			
Cable Gland	Rated Current			
	Type :			
Material :				

	ELECTRICAL & INSTRUMENTATION SUPPLY CUM ERECTION WORKS TECHNICAL SPECIFICATION ELECTRICAL WORKS (SUPPLY & ERECTION)	PC183/E/8003/SecVI-2.0	0	
		Document No.	Rev	
		Sheet 63 of 109		

SPECIFICATION SHEET SWITCH SOCKET & PLUG

PROJECT: Coal Based Fertilizer Plant		PLANT: Electrical & Instrumentation Package		
ISSUED FOR : PROPOSAL <input type="checkbox"/>		ENQUIRY <input checked="" type="checkbox"/>		
		ORDER <input type="checkbox"/>		
		FINAL <input type="checkbox"/>		
GENERAL		AMBIENT CONDITION		
Ref. Stds. :	IS / IEC	Temp. - Max / Min / Design ref.: 46 / 1 / 50°C		
Encl. Docs. :		Max Relative Humidity ≤ 100% Alt. above sea : <1000 M		
Vendor :		Atmospheric Pollution	Dusts : Coal Dust & Urea Dust	
Vendor Ref. No. :			Vapour : Ammonia & Highly Corrosive	
Sample Req. :		Area	Safe <input type="checkbox"/> Hazardous - <input type="checkbox"/>	
		Hazardous Zone :	Encl. Gr. :	
		Area Class	Temp. Class :	
		Location :	Indoor <input checked="" type="checkbox"/> Outdoor <input checked="" type="checkbox"/>	
TESTS TO BE WITNESSED :		Routine <input checked="" type="checkbox"/>		
		Type <input type="checkbox"/>		
		Others <input type="checkbox"/>		
BASIC DATA				
Item No.				
Quantity				
Rated Voltage & Frequency		415V/240V+ 10%, 50 Hz± 5%.		
Rated Current		63A/15 Amp		
No. of Phases & Pins		3ph/1 Ph, 3 Pin		
Degree of Protection		IP65		
Addl. Degree of Protection		--		
Cable Size	Supply			
	Plug	--		
Period for which Spares required		2 Years		
- All unfilled data shall be filled by the Contractor. Completely filled in Specification Sheet duly stamped & signed by the Contractor shall be submitted after award of order.				
TECHNICAL PARTICULARS				
Completely filled in Technical Particulars Sheet in line with NIT/Contract, shall be submitted after award of order for Owner/Consultant approval, before commencement of manufacturing.				
General	Make & Maker's Type			
	Material & Thickness of Enclosure			
	Gasketing Materials			
	Material of Ext. Hardwares < 8mm / > 8mm			
	Cable glands Type & Material			
	Painting	Pre treatment		
		Shade		
	Dimensional Drawing Reference No.			
Weight of Switch Socket / Plug				
Switch	Make & Maker's Type			
	Reference Standards			
	Rated Current			
	Utilisation Category			
Fuse	Make & Maker's Type			
	Reference Standards			
	Rated Current			
Socket	Make & Maker's Type			
	Reference Standards			
	Rated Current			
Plug	Make & Maker's Type			
	Reference Standards			
	Rated Current			



	ELECTRICAL & INSTRUMENTATION SUPPLY CUM ERECTION WORKS TECHNICAL SPECIFICATION ELECTRICAL WORKS (SUPPLY & ERECTION)	PC183/E/8003/SecVI-2.0	0	
		Document No.	Rev	
		Sheet 64 of 109		

**SPECIFICATION SHEETS
JUNCTION BOX**

PROJECT: Coal Based Fertilizer Plant		PLANT: Electrical & Instrumentation Package	
ISSUED FOR : PROPOSAL <input type="checkbox"/>		ENQUIRY <input checked="" type="checkbox"/>	ORDER <input type="checkbox"/> FINAL <input type="checkbox"/>
GENERAL			
Ref. Stds.		IS / IEC	
Encl. Docs.			
Make			
Maker's type			
Sample Required		Yes <input type="checkbox"/>	No <input checked="" type="checkbox"/>
AMBIENT CONDITIONS			
Temp. Max. / Min. / Design Ref.		46 / 1 / 50°C	
Rel. Humidity		100%	
Alt. Above Sea Level		<1000M	
ATMOSPHERIC POLLUTION	Dusts	Dusts : Coal Dust & Urea Dust	
	Vapours	Vapour : Ammonia & Highly Corrosive	
Area		Safe <input checked="" type="checkbox"/>	Hazardous <input type="checkbox"/>
Hazardous area classification		Zone:	Encl. Gr.: Temp. Class:
Location		Indoor <input checked="" type="checkbox"/>	Outdoor <input checked="" type="checkbox"/>
TESTS		Routine <input checked="" type="checkbox"/>	Type <input type="checkbox"/> Others <input type="checkbox"/>
BASIC DATA			
Item No.			
Quantity			
Rated Voltage		240V±10%	
Rated Frequency		50Hz±5%	
Rated Current		16A	
No. of Phases & Wires		1Phase / 3wires (PNE)	
Application		For looping of cable	
Material of Enclosure			
Shape of Enclosure		Round	
Degree of Protection		IP-55	
Addl. Degree of Protection		--	
Type of Cover		Dome	
No. of Outlets		3 nos. + one plug	
PAINTING	Type: Epoxy based		
	Shade: 631 as per IS: 5		
SPARE	Required: Yes		
	Duration: 2 Years operation and maintenance		
No. of Terminals: As required			
Cable gland: 4 nos.			
Stopping Plug: 1 no.			
CABLE SIZE	Incoming -- 3Cx2.5 mm ² (Cu) 1.1 KV XLPE ARMoured FRLS PVC		
	Outgoing -- 3Cx2.5 mm ² (Cu) 1.1 KV XLPE ARMoured FRLS PVC		

Note:



- Double compression rolled aluminium cable glands, lugs and plugs shall be provided
- All unfilled data shall be filled by the Contractor. Completely filled in Specification Sheet duly stamped & signed by the Contractor shall be submitted after award of order.

	ELECTRICAL & INSTRUMENTATION SUPPLY CUM ERECTION WORKS TECHNICAL SPECIFICATION ELECTRICAL WORKS (SUPPLY & ERECTION)	PC183/E/8003/SecVI-2.0	0	
		Document No.	Rev	
		Sheet 65 of 109		

**TECHNICAL PARTICULARS
JUNCTION BOX**

PROJECT: Coal Based Fertilizer Plant		PLANT: Electrical & Instrumentation Package	
ISSUED FOR : PROPOSAL <input type="checkbox"/>		ENQUIRY <input checked="" type="checkbox"/>	
ORDER <input type="checkbox"/>		FINAL <input type="checkbox"/>	
GENERAL			
Item No.			
Ref. Std.			
Type of Junction Box			
Make			
Maker's type			
CONSTRUCTIONAL FEATURES			
Material of Construction			
Thickness of Enclosure			
Enclosure Protection Class			
Mounting Arrangement			
Cover Fixing Arrangement			
Gasketing Material			
External Cable Sizes			
Dimensions L X B X H / Dimensional Drg. Ref. No.			
Weight			
Painting			
Type Test Certificate No.			
CABLE GLAND			
Type			
Material of Construction			
Make			
TERMINAL BLOCK			
Nos. of Terminals			
Material			
Type			
Current Rating			
Fixing Arrangement			
Make			



NOTE: Completely filled in Technical Particulars Sheet in line with NIT/Contract, shall be submitted after award of order for Owner/Consultant approval, before commencement of manufacturing..

	ELECTRICAL & INSTRUMENTATION SUPPLY CUM ERECTION WORKS TECHNICAL SPECIFICATION ELECTRICAL WORKS (SUPPLY & ERECTION)	PC183/E/8003/SecVI-2.0	0	
		Document No.	Rev	
		Sheet 66 of 109		

**SPECIFICATION SHEET
DCDB**

PROJECT: Coal Based Fertilizer Plant		PLANT: Electrical & Instrumentation Package		
ISSUED FOR : PROPOSAL <input type="checkbox"/> ENQUIRY <input checked="" type="checkbox"/>		ORDER <input type="checkbox"/> FINAL <input type="checkbox"/>		
GENERAL		AMBIENT CONDITIONS		
Ref. Stds. : IS/IEC		Temp.- Max / Min / Design ref.: 46 / 1 / 50°C		
Encl. Docs. : <input type="checkbox"/>		Relative Humidity: 100% Max.	Alt. above Sea Level <1000M	
Make : As per enclosed vendor list		Atmospheric Pollution	Dusts : Coal Dust & Urea Dust	
Maker's Type :			Vapour : Ammonia & Highly Corrosive	
		Location	A/C Room <input type="checkbox"/> Ventilated Room <input checked="" type="checkbox"/>	
			Non Ventilated Room <input type="checkbox"/>	
TESTS: Type <input type="checkbox"/> Routine <input checked="" type="checkbox"/> Acceptance <input type="checkbox"/> Others <input type="checkbox"/>				
BASIC DATA				
TAG NO.	Item No.	DCDB		
	Description	DC DISTRIBUTION BOARD		
	Code No.			
REFERENCE DRAWINGS	Single Line Diagram	--		
SYSTEM DETAILS	Nominal Voltage with Variation	110V DC		
	Rated Frequency with Variation	--		
	Combined V & F Variation	--		
	No. of Phases & Wires	1 Phase 2 wire		
	Insulation Level	1.1 KV		
	Fault Level			
BUS BARS	Rating	Continuous		
		Short Time for 1 sec.	16 kA	
	Material of Construction	Al		
	Bare / Insulated	Insulated		
	Type of Insulation	Heat Shrinkable Raychem Sleeves		
EXECUTION	Single Front / Double Front	Single Front		
	Drawout / Non Drawout	Non Drawout		
	CABLE ENTRY	Top	--	
		Bottom	Yes	
MISC. DATA	Dummy Panel Reqd. (Yes / No)	No		
	Width of Dummy Panel	--		
	No. of Dummy Panel	--		
	PAINTING	Type	Epoxy Based	
		Shade	RAL 7035	
	Spares Parts Reqd. For a Period of			



- Note : All unfilled data shall be filled by the Contractor. Completely filled in Specification Sheet duly stamped & signed by the Contractor shall be submitted after award of order.

	ELECTRICAL & INSTRUMENTATION SUPPLY CUM ERECTION WORKS TECHNICAL SPECIFICATION ELECTRICAL WORKS (SUPPLY & ERECTION)	PC183/E/8003/SecVI-2.0	0	
		Document No.	Rev	
		Sheet 67 of 109		

**SPECIFICATION SHEET
ELECTRICAL EQUIPMENT FOR CRANES & HOISTS**



PROJECT: Coal Based Fertilizer Plant		PLANT: Electrical & Instrumentation Package	
ISSUED FOR : PROPOSAL <input type="checkbox"/>		ENQUIRY <input checked="" type="checkbox"/>	
ORDER <input type="checkbox"/>		FINAL <input type="checkbox"/>	
GENERAL			
Item No. :		Ref. Stds. : IS/IEC	
Quantity :		Encl. Docs.	
Description :		Make : As per vendor list enclosed	
Code No. :		Maker's Type. :	
TESTS: Routine <input checked="" type="checkbox"/>		Type <input checked="" type="checkbox"/>	
		Others <input checked="" type="checkbox"/>	
SERVICE CONDITIONS			
SYSTEM DETAILS		AMBIENT CONDITION	
Rated Voltage with + % : 415 V ± 10 %		Temp: - 46 / 1 / 50°C	
No. of phases : 3 Ph, 4 Wire		Relative Humidity: 100% Max. Alt. above sea : <1000 M	
Rated Frequency With + % : 50 Hz ± 5 %		ATMOSPHERIC POLLUTION Dusts : Coal Dust & Urea Dust Vapour : Ammonia & Highly Corrosive	
Combined V & F variation : ± 10 %			
Fault Level :		AREA * Safe <input type="checkbox"/> Hazardous <input type="checkbox"/>	
Earthing Mode : Solidly Earthed		HAZ. AREA CLASS. * Zone : Encl. Gr. :	
Control Supply Voltage : 240 V AC, 1 Ph.		Temp. Cl.	
Lighting & Fan Supply Voltage : 415 V (3 Ph)/ 240 V (1Ph) AC		Location : Indoor <input type="checkbox"/> Outdoor <input type="checkbox"/>	
Hand Lamp Supply Voltage:- 24 V AC			
MISCELLANEOUS DATA			
POWER FEED METHOD		PAINTING	
Flexible Cable :		Type :	
Overhead Bar Conductor :		Shade : of IS : 5	
Incoming Cable Type : size :		SPARE PARTS Required <input checked="" type="checkbox"/> For Period of 2Years operation & maintenance	
CONTROLS			
Pendant Control Station :			
Operator's Cabin :			
MAKE OF EQUIPMENT AND COMPONENTS			
Motors :			
Switch :			
Contactor :			
Fuse :			
Push Button :			
Limit Switch :			
Brake :			
Cable :			
Control Transformer :			
Lighting fixture :			
Junction Box :			
Terminal Block :			
Control Panel :			

- All unfilled data shall be filled by the Contractor. Completely filled in Specification Sheet duly stamped & signed by the Contractor shall be submitted after award of order.

	ELECTRICAL & INSTRUMENTATION SUPPLY CUM ERECTION WORKS TECHNICAL SPECIFICATION ELECTRICAL WORKS (SUPPLY & ERECTION)	PC183/E/8003/SecVI-2.0	0	
		Document No.	Rev	
		Sheet 68 of 109		



**TECHNICAL PARTICULARS
ELECTRICAL EQUIPMENT FOR CRANES & HOISTS**

PROJECT: Coal Based Fertilizer Plant		PLANT: Electrical & Instrumentation Package	
ISSUED FOR : PROPOSAL <input type="checkbox"/>		ENQUIRY <input checked="" type="checkbox"/>	ORDER <input type="checkbox"/>
			FINAL <input type="checkbox"/>
POWER CONTROL PANEL			
GENERAL	Make & Maker's Type		
	Ref. Standard		
	Service		
	Degree Of Protection		
	Matl. Of Construction & Thickness		
	Gasket Material		
	External Hardwares		
	Clearance Available on all sides		
BUS BAR	Material Of Construction		
	Size & Rating		
	Minimum Clearances / Creepage Distance		
	Insulation & Temp. Rise		
	Support Details		
SWITCHES	Make & Maker's Type		
	Ref. Standard		
	Duty Category		
	Rated Voltage & Current		
	Making / Breaking Speed		
	Making / Breaking Capacity		
FUSES	Make & Maker's Type		
	Ref. Standard		
	Duty Category		
	Rated Voltage		
	Rated Current		
	Prospective Current		
	Fuse Puller : Included		
	Distance of Gland Plate from Bottom		
CONTACTORS	Make & Maker's Type		
	Ref. Standard		
	Utilization Category		
	Rated Voltage & Thermal Current		
	Making / Breaking Capacity		
	Coil Voltage		
PUSH BUTTON	Make & Maker's Type		
	Ref. Standard		
	Rated Voltage & Current		
	No. of Aux. Contacts		NO NC
CONTROL TRANSFORMER	Make & Maker's Type		
	Ref. Standard		
	Rating		
	Class Of Insulation		
SIGNAL LAMPS	Make & Maker's Type		
	Ref. Standard		
	Rated Voltage / Wattage		
	Type Of Lamp & Lamp Holder		
LIMIT SWITCH	Make & Maker's Type		
	Ref. Standard		
	Duty Category		

	ELECTRICAL & INSTRUMENTATION SUPPLY CUM ERECTION WORKS TECHNICAL SPECIFICATION ELECTRICAL WORKS (SUPPLY & ERECTION)	PC183/E/8003/SecVI-2.0	0	
		Document No.	Rev	
		Sheet 69 of 109		

MOTORS						
Description						
Code No.						
Make						
Maker's Type						
Rating						
Rated Output						
Synchronous Speed						
Duty						
Rotot Type						
Starting Method						
Max I Start / I Rated						
Min. V Start at Terms						
Min. M Start at VR						
EXECUTION	Degree of Protection		IP	IP	IP	IP
	Addl. Degree of Protection					
	Insulation					
	Cooling Method		IC	IC	IC	IC
	Stator Connection					
ELECTRICAL DATA	No. of Starts / Stop per Hour					
	Torque-Starting / Pull Up / Pull Out					
	Safe Stall Time at $V_R / 1.1 V_R$					
	Stator Time Constant					
	Max. Temp. Rise					
	Current at FL / 0.85 FL					
	Push Pull with Stand Capacity					
	Max. V Deep for 1 Sec. / 10 Sec.					
	Space Heater Rating					
ACCESSORIES	Lifting Eye Bolt					
	Earthing Terminals	On Body				
		In T.B.				
	Name Plate					
Addl. Name Plate						
CABLING DATA	Power Cable					
	Heater Cable					
	Cable Gland Type					
	Cable Gland Material					
MECHANICAL DATA	Frame Size / Weight					
	Ref. Dimensional Drg.					
	Material of Insulation					
	Size of Wdg. Wire					
	Type & Material of Fan					
	Lubrication Specification					
	Interval of Lubrication					
	Bearing Type with No. DE / NDE					



NOTE: Completely filled in Technical Particulars Sheet in line with NIT/Contract, shall be submitted after award of order for Owner/Consultant approval, before commencement of manufacturing.

	ELECTRICAL & INSTRUMENTATION SUPPLY CUM ERECTION WORKS TECHNICAL SPECIFICATION ELECTRICAL WORKS (SUPPLY & ERECTION)	PC183/E/8003/SecVI-2.0	0	
		Document No.	Rev	
		Sheet 70 of 109		

SPECIFICATION SHEET HT CABLES

PROJECT: Coal Based Fertilizer Plant		PLANT: Electrical & Instrumentation Package	
ISSUED FOR : PROPOSAL <input type="checkbox"/>		ENQUIRY <input checked="" type="checkbox"/>	ORDER <input type="checkbox"/> FINAL <input type="checkbox"/>
GENERAL		AMBIENT CONDITION	
Encl. Docs. :		Temp. Max./Min./Design Ref. 46 / 1 / 50°C	
Vendor :		Relative Humidity: 100 %	Alt. above Sea Level < 1000M
Vendor Ref. No. :		Atmospheric Pollution Dusts : Coal Dust & Urea Dust	
		Vapour : Ammonia & Highly Corrosive	
TESTS TO BE WITNESSED: Routine <input checked="" type="checkbox"/> Type <input type="checkbox"/> Acceptance <input checked="" type="checkbox"/> Others <input type="checkbox"/>			
Type Tests Certificate of Similar Cable : Required <input checked="" type="checkbox"/> Not required <input type="checkbox"/>			
BASIC DATA			
Item No.	1	2	
Ref. Stds.	IS:7098 (PART-2)	IS:7098 (PART-2)	
Voltage Grade	11 kV / 3.3 kV POWER CABLE	11 kV / 3.3 kV EARTHING CABLE	
System Earthing	UE	E	
Type of Cable	POWER	EARTHING	
CONDUCTOR	ALUMINIUM/ COPPER	ALUMINIUM	
	STRANDED	STRANDED	
Insulation Type	XLPE EXTRUDED	XLPE EXTRUDED	
Inner Sheath Type	EXTRUDED PVC (ST2)	--	
CONDUCTOR SCREEN	Required	--	
	Not Required	--	
Material of Conductor Screen	AS PER IS		
ARMOURING	Required	YES	
	Material	GALVANISED STEEL STRIP / WIRE	
	No. of Layer		
Outer Sheath Type	EXTRUDED FRLS PVC TYPE-ST2	EXTRUDED FRLS PVC TYPE-ST2	
Special Requirements	INSULATION SCREEN REQUIRED	--	
Drum Material	STEEL	WOOD	



- 1) All unfilled data shall be filled by the Contractor. Completely filled in Specification Sheet duly stamped & signed by the Contractor shall be submitted after award of order.

	ELECTRICAL & INSTRUMENTATION SUPPLY CUM ERECTION WORKS TECHNICAL SPECIFICATION ELECTRICAL WORKS (SUPPLY & ERECTION)	PC183/E/8003/SecVI-2.0	0	
		Document No.	Rev	
		Sheet 71 of 109		

**SPECIFICATION SHEET
LT POWER & CONTROL CABLES**

PROJECT: Coal Based Fertilizer Plant		PLANT: Electrical & Instrumentation Package	
ISSUED FOR : PROPOSAL <input type="checkbox"/>		ENQUIRY <input checked="" type="checkbox"/>	ORDER <input type="checkbox"/> FINAL <input type="checkbox"/>
GENERAL		AMBIENT CONDITION	
Encl. Docs. :		Temp. Max./Min./Design Ref.: 46 / 1 / 50°C	
Vendor :		Relative Humidity: 100 %	Alt. above Sea Level < 1000M
Vendor Ref. No. :		Atmospheric Pollution	Dusts : Coal Dust & Urea Dust
			Vapour : Ammonia & Highly Corrosive
TESTS TO BE WITNESSED:		Routine <input checked="" type="checkbox"/>	Type <input type="checkbox"/> Acceptance <input checked="" type="checkbox"/> Others <input type="checkbox"/>
Type Tests Certificate of Similar Cable :		Required <input checked="" type="checkbox"/>	Not required <input type="checkbox"/>
BASIC DATA			
Item No.			
Ref. Stds.	IS:7098 (PART-1)	IS:7098 (PART-1)	IS:7098 (PART-1)
Voltage Grade	1.1 KV POWER CABLE	1.1 KV CONTROL CABLE	1.1 KV EARTHING CABLE
System Earthing	NEUTRAL SOLIDLY EARTHED	NEUTRAL SOLIDLY EARTHED	NEUTRAL SOLIDLY EARTHED
Type of Cable	POWER	CONTROL	EARTHING
CONDUCTOR	ALUMINIUM/ COPPER	ALUMINIUM / COPPER	COPPER
	STRANDED	STRANDED	STRANDED
Insulation Type	XLPE EXTRUDED	XLPE EXTRUDED	XLPE EXTRUDED
Inner Sheath Type	EXTRUDED PVC (ST2)	EXTRUDED PVC (ST2)	--
CONDUCTOR SCREEN	Required	--	--
	Not Required	--	--
Material of Conductor Screen	--	--	--
ARMOURING	Required	YES	YES
	Material	GALVANISED STEEL STRIP / WIRE	GALVANISED STEEL WIRE
	No. of Layer	SINGLE	SINGLE
Outer Sheath Type	EXTRUDED FRLS PVC TYPE-ST2	EXTRUDED FRLS PVC TYPE-ST2	EXTRUDED FRLS PVC TYPE-ST2
Special Requirements	--	--	--
Drum Material	WOOD	WOOD	WOOD



- All unfilled data shall be filled by the Contractor. Completely filled in Specification Sheet duly stamped & signed by the Contractor shall be submitted after award of order.

	ELECTRICAL & INSTRUMENTATION SUPPLY CUM ERECTION WORKS TECHNICAL SPECIFICATION ELECTRICAL WORKS (SUPPLY & ERECTION)	PC183/E/8003/SecVI-2.0	0	
		Document No.	Rev	
		Sheet 72 of 109		

TECHNICAL PARTICULARS CABLES

PROJECT: Coal Based Fertilizer Plant		PLANT: Electrical & Instrumentation Package	
ISSUED FOR : PROPOSAL <input type="checkbox"/>		ENQUIRY <input checked="" type="checkbox"/>	ORDER <input type="checkbox"/> FINAL <input type="checkbox"/>
GENERAL			
Make			
Ref. Standard			
Item No.			
Voltage Grade			
Suitable For Earthed / Unearthed System			
No. of Cores & Size of Conductor			
CONSTRUCTIONAL DETAILS			
CONDUCTOR	Material		
	Construction		
	No. & Dia of wires per Core		
CONDUCTOR SCREEN	Material		
	Thickness		
INSULATION	Material		
	Thickness		
	Core Identification Method		
INSULATION SCREEN	Material		
	Thickness		
INNER SHEATH	Type & Material		
	Thickness		
ARMOURING	Type & Material		
	Dia of Wire / Strip Thickness		
OUTER SHEATH	Material		
	Thickness		
ELECTRICAL DATA			
CONTINUOUS CURRENT RATING WHEN LAID IN	Ground At 30 ^o C		
	Air At 40 ^o C		
Short Circuit Current For 1 sec.			
CONDUCTOR TEMP.	Continuous		
	Short Time		
Resistance At Operating Temp. (Ohm / KM)			
Reactance At 50 C/S (Ohm/KM)			
Capacitance (F/Km)			
Insulation Resistance			
Polarisation Index			
DERATING FACTOR CHART ATTACHED FOR	Temperature		
	Grouping		
	Exposure to Sun		
MECHANICAL DATA			
DIAMETER WITH TOLERANCE	Over Inner Sheath		
	Over Armour		
	Overall		
Weight Of Cables Per KM			
Minimum Bending Radius			
Maximum Pulling Tension			
Standard Drum Length			
Tolerance On Drum Length			



NOTE: Completely filled in Technical Particulars Sheet for each type & size of cable in line with NIT/Contract, shall be submitted after award of order for Owner/Consultant approval, before commencement of manufacturing.

	ELECTRICAL & INSTRUMENTATION SUPPLY CUM ERECTION WORKS TECHNICAL SPECIFICATION ELECTRICAL WORKS (SUPPLY & ERECTION)	PC183/E/8003/SecVI-2.0	0	
		Document No.	Rev	
		Sheet 73 of 109		

TECHNICAL PARTICULARS LIGHTING FIXTURES AND ACCESSORIES

PROJECT: Coal Based Fertilizer Plant		PLANT: Electrical & Instrumentation Package	
ISSUED FOR : PROPOSAL <input type="checkbox"/>		ENQUIRY <input checked="" type="checkbox"/>	
		ORDER <input type="checkbox"/>	
		FINAL <input type="checkbox"/>	
FIXTURE			
Item No.			
Make			
Type			
Ref. Standard			
Suitable For	Type Of Lamp		
	Wattage Of Lamp		
Suitable For Outdoor Use			
Control Gear Integral / Separate			
Degree of Protection	Fixture		
	Control Gear Box		
Additional Degree of Protection	Fixture		
	Control Gear Box		
Material & Finish	Housing		
	Reflector		
	Control Gear Box		
	Diffuser / Louvre		
	Gasket		
	Ext. Hardwares <8mm/>8mm		
Pre - treatment	Housing		
	Reflector		
	Control Gear Box		
Thickness of material	Housing		
	Reflector		
	Control Gear Box		
Minimum Mounting Height			
Spacing / Height Ratio			
Light Output Ratio - Up / Down			
Surface Temp. Rise Range (For FLP Fxt)			
Cable Gland	Type		
	Material		
	Qty. Fittings / Control Gear Box		
Threaded Plug Provided	Fixture		
	Control Gear Box		
Looping Facility Available	Fixture		
	Control Gear Box		
Mounting Bracket Provided			
Weight Of Fixture			
Catalogue attached indicating	General Arrangement		
	Light Distribution		
	Utilisation Factors		
	I FL / I Starting		
ACCESSORIES			
Ballast	Make & Maker's Type		
	Ref. Standard		
	Rating		
	Winding Wire Material		
	Insulation Class		
	Power Loss in Ballast		
Capacitor	Make & Maker's Type		
	Ref. Standard		
	Rating		
Lamp Holder	Make & Maker's Type		
	Ref. Standard		
	Rating		
Starters	Make & Maker's Type		
	Ref. Standard		



NOTE: Completely filled in Technical Particulars Sheet in line with NIT/Contract, shall be submitted after award of order for Owner/Consultant approval, before commencement of manufacturing.

	ELECTRICAL & INSTRUMENTATION SUPPLY CUM ERECTION WORKS TECHNICAL SPECIFICATION ELECTRICAL WORKS (SUPPLY & ERECTION)	PC183/E/8003/SecVI-2.0	0	
		Document No.	Rev	
		Sheet 74 of 109		

SPECIFICATION SHEET INTERLOCKING SWITCH SOCKET & PLUG

PROJECT: Coal Based Fertilizer Plant		PLANT: Ash Pond and Allied Services	
ISSUED FOR : PROPOSAL <input type="checkbox"/> ENQUIRY <input checked="" type="checkbox"/>		ORDER <input type="checkbox"/> FINAL <input type="checkbox"/>	
GENERAL		AMBIENT CONDITION	
Ref. Stds. :	IS / IEC	Temp.- Max / Min / Design ref.: 46 / 1 / 50°C	
Encl. Docs. :		Max Relative Humidity ≤100% Alt. above sea : <1000 M	
Vendor :		Atmospheric Pollution	Dusts : Coal Dust & Urea Dust Vapour : Ammonia & Highly Corrosive
Vendor Ref. No. :		Area	Safe <input type="checkbox"/> Hazardous - <input type="checkbox"/>
Sample Req. :		Hazardous Area Class	Zone : Encl. Gr. :
			Temp. Class :
		Location :	Indoor <input checked="" type="checkbox"/> Outdoor <input checked="" type="checkbox"/>
TESTS TO BE WITNESSED : Routine <input checked="" type="checkbox"/>		Type	Others
BASIC DATA			
Item No.			
Quantity			
Rated Voltage & Frequency		415V ± 10 %, 50Hz ± 3%	240V+ 10%, 50 Hz± 5%,
Rated Current		63 Amp	16 Amp
No. of Phases & Pins		3 Ph, 5 Pin	1 Ph, 3 Pin
Degree of Protection		IPW55	IP65
Addl. Degree of Protection			
Cable Size	Supply		
	Plug		
Period for which Spares required			
MAKE OF COMPONENTS			
SWITCH :			
FUSE:			
SOCKETS :			
PLUG :			
CABLE GLANDS :			
TERMINAL BLOCKS :			
TECHNICAL PARTICULARS			
General	Make & Maker's Type		
	Material & Thickness of Enclosure		
	Gasketing Materials		
	Material of Ext. Hardwares < 8mm / > 8mm		
	Cable glands Type & Material		
	Painting	Pre treatment	
		Shade	
	Dimensional Drawing Reference No.		
Weight of Switch Socket / Plug			
Switch	Make & Maker's Type		
	Reference Standards		
	Rated Current		
	Utilisation Category		
Fuse	Make & Maker's Type		
	Reference Standards		
	Rated Current		
Socket	Make & Maker's Type		
	Reference Standards		
	Rated Current		
Plug	Make & Maker's Type		
	Reference Standards		
	Rated Current		



NOTE: Completely filled in Technical Particulars Sheet in line with NIT/Contract, shall be submitted after award of order for Owner/Consultant approval, before commencement of manufacturing.

	ELECTRICAL & INSTRUMENTATION SUPPLY CUM ERECTION WORKS TECHNICAL SPECIFICATION ELECTRICAL WORKS (SUPPLY & ERECTION)	PC183/E/8003/SecVI-2.0	0	
		Document No.	Rev	
		Sheet 75 of 109		

**SPECIFICATION SHEET
LIGHTING TRANSFORMER**

PROJECT: Coal Based Fertilizer Plant		PLANT: Urea Handling & Bagging Package	
ISSUED FOR : PROPOSAL <input type="checkbox"/>		ENQUIRY <input checked="" type="checkbox"/>	
		ORDER <input type="checkbox"/>	
		FINAL <input type="checkbox"/>	
GENERAL			
Item No. :	As Required	Ref. Stds. :	IS/IEC
Quantity :	As Required	Encl. Docs. :	
Description :	Auxiliary Service Transformer	Make :	As per enclosed vendor list
Code No. :		Maker's Type :	
TESTS :	Routine <input checked="" type="checkbox"/>	Heat Run <input checked="" type="checkbox"/>	Others : <input checked="" type="checkbox"/>
			Impulse <input checked="" type="checkbox"/>
SERVICE CONDITIONS			
SYSTEM DETAILS (PRI. / SEC.)		AMBIENT CONDITIONS	
Nom. Voltage with \pm % :	415 \pm 10 % V	Temp.- Max./Min./Design Ref. :	46 / 1 / 50°C
Highest System Voltage :	457 KV	Rel. Humidity: 100% Max.	Alt. above Sea < 1000M
Number of phases :	3 Ph + N	Atmospheric	Dusts : Coal Dust & Urea Dust
Rated Frequency with + :	50 \pm 5 % Hz	Pollution	Vapour : Ammonia & Highly Corrosive
Combined V & F Variation :	\pm 10 %	Location	Indoor : <input checked="" type="checkbox"/>
Fault MVA :			Outdoor : <input type="checkbox"/>
Earthing Mode :	Solidly Earthing		
BASIC DATA			
RATING		TERMINAL CONNECTIONS	
Rated Capacity :		PRI.	Cable / Cond.
No Load Voltage Ratio : 415/433 V			Type :
Highest Voltage for Eqpt. 457 V		SEC.	Cable / Cond.
Connection	Primary : Delta		Type :
	Secondary : Star		No. & Size :
% Impedance :		Earth Conductor	
Cooling System :			Body :
			Neutral :
PAINTING		SPARE PARTS	
Type :	Epoxy based	Reqd. :	<input checked="" type="checkbox"/>
Shade :			For a period of 2 Years operation and maintenance
ADDITIONAL FITTINGS			
Refer Technical Specification			



- 1) All unfilled data shall be filled by the Contractor. Completely filled in Specification Sheet duly stamped & signed by the Contractor shall be submitted after award of order.

	ELECTRICAL & INSTRUMENTATION SUPPLY CUM ERECTION WORKS TECHNICAL SPECIFICATION ELECTRICAL WORKS (SUPPLY & ERECTION)	PC183/E/8003/SecVI-2.0	0	
		Document No.	Rev	
		Sheet 76 of 109		

**SPECIFICATION SHEET
415 V BUSDUCT**

PROJECT: Coal Based Fertilizer Plant		PLANT: Electrical & Instrumentation Package	
ISSUED FOR : PROPOSAL <input type="checkbox"/>		ENQUIRY <input checked="" type="checkbox"/>	ORDER <input type="checkbox"/>
		FINAL <input type="checkbox"/>	
GENERAL			
Ref. Stds. : IS/IEC			
Encl. Docs. :			
Make : As per enclosed Vendor list			
Maker's Type :			
AMBIENT CONDITION			
Temp.- Max./Min./Design Ref. : 46 / 1 / 50°C			
Relative Humidity 100% Max.		Alt. above sea : < 1000 M	
Atmospheric Pollution		Dusts : Coal Dust & Urea Dust	
		Vapour : Ammonia & Highly Corrosive	
Location		Indoor <input type="checkbox"/>	Outdoor <input checked="" type="checkbox"/>
TESTS :		Routine <input checked="" type="checkbox"/>	Temp. Rise <input checked="" type="checkbox"/>
		Others <input checked="" type="checkbox"/>	
BASIC DATA			
TAG NO. & QTY.	Item No. :		
	Description :	Bus Duct	
	Code No.		
SYSTEM DETAILS	Rated Voltage with Variation :	415 V (± 10%)	
	Rated Frequency with Variation :	50 Hz ± 5%	
	Highest System Voltage :	/ 457 V	
	Combined V & F Variation :	± 10 %	
	No. of Phases & Wires :	3 Ph, 3 W & 3 Ph, 4 W	
	Fault Level : ----/----/----	36 (MVA)	
	Earthing Mode :	Solidly Grounded	
CURRENT RATING	Continuous :		
	Short Time Current / Time :		
PAINTING	Type :	Epoxy based	
	Shade :	Shade 631 of IS: 5	
Spares Parts Reqd. for a Period of :		2 Years operation and maintenance	
Fire rating			
Seismic Compliance			



- 1) All unfilled data shall be filled by the Contractor. Completely filled in Specification Sheet duly stamped & signed by the Contractor shall be submitted after award of order.

	ELECTRICAL & INSTRUMENTATION SUPPLY CUM ERECTION WORKS TECHNICAL SPECIFICATION ELECTRICAL WORKS (SUPPLY & ERECTION)	PC183/E/8003/SecVI-2.0	0	
		Document No.	Rev	
		Sheet 77 of 109		

**TECHNICAL PARTICULARS
415 V BUSDUCT**

PROJECT: Coal Based Fertilizer Plant		PLANT: Electrical & Instrumentation Package	
ISSUED FOR : PROPOSAL <input type="checkbox"/> ENQUIRY <input checked="" type="checkbox"/> ORDER <input type="checkbox"/> FINAL <input type="checkbox"/>			
GENERAL			
Item No. :			
Description :			
Code No.			
Ref. Stds. :			
Make :			
Maker's Type :			
TECHNICAL DATA			
BUS - BARS	Material & Grade :		
	Size	Phase	
		Neutral	
ENCLOSURES	Material :		
	Thickness :		
	Cross - Sectional area :		
MIN. CLEARANCE BETWEEN	Live Parts :		
	Live Parts & Accidentally Dangerous Parts :		
Min. Creepage Distance :			
TEMP. RISE OVER AMBIENT	Bus Bar :		
	Enclosure :		
BUS - BAR SUPPORTS	Material & Grade :		
	Interval :		
Resistance of Bus - Bar per M :			
Reactance of Bus - Bar per M :			
EARTHING	No. of Conductors :		
	Material & Size :		
No. of Inspection Windows :			
No. of Ventilating Louvers :			
No. of Expansion Joints :			
Phase Cross - Over Provided :			
FIRE RESISTANCE BARRIERS PROVIDED AT	Transformer End :		
	Switch Gear End :		
Drain Plug Provided :			

- Completely filled in Technical Particulars Sheet shall be furnished after award of order for owner/consultant approval before commencement of manufacturing in line with NIT/PO.

	ELECTRICAL & INSTRUMENTATION SUPPLY CUM ERECTION WORKS TECHNICAL SPECIFICATION ELECTRICAL WORKS (SUPPLY & ERECTION)	PC183/E/8003/SecVI-2.0	0	
		Document No.	Rev	
		Sheet 78 of 109		



**SPECIFICATION SHEET
11 kV ICOG Breaker Panel**

PROJECT: Coal Based Fertilizer Plant		PLANT: Electrical & Instrumentation Package		
ISSUED FOR : PROPOSAL <input type="checkbox"/>		ENQUIRY <input checked="" type="checkbox"/>	ORDER <input type="checkbox"/> FINAL <input type="checkbox"/>	
GENERAL		AMBIENT CONDITION		
Ref. Stds. : IS <input checked="" type="checkbox"/>	IEC <input checked="" type="checkbox"/>	Temp. Max./Min./Design Ref. : 46 / 1 / 50°C		
Encl. Docs. :		Relative Humidity: 100%	Alt. above sea <1000 M	
Make :		Dusts : Coal Dust		
Maker's Ref. No. :		Vapour : Highly Corrosive		
		ATMOSPHERIC POLLUTION		
		Indoor <input checked="" type="checkbox"/>	Outdoor <input type="checkbox"/>	
		Gr. Floor <input type="checkbox"/>	1 st floor <input type="checkbox"/>	
		LOCATION		
ADDL. SCOPE		Incoming Bus Duct <input type="checkbox"/>	Tie Bus Duct <input type="checkbox"/>	
		Erection & Comm. <input checked="" type="checkbox"/>	Supervision of Erection & Comm. <input type="checkbox"/>	
TESTS:		Routine <input checked="" type="checkbox"/>	Type <input type="checkbox"/> Others <input type="checkbox"/>	
BASIC DATA				
	Description	11kV ICOG Panel		
REFERENCE DRAWINGS	Single Line Diagram			
	Feeder Details			
	P.T. Bus Arrangement	--		
SYSTEM DETAILS	Rated Voltage with variation	11 kV ± 10%		
	Rated Frequency with variation	50Hz ± 5%		
	Highest System Voltage	12 kV		
	Combined V & F Variation	± 10%		
	No. of Phases & Wires	3 Phase, 3 Wire		
	Insulation Level	70 kVp/ 28kV BIL		
	Fault Level	750 MVA for 3 sec.		
Earthing Mode	Non effectively earthed through resistor			
BUS BARS	Rating	Continuous	1250A	
		Short Time for 3 sec.	40KA for 3 sec.	
	Type of Insulation	Insulating heat shrinkable Sleeved		
CIRCUIT BREAKER	Type	Vacuum Circuit Breaker		
	Breaking Capacity	Symmetrical	40 KA for 3 sec.	
		% DC Component	20% (Min.)	
	Making Capacity (peak)	2.55 times Breaking Capacity		
	Earthing Switch	Integral type		
CONTROL SUPPLY	Closing & Indication	110V DC **		
	Tripping	110V DC **		
	Alarm / Signal	110V DC **		
	Space Heater	240V AC		
MISC. DATA	Cable Entry	Top / Bottom	Bottom	
	Dummy Panel Reqd.	Yes / No	As required	
	Width of Dummy Panel	--		
	No. of Dummy Panel	--		
	PAINTING	Type	Epoxy Based	
		Shade	631 of IS: 5	
	Spares Parts Reqd. for a Period of	2 Years		

NOTE:



- ** 110V DC Power required for closing, tripping and indication of circuit breaker feeder shall be provided by the vendor through in-built power pack in the feeders having battery back-up of 30 minutes.

- For metering, protection etc. refer SLD.
- All unfilled data shall be filled by the Contractor. Completely filled in Specification Sheet duly stamped & signed by the Contractor shall be submitted after award of order.



	ELECTRICAL & INSTRUMENTATION SUPPLY CUM ERECTION WORKS TECHNICAL SPECIFICATION ELECTRICAL WORKS (SUPPLY & ERECTION)	PC183/E/8003/SecVI-2.0	0	
		Document No.	Rev	
		Sheet 79 of 109		

**TECHNICAL PARTICULARS
11 KV ICOG Panels**



PROJECT: Coal Based Fertilizer Plant		PLANT: Electrical & Instrumentation Package	
ISSUED FOR : PROPOSAL <input type="checkbox"/>		ENQUIRY <input checked="" type="checkbox"/>	ORDER <input type="checkbox"/> FINAL <input type="checkbox"/>
GENERAL			
Make / Maker's Type :			
Ref. Standards			
Rated Operational Voltage with \pm %			
Rated Insulation Voltage			
Rated Voltage of Aux. Circuits with \pm %			
Rated Current			
Short Time Rating			
Degree of Protection of Enclosure			
Service Conditions : Indoor / Outdoor			
DRAWOUT FACILITIES	Circuit Breaker's		
	P.T.'s		
	Protective Relays		
	Meters		
SHEET STEEL TYPE & THICKNESS	Base Channel		
	Others		
Material of Gaskets			
Material of External Hardware			
Operating Height : Max. / Min.			
Space Heater Rating of each Panel			
PAINTING	Method of Pre-treatment		
	Thickness of Paint		
	Type & Shade		
Final Temperature			
PROVISIONS / FACILITIES	Safety Shutters		
	Interlocks		
	Earthing Facility		
	Base Channels with Fdn. Bolts		
	Gland Plate with Glands		
	Limit of Maximum Nos. of Cables Termination Possible		
Dimensions : L X B X H / Dim. Drg. Ref. No.			
Shipping Dimensions of Largest Package			
Weight : Static / Dynamic			
Heat Dissipation			
BUS - BARS			
Material			
SIZE	HBB		
	VBB		
	Ground		
	Supporting Calculation Attached		
MINIMUM CLEARANCE	Between Phases		
	Between Phase & Earth		
Minimum Creepage Distance			
CURRENT RATING	Continuous		
	Short Time for 3 secs.		
Max. current density for bus-bars			
Temp. Rise for : Cont. Load / Short Ckt. Current			
SUPPORT	Material		
	Voltage Class		
	BIL		
	Arrangement : Separate/Common		
Power Frequency test Voltage for 1 Min. Duration			
Material of Bus-bar Insulation			
Material of Inter Panel / Compartment Barrier			
Shrouding Material for Joints			
Bus Bar Phase Identification Mark			

	ELECTRICAL & INSTRUMENTATION SUPPLY CUM ERECTION WORKS TECHNICAL SPECIFICATION ELECTRICAL WORKS (SUPPLY & ERECTION)	PC183/E/8003/SecVI-2.0	0	
		Document No.	Rev	
		Sheet 80 of 109		

No. & Type of Bolts per Joint		
CIRCUIT BREAKERS		
Make / Maker's Type		
Ref. Standards		
Type of Circuit Breaker		
Principle / Collaborator		
Rated Operating Sequence		
Rated Voltage		
Rated Frequency		
No. of Poles		
CURRENT RATING	Continuous in IPH6 Enclosure	
	3 second RMS	
	Momentary (Peak)	
BREAKING CURRENT	Symmetrical KA	
	Asymmetrical KA	
	% D.C. Component	
Making Current (Peak)		
Derating Factor, if any for Site Condition		
LIMITATION OF CURRENT RATING FOR	Motor Duty	
	Capacitor Duty	
	Transformer Switching	
	Cable Charging	
Restriking Voltage (Peak)		
INSULATION LEVEL	1 Min. PF withstand Voltage	
	Impulse withstand Voltage	
No. of Breaks per Pole		
TYPE AND MATERIAL OF	Fixed Contact	
	Moving Contact	
	Arcing Contact	
Type of Closing Mechanism		
Type of Tripping Mechanism		
ARC CONTROL DEVICE	Type	
	Material of Arc Chamber	
Details of Anti – Pumping Feature		
Details of Trip Free Feature		
Total Closing Time		
Total Interrupting Time at 10%, 50%, 100% of rated		
Interrupting Capacity		
SPRING CHARGING MOTOR	Rating	
	Voltage	
	Insulation	
	Duty	
	Type	
Spring Charging Time		
VOLTAGE / CURRENT REQD. FOR	Closing	
	Tripping	
	A.C. Supply	
AUXILIARY CONTACTS	No. of Spare Contacts NO / NC	
	Contact Rating Ac / Dc	
	Convertible Type	
INSULATING OIL	Ref. Standard	
	Volume of Oil Required	
Mounting Arrangement		
Temp. Rise of Different Parts		
DETAILS FOR SF₆	SF ₆ Gas Pressure	
	Wt. Of SF ₆ Gas per Breaker	



	ELECTRICAL & INSTRUMENTATION SUPPLY CUM ERECTION WORKS TECHNICAL SPECIFICATION ELECTRICAL WORKS (SUPPLY & ERECTION)	PC183/E/8003/SecVI-2.0	0	
		Document No.	Rev	
		Sheet 81 of 109		

DETAILS FOR SF₆	Gas Leakage Detector Provided	
	Gas Density Monitor Provided	
DETAILS FOR VCB	Pressure inside the Interrupter	
	Contact Wear Indication Provided	
	Facility for Checking Loss of Vacuum Provided	
RECOMMENDED TIME INTERVAL FOR	Inspection of Drives	
	Inspection of Contacts	
	Quenching Devices	
	Replacement of Oil	
Dimensions : L X B X H / Dim. Drg. Ref. No.		
Type Testing Authority & Test Report Ref. No.		
Net Weight of Breaker		
CURRENT TRANSFORMERS		
Make / Maker's Type		
Ref. Standard		
Type of Primary Winding		
No. of Cores		
Ratio		
Rated Burden		
Accuracy Class		
ALF / ISF		
Thermal Limit		
Dynamic Limit		
Insulation Class / Material		
Basic Insulation Level		
Ref. Magnetisation Curve No.		
POTENTIAL TRANSFORMERS		
Make / Maker's Type		
Ref. Standard		
Winding Connection : Pri. / Sec.		
Ratio		
Rated Burden		
Accuracy Class		
Insulation Class / Material		
Basic Insulation Level		
Weight		
Dimension		
Rated Voltage Factor		
SURGE DIVERTER		
Type & Maker's Type		
Rated Voltage KV		
Nominal Discharge Current (8/20 μ sec. wave)		
Residual Voltage at Rated Discharge Current		
Power Frequency Spark Over Voltage		
1.2/50 μ sec. Spark Over Voltage		
RELAYS		
Application		
Make / Maker's Type :		
Ref. Standards		
Operating Principle		
Rated Voltage / Current		
Rated Burden		
Setting Range		
Type of Mounting		
Reset : Hand or Self		
Flag Indication Type		
Ref. Characteristic Curve Type		
Ref. Descriptive catalogue		
INSTRUMENTS AND METERS		
Application		



	ELECTRICAL & INSTRUMENTATION SUPPLY CUM ERECTION WORKS TECHNICAL SPECIFICATION ELECTRICAL WORKS (SUPPLY & ERECTION)	PC183/E/8003/SecVI-2.0	0	
		Document No.	Rev	
		Sheet 82 of 109		

Make / Maker's Type :	
Ref. Standards	
Operating Principle	
Rated Burden	
Scale Range	
Accuracy	
Size	
Type of Mounting	
CONTROL SWITCHES	
Application	
Make / Maker's Type :	
Ref. Standards	
Contact Rating	
Utilisation Category	
PUSH BUTTON	
Make / Maker's Type :	
Ref. Standards	
Contact Rating	
Utilisation Category	
SIGNAL LAMPS	
Make / Maker's Type :	
Ref. Standards	
Rated Voltage / Wattage	
Type of Lamp Holder	
Type of Globe	
Accessibility from Front	
MOULDED CASE CIRCUIT BREAKERS	
Make / Maker's Type	
Ref. Standard	
Current Rating	
Breaking Capacity	
Setting Range of Thermal Release	
Setting Range of Magnetic Release	
MINIATURE CIRCUIT BREAKER	
Make / Maker's Type :	
Ref. Standards	
Rated Current	
Breaking Capacity	
CABLE GLANDS	
Material	
Type	
TERMINAL BLOCKS	
Make	
Type	
Current Rating	

NOTE: Completely filled in Technical Particulars Sheet in line with NIT/PO, shall be submitted after award of order for Owner/Consultant approval, before commencement of manufacturing.

	ELECTRICAL & INSTRUMENTATION SUPPLY CUM ERECTION WORKS TECHNICAL SPECIFICATION ELECTRICAL WORKS (SUPPLY & ERECTION)	PC183/E/8003/SecVI-2.0	0	
		Document No.	Rev	
		Sheet 83 of 109		

ELECTRICAL ERECTION, TESTING & COMMISSIONING SPECIFICATION



	ELECTRICAL & INSTRUMENTATION SUPPLY CUM ERECTION WORKS TECHNICAL SPECIFICATION ELECTRICAL WORKS (SUPPLY & ERECTION)	PC183/E/8003/SecVI-2.0	0	
		Document No.	Rev	
		Sheet 84 of 109		

1.1. SCOPE OF WORK

- 1.1.1 The scope of work shall include storage, handling, transportation, unpacking, checking, reporting of damages/defects, assembling, erection, installation, including fabrication, alignment, leveling, grouting, welding, bolting, painting (wherever specified), etc., testing and commissioning of various electrical equipment either supplied by the contractor or supplied by owner as free issue items, earthing system, fabrication & installation of steel structural etc. as per drawings & documents, specifications, standards & codes, prevalent rules & regulations and best engineering practices.
- 1.1.2 The scope shall also include obtaining approval from statutory authorities, as required.

1.2 SCOPE OF ERECTION

- 1.2.1 The scope comprises of erection/installation, testing and commissioning of electrical equipment/items as indicated in SOR.
- 1.2.2 Laying of cables in excavated/ RCC trenches and on cable trays as required.
- 1.2.3 Installation of Cable Trays on MS structure along with supply of Tray Clamps, jointing/Reducing Plates and other hardware. Laying of cables in excavated/RCC trenches and on cable trays as required along with cables clamping including supply of clamping material.
- 1.2.4 Supply of double compression/FLP rolled aluminium cable glands and crimping type tinned copper cable lugs.
- 1.2.5 Excavation and back filling of cable trenches.
- 1.2.6 Termination of power, control and lighting cables.
- 1.2.7 Fabrication with supply of MS material, consumable and hardware of frames, supports, cable racks etc. as required.
- 1.2.8 Supply, laying & connection of the complete earthing system including supply of GI earth electrode as per sketch given, GI earthing strips, Earth Bus-Bars, flexible earthing conductors etc.
- 1.2.9 Minor civil works such as digging of earth and refilling for directly buried cables, earth strips, cable protection pipes, earth electrode pits, ground mounted lighting pole foundations, civil works such as making earth pit inspection chambers with covers, grouting of base plate, channels, supports and foundation bolts, including chipping of concrete or in brick work for earth strips, pipes and other minor chipping for foundation preparation, if required, cutting holes in walls for racks, risers, light fitting brackets, sealing of cable entries and making good the same after installation of the equipment and leveling and other minor similar jobs shall be in contractor's scope.
- 1.2.10 Hydra/cranes/forklift etc. for shifting/lifting of material shall be in contractor's scope.
- 1.2.11 Straight - through jointing of cables (wherever required)
- 1.2.12 Making/providing canopies/rain hoods.
- 1.2.13 All hardware required for successful commissioning, whether specifically mentioned or not in the specification shall be supplied by the Contractor.
- 1.2.14 Concrete foundations for pedestals, lighting poles, grouting of equipments etc., including supply of grouting materials.
- 1.2.15 Removal of materials/scrap to the scrap yard and stores etc. as per instructions of Owner/Consultant.
- 1.2.16 Supply and installation of any other item not specifically mentioned but found necessary by the engineer-in-charge for satisfactory completion of job.

	ELECTRICAL & INSTRUMENTATION SUPPLY CUM ERECTION WORKS TECHNICAL SPECIFICATION ELECTRICAL WORKS (SUPPLY & ERECTION)	PC183/E/8003/SecVI-2.0	0	
		Document No.	Rev	
		Sheet 85 of 109		

- 1.2.17 All letter writing on switchboards, transformer, danger boards, sign etc shall be done by the contractor.
- 1.2.18 Any work not included in this tender but may be required, as decided by engineer-in-chief, such as site modification of panel wiring, mounting of additional equipment etc. for which extra payment shall be made as per the man-day-rates to be quoted for various categories of workmen.
- 1.2.19 "AS BUILT" drawings with all site modifications shall be prepared by making the changes on owner's drawings.

1.3 EXCLUSIONS

1.4 CODES AND STANDARDS

- 1.4.1 The design, manufacture, testing, installation of the equipment shall comply with the latest issue of all relevant Indian Standards and codes of practices and all applicable Statutory Acts & Regulations.
- 1.4.2 The contractor shall have acquainted with local safety standards pertaining to electrical installation, testing & commissioning
- 1.4.3 The contractor shall have valid "A" class license from the Director of Electrical Safety to the Govt. of Gujarat. The contractor shall have to submit the copy of their license. The contractor must have PF & ESI codes covering all persons hired by him for carrying out the job.
- 1.4.4 The contractor shall observe safety rules and take all necessary safety precautions to carry out the work in the plant.

1.5 GENERAL PROCEDURE FOR ERECTION



- 1.5.1 The general procedure governing "Transfer of equipment and materials to Contractor", erection and final acceptance of owner/consultant are given below:

1.5.1.1 Storage of equipment at site

- a) All equipment and materials shall be properly stored by the contractor at site in the designated storage area provided by the owner. Contractor shall arrange to draw the necessary equipment/materials in the sequence required for erection and transport the same from contractor's store to erection point.
- b) The contractor shall keep proper record of the materials supplied by him/owner.
- c) The contractor shall ensure that all the materials drawn by him are stored indoor/under shade/outdoor as per package storage instruction. However, if a package is temporarily stocked outdoor due to unavoidable reasons, this shall be ensured that the storage area is dry, hard and well-drained.
- d) Goods must not be placed directly on the floor/ground but shall be kept on blocks, 60 mm to 120 mm above the floor level such that the bottom is well ventilated.
- e) In case of outdoor storage, the contractor at his own cost shall provide waterproof PVC sheets/tarpaulin to cover all goods so as to protect them from rain etc. These sheets/tarpaulin shall be removed for inspection once in a week and if found moist or mouldy, shall be dried in direct sunlight.
- f) In addition to the above, the equipment manufacturer's storage instructions, if any, shall be strictly followed.

1.5.1.2 Contractor's inspection at site

- a) On receipt of any material (supplied by the contractor) at site, contractor shall fully unpack and inspect all equipment received for completeness, signs of damages, defect etc. in the presence of owner's representative. Any damage/short supply detected shall be recorded

	ELECTRICAL & INSTRUMENTATION SUPPLY CUM ERECTION WORKS TECHNICAL SPECIFICATION ELECTRICAL WORKS (SUPPLY & ERECTION)	PC183/E/8003/SecVI-2.0	0	
		Document No.	Rev	
		Sheet 86 of 109		

immediately. The contractor shall be required to make good/replace/repair the defective/damaged items at no extra cost to the owner.

1.5.1.3 Handling and cleaning

- a) The contractor shall be responsible for proper handling and cleaning of all materials/equipment drawn/ supplied by him until owner/consultant finally accepts the erected equipment.
- b) Equipment shall be handled with care by experienced riggers under guidance of competent supervisors and as per rigging marks given on cases. Dragging on floor shall be avoided and crane/suitable rollers shall be used for moving the equipment at any times.
- c) The contractor shall be fully responsible for the safe keeping of equipment issued to him till these are erected, tested, commissioned by him and accepted by owner/consultant.



1.5.1.4 Transportation

This involves transportation of various electrical equipments/materials from HWB stores to contractor's store/erection site and from contractor's store to erection site. When transporting the equipment, it shall be loaded on suitable trailer/ trucks as per capacity and size of equipment, and shall be properly supported on the trailers/ trucks by means of ropes/stoppers to avoid damage or tilting due to heavy jerks and vibration.

Precautions, if any, displayed on equipment shall be strictly observed. Transportation equipment without safe load certified capacity shall not be used in any case.

1.5.1.5 Erection Requirements

- a) All work shall be carried out as per drawings supplied. Placing on foundation, aligning, grouting, connecting, fixing danger notice plate / board on equipment as specified, meggering, labeling and painting shall form part of erection requirements.
- b) Fixing of supporting frames/pedestals, grouting, cutting and dressing holes in walls/ceiling and any other minor civil work necessary for installation and leveling of electrical equipment are included in electrical erection scope.
- c) The scope of erection also includes cable dressing using steel tie/aluminium clamps fabricated from Al strip 25mm (width)X3mm (thick)/clamping/minor rerouting, minor relocation of fittings, internal cleaning of equipment, overhauling and minor repairs.
- d) Fabrication of clamps from the materials specified and clamping of cables on racks, trays etc. fixing of single core cables in tri-foil formation in aluminium clamps, earthing of cable armour and lead sheath, wherever necessary (and as per the details given by Consultant) fall under erection scope of work.
- e) Marking of cables by fixing/grouting the cable marks/number tags at every 25 metres along entire route of cables are included in the scope of work. The tags shall be made of Aluminium Strips.
- f) The contractor shall without any extra cost, touch up with paint all electrical equipment which are damaged/scratched during handling, erection or repair. The paint used shall match exactly the painted surface of the equipment on which touch-up is done, and shall be epoxy based.
- g) The descriptions given above are only to give a preliminary idea about the scope of work and they do not limit the entire scope to these descriptions only. Hence all other parts of the tender document shall be read in conjunction with the referred standards, associated drawings, specification sheets and schedule of materials & services to assess actual scope of work.
- h) The contractor shall undertake erection of all equipment specified herein in accordance with good engineering practices in conformity with statutory regulations and Code of Practice and to the entire satisfaction of the purchaser/ owner.

	ELECTRICAL & INSTRUMENTATION SUPPLY CUM ERECTION WORKS TECHNICAL SPECIFICATION ELECTRICAL WORKS (SUPPLY & ERECTION)	PC183/E/8003/SecVI-2.0	0	
		Document No.	Rev	
		Sheet 87 of 109		

- i) The contractor shall arrange all the necessary erection tools, tackles, testing and measuring instruments and shall supply all erection materials as required.

1.6 SPECIFICATION FOR ELECTRICAL ERECTION

1.6.1 General

1.6.1.1 These specifications lay down the erection procedures to be followed for each type of equipment, over and above the general "Erection Requirements".

1.6.1.2 The contractor shall also follow manufacturer's instructions and any other instructions of consultant/Principal/Statutory bodies during erection.

1.6.1.3 Suggestive Erection Drawings shall be supplied to the successful bidder for Lighting, Earthing, Cable Tray Routing, etc. These drawings may be suitably modified, if required, to suit site requirement with the approval of owner/consultant.

1.6.1.4 As-Built Drawings shall be prepared by the bidder and supplied to owner/consultant.

1.6.2 Switch Boards



(HT SwitchBoard, PMCC/EPGCC/MCC, Capacitor Panel, MLDB, UPS ACDB, LSDB, ASPB, Feeder Pillar Box, etc.)

1.6.2.1 Handling

- a) As far as possible lifting of switchboards shall be done by making use of eyebolts provided. It shall be ensured that before lifting, all eyebolts are fully tightened and that panel supports, nuts and bolts are intact and tight.
- b) If lifting arrangement is not provided/ not feasible and final positioning by sliding is unavoidable, packing base shall be retained as long as possible and rolled on suitable pipes. Dragging of panel directly on floor by crowbars shall be avoided.
- c) Maximum care shall be taken to avoid any damage to insulator, bushings, meters and protective equipment.

1.6.2.2 Erection

- a) Check the foundation according to the drawings. Ensure that all pockets have been rightly made. Fix the datum level, and level the foundation by chipping in such a way that the prescribed point of cubicle base plate is flushed with finished floor.
- b) Check the individual cubicle for any deformity and ensure that all faces are straight. Any dent on sheet steel frame shall be rectified before placing on foundation.
- c) For Installation of base frame supplied with equipment or site fabricated, level the foundations in both directions (lateral and transverse) and ensure that these have been correctly leveled throughout. In case of runner rails, check the rails for level in both the directions and ensure that they are parallel to each other. Wherever base frame is fixed to cubicle, place the cubicle on foundation ensuring that holding down bolts are directly over the foundation pockets.
- d) Obtain correct level of panel with respect to floor/ existing bus-bar by putting shims below base frame, shims are to be supplied by the contractor. Measure the level of each frame with reference to datum and ensure that level difference between the two ends of the switchboard base frame is within ± 2 mm.
- e) Cubicle shall be so adjusted that front face of all the panels are in one plane, all sides are plumb and corresponding horizontals on all panel faces (e.g. minimum lines, door edges, inter cubicle joints) line up in the same horizontal line (s). Match the cubicles and adjust properly. Provide gasket between edges, if required; so that no inter-panel gaps are seen.
- f) Bolt adjacent cubicles and base frame together by drilling new holes, wherever necessary to match holes.

	ELECTRICAL & INSTRUMENTATION SUPPLY CUM ERECTION WORKS TECHNICAL SPECIFICATION ELECTRICAL WORKS (SUPPLY & ERECTION)	PC183/E/8003/SecVI-2.0	0	
		Document No.	Rev	
		Sheet 88 of 109		

- g) Grout the foundation bolts with mortar, run grouting mixture under base of the cubicle frame, ram to ensure solidity. After grout has set properly, tighten the foundation bolts.

1.6.2.3 Bus Connections and Installation of Loose items

- a) Fix bus bar links and inter panel bus-bar connections with coupling bolts/ supporting insulators. Clean the contact surface of bus bars and links and smear with contact grease before bolting.
- b) Wherever recommended, fix shroud on the joints and fill compound, or compound may be put on joint to form smooth homogenous & spherical shaped mass and then wrapped with tape. Simple taping of joints may also be done. Recommendation of manufacturer/ consultant/ Principal shall be followed in this respect.
- c) In case of misalignment of bus bars, adjustments may be necessary. The connecting pieces may have to be re-drilled or re-fabricated.
- d) Check tightness of bus bars bolts connections with torque wrench. Follow vendor's recommendations in this regard. Bus tightens shall be confirmed by contractor by Micro ohm testing equipment.
- e) Install all loose relays, instruments, cable boxes, metering and protective CTs, PTs etc. Before fixing the relays, make sure that they are cleaned and all packing materials have been removed from them and proper operation. Clean the contacts.
- f) Connect all inter-panel bus wiring. Connections of relays and instruments shall be done as per drawings. Check the wiring according to wiring diagram.
- g) Connect all earthing bus bar between the cubicles and it shall be connected at two points by Al/ GI strip or cable to the main earthing ring. Fix all glands for incoming and outgoing and control cable connections on the holes provided for the purpose, as per drawings.
- h) Drill holes for fixing cable glands/ cable boxes as per drawings, if such holes are not provided. All spare holes, gaps etc. shall be blanked as per instructions of Principal/ Consultant.

1.6.2.4 Cleaning



After erection is complete all cubicles, switches, starters, CTs, PT Chambers, Bus bar Chambers etc. should be cleaned by blowing air (preferably hot air). Surface of the insulation shall be cleaned with cloth soaked in CTC/ Benzene.

1.6.2.5 Circuit breakers installation (Air Circuit Breaker)

- a) Clean the contacts properly with cloth soaked in CTC/ Benzene etc. Clean and lubricate the operating mechanism, check and rectify the main insulating contacts and bushings and also secondary contact for any damage/ misalignment. Check the locking mechanism.
- b) Manually close and trip the breaker several times and check contact alignment and pressure. Adjustment, if required, shall be done according to the manufacturer's instruction. The arc chute if dispatched separately should be fixed properly, only after checking of contact alignment etc. After fixing the Arc Chute, operate manually the breaker and check the contacts make properly. Measure contact resistance with conductor. Check the operation of OFF-ON indicator.

1.6.2.6 Vacuum Circuit Breaker

- a) Check the breaker frame for any damage. In case of vertical isolation type, raise and lower the breaker several times and ensure that breaker moves freely on guide, lubricate the mechanism.
- b) Check the operation of locking mechanism. Check the secondary isolating contacts for any deformity. Check HT bushings for any damage and repair if it is minor.

	ELECTRICAL & INSTRUMENTATION SUPPLY CUM ERECTION WORKS TECHNICAL SPECIFICATION ELECTRICAL WORKS (SUPPLY & ERECTION)	PC183/E/8003/SecVI-2.0	0	
		Document No.	Rev	
		Sheet 89 of 109		

- c) Manually close and trip the breaker several times. Adjust the mechanism as per manufacturer's instruction. Measure the contact resistance with ductor. Check the oil level in the chamber. If level is low, due to leakages, rectify and fill up as per manufacturer's instruction. Check the operation of ON/OFF Indicator.
- d) Check that safety shutter open and close smoothly. Remove the lock if provided before racking in the circuit breakers. Put the circuit breaker inside the cubicles. If cubicle is aligned properly, the circuit breaker shall go smoothly inside the cubicle.
- e) In case of horizontal isolation type circuit breaker, engage the racking mechanism and put the interlock mechanism operates smoothly and adjustment if required shall be done. Slowly rack in the breaker to service position. While racking in, ensure that safety shutters open smoothly. Check the mechanical interlock mechanism. Also check that the main and secondary isolating contacts mesh properly. Conduct this operation a few times to ensure proper functioning and alignment of all mechanism.
- f) For vertical isolation type circuit breaker, put it first at the test position and check interlock mechanism and also the secondary isolating contacts engaged properly. Put it at service position, and slowly raise it to fully raised position. Ensure that main isolating contact bushings enter bush bars spouts smoothly and contacts mesh properly. Conduct the raising/lowering operation several times to ensure a smooth functioning of all mechanism. Any other allied work thought necessary for completion of the erection will have to be done by the Contractor.

1.6.2.7 General Checks

- a) Ensure that all gaskets are in position, replace the same if found damaged.
- b) All opening covers and rear doors shall be bolted with required number of bolts. Take care that no bolt/nut/washer gets lost during handling and erection.
- c) Check inter-changeability of breakers of same rating.



1.7 ECS I/O RACK & NGR

1.7.1.1 Handling

- a) As far as possible lifting of I/O Racks / Panels & NGR shall be done by making use of eyebolts provided. It shall be ensured that before lifting, all eyebolts are fully tightened and that panel supports, nuts and bolts are intact and tight.
- b) If lifting arrangement is not provided/ not feasible and final positioning by sliding is unavoidable, packing base shall be retained as long as possible and rolled on suitable pipes. Dragging of panel directly on floor by crowbars shall be avoided.
- c) Maximum care shall be taken to avoid any damage to insulator, bushings, meters and protective equipment.

1.7.1.2 Erection

- a) Check the foundation according to the drawings. Ensure that all pockets have been rightly made. Fix the datum level, and level the foundation by chipping in such a way that the prescribed point of cubicle base plate is flushed with finished floor.
- b) Check the individual cubicle for any deformity and ensure that all faces are straight. Any dent on sheet steel frame shall be rectified before placing on foundation.
- c) Take prior approval for Fabrication of the base frame if required.
- d) For Installation of base frame supplied with equipment or site fabricated, level the foundations in both directions (lateral and transverse) and ensure that these have been correctly leveled throughout. In case of runner rails, check the rails for level in both the directions and ensure that they are parallel to each other. Wherever base frame is fixed to

	ELECTRICAL & INSTRUMENTATION SUPPLY CUM ERECTION WORKS TECHNICAL SPECIFICATION ELECTRICAL WORKS (SUPPLY & ERECTION)	PC183/E/8003/SecVI-2.0	0	
		Document No.	Rev	
		Sheet 90 of 109		

cubicle, place the cubicle on foundation ensuring that holding down bolts are directly over the foundation pockets.

- e) Obtain correct level of panel with respect to floor/existing bus-bar by putting shims below base frame; shims are to be supplied by the contractor. Measure the level of each frame with reference to datum and ensure that level difference between the two ends of the switchboard base frame is within ± 2 mm.
- f) Cubicle shall be so adjusted that front face of all the panels are in one plane, all sides are plumb and corresponding horizontals on all panel faces (e.g. minimum lines, door edges, inter cubicle joints) line up in the same horizontal line (s). Match the cubicles and adjust properly. Provide gasket between edges, if required; so that no inter-panel gaps are seen.
- g) Bolt adjacent cubicles and base frame together by drilling new holes, wherever necessary to match holes.
- h) Grout the foundation bolts with mortar, run grouting mixture under base of the cubicle frame, ram to ensure solidity. After grout has set properly, tighten the foundation bolts
- i) Mounting in place loose items supplied with the equipment.
- j) In addition to the procedure laid above, any other instruction given by the manufacturer shall also be followed.



1.7.2 Transformer

1.7.2.1 Handling

- a) Transformers shall be lifted by lugs or shackles provided for the purpose to avoid unbalance while lifting.
- b) It shall be ensured that Lifting chains/slings do not interfere with any part of the transformer.
- c) Cover bolts shall be checked for tightness. If found loose, it shall be tightened fully before handling. Care shall be taken that the bolt does not rotate to avoid damage of the gasket.
- d) Jacks shall be used, if required, only on jacking pads provided for the purpose (jacks shall never be used under valves or radiators tubes).
- e) Transformer shall never be left without putting stoppers of the wheels.

1.7.2.2 Erection

- a) Foundation of the transformer shall be prepared and checked for its level as per Drg. before shifting/transferring the transformers from the stores.
- b) Proper time shall be given for curing the level of rails.
- c) Wheels shall be fixed before placing of the transformer in position. Wheels of the transformers shall be checked for its proper movement. Greasing shall also be done on the shaft of wheel before placing the wheels in position. Split pins must be used/placed in position before its rolling.
- d) Transformer shall be placed on the prepared foundation only.
- e) Transformer's wheels shall be checked for its free movement on the rails/plates. It shall be then leveled & aligned with the bus ducts, which shall be connected on the LT side of the transformer.
- f) Stoppers to the transformer wheels shall be provided immediately after alignment to prevent any movement.
- g) Cleaning of all the accessories like radiators, cooling fans, valves, conservator tank, explosion vent pipe, bushings and other accessories shall be done.
- h) Radiators shall be flushed with hot oil before assembly.
- i) Cloth only shall be used for cleaning purposes.



	ELECTRICAL & INSTRUMENTATION SUPPLY CUM ERECTION WORKS TECHNICAL SPECIFICATION ELECTRICAL WORKS (SUPPLY & ERECTION)	PC183/E/8003/SecVI-2.0	0	
		Document No.	Rev	
		Sheet 91 of 109		

CAUTION: While working on the transformers with hand-holes or bushing holes, take care that no tools or any other foreign matters are dropped into the tanks. All the loose tools shall be properly tied and secured.

- j) All accessories such as radiators, conservator, valves, explosion vent pipe, Buchholz relay, HV and LV bushings, cable end termination boxes, marshalling box, instruments, capillary tubes, silica gel breather with dried silica gel, fans etc. shall be assembled as per vendor's drawings and instructions.
 - k) Operation of shut off valves and tightness of all gasket joints shall be checked before topping up of oil. Thermometers shall also be fixed.
 - l) Oil samples from each drum for dielectric strength shall be tested. Oil with standing 40 KV for 1 minute shall only be filled.
 - m) Oil shall be filtered with filtering machine by using metallic hose.
 - n) Bottom drain valve shall be used to fill oil in the transformer tank to prevent aeration in oil.
 - o) It shall be ensured during oil filling operation that no air pockets are left in the tank and no dust or moisture enters the oil. All air vents shall be opened. Oil flow rate shall be reduced when oil level is almost up to the bottom of the main cover to prevent internal pressure from rupturing the diaphragm of pressure relief pipe. Sufficient time shall be allowed to escape all air bubbles. Air bubble accumulated in Buchholz relay shall be released by opening air release cock provided on the top. Vent plugs shall be closed.
 - p) Cables shall be connected to HV and LV terminals of transformer.
 - q) Control cables/ power cables shall be connected to Marshalling Box. Stop push button mounted on the wall of transformer room shall be connected to trip the transformer.
 - r) Transformer body shall be earthed at two separate points to main earthing strip.
 - s) Transformer neutral shall be earthed to a separate and distinct neutral earth pit (through NER, wherever applicable) as per design and drawings.
 - t) Danger notice board conforming to IS: 2551 and IE Rules 1956 shall be provided on enclosure or door of the enclosure.
 - u) Transformer Room's door/enclosures shall be earthed as per IE Rules, 1956.
- Safety items i.e. fire extinguishers, shock treatment chart, fire buckets with screened sand, danger board etc. shall be provided

1.7.3 **Storage Batteries**

- a) Installation work for storage battery cells on steel / wooden racks shall be done strictly as per supplier's drawings and instructions.
- b) Steel / wooden racks shall be installed in the battery room on support insulators. The racks shall be plumbed and aligned properly.
- c) Each cell shall be inspected for any damage of its positive, negative plates, containers etc. Cell shall be cleaned properly and all packing materials removed as per manufacturer's instructions.
- d) The cells after assembling the plates, indicators etc. shall be placed on cell insulators over racks and interconnected to each other so as to avoid strain on cell-terminals.
- e) The electrolyte shall be prepared in large glass/ PVC or special jars as per manufacturer's instructions. The jars shall be cleaned with distilled water. The concentrated sulphuric acid shall be added to the distilled water slowly (never add water to sulphuric acid) and electrolyte stirred constantly with PVC rod. Temperature and specific gravity of electrolyte shall be as per manufacturer's instruction.

	ELECTRICAL & INSTRUMENTATION SUPPLY CUM ERECTION WORKS TECHNICAL SPECIFICATION ELECTRICAL WORKS (SUPPLY & ERECTION)	PC183/E/8003/SecVI-2.0	0	
		Document No.	Rev	
		Sheet 92 of 109		

- f) All necessary safety precautions shall be taken while preparing the electrolyte i.e. goggles, rubber apron, and gloves etc. shall be used.
- g) No foreign materials, dust or dirt etc. shall be allowed to fall in the electrolyte and it shall be kept duly covered.
- h) Connection to the battery charger shall be made.
- i) Prepared electrolyte shall be filled in cells up to mark level of at least 10 mm above upper edge of the plates in a manner approved by manufacturer. Electrolyte shall be allowed to cool down.
- j) While giving initial charges to the cells, instructions of the manufacturer's regarding rate of charging shall be strictly followed and care taken that charging unit is not over loaded more than the rated capacity. During the period of charging, the cells must be topped up as often as necessary to prevent the electrolyte falling below the required level. Distilled water to be used for topping purposes and quantity of distilled water used for topping up of the cells shall be noted.
- k) After initial charging battery shall be discharged at specified rate. Thereafter battery shall be recharged.
- l) Record all battery voltage of each cell, specific gravity, temperature, charging current during charging/ discharging and shall be kept in Performa supplied by the supplier or in a form approved by the consultant/ Owner Discharging and recharging operations shall be done as recommended. After final charging the battery shall be put on float charge.
- m) No naked flame or sunlight shall be permitted in battery room and smoking shall be strictly prohibited.
- n) During initial charging and discharging battery shall not be left unattended. It is to be assured that battery room is properly ventilated with an exhaust fan / blower.
- o) It is to be assured that battery room is properly ventilated with an exhaust fan.



1.7.4 Cable Installation

1.7.4.1 General

- a) All fabrication, cutting, laying, spacing, fixing etc. of cables, trays, supports, hangers etc. shall be as per drawings and instructions of Owner/Engineer-in-Charge.
- b) The contractor shall keep accurate record of cable drums supplied by owner, the drum nos. and actual length of cable taken out of each drum. Each cable length shall be cut from a specific drum as per approved schedule of cable. Lengths of cable runs shown in the cable schedule are calculated lengths only, hence the actual lengths shall be measured at site before laying and cutting the cable. The contractor shall take extreme care to adjust cable runs from drums so that joints in the cable are avoided and wastage reduced to minimum.
- c) For purpose of measurement of cable run for payment the length of cable between and terminations only shall be considered.
- d) Factory made cable tray, bend elbow, etc. also shall be used. Whereas standard supply could not be used/available. Fabrication as per site requirement shall be in contractor's scope including cold galvanization on site.
- e) Dismantling of cables rolling in cable drums, disposal at designated place as required by owner / engineer in charge shall be carried out by the contractor.

1.7.4.2 Laying



- a) The cable drums should be properly mounted on jack/ cable wheel. Make sure that the spindle is suitable for carrying weight of the drum without bending. Check that spindle is laying horizontal on the bearing so as to prevent the drum creeping to one side or to the other while rotating.

	ELECTRICAL & INSTRUMENTATION SUPPLY CUM ERECTION WORKS TECHNICAL SPECIFICATION ELECTRICAL WORKS (SUPPLY & ERECTION)	PC183/E/8003/SecVI-2.0	0	
		Document No.	Rev	
		Sheet 93 of 109		

- b) Unroll the cables from the drum in correct direction. Rotate drum only as per arrow mark given in the cable drum. Ensure that the end protection box attached to the flange of the drum is removed and securing rope cut to allow cable and move freely. Rotate the cable drum and simultaneously pull cable steadily and with even pulls and not with unnecessary jerk or strain. In no case the cable shall be allowed to twist or kink since this is likely to spring the armour and fracture the insulation and outer serving of the cable.
- c) Do not drag the cable on floor or hard surface. Use only wooden/steel cable rollers for this purpose.
- d) Cable should not be bent sharply to a small radius. The cable bending radius shall be as large as possible and will not be less than 15 times the outside diameter for XLPE cables and 12 times for PVC cables. At joint termination the individual core of cable shall not be bent with bending radius of less than 15 times the diameter over the insulation.
- e) Where cables are laid on the MS racks, trays etc. ensure that trays/racks/supports are fixed properly in an approved manner or according to the drawings. Check from drawings that for horizontal runs of cable, bracket, risers, supports, angles are grouted or fixed in formation as required.
- f) In sub-station where large no. of cables rise to panels/switchboards, it shall be ensured that these risers do not interfere with cables on racks and rising cables do not interfere with cables on racks and rising cables do not cross the other cables in horizontal runs. Risers are to be properly supported so that weight of cable does not fall on terminations. All cable crossings shall be avoided.
- g) Cable laid in trenches should be sealed at the entry to hazardous area/non-hazardous area as per direction of owner/engineer-in-charge.
- h) Openings in substation basement and floors for entry of cables shall be sealed after the cables are laid.
- i) Cables shall be clamped by taking care to be taken to space clamps at such intervals as to prevent buckling of cables.
- j) The laying of the cable on the racks shall be done in an approved manner and according to the drawings supplied.
- k) Where cables are laid in cable slits, the slits after laying of cables shall be filled with sand & lean cement mixture and plastered so that surface flushes with top of slit.
- l) Cable cutting shall be done as per cable cutting schedule.

1.7.4.3 Directly Buried Cables

- a) Laying of underground directly buried cables shall include excavation of earth along the cable route, laying of Hume/GI pipes for road crossing, back filling, ramming, removing of extra earth including supply of bricks, sand etc. as per drawing and instruction of Owner/Engineer-in-Charge.
- b) Where cables are directly laid into ground, trenches should be dug up to such a depth as to ensure that the depth of the top of the entire cable below the ground level is min. 900 mm for medium and low voltage cables, and min. 1200 mm for high voltage cables. Before laying of cables at these trenches, bottom of the trench should be properly leveled up and all odd and sharp materials removed. Trench bottom then should be bedded with a 75 mm thick layer of sand. Approval of Owner/Engineer-in-Charge shall be taken for preparation of this bed before laying of cables. Cables shall be laid in the trenches in straight runs. Care shall be taken so that any kinks or bends are not formed. After laying of the cables, bricks shall be placed length wise on both the sides of the cables along the entire length to form trough.
- c) Fill up space between bricks with sand up to height of the bricks. Then place bricks closely width wise on top of the sand layer throughout the length. Fill up loose earth in trench, ram

	ELECTRICAL & INSTRUMENTATION SUPPLY CUM ERECTION WORKS TECHNICAL SPECIFICATION ELECTRICAL WORKS (SUPPLY & ERECTION)	PC183/E/8003/SecVI-2.0	0	
		Document No.	Rev	
		Sheet 94 of 109		

properly to compact, remove extra earth from site. Broken bricks shall not be use for brick working. Only Class-I bricks shall be used.

- d) If new cables are laid to cross existing cables, the new cable shall be laid under existing cables at depth of not less than 200 mm from the existing cable. It shall be ensured that the approach of new cable to the crossing is uniform and gradually sloped.
- e) Fix cable markers at 100 Mtrs. apart and at joints on the entire cable route length of the cables. The cable markers shall be made of pre-cast concrete blocks of 300 mm x 350 mm x 350 mm size with markings of "HT CABLE", "LT CABLE", "Depth of Cable", "Arrow Marks" etc. inscribed. These shall be supplied by the contractor at no extra cost and fixed as per directions of the Owner / Engineer-in-Charge. The top of the above concrete slabs shall have a smooth finish with cement only.
- f) Laying of cables under road crossings etc. shall be done in pipes, and pipe ends shall be sealed with bitumen compound and sand as required after cables are laid. Backfilled soil shall be rammed thoroughly to prevent road surface cracking due to settlement of loose soil.

1.7.4.4 Laying in Readymade Trenches

- a) RCC slabs / chequered plates lifted from trenches for laying cables shall be put back in position at close of work every day to avoid accident & damage to cables in the trench.
- b) When cables pass through pipes, pipe ends shall be sealed with bitumen compound and sand as required.
- c) Protection pipes shall be provided, whenever cables enter from the floor, trench etc. in the equipment and sealing in and around these pipes shall be done.

1.7.5 Cable Jointing and Termination

1.7.5.1 General



The scope of work shall include but not limited to the followings:

- a) Soldering/crimping of sockets/ferrules and connections at all joints/terminations as per specifications. Sockets shall be provided at all terminations except where pressure clamp type terminals are provided.
- b) Glanding of cable and fixing of cable boxes.
- c) Scrap generated from cable termination shall be disposed in scrap yard as per instruction of site engineer in charge.
- d) Tagging of cables at its both ends e.g. MCC/DB & equipment end.

1.7.5.2 Specifications

- a) HT XLPE cables shall be terminated by use of heat shrink type termination kits.
- b) All LT XLPE power and control cables shall be terminated through double compression type gland.
- c) In case of LT XLPE cables, armours shall be suitably earthed in compression type glands. For HT XLPE cables, this shall be done either in glands or by any other suitable means like bonding the armour with suitable wire and connecting same to the earth terminals inside cable box.
- d) In explosion proof equipment, sealing accessories, where provided in cable box, shall be used for sealing the cable entry to the box and termination.
- e) All lighting and control cables shall be provided with crimped Al/Cu Sockets before termination in junction boxes.

1.7.5.3 Crimping

	ELECTRICAL & INSTRUMENTATION SUPPLY CUM ERECTION WORKS TECHNICAL SPECIFICATION ELECTRICAL WORKS (SUPPLY & ERECTION)	PC183/E/8003/SecVI-2.0	0	
		Document No.	Rev	
		Sheet 95 of 109		

- a) For all power cables, crimping type Al lugs for Al cables and tinned Cu lugs for Cu cables shall be provided. These lugs shall be crimped on the cable conductors by means of special hand/hydraulic crimping tools. Before crimping the socket inhibiting grease shall be smeared over the conductor. Conductor shall be shaped properly before sliding the socket over it. Crimping shall be done in an approved manner.
- b) All the control cables, which shall be of copper conductor, shall be terminated without any additional lugs in screwed type terminals provided in various equipments.

1.7.5.4 Jointing

- a) The jointing shall be done in an approved manner. Care shall be taken not to damage the insulation when opening the cable for jointing.
- b) Before commencing soldering of the socket, conductor shall be thoroughly cleaned and insulation protected. The ferrules shall be thoroughly cleaned. Ferrule and each strand of the cable shall be thoroughly sweated with solder to tin them and fill the conductor gaps to remove all air pockets. Soldering materials of approved quality as per ISS practice shall be used. Taping of the conductors shall be done in an approved manner after crimping/soldering.

1.7.5.5 Filling up compound and sealing the cable box shall never be done in one operation. After the first pouring of compound, it should be topped up again with compound and then sealed.

1.7.5.6 Sealing of GI pipe end shall be done after cable termination.

1.7.5.7 **STRAIGHT THROUGH JOINTS**

- a) Jointing of XLPE & HRPVC cables shall be done with extreme care and manufacturer's instructions shall be strictly followed. Soldering of sockets shall also be done with extreme care as indicated above.



Earth continuity wire shall be plumbed and/or clamped. Compound shall be filled according to the instructions of manufacturers of terminating kit/cable. Joints made inside trench or on rack shall be properly supported. Wherever joints are made inside ground, brick masonry work shall be done around the joint box and filled with sand, and there after covered with earth at no extra cost.

- b) A tent shall be used in all circumstances where jointing work is being done outdoor, for protection against rain and to prevent dust from being blown in to exposed joints and jointing materials. Extreme care shall be taken to maintain proper phase sequence while terminating at equipment ends. Records of connection details shall be maintained. Conductors shall be shaped properly while terminating and no sharp bends shall be given. Where numbers of cables are to be connected in parallel, proper tests shall be done before connection, so that no cross connection shall be made. No phase crossings shall be allowed for making the connections.
- c) Cables shall be supported adequately at the entry to cable box/equipment so that load of cable does not come on cable glands.
- d) All cables shall be meggered before and after jointing and insulation values recorded.
- e) While terminating at equipment end, each core shall be properly tagged with numbering ferrules as per nomenclature given in the drawings. Wires should be dressed and clamped neatly, bolting shall be done properly.

1.7.6 **Earthing**

1.7.6.1 General

- a) Painting of all earth strip joints with anti-corrosive paints shall be carried out as per details given in drawings and instruction of Owner/Engineer-in-Charge.

	ELECTRICAL & INSTRUMENTATION SUPPLY CUM ERECTION WORKS TECHNICAL SPECIFICATION ELECTRICAL WORKS (SUPPLY & ERECTION)	PC183/E/8003/SecVI-2.0	0	
		Document No.	Rev	
		Sheet 96 of 109		

- b) All electrical equipment rated 415 V and above shall be connected to earth bus by two separate and distinct earth connections. All equipment rated 240 V and below shall be earthed with single earth conductor.

1.7.6.2 Specifications

- a) Types and sizes of earthing conductors shall be as indicated in the SOR attached. All earthing installations shall conform to IS-3043.
- b) Underground conductors shall run at a depth of 600 mm below ground level. Where these conductors run along with cables, they shall be laid at the same depth as cables. Where conductors run on wall, ceilings, they shall be laid on clamps or brackets made out of Al/GI strips.
- c) Wherever, earthing conductor is passing through floor, walls etc. the conductor shall be taken through PVC/GI pipes.
- d) All paints, enamel etc. shall be removed from point of contact before making connections.
- e) Connections between G.I. strips shall be done by welding. For connecting Al conductor/G.I. wire, Al socket shall be crimped on the conductor/wire. At the equipment end, connections shall be done by bolting.
- f) Connection between Al & GI shall be done by bolting. Graphite grease shall be applied on contact surfaces.
- g) Epoxy resin paint or bitumen shall be applied on welded or bolted joints to prevent corrosion and taping done as indicated in the drawing. Connections between Al wires shall be done by crimping back to back Al ferrule.
- h) Earth electrodes - Earth electrodes shall be provided as per drawings/specification. Work includes excavation of earth, installation of electrodes and test links etc., supply and filling of charcoal and common salt, back filling of earth and removal of extra earth as specified earlier. It also includes making brick wall around the electrode and cover as per drawings/specifications. The testing links shall be grouted on brick wall and connections with earth electrode and conductors shall be made. Distance between two electrodes shall not be less than 10 meters and may be located 4 M away from building foundation.
- i) Earth pits for equipment earthing, neutral earthing and lightning protection shall be separate. However, these pits shall be inter-connected.

1.7.7 Plant Lighting



1.7.7.1 The electrical installation covered by this specification shall conform to relevant Indian Standards & codes of practices.

1.7.7.2 Erection of light fittings, plug sockets etc.

1.7.7.3 Fabrication of supports for lighting fittings, sockets, junction boxes shall be done as per the relevant drawings/instructions given by the owner/consultant/engineer-in-charge. These shall be grouted to walls, ceiling or welded to insert plates, steel structures etc. Insert plates on ceilings shall normally be provided. However, if required, the contractor shall weld such supports to the reinforcement rods after exposing by chipping off concrete at no extra cost. Installation of lighting fittings includes control boxes, where supplied separately and shall be done as per drawings. Before installation, checking of internal parts, assembly of accessories shall be done as per manufacturer's instruction.

1.7.7.4 The explosion-proof fittings shall be earthed through third core of the cable used for wiring. The third pin and body of 15 amps/25A switch socket shall be earthed similarly.

1.7.7.5 Installation of explosion proof equipment shall be done strictly following manufacturer's instruction or relevant Standards. Cable termination shall be done as per relevant drawings. No drilling of holes or any change in construction of equipment or part thereof shall be done.

	ELECTRICAL & INSTRUMENTATION SUPPLY CUM ERECTION WORKS TECHNICAL SPECIFICATION ELECTRICAL WORKS (SUPPLY & ERECTION)	PC183/E/8003/SecVI-2.0	0	
		Document No.	Rev	
		Sheet 97 of 109		

1.7.7.6 Wiring for normal AC supply light points and plugs shall be taken on the same brackets but wiring for emergency DC supply lights shall be taken separately. Drawings for lighting layout give only tentative location of fittings and wiring route shall be decided in consultation with owner/engineer-in-charge. Wiring shall follow shortest possible route and no. of circuit shall be bunched together to the extent possible in the same route. For wiring and laying of cables, "CABLE INSTALLATION PROCEDURE" described above shall be referred.

1.7.7.7 Cable for wiring light points and socket outlets shall normally be laid along wall, ceilings, structures, on suitable brackets made out of M.S./Al sheets or strips. Connections to the points with fluorescent fixtures in one circuit shall be taken through junction boxes. Junction boxes shall be suitably located for branching off from the circuit to the individual point. Wherever indicated, cables may be laid directly on walls, ceilings etc. by clamping on saddles.

1.7.7.8 Terminations shall be done in a manner as detailed in Cl. 3.6.6. Wherever indicated, the wire can be drawn through PVC bushings provided in the fittings. Relevant drawings may also be referred to.

1.7.7.9 Lamps shall be installed after installation of fittings and wirings.

1.7.7.10 All light fittings and corresponding control switches shall be numbered in a permanent way as instructed by owner/engineer-in-charge.

1.7.8 ERECTION OF STRUCTURES

1.7.8.1 Specification



The fabrication work shall be done as per drawings/specifications/sketches in an approved manner and to the entire satisfaction of owner/engineer-in-charge. The contractor shall take adequate measures to avoid wastage. Scrap quantity shall not exceed 2% of total quantity used for erection.

1.7.8.2 Erection of racks, risers, supports etc.

- a) Erection of racks and risers for cable supports shall be done along the cable routes as indicated in the drawings. Where no such drawing exist contractor shall prepare site execution drawings get approval prior to actual site execution. The contractor before erection shall check the route for any obstruction like process pipe lines, structures, equipment etc. In case of obstructions, the matter shall be brought to the notice of owner/engineer-in-charge in writing and racks shall be re-routed as per his instructions.
- b) As and where indicated in the drawings, supports for racks, risers etc. shall be welded on the steel structure, such as MS beams, pipe trestles, insert plates provided in the RCC column etc. for erection of racks.
- c) Wherever indicated, supports for racks, risers, shall be grouted on walls. The racks, risers etc. shall be installed on such supports and those properly welded.
- d) Opening on walls/floors shall be provided where racks/risers are crossing floors/walls.
- e) Heavy channels, risers may also be grouted on the floors in addition to supports provided from walls, ceilings, steel structures etc.
- f) As indicated in the drawings, racks and risers shall be erected either in single tier/ multi tier formation.

1.7.8.3 Erection of supports in trench

- a) Supports and Hangers shall be grouted with rag bolts on the walls of readymade concrete trench.
- b) In existing trench wall, contractor may be required to provide pockets for grouting cable supports at some points. This shall be done without any extra cost to the owner.

	ELECTRICAL & INSTRUMENTATION SUPPLY CUM ERECTION WORKS TECHNICAL SPECIFICATION ELECTRICAL WORKS (SUPPLY & ERECTION)	PC183/E/8003/SecVI-2.0	0	
		Document No.	Rev	
		Sheet 98 of 109		

c) In case of requirement of insert plates for support of cable rack, the contractor shall weld such plates to the reinforcement MS rods. This shall be done by chipping the concrete for exposing the reinforcement MS rods and thereafter welding the plates and making good the concrete chipping by plastering.

1.7.8.4 The pipes will have to be bent (wherever required) and fixed/embedded in floor, wall and ground for laying the cables. Neoprene bushes shall have to be fixed at the end of such pipes.

1.7.8.5 GI trays of different sizes shall be cut in size and fixed on racks and risers. Fixing of trays shall only be done after erection/welding/painting of the supports as required.

1.7.8.6 Erection of support frames for miscellaneous equipments, base channels for transformers and switchboards etc. shall be carried out at no extra cost.

1.7.8.7 Dismantling of steel fabrication, disposal at designated place and re-erecting as required by owner/engineer-in-charge shall have to be carried out by the contractor.

1.7.8.8 Dismantling of cable racks, disposal at designated place and re-erecting as required by owner/engineer in charge shall be carried out by the contractor.

1.8 **GENERAL PROCEDURE FOR TESTING & COMMISSIONING**

1.8.1 Before proceeding with the work, contractor shall fully inspect all installed Electrical Equipment for completeness, signs of damages, defects etc. and record all discrepancies noticed. The contractor shall be required to make good/repair/replace the damaged components at no extra cost.

1.8.2 Testing and Commissioning Requirements

a) All works shall be carried out in accordance with the drawings, supplier's instructions/ manuals for equipment and as per relevant ISS & Code of Practices.

b) Before conducting test on any equipment, the contractor shall obtain permission from owner/ engineer-in-charge and all tests shall be conducted in their presence.

c) Results of each test shall be recorded by the contractor immediately after the test on approved Performa and counter signed by the owner's authorized representative. The test results shall be furnished in four copies in the form of 'Test Certificates'. Performa of which shall be provided during testing.

d) Copies of the record shall be handed over to owner/engineer-in-charge.

e) The Contractor shall commission all electrical equipment and carry out all pre-commissioning/commissioning tests inclusive of no-load and on-load tests on motors, and shall be responsible for final adjustments of relays, motors, instruments, starters, breakers etc. as per operational data supplied and as per directions of Engineer-in-Charge.

f) All terminals, cable joints, earth terminals which are opened for testing purposes shall be re-terminated and re-insulated by the Contractor to restore their original state.



g) Painting

h) The contractor shall without any extra cost, touch up with paint all electrical equipment which are damaged/scratched during testing and commissioning work. The paint used shall match exactly painted surface of the equipment on which touch up is done.

1.8.3 Cleaning and Regular Maintenance

Till the commissioned equipment is finally accepted by owner/engineer-in-charge, Contractor shall be responsible for regular cleaning and maintenance of all electrical equipment. The maintenance job is to be done in consultation with or on advice from the Owner/Consultant.

1.9 **TESTING & COMMISSIONING SPECIFICATIONS**

	ELECTRICAL & INSTRUMENTATION SUPPLY CUM ERECTION WORKS TECHNICAL SPECIFICATION ELECTRICAL WORKS (SUPPLY & ERECTION)	PC183/E/8003/SecVI-2.0	0	
		Document No.	Rev	
		Sheet 99 of 109		

1.9.1 These specifications lay down the testing and commissioning procedures to be followed for each type of equipment, over and above the general requirements laid down in specifications for erection.

Manufacturer's instructions and any other instructions of owner/consultant/engineer-in-charge/statutory bodies shall also be followed by the contractor during testing and commissioning.

The contractor shall maintain and furnish the records of all equipments i.e. HT/LT panels, motors, transformers, CT, PT, relays etc. including any special test as per manufacturer's manual.

1.9.2 Switch Boards

1.9.2.1 General Checks

- a) Check all auxiliary contacts of breakers for proper make/break operation.
- b) If necessary, make minor adjustments to circuit breakers mechanism, auxiliary contacts etc. for proper operation of circuit breakers. Proper greasing and lubrication or mechanism shall also be done before final commissioning.
- c) Check for termination of control circuit wiring as per drawing and ensure that the terminals at equipment and panel are mechanically sound.
- d) Ensure proper operation of all test operation switches and push button.
- e) Check wiring of all space heaters, indication lamps bells, buzzers etc.

1.9.2.2 Insulation resistance test

- a) Measure the insulation resistance of main bus-bars (Phase to phase & Phase to earth) and circuit breaker with 5000V/2500V/1000V Megger (IR values shall generally be not less than 100M Ω for 11KV, 50M Ω for 3.3KV, 10M Ω for 415V).
- b) Control wiring shall be tested with 500 V Megger (IR values shall not be less than 2 M Ω).

1.9.2.3 High Voltage Test

The test shall be conducted on switch Gear rated 3.3 KV and above. Test shall be as per relevant Indian Standard. However, for AC high voltage test the value shall be twice the working voltage of the switchgear plus 1000V. This voltage shall be maintained for 1 minute. Each phase shall be tested in turn with remaining phases earthed. After high voltage test, a further megger test shall be made to make sure that insulation resistance to earth has not altered appreciably. The reading of second megger test should be consistent with that of the first. (AC test voltage for 1 min. duration shall be 24KV for 11 KV panel and 8 KV for 3.3 KV panel).

1.9.2.4 Testing of Current Transformer



- a) Insulation resistance to earth of Primary Winding and Between Primary and secondary winding shall be tested with 500 V megger (remove earth connection before test).
- b) Check the polarity of C.T:- Connect zero centre voltmeter in the secondary winding, connect 6V battery with switch in the primary, close the switch and from the kick of the voltmeter, ascertain the polarity.
- c) CT Primary Injection shall be performed using CT primary injection KIT.

1.9.2.5 Testing of P.T. Insulation

Testing of H.T. & LT side of P.T. shall be done with 1000 Volts and 500 Volts megger respectively (the value shall not be less than 100 M Ω and 2 M Ω respectively).

1.9.2.6 Testing of Relays

- a) Checking of wiring shall be done according to Manufacturer's drawings. Check relay continuity at all taps and also ensure plug bridge contact satisfactory.

	ELECTRICAL & INSTRUMENTATION SUPPLY CUM ERECTION WORKS TECHNICAL SPECIFICATION ELECTRICAL WORKS (SUPPLY & ERECTION)	PC183/E/8003/SecVI-2.0	0	
		Document No.	Rev	
		Sheet 100 of 109		

b) Secondary injection test

Use secondary injection test set incorporating timer. Testing of all protective relays such as but not limited to over current, earth fault, differential, motor protection, under voltage relays, generator protection relay etc. shall be done as per the procedure set by the manufacturers of the relays. All time delay relays shall be tested to verify their characteristics for IDMT and instantaneous relay pick up and drop off values shall be noted at various taps. Relays shall be tested at all taps. Errors shall be calculated and compared with permissible limits specified by manufacturers. Adjustment, such as in establishing circuit, shall be done as recommended by manufacturer. After testing, relays shall be set at values given by Consultant.

c) Timer relay shall be tested and calibrated and set properly.

d) All auxiliary relays shall be tested for proper operation.

1.9.2.7 Testing of Instruments

All indicating and recording instruments like Ammeter, Voltage meter, KWh meter etc. shall be calibrated. Zero error of each instrument shall be corrected.

1.9.2.8 Operational Test



Conduct the following operational tests after putting the circuit breaker at test and service position. Check that the fuses of proper rating are put in control circuit as per wiring diagram.

- a) Close and trip the circuit breaker several times with power or manually. In case of motor operated spring charged closing mechanism, check the operation of charging motor. Ensure that it cuts in/off properly.
- b) Check the indication scheme ON, OFF, trip circuit healthy, auto-trip etc.
- c) Trip the breaker by operating the protective relays (operate contact manually).
- d) Check the trip free feature
- e) Check the anti-pumping feature
- f) Check operation of voltage selector relay scheme for supply.
- g) Check annunciation scheme for AC/DC power supply failure.
- h) Each motor starter shall be tested for correct operation. All operational tests to verify sequence of operation, inter-locking, alarm indication schemes (by simulating the connection) shall be done.
- i) Bi-metallic type thermal over load relay shall be tested at different settings. Current shall be injected through the thermal elements (three elements can be connected in series) at twice and thrice the set value and tripping time shall be noted. The values shall be compared with the data supplied by manufacturer.
- j) Single phase prevention relays shall be tested for proper operation.
- k) Check that fuses of specified ratings are put in various outlets.

1.9.3 Testing of Distribution board (ASPB, DCDB, LSDB, UPS ACDB etc.)

- a) **Wiring check for completeness for all equipment of the Panel.**
- b) **IR value with 500V Insulation Tester.**
- c) **Operational check of the Panel by simulation.**
- d) **Meters and indication lamp to be checked.**

1.9.4 Transformer

	ELECTRICAL & INSTRUMENTATION SUPPLY CUM ERECTION WORKS TECHNICAL SPECIFICATION ELECTRICAL WORKS (SUPPLY & ERECTION)	PC183/E/8003/SecVI-2.0	0	
		Document No.	Rev	
		Sheet 101 of 109		

1.9.4.1 Final testing before commissioning shall be done in cold condition after drying out the transformer and disconnecting H.V. and L.V. side cables by removing link in disconnecting chamber, cables and also earth connections to neutral.

1.9.4.2 At least 5000/2500/1000 V Volt megger shall be used for 11/3.3/0.415 KV winding and manufacturer's test certificates shall be compared for the purpose. 500 Volt megger shall be used for auxiliary power cables and control cable and values shall be preferably more than 2 MΩ.

Polarization Index shall be recorded as below to determine whether drying is necessary or not:-

$$PI = \frac{IR \ 10 \ Min}{IR \ 1 \ Min}$$

	Evaluation of insulation condition based	Base on PI	Drying on PI
Hazardous	< 1	Mandatory	
Bad	1-1.5	Mandatory	
Doubtful	1.5 - 2	Recommended	
Adequate	2 - 3	No	
Good	3 - 4	No	
Excellent	> 4	No	

1.9.4.3 Oil Tests

- Crackle Test: Cleaned Iron piece shall be heated red hot and put in the oil taken in a pot. In case of crackle sound, presence of moisture is indicated.
- Dielectric Strength Test: It shall be done as prescribed in Appendix 'C' of IS: 335. The oil should withstand minimum of 40 KV for 1 minute.

Even oil conditions are found satisfactory in testing after final topping. It is advisable that as an additional precaution, the transformers shall be dried out.

1.9.4.4 Drying out Procedure

- Drying out of the transformers shall be carried out in accordance with IS: 10028.



Before drying out following points shall be checked:-

- Any oil leakage through bushings and radiators
- Transformer tank is connected to the earth
- Temperature indicators are suitably calibrated and connected

- Precautions when drying :-

Maximum sustained temperature shall not be more than 80°C. Do not leave the transformer unattended during drying out period. Watch the transformer during drying out process and record carefully all observations viz. Oil temperature, winding temperature and insulation resistance of H.V. and L.V. windings. Drying out shall be continued till the insulation resistance value is steady prescribed in Standard Code of practice and IS: 10028 Part-II and steady value remains constant for 12 hours. Within the above period, several samples of oil are to be tested to ascertain dielectric strength. All readings shall be recorded (hourly/half hourly) for insulation resistance and temperature of oil and winding. Sample of transformer oil shall be collected from bottom only. The oil shall be allowed to settle for at least 24 hrs.

In case the insulation value does not improve by the above method, low voltage equal to impedance voltage shall be supplied to HV side for few hours after short-circuiting the

	ELECTRICAL & INSTRUMENTATION SUPPLY CUM ERECTION WORKS TECHNICAL SPECIFICATION ELECTRICAL WORKS (SUPPLY & ERECTION)	PC183/E/8003/SecVI-2.0	0	
		Document No.	Rev	
		Sheet 102 of 109		

LV side. During the process, regular readings of insulation resistance of winding to earth, winding to winding and temperature against time shall be recorded.

If necessary/depending upon the manufacturer's recommendations, a vacuum pressure of 635 mm of mercury shall be applied for removal of air bubble. Hot air shall be released after drying out is done. Vent cocks and screws after release of air shall be closed.

1.9.4.5 Ratio Test :

3 phase, 415 volt shall be supplied on HV side for every tap position and reading shall be taken on other side. For every tap changing, supply shall be switched off for off-load changer.

1.9.4.6 Polarity Test

3 phase, 415 volts shall be applied to HV side. One terminal of HV side shall be joined to corresponding terminal of LV side, say A-a. The voltage across A-a, A-b, B-a, B-b, B-c, C-a, C-b, C-c, N-a, N-b, N-c shall be recorded and vector group shall be ascertained.

1.9.4.7 Phasing for Paralleling Operations

Two transformers shall be connected on primary side. Terminal 'a' of secondary side shall be connected to bus-bar which corresponds to the equivalent terminal of second transformer. Both transformers shall be at same tap. Then 415 volt, 3 phase supply shall be connected to primary side. Circuit breaker of second transformer shall be closed. The corresponding secondary terminal voltage of two transformers, a1-a2, b1-b2, c1-c2 shall be measured. These voltages shall be zero in case both transformers are of same polarity and phase displacement. Voltmeter of the double reading of voltage of the secondary shall be used for measuring their condition. In case of star connected secondary winding having star joint earthed, secondary terminals need not be connected as stated earlier.

1.9.4.8 Buchholz Relay Testing

Air pressure shall be inserted through petcock gently till alarm contacts make. Pressure shall further be increased till trip contact makes. For low oil pressure also check shall be done.

1.9.4.9 Temperature Indicators

Temperature indicator shall be calibrated for the alarm contact properly.

1.9.4.10 Following points shall be checked before commissioning the transformer:-

a) General Inspections

- i) Assembly of accessories and mounting shall be checked with reference to Drgs.
- ii) Tightness of all cover bolts, flange etc. shall be checked.
- iii) Oil leakage through bushings, valve, radiator valve etc. shall be checked.

b) Oil Level

- i) Correct level in conservator shall be checked.
- ii) Oil level in disconnecting chamber and in thermometer pocket shall be checked.

c) Buchholz Relay



It shall be checked that floats are at normal position and shut off valve between relay & conservator is open.

d) Breather

- i) It shall be checked that the protective cover on air passage is removed.
- ii) Oil level in seal chamber and condition of silica gel shall be checked.

e) Explosion Vent

- i) It shall be checked that the diaphragm is intact and no oil visible in gauge glass.

	ELECTRICAL & INSTRUMENTATION SUPPLY CUM ERECTION WORKS TECHNICAL SPECIFICATION ELECTRICAL WORKS (SUPPLY & ERECTION)	PC183/E/8003/SecVI-2.0	0	
		Document No.	Rev	
		Sheet 103 of 109		

- ii) Equalizer pipe valve between vent and conservator shall be opened.
- f) Radiator
 - All the valves between radiator bands and main tank shall be opened.
- g) Thermometer
 - The connection of C.T. and Heater element for winding temperature indicator shall be checked.
- h) Wiring
 - Wiring from instruments to marshalling box and to switch board/ control panel shall be checked.
- i) HV and LV Bushing and connections.
 - a. Bushings shall be cleaned and connections shall be checked for outgoing and incoming lines.
 - b. Gap of arcing horn (HV bushing) shall be checked.
 - c. High pot test of transformer shall be completed.
- j) After all checking found O.K., the breaker for incoming of transformer shall be made ON for charging the transformer. It shall be watched for at 24 hrs. without load. Then it can be loaded after finding everything O.K.

1.9.5 DC Distribution Board/UPS/VFD

- a) Test insulation resistance with 500 V megger. T
- b) All operational tests to verify function of each component like relays, switches etc. and sequence of operation, interlock, as per circuit diagram.
- c) Above panels shall be tested as per the instructions of manufacturer A

1.9.6 Cables

- a) All HT & LT cables shall be tested for insulation resistance with 5000/2500/415 V megger as applicable after termination. IR shall be measured between phases and between phase & earth. The voltage shall be applied for 1 minute.
- b) IR test of HT cables shall be done before and after of High Voltage test in accordance with IS: 1255.
- c) Tan Delta testing of all the new cables shall be performed at site.

1.9.7 Neutral Earthing Resistor



Before taking any NER in line, the IR values shall be recorded for entire installation. The testing shall be done with 500 V megger. Resistance of the NER shall also be measured and recorded.

1.9.8 Lighting

Before energizing any lighting circuit, the IR values (phase to phase and phase to earth) shall be recorded for entire wiring installation. The testing shall be done with 500 V megger. After switching on the power supply, load of each circuit shall be measured.

1.9.9 Earthing

- a) The continuity of earthing and resistance of each earth pit and grid shall be measured with earth megger.
- b) Checking earth grids for size, continuity and connections
- c) Checking size and continuity of earth connections from grid to each equipment

	ELECTRICAL & INSTRUMENTATION SUPPLY CUM ERECTION WORKS TECHNICAL SPECIFICATION ELECTRICAL WORKS (SUPPLY & ERECTION)	PC183/E/8003/SecVI-2.0	0	
		Document No.	Rev	
		Sheet 104 of 109		

- d) Measurement of connections to earth at equipment which are likely to have highest earth resistance
- e) Measurement of earth loop impedance for checking the operation of protective devices in case of earth fault.

1.9.10 Miscellaneous Equipment



Under this are included, exhaust fans, blowers, limit switches, vibrators, electro-magnets, air pressurization unit etc. The following tests shall be conducted.

- a) Measurement of insulation resistance
- b) Check up the direction of rotation.
- c) Operational test

1.9.11 Motors

1.9.11.1 General Checks

- a) Check the alignment of motor with the driven equipment.
 - b) Check and calibrate meters, safety switches, bearings/air temperature indicators, winding temperature indicators, lubricating oil pump motors etc. as applicable.
 - c) Check operation of space heaters.
 - d) For motor standing idle for a long time, carry out overhauling, re-greasing and drying.
- 1.9.11.2 Check the condition of grease in bearings and if required, replace completely with fresh grease after proper cleaning of bearings. This work shall preferably be taken up before final alignment of motor with driven equipment.
- 1.9.11.3 In case of oil lubricated bearings, the bearing housing shall be flushed with oil and then filled up to the specified level. Check that oil ring rotates freely along with rotor. In case of pedestal type journal bearing, it shall be necessary to open the top cover, and check the bearings.
- 1.9.11.4 Fix up all accessories like tacho-generators, water pressure relay, temperature detectors and any other safety switches after calibration.
- 1.9.11.5 Check that the shaft rotates freely. This shall be done after decoupling the motor from driven equipment.
- 1.9.11.6 Check air gap between rotor and stator (wherever possible) at three places at 120° apart on both sides of drive and verify with the figures furnished by the manufacturers. The variation shall not exceed 10% of average value.
- 1.9.11.7 Check the tightness of foundation bolts. Ensure pins are fitted before commissioning of motor.
- 1.9.11.8 Check that power and control cables are properly connected and tightened. All earth connections of the machine shall be checked.
- 1.9.11.9 In case of forced ventilated motor, clean the ventilation duct. Ensure that recommended flow and pressure of air is available to produce the required cooling effect. If the motor is provided with air to water heat exchanger, check for the adequate flow of water. If necessary, clean the exchanger to remove any obstruction to water flow. Check that there is no leakage from water cooler, pipe connections.
- 1.9.11.10 Check the space heater circuit. Space heaters shall be provided on all HT motors and LT motors rated 30KW & above. Switch on space heater supply at least one week before the commissioning of motor. Wherever drain plugs are provided in motor body, open and check for water accumulation inside motor.
- 1.9.11.11 Testing

	ELECTRICAL & INSTRUMENTATION SUPPLY CUM ERECTION WORKS TECHNICAL SPECIFICATION ELECTRICAL WORKS (SUPPLY & ERECTION)	PC183/E/8003/SecVI-2.0	0	
		Document No.	Rev	
		Sheet 105 of 109		

- a) Insulation resistance test - The insulation resistance of LT motors shall be measured between the winding of the machine and its frame by means of 500/1000V megger. A minimum value of 1 MΩ for 415 V motors shall be considered a safe value.
- b) However, it is desirable that before commissioning the motors, the insulation resistance shall be improved substantially above the lower limits. The contractor shall carry out heating of winding as per the advice of the owner/engineer-in-charge.

1.9.11.12 Drying

- a) Blowing hot air
- b) Placing heater or lamps around and inside, in case of small motors after making suitable guarding and covering arrangement so as to conserve the heat.
- c) Heating by injecting low voltage in the winding (low voltage output of welding set may be used). The winding shall be inter-connected so that current flows through each phase, and particular care shall be exercised to prevent local overheating. The voltage applied shall be suitably adjusted. The maximum temperature of winding, while drying, shall be 70o to 80oC by thermometer or 90o to 95oC by resistance method. Heating shall be done slowly, first till steady temperature of winding is reached (may be within 4 to 8 hours depending upon size of motor). Once the steady temperature is reached, maintain it for some time.
- d) Check the insulation resistance which will drop first and then become steady. Hourly reading of IR shall be taken and temperature shall be recorded 1/2 hourly. If IR is reasonably steady, supply can be switched off. Measure the IR under cold condition. Never keep the motor unattended during drying process.
- e) For checking polarization index of HT motor, note IR value after 1 minute & 10 minute, the ratio shall be compared with data supplied by manufacturer, these shall not be less than 2.5.

1.9.11.13 Operational Test

- a) Check control gear and set the protective relays as per settings supplied by Consultant. It is preferable that before first no-load run, the settings may be kept lower than 100%. However, during load running, settings shall be restored to Normal. Simulation test shall be conducted on motor starter, circuit breaker (main fuses removed on CB at test position). All interlock shall be incorporated in the control system. Testing shall be done from local and remote control station and shall be ensured that the control system works satisfactorily. In case of any defect in the integrated control wiring the contractor shall locate and rectify such defects.
- b) Any other tests recommended by the manufacturer for special type equipment like variable speed motors etc. shall be done.



1.9.11.14 No-load Test

Finally the motor shall be started on no load after decoupling. Check the direction of rotation and change if required. The motor shall be run for 8 to 10 hours. Voltage, starting current, and starting time shall be noted. Hourly reading of current, winding and bearing temperature, (for small motors body temperature to be measured by thermometer) shall be noted. Note vibration, excessive noise if any. In case of variable speed motor, variation of speed shall be checked and regulation of speed noted.

- 1.9.11.15 After switching off the motor, the insulation resistance shall be measured under hot and cold condition.

- 1.9.11.16 If the no-load trial run is found satisfactory, the motor shall be run on load after adjusting the protective relay setting to 100% value. Note the starting time, load current, winding temperature etc. The temperature rise should not be more than the specified value. Check for any excessive vibration or noise.

1.9.12 Installation of Battery bank

	ELECTRICAL & INSTRUMENTATION SUPPLY CUM ERECTION WORKS TECHNICAL SPECIFICATION ELECTRICAL WORKS (SUPPLY & ERECTION)	PC183/E/8003/SecVI-2.0	0	
		Document No.	Rev	
		Sheet 106 of 109		



- 1.9.12.1 Installation, Testing & commissioning of Ni-Cd Battery bank in two tier/ multi-tier arrangement complete with stands, stand insulators, connectors etc., excluding cable termination but including handling, transportation from owner's stores / storage yard to erection site, unpacking, inspection, levelling, aligning, fixing of stands in position, placing of cells / groups of cells in position on stands in proper sequence and order, aligning, making intercell, inter-row, inter tier connections, charging, discharging and recharging for capacity test, all work, labour and materials complete as drawings and documents, specifications codes and standards and direction of consultant / owner / OEM guidelines.
- 1.9.12.2 Installation of new battery bank shall be in party's scope: This includes but not limited to assembly of stands, placing it on insulators, Installing and arranging new cells in Double Row Double Tier configuration, Fixing Inter Row Inter Tier connectors, Filling of Electrolyte, Applying jelly on terminals etc. This should be done as per the OEM standard procedure.
- 1.9.12.3 Commissioning of new Battery Bank: Commissioning should be done as per standard procedure of OEM. The required battery charger and resistance bank for battery discharging shall be in party's scope. The necessary manpower required for the commissioning of battery bank shall be in party's scope.
- 1.9.12.4 The vendor shall ensure min. 3 Charge and 2 Discharge cycles (Capacity verification) for the new battery bank and shall follow the instructions of the OEM and Engineer in charge.
- 1.9.12.5 Party shall arrange the necessary tools such as Hydrometer, multimeter, reading sheets and all kind of spanners and safety equipments etc. at site.
- 1.9.12.6 Acceptance of battery bank: When parameters of all cells are in acceptable range the battery bank shall be taken in to service as per the battery OEM guidelines.

1.9.13 Installation Battery Charger

- 1.9.13.1 The installation of the battery charger shall be carried out as per the guidelines and under the supervision of the OEM representative and Engineer in charge.
- 1.9.13.2 The job includes but not limited to Installation, Testing & Commissioning of sheet steel enclosed, free standing, floor mounting, cubicle type, including transportation from the owner's store to the site of erection, assembly, mounting, and inter panel wiring as necessary at site.
- 1.9.13.3 All inter bus bar joining and panel earthing at two points shall be carried out at site.
- 1.9.13.4 Installation on foundation including leveling and aligning, supply of foundation nuts and bolts, drilling of gland plates with requisite holes, fixing of cable glands supplied loose, plugging of all unused cable entries and other holes found in boards for making the same dust and vermin proof with all labour and materials to make the installation complete as per approved drawings technical specifications and direction of engineer-in-charge shall be in vendors scope
- 1.9.13.5 Job shall also include rigidly fixing the frame including grouting, with minor civil work if necessary.

1.10 DOCUMENTATION

- 1.10.1 For the purpose of completion certificate, the following documents will be deemed to form completion document:
- The technical documents according to which the work was carried out.
 - Final check-list and completion report.
 - Commissioning Reports of all Equipment along with Testing Reports

	ELECTRICAL & INSTRUMENTATION SUPPLY CUM ERECTION WORKS TECHNICAL SPECIFICATION ELECTRICAL WORKS (SUPPLY & ERECTION)	PC183/E/8003/SecVI-2.0	0	
		Document No.	Rev	
		Sheet 107 of 109		

- 1.10.2 Three sets of construction drawings showing therein the modifications and correction made during the course of execution signed by Owner/Engineer-in-charge.
- 1.10.3 Test certificates for the materials purchased by Contractor.
- 1.10.4 Material appropriation statement for the materials issued by Owner for the works and list of surplus materials returned to Owner's stores duly supported by necessary documents.
- 1.10.5 No claim certificate by the Contractor certifying that the entire work done by him under the contract has been measured & accepted for the final bill to his satisfaction and that he will have no claim(s) concerning any work(s) or part thereof performed by him under the Contract, to Owner except otherwise indicated in the final bill.
- 1.10.6 The completion certification shall be issued by Owner within 30 days of the Contractor furnishing documents listed in this clause jointly certified by Owner/Engineer-in-charge and Contractor's Site Engineer.



1.11 HANDING OVER TO OWNER

- 1.11.1 The contractor shall hand over the complete installation as a whole. Minor works not specified or mentioned in the scope or SOR but required to complete the job as a whole will have to be done by the contractor without extra cost. Any equipment/installation shall not be deemed as handed over to Owner until the same is complete in all respect and is accepted in writing by the Owner/Engineer-in-charge.
- 1.11.2 The final acceptance of the work shall be after the demonstration of guarantees by the Contractor. Owner shall issue the final acceptance/taking over certificate upon fulfillment of the guarantees.
- 1.11.3 The complete Installation shall be guaranteed by the Contractor for minimum one year against any bad workmanship or defective material supplied by them.

1.12 OBLIGATIONS & RESPONSIBILITIES OF CONTRACTOR



The contractor's obligations and responsibilities shall include but not limited to the following:

- 1.12.1 To deploy skilled, semi skilled and unskilled personnel in requisite numbers and as per scheduled programme so as to complete the WORK as per overall project schedule.
- 1.12.2 To deploy suitably qualified site manager, engineers and supervisors in requisite numbers to assure execution of good quality job as per best engineering practices and to the full satisfaction of Owner/Consultants.
- 1.12.3 Contractor shall submit method statement/work procedure and take approval of same by owner/consultant/engineer in charge prior to execution of work.
- 1.12.4 Safety supervisor shall be deployed at site that monitors safety aspect during the site construction work. Contractor to note that all workers shall use PPE (helmet, safety shoes, hand gloves, goggles, double lanyard safety belt etc. and they shall be medically tested before putting into the job.
- 1.12.5 To prepare detailed planning and execution schedule considering the availability of fronts and materials. This shall be reviewed by Owner/Engineer-in-charge and Contractor shall be required to keep updating the same (as per the instructions of Owner/Engineer-in-charge) to take care of any changes in the availability of fronts and materials and to complete all jobs as per the overall project schedule. Owner/Engineer-in-charge shall in no way be held responsible for such changes.
- 1.12.6 To check for quantity compliance between bill of materials and drawings for cable, structural, earthing materials etc. and intimate Owner/Engineer-in-charge sufficiently in advance regarding discrepancies, if any.
- 1.12.7 Construction power shall be made available at one point. Arrangement for distributing the same to various area for construction shall be the contractor's responsibility.

	ELECTRICAL & INSTRUMENTATION SUPPLY CUM ERECTION WORKS TECHNICAL SPECIFICATION ELECTRICAL WORKS (SUPPLY & ERECTION)	PC183/E/8003/SecVI-2.0	0	
		Document No.	Rev	
		Sheet 108 of 109		

- 1.12.8 To arrange all required tools and tackles, consumables, instruments, erection materials & machineries etc. for handling erection, testing & commissioning of complete electrical installation.
- 1.12.9 To arrange and supply storage tanks for drinking water so as to avoid any inconvenience that may be caused due to interruption in water supply at times.
- 1.12.10 To provide proper storage and security arrangements for his tools, tackles, equipments, materials etc. as well as equipment and materials issued by Owner/Engineer-in-charge to Contractor. Owner/Engineer-in-charge shall not be responsible for any loss or damage to items in the custody of Contractor at site for any reason whatsoever.
- 1.12.11 Completion of all repairs arising out of defective work done by Contractor, Owner/Engineer-in-charge may at his discretion require the Contractor to rectify certain defects in materials caused due to bad workmanship of supplier and/or during transportation.
- 1.12.12 The contractor shall be fully responsible for any accident to their personnel. Required insurance of workmen shall be as per the norms and rules.
- 1.12.13 To maintain all the records for men, materials and execution of job as required by law as well as Owner/Engineer-in-charge.
- 1.12.14 To get his work inspected by Owner/Engineer-in-charge and get approved from statutory agencies such as but not limited to Electrical Inspector, Factory Inspector etc.
All co-ordination with Statutory Authorities shall be contractor's responsibility. Only statutory fee required for approval shall be paid by the owner.
- 1.12.15 To make arrangements for services such as transport, medical, lighting, canteen etc. for working round the clock.
- 1.12.16 In addition to safety regulations indicated in this enquiry, Owner/Engineer-in-charge may issue certain safety directives, which shall have to be followed meticulously without any reservation.
- 1.12.17 To undertake and execute work and supply as per scope of work, scope of supply and follow Technical Conditions including specification for electrical erection, specification for electrical testing and commissioning and as per schedule of rates
- 1.12.18 Reconciliation of all materials issued by owner/supplied by contractor.
- 1.12.19 Handing over of the completed works to owner/engineer-in-charge as per procedure laid down by Consultant.
- 1.12.20 To submit documentation forming part of request for issue of completion certificate.
- 1.12.21 Clearing the site after cleaning the areas where the Contractor executed the job, stored the materials and built his office, fabrication shop etc.
- 1.12.22 Contractor shall be responsible for good Housekeeping of his area of scope of work.
- 1.12.23 The contractor shall be responsible for shifting of the defective material to scrap yard or any other place which will be shown by owner for clearing the sites.
- 1.12.24 Disposal of packing material after unpacking of equipment/material in contractor's scope of work at designated location.
- 1.12.25 The contractor shall make their own arrangement of Lodging and boarding and transportation of their manpower for working at site during installation and commissioning of all the Equipment.
- 1.12.26 Contractor shall submit site organization chart with mobilization plan.



1.13 SAFETY MEASURES

	ELECTRICAL & INSTRUMENTATION SUPPLY CUM ERECTION WORKS TECHNICAL SPECIFICATION ELECTRICAL WORKS (SUPPLY & ERECTION)	PC183/E/8003/SecVI-2.0	0	
		Document No.	Rev	
		Sheet 109 of 109		

- 1.13.1 Contractor shall not undertake any work within the Battery Limits of the plants, unless proper and valid safety permit is obtained.
- 1.13.2 Contractor shall have to observe all the safety practices as required and shall provide safety wear for his workmen. Contractor and his employees should observe all safety regulations within factory area as directed by owner's safety department from time to time.
- 1.13.3 Supervisor appointed at site must be experienced and qualified for the jobs to be carried by the contractor as per the scope mentioned above.
- 1.13.4 Workman's experience, age, address, character and medical fitness certificate need to be certified by the contractor before starting the job.
- 1.13.5 All persons must take safety training from safety dept. before starting the job.
- 1.13.6 All the jobs are to be performed / carried out in the running plant. The bidder shall take at most care and follow the safety guidelines issued by the engineer in charge.
- 1.13.7 Party must make following min. safety appliances available to their workman at job site.
- a) Helmet
 - b) Safety Shoes
 - c) Ear plugs
 - d) Hand gloves
 - e) Safety Goggles
 - f) positive air mask with life line (if required)
 - g) Boiler/Fire protection suit.

1.14 INSURANCE OF STAFF

- 1.14.1 The Contractor will be responsible for the insurance of his supervisory, skilled and unskilled staff under the workmen's compensation Act 1923, 1933 and subsequent amendment if any, thereon. The Contractor should produce copies of insurance of his staff for verification.
- 1.14.2 The Owner assumes no responsibility for any damages due to accidents or any other cause to the erection of equipment or persons employed by the Contractor.
- 1.14.3 The Contractor shall ensure that the person or person appointed by them for service in the company's premises do not suffer any legal disqualification for service by reason of his age or any law and statute in force from time to time of any other reason whatsoever.
- 1.14.4 The employee of the contractor shall be liable to search by company's security forces.
- 1.14.5 If the Engineer-In-Charge is not satisfied with the service or conduct of any of the employee of the contractor for any reason whatsoever, the contractor shall remove such employees from the company's premises.
- 1.14.6 No. employee of the contractor shall be allowed to stay on the premises of the company beyond authorized working hours.

	TALCHER FERTILIZERS LIMITED TECHNICAL SPECIFICATION - PA SYSTEM	PC183-TS-0801	0	
		Document No.	Rev	
		Sheet 1 of 7		

TECHNICAL SPECIFICATION

PUBLIC ADDRESS SYSTEM



TALCHER FERTILIZERS LIMITED
TECHNICAL SPECIFICATION - PA SYSTEM

PC183-TS-0801

0

Document No.



Rev

Sheet 2 of 7



CONTENTS

SECTION NUMBER	DESCRIPTION
1.0	SCOPE
2.0	STANDARDS TO BE FOLLOWED
3.0	SERVICE CONDITIONS
4.0	OPERATIONAL REQUIREMENTS
5.0	TECHNICAL REQUIREMENTS
6.0	POWER SUPPLY
7.0	CABLES
8.0	CABLING
9.0	JUNCTION BOXES
10.0	EARTHING
11.0	ERECTION AND COMMISSIONING
12.0	DRAWINGS AND DOCUMENTS
13.0	SPARES
14.0	PACKING
15.0	DEVIATIONS
ANNEXURE - I	DOCUMENTION FOR PUBLIC ADDRESSSS SYSTEM

	TALCHER FERTILIZERS LIMITED TECHNICAL SPECIFICATION - PA SYSTEM	PC183-TS-0801	0	
		Document No.	Rev	
		Sheet 3 of 7		

1.0 SCOPE

- 1.1 This standard covers the technical requirements of design, manufacture, testing, delivery installation at site and commissioning of Public Address System along with all accessories.
- 1.2 This standard shall be read in conjunction with relevant part of Design Philosophy - Electrical.

2.0 STANDARDS TO BE FOLLOWED

- 2.1 The design, manufacture and testing of public address system and their accessories covered by this standard shall comply with the latest issue of the following and other relevant Indian Standards Equipment complying with equivalent IEC standards shall also be acceptable.

- IS: 1881 - Code of practice for installation of indoor amplifying and sound distribution systems.
- IS: 1882 - Outdoor installation of public address system-code of practice.
- IS: 1301 - Code of safety requirements for electric mains-operated audio amplifiers.
- IS: 8061 - Code of practice for design, installation and maintenance of service lines up to and including 650 V.
- IS: 3043 - Code of practice for earthing.
- IS: 1490 - Recommendation for minimum performance requirements of mains-operated public address amplifiers.
- IS: 1819 - Recommendation for general requirements of public address amplifiers.
- IS: 1031 - Methods of measurements of loudspeakers and loudspeaker systems.
- IS:1554 (Part1) - PVC insulated (heavy duty) electric cables for working voltages up to and including 1100 V.
- IS: 694 - PVC insulated cables for working voltage up to and including 1100 volts.
- BS: 2004 - Electric cables for working voltage up to and including 1100 volts.



- 2.2 The design and operational features of all the equipments offered shall comply with the provisions of the latest issue of the Indian Electricity Rules and other Statutory Acts and Regulations. The supplier shall, wherever necessary, make suitable modifications in the equipment to comply with the above.

- 2.3 Wherever any requirement, laid down in this standard, differs from that in Indian Standard specifications, the requirement specified herein shall prevail.

3.0 SERVICE CONDITIONS

3.1 Ambient Conditions

These shall be as indicated in Design Philosophy – Electrical / Technical Specification – Electrical.

	TALCHER FERTILIZERS LIMITED TECHNICAL SPECIFICATION - PA SYSTEM	PC183-TS-0801	0	
		Document No.	Rev	
		Sheet 4 of 7		

3.2 **System Details**
These shall be as indicated in Design Philosophy – Electrical / Technical Specification – Electrical.

4.0 OPERATIONAL REQUIREMENTS

The public address system and their associated accessories shall be suitable for operating continuously under the ambient conditions and with the voltage and frequency variation without exceeding temperature rise limits as per relevant standards and without detrimental effect on any part.

5.0 TECHNICAL REQUIREMENTS

5.1 The public address system shall be microprocessor based, non-EPABX distributed amplifier type. It should be designed for communication between various process units and office areas of an industrial plant and various control room(s).

5.1.1 The band width of the communication system shall not be less than 9 KHz for intelligible speech reproduction required for industrial environment.

5.1.2 The system shall comprise of:

- i) Microprocessor based central exchange
- ii) Master control station(s)
- iii) Field stations and junction boxes, if any
- iv) Power supply unit
- v) Cables
- vi) Loudspeaker

5.1.3 All other items not specifically mentioned, but required for the completeness of the system shall be supplied.

5.2 Microprocessor based central exchange

5.2.1 The exchange shall be rack mounted microprocessor controlled. It should be designed such that future extensions or modification can be easily carried out.

5.2.2 The actual control of communication shall be from the exchange. From the exchange, various system information and data shall be acquired, processed and communication links between stations shall be established as per user requirement through master control station.

5.2.3 The exchange shall be 100% redundant in hot standby mode. The exchange shall have facility for hooking up with the existing EPABX system. It shall have two independent lines of communication viz. page & party.



5.3 Master control stations (MCS)

5.3.1 The MCS shall be desk mounted type and shall comprise of a keyboard with LEDs, a built-in loudspeaker and a built-in dynamic noise cancelling goose neck microphone. It should have facility for duplex mode of communication.

5.3.2 The MCS shall have a key to initiate an EPABX call and should have facility to receive EPABX call.

5.3.3 The MCS shall have features to initiate the following type of call:

- i) All call
- ii) Alarm call

	TALCHER FERTILIZERS LIMITED TECHNICAL SPECIFICATION - PA SYSTEM	PC183-TS-0801	0	
		Document No.	Rev	
		Sheet 5 of 7		

- iii) Conferencing
- iv) Inter MCS call
- v) Call from MCS to field station & vice-versa
- vi) Global call
- vii) Call from field station of one MCS to field station another MCS

5.3.4 The MCS shall have drop out facility i.e. after connecting two field stations, the MCS, if required, may drop out of the ongoing conversation. Priorities shall be assigned to the various calls (Alarm & Global) shall have higher priority than other calls.

5.4 **Field Station**

5.4.1 It shall be of cast aluminium (LM-6) / FRP / GRP enclosure and shall consist of adequate capacity amplifiers (Minimum 25 W) for page channel, preferably telephone type handset & cradle switch, Twin keys & keypad and all other necessary control switches & push buttons required for satisfactory operation of the system. Each FCS shall be provided with inbuilt 25 W Amplifier..

5.4.2 Handsets shall be completely factory wired up to terminal blocks and shall be provided with cable termination accessories for connecting external cables.

5.4.3 The field stations shall be suitable for hazardous area classification defined as zone I/II, gas group IIA/IIB/IIC & temperature class T3. All master control station shall be suitable for outdoor installation with IP-65 protection.

5.5 **Loudspeaker (LS)**

5.5.1 Loudspeaker shall be highly efficient, high power driver unit designed for non-ringing to deliver clear reproduction. The driver unit shall be lockable type to avoid pilferage.

5.5.2 Loudspeaker shall be provided with impedance matching transformer. Transformer shall have the minimum "frequency characteristic" required for public address system.

5.5.3 Loudspeaker for indoor mounting shall be direct radiator, permanent magnet moving coil type rated for 6W/15W. However, loudspeaker for outdoor mounting and in areas with high ambient noise level shall be pressure unit operated, projector or horn type, weatherproof, rugged die-cast aluminium / GRP construction rated for 25W with Minimum 3 Nos. of Tapping. Outdoor speakers shall be of MEDC/Eaton/DNH Make. Indoor speakers shall be of IC Audio / DNH Make.

6.0 **POWER SUPPLY**

6.1 Power supply single phase, 240 V, 50 Hz and further distribution shall be arranged by the vendor.



6.1.1 DC supply, if required, shall be arranged by the vendor from the dedicated power supply unit working on single phase 240 V, 50 Hz supply.

6.1.2 The system shall be provided with UPS of eight hour back-up and the battery used shall be Nickel-Cadmium type.

7.0 **CABLES**

7.1 Signal and loudspeaker cables shall have annealed tinned copper, twin twisted & colour coded, PVC sheathed, GI round wire armoured and PVC overall sheathed. Loudspeaker cables shall be of 24 / 0.2 mm copper and signal cable shall be of 16 / 0.2 mm copper.

7.1.1 For power cables, 3 core 2.5 sq. mm annealed tinned copper, PVC insulated armoured cables are required.

	TALCHER FERTILIZERS LIMITED TECHNICAL SPECIFICATION - PA SYSTEM	PC183-TS-0801	0	
		Document No.	Rev	
		Sheet 6 of 7		

7.1.2 The bidder shall indicate the details & quantity of cables required in tabular form.

8.0 CABLING

The contractor shall supply, lay & connect at both ends all the cables with accessories. The cables shall be accommodated in the existing overhead cable racks / structures as far as possible; where racks are not available, the cables shall be laid underground by using GI protection pipes.

9.0 JUNCTION BOXES

The junction boxes shall be of die cast aluminium powder coated. These shall be complete with inspection cover, conduit glands and terminal stripes. The cover shall be gasketed to make it dust & vermin proof and IP-55 protection. Holes for screwing the covers shall have stainless steel inserts.

10.0 EARTHING

All the equipment and their associated accessories of public address system shall be provided with earthing terminals and shall be connected to the ground mat by vendor as per relevant Indian Standard.

11.0 ERECTION & COMMISSIONING

The bidder shall include complete, testing & commissioning along with fittings & accessories in their scope. Good engineering practice in conformity with latest Indian Standard & code of practice shall be followed for erection & commissioning of all the accessories of public address system.

12.0 DRAWINGS AND DOCUMENTS

12.1 Drawings and documents as per Annexure-I shall be supplied unless otherwise specified.

12.2 All drawings and documents shall have the following description written boldly.

- i) Name of client
- ii) Name of consultant
- iii) Enquiry / order number with plant / project name
- iv) Equipment Code no. and Description

13.0 SPARES

13.1 Commissioning Spares : Commissioning spares, as required, shall be supplied with the main equipment. Item-wise list of recommended commissioning spares shall be furnished for information.

13.2 Spares for 2 Years Operation (Mandatory), as specified shall be supplied.

13.3 List of Recommend Spares (other than Mandatory Spares) alongwith recommended quantity shall be furnished.

13.4 All spare parts shall be identical to the parts used in the equipment

14.0 PACKING

The public address system shall be properly packed to safeguard against weather conditions and handling. It shall be wrapped in polythene bag with an additional wrapping of bitumen paper to make it completely waterproof before the equipment is packed in wooden crates.

ANNEXURE - I

DOCUMENTATION FOR PUBLIC ADDRESS SYSTEM

Sl. No.	Documentation	Documents Required (Y / N)		
		With Bid	For Approval	Final
1.	Guaranteed technical particulars	N	Y	Y
2.	Outline drawing showing dimensions and other details.	N	Y	Y
3.	Complete assembly drawings of equipments showing plan, elevation and cross section.	N	Y	Y
4.	Schematic of field stations of each type.	N	Y	Y
5.	Cable schedule with complete layout drawings	N	Y	Y
6.	Illustrative and descriptive catalogues	N	N	Y
7.	Installation, operation & maintenance manual	N	N	Y
8.	Quality assurance program	N	N	N
9.	Type test certificate for			
	i) Hose proof items	N	N	Y
	ii) Flame proof items	N	N	Y
10.	Test certificates	N	N	Y
11.	Guarantee certificates	N	N	Y

Note:

1. 4 hard copies & 1 soft copy shall be supplied for approval after order within 4 weeks from the date of LOI.
2. 8 hard copies & 2 soft copies in CD shall be submitted as final documents prior to despatch of the equipment. These shall be made in sets and supplied in fine plastic coated folder.

Y - Yes, N - No

 पी डी आई एल PDIL	TALCHER FERTILIZERS LIMITED TECHNICAL SPECIFICATION – POWER TRANSFORMER	PC183-TS-0803	0	 Talcher Fertilizers
		Document No.	Rev	
		Sheet 1 of 24		



TECHNICAL SPECIFICATION

POWER TRANSFORMERS



CONTENTS

SECTION NUMBER	DESCRIPTION
1.0	SCOPE
2.0	STANDARDS TO BE FOLLOWED
3.0	SERVICE CONDITIONS
4.0	OPERATING REQUIREMENTS
5.0	GENERAL DESIGN FEATURES
6.0	CONSTRUCTIONAL FEATURES
7.0	FITTINGS
8.0	PAINTING
9.0	TESTS AND INSPECTION
10.0	DRAWINGS AND DOCUMENTS
11.0	SPARES
12.0	PACKING
ANNEXURE - I	LIST OF FITTINGS
ANNEXURE - II	DOCUMENTATION FOR TRANSFORMERS

	TALCHER FERTILIZERS LIMITED TECHNICAL SPECIFICATION – POWER TRANSFORMER	PC183-TS-0803	0	
		Document No.	Rev	
		Sheet 3 of 24		

1.0 SCOPE

- 1.1 This standard covers the technical requirements of design, manufacture, testing at works and despatch in well-packed condition of Power Transformers.
- 1.2 This standard shall be applicable for 3 phase, core type, separate winding power transformers of rating 315 KVA and above.
- 1.3 This standard shall be read in conjunction with the relevant part of Design Philosophy – Electrical.

2.0 STANDARDS TO BE FOLLOWED

- 2.1 The design, manufacture and testing of the equipment covered by this standard shall comply with the latest issue of IS 2026, unless otherwise specified. Equipment complying with equivalent IEC standards shall also be acceptable.
- 2.2 The design and operational features of the equipment offered shall comply with the provisions of the latest issue of the Indian Electricity Rules and other relevant Statutory Acts and Regulations. The supplier shall, wherever necessary, make suitable modifications in the equipment to comply with the above.
- 2.3 Wherever any requirement, laid down in this standard, differs from that in Indian Standard Specifications, the requirement specified herein shall prevail.

3.0 SERVICE CONDITIONS

3.1 Ambient Conditions

These shall be as indicated in Design Philosophy – Electrical.

3.2 System Details



These shall be as indicated in Design Philosophy – Electrical.

4.0 OPERATING REQUIREMENTS



- 4.1 The transformer shall be suitable for operating at the rated capacity continuously at any of the taps, under the ambient conditions and with the voltage and frequency variations without exceeding the permissible temperature rise and without any detrimental effect on any part.
- 4.2 The transformer shall also be capable of delivering rated current at a voltage equal to 105 % of the rated voltage.
- 4.3 The maximum flux density in any part of the core and yoke at the rated MVA, voltage and frequency shall be such that under 10 per cent continuous over voltage condition it does not exceed 1.9 Tesla at any tap position.
- 4.4 The transformer shall be capable of allowing at least three consecutive starts of the largest Squirrel Cage Induction Motor, while delivering 85% of its rated power without any harmful effect on its insulation. It shall be possible to repeat the starting cycle once in eight hours.
- 4.5 The transformer shall be designed to be loaded as per IS 6600.
- 4.6 The transformer shall be so designed as to operate in parallel satisfactorily with similar transformers.

5.0 GENERAL DESIGN FEATURES

- 5.1 Transformers shall be built under strict quality assurance procedures to comply with IEC 60076 and or IEC 60726.
- 5.2 Transformers shall be suitable for continuous operation at full load for at least 30,000 hours without maintenance requiring the transformer to be de-energized
- 5.3 The design of the transformers shall be in accordance with the latest practice.
- 5.4 **Rated Voltage, Frequency and Phase Connection**
These shall be as indicated in Design Philosophy – Electrical.

	TALCHER FERTILIZERS LIMITED TECHNICAL SPECIFICATION – POWER TRANSFORMER	PC183-TS-0803	0	
		Document No.	Rev	
		Sheet 4 of 24		

- 5.5 The transformer shall be so designed that it is capable of operation at 125% rated voltage for a period of one minute and 140% rated voltage for a period of five seconds due to sudden load throw off.
- 5.6 Transformer shall be capable of withstanding thermal and mechanical stresses caused by symmetrical or asymmetrical faults on any winding.
- 5.7 Transformers shall withstand, without injurious heating, combined voltage and frequency fluctuations which produce the following over fluxing conditions:
- 110% for continuous operation
 - 125% for 1 - minute
 - 140% for 5 – seconds
- 5.8 **Tap Changing Gear**
- 5.8.1 Each transformer shall be provided with on-load/ off-circuit tap changing equipment on the high voltage winding with taps. It shall be mounted on one side, in an easily accessible position.
- 5.8.2 The range of tap changer shall be as indicated and arranged in steps of 2.5%.
- 5.8.3 The off-circuit tap changing shall be affected by an externally operated handle capable of being padlocked in any position and provided with tap position indicator and mechanical stops at the extreme positions.
- 5.8.4 For transformer specified with on-load tap changer, tap changing gear shall be complete with tap position indicator, limit switch, lock and key and necessary control panel. Provision shall be made for auto-manual operation. The manual operation shall be possible both from the panel as well as from field. In case the tap changer is located in a separate housing, the housing shall be connected with the conservator for oil connection. A separate buchholz relay shall be provided in such a case. Emergency mechanical manual device shall also be provided. A minimum of 2 lakh trouble-free operations shall be considered.
- 5.9 **On-Load Tap-Changing Mechanism (O.L.T.C.)**
- 5.9.1 For transformer specified with on-load tap changer, high speed tap changing gear shall be complete with tap position indicator, limit switch, lock and key and necessary control panel. Provision shall be made for auto-manual operation. In case the tap changer is located in a separate housing, the housing shall be connected with the conservator for oil connection. A separate buchholz relay shall be provided in such a case. Emergency mechanical manual device shall also be provided. A minimum of 2 lakh trouble-free operations shall be considered. The OLTC gear shall have diverter resistance and the current diverting contacts shall be housed in a separate oil chamber segregated from the main tank of the transformer.
- 5.9.2 Transformer shall be provided with an on-load tap changing mechanism, as required. This shall be designed suitable for remote control operation from switch boards in the control room in addition to being capable of local manual as well as local electrical operation.
- 5.9.3 It shall not be possible to use the electric drive when manual gear is in use and it shall be possible to use only one electrical control at a time. Operation of the local or remote control switches shall cause one tap movement only until the control switch is returned to the off position for the next operation.
- 5.9.4 The local electrical control switches shall be mounted in the outdoor cubicle.
- 5.9.5 The equipment shall be so arranged as to ensure that when a tap change operation has been commenced it shall be completed independently of the operation of the control relays and switches. If a failure of the auxiliary supply during a tap change or any other contingency result in that movement not being completed, adequate means shall be provided to safeguard the transformer and its auxiliary equipment from damage. Supervisory indication shall be provided to indicate “The change incomplete” foul.

	TALCHER FERTILIZERS LIMITED TECHNICAL SPECIFICATION – POWER TRANSFORMER	PC183-TS-0803	0	
		Document No.	Rev	
		Sheet 5 of 24		

- 5.9.6 Limit switches may be connected in the control circuit of the operation motor provided that a mechanical de-clutching mechanism is incorporated. Otherwise it shall be directly connected to the operating motor circuit and mechanical stop provided.
- 5.9.7 Thermal devices or other means shall be provided to protect the motor and control circuits. All relays switches, fuses etc. shall be mounted in the marshalling box and shall be clearly marked to indicate their purpose.
- 5.9.8 The whole of the apparatus shall be of robust design and capable of giving satisfactory service without undue maintenance under the conditions to be met in service, including frequent operation.
- 5.9.9 A five-digit counter shall be fitted to the tap changing mechanism to indicate the number of operations completed by the equipment.
- 5.9.10 A permanently legible lubrication chart shall be fitted within the driving mechanism chamber.
- 5.9.11 The On-Load Tap Changer shall include the following :-
- a) An oil immersed tap selector and arcing switch or arc-suppressing tap selector, provided with resistor for reduction of make and break arcing voltage, overload and short circuits.
 - b) Motor driven mechanism.
 - c) Control and Protection devices.
 - d) Local and remote tap-changer position indicator.
 - e) Manual operating device.
- 5.9.12 The on-load tap changer shall be designed so that the contacts shall not interrupt arc within the main tank of the transformer. The tap selector and arcing switch or arc suppressing tap selector switch shall be located in one oil filled compartment. The compartment shall be provided with a means of releasing the gas produced by the arcing. It shall be designed so as to prevent the oil in the tap selector compartment from mixing with the oil in the transformer tank.
- 5.9.13 The oil in those compartments of the main tap-changing apparatus which do not contain contacts used for making or breaking current shall be maintained under conservator head by means of an adequate diameter pipe corresponding dia of OLTC oil surge relays connection from the highest point of the chamber connection corresponding to the dia. of OLTC oil surge relay from the highest point of the chamber to the conservator. This connection shall be controlled by a suitable valve and shall be arranged so that any gas leaving the chamber will pass into the gas and oil actuated relay.
- 5.9.14 The tap changer shall be capable of permitting parallel operation with other transformers for which necessary wiring and accessories, if any, shall be provided.
- 5.9.15 The centre of manual operating device shall be located :- at a height of 1500 mm from rail top so that it can be operated by a person standing at the ground level. The arrangement shall be strong and robust in construction. The transformer shall give full load output on all tap positions.
- The mechanism shall be complete with normal accessories including at least the following:-
- A mechanical tap position indicator (Rated tap voltages shall be marked on the diagram plate).
 - A mechanical operation counter.
 - Mechanical stops to prevent over cranking of the mechanism beyond extreme tap positions.
- 5.9.16 The control scheme for the tap changer shall be provided for independent control of the tap changers when the transformers are in independent service. In addition, provision shall be made to enable parallel operation control also at time so that the tap changer will be operated simultaneously when one unit is in parallel with another will not become out of step and this will eliminate circulating current.



Additional features like Master / Follower and visual indication during the operation of motor shall also be incorporated.

Control circuit shall incorporate the following:

- a) Local/remote manual electrical operation.
- b) Device to ensure a positive and full completion of tap change once it is initiated even if there is loss of power.
- c) An interlock to cut-off electrical control automatically upon recourse being taken to manual mechanical control in emergency.
- d) Electrical interlock to cut-off a counter impulse for a reverse tap change, being initiated during a progressive tap change and until the mechanism comes to rest and resets circuits for a fresh operation.
- e) All auxiliaries and devices for electrical control of OLTC gear should be housed in a weather-proof cabinet mounted on the transformer and shall include:
 - Local tap position indicator
 - 5 digit operation counter
 - Cubicle lighting
 - Thermostatically controlled space heater.
 - Miniature circuit breaker with magnetic and thermal overload devices for controlling the incoming supply to the OLTC motor.
 - Padlocking arrangement for the hinged cabinet door.
 - Removable plate with cable glands.
 - Inside tag with control scheme indelibly marked.

5.9.17 Necessary interlock, blocking independent control when the units are in parallel, shall be provided.

5.9.18 Under abnormal conditions such as may occur if the contactor controlling one tap changer sticks, the arrangement must be such as to switch off supply to the motor so that an out of step condition is limited to one tap difference between the units. Details of out of step protection provided for the taps should be furnished in the bid.

5.9.19 The contactor and associated gear for the tap change driving motors shall be housed in a local kiosk mounted adjacent to the transformer. The motors shall be suitable for operation on 230 V single phase or 3-phase 440 V, 50 cycle external power supply. The kiosk having space heater, shall be dust and vermin proof and suitable protected against corrosion or deterioration due to condensation, fungi etc.

5.9.20 Indoor cubicle (RTCC panel) shall be provided in the control room which shall contain :

- a) Indication of the transformer ratio in use on each transformer and the number designating the tap in use by means of digital type indicators.
- b) Raise and lower push Button switch and AVR Relay.
- c) Independent/Master/Follower selector switch.
- d) Remote tap position indicator with indicating lamp.
- e) Repeater dial of winding temperature indicator for remote indication with a device for indicating hottest spot winding temperature in addition to a pointer to register the highest temperature reached.
- f) An indication lamp showing tap change in progress.
- g) Necessary audible and visual alarms.
- h) Pressure relief device operation alarm.

	TALCHER FERTILIZERS LIMITED TECHNICAL SPECIFICATION – POWER TRANSFORMER	PC183-TS-0803	0	
		Document No.	Rev	
		Sheet 7 of 24		

- i) Out of step relay with two spare contacts (2 NC and 2 NO).
- j) The remote indoor cubicle in addition to the above indications shall also have the following trip and non-trip alarm windows facias with 5 spare windows suitable for 110V DC supply.
 - i. Oil Temperature alarm
 - ii. Winding Temperature alarm
 - iii. Winding temperature trip
 - iv. Buchholz alarm
 - v. Buchholz trip
 - vi. Sudden Pressure trip (Main tank)
 - vii. Surge Relay trip (OLTC Gear)
 - viii. Tap changer out of step alarm
 - ix. Low oil level alarm
 - x. Cooling fans working indication
 - xi. Oil pumps on and off indication
 - xii. Failure of group of fans alarm
 - xiii. Failure of group of oil pumps alarm
 - xiv. Failure of supply
 - xv. Oil flow alarm

Each relay for tripping function shall have two normally open and two normally closed contacts for connection.

5.9.21 Remote Electrical Group Control

The OLTC control scheme offered shall have provision of remote electrical group control during the parallel operation of transformer. This is in addition to independent control of OLTC:

- i) A four position selector switch having Master, Follower, Independent and Off position shall be provided in the remote OLTC control panel for each transformer.

This shall be wired to enable operator to select operation of OLTC in Master, Follower or Independent mode.

- ii) Out of step relays with timer contacts shall also be provided to give alarm and indication in case tap position in all the transformers under group control are not in same position.
- iii) **Master Position**

If the selector switch is in Master position, it shall be possible to control the OLTC units in the follower mode by operating the controls of the master unit. Independent operation of the units under Follower mode shall have to be prevented. However the units under independent mode will be controlled independently.

- iv) **Follower Position**



If the selector switch is in Follower mode, control of OLTC shall be possible only from panel of the Master unit.

- v) **Independent Position**

In this position of Selector Switch, Control of OLTC of individual unit shall only be possible

5.9.22 The OLTC shall be provided on the conservator side of the Power Transformer and not in front of H.V. Bushings.

5.9.23 OLTC shall be suitable for bi-directional power flow.

	TALCHER FERTILIZERS LIMITED TECHNICAL SPECIFICATION – POWER TRANSFORMER	PC183-TS-0803	0	
		Document No.	Rev	
		Sheet 8 of 24		

5.10 Impedance Voltage

The impedance voltage of the transformer at 75OC shall be as per latest IS 1180. This shall be guaranteed within limits specified in relevant IS / IEC at principal tap position. There shall not be any negative tolerance.

5.11 Losses

The losses at 50 percent of rated load and full load condition, at the rated voltage and frequency shall be indicated by the vendor at 75OC. These shall be guaranteed within the tolerable limits specified in IS:2026 at principal tap position. Owner has the right to impose penalty charges or reject the transformer in case of any difference in the test and guaranteed values.

For upto 2 MVA transformer losses shall be as per energy efficiency level-3 of latest IS 1180.

5.12 Temperature Rise

The temperature rise of the winding, oil and core shall not exceed the values specified in IS: 2026 when the transformer is delivering its rated output continuously under the service conditions.

5.13 Insulation Level

All windings up to maximum system voltage of 72 KV shall have uniform insulation to earth. For windings having higher maximum system voltage, graded insulation is acceptable.

5.14 Terminal Arrangements

The HV and LV side terminal arrangement shall be provided as required. Disconnecting link chambers shall be provided on the transformer primary side in all cases as well as on secondary side, except where the termination is through bus duct. The disconnecting chambers shall be oil filled, preferably connected with the main tank through an isolating valve and also provided with a drain valve. However for system not exceeding 11 KV, air filled disconnecting chamber may be accepted. Suitable cable end box complete with cable glands and lugs shall be provided for termination of cables. Gland plate for single core cables shall be non-magnetic.

5.15 The transformer shall be able to withstand the electro-dynamic and thermal stresses due to terminal short circuit of the secondary, assuming the primary side fed from an infinite bus. All leads and windings in cores shall be properly supported, clamped and tightened after vacuum drying to ensure the short circuit withstand capacity. The short circuit withstand duration shall be 3 Secs.

5.16 The short circuit test results for similar transformers shall be furnished.

5.17 The transformer shall be so designed as to minimise any undue noise and vibration.

The noise level shall be limited to the value specified by latest NEMA Standard / CBIP.

5.18 Due attention shall be given in the design for the suppression of harmonics.

5.19 Cooling System

5.19.1 The cooling system shall be provided as required. In case the transformer is designed for two types of cooling, the output rating for each type shall be indicated in the offer. The minimum acceptable output shall be 70% of rated output when forced type of cooling system is not in operation.

5.19.2 Wherever ONAF Cooling is specified, the cooling fans shall be adequately rated and shall be suitable for auto/manual and local/remote operation. Auto operation shall be through winding temperature indicator contact..

5.19.3 Transformer shall have multiple cooling units with standby cooling units.

5.19.4 Cooling fans for each radiator bank shall be housed in fan box to prevent ingress of rain water. Each fan shall be suitably protected by galvanized wire mesh guard. It shall be possible to remove the cooling fan with motors without disturbing and dismantling the cooler structural frame work.

5.19.5 Where OFAF cooling is applicable, two numbers of centrifugal oil pumps shall be used. Measures shall be taken to prevent mal-operation of Buchholz relay or sudden pressure relay

	TALCHER FERTILIZERS LIMITED TECHNICAL SPECIFICATION – POWER TRANSFORMER	PC183-TS-0803	0	
		Document No.	Rev	
		Sheet 9 of 24		

when all oil pumps are simultaneously put into service. The pumps shall be so designed that on failure of power supply to the pump motor, the pump impeller will not limit the natural circulation of oil.

- 5.19.6 Cooling fans and oil pump motors shall be of squirrel cage, totally enclosed whether proof type suitable for operation on 400 volts, three phase, 50 Hz power supply. All motors having ball and roller bearings and grease lubricators shall be fitted with hexagonal nipples conforming to relevant Indian Standard.
- 5.19.7 An oil flow indicator with alarm contacts shall be provided for the confirmation of the oil pump operating in a normal state. An indication shall be provided on the control panel to indicate that the pump is running.
- 5.19.8 The coolers and theirs accessories shall be hot dip galvanized or corrosive resistant painted.
- 5.19.9 The supporting arrangement for the cooler units or for radiator banks shall be in such a manner that the stresses if developed, shall not be transferred to the flanges of the butterfly valves.
- 5.19.10 The shut off valves shall be provided on the tank at each point of connection of cooler units radiators to the transformer tank. Removable blanking plates shall be provided to permit blanking off the oil connection to cooler radiators.
- 5.19.11 All valves shall be of gun metal or cast steel or may have cast iron bodies with gun metal fittings. They shall be of full way type with internal screw and shall be opened by turning counter clock-wise when facing the hand wheel.
- 5.19.12 Means shall be provided for pad locking of valves in the open and closed position.
- 5.19.13 Every valve shall be provided with indicator to show clearly the position of the valve whether open or closed.
- 5.19.14 All valves shall be provided with flanges having machined faces.
- 5.19.15 The drilling of valve flanges shall comply with the requirements of IS:3639.

5.20 CONTROL OF COOLER OPERATION

- 5.20.1 Each motor or group of motors shall be provided with an electrically operated contactor and with control gear of suitable design both for starting and stopping the motor manually and also automatically from the contacts on the winding temperature indicating device as specified. Additional terminal for remote manual electrical control of motors shall be provided. Overload and single phasing protection shall be provided. HRC fuses shall be provided for short circuit protection. This equipment shall be accommodated in the marshalling box. The power supply shall be adequately and properly fused.
- 5.20.2 Where small motors are connected in groups, the group protection shall be arranged so that it operates satisfactorily in the event of a fault occurring on a single motor.
- 5.20.3 Where fans and oil pumps are provided, the connection shall be arranged as to allow the motors or groups of motors to be started up and shutdown either collectively or individually.
- 5.20.4 All motor contactors and their associated apparatus shall be capable of holding in and operating satisfactorily and without over heating for a period of ten minutes if the supply voltage falls for that period, to 75% of normal value and at normal frequency. The motor contactors and associated apparatus shall be capable of normal operation with a supply voltage of 85 % of the normal value and at normal frequency.
- 5.20.5 All contacts and other parts which may require renewal, adjustment or inspection shall be readily accessible.
- 5.20.6 The control arrangements are to be so designed as to prevent the simultaneous starting of motors of total rating of more than 20 HP where such an eventually may arise, two step operation shall be preferred.
- 5.20.7 Alarm indication for failure of group of fans and oil pump shall be provided.
- 5.20.8 Alarm indication shall be provided to indicate failure of power supply.

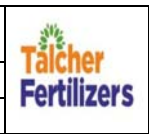

5.20.9 Provision in the cooler control circuit may be made such that tripping of transformer breaker on Differential or Sudden Pressure should lead to supply disconnection to motor of the cooler pump.

6.0 CONSTRUCTIONAL FEATURES

6.1 Core

6.1.1 The transformer core shall be of high grade, non-ageing, electrical silicon cold rolled magnetic sheet steel of low hysteresis loss and high permeability. The maximum flux density in any part of the core and yoke at rated voltage and frequency shall not exceed 1.7 Tesla. The core structure shall be securely grounded to prevent electrostatic potential. Lifting eyes and lugs shall be provided on the limbs and coils assembly. Preferably no bolt shall be used in the cores. Clamping shall be done external to the limb. Bolts passing through the yoke, if any, shall be insulated for 2 KV for transformers rated up to 33 KV and 5 KV for higher voltage ratings (rms) for 1 minute.

6.1.2 The temperature of the core shall not exceed that permitted in IS.

6.1.3 The design of the magnetic circuit shall be such as to avoid static discharges, development of short circuit paths within itself or to the earthed clamping structure and production of flux component at right angles to the plane of laminations which may cause local heating. The temperature of any part of the core or its support structure in contact with oil shall not exceed 120 deg C under normal operating condition and 130 deg C under most extreme operating condition. Adequate temperature margin shall be provided to maintain longer life expectancy for this material.

6.1.4 Core and winding shall be capable of withstanding the shock during transport, installation and service. Adequate provision shall be made to prevent movement of core and winding relative to tank during these conditions.

6.1.5 All steel sections used for supporting the core shall be thoroughly sand blasted after cutting, drilling and welding.

6.1.6 Each core lamination shall be insulated with a material that will not deteriorate due to pressure and hot oil.

6.1.7 The supporting frame work of the core shall be so designed as to avoid presence of pockets which would prevent complete emptying of tank through drain valve or cause trapping of air during oil filling.

6.1.8 Adequate lifting lugs will be provided to enable the core and windings to be lifted.

6.1.9 The core shall be earthed to the core clamping structure at one point only, through a removable external link suitably located and protected to facilitate testing after installation of the transformer.

6.1.10 In case core laminations are divided into sections by insulating barriers or cooling ducts parallel to the plane of the lamination, tinned copper bridging strips shall be inserted to maintain electrical continuity between sections.

6.1.11 A drawing furnishing the details of the internal earthing design shall be included in the manual

6.2 Tank

6.2.1 The tank shall be made of good commercial grade low carbon steel plate of adequate thickness capable of withstanding stress not less than 0.40 kg/cm², properly welded and gusseted to ensure a rigid construction. It shall also be able to withstand normal transportation shocks without any deformation and shall be capable of withstanding following vacuum.

Highest System Voltage	MVA Rating	Vacuum in mm of Hg
Up to 72 KV	Up to 1.6	250
	Above 1.6 to 20	500
	Above 20	760



	TALCHER FERTILIZERS LIMITED TECHNICAL SPECIFICATION – POWER TRANSFORMER	PC183-TS-0803	0	
		Document No.	Rev	
		Sheet 11 of 24		

Above 72 KV

For all Ratings

760

- 6.2.2 For outdoor transformer, the top of the tank, the marshalling box and the headers of radiators, shall be of such a construction so as to prevent accumulation of water.
- 6.2.3 Guides shall be provided to facilitate tanking and untanking of the core with the coil assembly. The details of anchoring of core and coil assembly of the tank shall be furnished.
- 6.2.4 Radiators, where necessary, shall be provided on the tank to facilitate cooling. These shall be detachable type and shall be provided with isolating valves at ends, drain plug and air release plug. The radiators shall be fabricated out of minimum 1.25 mm thick seamless steel tubing or pressed sheet steel. For sizes up to 500 KVA, cooling tubes shall be acceptable.
- 6.2.5 Each tank shall be provided with:
- a) Lifting lugs suitable for lifting the equipment complete with oil.
 - b) A minimum of four jacking pads in accessible position to enable the transformer complete with oil to be raised or lowered using hydraulic jacks. Each jacking pad shall be designed to support with an adequate factor of safety for at least half of the total mass of the transformer filled with oil allowing in addition for maximum possible misalignment of the jacking force to the centre of the working surface.
 - c) Suitable haulage holes shall be provided.
- 6.2.6 The tank shall be designed in such a way that it can be mounted on the rollers.
- 6.2.7 The base of each tank shall be so designed that it shall be possible to move the complete transformer unit by skidding in any direction without injury when using plates or rails.
- 6.2.8 All bolted connections shall be fitted with weather proof, hot oil resistant, resilient gasket in between for complete oil tightness. If gasket is compressible, metallic stops/other suitable means shall be provided to prevent over-compression. All gasketed joints shall be designed, manufactured and assembled to ensure long-term leak and maintenance free operation. Groove provided to accommodate round nitrile rubber cord for rectangular openings shall be milled.
- 6.2.9 The transformer shall be mounted on rollers, as per manufacturer's standard practice.
- 6.2.10 The roller mounted transformers are to be provided with flanged bi-directional wheels and axles. This set of wheels and axles shall be suitable for fixing to the under carriage of transformer to facilitate its movement on rail track. Suitable locking arrangement along with foundation bolts shall be provided for the wheels to prevent accidental movement of transformer.
- 6.2.11 The rail track gauge shall be 1676 mm.
- 6.2.12 To prevent transformer movement during earthquake, suitable clamping devices shall be provided for fixing the transformer to the foundation.
- 6.2.13 The tank cover shall be designed to prevent retention of rain water and shall not distort when lifted. The internal surface of the top cover shall be shaped to ensure efficient collection and direction of free gas to the buchholz relay.
- 6.2.14 At least one adequately sized inspection openings shall be provided in the transformers for easy access to bushings and earth connections. The inspection covers shall not weigh more than 25 kg. Handles shall be provided on the inspection cover to facilitate lifting.
- 6.2.15 The tank covers shall be fitted with pockets at the position of maximum oil temperature at maximum continuous rating for bulbs of oil and winding temperature indicators. It shall be possible to remove these bulbs without lowering the oil in the tank. The thermometer shall be fitted with a captive screw to prevent the ingress of water.
- 6.2.16 Bushing turrets, covers of inspection openings, thermometer pockets etc. shall be designed to prevent ingress of water into or leakage of oil from the tank.

	TALCHER FERTILIZERS LIMITED TECHNICAL SPECIFICATION – POWER TRANSFORMER	PC183-TS-0803	0	
		Document No.	Rev	
		Sheet 12 of 24		

6.2.17 All bolted connections shall be fitted with weather proof, hot oil resistant, resilient gasket in between for complete oil tightness. If gasket is compressible, metallic stops/other suitable means shall be provided to prevent over-compression. All gasketed joints shall be designed, manufactured and assembled to ensure long-term leak and maintenance free operation. Groove provided to accommodate round nitrile rubber cord for rectangular openings shall be milled.

6.2.18 The maximum temperature on any metal part shall not exceed 130 deg. Celsius.

6.2.19 Seamless pipe shall be used upto 80mm conforming to IS 1978 & IS 1979, ERW mild steels pipes as per IS 1239 (Part 1) medium shall be used for ≥ 100 mm and IS 3589 for 150mm. Non-magnetic Stainless-steel materials used shall conform to IS 6911 or ISO 683-13 or EN 10088-2 or AISI 304L or ASTM A240 or J4(S20430 Modified).

6.3 Windings

6.3.1 Each coil shall be made out of paper insulated electrolytic grade copper conductor. Similar coils shall be interchangeable. Successive coils of a winding shall be connected by accessible joints and shall be brazed and finished smooth to prevent abrasive damage to insulation. There shall be no sharp bends in the connecting leads to prevent corona discharge. Aluminium foil wound transformer will also be acceptable.

6.3.2 Immediately after winding process, it shall be vacuum dried, dimensionally pre-stabilized and oil impregnated before next process.. The insulation resistance and polarization index of the winding measured after impregnation shall be furnished in the test certificate.

6.3.3 The magnitude of impulse surges transferred from HV to the LV winding by inductive and capacitive coupling shall be limited to a value below the rated impulse strength of the LV winding. The impulse voltage test results and surge distribution on windings for similar transformer shall be furnished.

6.3.4 The manufacture shall ensure that windings are made in dust proof, Positive pressure, Desert Climate environment. Movement of windings and active part shall be done on air-casters to prevent shocks and abnormal jerks.

6.3.5 Winding clamping arrangement shall distribute the clamping forces evenly over the ends of the windings. All insulating materials and structures shall be protected from contamination and the effects of humidity during and after fabrication, and after receipt, by storing them in a separate, climate-controlled area.

6.4 Insulating Oil

6.4.1 The insulating oil shall be virgin high grade inhibited, conforming to IEC-60296 & all parameters specified below, while tested at supplier's premises. The contractor shall furnish test certificates from the supplier against the acceptance norms as mentioned below, prior to dispatch of oil from refinery to site. Under no circumstances, poor quality oil shall be filled into the transformer and only thereafter be brought up to the specified parameter by circulation within the transformer.

6.4.2 At manufacturer's works the quality of oil used for first filling, testing and impregnation of active parts shall meet at least parameters as mentioned in IEC . The oil test results shall form part of equipment test report.

6.4.3 Prior to filling in main tank at site and shall be tested for

1. Break Down voltage (BDV) : 70kV (min.)
2. Moisture content : 5 ppm (max.)
3. Tan-delta at 90 °C : 0.0025 (max)
4. Interfacial tension : More than 0.004 N/m

6.4.4 Prior to energisation at site oil shall be tested for following properties & acceptance norms as per below generally in line with IEC 60422:

1. Break Down voltage (BDV) : 70 kV (min.)



TALCHER FERTILIZERS LIMITED
TECHNICAL SPECIFICATION – POWER TRANSFORMER

PC183-TS-0803

0

Document No.

Rev

Sheet 13 of 24



2. Moisture content : 10 ppm (max.)
3. Tan-delta at 90 °C : 0.01 (max.)
4. Resistivity at 90 °C : 6×10^{12} ohm-cm (min.)
5. Interfacial tension : 0.035 N/m (min.)
6. *Oxidation Stability (Test method as per IEC 61125 method C, Test duration: 500hour for inhibited oil)
 - a) Acidity: 0.3 (mg KOH /g) (max.)
 - b) Sludge: 0.05 % (max.)
 - c) Tan delta at 90 °C: 0.05 (max.)
7. * Total PCB content : Not detectable (2 mg/kg total)

* For Sr. No. 6 & 7 separate oil sample shall be taken and test results shall be submitted within 45 days after commissioning for approval of Consultant.

Oil sample shall be drawn before and after heat run test and shall be tested for dissolved gas analysis. Oil sampling to be done 2 hours prior to commencement of temperature rise test. For ONAN/ONAF cooled transformers, sample shall not be taken earlier than 2 hours after shutdown. The acceptance norms with reference to various gas generation rates shall be as per IEC 61181.

6.5 Insulation Materials



- 6.5.1 Class 'A' insulating materials specified in IS 1271 shall be used. Paper insulation shall be new and free from punctures. Wood insulation, where used, shall be well seasoned and treated.
- 6.5.2 The mineral oil shall comply with IS: 335. 10% extra oil shall be supplied along with the transformer in non-returnable drums.
- 6.5.3 For the transformers required to be filled up with inert gas for transport purpose, the required amount of oil including 10% extra shall be supplied in non-returnable drums.

6.6 Bushing

- 6.6.1 The bushing insulator shall be rated for the maximum system voltage and shall comply with the requirements laid down in IS. The minimum current rating shall be 400 Amps. in case of overhead line connected transformers, the bushings shall be outdoor type having creepage distances of 31mm/kV and complete with arcing horns. In case of transformers connected with bus duct or cable, the bushings shall be enclosed in the terminal box. In either case, they shall be detachable from outside of the tank. The hardware shall be of tinned copper or nickel plated brass suitable to receive the conductors. Separate neutral bushings shall be provided for earthing the neutral, as required. All bushings shall be marked with the symbols corresponding to the connection diagram indicated in the diagram plate and in accordance with IS.
- 6.6.2 Bushing rated 52 KV class and above shall be oil impregnated paper condenser bushings. Bushing rated below 52KV voltage class shall be solid porcelain or oil communicating type.

6.7 Conservator

- 6.7.1 Main conservator shall have air cell type constant oil pressure system to prevent oxidation and contamination of oil due to contact with moisture, and shall be fitted with magnetic oil level gauge with low oil level potential free contacts.
- 6.7.2 OLTC shall have conventional type conservator with prismatic oil level gauge.
- 6.7.3 Conservator tank shall have adequate capacity with highest and lowest visible-levels to meet the requirements of expansion of total cold oil volume in the transformer and cooling equipment from minimum ambient temperature to 100degC. The capacity of the conservator tank shall be such that the transformer shall be able to carry the specified overload without overflowing of oil. The Calculation shall be submitted during design review.

	TALCHER FERTILIZERS LIMITED TECHNICAL SPECIFICATION – POWER TRANSFORMER	PC183-TS-0803	0	
		Document No.	Rev	
		Sheet 14 of 24		

- 6.7.4 The conservator shall be fitted with integral lifting lugs in such a position so that it can be removed for cleaning purposes. Suitable provision shall be kept to replace air cell and cleaning of the conservator wherever applicable.
- 6.7.5 Conservator shall be positioned so as not to obstruct any electrical connection to transformer. Pipe work shall neither obstruct the removal of tap changers for maintenance or the opening of inspection or manhole covers.
- 6.7.6 Pipe work connections shall be of adequate size for their duty and as short and direct as possible. Only radiused elbows shall be used.
- 6.7.7 The feed pipe to the transformer tank shall enter the transformer cover plate at its highest point and shall be straight for a distance not less than five times its internal diameter on the transformer side of the Buchholz relay, and straight for not less than three times that diameter on the conservator side of the relay.
- 6.7.8 This pipe shall rise towards the oil conservator, through the Buchholz relay, at an angle of not less than 5 degree.
- 6.7.9 Contact of the oil with atmosphere is prohibited by using a flexible air cell of nitrile rubber reinforced with nylon cloth.
- 6.7.10 The temperature of oil is likely to rise upto 100 deg C during operation. As such air cell used shall be suitable for operating continuously at 100 deg C.
- 6.7.11 Air cell of conservator shall be able to withstand the vacuum during installation /maintenance periods. Otherwise provision shall be kept to isolate the conservator from the main tank when the latter is under vacuum by providing a vacuum sealing valve or other suitable means in the pipe connecting main tank with the conservator.
- 6.7.12 The transformer manual shall give full and clear instructions on the operation, maintenance, testing and replacement of the air cell. It shall also indicate shelf life, life expectancy in operation, the recommended replacement intervals and the supplier.
- 6.7.13 The connection of air cell to the top of the conservator is by air proof seal preventing entrance of air into the conservator.

6.8 Neutral Earthing Arrangement

The neutral terminals of transformer shall be brought to the ground level by a brass/tinned copper grounding bar, supported from the tank by using porcelain insulators. The end of the brass/tinned copper bar shall be brought to the bottom of the tank, at a convenient point, for making bolted connection to two (2) 75 x 6 mm galvanised steel flats connected to Owner's grounding mat.

7.0 FITTINGS

- 7.1 Fittings as listed in Annexure - I shall be provided. Any other fittings which may be necessary for the satisfactory operation of the transformer shall also be provided on each transformer.
- 7.2 All fittings shall conform to relevant Indian Standard Specifications.
- 7.3 Fittings such as conservator and associated pipes, explosion vent pipe etc. shall be designed to withstand vacuum as specified in Clause 6.2.1 against atmospheric pressure.
- 7.4 Fittings such as rating plate, dehydrating breather, off-circuit tapping switch, dial type thermometer etc. which need to be observed/ operated, shall be mounted at convenient heights of not more than 1.5 M from the base of the transformer and located so as to be clearly visible from the front.
- 7.5 All opening shall be provided with gasketed metallic covers for protection during transportation.
- 7.6 All valves shall be of globe/butterfly type provided with blanking plates. The valve body shall be made of either Carbon Steel with trim of 13 Cr. steel or gun metal.

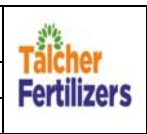

- 7.7 The rating plate, the terminal diagram and terminal marking plates shall be made of Aluminium and shall contain relevant details as per IS 2026. The Code No. of equipment shall be marked on a separate plate.
- 7.8 All terminals shall be anti loosening type and complete with connectors of required size. The earthing terminals shall have identification marks.
- 7.9 All valves in oil line shall be suitable for continuous operation with transformer oil at 115 deg C.
- 7.10 The oil sampling point for main tank shall have two identical valves to be put in series .Oil sampling valve shall have provision to fix rubber hose of 10 mm size to facilitate oil sampling.
- 7.11 A valve or other suitable means shall be provided to fix (in future) on line dissolved gas monitoring system to facilitate continuous dissolved gas analysis. The location & size of the same shall be finalised during detail engineering stage

7.12 Winding Temperature Indicator

Winding temperature indicator for measuring hot spot temperature of the winding shall comprise of current transformer image coil, temperature sensing element, capillary tube jacketed with PVC sleeve, 150 mm dia. local indicating instrument with two pairs of contacts one for alarm and other for trip and maximum point indicator capable of being reset by hand without tools.

In addition to the above, the following equipment shall be provided for remote indication of winding temperature for each of the winding:

a) Signal transmitter for each winding

Signal transmitter shall have additional facility to transmit signal for recording winding temperature at Owner's data acquisition system, for which duplex platinum RTD with nominal resistance of 100 ohms at zero degree centigrade shall be supplied. The RTD shall be three wire ungrounded system. The calibration shall be as per SAMA (USA) standard or equivalent. The RTD may be placed in the pocket containing temperature sensing element and image coil for WTI system which will be used for both remote WTI and DAS. Necessary equipment for sending the signal to remote WTI and DAS shall be provided. In lieu, separate RTD for each of the functions shall be provided.

b) Remote winding temperature indicator

It shall be suitable for flush mounting on Owner's panel. This shall not be repeater dial of local WTI and will operate by signal transmitter. Any special cable required for shielding purpose, for connection between cooler control cabinet and remote WTI control circuit, shall be in the scope of Contractor. Only one RWTI with a selector switch shall be provided for all the windings (HV and LV).



7.13 Oil Temperature Indicator

Oil temperature indicator for measuring top oil temperature shall comprise of 150 mm dial type thermometer, thermometer pocket and capillary tube jacketed with PVC sleeve. Thermometer shall have two pairs of contacts, one for alarm and other for trip and maximum point indicator capable of being reset by hand without tools.

In addition to the above, the following equipment shall be provided for remote indication of oil temperature:

a) Signal transmitter

Signal transmitter shall have additional facility to transmit signal for recording oil temperature at Owner's data acquisition system, for which duplex platinum RTD with nominal resistance of 100 ohms at zero degree centigrade shall be supplied. The RTD shall be three wire ungrounded system. The calibration shall be as per SAMA (USA) standard or equivalent. The RTD may be placed in the pocket containing temperature sensing element and image coil for OTI system which will be used for both remote OTI and DAS. Necessary equipment for sending the signal to remote OTI and DAS shall be provided. In lieu, separate RTD for each of the functions shall be provided.

	TALCHER FERTILIZERS LIMITED TECHNICAL SPECIFICATION – POWER TRANSFORMER	PC183-TS-0803	0	
		Document No.	Rev	
		Sheet 16 of 24		

b) Remote oil temperature indicator

It shall be suitable for flush mounting on Employer's/RTCC panel. This shall not be repeater dial of local OTI and will operate by signal transmitter. Any special cable required for shielding purpose, for connection between cooler control cabinet and remote OTI control circuit, shall be in the scope of Contractor. Only one ROTI with a four point selector switch shall be provided.

7.14 Buchholz Relay

The Buchholz relay as per IS 3637 shall be of double float type, provided with, two pairs of contacts, one for alarm and other for trip, facility for testing by injection of air by hand pump and with a cock for draining and venting of air. The relay shall be provided with shutoff valves on the conservator side as well as on the tank side.

The alarm and trip contacts of all protective devices shall be potential free and rated for 1 Amp at 110 V / 220 V D.C.

7.15 Marshalling Box

A marshalling box shall be provided to accommodate all auxiliary devices except those which are to be located directly on transformer or housed in a separate panel.

- i. Terminal boxes, Junction Boxes & Marshalling Panel shall have IP 55 enclosure(min.), dust, weather and vermin proof type.
- ii. The marshalling box shall be dust, weather and vermin proof type made of sheet steel of not less than 2 mm thick. The box shall be rectangular in shape having sufficient space for easy termination of cables. The terminal block shall be pressure clamp type. 10% spare terminals shall be provided.

Suitable heavy duty double compression type rolled Aluminium cable glands for all incoming and outgoing cables shall be provided.

7.16 Current Transformers

The current transformers shall be provided and shall comply with IS 2705. The C.T. terminals shall be accessible through a weatherproof removable cover for the purpose of testing etc. CT polarity shall be clearly marked. The C.T. for standby earth fault protection shall be 15 VA, 5P10. The C.T's for differential and restricted earth fault protection shall be of Class PS accuracy. The values of V_k and I_{mag} for these CTs shall be furnished at the order stage.

7.17 Wiring

All controls, indication and protective devices provided on the transformer shall be wired upto the terminal block inside the marshalling box, by means of stranded copper heat resistant PVC insulated armoured cable of 1.1 KV grade and size not less than 2.5 sq. mm. Wiring shall be properly fixed on cable tray with at least 100 mm clearance from the transformer body. Suitable identification mark shall be provided on all wires.



7.18 All bought out items shall be of reputed make to be approved by Consultant/ Owner.

7.19 NITROGEN INJECTION FIRE PREVENTION AND EXTINGUISHING SYSTEM

7.19.1 Nitrogen Injection Fire Prevention and Extinguishing System shall be provided for fire protection of Transformer against fire due to an arc, during internal faults and external fires is for preventing tank explosion. The system design shall also conform to TAC/ NFPA norms.

7.19.2 The system should comprise the following :-

- i. Fire Extinguishing Cubicle with base frame and containing, oil drain assembly, nitrogen cylinder, electric mechanical control unit for oil drain and nitrogen release detections necessary for monitoring system flanges on top panel for connecting pipe connections from transformer, panel lighting etc.
- ii. Control Box for monitoring system operation, automatic control and remote operation, with alarms, indication light switches, push buttons, audio signal, suitable for tripping and signaling on 110V DC supply.

	TALCHER FERTILIZERS LIMITED TECHNICAL SPECIFICATION – POWER TRANSFORMER	PC183-TS-0803	0	
		Document No.	Rev	
		Sheet 17 of 24		

- iii. Pre-stressed non-return valve (PNRV) working on transformer oil flow rate, with proximity switch for remote alarm indication and with visual position indicator.
- iv. Required number of fire detectors rated for 141⁰C for heat sensing, each fitted with two number cable glands.
- v. Signal box for terminating cable connections from PNRV and fire detectors.
- vi. Pressure relief valve with limit switch.

7.19.3 The following arrangements are required to be made on the transformer Tank at the time of fabrication of the tank :-

- i. Oil drain opening with pipe, flange and manual gate valve at about 120mm below the top cover. Pipe size DN125 for 100 MVA and higher ratings.
- ii. Nitrogen Injection openings with pipe size DN 25 with flange and manual gate valve on tank sides at about 100-200 mm from the bottom plate.
- iii. Flanges having 4 Nos. 18 dia. holes with pcd as 155mm and dummy pipe on the conservator pipe between buchholz relay and conservator tank manual gate valve, for fixing PNRV.
- iv. Fire detector brackets on top cover.
- v. Brackets for fixing signal box at a suitable location on top cover or tank size wall.

7.19.4 **ACTIVATION OF NIFPES:**

Mal-functioning of fire prevention / extinguishing systems is their major shortcoming which leads to interruption in power supply. The Contractor shall ensure that the chances of malfunctioning of NIFPES are practically nil. To achieve this objective, the Contractor shall work out their scheme of activating signals which, while preventing mal-operation, should not be too rigorous to make the operation of NIFPES impracticable in case of actual need. Transformer isolation shall be the mandatory pre-requisite for activation of the system in Automatic mode or Remote mode in the control room.

In addition, at least following electrical-signals shall be provided in series for activating NIFPES.

7.19.5 Auto Mode

- a) For Prevention of Fire :
 - i. Differential Relay Operation
 - ii. Buchholz Relay parallel with Pressure Relief Valve or RPRR. (Rapid Pressure Release Relay)
 - iii. Tripping of all concerned breakers is a prerequisite for initiation of system activation.

- b) For Extinguishing Fire :
 - i. Fire Detector
 - ii. Buchholz Relay paralleled with Pressure Relief Valve or RPRR.
 - iii. Tripping of all connected breakers is a prerequisite for initiation of system activation.

7.19.6 Manual Mode (Local/Remote): Tripping of all connected breakers is a pre-requisite for initiation of system activation.

7.19.7 Manual Mode (Mechanical): Tripping of all connected breakers is a pre-requisite for initiation of system activation.

7.19.8 **General Description of NIFPES**

7.19.9 **Schematic of the System**

NIFPES should be a stand alone dedicated system for oil filled. It should have a fire extinguishing FE) cubicle placed on a plinth at a distance of 6-10 mtrs. from the transformer. The F.E. cubicle may be connected to the transformer oil tank (near its top) and to the oil pit from its bottom through oil pipes with gate valves. The F.E. cubicle should house a pressurized nitrogen cylinder connected to the transformer oil tank (near its bottom). Cable connections are to be provided from signal box placed on the transformer to the control box in the control room and from control box to F.E. cubicle. Fire detectors placed at the top of transformer are to be connected in parallel to the signal box. The signal box may be connected to a pre-stressed non-return valve fitted between the conservator tank and Buchholz relay. Control box is also to be connected to relay panel in control room for system activation signals.

7.19.10 Operation

On receipt of all activating signals, drain of pre-determined quantity of oil commences thus removing high temp. top oil layer. Simultaneously nitrogen is injected under high pressure at a pre-fixed rate, string the oil thus bringing the temperature of top oil layer down. Nitrogen occupies the space created by oil drained out and acts as an insulating layer between the tank oil & fire on top cover. Pre-stressed non return valve blocks oil flow form conservator tank, thus isolating it & preventing aggravation of fire.

7.19.11 System Components

Broadly, NIFPES shall consist of the following components. It is emphasized that all components, necessary for fast reliable & effective working of NIFPES shall be considered within the scope.

7.19.12 Fire Extinguishing Cubicle

It shall be made of 3mm thick steel sheet, painted dark red from inside & outside with hinged split doors fitted with high quality tamper proof lock. It shall be complete with the base frame and the following:-

- Nitrogen gas cylinder with regulator and falling pressure electrical contact manometer
- Oil drain pipe with mechanical quick drain valve.
- Electro mechanical control equipment for oil drain and pre-determined regulated nitrogen release.
- Pressure monitoring switch for back-up protection for nitrogen release.
- Limit switches for monitoring of the system.
- Flanges on top panel for connecting oil drain and nitrogen injection pipes for transformer.
- Panel lighting (CFL Type)
- Oil drain pipe extension of suitable sizes for connecting pipes to oil pit.

7.20 Control Box

Control Box for monitoring system operation, automatic control and remote operation, with following alarms indication, light switches, push buttons, audio signal, line fault detection suitable for tripping and signaling on 110V DC supply :

- System on*
- PNRV open*
- Oil drain valve closed*
- Gas inlet valve closed*
- PNRV closed^
- Fire Detector Trip^
- Buchholz Relay Trip^
- Oil drain valve open^
- Extinction in pressure^

	TALCHER FERTILIZERS LIMITED TECHNICAL SPECIFICATION – POWER TRANSFORMER	PC183-TS-0803	0	
		Document No.	Rev	
		Sheet 19 of 24		

- Cylinder pressure low[^]
- Differential relay trip[^]
- PRV/RPRR trip[^]
- Transformer trip[^]
- System out of service
- Line fault free detector
- Line fault differential relay
- Line fault buchholz relay
- Line fault PRV
- Line fault transformer trip
- Line fault PNRV
- Auto/Manual/Off
- Extinction release on
- Extinction release off
- Lamp test
- Visual / Audio Alarm
- Visual / Audio alarm for DC supply fail

The signals marked (*) shall be in the topmost row of control box panel. The signals marked (^) shall follow next.

7.21 **Pre-stressed Non Return Valve (PNRV)**

PNRV is to be fitted in the conservator pipe line between conservator & Buchholz relay. It shall have the proximity switch for remote alarm, indication and with visual position indicator. The PNRV should be of the best quality because malfunction of PNRV shall be of serious consequence as its closing leads to stoppage of breathing of transformer.

7.22 **Fire Detectors**

The system shall be complete with adequate number of fire detectors fitted on the top of oil tank, OLTC/Off ckt. Tap changer rated for 1410C for heat sensing each fitted with two no. cable glands (water proof/weather proof).

7.23 **Signal Box**

It shall be fitted on the transformer for terminating cable connections from PNRV & fire detectors and for further connection to the control box.

7.24 **Cables**

Fire survival cables, able to withstand 7500C, 4 core x 1.5mm sq. for connection of fire detectors in parallel shall be used. Fire retardant low smoke (FRLS) cable 12 core x 1.5mm sq. for connection between transformer signal box/marshalling box to control box and control box to fire extinguishing cubicle shall be used.

Fire retardant low smoke (FRLS) cable 4 core x 1.5mm sq. for connection between control box to DC supply source and fire extinguishing cubicle to AC supply source, signal box marshalling box to prestressed non return valve connection on transformer shall be used.

7.25 **Pipes**

Pipes, complete with connections, flanges, bends, tees etc. shall be supplied alongwith the system.

7.26 **Other items**

- a) Oil drain and nitrogen injection openings with gate valves on transformer tank at suitable locations
- b) Flanges with dummy piece in conservator pipe between Buchholz relay and conservator tank for fixing PNRV.

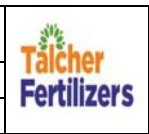

- c) Fire detector brackets on transformer top cover.
- d) Spare potential free contacts for system activating signals i.e. differential relay, buchholz relay, pressure relief valve, transformer isolation (master trip relay).
- e) Pipe connections between transformer to fire extinguishing cubicle and fire extinguishing cubicle to oil pit.
- f) Cabling on transformer top cover for fire detectors to be connected in parallel and inter cabling between signal box to control box and control box to fire extinguishing cubicle
- g) Mild steel oil tank with moisture proof coating with capacity as minimum 10% of total oil quantity of transformer, with water tight cover, to be place in the oil pit. This tank shall be provided with the manhole, air vent pipe through silica gel breather, drain valve and a spare gate valve at the top.
- h) Gate valves on oil drain pipe & nitrogen injection pipe should be able to withstand full vacuum. A non-return valve shall also be fitted on nitrogen injection pipe between transformers & gate valve.
- i) Pressure relief valve, wherever not fitted on the transformer.
- j) The F.E. cubicle shall be painted with post office red colour (Shade 538 of IS-5). All the exposed parts i.e. pipes, supports, signal box etc. shall be painted with enameled paint.

7.27 Modification on the transformer

No modification on the transformer shall be allowed which affects its performance (i.e. efficiency, losses, heat dissipation ability etc.), safety, life etc. or its any other useful parameter. This requirement shall be of paramount importance and shall be followed.

However, in any case, performance of transformer should not be affected in any manner by having NIFPES system and the Contractor shall give an undertaking to this effect. All pipes should be washed/rinsed with transformer oil. If any damage is done to the transformer and/or any connected equipment during installation & commissioning full recovery therefore shall be effected from the Contractor.



It shall be solely the responsibility of Contractor/Sub-Contractor to install, carry out pre-commissioning tests & commission NIFPES at Ridge Valley indicated in this Specification, to the entire satisfaction of the Owner/Consultant..

7.28 Interlocks

It shall be ensured that once the NIFPES gets activated manually or in auto mode, all the connected breakers shall not close until the system is actually put in OFF mode. Also PNRV shall get closed only if all the connected breakers are open.

7.29 In general, following Fire Extinction period and other data shall be followed :

On commencement of Nitrogen Injection	:	Maximum 30 seconds
From the moment of system activation to complete cooling	:	Maximum 3 minutes
Fire detectors heat sensing temperature	:	141 ⁰ C
Heat sensing area	:	800mm radius
Pre-stressed non return valve setting for Operation	:	minimum 60 ltr. Per minute
Capacity of Nitrogen cylinder	:	Minimum 68 litre water capacity And shall hold minimum 10 cubic Meter gas to 150 bar pressure
Power Source	:	
Control Box	:	220VDC

	TALCHER FERTILIZERS LIMITED TECHNICAL SPECIFICATION – POWER TRANSFORMER	PC183-TS-0803	0	
		Document No.	Rev	
		Sheet 21 of 24		

Fire extinguishing cubicle for 230VAC lighting

7.30 The following information in detail shall be provided :

- a) The maintenance and testing schedule for NIFPES.
- b) All the steps required to be undertaken for restarting the transformer and connected equipment after operation and mal-operation (if any) of the NIFPES.
- c) The process of venting nitrogen in case nitrogen pressure in the cylinder exceeds the stipulated maximum value.

8.0 PAINTING

- 8.1 The surface to be painted shall be shot or sand blasted to remove all dust, scale and foreign adhering matter. All traces of oil and greases should be removed by suitable treatment.
- 8.2 All steel surfaces in contact with insulating oil shall be painted with heat resistant oil insoluble insulating varnish.
- 8.3 All steel surfaces exposed to outside shall be painted with suitable anti-rust and anticorrosive paints. Epoxy paints shall be used.
- 8.4 All paints shall be carefully selected to withstand tropical heat and extremes of weather. The paint shall not scale off, crinkle or be removed by abrasion due to normal handling.
- 8.5 The paint should not fade during drying process. The paint should be able to withstand temperature up to 120 deg. C .The detailed painting procedure shall also be submitted along with the bid which shall be finalized before award of the contract.
- 8.6 Unless otherwise specified, the finishing shade shall be light grey Shade No. 631 as per IS 5.
- 8.7 1 litre of paint per transformer shall be supplied for touch up at Site.

9.0 TESTS AND INSPECTION

- 9.1 All transformers shall be routine tested as per IS 2026. Transformer oil shall be tested as per IS 335. Heat run test shall be carried out for one transformer of each rating.
- 9.2 Type test certificate shall be furnished.
 - a. Temperature-rise tests (IEC 60076-2)
 - b. Dielectric tests: Full-wave impulse-voltage withstand test (IEC 60076-3)
- 9.3 Additional tests, wherever specified, shall be carried out on one transformer of each rating.
- 9.4 All the above mentioned tests shall be carried out in the presence of Purchaser's representative. In addition, the transformers shall be subject to stage inspection at works and inspection at site for final acceptance.
- 9.5 These inspections shall, however, not absolve the Vendor from their responsibility for making good any defect which may be noticed subsequently.

10.0 DRAWINGS AND DOCUMENTS

- 10.1 The drawings and documents as per Annexure-III shall be furnished, unless otherwise specified.
- 10.2 All drawings and documents shall have the following descriptions written boldly:
 - Name of Client
 - Name of Consultant
 - Enquiry / order number with plant / project name
 - Equipment Code No. and Description
- 10.3 The transformer shall be suitably packed to avoid damage in transit and shall be properly sealed so as to completely exclude oxygen and moisture from coming in contact with oil.

	TALCHER FERTILIZERS LIMITED TECHNICAL SPECIFICATION – POWER TRANSFORMER	PC183-TS-0803	0	
		Document No.	Rev	
		Sheet 22 of 24		

Bushing shall be wrapped in straw ropes or similar material and complete transformer shall be packed in wooden crates.

10.4 The packing box shall contain a copy of the installation, operation and maintenance manual.

10.5 All loose pieces shall be separately wrapped in moisture resistant paper and marked with identification mark of the corresponding transformer.

11.0 SPARES

11.1 Commissioning Spares : Commissioning spares, as required, shall be supplied with the main equipment. Item-wise list of recommended commissioning spares shall be furnished for information.

11.2 Spares for 2 Years Operation (Mandatory), as specified shall be supplied.

11.3 List of Recommend Spares (other than Mandatory Spares) alongwith recommended quantity shall be furnished.

11.4 All spare parts shall be identical to the parts used in the equipment.

12.0 PACKING

12.1 The transformer shall be suitably packed to avoid damage in transit and shall be properly sealed so as to completely exclude oxygen and moisture from coming in contact with oil. Bushing shall be wrapped in straw ropes or similar material and complete transformer shall be packed in wooden crates.

12.2 The packing box shall contain a copy of the installation, operation and maintenance manual.

12.3 All loose pieces shall be separately wrapped in moisture resistant paper and marked with identification mark of the corresponding transformer.



ANNEXURE - I LIST OF FITTINGS

I. The fittings as given below shall be provided for all the ratings of transformers.

1. Oil Sampling Valve.
2. Filter valves with plug.
3. Radiator shutoff valves on top and bottom for each unit.
4. Buchholz relay shutoff valves.
5. Winding temperature indicator for 1000 KVA and above.
6. Oil temperature indicator.
7. Oil level indicator with minimum marking.
8. Oil conservator complete with drain plug and oil filling hole with cover.
9. Buchholz relay with air release device and alarm and trip contacts.
10. Silica gel breather with oil seal and connecting pipe.
11. Explosion vent.
12. Bi-directional rollers.
13. Inspection holes with cover.
14. Marshalling Box.
15. Rating Plate.
16. Diagram and Terminal marking plate.
17. Lifting lugs.
18. Jacking pad.
19. Earthing Terminals.
20. Air release device.
21. Neutral bushing for earthing.
22. Ladder with safety device for access to the top of transformer tank.

II. The additional fittings as given below shall also be provided, as per requirement:

1. Magnetic oil level gauge with low oil level alarm contact.
2. Hauling lugs for extra high voltage transformers.
3. Protective CTs for
 - a) Stand-by earth fault.
 - b) Restricted earth fault.
 - c) Differential protection.
4. Bi-directional wheels if already bi-directional rollers not considered.
5. Skids.
6. Cooler units complete with valves, fans, pumps, oil flow indicators, supporting structure with fixing and foundation bolts etc as required and Cooler Control panel.
7. Tap-changing gear complete with tap position indicator, operation counter etc. For OLTC gear(where specified), oil surge relay(OSL) with shut-off valve, Local control cabinet.
8. Nitrogen Injection Fire Prevention and Extinguishing System

	TALCHER FERTILIZERS LIMITED TECHNICAL SPECIFICATION – POWER TRANSFORMER	PC183-TS-0803	0	
		Document No.	Rev	
		Sheet 24 of 24		

ANNEXURE - II
DOCUMENTATION FOR TRANSFORMERS

Sl. No.	Description	Documents Required (Y / N)		
		With Bid	For Approval	Final
1.	Specification Sheet	N	Y	Y
2.	Technical Particulars	N	Y	Y
3.	Dimensional drawing for complete Transformer, Marshalling Box, disconnecting chamber, terminal chambers etc.	N	Y	Y
4.	Schematic and Wiring Diagram	N	Y	Y
5.	Terminal arrangement drawing	N	Y	Y
6.	Installation, operation and maintenance manual	N	N	Y
7.	Catalogues and test certificates for bought out accessories	N	N	Y
8.	Type test certificates of similar transformer	N	N	Y
9.	Test Certificates	N	N	Y
10.	Guarantee Certificates	N	N	Y
11.	Spare parts list with identification marks	N	N	Y

Note:

1. 4 hard copies & 1 soft copy shall be supplied for approval after order within 4 weeks from the date of LOI.
2. 8 hard copies & 2 soft copies in CD shall be submitted as final documents prior to despatch of the equipment. These shall be made in sets and supplied in fine plastic coated folder.

Y - Yes, N - No



TALCHER FERTILIZERS LIMITED
TECHNICAL SPECIFICATION - MEDIUM VOLTAGE
SWITCH BOARDS

PC183-TS-0805

0

Document No.

Rev

Sheet 1 of 16



TECHNICAL SPECIFICATION
MEDIUM VOLTAGE SWITCH BOARDS

CONTENTS

SECTION NUMBER	DESCRIPTION
1.0	SCOPE
2.0	STANDARDS TO BE FOLLOWED
3.0	SERVICE CONDITIONS
4.0	OPERATING REQUIREMENTS
5.0	DESIGN AND CONSTRUCTIONAL FEATURES
6.0	COMPONENT DETAILS
7.0	ACCESSORIES
8.0	PAINTING
9.0	TESTS AND INSPECTION
10.0	DRAWINGS AND DOCUMENTS
11.0	SPARES
12.0	PACKING
ANNEXURE - I	DOCUMENTATION FOR MEDIUM VOLTAGE SWITCH BOARDS

1.0 SCOPE

- 1.1 This standard covers the technical requirements of design, manufacture, testing at works and delivery in well-packed condition of Medium Voltage Switchboards.
- 1.2 This standard shall be applicable for the Power Control Centres, Power cum Motor Control Centres and Motor Control Centres.
- 1.3 This standard shall be read in conjunction with relevant part of Design Philosophy – Electrical, Schematic diagrams etc.

2.0 STANDARDS TO BE FOLLOWED

- 2.1 The design, manufacture and testing of the equipment shall comply with the latest issue of the following Indian Standards, unless otherwise Specified. Equipment complying with equivalent IEC standards shall also be acceptable.

- | | |
|--------------|--|
| IS 8623 | - Specification for low voltage switchgear and control gear assemblies |
| IS/IEC 60947 | - Low-voltage switchgear and control gear (General Rules) |
| IS 5578 | - Guide for marking of insulated conductors |
| IS 10118 | - Code of practice for selection, installation and maintenance of switchgear and control gear |
| IS 11353 | - Guide for uniform system of marking and identification of conductors and apparatus terminals |

Various components housed in the switchboards shall conform to the Indian Standard specifications as mentioned against the component details or IEC specifications.

- 2.2 The design and operational features of all the equipment offered shall also comply with the provisions of the latest issue of the Indian Electricity Rules and other Statutory Acts and Regulations, as applicable. The supplier shall, wherever necessary, make suitable modifications in the equipment to comply with the above.
- 2.3 Wherever any requirement, laid down in this standard, differs from that in Indian Standard Specification / IEC Specification, the requirement specified herein shall prevail.

3.0 SERVICE CONDITIONS

3.1 Ambient Conditions

These shall be as indicated in Design Philosophy – Electrical.

3.2 System Details

These shall be as indicated in Design Philosophy – Electrical.

4.0 OPERATING REQUIREMENTS

The Medium Voltage Switchboards shall be suitable for operating at the specified rating continuously, with the specified voltage and frequency variations under the ambient conditions, without exceeding the permissible temperature rise and without any detrimental effect on any part.

5.0 DESIGN AND CONSTRUCTIONAL FEATURES

5.1 General

- 5.1.1 The switchboards shall consist of an assembly of a series of floor mounting, identical, metal clad, dead front type sheet steel panels of unitized design. The panels shall be placed side by side to form a compact assembly and shall be extensible on either side.
- 5.1.2 The complete assembly shall be dust, damp and vermin proof having minimum degree of protection equivalent to IP-52 up to 1600A rating and IP-4X above 1600A rating as per IS/IEC:60947.
- 5.1.3 The frame work of the cubicles shall be of bolted/welded construction. The minimum thickness of sheet steel shall be 2 mm for load bearing members, 1.6 mm for non-load bearing members and 3 mm for base channel. The doors and covers shall be fabricated from cold rolled sheets. Suitable reinforcement, wherever necessary, shall be provided.
- 5.1.4 The door hinges shall be concealed type.
- 5.1.5 All external hardwares shall be cadmium plated. The hardwares for fixing the removable parts shall be provided with retaining devices.
- 5.1.6 The doors and the removable covers shall be provided with non-deteriorating neoprene gaskets. Gaskets without any discontinuity shall be preferred. Gaskets shall be held in position in groove, in shaped sheet steel work or these shall be of U type. Adhesive cement, if used, shall be of good quality so that the gaskets do not come off during service.
- 5.1.7 All the components shall be accessible for inspection and maintenance without the necessity for removal of the adjacent ones.
- 5.1.8 The layout of the component inside the module shall be liberal to facilitate maintenance and interconnecting wiring between the components shall not be subjected to any undue stresses at the bends.
- 5.1.9 Mounting height of components requiring operations and observation shall not be lower than 300 mm and higher than 1800 mm.
- 5.1.10 Inter panel barriers shall be provided.
- 5.1.11 All the live parts which are accessible after opening of front cover/cable alley cover/back cover shall be properly insulated or provided with insulating barrier to prevent accidental contact. Removal facility shall be provided for all such parts.
- 5.1.12 Adequate arrangement for earthing shall be provided to safeguard the operator or other personnel from electric hazards under all conditions of operation.

5.2 Panel Arrangement

The Switchboards shall be in fixed/draw out, single front execution, fully compartmentalised type and divided into distinct panels, each comprising of :

- i) A completely metal enclosed bus-bars compartment running horizontally the top.
- ii) Individual feeder modules.
- iii) Enclosed vertical bus-bars serving all modules, in case of multi-tier panels.
- iv) A vertical cable alley.
- v) Separate horizontal enclosure for all auxiliary power and control buses.

5.3 Circuit Breaker Controlled Feeders

- 5.3.1 The panels housing circuit breaker feeders shall be in single front draw out execution. The incoming and bus coupler circuit breaker feeders shall be in single tier formation while the outgoing circuit breaker feeders may be in double tier formation.

- 5.3.2 A suitable barrier shall be provided between the circuit breaker and the associated control, protective and indication devices including instrument transformers.
- 5.3.3 All the protective relays and meters shall be flush mounted type. The relays and meters pertaining to a particular circuit breaker shall be mounted on the same panel. Where it is not possible to accommodate all the relays and meters in the same panel, one metering panel shall be provided adjacent to the circuit breaker panel exclusively for that feeder. Location of these in the adjacent panel of other feeders shall not be acceptable.
- 5.3.4 A spacious cable chamber suitable for accommodation, support and termination of required number of power cables shall be provided at the back. No bare bus-bars or live connection shall intrude into the cabling space.
- 5.3.5 The switchboard shall be provided with following inter locks and safety features:
- i) It shall not be possible to open the compartment door unless the breaker is drawn to isolated position.
 - ii) The withdrawn and engagement of a circuit breaker shall not be possible unless it is in open position.
 - iii) The operation of a circuit breaker shall not be possible unless it is in fully service, test or isolated position.
 - iv) It shall not be possible to close the circuit breaker in service position unless all auxiliary and control circuits are connected.
 - v) A breaker of the lower rating shall be prevented from engaging with the stationary element of higher rating.
 - vi) Insertion of the manual mechanism shall render the motorised mechanism in operation.
 - vii) Circuit breaker 'ON', 'OFF' indication shall be provided at the back of each panel. Alternatively, alarm shall be provided in case panel back door is opened with breaker "ON".
 - viii) Caution nameplate shall be provided at the back of incomer's panels where terminals are likely to remain live and isolation is possible only from remote end.
 - ix) Automatic safety shutter, with Padlocking facility for locking in closed position, to completely cover the spouts for the bus-bars and cable connection when the breaker is withdrawn.
- 5.4 **Switch/MCCB Controlled Feeders**
- 5.4.1 The panels housing motor starter or other feeders shall be either fixed or draw out type in single front execution.
- 5.4.2 All components of one feeder shall be mounted on a rigid sheet steel chassis.
- 5.4.3 Each panel shall be divided into a number of modules in tier formation placed one above the other. These modules shall be closed on all sides.
- 5.4.4 The modules shall be so placed that largest one is placed at the bottom of the panel. Type modules shall be at least 300 mm from the base channel.
- 5.4.5 The number of modules shall be so decided that the cables in the cable alley are not over crowded. However the number of module in any panel shall not exceed six.
- 5.4.6 The minimum size of module shall be 300 mm and 200 mm for starter and switch fuse feeders respectively.
- 5.4.7 The minimum clear width of cable alley shall be 250 mm.

- 5.4.8 For MCC rated above 630 Amp. The incomer and bus coupler modules shall be located in individual single panel. For MCC rated for 630 Amp. and below the incomer and bus coupler modules shall be half the panel size.
- 5.4.9 The module door shall be so interlocked that it shall not be possible to open the door with switch in closed position and close the door unless the module is fully plugged in. Defeat interlock facility shall be provided.
- 5.5 Special Features of Draw out Modules**
- 5.5.1 The module shall be fully draw out type with sheet steel chassis moving freely on the guides. Chassis of the same size shall be fully interchangeable.
- 5.5.2 The module shall have the following distinct mechanical positions:
- i) Service -- In which both power and control contacts shall be made.
 - ii) Test -- In which power contacts shall be isolated but control contacts shall be made.
 - iii) Isolated -- In which both power and control contacts shall be Isolated.
- Maintenance position shall be preferred.
- 5.5.3 Each position shall be clearly marked. Padlocking facility shall be provided to padlock the chassis in any of the position.
- 5.5.4 The movement of the chassis from one position to the other shall be controlled by using an appropriate racking mechanism. Stopper shall be provided to prevent over travel of the chassis beyond the isolated position.
- 5.5.5 The guiding system shall permit smooth movement of the module and the power and control contacts shall be self-aligning type so that accurate alignment of the contacts is ensured.
- 5.5.6 No wiring shall be taken to the door. Only the actuators of the push buttons and switches, lenses for the indicating lamps and Perspex cover for meters shall be mounted on the door.
- 5.5.7 The power contacts shall be of plug-in/stab-in type made of silver plated copper, spring loaded and of adequate current carrying capacity. The contacts shall be so designed that contact pressure is maintained both under normal and short circuit conditions.
- 5.5.8 The parting contacts, both on bus-bar side and outgoing cable side, shall always be copper to copper and both sides silver plated. A bimetallic strip shall be used where two dissimilar materials are in contact.
- 5.6 Bus-Bars and Connections**
- 5.6.1 The bus-bars shall be for three phase and neutral. The main bus-bars and connections shall be made of electrolytic grade copper of rectangular cross-section. Auxiliary bus-bars for control supply, space heater supply etc. shall be made of electrolytic copper.
- 5.6.2 The horizontal bus-bars shall be insulated with heat shrinkable PVC sleeves of reputed make to protect against approach to live parts. The vertical bus-bars shall be sleeved or shrouded by barriers. Removable type insulating shrouds shall be provided for all joints of horizontal bus-bars.
- 5.6.3 The bus-bars shall be amply sized to carry the rated continuous current under the specified ambient temperature without exceeding temperature limits specified in IS: 8084. The thermal rating of the bus-bars shall be designed to withstand the system fault current for 1 second without exceeding the limiting temperature of 200°C for bare Aluminium/Copper. Calculation for bus-bars sizing shall be furnished along with the offer.

- 5.6.4 Horizontal bus-bars shall be of the same cross-section through out. Stepped bus-bars shall not be acceptable.
- 5.6.5 The bus-bars shall be arranged and colour coded according to IS: 5578 / IS: 11353.
- 5.6.6 The bus-bar chamber shall be sufficiently spacious and shall have separate screwed covers for maintenance purpose.
- 5.6.7 The bus-bars shall be rigidly supported at equal intervals to withstand maximum short circuit stresses. The supports shall be of moulded construction with built-in anti-tracking barriers. The support materials shall be of DMC or fibreglass reinforced thermosetting plastic.
- 5.6.8 Bus-bar joints shall be between the two transporting sections only.
- 5.6.9 A minimum of two bolts shall be used in bus-bar joints. Only high tensile electric galvanized bolts, nuts and washers shall be used.
- 5.6.10 In case of Aluminium bus-bars, all joints shall be suitably treated to avoid oxidation of contact surfaces and bimetallic corrosion.

5.7 **Earth Bus**

A continuous earth bus of electrolytic grade copper, running along the entire length of the lower part of the switchboard shall be provided with lugs at two ends for external connections. The minimum size of earth bus shall be suitable for carrying three phase fault current for 1 sec.

5.8 **Bus Duct**

- 5.8.1 Suitable extension of bus-bars in proper phase sequence on the top, with the connecting bolts shall be provided where connection of transformer to switchboard is specified to be through bus duct.
- 5.8.2 Bus duct between two halves of a switchboard, if required, shall be supplied by the switchboard manufacturer. The bus-bars of interconnecting bust duct shall be similar to the main bus-bars of the switchboard and as specified above.
- 5.8.3 Bust duct between transformer and incoming breaker panel, if included in Vendor's scope, shall conform to ES-8062.

5.9 **Clearances and Creepage Distances**

- 5.9.1 The clearances and creepage distances shall not be lower than the values specified below:

- | | | | |
|------|--|----|-------|
| i) | Minimum clearance between two live conductors | -- | 20 mm |
| ii) | Minimum clearance between live parts and accidentally dangerous part | -- | 20 mm |
| iii) | Minimum creepage distance | -- | 28 mm |

- 5.9.2 The clearances and creepage, as specified above, shall definitely be maintained in the bus-bar system. Provision of bus-bar insulation, separators or barriers shall not be considered to reduce the clearance from the values specified above.

- 5.9.3 At the termination points in the equipment e.g. switches, contactors, thermal relays etc. It is realized that above clearances may not always be possible to be maintained. All such points, where above clearances and creepage distances are not possible to be maintained, shall be insulated or taped.

5.10 **Insulation**

- 5.10.1 The insulation used shall be non-hygroscopic and may be of porcelain, epoxy resins or fibreglass moulded with plastic. It shall be of adequate electrical, mechanical and

thermal strength to give trouble free service during normal operation and short circuit conditions.

5.10.2 The insulation shall be treated suitably to withstand the tropical conditions and atmospheric pollution.

5.11 Power Wiring

5.11.1 The connections from bus-bar to individual functional unit on the modules shall be of PVC insulated flexible copper cables or taped Copper/Aluminium strip.

5.11.2 The power wiring size shall be decided based on rating of the switch/breaker after using a rating factor of not more than 50% over the current rating in free air.

5.11.3 Power wiring size selected for breaker controlled module shall also be able to withstand full short circuit current for duration of 0.25 sec.

5.11.4 In any case minimum size of power wiring shall not be less than 4 sq. mm copper.

5.11.5 The size of connection from incomer to horizontal bus-bar and from horizontal bus-bar to bus-coupler shall not be less than the size adopted for horizontal bus-bar.

5.12 Control Wiring

5.12.1 The switchboard shall be completely factory wired and ready for external connections.

5.12.2 The wiring shall be carried out with flexible stranded PVC insulated copper conductor cables of 1100 Volt grade. The size of wires shall be as follows:

C.T. Circuit -- 2.5 sq. mm

V.T. and Control Circuits -- 1.5 sq. mm

5.12.3 All wiring shall be provided with dependent both ends marking as per IS: 5578. Numbered ferrules, reading from the terminals outwards, shall be provided at both ends of all wiring for easy identification. These shall be interlocking type plastic ferrules.

5.12.4 Control wiring circuits, fed from a supply common to a number of panels, shall be so protected that failure of a circuit in one panel does not effect the operation of the other panels.

5.12.5 The wiring to the equipment mounted on the doors shall be carried out with flexible multi strand copper conductor cable and so supported that on opening of the door there is no undue strain on wire leads.

5.12.6 The control cables shall be neatly arranged and property supported.

5.13 External Cable Termination

5.13.1 All power and control cables shall enter the switchboard from the bottom. Sufficient space shall be provided for ease of connection and termination of cables.

5.13.2 The type, number and sizes of cables shall be as indicated in Feeder details.

5.13.3 Compression type cable glands along with the cable lugs as required shall be provided for termination of cables.

5.13.4 The cable glands shall be of rolled Aluminium heavy duty double compression type and shall be mounted on a removable gland plate, provided at a minimum height of 75 mm from the bottom of the switchboard. Two number spare knockouts of size 20 mm shall also be provided on the gland plates for future use. Gland for termination of single core cables shall be nonmagnetic type.

5.13.5 For all power cables, crimped type Aluminium lugs for Aluminium cables and tinned Copper lugs for Copper cables shall be provided.

5.13.6 The terminal blocks shall be pressure clamp type up to 35 sq. mm cable sizes and bolted lug type for higher sizes of cables. These shall be protected type and rated for

1100 Volts service. The minimum current rating of terminal block shall be 16 Amp. The construction shall be such that after the connection of cables by means of lugs, necessary clearance and creepage distance are available.

5.13.7 Where more than two cables in parallel are required to be terminated, a system of bus links shall be provided with adequate clearance and spacing.

5.13.8 Suitable clamps to support the vertical run of cables shall be provided.

5.13.9 The terminal block shall be grouped according to circuit functions and suitably numbered. 20% extra terminals shall be provided in the terminal block.

5.13.10 For power connections, suitable marking on the terminals shall be provided to identify the phases.

5.14 **Feeder Details**

5.14.1 The requirements of incomer, bus coupler and outgoing feeders shall be as indicated in the single line diagram, feeder details and corresponding schematic diagrams.

5.14.2 Interlocks shall be provided between incomers and bus section panels. The interlocks shall be either electrical or mechanical type. In addition, arrangement for defeating the interlock shall also be provided to facilitate manual changeover.

5.14.3 Auto changeover scheme, wherever specified, shall be provided.

5.15 **Dummy Panels**

Dummy panels complete with bus-bar system in 400 mm width may be required for which unit price shall be indicated.

5.16 **Control Power Supply**

5.16.1 D.C. Power required for closing, tripping and indication of circuit breaker feeders shall be supplied at the bus coupler panel through two completely separate circuits by owner, one for tripping and other for closing and indication.

5.16.2 For receiving each external control supply, a double pole miniature circuit breaker shall be provided. This power shall be distributed inside the switchboard for each circuit breaker feeder having its MCB unit.

5.17 **Space Heater Power Supply**

5.17.1 Panel space heater shall be fed from a separate bus common for the whole board. This bus shall be fed from owner's supply for which a double pole MCB shall be provided in bus section panel.

5.17.2 Power supply for space heaters of motors shall be tapped from this bus by means of a MCB located in the motor feeder compartment. These MCBs shall be of triple pole and rated for 15 Amp.

6.0 **COMPONENT DETAILS**

Components of the switchgear shall ensure type of coordination 'C' as per IS:60947 (Part 4/ Section 1). Makes of all components shall be subject to owner's / consultant's approval

6.1 **Circuit Breaker**

6.1.1 The circuit breakers shall comply with the requirement of IS/IEC 60947.

6.1.2 All circuit breakers shall be of P2 (0-3 min - CO - 3 min - CO) category, capable of carrying the specified current at the site conditions and making/breaking of the system fault current.

- 6.1.3 Type test certificates from an independent testing authority shall be furnished along with the offer for each circuit breaker rating and type.
- 6.1.4 The circuit breakers controlling motors shall be suitable for DOL starting and stopping of induction motor a number of times.
- 6.1.5 The circuit breakers controlling capacitors shall be suitable for energizing and de-energizing the rated capacitor bank.
- 6.1.6 The circuit breakers shall be of the 3 phase, 4 pole horizontal draw out, horizontal isolation, air break type.
- 6.1.7 The circuit breaker shall be suitable for electrical or manual closing as specified. Manual operated breakers shall have independent manual spring closing mechanism. In case of electrically operated breaker, it shall have motor wound spring mechanism. In all cases tripping shall be by means of shunt trip coil.
- 6.1.8 All circuit breaker units of the same rating shall be physically and electrically interchangeable.
- 6.1.9 The circuit breakers shall be electrically and mechanically trip free and provided with anti-pumping feature.
- 6.1.10 Provision shall be made for slow closing for maintenance purposes. A suitable handle shall be provided one for each board for this purpose.
- 6.1.11 The circuit breakers shall have three positions i.e. service, test and isolated with the cubicle door closed. Necessary stoppers shall be provided to prevent the excessive movement of the breaker cradle than desired for the position. Service and test positions of the breaker shall have monitoring switch having 1NO+1NC contacts.
- 6.1.12 The circuit breaker shall be provided with emergency manual trip device, mechanical 'ON', 'OFF' and 'ISOLATED' position indicators and operation counter.
- 6.1.13 A maintenance truck/device for raising, lowering and withdrawal of the circuit breaker shall be supplied for each switch board.
- 6.1.14 The arc interrupting devices shall be capable of interrupting satisfactorily current from zero to the rated interrupting current when used on predominantly capacitive or inductive circuits, without requiring excessive maintenance of the contacts. The arc shall be restricted within the interrupting chamber and no emission of flame shall be allowed which may cause electrical breakdown or damage to insulation on the apparatus.
- 6.1.15 The main contacts shall be self aligning, adjustable and replaceable type.
- 6.1.16 The arcing contacts shall be easily accessible for maintenance and inspection and shall be easily replaceable type. They shall be provided with, contact face of special arc-resisting and non-pitting metal.
- 6.1.17 Mechanical safety interlock shall be provided for safe operation and movement of the breaker.
- 6.1.18 The circuit breakers shall be provided with minimum of four normally open and four normally closed auxiliary switch contacts, over and above those required for its own control scheme, for Owner's use. The contacts shall be wired separately to the terminal board.
- 6.2 Moulded Case Circuit Breakers**
- 6.2.1 The circuit breaker shall conform to IS/IEC 60947 and shall be of P2 category having rupturing capacity as per system requirement and mounted on a draw out chassis.
- 6.2.2 The circuit breaker shall be provided with spring assisted quick make quick break type manually operated trip free mechanism, mechanical 'ON', 'OFF' position indicators,

thermal tripping devices of inverse characteristics, instantaneous short circuit tripping devices and necessary auxiliary and alarm switches. The MCCB Chassis shall be provided with service, test and isolated position and automatic safety shutter.

- 6.2.3 The thermal and short circuit tripping devices shall be adjustable type.
- 6.2.4 When used for motor circuits, shunt trip device shall be provided and the let through power of controlling MCCB shall be lower than the respective contactor.
- 6.2.5 In addition, under voltage trip shall be provided.

6.3 Switches

- 6.3.1 The switches shall be motor duty type AC 23 Category and shall comply with the requirements laid down in IS/IEC 60947. Switches up to 63 Amps shall be rotary type and those of 100 Amps. & above, link type.
- 6.3.2 'ON' and 'OFF' position of the switches shall be indicated on the module. Provision shall be made to lock the switch in the 'OFF' position.
- 6.3.3 The fixed contacts shall be shrouded type. All contacts shall be silver plated.

6.4 Fuses

- 6.4.1 The fuses shall be of non-deteriorating HRC cartridge link type and shall conform to IS: 13703. They shall be suitable for the load and service required in the circuit.
- 6.4.2 One fuse puller shall be supplied along with each board.

6.5 Air Break Contactors

- 6.5.1 The Air Break Contactors shall be of Category AC3/AC4, unless otherwise specified, conforming to IS: 60947 and flapper type.
- 6.5.2 The dropout voltage shall not exceed 65% of rated voltage.
- 6.5.3 Each contactor shall be provided with auxiliary contacts as required. The rating of the auxiliary contacts shall be 5 Amps. AC or 1 Amp DC at the specified control voltages. The spare auxiliary contacts shall also be wired up to the terminal blocks.

6.6 Bimetal Thermal Overload Relays

- 6.6.1 The contactor shall be provided with three pole bimetal thermal overload relays, unless other-wise specified. The bimetal relays shall be of suitable range, ambient temperature compensated and shall be separate mounting type. They shall be adjustable through graduated scale and shall be provided with changeover contact. Thermal relays having long time/current characteristics, operated through saturated C.T.s shall be supplied, wherever required.
- 6.6.2 Bimetal thermal relays shall conform to IS: 3231 and IS/IEC 60947 and shall have built-in single phasing preventor.
- 6.6.3 The bimetal relays shall be provided with a manual resetting device resetable after opening module door. Auto reset thermal relays are not acceptable.

6.7 Current Transformers

- 6.7.1 The current transformers shall conform to IS: 2705.
- 6.7.2 C.T.s shall be Class F insulated and vacuum impregnated or resin cast. The C.T.s shall be rigidly mounted and shall be easily accessible for maintenance and testing.
- 6.7.3 The short time thermal withstand ratings of C.T.s shall be same as the thermal withstand rating of the breakers.
- 6.7.4 The C.T.s output shall be minimum 15VA for breaker feeders and 7.5 VA for the other feeders per phase and in any case, the output shall be adequate for the protection and

metering duties involved with sufficient margin. The C.T.s shall have the following accuracies for the various applications:

Application	Class of accuracy as per IS: 2705
--------------------	--

- | | |
|--|------|
| i) For metering service | - 1 |
| ii) For use with protective relays | - 5P |
| iii) For use with restricted earth fault and differential relays | - PS |

6.7.5 The C.T. cores for metering and protection shall be separate.

6.7.6 The ratio of C.T.s shall be as specified in Feeder details.

6.7.7 All the C.T.s shall be provided with terminals and shorting links. One of the terminals of the C.T. shall be earthed. The polarity of the C.T.s shall be clearly marked.

6.7.8 Provision of Interposing C.T.s is not acceptable.

6.7.9 The C.T.s shall be capable of withstanding momentary open circuit on the secondary side without injurious effects.

6.8 Voltage Transformers

6.8.1 The V.T.s shall be Class F insulated and vacuum impregnated or resin cast conforming to IS: 3156.

6.8.2 The primary nominal voltage shall be equal to the system nominal voltage. The secondary terminal voltage shall be 110 V.

6.8.3 The primary and secondary winding shall be protected by HRC fuses in each phase except in the ground phase of the secondary side.

6.8.4 The V.T.s shall be mounted on separate withdrawable carriage. The accuracy Class of V.T.s shall be 1.

6.8.5 The rated output of each V.T. shall be adequate for the relays, meters and associated wiring connected to it and shall not be less than 50 VA per phase.

6.9 Control Transformers

These shall be air cooled Class F insulated and vacuum impregnated. The rating of control transformer shall be twice the hold on VA of all contactor/relays or 2.5 KVA whichever is high. It shall be free from hum and rigidly mounted. Epoxy cast transformers shall be preferred.

6.10 Transformers for Kondorffer Starting

These shall be three phase core type, Class F insulated and vacuum impregnated. Tapping at 90%, 80%, 70% & 60% shall be provided and terminals shall be brought out for easy change of tapping at site. The operating temperature shall not exceed 80°C. The transformers shall be suitable for taking 7.5 times the specified full load current of the motor continuously for 120 secs.

6.11 Relays

6.11.1 All protective relays shall be of latest version, microprocessor based numerical type with communication port and interlinked with online energy management system. 100% redundancy shall be provided for communication.

6.12 Timers

The timers shall be electronic pneumatic or synchronous type with manual/auto reset

features as per the functional requirements. The time delay shall be 'ON' delay or 'OFF' delay type as specified. The repeat accuracy shall be 0.5% or better.

6.13 **Single Phasing Preventor**

6.13.1 Single phasing preventor relay shall be of the current operated type, suitable for the system voltage. The relay shall not operate for normal system voltage but operate positively in the event of unbalanced voltage more than the normal. The relay shall not operate in case of total interruption of power.

6.13.2 The relay shall be fail safe, self reset type and provided with flag indication. The relay operation shall be independent of the motor rating, loading and speed.

6.14 **Instruments and Meters**

6.14.1 All instruments shall be flush mounting type with square face of 96 mm x 96 mm. They shall be tropicalized and dust tight.

6.14.2 Meters shall be digital multifunctional meters with communication port for energy management at remote location.

6.14.3 All ammeters and voltmeters, to be provided separately, shall have 0-90° scale and shall be moving iron spring controlled type of class 1.5 accuracy as per IS: 1248. The scale range of the ammeters and voltmeters shall be as indicated in the Feeder details.

6.14.4 In case of motor feeders, the ammeters shall be graduated uniformly upto C.T. primary current and with compressed end scale upto 6 times C.T. primary current. Red pointer shall be provided, which shall be adjusted at site for indicating full load current of the motor.

6.15 **Push Buttons and Control Switches**

6.15.1 The switches and push buttons shall conform to utilization category AC11/DC11 as per IS: 60947. The contact shall be rated to make, break and carry inductive current of 5 Amp at 415 V AC and 1 Amp at 220 V DC.

6.15.2 The control switches shall be spring return rotary type, unless otherwise specified and provided with pistol grip type handle. The control switches for circuit breakers shall be additionally fitted with lost motion devices and sequencing devices.

6.15.3 The selector switches shall be stay put rotary type and provided with oval shape handles.

6.15.4 The push buttons shall be of momentary contact spring loaded type with a set of normally close and open contacts. The push button for 'Start' shall be shrouded type and coloured green, stop push button shall be un-shrouded type and coloured red and other push buttons shall be un-shrouded type coloured black. The fixing ring shall be metallic white.

6.15.5 Emergency stop push buttons, if specified, shall be lockable in pushed position.

6.16 **Miniature Circuit Breakers**

6.16.1 The miniature circuit breakers shall conform to IS: 8828 and shall be of duty category M-9.

6.16.2 It shall be provided with overload and short circuit protective devices in a heat resistant housing.

6.16.3 A certificate for short circuit rating and Current-Time tripping curve shall be furnished along with the offer.

6.17 **Signal Lamps**

6.17.1 Signal lamps shall be provided to indicate the various circuit conditions as shown in scheme drawings. The colour of the lamps for various functions shall be as follows :



TALCHER FERTILIZERS LIMITED
TECHNICAL SPECIFICATION - MEDIUM VOLTAGE
SWITCH BOARDS

PC183-TS-0805

0

Document No.

Rev

Sheet 14 of 16



- Red -- Circuit breaker/switch/contactor closed.
- Green -- Circuit breaker/switch/contactor open.
- White -- Trip circuit healthy.
- Amber -- Alarm and auto trip.
- Blue -- Non-Trip

6.17.2 All lamps shall be of LED type with lumen output of 200 mili candela in axial direction.

7.0 ACCESSORIES

7.1 The supply shall include the following accessories:

- Maintenance truck/device for raising, lowering and withdrawal of circuit breaker, if required.
- Fuse puller.
- Test plug for relays.
- Test plug for kWh meters.

7.2 Space Heater

Each vertical section shall be provided with a thermostatically controlled space heater, rated for 240 V, 50 Hz and controlled through double pole miniature circuit breaker.

7.3 Name Plates

7.3.1 The switchboard shall have large name plate on the top indicating its Name, Designation and Code No.

7.3.2 Each feeder shall be provided with name plate. Each single front panel shall have name plate indicating panel number both in front and back.

7.3.3 All control switches, push buttons, lamps etc. shall have functional identification labels.

7.3.4 Name plate shall be of black Perspex with white engraving and of minimum 3mm thick.

7.4 Any other accessories required, but not specified, shall also be supplied to make the switchboard complete in all respects and ensure safe and proper operation.

8.0 PAINTING

8.1 The enclosure, after degreasing, pickling in acid, cold rinsing, phosphatising, passivating etc. shall be painted with two coats of anti-rust paint followed by two coats of anticorrosive paint.

8.2 Epoxy based paint shall be used.

8.3 All paints shall be carefully selected to withstand tropical heat and extremes of weather. The paint shall not scale off, crinkle or be removed by abrasion due to normal handling.

8.4 Unless otherwise specified, the finishing shade shall be light grey having Shade No.631 as per IS: 5.

8.5 One litre of paint shall be supplied along with each board for touch up at site.

9.0 TESTS AND INSPECTION

9.1 All the switchboards shall be subjected to routine test as per IS: 8623 and their components as per relevant standards.

9.2 Additional tests, wherever specified, shall be carried out.

- 9.3 All the above tests shall be carried out in presence of Purchaser's representative. In addition, the equipment shall be subjected to stage inspection during process of manufacture at works and site inspection.
- 9.4 These inspections shall however, not absolve the vendor from their responsibility for making good any defect which may be noticed subsequently.
- 10.0 DRAWINGS AND DOCUMENTS**
- 10.1 Drawings and documents as per Annexure-I shall be supplied, unless otherwise specified.
- 10.2 All drawings and documents shall have the following description written boldly:
- Name of Client
 - Name of Consultant
 - Enquiry / Order Number with Project / Plant Name
 - Code No. & Description
- 11.0 SPARES**
- 11.1 Commissioning Spares : Commissioning spares, as required, shall be supplied with the main equipment. Item-wise list of recommended commissioning spares shall be furnished for information.
- 11.2 Spares for 2 Years Operation (Mandatory), as specified shall be supplied.
- 11.3 List of Recommend Spares (other than Mandatory Spares) alongwith recommended quantity shall be furnished.
- 11.4 All spare parts shall be identical to the parts used in the equipment
- 12.0 PACKING**
- 12.1 The board shall be properly packed before despatch to avoid damage during transport, storage and handling.
- 12.2 The packing box shall contain a copy of the installation, operation and maintenance manual.
- 12.3 A sign to indicate the upright position of the panels to be placed during transport and storage shall be clearly marked. Also proper arrangement shall be provided to handle the equipment.

ANNEXURE - I

DOCUMENTATION FOR MEDIUM VOLTAGE SWITCHBOARDS

SI.No.	Documentation Description	Documents Required (Y / N)		
		With Bid	For Approval	Final
1.	Specification Sheets	N	Y	Y
2.	Technical Particulars	N	Y	Y
3.	Feeder Details	N	Y	Y
4.	General arrangement and Foundation Drgs.	N	Y	Y
5.	Schematic and Wiring Diagrams	N	Y	Y
6.	Calculation for Bus-bar sizing	N	Y	N
7.	Terminal Arrangement Drgs.	N	Y	Y
8.	Illustrative and Descriptive Literature	N	N	Y
9.	Catalogues for bought out accessories.	N	N	Y
10.	Installation, Operation and maintenance manual.	N	N	Y
11.	Test Certificates			
	i) Type -- Switchboard	N	N	N
	-- Circuit Breaker	N	N	N
	-- MCCB's	N	N	N
	ii) Routine	N	N	Y
12.	Guarantee Certificates	N	N	Y
13.	Spare Parts List	N	N	Y

Note:

1. 4 hard copies & 1 soft copy shall be supplied for approval after order within 4 weeks from the date of LOI.
2. 8 hard copies & 2 soft copies in CD shall be submitted as final documents prior to despatch of the equipment. These shall be made in sets and supplied in fine plastic coated folder.

Y - Yes, N – No



TALCHER FERTILIZERS LIMITED
TECHNICAL SPECIFICATION - HIGH VOLTAGE
SWITCHBOARDS

PC183-TS-0806

0

Document No.

Rev

Sheet 1 of 13



TECHNICAL SPECIFICATION
HIGH VOLTAGE SWITCH BOARDS



TALCHER FERTILIZERS LIMITED
TECHNICAL SPECIFICATION - HIGH VOLTAGE
SWITCHBOARDS

PC183-TS-0806

0

Document No.

Rev

Sheet 2 of 13



CONTENTS

SECTION NUMBER	DESCRIPTION
1.0	SCOPE
2.0	STANDARDS TO BE FOLLOWED
3.0	SERVICE CONDITIONS
4.0	OPERATING REQUIREMENTS
5.0	DESIGN AND CONSTRUCTIONAL FEATURES
6.0	COMPONENT DETAILS
7.0	ACCESSORIES
8.0	PAINTING
9.0	TESTS AND INSPECTION
10.0	DRAWINGS AND DOCUMENTS
11.0	SPARES
12.0	PACKING
ANNEXURE - I	DOCUMENTATION FOR HIGH VOLTAGE SWITCHBOARDS

	TALCHER FERTILIZERS LIMITED TECHNICAL SPECIFICATION - HIGH VOLTAGE SWITCHBOARDS	PC183-TS-0806	0	
		Document No.	Rev	
		Sheet 3 of 13		

1.0 SCOPE

- 1.1 This standard covers the technical requirements of design, manufacture, testing at works and delivery in well-packed condition of High Voltage Switch Boards.
- 1.2 This standard shall be read in conjunction with relevant part of Design Philosophy – Electrical , Schematic diagrams etc.

2.0 STANDARDS TO BE FOLLOWED

- 2.1 The design, manufacture and testing of the equipment shall comply with the latest issues of the following standard, unless otherwise specified. Equipment complying with equivalent IEC standards shall also be acceptable.

IS: 3427 A.C. Metal enclosed switchgear and control gear for rated voltages above 1 kV up to and including 52 kV.

IS: 13118 Specification for high voltage alternating current circuit breakers.

IS: 5578 Guide for marking of insulated conductors.

IS: 11353 Guide for uniform system of marking and identification of conductors and apparatus terminals.

IS: 10118 Code of Practice for selection, installation and maintenance of switchgear and control gear.

Various components housed in the switchboards shall conform to the Indian Standards Specification as mentioned against the component details or IEC Specifications.

- 2.2 The design and operational features of all the equipment offered shall also comply with the provisions of the latest issue of the Indian Electricity Rules and other Statutory Acts and Regulations. The supplier shall, wherever necessary, make suitable modifications in the equipment to comply with the above.
- 2.3 Wherever any requirement, laid down in this standard, differs from that in Indian Standard Specifications / IEC Specification, the requirement specified herein shall prevail.

3.0 SERVICE CONDITIONS

3.1 Ambient Conditions

These shall be as indicated in Design Philosophy – Electrical.



3.2 System Details

These shall be as indicated in Design Philosophy – Electrical.

4.0 OPERATING REQUIREMENTS

The switchboards shall be suitable for operating at the specified rating continuously, with the specified voltage and frequency variations under the ambient conditions, without exceeding the permissible temperature rise and without any detrimental effect on any part.

5.0 DESIGN AND CONSTRUCTIONAL FEATURES

	TALCHER FERTILIZERS LIMITED TECHNICAL SPECIFICATION - HIGH VOLTAGE SWITCHBOARDS	PC183-TS-0806	0	
		Document No.	Rev	
		Sheet 4 of 13		

5.1 General

- 5.1.1 The switchboards shall consist of an assembly of a series of floor mounting, identical, metal clad, cubicle type panels placed side by side to form a compact assembly and shall be extensible on either side.
- 5.1.2 The complete assembly shall be dust, damp and vermin proof having minimum degree of protection equivalent to IP4X as per IS/IEC:60529. However, in case some ventilation openings are to be provided, these may be permitted for equipment located indoors and such openings shall be covered by fine wire mesh ensuring minimum IP3X protection.
- 5.1.3 The framework of the cubicles shall be bolted / welded construction. The minimum thickness of sheet steel shall be 3 mm for base channel and 2 mm for other members. The doors and covers shall be fabricated from cold rolled sheet steel. Suitable reinforcement, wherever necessary, shall be provided.
- 5.1.4 The switchboard shall be mounted on the channel which shall be included in the vendor's scope.
- 5.1.5 Each cubicle shall be provided with front access door with handle lock and key for breaker compartment and a removable back cover. The door hinges shall be concealed type. Front doors of the panels shall mechanically stop in full open position to facilitate removal of breakers and for ease of maintenance.
- 5.1.6 All external hardwares shall be cadmium plated. The hardwares for fixing removable parts shall be provided with retaining devices.
- 5.1.7 The doors and the removable covers shall be provided with non-deteriorating neoprene gaskets. Gaskets without any discontinuity shall be preferred. Gaskets shall be held in position in groove, in shaped sheet steel work or these shall be U-type.
- 5.1.8 Each cubicle shall have separate compartment within the cubicle for circuit breaker, bus-bars, instrument transformers, metering and relaying devices and cable termination.
- 5.1.9 Inter-panel and inter-compartment fire resistant barrier shall be provided. Cast resin seal off bushing shall be provided in the bus compartment, through which connections to breaker compartment/cable compartment/bus compartment of adjacent panel shall be taken. Failure of one of the equipment shall not effect the equipment in the adjacent compartment.
- 5.1.10 All the components shall be accessible for inspection and maintenance without the necessity of removing the adjacent ones. Their mounting shall be accessible and ensure the necessary degree of safety.
- 5.1.11 The layout of the components inside the cubicle shall be liberal to facilitate maintenance and the interconnecting wiring between components shall not be subjected to undue stresses at the bends.
- 5.1.12 Mounting height of components requiring operation and maintenance shall not be lower than 300 mm and higher than 1800 mm.
- 5.1.13 All live parts which are accessible after opening of front and back door/cover shall be properly insulated or provided with insulating barrier to prevent accidental contact. Phase insulating barriers shall be provided between the breaker poles. Removal facility shall be provided for all such barriers.
- 5.1.14 Adequate arrangement for earthing shall be provided to safeguard the operator or other personnel from electric hazards under all conditions of operation.
- 5.1.15 The switchboard shall be provided with following interlocks and safety features:
- i) The withdrawal and engagement of a circuit breaker shall not be possible unless it is in open position.



TALCHER FERTILIZERS LIMITED
TECHNICAL SPECIFICATION - HIGH VOLTAGE
SWITCHBOARDS

PC183-TS-0806

0

Document No.

Rev

Sheet 5 of 13



- ii) The operation of a circuit breaker shall not be possible unless it is in fully service, test or isolated position.
- iii) It shall not be possible to close the circuit breaker in service position unless all auxiliary and control circuits are connected.
- iv) A breaker of the lower rating shall be prevented from engaging with the stationary element of higher rating.
- v) Insertion of the manual mechanism shall render the motorized mechanism inoperable.
- vi) Circuit breaker "ON", "OFF" indication shall be provided at the back of each panel.
- vii) Caution name plate shall be provided at the back of incomer panels where terminals are likely to remain live and isolation is possible only from remote end.
- viii) Automatic safety shutter, with padlocking facility for locking in closed position, to completely cover the spouts for bus-bars and cable connection when the breaker is withdrawn.

5.2 Bus-Bars and Connections

- 5.2.1 The bus-bars shall be for three phases. The bus-bars and connection shall be made of electrolytic grade copper of rectangular cross-section.
- 5.2.2 Bus-bars and connections shall be sleeved to protect against approach to live parts and to eliminate potential arcing points. Sleeving material shall have adequate electrical, thermal and mechanical properties to withstand impulse level, temperature rise during normal and short circuit condition and allow easy bending of bus bars.
- 5.2.3 The bus-bars shall be amply sized to carry the rated continuous current under the specified ambient temperature without exceeding the limits specified in IS: 8084. The thermal rating of the bus-bars shall be designed to withstand the system fault current for 3 seconds without exceeding the limiting temperature of 250°C for bare copper. Calculation for bus-bar sizing shall be furnished along with the offer.
- 5.2.4 Horizontal bus-bars shall run in a separate compartment through the entire length of the board and shall be of same cross-section throughout. Stepped bus-bars shall not be acceptable.
- 5.2.5 The bus-bars shall be arranged and colour coded according to IS: 5578 & IS: 11353.
- 5.2.6 The bus-bars chamber shall be sufficiently spacious and shall have separate screwed covers for maintenance purpose. It shall be adequately ventilated and shall allow the escape of the hot gases.
- 5.2.7 The bus-bars shall be rigidly supported at equal intervals to withstand the stresses due to full short circuit and also to take care of thermal expansion.
- 5.2.8 A minimum of two bolts shall be used per bus-bar joint. Only high tensile electro galvanized cadmium plated bolts, nuts and washers shall be used. The washers shall be spring and plain type. The bus-bar supports shall be of molded construction with built-in anti-tracking barriers. The support materials shall be of DMC or fiber glass reinforced thermosetting plastic.
- 5.2.9 The bus-bars, both horizontal and vertical, shall be PVC sleeved. Insulating shrouds shall be provided for all joints of insulated bus-bars.

5.3 Earth Bus

A continuous earth bus of Aluminium running along the lower part of the switchboard shall be provided with two end terminals with lugs for external connection. The earth bus shall be rated to carry three phase fault current for a period of 3 sec.

5.4 Bus Duct



TALCHER FERTILIZERS LIMITED
TECHNICAL SPECIFICATION - HIGH VOLTAGE
SWITCHBOARDS

PC183-TS-0806

0

Document No.

Rev

Sheet 6 of 13



- 5.4.1 Suitable extension of bus-bars in proper phase sequence on the top, with connecting bolts shall be provided where connections between transformer and switchboard or between two halves of the switchboard is specified to be through bus duct.
- 5.4.2 Bus duct between two halves of the switchboard, if required, shall be supplied by the switchboard manufacturer. The bus-bars of interconnecting bus duct shall be similar to the main bus-bars of switchboard as specified above and shall conform to IS: 8084.
- 5.4.3 Bus duct between transformer and switchboard, if included in vendor's scope shall conform to IS: 8084.
- 5.5 **Clearances and Creepage Distance**
- The clearance and creepage distance shall be adequate to meet the BIL of the equipment.
- 5.6 **Insulation**
- 5.6.1 The insulation used shall be non-hygroscopic and shall be of porcelain, epoxy resins or fiber glass molded with plastic. It shall be of adequate electrical, mechanical and thermal strength to give trouble free service during normal operation and short circuit conditions.
- 5.6.2 The insulation shall be treated suitably to withstand the tropical conditions and atmospheric pollution.
- 5.7 **Control Wiring**
- 5.7.1 The switchboard shall be completely factory wired and ready for external connections.
- 5.7.2 The wiring shall be complete in all respect so as to ensure proper functioning of control, interlocking, protection, metering, indications and annunciations.
- 5.7.3 The wiring shall be carried out with flexible stranded PVC insulated copper conductor cables of 1100 Volt grade. The minimum size of wires shall be as follows:
- | | | |
|---------------------------|----|------------|
| C.T. Circuit | -- | 2.5 Sq. mm |
| V.T. and Control Circuits | -- | 1.5 Sq. mm |
- 5.7.4 All wiring shall be provided with dependent both ends marking as per IS: 5578. Numbered ferrules, reading from the terminal outwards, shall be provided at both ends of all wiring for easy identification. These shall be interlocking type plastic ferrules.
- 5.7.5 Control wiring circuits, fed from a supply common to a number of panels, shall be so protected that failure of a circuit in one panel does not affect the operation of other panels.
- 5.7.6 The wiring to the equipment mounted on the doors shall be carried out with flexible multi-strand copper conductor cable and so supported that on opening of the door, there is no undue strain on wire leads.
- 5.7.7 The control cables shall be neatly arranged and properly supported.
- 5.8 **External Cable Termination**
- 5.8.1 All power and control cables shall enter the switchboard from the bottom on the back of the panel. Sufficient space shall be provided for ease of connection and termination of cables.
- 5.8.2 All power cables and control cables shall be of type, number and size as indicated in Feeder Details.
- 5.8.3 The termination arrangement for single core cables shall be such that so as to minimize flow of eddy current and heating due to eddy currents.
- 5.8.4 Heavy duty double compression type rolled Aluminium cable glands along with the

	TALCHER FERTILIZERS LIMITED TECHNICAL SPECIFICATION - HIGH VOLTAGE SWITCHBOARDS	PC183-TS-0806	0	
		Document No.	Rev	
		Sheet 7 of 13		

cable lugs, as required shall be provided for termination of control cables and auxiliary power supply cables.

- 5.8.5 The cable glands shall be mounted on a removable gland plate, provided at a minimum height of 75 mm from the bottom of the switchboard. Two number spare knockouts of size 20 mm shall also be provided on the gland plate for future use.
- 5.8.6 Terminal blocks shall be provided at suitable locations inside the panels for termination of control and auxiliary power supply wiring. These terminal blocks shall be pressure clamp type up to 35 sq. mm cables and bolted lug type for higher sizes of cables. These shall be protected type and rated for 1100 Volt service. The minimum current rating of the terminal block shall be 16 Amp.
- 5.8.7 Where more than two cables in parallel are required to be terminated, a system of bus links shall be provided with adequate clearance and spacing.
- 5.8.8 The terminal block shall be grouped according to circuit functions and numbered suitably. 20% extra terminals shall be provided in the terminal block.
- 5.8.9 Suitable clamps to support the vertical run of cables shall be provided.
- 5.8.10 For power connections, suitable marking on the terminals shall be provided to identify the phases.

5.9 Feeder Details

- 5.9.1 The requirements of incomer, bus coupler and outgoing feeders shall be as indicated in the single line diagram, feeder details and corresponding schematic diagrams.
- 5.9.2 Non-paralleling interlocks shall be provided between incomers and bus section panels. The interlocks shall be either electrical or mechanical type. Arrangement for defeating the interlock shall also be provided.
- 5.9.3 Auto changeover scheme, wherever specified, shall be provided.

5.10 Dummy Panels

Dummy panels complete with bus-bar system in 400 mm width shall be required for which unit price shall be indicated.

5.11 Control Power Supply

- 5.11.1 D.C. power required for closing, tripping and indication shall be supplied at the bus coupler panel through two completely separate circuits by the owner, one for tripping and another for closing and indication for the whole board.
- 5.11.2 For receiving each external control power supply, a double pole miniature circuit breaker shall be provided. This power shall be distributed inside the switchboard for each feeder having its MCB unit.

5.12 Space Heater Power Supply

- 5.12.1 Panel space heaters shall be fed from a separate bus, common for the whole board. This bus shall be fed from owner's supply for which a double pole MCB shall be provided in bus section panel.
- 5.12.2 Power supply for space heaters of motors shall be tapped from this bus by means of miniature circuit breakers located in the motor feeder panels. These MCB's shall be of triple pole and rated for 15 Amp.

6.0 COMPONENT DETAILS

Makes of all components shall be subject to owner's / consultant's approval



TALCHER FERTILIZERS LIMITED
TECHNICAL SPECIFICATION - HIGH VOLTAGE
SWITCHBOARDS

PC183-TS-0806

0

Document No.

Rev

Sheet 8 of 13



6.1 Circuit Breakers

- 6.1.1 The circuit breakers shall comply with the requirements of IS: 13118.
- 6.1.2 All circuit breakers shall be of 0-3 min-CO-3 min-CO rated operating sequence capable of carrying the specified current at the site conditions and making/breaking of the system fault current.
- 6.1.3 Type test certificates from an independent testing authority shall be furnished along with the offer for each circuit breaker rating and type.
- 6.1.4 The circuit breakers controlling motors shall be suitable for DOL starting and stopping induction motor a number of times and shall have provision to limit over voltage to the value safe for motor insulation. Unless otherwise specified this value shall be taken as 2.5 times the rated voltage. The magnitude of the voltage surge produced by the breaker when switching off the smallest motor shall be indicated.
- 6.1.5 The circuit breakers controlling capacitors shall be suitable for energizing and de-energizing the rated capacitor bank.
- 6.1.6 The circuit breakers shall be of the 3 phase, single/double break, horizontal draw-out, vertical/horizontal isolation type. The medium of arc quenching shall be minimum Oil/Bulk oil/vacuum/SF6 as specified elsewhere.
- 6.1.7 The circuit breakers shall be suitable for electrical/manual closing as specified in Feeder details. Electrically operated circuit breakers shall preferably have motor wound spring closing mechanism with provision for manual closing arrangement. Manually operated circuit breakers shall have independent manual spring closing mechanism. In all cases tripping shall be by means of shunt trip coil.
- 6.1.8 All circuit breaker units of the same rating shall be physically and electrically interchangeable.
- 6.1.9 The circuit breakers shall be electrically and mechanically trip free and provided with anti-pumping feature.
- 6.1.10 The circuit breakers shall have three positions, i.e. service, test and isolated with the cubicle door closed. Necessary stoppers shall be provided to prevent the excessive movement of the breaker cradle than desired for the position. Service and test positions of the breaker shall have monitoring switch having 1NO+1NC contacts.
- 6.1.11 The circuit breakers shall be provided with emergency manual trip device, mechanical 'ON', 'OFF', 'ISOLATED' position and spring 'CHARGED', 'DISCHARGED' indicators and operation counter.
- 6.1.12 A maintenance truck/device, if required, for raising, lowering and withdrawals of the circuit breaker shall be supplied for each switchboard.
- 6.1.13 The arc interrupting devices shall be capable of interrupting satisfactorily current from zero to the rated interrupting current when used on predominantly capacitive or inductive circuits, without requiring excessive maintenance of the contacts. The arc shall be restricted within the interrupting chamber and no emission of flame shall be allowed which may cause electrical breakdown or damage to insulation on the apparatus.
- 6.1.14 Mechanical safety interlock shall be provided for safe operating and movement of the breaker.
- 6.1.15 The circuit breakers shall be provided with minimum of four normally open and four normally closed auxiliary switch contacts, over and above those required for its own control scheme, for owner's use. These contacts shall be wired separately to the terminal board.
- 6.1.16 The closing coil and other associated auxiliary relays shall operate satisfactorily at all



TALCHER FERTILIZERS LIMITED
TECHNICAL SPECIFICATION - HIGH VOLTAGE
SWITCHBOARDS

PC183-TS-0806

0

Document No.

Rev

Sheet 9 of 13



voltages between 85% and 110% of the rated control voltage. The tripping coil and other associated relays shall operate satisfactorily at all voltages between 70% and 110% of the rated control voltage.

6.1.17 Cable earthing facility shall be provided in the circuit breaker for discharging of power cable through the circuit breaker contact with circuit breaker in drawn-out position. An integral earthing arrangement shall be preferred. In case the integral earthing arrangement is not feasible due to circuit breaker design, a separate earthing truck, which shall be inserted in place of circuit breaker, shall be provided per board.

6.1.18 Positive earthing of circuit breaker frame shall be maintained at every position of circuit breaker. The earthing contact shall be line/scraping type and not of point type.

6.2 Current Transformers

6.2.1 The current transformers shall conform to IS: 2705.

6.2.2 C.T.s shall be class F insulated and vacuum impregnated or resin cast type. The C.T.s shall be rigidly mounted and shall be easily accessible for maintenance and testing.

6.2.3 The short time thermal withstand ratings of the C.T.s shall be same as the thermal withstand ratings of the breakers.

6.2.4 The C.T.s output shall be minimum 15 VA per phase and in any case, the output shall be adequate for the protection and metering duties involved with sufficient margin. The C.T.s shall have the following accuracies for the various applications:

<u>Application</u>	<u>Class of Accuracy as per IS: 2705</u>
i) For metering service	1
ii) For use with protective relays	5 P
iii) For use with restricted earth fault and differential relays	PS

6.2.5 The C.T. cores for metering and protection shall be separate.

6.2.6 The ratios of the current transformers shall be as indicated in Feeder details.

6.2.7 All the C.T.s shall be provided with terminals and shorting links. One of the terminals of the C.T. shall be earthed. The polarity of the C.T. shall be clearly marked.

6.2.8 Provision of interposing C.T. is not acceptable.

6.2.9 The C.T.s shall be capable of withstanding momentary open-circuit on the secondary side without injurious effects.

6.3 Voltage Transformers

6.3.1 The V.T.s shall be class F insulated and vacuum impregnated or resin cast type conforming to IS: 3156.

6.3.2 The primary nominal voltage shall be equal to the system nominal voltage. The secondary terminal voltage shall be $110 / \sqrt{3}$ V.

6.3.3 The rated output of each VT shall be adequate for the relays, meters and associated wiring connected to it with sufficient margin and shall not be less than 200 VA per phase.

6.3.4 The accuracy class of V.T.s shall be 1 as per IS: 3156.

6.3.5 The primary and secondary winding shall be protected by HRC fuses in each phase except in the grounded phase of the secondary side.

6.3.6 The V.T. shall be mounted on a with-drawable carriage. Shutters with padlocking facility, provided on high voltage sides, shall be so arranged that the live orifices are



TALCHER FERTILIZERS LIMITED
TECHNICAL SPECIFICATION - HIGH VOLTAGE
SWITCHBOARDS

PC183-TS-0806

0

Document No.

Rev

Sheet 10 of 13



automatically closed when the V.T. is withdrawn.

6.3.7 Mechanical interlocking arrangement shall be provided so that the access to the high voltage fuse is possible only when the V.T. is fully withdrawn.

6.4 Relays

6.4.1 All protective relays shall be of latest version, microprocessor based numerical type with communication port and interlinked with online energy management system. 100% redundancy shall be provided for communication.

6.5 Timers

6.5.1 The timers shall be electronic, pneumatic or synchronous type with manual/ auto reset features as per the functional requirements. The timers shall be 'ON' delay or 'OFF' delay type as specified. The repeat accuracy shall be 0.5% or better.

6.6 Instruments and Meters

6.6.1 All instruments shall be flush mounting type with square face of 96 mm x 96 mm. They shall be tropicalized and dust tight.

6.6.2 Meters shall be digital multifunctional meters with communication port for energy management at remote location.

6.6.3 All ammeters and voltmeters, to be provided separately, shall have 0-90° scale and shall be moving iron spring controlled type of class 1.5 accuracy as per IS: 1248. The scale range of the ammeters and voltmeters shall be as indicated in the Feeder details.

6.6.4 In case of motor feeders, the ammeters shall be graduated uniformly upto C.T. primary current and with compressed end scale upto 6 times C.T. primary current. Red pointer shall be provided, which shall be adjusted at site for indicating full load current of the motor.

6.7 Push Buttons and Control Switches

6.7.1 The switches and push buttons shall conform to utilization category AC11/DC11 as per IS/IEC:60947. The contact shall be rated to make, break and carry inductive current of 5 Amps. at 415 V AC and 1 Amp. at 220 V DC.

6.7.2 The control switches shall be spring return rotary type, unless otherwise specified and provided with Pistol grip type handle. The control switches for circuit breakers shall be additionally fitted with lost motion devices and sequencing devices, if required.

6.7.3 The selector switches shall be stay put rotary type and provided with oval shape handles.

6.7.4 The push buttons shall be of momentary contact spring loaded type with a set of normally close and open contacts. The start push button shall be shrouded type and coloured green. The stop push button shall be un-shrouded type and coloured red and other push buttons shall be un-shrouded type and coloured black. The fixing ring shall be metallic white.

6.7.5 Emergency stop push buttons, if specified, shall be lockable in pushed position.

6.8 Control Fuses

6.8.1 The fuses shall be non-deteriorating HRC cartridge link type and shall conform to IS: 13703. They shall be suitable for load and service required in the circuit.

6.8.2 One fuse puller shall be supplied along with each board.

6.9 Miniature Circuit Breakers

6.9.1 The miniature circuit breakers shall conform to IS: 8828 and shall be of duty category M-9.

	TALCHER FERTILIZERS LIMITED TECHNICAL SPECIFICATION - HIGH VOLTAGE SWITCHBOARDS	PC183-TS-0806	0	
		Document No.	Rev	
		Sheet 11 of 13		

6.9.2 It shall be provided with overload and short circuit protective devices in a heat resistant housing.

6.9.3 Type test certificate for short circuit rating and current time tripping curve shall be furnished along with the offer.

6.10 Signal Lamps

6.10.1 Signal lamps shall be provided to indicate the various circuit conditions as shown in scheme drawings. The colour of the lamps for various functions shall be as follow:

- | | | |
|-------|---|-----------------------|
| Red | - | Circuit breaker 'ON' |
| Green | - | Circuit breaker 'OFF' |
| White | - | Trip circuit healthy |
| Amber | - | Alarm and auto trip |
| Blue | - | Non-Trip |

6.10.2 The lamps shall LED type with lumen output of 200 millicandella in axial direction.

7.0 ACCESSORIES

7.1 The supply shall include the following accessories.

- Maintenance truck/device for raising, lowering and withdrawal of circuit breaker, if required.
- Earthing truck, in case the integral earthing arrangement is not feasible in the circuit breaker.
- Fuse puller.
- Test plug for relays.
- Test plug for kWh meters.
- Special tools and tackles, as required.

7.2 Space Heater

7.2.1 Each panel shall be provided with a thermostatically controlled space heater, rated for 240 V, 50 Hz and controlled through double pole miniature circuit breaker.

7.3 Name Plates

7.3.1 The switchboard shall have large name plate on the top to indicate its name and designation.

7.3.2 Each panel shall be provided with name plate both in front and back.

7.3.3 All control switches, push buttons, lamps etc. shall have functional identification labels.

7.3.4 Name plate shall be of black Perspex with white engraving and of minimum 3 mm thick.

7.4 Any other accessories required, but not specified, shall also be supplied to make the switchboard complete in all respects and ensure safe and proper operation.

8.0 PAINTING

8.1 The enclosure, after degreasing, pickling in acid, cold rinsing, phosphatising, passivating etc. shall be painted with two coats of anti-rust paint followed by two coats of anti-corrosive paint.

8.2 Epoxy based paint shall be used.

8.3 All paints shall be carefully selected to withstand tropical heat and extremes of weather. The paint shall not scale off, crinkle or be removed by abrasion due to normal handling.

	TALCHER FERTILIZERS LIMITED TECHNICAL SPECIFICATION - HIGH VOLTAGE SWITCHBOARDS	PC183-TS-0806	0	
		Document No.	Rev	
		Sheet 12 of 13		

8.4 Unless otherwise specified, the finishing shade shall be light grey having shade No.631 as per IS: 5.

8.5 One litre of paint shall be supplied along with each board for touch up at site.

9.0 TESTS AND INSPECTION

9.1 All the switchboards shall be subjected to routine test as per IS: 3427 and their components as per relevant standards.

9.2 Additional tests, wherever specified, shall be carried out.

9.3 All the above tests shall be carried out in presence of purchaser's representative. In addition, the equipment shall be subjected to stage inspection during process of manufacture at works and site inspection.

9.4 These inspection shall, however, not absolve the vendor from his responsibility for making good any defect which shall be noticed subsequently.

10.0 DRAWINGS AND DOCUMENTS

10.1 Drawings and documents as per Annexure-I shall be supplied, unless otherwise specified.

10.2 All drawings and documents shall have the following description written boldly.

- Name of client
- Name of consultant
- Enquiry / Order Number with plant / project name
- Code No. and Description

11.0 SPARES

11.1 Commissioning Spares : Commissioning spares, as required, shall be supplied with the main equipment. Item-wise list of recommended commissioning spares shall be furnished for information.

11.2 Spares for 2 Years Operation (Mandatory), as specified shall be supplied.

11.3 List of Recommend Spares (other than Mandatory Spares) alongwith recommended quantity shall be furnished.

11.4 All spare parts shall be identical to the parts used in the equipment.

12.0 PACKING

12.1 The switchboard shall be properly packed before dispatch to avoid damage during transport, storage and handling.

12.2 The packing box shall contain a copy of the installation, operation and maintenance manual.

12.3 A sign to indicate the upright position of the panels to be placed during transport and storage shall be clearly marked. Also proper arrangement shall be provided to handle the equipment.



ANNEXURE - I
DOCUMENTATION FOR HIGH VOLTAGE SWITCHBOARDS

Sl. No.	Description	Documents Required (Y / N)		
		With Bid	For Approval	Final
1.	Specification Sheets	N	Y	Y
2.	Technical Particulars	N	Y	Y
3.	Feeder Details	N	Y	Y
4.	General arrangement and Foundation Drawings	N	Y	Y
5.	Schematic/Wiring Diagrams	N	Y	Y
6.	Calculation for Bus-bar sizing	N	Y	N
7.	Terminal Arrangement Drawings	N	Y	Y
8.	Illustrative and Descriptive Literature	N	N	Y
9.	Catalogues for bought out accessories	N	N	Y
10.	Installation, Operation and maintenance manual	N	N	Y
11.	Test Certificates			
	i) Type - Switchboard	N	N	N
	- Circuit Breaker	N	N	N
	- MCB	N	N	N
	ii) Routine	N	N	Y
12.	Guarantee Certificates	N	N	Y
13.	Spare Parts List	N	N	Y

Note:

1. 4 hard copies & 1 soft copy shall be supplied for approval after order within 4 weeks from the date of LOI.
 2. 8 hard copies & 2 soft copies in CD shall be submitted as final documents prior to despatch of the equipment. These shall be made in sets and supplied in fine plastic coated folder.
- Y - Yes, N – No



TALCHER FERTILIZERS LIMITED
TECHNICAL SPECIFICATION - BUS DUCT

PC183-TS-0807

0

Document No.

Rev

Sheet 1 of 8



TECHNICAL SPECIFICATION

BUS DUCT



CONTENTS

SECTION NUMBER	DESCRIPTION
1.0	SCOPE
2.0	STANDARDS TO BE FOLLOWED
3.0	SERVICE CONDITIONS
4.0	OPERATING REQUIREMENTS
5.0	GENERAL DESIGN AND CONSTRUCTIONAL FEATURES
6.0	ACCESSORIES
7.0	LAYOUT
8.0	PAINTING
9.0	TESTS AND INSPECTION
10.0	DRAWINGS AND DOCUMENTS
11.0	SPARES
12.0	PACKING
ANNEXURE - I	DOCUMENTATION FOR BUS DUCT

1.0 SCOPE

- 1.1 This standard covers the technical requirements of design, manufacture testing at works and despatch in well packed condition of bus duct.
- 1.2 This standard shall be read in conjunction with relevant part of Design Philosophy - Electrical.

2.0 STANDARDS TO BE FOLLOWED

- 2.1 The design, manufacture and testing of the equipment covered by this standard shall comply with the latest issue of following Indian Standards unless otherwise specified. Equipment complying with equivalent IEC standards shall also be acceptable.

- IS: 8084 - Interconnecting bus-bars for A.C. Voltage above 1 KV up to and including 36 KV.
- IS: 8623 - Specification for low voltage switchgear and control gear assemblies.
- IS: 5578 - Guide for marking of insulated conductors.
- IS: 11353 - Guide for uniform system of marking and identification of conductors and apparatus terminals.

- 2.2 The design and operational features of all the equipment offered shall also comply with the provisions of the latest issue of the Indian Electricity Rules and other relevant Statutory Acts and Regulations. The supplier shall wherever necessary, make suitable modifications in the equipment to comply with the above.

- 2.3 Wherever any requirement, laid down in this standard differs from those in Indian Standard Specifications, the requirement specified herein shall prevail.

3.0 SERVICE CONDITIONS

3.1 Ambient conditions

These shall be as indicated in Design Philosophy - Electrical.

3.2 System Details

These shall be as indicated in Design Philosophy - Electrical.

4.0 OPERATING REQUIREMENTS

The bus duct shall be suitable for operating at the rated capacity continuously under the ambient conditions and with the voltage and frequency variations without exceeding the permissible temperature rise and without any detrimental effect on any part.

5.0 GENERAL DESIGN AND CONSTRUCTIONAL FEATURES

5.1 Enclosures

- 5.1.1 The sheet steel enclosure for enclosing and supporting the bus-bars shall be made out of 14 SWG sheet steel, bolted on the angle iron frame work.

- 5.1.2 The enclosure shall completely enclose the bus bars from all sides. It shall have degree of protection IP: 52 for indoor installation and IP: 55 with rain protection canopy for outdoor installation as per IS/IEC:60947. Where part of the bus duct is required for indoor installation and part for outdoor installation, the complete section shall be suitable for outdoor installation. Ventilation louvers, if necessary, shall be provided with fine wire mesh from inside, in that case the degree of protection shall be IP: 42. Neoprene gasket shall be provided on covers at joints.



TALCHER FERTILIZERS LIMITED
TECHNICAL SPECIFICATION - BUS DUCT

PC183-TS-0807

0

Document No.

Rev

Sheet 4 of 8



5.1.3 Whether bus duct (with louvers) is installed outdoor or indoor, suitably rated space heater with thermostat control shall be provided at different locations inside the bus duct to avoid moisture condensation.

5.1.4 All external hardware of diameter less than 8 mm shall be stainless steel and those of diameter 8 mm and above shall be mild steel cadmium plated or zinc passivated.

5.2 Bus Bars and Connections

5.2.1 The bus-bars in LV Bus duct shall be of three phase and neutral, non-segregated and air insulated type.

The bus-bars in HV Bus duct shall be of three phase, phase-segregated with insulating material.

5.2.2 The bus bars shall be amply sized to carry the rated continuous current under the specified ambient temperature without exceeding the temperature limits specified in IS: 8084. The bus bars shall be designed to withstand the system fault current for one second without exceeding the total temperature of 200°C. Type test certificate of similar bus duct shall be furnished.

5.2.3 The bus-bars material shall be high conductivity Aluminium alloy conforming to grade E91E of IS: 5082/electrolytic grade copper.

5.2.4 The bus-bars shall be rectangular in shape and cross-sectional area of neutral bus-bars shall be half of phase bus-bars.

5.2.5 The sizes of bus-bars selected shall be subjected to approval by PDIL. The vendor shall furnish supporting calculations for bus-bars and enclosure sizes both under normal load and short circuit conditions as well as that of temperature rise along with the offer.

5.2.6 All the bus-bars shall be bare and without any painting. The bus-bars shall be arranged and provided with proper phase identification as per IS: 5578/11353.

5.3 Joints and Bends

5.3.1 Only lap joints shall be used for jointing the bus bars. The over lap shall be equal to the width of the bus bars.

5.3.2 The contact surfaces of the overlapping bus-bars shall be thoroughly cleaned followed by application of good quality electrical grease and bolted immediately. In case of Aluminium to copper joints, copper bus-bars in addition shall be preferably tinned.

5.3.3 The bolting schedule adopted shall ensure proper contact pressure. A minimum of two bolts shall be used per joint.

5.3.4 The contact pressure shall be 100-140 kg/cm². Only high tensile, zinc passivated or galvanized steel bolts shall be used along with large diameter flat washers of adequate thickness.

5.3.5 At the bends, the bus-bars shall bend at a radius of 2t where the 't' is the thickness of the bus-bars and the radius is measured to the inside of bus-bars.

5.4 Flexible Joints

Flexible joints and connections shall consist of tinned laminated copper strips or Aluminium strips of required cross sectional area. Precautions as mentioned under 5.3.2 shall also be observed while marking joints with laminated copper plates. Filler plates of Aluminium as required shall be used.

5.5 Expansion Joints

Expansion joints, where necessary, to allow for longitudinal expansion and contraction of bus-bars and bus enclosures caused by temperature variation shall be provided.



5.6 Bus Bar Supports

5.6.1 The bus-bars shall be rigidly supported at equal intervals. The bus-bars supports shall be such that they withstand stresses to which they may be subjected under normal and short circuit conditions.

5.6.2 The supports shall be of moulded construction of fibre glass reinforced with thermosetting plastics or superior materials. The supports, where necessary, shall either have built-in anti-tracking barriers or painted with anti-tracking varnishes.

5.7 Clearances and Creepage Distance

5.7.1 The clearances and creepage distance shall not be lower than the values specified below for any part of the bus duct.

- | | | | |
|------|---|---|-------|
| i) | Minimum clearance between two live parts | - | 25 mm |
| ii) | Minimum clearance between a live part and accidentally dangerous part | - | 25 mm |
| iii) | Creepage distance | - | 30 mm |

5.7.2 The clearances and creepage distance, as specified above, shall definitely be maintained throughout the bus bars system. Provision of bus-bar separators or barriers shall not be considered to reduce the clearances from the values specified above.

5.8 Terminal Chambers at Switchgear and Transformer End

5.8.1 The bus duct shall be suitable for bolting to the flanges provided at the transformer and switchgear end. The exact dimensions and details of these terminal chambers shall be made available at the time of execution.

5.8.2 Phase changeover arrangement wherever required shall be provided in one of the terminal chambers to connect the bus-bars between same phase terminals at switchgear and transformer ends.

6.0 ACCESSORIES

6.1 Earthing

Two continuous earth strips of Aluminium having minimum 300 sq. mm size shall be provided throughout the length of bus duct or shall be suitable for full short circuit fault current for 1 sec. whichever is more.

6.2 Drain Plug

Bus duct shall be provided with drain plug to remove condensed moisture when required.

6.3 Fire Barriers

Two sets of epoxy moulded fire barriers shall be provided on switchgear end as well as transformer end.

6.4 Name Plates

6.4.1 Each bus duct shall be provided with a name plate of stainless steel with letter embossed on them and located at convenient location.

6.4.2 The name plate shall contain all details as per IS: 8084.

6.5 Hardware

Required number of hardwares like bolts, nuts, plain washers, spring washers etc. shall be provided for jointing the bus duct with transformer as well as switchgears.

7.0 LAYOUT

7.1 The proposed bus duct routing between transformer and associated switchgear shall be as shown in the drawing enclosed with NIT. Where no layout drawing is enclosed, the



TALCHER FERTILIZERS LIMITED
TECHNICAL SPECIFICATION - BUS DUCT

PC183-TS-0807

0

Document No.

Rev

Sheet 6 of 8



schedule of quantities shall be followed for bidding. However, the exact routing and details of switchgear and transformer end chambers shall be supplied at the time of order or drawing approval.

- 7.2 The successful vendor shall prepare final layout drawing for each bus duct with bill of materials and submit the same for PDIL/Purchaser's approval.

8.0 PAINTING

- 8.1 The enclosure after degreasing, pickling in acid, rinsing, phosphatising, passivating etc. shall be painted with two coats of anti-rust paint followed by two coats of anticorrosive paint.
- 8.2 Epoxy based paint shall be used.
- 8.3 All paints shall be carefully selected to withstand tropical heat and extremes of weather. The paint shall not scale off, crinkle or be removed by abrasion due to normal handling.
- 8.4 Unless otherwise specified, the finishing shade shall be light grey having shade no. 631 as per IS: 5.

9.0 TESTS AND INSPECTION

- 9.1 The bus duct shall be subjected to routine tests as per relevant standard.
- 9.2 Wherever specified, temperature rise tests shall be carried out on a minimum 5 metre length bus duct of each rating.
- 9.3 The test shall be carried out in manufacturer's works in presence of purchaser's representative. In addition, the bus ducts shall be subjected to stage inspection at works and inspection at site for final acceptance.
- 9.4 These inspections shall, however, not absolve the vendor from his responsibility of making good any defect which may be noticed subsequently.

10.0 DRAWINGS AND DOCUMENTS

- 10.1 Drawings and documents as per Annexure - I shall be supplied, unless otherwise specified.
- 10.2 All drawings and documents shall have the following descriptions written boldly
- Name of client
 - Name of consultant
 - Enquiry / Order Number with plant / project name
 - Code No. and Description

11.0 SPARES

- 11.1 Commissioning Spares : Commissioning spares, as required, shall be supplied with the main equipment. Item-wise list of recommended commissioning spares shall be furnished for information.
- 11.2 Spares for 2 Years Operation (Mandatory), as specified shall be supplied.
- 11.3 List of Recommend Spares (other than Mandatory Spares) alongwith recommended quantity shall be furnished.
- 11.4 All spare parts shall be identical to the parts used in the equipment.

12.0 PACKING

- 12.1 The bus duct shall be properly packed before despatch to avoid damage during transport, storage and handling. It shall be wrapped in polythene bags to make it



TALCHER FERTILIZERS LIMITED
TECHNICAL SPECIFICATION - BUS DUCT

PC183-TS-0807

0

Document No.

Rev

Sheet 7 of 8



waterproof. An additional wrapping with bitumen paper shall also be provided to make it completely water proof before the equipment is packed in wooden crates.

- 12.2 The packing box shall contain a copy of the installation, operation and maintenance manual.

ANNEXURE - I
DOCUMENTATION FOR BUS DUCT

Sl.No.	Description	Documents Required (Y / N)		
		With Bid	For Approval	Final
1.	General arrangement for each bus duct showing the complete layout.	N	Y	Y
2.	Design calculations	N	Y	N
	a) Bus bars sizing			
	b) Flexible sizing			
	c) Temperature Rise			
	d) Support Span			
3.	Specification sheet & Technical Particulars	N	Y	Y
4.	Switchgear end termination details for each rating of bus duct.	N	Y	Y
5.	Transformer end termination details for each rating of bus duct.	N	Y	Y
6.	Assembly drawing of rigid bends.	N	Y	Y
7.	Assembly drawing of bends with flexible	N	Y	Y
8.	Assembly drawing of straight run	N	Y	Y
9.	Transposition chamber details	N	Y	Y
10.	Installation, operation & maintenance manual	N	Y	Y
11.	Test Certificates			
	i) Type	N	N	N
	ii) Routine & others	N	N	Y
12.	Guarantee Certificates	N	N	Y
13.	List of spare parts	N	N	N

Note:

1. 4 hard copies & 1 soft copy shall be supplied for approval after order within 4 weeks from the date of LOI.
2. 8 hard copies & 2 soft copies in CD shall be submitted as final documents prior to despatch of the equipment. These shall be made in sets and supplied in fine plastic coated folder.

Y - Yes, N - No

	TALCHER FERTILIZERS LIMITED TECHNICAL SPECIFICATION - SHEET STEEL DISTRIBUTION BOARDS	PC183-TS-0808	0	
		Document No.	Rev	
		Sheet 1 of 11		



TECHNICAL SPECIFICATION

SHEET STEEL DISTRIBUTION BOARDS



CONTENTS

SECTION NUMBER	DESCRIPTION
1.0	SCOPE
2.0	STANDARDS TO BE FOLLOWED
3.0	SERVICE CONDITIONS
4.0	OPERATING REQUIREMENTS
5.0	DESIGN AND CONSTRUCTIONAL FEATURES
6.0	COMPONENT DETAILS
7.0	ACCESSORIES
8.0	PAINTING
9.0	TESTS AND INSPECTION
10.0	DRAWINGS AND DOCUMENTS
11.0	SPARES
12.0	PACKING
ANNEXURE - I	DOCUMENTATION FOR SHEET STEEL DISTRIBUTION BOARDS

	TALCHER FERTILIZERS LIMITED TECHNICAL SPECIFICATION - SHEET STEEL DISTRIBUTION BOARDS	PC183-TS-0808	0	
		Document No.	Rev	
		Sheet 3 of 11		

1.0 SCOPE

- 1.1 This standard covers the technical requirements of design, manufacture, testing at works and delivery in well-packed condition of Sheet Steel Distribution Boards.
- 1.2 This standard shall be read in conjunction with relevant part of Design Philosophy – Electrical.

2.0 STANDARDS TO BE FOLLOWED

- 2.1 The design, manufacture and testing of the equipment shall comply with the latest issue of the following Indian Standards, unless otherwise specified. Equipment complying with equivalent IEC standards shall also be acceptable.

- | | |
|--------------|---|
| IS: 8623 | - Specification for low voltage switchgear and control gear assemblies. |
| IS/IEC:60947 | - Specification for Low-voltage Switchgear and Control gear |
| IS: 5578 | - Guide for marking of insulated conductors. |
| IS: 11353 | - Guide for uniform system of marking and identification of conductors and apparatus terminals. |
| IS: 10118 | - Code of practice for selection, installation and maintenance of switchgear and control gear. |

Various components housed in the distribution board shall conform to the Indian Standard Specification as mentioned against the component details.

- 2.2 The design and operational features of the equipment offered shall also comply with the provisions of the latest issue of the Indian Electricity Rules and other Statutory Acts and Regulations. The supplier shall, wherever necessary, make suitable modifications in the equipment to comply with the above.
- 2.3 Wherever any requirement, laid down in this standard, differs from that in Indian Standard Specification the requirement specified herein shall prevail.

3.0 SERVICE CONDITIONS

3.1 Ambient Conditions

These shall be as indicated in Design Philosophy – Electrical.

3.2 System Details

These shall be as indicated in Design Philosophy – Electrical.



4.0 OPERATING REQUIREMENTS

The distribution board shall be suitable for operating at the specified rating continuously with the specified voltage and frequency variations under the ambient conditions, without exceeding the permissible temperature rise and without any detrimental effect on any part.

5.0 DESIGN AND CONSTRUCTIONAL FEATURES

5.1 General

- 5.1.1 The distribution board shall consist of an assembly of a series of floor mounting, identical, metal clad, dead front type panels of unitized design. The panels shall be placed side by side to form a compact assembly and shall be extensible on either side.
- 5.1.2 The complete assembly shall be dust, damp and vermin proof having minimum degree of protection equivalent to IP-52 as per IS/IEC:60947.
- 5.1.3 The frame work of the cubicles shall be of bolted/welded construction. The minimum thickness of steel shall be 2 mm for load bearing members, 1.6 mm for non-load bearing

	TALCHER FERTILIZERS LIMITED TECHNICAL SPECIFICATION - SHEET STEEL DISTRIBUTION BOARDS	PC183-TS-0808	0	
		Document No.	Rev	
		Sheet 4 of 11		

members and 3 mm for base channel. The doors and covers shall be fabricated from cold rolled sheet steel. Suitable reinforcement, wherever necessary, shall be provided.



- 5.1.4 The door hinges shall be concealed type.
- 5.1.5 All external hardware shall be cadmium plated/zinc passivated. The hardware for fixing the removable parts shall be provided with retaining devices.
- 5.1.6 The doors and the removable covers shall be provided with non-deteriorating neoprene gaskets. Gaskets without any discontinuity shall be preferred. Gaskets shall be held in position in groove of shaped sheet steel work or these shall be of U type. Adhesive cement, if used, shall be of good quality so that the gaskets do not come off during service.
- 5.1.7 All the components shall be accessible for inspection and maintenance without the necessity for removal of the adjacent ones. In case of single front design all components shall be accessible from the front for maintenance and back opening doors/ openable covers for maintenance shall not be acceptable.
- 5.1.8 The layout of the components inside a module shall be liberal to facilitate maintenance and the interconnection of wiring between the components shall not be subjected to any undue stress at the bends.
- 5.1.9 Mounting height of components requiring operation and observation shall not be lower than 300 mm and higher than 1800 mm.
- 5.1.10 Inter panel barriers shall be provided.
- 5.1.11 Adequate arrangement for earthing shall be provided to safeguard the operator or other personnel from electric hazards under all conditions of operation.

5.2 Panel Arrangement

- 5.2.1 The distribution board shall be non-drawout type in single front configuration.
- 5.2.2 Each Panel shall have its horizontal bus-bar chamber running on the top with multi-tier module units in the centre and having vertical bus-bar chamber and cable alley on either side.
- 5.2.3 The modules shall be enclosed on all sides and shall be so arranged that larger ones are placed at the bottom portion of the panel. Fixed type modules shall be at least 300 mm from the base channel.
- 5.2.4 The number of modules in the panel shall not exceed six for motor starter feeders and eight for switch fuse/MCB/MCCB feeders. The minimum size of module shall be 300 mm and 200 mm for starter and switch fuse feeders. The incomer and bus coupler module sizes for ratings up to 400 A shall be half the panel size. For higher ratings they shall be housed in single panel.
- 5.2.5 The module door shall be so interlocked that it shall not be possible to open the door with switch in closed position. Defeat interlock facility shall be provided.
- 5.2.6 The relay, meters, switches and lamps shall be flush mounted. All components of one module shall be mounted on the same module on a rigid sheet steel chassis. A 20 mm dia. rotating knob on the door shall be provided for closing and opening.



5.3 Bus Bars and Connections

- 5.3.1 The bus-bar shall be suitable for the supply system. The bus-bar and connections shall be made of electrolytic copper or high conductivity aluminium alloy conforming to Grade E91E of IS: 5082.
- 5.3.2 The bus-bar shall be amply sized to carry the rated continuous current under the specified ambient temperature without exceeding the temperature of 90°C. The bus-bars shall also be designed to withstand the system fault current for 1 second without



	TALCHER FERTILIZERS LIMITED TECHNICAL SPECIFICATION - SHEET STEEL DISTRIBUTION BOARDS	PC183-TS-0808	0	
		Document No.	Rev	
		Sheet 5 of 11		

exceeding the temperature of 200°C for bare aluminium and 250°C for bare copper. The minimum acceptable size of bus-bars shall be 250 sq. mm (Al). Calculation for the bus-bar sizing shall be furnished along with the offer.

- 5.3.3 In case of double front arrangement of distribution boards, different sets of vertical bus-bars shall be provided. The vertical bus-bars shall be PVC sleeved or shrouded by insulating barriers which shall have cut-outs to permit entry of power wires. It shall be possible to remove the shroud for inspection and maintenance. Neutral-bars shall be provided in this chamber.
- 5.3.4 Horizontal bus-bars shall be of same cross-section through out. Stepped bus-bars shall not be acceptable.
- 5.3.5 All bus-bars shall be arranged and colours coded according to IS: 5578/11353.
- 5.3.6 The horizontal bus-bar shall run in a separate bus chamber located at the top shall have separate screwed cover for inspection purpose.
- 5.3.7 The bus-bars shall be rigidly supported at equal intervals to withstand maximum short circuit stresses. The supports shall be of moulded construction with built in anti tracking barriers. The support material shall be of fibre glass reinforced thermosetting plastic.
- 5.3.8 All joints shall be suitably treated to avoid oxidation of contact surfaces and bimetallic corrosion. A minimum of two bolts with spring washers shall be used for horizontal bus-bar joints.
- 5.3.9 Horizontal bus bars shall be insulated with heat shrinkable PVC sleeves of reputed makes. Insulating shrouds shall be provided for all joints of insulated bus-bars.
- 5.4 Clearance and Creepage Distances**
- 5.4.1 The clearance and creepage distances shall not be lower than the values specified below :
- | | | |
|---|----|-------|
| i) Minimum clearance between two live conductors | -- | 20 mm |
| ii) Minimum clearance between live part and accidentally dangerous part | -- | 20 mm |
| iii) Minimum creepage distance | -- | 28 mm |
- 5.4.2 The clearances and the creepage, as specified above, shall definitely be maintained in the bus-bar system. Provision of bus-bar insulations, separator or barriers shall not be considered to reduce the clearance from the values specified above.
- 5.4.3 At the termination points in the equipment, e.g. switches, contactors, thermal relays, etc. it is realized that above clearance shall not always be possible to be maintained. All such points where above clearance are not possible to be maintained shall, therefore, be insulated or taped.
- 5.5 Insulation**
- 5.5.1 The insulation used shall be non-hygroscopic and shall be of porcelain, Epoxy- resins or fibre glass moulded with plastic. It shall be of adequate electrical and mechanical strength to give trouble free service during normal operation and short circuit conditions.
- 5.5.2 The insulation shall be treated suitably to withstand the tropical conditions and atmospheric pollution.
- 5.6 Power Wiring**
- 5.6.1 The connections from bus-bar including neutral to individual units on the modules shall consist of PVC insulated flexible copper cable or tapped copper strip.

	TALCHER FERTILIZERS LIMITED TECHNICAL SPECIFICATION - SHEET STEEL DISTRIBUTION BOARDS	PC183-TS-0808	0	
		Document No.	Rev	
		Sheet 6 of 11		

- 5.6.2 The power wiring size shall be decided based on the rating of the switch, after using a rating factor of not more than 50% over the current rating in free air. In any case the minimum size of power wiring shall not be less than 4 sq. mm copper.
- 5.6.3 The size of connection from incomer to horizontal bus-bar and from horizontal bus-bar to bus coupler shall not be less than the size adopted for horizontal bus-bar.
- 5.7 Control Wiring**
- 5.7.1 The switch board shall be completely factory wired and ready for external connections.
- 5.7.2 The wiring shall be carried out with flexible stranded PVC insulated copper conductor cables of 1100 Volt grade. The size of wires shall be as follows:
- | | | |
|---------------------------|----|------------|
| C.T. Circuit | -- | 2.5 sq. mm |
| V.T. and Control Circuits | -- | 1.5 sq. mm |
- 5.7.3 All wiring shall be provided with dependent both end marking as per IS: 5578. Numbered ferrules, reading from the terminals outwards, shall be provided at both ends of all wiring for easy identification. These shall be interlocking type plastic ferrules.
- 5.7.4 Control wiring circuits, fed from a supply common to a number of feeders, shall be so protected that failure of a circuit in one feeder does not affect the operation of the other feeders.
- 5.7.5 The wiring to the equipment mounted on the doors shall be carried out with flexible multi strand copper conductor cable and supported so that opening of the door, there is no undue strain on wire leads.
- 5.7.6 The control cables shall be neatly arranged and properly supported.
- 5.8 External Cable Termination**
- 5.8.1 All power and control cables shall enter the distribution board from the bottom. Sufficient space shall be provided for ease of connection and termination of cables.
- 5.8.2 All cables shall be of 1.1 KV grade PVC insulated armoured and PVC sheathed except for single core cable which shall be unarmoured. The number and sizes of cable shall be as indicated in Feeder details.
- 5.8.3 Compression type cable glands along with the cable lugs as required shall be provided for termination of cables.
- 5.8.4 The cable glands shall be of rolled Aluminium heavy duty double compression type and shall be mounted on a removable gland plate, provided at a minimum height of 75 mm from the bottom of the distribution board. Two numbers spare knockouts of size 20 mm shall also be provided on the gland plates for future use.
- 5.8.5 For all power cables crimped type aluminium lugs for aluminium cables and tinned copper lugs for copper cables shall be provided.
- 5.8.6 The terminal blocks shall be pressure clamp type up to 35 sq. mm cable and bolted lug type for higher sizes of cables. These shall be protected type and rated for 1100 Volts service. The minimum current rating of terminal block shall be 16 Amp. The construction shall be such that after the connection of cables by means of lugs, necessary clearance and creepage distance are available.
- 5.8.7 Where more than two cables in parallel are required to be terminated, a system of bus links shall be provided with adequate clearance and spacing.
- 5.8.8 Suitable clamps to support the vertical run of cables shall be provided.
- 5.8.9 The terminal block shall be grouped according to circuit functions and suitably numbered. 20% extra terminals shall be provided in the terminal block.

	TALCHER FERTILIZERS LIMITED TECHNICAL SPECIFICATION - SHEET STEEL DISTRIBUTION BOARDS	PC183-TS-0808	0	
		Document No.	Rev	
		Sheet 7 of 11		

5.8.10 For power connections, suitable marking on the terminals shall be provided to identify the phases.

5.9 Feeder Details

5.9.1 The requirements of incomer, bus coupler and outgoing feeders shall be as indicated in the single line diagram, feeder details and corresponding schematic diagram.

5.9.2 The bus coupler shall be so located that it is possible to maintain half of the bus-bars while the other half is still alive. Complete segregation of bus-bar connections to bus coupler shall be provided.

5.9.3 Castle key type mechanical interlocks shall be provided between incomers and bus section modules to avoid paralleling of incomers. In addition padlocking facilities shall be provided in OFF position.

5.9.4 Single phase loads shall be distributed as far as possible on all the three phases.

6.0 COMPONENT DETAILS

The components shall conform to type of co-ordination C as per IS/IEC:60947. Makes of all components shall be subject to owner's / consultant's approval

6.1 Moulded Case Circuit Breakers

6.1.1 The circuit breaker shall conform to IS/IEC:60947 and shall be of P2 category having rupturing capacity as per system requirement.

6.1.2 The circuit breaker shall be provided with spring assisted quick make quick break type manually operated trip free mechanism, mechanical ON/OFF position indicators, thermal tripping devices of inverse characteristics, instantaneous short circuit tripping devices and necessary auxiliary and alarm switches. The MCCB cubicle shall be provided with service, test and isolated position and automatic safety shutter.

6.1.3 The thermal and short circuit tripping device shall be adjustable type.

6.1.4 When used for motor circuit shunt trip devices shall be provided and the let through power of controlling MCCB shall be lower than the respective contactor.

6.1.5 In addition, under voltage trip shall be provided, if specified.

6.2 Switches

6.2.1 The switches shall be Motor duty type AC23 category and shall comply with the requirements laid down in IS/IEC:60947. Switches up to 63 Amps shall be rotary type and those of 100 Amp and above shall be link type.

6.2.2 'ON' and 'OFF' positions of the switches shall be indicated on the panel. Provision shall be made to lock the switch in the 'OFF' position.

6.2.3 The fixed contacts shall be shrouded and the contacts shall be silver plated.

6.2.4 Two Pole switches shall also isolate the neutral circuit along with phase circuit. 4 Pole / 2 Pole switches shall be used for 3 Phase/1 Phase circuits respectively.



6.3 Fuses

The fuses shall be of non-deteriorating HRC cartridge link type and conform to IS: 13703. They shall be suitable for the load and the service required in the circuit.

6.4 Air Break Contactors

6.4.1 The Air Break Contactor shall be of AC3 category unless otherwise specified, conforming to IS/IEC:60947 and flapper type. Gravity operated contactors are not acceptable.

6.4.2 The dropout voltage shall not exceed 65% of rated voltage.

	TALCHER FERTILIZERS LIMITED TECHNICAL SPECIFICATION - SHEET STEEL DISTRIBUTION BOARDS	PC183-TS-0808	0	
		Document No.	Rev	
		Sheet 8 of 11		

6.4.3 Each contactor shall be provided with auxiliary contacts as required. The rating of the auxiliary contacts shall be 5 Amps. AC or 1 Amp DC at the specified control voltages. The spare auxiliary contacts shall also be wired terminal block.

6.5 **Bimetal Thermal Overload Relays**

6.5.1 The contactor shall be provided with three pole bimetal thermal overload relays unless otherwise specified. The bimetal relays shall be of suitable range, ambient temperature compensated and shall be separate mounting type. They shall be adjustable through graduated scale and shall be provided with changeover contact.

6.5.2 Bimetal relays shall conform to IS: 3231 and shall have built in single phasing preventor.

6.5.3 The bimetal relays shall be provided with a manual reset device resettable after opening the cubicle door. Auto reset thermal relays are not acceptable.

6.6 **Current Transformers**

6.6.1 The current transformers shall conform to IS: 2705.

6.6.2 Current Transformers shall be Class-F insulated and vacuum impregnated. The Current Transformers shall be rigidly mounted and shall be easily accessible for maintenance and testing.

6.6.3 The Current Transformers shall be of 7.5 VA output. The output shall be adequate for the instrument and metering duties involved with sufficient margin. The Current Transformers shall have the accuracy Class-1 for the metering duty.

6.6.4 All the Current Transformers shall be provided with terminals and shorting links. One of the terminals of C.T. shall be earthed. The polarity of the C.T. shall be clearly marked.

6.6.5 The C.T.s shall be capable of withstanding momentary open-circuit on the secondary side without injurious effects.

6.7 **Instruments and Meters**

6.7.1 All instruments shall be flush mounting type with square face and shall be tropicalized and dust tight.

6.7.2 The size of the instruments shall be 96 mm x 96 mm for full and half size modules and 72 mm x 72 mm for lower size modules.

6.7.3 Dials shall be parallax free with scale marked in black on white background and shall be suitable for direct reading.

6.7.4 Zero adjusters shall be provided for operation from the front of the cases.

6.7.5 All ammeters and voltmeters shall have 0 - 240° scale moving iron spring controlled type and of Class 1.5 accuracy as per IS: 1248. The scale range of the ammeter and voltmeter shall be as indicated in the feeder details.



6.7.6 In case of motor feeders, the ammeter shall be graduated uniformly upto C.T. primary current and with a compressed end scale upto 6 times the C.T. primary current. Red pointer shall be provided, which can be adjusted at site for indicating full load current.

6.7.7 KWH meter shall be 3 phase 4 wire type. These shall conform to the requirements of relevant IS and shall be C.T. operated. The current coil shall be rated for 5 Amp.

6.7.8 All kWh meters shall be provided with test blocks for current and voltage coils for testing them at site without interrupting their recording while in service.

6.8 **Push Button and Control Switches**

6.8.1 The switches and push buttons shall conform to utilization category AC 11/DC 11 as per IS/IEC:60947 . The contact shall be rated to make, break and carry inductive current of 5 Amp. at 415 V AC and 1 Amp at 220 V DC.

	TALCHER FERTILIZERS LIMITED TECHNICAL SPECIFICATION - SHEET STEEL DISTRIBUTION BOARDS	PC183-TS-0808	0	
		Document No.	Rev	
		Sheet 9 of 11		

6.8.2 The control switches shall be spring return rotary type unless otherwise specified and provided with pistol grip type handle. The control switches for circuit breakers shall be additionally fitted with lost motion devices and sequencing devices.

6.8.3 The selector switches shall be stay-put rotary type and provided with oval shape handles.

6.8.4 The push buttons shall be of momentary contact spring loaded type with a set of normally close and open contacts. The push button for 'Start' shall be shrouded type and coloured green, stop push button shall be un-shrouded type and coloured red and other push buttons shall be un-shrouded type coloured black. The fixing ring shall be metallic white.

6.8.5 Emergency stop push buttons, if specified, shall be lockable in pushed position.

6.9 **Miniature Circuit Breakers**

6.9.1 The miniature circuit breakers shall conform to IS: 13032 and shall be of duty category M-9.

6.9.2 It shall be provided with overload and short circuit protective devices in a heat resistant housing.

6.9.3 A certificate of short circuit rating and current time tripping curve shall be furnished alongwith the offer.

6.10 **Signal Lamps**

6.10.1 Signal lamps shall be provided to indicate the various circuit conditions as shown in scheme drawings. The colour of the lamps for various functions shall be as follows:

Red -- Switch/Contactor closed.
Green -- Switch/Contactor open.

6.10.2 The lamps shall be LED type having lumen output 200 milli candela in axial direction.

6.10.3 It shall be possible to remove the globe from outside for replacement of lamps.

7.0 **ACCESSORIES**

7.1 The supplier shall include the following accessories.

- Fuse Puller.
- Test plug for kWh meters.

7.2 **Space Heater**

Each vertical section shall be provided with a thermostatically controlled space heater, rated for 240 V, 50 Hz and controlled through double pole miniature circuit breaker.

7.3 **Name Plates**

7.3.1 The distribution board shall have large name plate on the top to indicate its name and designation.

7.3.2 Each feeder shall be provided with name plate. Each single front panel shall have name plate both in front and back.



7.3.3 All control switches, push buttons, lamps etc. shall have functional identification labels.

7.3.4 Name plate shall be of black perspex with white engraving and of minimum 3 mm thick.

7.3.5 Any other accessories required, but not specified shall also be supplied to make the distribution board complete in all respects to ensure safe and proper operation.

8.0 **PAINTING**

8.1 The enclosure after degreasing, pickling in acid, cold rinsing phosphatising, passivating etc. shall be painted with two coats of anti-rust paint followed by two coats of anticorrosive paint.

	TALCHER FERTILIZERS LIMITED TECHNICAL SPECIFICATION - SHEET STEEL DISTRIBUTION BOARDS	PC183-TS-0808	0	
		Document No.	Rev	
		Sheet 10 of 11		

- 8.2 Epoxy based paint shall be used.
- 8.3 All paints shall be carefully selected to withstand tropical heat and extremes of weather. The paint shall not scale off, crinkle or be removed by abrasion due to normal handling.
- 8.4 Unless otherwise specified, the finishing shade shall be light grey Shade No.631 as per IS: 5.
- 8.5 One litre of paint shall be supplied along with each board for touch up at site.

9.0 TESTS AND INSPECTION

- 9.1 The distribution boards shall be subjected to routine test as per IS: 8623.
- 9.2 Additional tests, wherever specified, shall be carried out.
- 9.3 All the above tests shall be carried out in presence of purchaser's representative. In addition, the equipment shall be subjected to stage inspection during process of manufacture at works and site inspection.
- 9.4 These inspections shall however, not absolve the vendor from his responsibility for making good any defect which shall be noticed subsequently.

10.0 DRAWINGS AND DOCUMENTS

- 10.1 Drawings and documents as per Annexure-I shall be supplied unless otherwise specified.
- 10.2 All drawings and documents shall have the following description written boldly:
- Name of client
 - Name of consultant
 - Enquiry / Order Number with plant / project name
 - Code No. and Description

11.0 SPARES

- 11.1 Commissioning Spares: Commissioning spares, as required, shall be supplied with the main equipment. Item-wise list of recommended commissioning spares shall be furnished for information.
- 11.2 Spare for 2 Years Operation (Mandatory), as specified shall be supplied.
- 11.3 List of Recommend Spares (other than Mandatory Spares) alongwith recommended quantity and item-wise price shall be furnished.
- 11.4 All spare parts shall be identical to the parts used in the equipment.

12.0 PACKING

- 12.1 The distribution board shall be properly packed before despatch to avoid damage during transport, storage and handling.
- 12.2 The packing box shall contain a copy of the installation, operation and maintenance manual.
- 12.3 A sign to indicate the upright position of the panels to be placed during transport and storage shall be clearly marked. Also proper arrangement shall be provided to handle the equipment.

ANNEXURE - I



DOCUMENTATION FOR SHEET STEEL DISTRIBUTION BOARDS

Sl.No.	Documents	Documents Required (Y / N)		
		With Bid	For Approval	Final
1.	Specification Sheet	N	Y	Y
2.	Technical Particulars	N	Y	Y
3.	Feeder Details	N	Y	Y
4.	General Arrangement and Foundation Drawings	N	Y	Y
5.	Schematic Diagrams with Terminal arrangement drawings	N	Y	Y
6.	Calculation for Bus-bar sizing	N	Y	N
7.	Illustrative and Descriptive literature	N	N	Y
8.	Catalogues for bought out accessories	N	N	Y
9.	Installation, Operation and Maintenance Manual	N	N	Y
10.	Test Certificates			
	-- Type (for MCCB & MCB)	N	N	N
	-- Routine	N	N	Y
11.	Guarantee Certificates	N	N	Y
12.	Spare Parts List	N	N	Y

Note:

1. 4 hard copies & 1 soft copy shall be supplied for approval after order within 4 weeks from the date of LOI.
2. 8 hard copies & 2 soft copies in CD shall be submitted as final documents prior to despatch of the equipment. These shall be made in sets and supplied in fine plastic coated folder.

Y - Yes, N - No



	TALCHER FERTILIZERS LIMITED TECHNICAL SPECIFICATION - LIGHTING SUB DISTRIBUTION BOARDS	PC183-TS-0809	0	
		Document No.	Rev	
		Sheet 1 of 6		

TECHNICAL SPECIFICATION

LIGHTING SUB DISTRIBUTION BOARDS

CONTENTS

SECTION NUMBER	DESCRIPTION
1.0	SCOPE
2.0	STANDARDS TO BE FOLLOWED
3.0	SERVICE CONDITIONS
4.0	OPERATING REQUIREMENTS
5.0	GENERAL DESIGN AND CONSTRUCTIONAL FEATURES
6.0	SPECIAL FEATURES FOR FLAME PROOF LIGHTING SUB DISTRIBUTION BOARDS
7.0	COMPONENT DETAILS
8.0	PAINTING
9.0	TESTS AND INSPECTION
10.0	DRAWINGS AND DOCUMENTS
11.0	SPARES
12.0	PACKING
ANNEXURE - I	DOCUMENTATION FOR LIGHTING SUB DISTRIBUTION BOARDS

	TALCHER FERTILIZERS LIMITED TECHNICAL SPECIFICATION - LIGHTING SUB DISTRIBUTION BOARDS	PC183-TS-0809	0	
		Document No.	Rev	
		Sheet 3 of 6		

1.0 SCOPE

- 1.1 This standard covers the technical requirements of design, manufacture, testing at works and delivery in well packed condition of lighting sub distribution boards.
- 1.2 This standard shall be read in conjunction with relevant part of Design Philosophy - Electrical.

2.0 STANDARDS TO BE FOLLOWED

- 2.1 The design, manufacture and testing of the equipment covered by this standard shall comply with the latest issue of the following Indian Standards. Equipment complying with equivalent IEC standards shall also be acceptable
- IS/IEC:60947 - Low voltage switchgear and control gear
 - IS: 8623 - Specification for low voltage switchgear and control gear assemblies
- 2.2 The design and operational features of the equipment offered shall also comply with the provisions of latest issue of the Indian Electricity Rules and other relevant statutory acts and regulations. The supplier shall, wherever necessary, make suitable modification in the equipment to comply with the above.
- 2.3 Wherever any requirement, laid down in this standard, differs from that in Indian Standard Specifications, the requirement specified herein shall prevail.

3.0 SERVICE CONDITIONS

3.1 Ambient Conditions

These shall be as indicated in Design Philosophy - Electrical.

3.2 System Details



These shall be as indicated in Design Philosophy - Electrical.

4.0 OPERATING REQUIREMENTS



The lighting sub-distribution boards shall be suitable for operating continuously under the ambient conditions and with the voltage and frequency variations, without exceeding the specified temperature rise and without any detrimental effect on any part.

5.0 GENERAL DESIGN AND CONSTRUCTIONAL FEATURES

- 5.1 The lighting sub distribution boards shall be fabricated out of 2.5 mm thick cold rolled sheet steel and shall be suitable for mounting on wall/structure. These shall have dust and vermin proof construction conforming to IP-65 as per IS/IEC:60947. For outdoor installation, the enclosure shall conform to IPW-55. Suitable canopy made out of 2 mm thick Aluminium sheet shall be supplied along with the board.
- 5.2 The miniature circuit breakers shall be so mounted inside the enclosure that their operating knobs project outside for easy operation. The cut-out for the knobs on the enclosure shall be lined with gasket for dust proofness. For further protection against ingress of dust, the portion where the knobs have protruded out, shall be provided with another external front cover, internally hinged at the top, gravity operated and with a knurled knob at the bottom. The external cover shall be flushed with the main cover. Continuous neoprene gasket shall be provided to make the board completely dust and weather proof.
- 5.3 All external hard ware of diameter less than 8 mm shall be of stainless steel and those of diameter 8 mm and above shall be of mild steel cadmium plated or zinc passivated.

	TALCHER FERTILIZERS LIMITED TECHNICAL SPECIFICATION - LIGHTING SUB DISTRIBUTION BOARDS	PC183-TS-0809	0	
		Document No.	Rev	
		Sheet 4 of 6		

- 5.4 The sub-distribution boards to be located indoors shall have top entry arrangement for outgoing cables and bottom entry for incoming cable. However for outdoor locations, all cable entries shall be from the bottom only.
- 5.5 Three phase and neutral bus bar system of adequate size shall be provided to which all outgoing and incoming MCB's shall be connected.
- 5.6 The internal wiring shall be carried out by means of single core PVC insulated 2.5 sq. mm stranded copper conductor cables.
- 5.7 Two earthing terminals outside the board shall be provided.
- 5.8 Suitable label inscription consisting of black perspex with engraving for the board and circuit nos. of all outgoing feeders shall be provided. The label inscription of the board shall contain description and code no. The circuit nos. of outgoing feeders shall be serially indicated as 1L, 2L.....17L, 18L.
- 5.9 The board shall be complete with terminal block, cable glands, cable lugs and other accessories as specified.
- 6.0 SPECIAL FEATURES FOR FLAME PROOF LIGHTING SUB DISTRIBUTION BOARDS**
- 6.1 The enclosure shall be in addition of flame proof execution as per IS: 2148.
- 6.2 The enclosure group and temperature class shall be as indicated in Design Philosophy – Electrical.
- 6.3 The enclosure shall be of cast iron/cast Aluminium alloy (4600 as per IS: 617).
- 6.4 Cables shall enter the terminal chamber through flame proof compression type cable glands. From terminal chamber to the main enclosure connection shall be made through bushings. Direct entry of external cables into the main enclosure shall not be accepted.
- 6.5 The sub-distribution board shall be of 6 way type.
- 6.6 Individual earth terminals shall be provided for the earth conductor of the outgoing cables beside the phase and neutral terminals.
- 6.7 The sub-distribution board must be certified by Central Mining Research Institute, Dhanbad or other statutory authority for use in specified hazardous area.
- 7.0 COMPONENT DETAILS**
- 7.1 The lighting sub-distribution board shall be wired and have components as per SD-8083 (copy attached).
- 7.2 **Miniature Circuit Breaker (MCB)**
- The MCB shall be of duty category M-9 and shall conform to IS/IEC:60898-1:2002. It shall be provided with overload and short circuit protective devices. MCB shall be of C Curve Type.
- 7.2.1 The incoming MCB's or switches shall be of triple pole and switched neutral type and outgoing MCB's of single pole and switched neutral type, single phase earth leakage protection in each phase of the incomer shall be provided.
- 7.3 **Terminal Block**
- Pressure clamp type terminal blocks shall be provided both for incoming and outgoing cables. The rating of the terminal block shall be at least 1.5 times the rating of the MCB.
- 7.4 **Cable Glands**
- Heavy duty double compression type Aluminium cable glands suitable for PVC insulated, armoured and PVC sheathed 1.1 KV grade incoming and outgoing cables shall be provided.

	TALCHER FERTILIZERS LIMITED TECHNICAL SPECIFICATION - LIGHTING SUB DISTRIBUTION BOARDS	PC183-TS-0809	0	
		Document No.	Rev	
		Sheet 5 of 6		

8.0 PAINTING

- 8.1 The enclosure after suitable pre-treatment shall be painted with two coats of anti rust paint followed by two coats or anticorrosive paint.
- 8.2 Epoxy based paint shall be used.
- 8.3 All paints shall be carefully selected to withstand tropical heat and extremes of weather. The paint shall not scale off, crinkle or be removed by abrasion due to normal handling.
- 8.4 The finishing shade shall be light grey shade no.631 as per IS: 5.

9.0 TESTS AND INSPECTION

- 9.1 All the lighting sub-distribution boards shall be subjected to routine tests as per IS: 8623.
- 9.2 Additional tests, wherever specified, shall be carried out on one lighting sub-distribution board of each type.
- 9.3 The above mentioned tests shall be carried out in the manufacturer's works in the presence of purchaser's representative. In addition, the equipment shall be subjected to stage inspection at works and inspection at site for final acceptance.
- 9.4 The purchaser's inspection shall, however, not absolve the vendor from his responsibility for making good any defects which may be noticed subsequently.

10.0 DRAWINGS AND DOCUMENTS

- 10.1 Drawings and documents as per Annexure-I shall be supplied, unless otherwise specified.
- 10.2 All drawings and documents shall have the following description written boldly.
- Name of client
 - Name of consultant
 - Enquiry / Order Number with plant / project name
 - Code No. and Description

11.0 SPARES

- 11.1 Commissioning Spares: Commissioning spares, as required, shall be supplied with the main equipment. Item-wise list of recommended commissioning spares shall be furnished for information.
- 11.2 Spare for 2 Years Operation (Mandatory), as specified shall be supplied.
- 11.3 List of Recommend Spares (other than Mandatory Spares) alongwith recommended quantity and item-wise price shall be furnished.
- 11.4 All spare parts shall be identical to the parts used in the equipment.

12.0 PACKING

- 12.1 The equipment shall be properly packed to safeguard against weather conditions and handling during transit. It shall be wrapped in polythene bags and an additional wrapping of bitumen paper shall also be provided to make it completely water proof before the equipment is packed in wooden crates.
- 12.2 The packing box shall contain a copy of the installation, operation and maintenance manual.

ANNEXURE - I

DOCUMENTATION FOR LIGHTING SUB DISTRIBUTION BOARDS

SL.NO.	Description	Documents Required (Y / N)		
		With Bid	For Approval	Final
1.	Specification Sheet	N	Y	Y
2.	Technical particulars	N	Y	Y
3.	General arrangement Drgs.	N	Y	Y
4.	Certificate for flameproofness from statutory testing authority wherever applicable	N	N	Y
5.	Schematic diagram	N	Y	Y
6.	Descriptive literature of Various equipment	N	N	Y
7.	Guarantee certificate	N	N	Y
8.	Test certificate	N	N	Y

Note:

1. 4 hard copies & 1 soft copy shall be supplied for approval after order within 4 weeks from the date of LOI.
2. 8 hard copies & 2 soft copies in CD shall be submitted as final documents prior to despatch of the equipment. These shall be made in sets and supplied in fine plastic coated folder.

Y - Yes, N - No



TALCHER FERTILIZERS LIMITED
TECHNICAL SPECIFICATION - INTERLOCKING SWITCH
SOCKET AND PLUG

PC183-TS-0811

0

Document No.

Rev

Sheet 1 of 7



TECHNICAL SPECIFICATION
INTERLOCKING SWITCH SOCKET AND PLUG



CONTENTS

SECTION NUMBER	DESCRIPTION
1.0	SCOPE
2.0	STANDARDS TO BE FOLLOWED
3.0	SERVICE CONDITIONS
4.0	OPERATING REQUIREMENTS
5.0	GENERAL DESIGN AND CONSTRUCTIONAL FEATURES
6.0	SPECIAL FEATURES FOR FLAME PROOF SWITCH SOCKET AND PLUGS
7.0	COMPONENT DETAILS
8.0	PAINTING
9.0	TESTS AND INSPECTION
10.0	DRAWINGS AND DOCUMENTS
11.0	PACKING
12.0	SPARES
ANNEXURE - I	DOCUMENTATION FOR INTERLOCKING SWITCH SOCKET AND PLUG



TALCHER FERTILIZERS LIMITED
TECHNICAL SPECIFICATION - INTERLOCKING SWITCH
SOCKET AND PLUG

PC183-TS-0811

0

Document No.

Rev

Sheet 3 of 7



1.0 SCOPE

- 1.1 The standard covers the technical requirements of design, manufacture, testing at works and delivery in well packed condition of interlocking switch socket and plug.
- 1.2 The standard shall be read in conjunction with relevant part of Design Philosophy - Electrical.

2.0 STANDARDS TO BE FOLLOWED

- 2.1 The design, manufacture and testing of the equipment covered by this standard shall comply with the latest issue of IS-4160/ IEC-309 and other relevant Indian Standards, unless otherwise specified. Equipment complying with equivalent IEC standards shall also be acceptable.
- 2.2 The design and operational features of the equipment offered shall also comply with the provisions of latest issue of Indian Electricity Rules and other statutory acts and regulations. The supplier shall, wherever necessary, make suitable modifications in the equipment to comply with the above.
- 2.3 Wherever any requirement, laid down in this standard differs from that in Indian Standard Specifications, the requirement specified herein shall prevail.

3.0 SERVICE CONDITIONS

3.1 Ambient conditions

These shall be as indicated in Design Philosophy - Electrical.

3.2 System details

These shall be as indicated in Design Philosophy - Electrical.

4.0 OPERATING REQUIREMENTS

The equipment shall be suitable for operating at the rated capacity continuously without exceeding the specified temperature rise and without any detrimental effect on any part.

5.0 GENERAL DESIGN AND CONSTRUCTIONAL FEATURES

- 5.1 The switch socket shall be heavy duty industrial type. The interlocking arrangement shall be such that it is not possible to insert or withdraw the plug with the switch in 'ON' position.
- 5.2 The switch sockets shall have dust, hose and weather proof construction conforming to IPW55 as per IS/IEC:60947 and shall be suitable for outdoor use without any extra protection. All jointing surfaces shall be smoothly machined and of sufficient width to prevent ingress or dust. Further the covers shall be provided with continuous gaskets made of neoprene to prevent ingress of dust and moisture.
- 5.3 The enclosure of switch sockets and plugs shall be of cast aluminium alloy 4600 and suitable for fixing on wall / structure.
- 5.4 The enclosure shall be largely dimensioned in order to avoid temperature rise inside it which may damage the insulating materials and gaskets employed therein.
- 5.5 The insulating materials used shall be non-hygroscopic, mould proof and treated with suitable varnish to withstand the ambient conditions.
- 5.6 All external hardware of diameter less than 8 mm shall be of stainless steel and those of diameter 8 mm or above shall be of mild steel cadmium plated or zinc passivated.
- 5.7 Suitable arrangement for looping of cables from one switch socket to the other shall be provided. For switch sockets rated above 63A, looping shall be done from busbars and



TALCHER FERTILIZERS LIMITED
TECHNICAL SPECIFICATION - INTERLOCKING SWITCH
SOCKET AND PLUG

PC183-TS-0811

0

Document No.

Rev

Sheet 4 of 7



for switch sockets rated 63A and below, looping may be done from terminal block. Necessary terminals, cable glands and lugs for looping shall be provided. Also one no. The readed plug for each switch socket shall be supplied loose.

5.8 All the relevant information shall be provided on engraved name plate made of aluminium.

5.9 The enclosure shall be provided with two earthing terminals outside the body.

6.0 SPECIAL FEATURES FOR FLAME PROOF SWITCH SOCKET AND PLUGS

6.1 The enclosure shall be in addition of flame proof execution as per IS: 2148.

6.2 The enclosure group and temperature class shall be as indicated in Design Philosophy - Electrical.

6.3 Cable shall enter the terminal chamber through flame proof compression type cable glands. From the terminal to the main enclosure, the connection shall be made through proper bushings. Direct entry of external cables into the main enclosure shall not be accepted.

6.4 An additional earthing terminal inside the terminal chamber shall be provided.

6.5 Switch socket, plug and cable glands must be certified by the Central Mining Research Institute, Dhanbad or any other statutory authority for use in the specified hazardous area.

6.6 Further interlocking shall be provided so that the contacts cannot be energised when the plug and socket are separated.

7.0 COMPONENT DETAILS

Makes of all components shall be subject to owner's / consultant's approval

7.1 Air Break Switches

7.1.1 The switches shall be quick make, quick break rotary type and of utilisation category AC-23 as per IS/IEC:60947.

7.1.2 Switches shall be hand operated from outside the cover. The switch handle shall remain fixed to the front cover while removing the front cover.

7.2 H.R.C. Fuses

7.2.1 The sockets shall be provided with link type HRC fuses.

7.2.2 The fuses shall be capable of withstanding a short circuit current of 50 KA and shall be delayed action type conforming to IS: 13703. These shall be mounted on a shrouded base.

7.3 Socket Outlets

7.3.1 The socket outlet shall be located in the lower part of the enclosure and shall be provided with a threaded aluminium cover attached to the body with G.I. chain, to protect the socket after extraction of the plug. Spring loaded automatic shutter shall not be acceptable.

7.3.2 The socket contacts shall maintain satisfactory spring pressure and contact with the corresponding plug under normal service conditions.

7.3.3 The socket contacts shall be sunk well below the surface of the socket- outlets so as to make it impossible to be touched unintentionally.

7.3.4 An earthing contact shall be provided in the socket outlet which shall ensure making and breaking respectively of its contact with the earthing pin of the plug before and after making and breaking of the corresponding current carrying contacts.



TALCHER FERTILIZERS LIMITED
TECHNICAL SPECIFICATION - INTERLOCKING SWITCH
SOCKET AND PLUG

PC183-TS-0811

0

Document No.

Rev

Sheet 5 of 7



7.4 **Plugs**

- 7.4.1 The plugs shall be so constructed so that these can be easily fitted in to the socket outlets.
- 7.4.2 These shall be provided with knurled knob arrangement for screwing on the body of the socket so that it can be securely fixed on the top.
- 7.4.3 The plug base and cover shall be firmly secured to each other and shall be sufficiently robust in construction to withstand normal usage.
- 7.4.4 The plug pins shall preferably be of single part. The earthing pin shall be slotted with a single slot and shall be larger in dimension than other pins.
- 7.4.5 The plug and socket contacts shall be self aligning type with best electrical continuity.
- 7.4.6 The plug shall be provided with dust proof cable entry suitable for receiving TRS flexible heavy duty copper conductor cable of specified size. The arrangement shall be such that the conductors are relieved from strain including twisting where they are connected to the terminals and that the outer surface of the cable at the place of entry is not damaged.
- 7.4.7 Insulating barriers forming an integral part of the plug shall ensure separation of metals and bare flexible conductors at different potentials.

7.5 **Cable Termination**

- 7.5.1 Switch socket shall have cable termination arrangement on the upper part of the housing and shall be provided with side entries, one on either side, through heavy duty double compression type rolled aluminium cable glands suitable for 1.1 KV grade PVC insulated armoured and PVC sheathed cables of size.
- 7.5.2 The terminal blocks shall be pressure clamp type for switch socket rated up to 63A and bolted lug type for higher ratings. The terminals shall be rated for at least 1.5 times the switch rating.

8.0 **PAINTING**

- 8.1 The enclosure after suitable pre-treatment shall be painted with two coats of anti-rust paint followed by two coats of anti-corrosive paint.
- 8.2 Epoxy based paint shall be used.
- 8.3 All paints shall be carefully selected to withstand tropical heat and extremes of weather. The paint shall not scale off, crinkle or be removed by abrasion due to normal handling.
- 8.4 The finishing shade shall be light grey shade no.631 as per IS: 5, unless specified otherwise.

9.0 **TESTS AND INSPECTION**

- 9.1 The switch sockets and plugs shall be subjected to routine tests as per IS-4160 and other relevant standards.
- 9.2 Wherever specified, additional tests shall be carried out on one switch socket and plug of each rating.
- 9.3 The tests shall be carried out in the manufacturer's works in the presence of purchaser's representative. In addition to the above tests, the equipment shall be subject to stage inspection at works and inspection at site for final acceptance.
- 9.4 These inspections shall, however, not absolve the vendor from their responsibility for making good any defect which may be noticed subsequently.



TALCHER FERTILIZERS LIMITED
TECHNICAL SPECIFICATION - INTERLOCKING SWITCH
SOCKET AND PLUG

PC183-TS-0811

0

Document No.

Rev

Sheet 6 of 7



10.0 DRAWINGS AND DOCUMENTS

10.1 Drawings and documents as per Annexure-I shall be supplied, unless otherwise specified.

10.2 All drawings and documents shall have the following descriptions written boldly.

- Name of client
- Name of consultant
- Enquiry / Order Number with plant / project name
- Code No. and Description

11.0 PACKING

11.1 The switch socket and plug shall be properly packed to safeguard against weather conditions and handling during transit. It shall be wrapped in polythene bags and an additional wrapping of bitumen paper shall also be provided to make it completely water proof before the equipment is packed in wooden crates.

11.2 The packing box shall contain a copy of the installation, operation and maintenance manual.

12.0 SPARES

12.1 Commissioning Spares: Commissioning spares, as required, shall be supplied with the main equipment. Item-wise list of recommended commissioning spares shall be furnished for information.

12.2 Spare for 2 Years Operation (Mandatory), as specified shall be supplied.

12.3 List of Recommend Spares (other than Mandatory Spares) alongwith recommended quantity and item-wise price shall be furnished.

12.4 All spare parts shall be identical to the parts used in the equipment.



ANNEXURE – I



DOCUMENTATION FOR INTERLOCKING SWITCH SOCKET AND PLUG

Sl.No.	Description	Documents Required (Y / N)		
		With Bid	For Approval	Final
1.	Specification Sheet	N	Y	Y
2.	Technical Particulars	N	Y	Y
3.	General arrangement and foundation drawing	N	Y	Y
4.	Schematic / wiring diagram	N	Y	Y
5.	Illustrative and descriptive literature	N	N	Y
6.	Catalogue for bought out accessories	N	N	Y
7.	Installation operation and maintenance manual	N	N	Y
8.	Test Certificates			
	a) Type	N	N	Y
	b) Routine	N	N	Y
9.	Guarantee Certificate	N	N	Y
10.	Certificate of flameproofness from statutory testing authority wherever applicable.	N	N	Y
11.	Spare parts list with identification marks	N	N	Y

Note:

1. 4 hard copies & 1 soft copy shall be supplied for approval after order within 4 weeks from the date of LOI.
2. 8 hard copies & 2 soft copies in CD shall be submitted as final documents prior to despatch of the equipment. These shall be made in sets and supplied in fine plastic coated folder.

Y - Yes, N - No



	TALCHER FERTILIZERS LIMITED TECHNICAL SPECIFICATION - CABLES	PC183-TS-0815	0	
		Document No.	Rev	
		Sheet 1 of 6		

TECHNICAL SPECIFICATION

CABLES

CONTENTS

SECTION NUMBER	DESCRIPTION
1.0	SCOPE
2.0	STANDARDS TO BE FOLLOWED
3.0	SERVICE CONDITIONS
4.0	OPERATING REQUIREMENTS
5.0	GENERAL DESIGN AND CONSTRUCTIONAL FEATURES
6.0	SPECIAL PURPOSE CABLES
7.0	CABLE DRUM
8.0	TESTS AND INSPECTION
9.0	DRAWINGS AND DOCUMENTS
ANNEXURE - I	DOCUMENTATION FOR CABLES

	TALCHER FERTILIZERS LIMITED TECHNICAL SPECIFICATION - CABLES	PC183-TS-0815	0	
		Document No.	Rev	
		Sheet 3 of 6		

1.0 SCOPE

- 1.1 This standard covers the technical requirements of design, manufacture, testing at works and dispatch in well packed condition of power and control cables.
- 1.2 The standard shall be read in conjunction with relevant part of Design Philosophy - Electrical and other relevant references as specified therein.

2.0 STANDARDS TO BE FOLLOWED

- 2.1 The design, manufacture and testing of cables covered by this standard shall comply with the latest issue of following Indian Standards, unless otherwise specified. Equipment complying with equivalent IEC standards shall also be acceptable.

- IS: 1554 Part (I) -- PVC insulated (heavy duty) electric cables for working voltages upto and including 1100 volts.
- IS: 1554 Part (II) -- PVC insulated (heavy duty) electric cables for working voltages from 3.3 KV upto and including 11 KV.
- IS: 7098 Part (I) -- Cross linked polyethylene insulated PVC sheathed cables for working voltages upto and including 1100 volts.
- IS: 7098 Part (II) -- Cross linked polyethylene insulated PVC sheathed cables for working voltages from 3.3 KV upto and including 33 KV
- IS: 694 -- PVC insulated cables for working voltages upto and including 1100 volts
- IS: 5831 -- PVC insulation and sheath of electric cables

- 2.2 The design and operational features of the cables offered shall also comply with the provisions of latest issue of the Indian Electricity Rules and other relevant Statutory Rules & Regulations. The supplier shall, whenever necessary, make suitable modification in the cables to comply with the above mentioned rules.
- 2.3 Wherever any requirement, laid down in this standard, differs from that in Indian Standard Specifications, the requirement specified herein shall prevail.

3.0 SERVICE CONDITIONS

3.1 Ambient Conditions

These shall be as indicated elsewhere in Design Philosophy - Electrical.

3.2 System Details



These shall be as indicated elsewhere in Design Philosophy - Electrical.

4.0 OPERATING REQUIREMENTS

The cables shall be suitable for operating continuously at the rated capacity as specified in relevant I.S. under the ambient conditions without exceeding the permissible temperature rise and without any detrimental effect on any part.

5.0 GENERAL DESIGN AND CONSTRUCTIONAL FEATURES

- 5.1 The design, manufacture and workmanship of cables shall be in accordance with the latest practice.
- 5.2 All materials to be used shall be new, unused and of the best quality.

	TALCHER FERTILIZERS LIMITED TECHNICAL SPECIFICATION - CABLES	PC183-TS-0815	0	
		Document No.	Rev	
		Sheet 4 of 6		

5.3 Conductors

The power cables shall be of stranded Aluminium / copper round or shaped conductors and control cables shall be of annealed high conductivity stranded copper round conductors. The conductors shall comply with the requirements of IS: 8130.

5.4 Insulation

The conductor insulation shall be XLPE and shall comply with relevant IS.

5.5 Fillers

The cables shall have suitable fillers wherever required, laid up with conductors to provide substantially circular cross section before the inner sheath is applied.

5.6 Inner Sheath

Inner sheath, wherever applicable shall be ST1/ ST2 type compound applied by extrusion process except for paper cables for which it shall be of lead or lead alloy.

5.7 Armouring

All power and control cables shall be armoured. The single core cables shall be armoured with hard drawn Aluminium taps/ wires or any other suitable nonmagnetic material. All other cables shall have galvanized steel wire / strip armouring.

5.8 Outer Sheath

The outer sheath shall be ST1/ ST2 type compound applied by extrusion process and suitable to withstand atmospheric pollution, resistance to termites, fire retardant and coloured black.

5.9 Screening

Screening over conductor and insulation shall be provided as per relevant standard unless specified otherwise. The screening for control cables if specified shall be of aluminium, mylor or equivalent and provided with tinned drain wire which shall be continuous and permanently connected to the screen.

5.10 Identification

The individual cores of cables shall be coloured as per relevant IS. Where it is not possible to distinguish the cores by colour, coloured strip shall be applied on the cores or core nos. shall be marked on each core at regular intervals. All cables shall carry the manufacturer's name or trade mark, the cable size, voltage rating and year of manufacture at intervals not exceeding 100 meters. Running meter markings shall also be provided throughout the length of the cable.

5.11 Dimension

The overall dia. and dia. under armour of the cables shall be indicated by the vendor in the technical particulars. These shall be guaranteed with a tolerance of $\pm 5\%$ but not exceeding 2 mm.



5.12 The cut ends of the cables shall be sealed by means of non-hygroscopic materials.

6.0 SPECIAL PURPOSE CABLES

6.1 Flame Retardant Low Smoke Cables

Flame retardant low smoke cables shall have outer sheath of PVC having following values.

- Minimum oxygen index - 29%
- Minimum temperature index - 250°C

	TALCHER FERTILIZERS LIMITED TECHNICAL SPECIFICATION - CABLES	PC183-TS-0815	0	
		Document No.	Rev	
		Sheet 5 of 6		

- Maximum acid gas generation - 20%
- Maximum smoke density rating - 60%

6.2 Heat Resistant Cables

Heat resistant cables shall be of silicon rubber insulated laid circular with asbestos worming and overall glass fibre braided and varnished. Silicon rubber insulating compound shall conform to IS: 6380 and the constructional features shall conform generally to IS: 9968.

7.0 CABLE DRUM

- 7.1 The cables shall be supplied in non-returnable wooden drums (or steel drums if specified) of heavy construction. The wood used for construction of the drums shall be properly seasoned, sound and free from defects.
- 7.2 Cables shall be supplied in specified drum lengths. Where no such indication is given, standard drum lengths may be offered.
- 7.3 The tolerance on each drum of cable shall not exceed $\pm 2.5\%$. However, no negative tolerance on HV cables is acceptable.
- 7.4 All cable drums shall have stencilled data as per relevant IS as well as the purchaser's order no., item no. & drum no.

8.0 TESTS AND INSPECTION

- 8.1 The following tests shall be carried out on the cables as per relevant IS.
- i) Routine Tests - On all cables
 - ii) Acceptance tests - On representative length of each size
 - iii) Type tests - Wherever specified on one cable drum of each size
- 8.2 In addition, the following tests shall be carried out on all fire retardant low smoke cables as per IS or as per the following standards:
- i) Oxygen and temperature index test as per ASTM-D-2863
 - ii) Acid gas emission test as per IEC-754 Part-I
 - iii) Smoke density test as per ASTM-D-2843
 - iv) Flammability test as per IEC-332 Part-I or IS-10810
- 8.3 All the above mentioned tests shall be carried out in the presence of purchaser's representative. In addition, the cables shall be subjected to stage inspection at works and inspection at site for final acceptance.
- 8.4 These tests and inspections shall, however, not absolve the vendor from their responsibility for making good any defect which may be noticed subsequently.

9.0 DRAWINGS AND DOCUMENTS

- 9.1 Drawings and documents as per Annexure-I shall be supplied, unless otherwise specified.
- 9.2 All drawings and documents shall have the following descriptions written boldly.
- Name of client
 - Name of consultant
 - Enquiry / Order Number with plant / project name
 - Code No. and Description

ANNEXURE - I
DOCUMENTATION FOR CABLES

Sl. No.	Document Description	Documents Required (Y / N)		
		With Bid	For Approval	Final
1.	Specification Sheet	N	Y	Y
2.	Technical Particulars	N	Y	Y
3.	Illustrative and Descriptive catalogues	N	N	Y
4.	Installation, Termination and Jointing Instructions	N	N	Y
5.	Test certificates			
	a) Routine	N	N	Y
	b) Type	N	N	Y
6.	Guarantee Certificates	N	N	Y

Note:

1. 4 hard copies & 1 soft copy shall be supplied for approval after order within 4 weeks from the date of LOI.
2. 8 hard copies & 2 soft copies in CD shall be submitted as final documents prior to despatch of the equipment. These shall be made in sets and supplied in fine plastic coated folder.

Y - Yes, N - No

	TALCHER FERTILIZERS LIMITED TECHNICAL SPECIFICATION - PREFABRICATED LADDER TYPE CABLE RACKS	PC183-TS-0816	0	
		Document No.	Rev	
		Sheet 1 of 6		

TECHNICAL SPECIFICATION

PREFABRICATED LADDER TYPE CABLE RACKS

 पी डी आई एल PDIL	TALCHER FERTILIZERS LIMITED TECHNICAL SPECIFICATION - PREFABRICATED LADDER TYPE CABLE RACKS	PC183-TS-0816	0	
		Document No.	Rev	
		Sheet 2 of 6		

CONTENTS

SECTION NUMBER	DESCRIPTION
1.0	SCOPE
2.0	STANDARDS TO BE FOLLOWED
3.0	GENERAL DESIGN AND CONSTRUCTIONAL FEATURES
4.0	MARKING
5.0	TESTS AND INSPECTION
6.0	DRAWINGS AND DOCUMENTS
ANNEXURE - I	DOCUMENTATION FOR PREFABRICATED LADDER TYPE CABLE RACKS

	TALCHER FERTILIZERS LIMITED TECHNICAL SPECIFICATION - PREFABRICATED LADDER TYPE CABLE RACKS	PC183-TS-0816	0	
		Document No.	Rev	
		Sheet 3 of 6		

1.0 SCOPE

- 1.1 This standard covers the technical requirements of design, fabrication, testing at works and delivery in well-packed condition of prefabricated ladder type cable racks.
- 1.2 The standard shall be read in conjunction with Drawing Nos. PDS: E 530 to 538 (9 Sheets).

2.0 STANDARDS TO BE FOLLOWED

- 2.1 The design, manufacture and testing of the cable racks covered by this standard shall comply with the latest issue of following and other relevant Indian Standards, unless otherwise specified. Equipment complying with equivalent IEC standards shall also be acceptable.
- IS: 733 -- Wrought aluminium and aluminium alloy bars, rods and sections for general engineering purposes
- IS: 2629 -- Recommended practice for hot dip galvanising on iron and steel
- IS: 4759 -- Hot dip zinc coatings on structural steel and other allied products
- 2.2 Wherever any requirement, laid down in this standard, differs from that in Indian Standard Specifications, the requirement specified herein shall prevail.

3.0 GENERAL DESIGN AND CONSTRUCTIONAL FEATURES

- 3.1 Ladder type cable racks shall be fabricated as per attached Drawing Nos. PDS: E 530 to PDS: E 538 (9 Sheets).
- 3.2 Cable racks and accessories such as coupler plate, tees, bend, elbows etc. shall be fabricated from 3 mm thick mild steel galvanised sheet or 4 mm thick aluminium 19000 H2 alloy sheet extrusion conforming to designation No. 64430 and condition WP as per IS: 733.
- 3.3 G.I. racks and accessories shall have zinc coating of 800 gm/sq. metre applied by hot dip galvanising process. Galvanising shall be uniform, adherent, smooth and free from defects.
- 3.4 The finished rack and accessories shall be free from sharp edges and corners, burrs and un-evenness. Stepped arrangement of bending is not acceptable. The channel members in the bending shall have uniform curvature and shall be made out of single piece.
- 3.5 The racks shall be supplied in minimum length of 2.4 metre.
- 3.6 Each straight length and bend shall be supplied with two coupling plates fitted at each side channel at one end. The coupling plates shall be supplied with bolts, nuts and washers fitted at the other four holes for fixing to adjoining member.
- 3.7 Coupling plate shall be designed to permit longitudinal adjustment upto ± 10 mm and skew upto 10° .
- 3.8 Clamping arrangement as per attached drawings shall be provided for fixing the rack with the cross support as required.
- 3.9 All the bends, tees and junctions shall be made sufficiently rigid by providing suitable reinforcement on rungs as required.
- 3.10 The rungs shall be connected to the side channels by continuous welding alongwith three sides of rung. Aluminium rack shall be welded by TIG welding process.
- 3.11 All hard wares such as nuts, bolts, washers and crank bolts shall be cadmium plated.

	TALCHER FERTILIZERS LIMITED TECHNICAL SPECIFICATION - PREFABRICATED LADDER TYPE CABLE RACKS	PC183-TS-0816	0	
		Document No.	Rev	
		Sheet 4 of 6		

3.12 Tolerances in various dimension shall be follows:

Length	--	± 5 mm
Width	--	± 2 mm
Height	--	± 1 mm
Bend	--	± 1 mm
Thickness	--	± 0.2 mm

Positive tolerance on total quantity upto ± 5% is acceptable. However, negative tolerance on total quantity is not acceptable.

4.0 MARKING

The packing shall be clearly marked on the outside (on top side & ends) in indelible ink with the following minimum details:

- Part No.
- Size of Tray (Length x Width x Height)
- No. of Tray / Section, Total Weight
- Material Specification
- Client's Name
- Purchase Order No.
- Manufacturer's Name

5.0 TESTS AND INSPECTION

5.1 Following tests shall be carried out on prefabricated cable racks:

Visual inspection and checking for

- i) Quality and thickness of raw material
- ii) Dimensions as per drawing.
- iii) Quality of welding (before galvanising for G.I. racks)
- iv) Preparation of metal surfaces (for G.I. racks).

5.2 After galvanising, G.I. cable racks shall be subjected to following tests as per IS:4759.

- i) Mass of galvanising coating -- At any location the thickness of zinc coating shall not be less than 90 micron. However, average thickness of zinc coating shall not be less than 113 micron.
- ii) Uniformity of galvanising coating.
- iii) Adhesion of galvanising coating.
- iv) 3 samples from each lot shall be taken for testing.
- v) From each lot and size of rack, measure length of 10 trays and average length to be multiplied by number of trays to arrive for total length.

5.3 All the above tests shall be carried out in the manufacturer's works in the presence of Purchaser's representative. In addition to the above tests, the cable racks and its accessories shall be subjected to stage inspection at works and inspection at site for final acceptance.

	TALCHER FERTILIZERS LIMITED TECHNICAL SPECIFICATION - PREFABRICATED LADDER TYPE CABLE RACKS	PC183-TS-0816	0	
		Document No.	Rev	
		Sheet 5 of 6		

5.4 These tests and the Purchaser's inspection shall, however, not absolve the vendor from their responsibility for making good any defect which may be noticed subsequently.

6.0 DRAWINGS AND DOCUMENTS

6.1 Drawings and documents as per Annexure-I shall be supplied, unless otherwise specified.

6.2 All drawings and documents shall have the following descriptions written boldly.

- Name of client
- Name of consultant
- Enquiry / Order Number with plant / project name
- Code No. and Description

	TALCHER FERTILIZERS LIMITED TECHNICAL SPECIFICATION - PREFABRICATED LADDER TYPE CABLE RACKS	PC183-TS-0816	0	
		Document No.	Rev	
		Sheet 6 of 6		

ANNEXURE - I

DOCUMENTATION FOR PRE-FABRICATED LADDER TYPE CABLE RACKS

Sl. No.	Document Description	Documents Required (Y / N)		
		With Bid	For Approval	Final
1.	Illustrative and Descriptive catalogues	N	N	Y
2.	Installation, Termination and Jointing Instructions	N	N	Y
3.	General Arrangement Drawings, showing details of rack, coupling pieces, fasteners, etc.	N	Y	Y
4.	Test certificates	N	N	Y
5.	Guarantee Certificates	N	N	Y

Note:

1. 4 hard copies & 1 soft copy shall be supplied for approval after order within 4 weeks from the date of LOI.
2. 8 hard copies & 2 soft copies in CD shall be submitted as final documents prior to despatch of the equipment. These shall be made in sets and supplied in fine plastic coated folder.

Y - Yes, N - No



TALCHER FERTILIZERS LIMITED
TECHNICAL SPECIFICATION - LOCAL CONTROL STATION

PC183-TS-0817

0

Document No.

Rev

Sheet 1 of 8



TECHNICAL SPECIFICATION

LOCAL CONTROL STATION



CONTENTS

SECTION NUMBER	DESCRIPTION
1.0	SCOPE
2.0	STANDARDS TO BE FOLLOWED
3.0	SERVICE CONDITIONS
4.0	OPERATIONAL REQUIREMENTS
5.0	GENERAL DESIGN & CONSTRUCTIONAL FEATURES
6.0	SPECIAL FEATURES FOR FLAMEPROOF LOCAL CONTROL STATION
7.0	COMPONENT DETAILS
8.0	PAINTING
9.0	TESTS AND INSPECTION
10.0	DRAWINGS AND DOCUMENTS
11.0	SPARES
12.0	PACKING
ANNEXURE - I	DOCUMENTATION FOR LOCAL CONTROL STATIONS

	TALCHER FERTILIZERS LIMITED TECHNICAL SPECIFICATION - LOCAL CONTROL STATION	PC183-TS-0817	0	
		Document No.	Rev	
		Sheet 3 of 8		

1.0 SCOPE

- 1.1 This standard covers the technical requirements of design, manufacture, testing at works and delivery in well-packed condition of Local Control Stations.
- 1.2 This standard shall be read in conjunction with relevant part of Design Philosophy - Electrical and other relevant references as specified therein.

2.0 STANDARDS TO BE FOLLOWED

- 2.1 The design, manufacture and testing of the equipment covered by this standard shall comply with the latest issue of IS/IEC:60947 and other relevant Indian Standards, unless otherwise specified. Equipment complying with equivalent IEC standards shall also be acceptable.
- 2.2 The design and operational features of the equipment offered shall also comply with the provisions of latest issue of the Indian Electricity rules and other relevant statutory Acts and Regulations. The supplier shall, wherever necessary, make suitable modification in the equipment to comply with the above.
- 2.3 Wherever any requirement, laid down in this standard differs from that in Indian Standard Specifications, the requirement specified herein shall prevail.

3.0 SERVICE CONDITIONS

3.1 Ambient Conditions

These shall be as indicated elsewhere in Design Philosophy - Electrical.

3.2 System Details

These shall be as indicated elsewhere in Design Philosophy - Electrical.

4.0 OPERATIONAL REQUIREMENTS

This equipment and associated components shall be suitable for operating satisfactorily under the specified ambient and system conditions.

5.0 GENERAL DESIGN AND CONSTRUCTIONAL FEATURES

- 5.1 The Control Stations shall be suitable for control voltage not exceeding 500V, 50 Hz AC or 220V D.C.
- 5.2 The enclosure shall be of die cast Aluminium alloy LM-6. As an alternative to cast Aluminium, fibre glass enclosure is also acceptable.
- 5.3 The equipment shall have dust, hose and weather proof construction equivalent to IPW-55 as per IS/IEC:60947. These shall be suitable for outdoor location without any additional protection or cover.
- 5.4 A rain-hood shall be offered as an additional item. It shall be made of 14 gauge Aluminium sheet bent to shape. In case of fibre glass enclosure, these can be made of fibre glass.
- 5.5 All external hardware of diameter less than 8 mm shall be of stainless steel and those of diameter 8 mm and above shall be of mild steel cadmium plated or zinc passivated. For fibre glass enclosure Nylon PVC bolts of diameter 8 mm may be used.
- 5.6 The control station shall preferably be with bolted cover. The bolts for retaining the cover in position shall be provided with 10 mm dia. stainless steel and these shall be so arranged that they do not pierce into the door gasket.
- 5.7 All the components shall be mounted on a base plate inside the enclosure. Necessary actuating system for control switch, push button, non yellowing acrylic/ glass cover for

	TALCHER FERTILIZERS LIMITED TECHNICAL SPECIFICATION - LOCAL CONTROL STATION	PC183-TS-0817	0	
		Document No.	Rev	
		Sheet 4 of 8		

ammeter and indication lamps shall be provided on the front cover. No wiring shall be carried out on the front cover.

- 5.8 The layout of components in the control station shall be liberal and standardised.
- 5.9 All mating surfaces shall be smoothly machined and shall be of sufficient width of at least 6 mm. The covers shall be provided with continuous gasket made of neoprene or synthetic rubber to prevent ingress of dust and moisture. The gasket shall be held in position in groove provided in the enclosure and shall be pressed all around uniformly by suitably shaped projection of the door. Gaskets simply glued to the surface are not acceptable.
- 5.10 The enclosure shall be suitable for mounting on wall or on steel structure. 4 Nos. holes suitable for 12 mm bolts shall be provided outside the enclosure for fixing the control stations.
- 5.11 The internal wiring shall be carried by means of single core PVC insulated 1.5 sq. mm stranded copper conductor cable. All termination shall be made with crimping type proper size lugs and shall be properly ferruled.
- 5.12 The control stations shall be completely factory wired and ready for external cable connection.
- 5.13 For easy identification, numbering ferrules shall be provided on all wiring at both ends i.e. equipment end and terminal block end. Terminals for external wiring shall be numbered
- 5.14 The enclosure shall be provided with two earthing terminals with studs of 8 mm. dia. projecting outside the enclosure for connection to earth. These terminals shall not pierce through the enclosure and shall be marked with earthing symbol.
- 5.15 Each control station shall be provided with minimum 2 mm thick stainless steel name plates or consisting of black Perspex with white engraving indicating the code number and description of the equipment controlled by it. Similar labels shall be provided for all indication lamps, push buttons and control switches. The name plate and label shall be fixed with screws only.

6.0 SPECIAL FEATURES FOR FLAME PROOF LOCAL CONTROL STATION

- 6.1 The enclosure shall be in addition, of flameproof execution as per IS: 2148.
- 6.2 The control stations shall be suitable for hazardous area of enclosure group and temperature class as indicated in Design Philosophy - Electrical.
- 6.3 Cables shall enter the terminal box through flame proof cable gland. From the terminal chamber to the main enclosure, the connections shall be made through proper bushings. Direct entry of external cables into the main enclosure shall not be accepted. All entries shall be provided with stainless steel inserts.
- 6.4 An additional earthing terminal inside the terminal chamber shall be provided.
- 6.5 Local control stations and cable gland must be certified by the Central Mining Research Institute, Dhanbad or any other statutory authority for use in the specified hazardous area.

7.0 COMPONENT DETAILS

7.1 Trip-Neutral-Close Switch

TRIP-NEUTRAL-CLOSE switch shall be double pole, 3 position, pistol grip, rotary type having self spring return feature to neutral position. The contacts shall be of phosphor bronze and shall be provided with two breaks in series. Mechanical sequence device to prevent two successive movements to the same position shall be fitted. The switch shall be capable of being padlocked in the 'TRIP' position.

	TALCHER FERTILIZERS LIMITED TECHNICAL SPECIFICATION - LOCAL CONTROL STATION	PC183-TS-0817	0	
		Document No.	Rev	
		Sheet 5 of 8		

- 7.2 **‘Auto-Manual’ Switch**
‘Auto-Manual’ switch shall be single pole stay put type having three positions “AUTO-OFF-MANUAL”. Provision shall be made to padlock the switch in the “OFF” position.
- 7.3 **Selector Switch / Lock Service Switch**
These shall be single pole stay put type having two position with a pistol grip handle and capable of being padlocked in one of the position.
- 7.4 All the switches shall be rotary type with snap or wiping action contact and having a set of normally open and closed contacts in each position. All switches shall be provided with pistol grip handle.
- 7.5 **‘Off-Auto-On’ Switch**
- 7.5.1 ‘OFF-AUTO-ON’ switch shall be in minimum three stack configuration, each stack having three positions with spring return from ‘ON’ to ‘Auto’ position and lockable in ‘OFF’ position by means of padlock.
- 7.5.2 The switch shall have sliding contact between ‘AUTO’ and ‘ON’ position. In ‘OFF’ position the contact shall be completely broken from ‘AUTO’ position.
- 7.6 **Push Buttons**
These shall be spring loaded, with a set of normally closed and open contacts. The push buttons for ‘start’ shall be shrouded type and coloured green while ‘stop’ push buttons shall be un-shrouded type and coloured red. Provision shall be made to padlock the ‘stop’ push button in ‘OFF’ position. The fixing ring shall be metallic white. An oil proof rubber cap shall preferably be provided.
- 7.7 The switches and push buttons shall conform to utilization category AC11/ DC11 as per IS/IEC:60947. The contact shall be rated to make, break and carry inductive current of 5 Amp. at 415 V AC and 1 Amp of 220V DC. The contact arrangement shall be as shown in the terminal drawings. Built in locks instead of padlocking are not acceptable.
- 7.8 **Indication Lamps**
- 7.8.1 LED type indication lamps shall be provided to indicate the various circuit conditions as shown in the terminal drawings.
- 7.8.2 The LEDs shall provide good illumination through a viewing angle of 180°. The LEDs shall have lumen output of 200 milli Candella in the axial direction.
- 7.8.3 The colour of the LED indication for various functions shall be as follows:-
- RED : For ‘ON’ Indication
GREEN : For ‘OFF’ Indication
WHITE : For “Ready for Service” Indication
- 7.9 **A.C. Ammeters**
The ammeter shall be flush mounting, moving iron spring controlled type, of accuracy class 1.5 as per IS:1248, with square face of minimum size 72 mm x 72 mm having scale range 0-240°. The ammeter shall be provided with uniform scale up to CT primary current and compressed end scale up to 6 times the CT primary current. Adjustable red pointer shall be provided to indicate the full load current of the motors. Zero adjusters shall be provided for operation from the front of the meter. All ammeters shall be operated through 1Amp. CTs only.

	TALCHER FERTILIZERS LIMITED TECHNICAL SPECIFICATION - LOCAL CONTROL STATION	PC183-TS-0817	0	
		Document No.	Rev	
		Sheet 6 of 8		

7.10 **D.C. Ammeters**

The D.C. ammeter shall be shunt operated. These shall be moving coil or moving iron type of accuracy class 1.5 as per IS: 1248.

7.11 **Terminal Blocks**

All control stations shall be provided with terminal blocks. Terminal blocks shall be located at a minimum distance of 50 mm from the bottom of the enclosure. The terminal blocks for the control station shall be suitable for conductor sizes of 2.5 mm². These shall be of pressure clamp type design mounted on the base channel. The minimum rating of terminal block shall be 16 Amp.

7.12 **Cable Glands**

The cables for the external connections, shall enter the terminal chamber through heavy duty double compression type rolled Aluminium cable glands suitable for 2.5 sq. mm PVC insulated, armoured, and PVC sheathed copper conductor 1.1 KV grade cables. The number and cores of control cables shall be as per requirement. The cable gland shall be fitted in a threaded hole.

8.0 PAINTING

8.1 The enclosure after suitable pre-treatment shall be painted with two coats of anti-rust paint followed by two coats of anticorrosive paint.

8.2 Epoxy based paint shall be used.

8.3 All paints shall be carefully selected to withstand tropical heat and extremes of weather. The paint shall not scale off, crinkle or be removed by abrasion due to normal handling.

8.4 Unless otherwise specified, the finishing shade shall be of light grey having shade no. 631 as per IS: 5.

9.0 TESTS AND INSPECTION

9.1 All equipment shall be routine tested as per relevant standards.

9.2 Additional tests, wherever specified, shall be carried out.

9.3 All the above mentioned tests shall be carried out in the presence of purchaser's representative. In addition, the equipment shall be subjected to stage inspection at works and inspection at site for final acceptance.

9.4 These inspections shall, however, not absolve the vendor from their responsibility for making good any defect which may be noticed subsequently.

10.0 DRAWINGS AND DOCUMENTS

10.1 Drawings and documents as per Annexure-I shall be supplied, unless otherwise specified.

10.2 All drawings and documents shall have the following descriptions written boldly.

- Name of client
- Name of consultant
- Enquiry / Order Number with plant / project name
- Code No. and Description

11.0 SPARES

11.1 Commissioning Spares : Commissioning spares, as required, shall be supplied with the main equipment. Item-wise list of recommended commissioning spares shall be furnished for information.

	TALCHER FERTILIZERS LIMITED TECHNICAL SPECIFICATION - LOCAL CONTROL STATION	PC183-TS-0817	0	
		Document No.	Rev	
		Sheet 7 of 8		

- 11.2 Spares for 2 Years Operation (Mandatory), as specified shall be supplied.
- 11.3 List of Recommend Spares (other than Mandatory Spares) alongwith recommended quantity and item-wise price shall be furnished.
- 11.4 All spare parts shall be identical to the parts used in the equipment.

12.0 PACKING

- 12.1 The local control stations shall be properly packed to safeguard against weather conditions and handling during transit. It shall be wrapped in polythene bags and an additional wrapping of bitumen paper shall also be provided to make it completely water proof before the equipment is packed in wooden crates.
- 12.2 The packing box shall contain a copy of the installation, operation and maintenance manual.



ANNEXURE - I

DOCUMENTATION FOR LOCAL CONTROL STATIONS

Sl. No.	Document Description	Documents Required (Y / N)		
		With Bid	For Approval	Final
1.	Specification Sheet	N	Y	Y
2.	Technical Particulars	N	Y	Y
3.	General Arrangement Drawings	N	Y	Y
4.	Schematic Diagrams	N	Y	Y
5.	Illustrative and Descriptive catalogues	N	N	Y
6.	Catalogues of bought out accessories	N	N	Y
7.	Spare parts list	N	N	Y
8.	Installation, Operation and Maintenance manual	N	N	Y
9.	Test certificates			
	a) Routine	N	N	Y
	b) Type (only for flameproof equipment)	N	N	Y
	c) For enclosure	N	N	Y
10.	Guarantee Certificates	N	N	Y

Note:



1. 4 hard copies & 1 soft copy shall be supplied for approval after order within 4 weeks from the date of LOI.
2. 8 hard copies & 2 soft copies in CD shall be submitted as final documents prior to despatch of the equipment. These shall be made in sets and supplied in fine plastic coated folder.

Y - Yes, N - No

	TALCHER FERTILIZERS LIMITED TECHNICAL SPECIFICATION - JUNCTION BOX	PC183-TS-0818	0	
		Document No.	Rev	
		Sheet 1 of 6		

TECHNICAL SPECIFICATION

JUNCTION BOX

	TALCHER FERTILIZERS LIMITED TECHNICAL SPECIFICATION - JUNCTION BOX	PC183-TS-0818	0	
		Document No.	Rev	
		Sheet 2 of 6		

CONTENTS

SECTION NUMBER	DESCRIPTION
1.0	SCOPE
2.0	STANDARDS TO BE FOLLOWED
3.0	SERVICE CONDITIONS
4.0	GENERAL DESIGN & CONSTRUCTIONAL FEATURES
5.0	SPECIAL FEATURES FOR JUNCTION BOXES FOR HAZARDOUS AREA
6.0	PAINTING
7.0	TESTS & INSPECTION
8.0	PACKING
9.0	DRAWINGS AND DOCUMENTS
10.0	SPARES
ANNEXURE - I	DOCUMENTATION FOR JUNCTION BOXES

	TALCHER FERTILIZERS LIMITED TECHNICAL SPECIFICATION - JUNCTION BOX	PC183-TS-0818	0	
		Document No.	Rev	
		Sheet 3 of 6		

1.0 SCOPE

- 1.1 This standard covers the technical requirements of design, manufacture, testing and inspection at works and delivery in well packed condition of junction boxes.
- 1.2 This standard shall be read in conjunction with relevant part of Design Philosophy - Electrical and other relevant references as specified their in.

2.0 STANDARDS TO BE FOLLOWED

- 2.1 The design, manufacture and testing of the equipment covered by this standard shall comply with the latest issue of relevant Indian standards unless otherwise specified. Equipment complying with equivalent IEC standards shall also be acceptable.
- 2.2 Flameproof & increased safety junction boxes shall in addition, comply with the requirement as laid down in IS: 2148 & IS: 6381 respectively.
- 2.3 The design and constructional features of the junction boxes offered shall also comply with the provision of latest issue of the Indian Electricity Rules and other relevant Statutory Rules & Regulations. The supplier shall, whenever necessary, make suitable modification in the equipment to comply with the above mentioned rules.
- 2.4 Wherever any requirement laid down in this standard differs from that in Indian Standard specifications, the requirement specified herein shall prevail.

3.0 SERVICE CONDITIONS

3.1 Ambient Conditions



These shall be as indicated in Design Philosophy - Electrical.

3.2 System Details

The details of power supply system shall be as indicated in Design Philosophy – Electrical.

4.0 GENERAL DESIGN & CONSTRUCTIONAL FEATURES

- 4.1 The junction boxes shall be dust and weather proof and suitable for installation outdoors without extra protection. The degree of protection shall be IP-55 as per IS/IEC:60529.
- 4.2 The junction boxes shall be of die cast aluminium alloy LM-6 with domed / suspension covers.
- 4.3 The casting of the junction boxes and their cover shall be pressure die cast. The casting shall be uniform and free from blow holes. All mechanical surfaces shall be free from burrs, dents and internal roughness.
- 4.4 All external hardware of diameter less than 8 mm shall be of stainless steel and those of diameter 8 mm and above shall be of mild steel cadmium plated or zinc passivated. For fibre glass enclosure Nylon PVC bolts of diameter 8 mm may be used.
- 4.5 The clearances and creepage distances shall be maintained inside the junction boxes as per relevant Indian standard.
- 4.6 The junction boxes shall be suitable for wall / structure / ceiling mounting and necessary arrangement for mounting the same shall be provided.
- 4.7 The junction boxes shall be provided with continuous gasket made of neoprene or synthetic rubber to prevent ingress of dust. The gasket shall be held in position in groove provided in the enclosure and shall be pressed all around uniformly by suitably shaped projection of the door. Gaskets simply glued to the surface are not acceptable.
- 4.8 The junction boxes housing terminal block shall be moulded type made of DMC / Fibre glass. Threaded terminals shall be made of brass (nickel plated or tinned) and provided

	TALCHER FERTILIZERS LIMITED TECHNICAL SPECIFICATION - JUNCTION BOX	PC183-TS-0818	0	
		Document No.	Rev	
		Sheet 4 of 6		

with two tightening threaded nuts and four washers all made of brass (nickel plated or tinned). The terminals shall have two shorting links each horizontally placed connecting three terminals.

- 4.9 The terminal block shall be fitted with junction boxes base by means of 2 nos. 1/2" long nickel plated brass screws.
- 4.10 The junction boxes shall be provided with two nos. external earthing terminals and 1 no. internal earthing terminal.
- 4.11 All live parts inside the junction boxes shall be insulated and shall withstand a test voltage of 2.5 KV for 1 minute.
- 4.12 The junction boxes shall be provided with heavy duty double compression type rolled Al cable glands to suit the cable entries.
- 4.13 Threaded blanking plugs shall be provided for junction boxes to plug out the entries not in use as indicated in bill of quantities enclosed.
- 4.14 The junction boxes shall be provided with a blank stainless steel tag plate fastened to the junction box top cover with two stainless steel screws. The plate shall be at least 25 mm wide, 100 mm long and 1 mm thick.
- 4.15 For flameproof / increased safety junction boxes, the manufacturer shall submit copies of test certificates from statutory authorities clearly stating that the junction boxes as well as cable glands / blanking plugs are suitable for hazardous area.
- 4.16 **15 Amp. Junction Box**
- 4.16.1 The junction boxes shall be 4 way dome cover type.
- 4.16.2 The dimensions of the junction boxes with their cover and accessories shall be generally as per PDS: E-547.
- 4.16.3 The junction boxes housing terminal block shall be moulded type made of DMC / Fibre glass as per Drg. no. PDS: E-557.
- 4.17 **63 Amp. Junction Box**
- 4.17.1 The junction boxes shall be 3 / 4 way dome cover type.
- 4.17.2 The minimum internal diameter of the box shall be 240 mm.
- 5.0 **SPECIAL FEATURES FOR JUNCTION BOXES FOR HAZARDOUS AREA**
- 5.1 For increased safety junction boxes, the terminals shall be provided with positive locking device against loosening.
- 5.2 The enclosure shall be in addition, of increased safety execution, Exe, as per relevant standard and shall be suitable for installation in classified hazardous area.
- 5.3 The junction boxes shall be liberally dimensioned in order to avoid temperature rise inside the enclosure which may damage the insulating materials or gaskets employed therein.
- 5.4 Cables shall enter the terminal box through increased safety compression type cable glands. From the terminal chamber to the main enclosure, the connections shall be made through proper bushings.
- 5.5 An additional earthing terminal inside the terminal chamber shall be provided.
- 5.6 The junction boxes shall be provided with Brass-Nickel plated shorted links. The terminal block shall be made of non-hygroscopic compound. Bakelite / Hylam shall not acceptable.
- 5.7 All screws / bolts and nuts shall be of stainless steel.

	TALCHER FERTILIZERS LIMITED TECHNICAL SPECIFICATION - JUNCTION BOX	PC183-TS-0818	0	
		Document No.	Rev	
		Sheet 5 of 6		

- 5.8 Junction boxes and cable glands must be certified by Statutory Authorities for use in the specified hazardous area. Equipments certified by overseas authorities shall obtain certificate of compliance / letter of opinion from respective statutory authorities.
- 5.9 Type Test certificates for increased safety type junction boxes and cable glands along with blanking plugs shall be supplied.
- 6.0 **PAINTING**
- 6.1 Epoxy based electrostatic powder coating paint shall be provided on exterior surface while the interior of junction boxes shall be painted with anti-condensate paint. The painting shall be able to withstand corrosive atmosphere.
- 6.2 Unless otherwise specified, the finishing shade shall be grey having shade no. 632 as per IS-5.
- 6.3 The terminal block of junction boxes shall be painted with Red, Yellow, Blue & Black colour for phase indication.
- 7.0 **TESTS AND INSPECTION**
- 7.1 The junction boxes shall be routine tested as per relevant standards.
- 7.2 Additional tests, wherever specified, shall be carried out on one unit of each rating.
- 7.3 The procedure & extent of the physical checks, routine & type test shall be governed by Quality Assurance Plan mutually agreed and approved by Inspection Authority.
- 7.4 All the above mentioned tests shall be carried out in the presence of purchaser's representative. In addition, the equipment shall be subjected to stage inspection at works and inspection at site for final acceptance.
- 7.5 These inspections shall, however, not absolve the vendor from their responsibility for making good any defect which may be noticed subsequently.
- 8.0 **PACKING**
Each junction box and cable gland shall be suitably packed and protected from damage due to transportation, loading and unloading. Threaded fittings shall have plastic caps to protect the threading.
- 9.0 **DRAWINGS AND DOCUMENTS**
- 9.1 Drawings and documents as per Annexure-I shall be supplied, unless otherwise specified.
- 9.2 All drawings and documents shall have the following descriptions written boldly:
- Name of client
 - Name of consultant
 - Enquiry / order number with plant / project name
 - Motor Code No. and Description
- 10.0 **SPARES**
- 10.1 Commissioning Spares : Commissioning spares, as required, shall be supplied with the main equipment. Item-wise list of recommended commissioning spares shall be furnished for information.
- 10.2 Spares for 2 Years Operation (Mandatory), as specified shall be supplied.
- 10.3 List of Recommend Spares (other than Mandatory Spares) alongwith recommended quantity and item-wise price shall be furnished.
- 10.4 All spare parts shall be identical to the parts used in the equipment.

ANNEXURE - I



DOCUMENTATION FOR JUNCTION BOXES

Sl. No.	Document Description	Documents Required (Y / N)		
		With Bid	For Approval	Final
1.	Specification Sheet	N	Y	Y
2.	Technical Particulars	N	Y	Y
3.	Certified dimensional drawing, including mounting details	N	Y	Y
4.	Drawing showing constructional details	N	Y	Y
5.	Illustrative and Descriptive catalogues	N	N	Y
6.	Spare parts list	N	N	Y
7.	FLP/Exe certificates for junction boxes and terminals conforming to IEC/ISS (CMRI, CCE, DGFASLI and BARC for terminals)	N	N	Y
8.	Certificate for weather proof construction for junction boxes as per IPW-55	N	N	Y

Note:

1. 4 hard copies & 1 soft copy shall be supplied for approval after order within 4 weeks from the date of LOI.
2. 8 hard copies & 2 soft copies in CD shall be submitted as final documents prior to despatch of the equipment. These shall be made in sets and supplied in fine plastic coated folder.

Y - Yes, N - No

	TALCHER FERTILIZERS LIMITED TECHNICAL SPECIFICATION - ELECTRICALS FOR OVERHEAD CRANES & HOISTS	PC183-TS-0819	0	
		Document No.	Rev	
		Sheet 1 of 10		

TECHNICAL SPECIFICATION

ELECTRICALS FOR OVERHEAD CRANES & HOISTS

	TALCHER FERTILIZERS LIMITED TECHNICAL SPECIFICATION - ELECTRICALS FOR OVERHEAD CRANES & HOISTS	PC183-TS-0819	0	
		Document No.	Rev	
		Sheet 2 of 10		

CONTENTS

SECTION NUMBER	DESCRIPTION
1.0	SCOPE
2.0	STANDARDS TO BE FOLLOWED
3.0	SERVICE CONDITIONS
4.0	GENERAL DESIGN AND CONSTRUCTIONAL REQUIREMENTS
5.0	EQUIPMENT SPECIFICATION
6.0	CABLES, CABLE TERMINATION AND CONNECTIONS
7.0	EARTHING
8.0	CONTROL DESK / CONTROL STATION
9.0	PAINTING
10.0	MAKE OF ELECTRICAL ITEMS
11.0	TESTS AND INSPECTION
12.0	INSTALLATION, TESTING AND COMMISSIONING
13.0	DRAWINGS AND DOCUMENTS
ANNEXURE - I	DOCUMENTATION FOR ELECTRICALS FOR OVERHEAD CRANES & HOISTS

	TALCHER FERTILIZERS LIMITED TECHNICAL SPECIFICATION - ELECTRICALS FOR OVERHEAD CRANES & HOISTS	PC183-TS-0819	0	
		Document No.	Rev	
		Sheet 3 of 10		

1.0 SCOPE

- 1.1 This standard covers the technical requirements of design, engineering, manufacture, testing at works, supply at site, erection, site testing and commissioning of the complete electrical equipment and accessories as required for the overhead travelling crane and hoists.
- 1.2 This standard shall be read in conjunction with relevant mechanical specifications, other relevant standards / specifications.
- 1.3 The scope of work shall include but not limited to the following items:
- i) Drive motors
 - ii) Starting resistors (in case of slip ring motors)
 - iii) Power control panel
 - iv) Control stations
 - v) Limit switches
 - vi) Electromagnetic brakes
 - vii) Power and control cables with accessories
 - viii) Earthing of all equipment
 - ix) All other items, not specified but, required for safe and proper operation
- 1.4 The owner shall provide one no. medium voltage feeder for each crane / hoist and terminate the feeder cable in an isolator located at one end of the bay at a height of 1.5 m from the operating floor. The vendor shall indicate the exact power requirement (running and peak) to enable the owner to size and provide the power supply feeder.
- 1.5 Further distribution of power from this isolator onwards shall be in the vendor's scope.

2.0 STANDARDS TO BE FOLLOWED

- 2.1 The design, manufacture, testing and installation of the equipment shall comply with the latest issue of IS-6547, IS-807 and other relevant Indian Standard specifications and codes of practices. Equipment complying with equivalent IEC standards shall also be acceptable.
- 2.2 The equipment and installation shall also comply with the provisions of latest issue of Indian Electricity rules and other statutory acts and regulations.
- 2.3 Wherever any requirement, laid down in this standard, differs from that in Indian Standard Specification, the requirement specified here-in shall prevail.

3.0 SERVICE CONDITIONS

3.1 Ambient Conditions

These shall be as indicated in Design Philosophy - Electrical.

3.2 System Details

These shall be as indicated in Design Philosophy - Electrical.

- 3.3 The owner shall provide only three phase power at the specified medium voltage. For lighting, control and plug supply the vendor shall provide necessary single phase step-down transformers.

	TALCHER FERTILIZERS LIMITED TECHNICAL SPECIFICATION - ELECTRICALS FOR OVERHEAD CRANES & HOISTS	PC183-TS-0819	0	
		Document No.	Rev	
		Sheet 4 of 10		

3.4 All the electrical equipment shall be so designed that enable the crane / hoist to operate at its rated capacity and specified duty cycle with the system variation under the ambient conditions without exceeding the permissible temperature rise and without any detrimental effect on any part.

4.0 GENERAL DESIGN AND CONSTRUCTIONAL REQUIREMENTS

4.1 The electrical system and installation shall be designed as per latest practice to provide maximum reliability, flexibility, safety to personnel and equipment and ease of operation and maintenance.

4.2 All equipment shall have adequate and standard ratings as per ISS.

4.3 All electrical equipment to be located in indoor plant area shall be enclosed in dust, damp and vermin proof enclosure equivalent to IP-54 as per IS/IEC:60529.

4.4 Equipment to be located outdoor shall be weather proof and have IPW-55 protection as per IS/IEC:60529 and shall also be provided with canopy as far as practicable.

4.5 The equipment to be located in hazardous area shall have additional protection as follows:

- a) Zone – I All the equipment shall be in flameproof execution.
- b) Zone – II The equipment producing sparks under normal operation shall be in flameproof execution and others shall be in increased safety execution.

The equipment shall be suitable for the enclosure group and temperature class as indicated in Design Philosophy - Electrical. The equipment selected shall conform to relevant Indian Standard Specification and must be certified by Central Mining Research Institute, Dhanbad or any other statutory authority for use in the specified hazardous area.

4.6 The pendant push button shall be light weight enclosure of aluminium/ polypropylene etc. In case of hazardous areas, the loop between the pendant push button and the crane control panel shall be made intrinsically safe by using suitable isolators. Alternatively certified flame proof components and increased safety terminals can be housed in the hose proof aluminium / polypropylene enclosure.

4.7 Special care shall be taken to ensure that the parts to be opened for inspection and maintenance retain their dust tightness even after repeated opening and closing operations.

4.8 All mating surfaces shall be properly machined. Neoprene gaskets shall be used for dust and weather proofing. The gaskets shall be without any discontinuity.

4.9 Only non-hygroscopic materials shall be used for insulation. All insulation shall be specially impregnated to withstand ambient conditions and atmospheric pollution.

4.10 All live parts shall be adequately protected to prevent inadvertent or accidental contact.

4.11 The minimum clearance and creepage distance of M.V. equipment shall be 20 and 28 mm respectively and shall be positively maintained after connections.

4.12 All external hardware of diameter less than 8 mm shall be of stainless steel and those of diameter 8 mm and above shall be of mild steel cadmium plated or zinc passivated.

4.13 Earthing terminals complete with sockets and identification marks shall be provided on the enclosure of all electrical equipment. The number of terminals shall be two for equipment rated above 240V and one for those rated 240V and below. Additional internal earthing arrangement shall be provided for flameproof equipment.

	TALCHER FERTILIZERS LIMITED TECHNICAL SPECIFICATION - ELECTRICALS FOR OVERHEAD CRANES & HOISTS	PC183-TS-0819	0	
		Document No.	Rev	
		Sheet 5 of 10		

- 4.14 All equipment shall be provided with stainless steel name plates containing the particulars as per relevant IS along with the description and code nos. of equipment
- 4.15 All the electrical equipment shall be provided with separate terminal box, heavy duty double compression type rolled aluminium cable glands, proper crimping lugs and anti-vibration type terminals suitable for the cable sizes required.
- 4.16 Enclosure for limit switches, pendant push button, junction boxes and magnets etc. shall be of cast aluminium. Enclosure for control panel, transformer and resistors may be of sheet steel. The thickness of the sheet steel for the enclosure shall not be less than 2.5 mm. All enclosures shall be suitably painted to withstand atmospheric pollution as mentioned in the Design Philosophy - Electrical.
- 4.17 The doors or inspection covers shall be provided with threaded knobs or butterfly nuts made of plated carbon steel. Copper or copper alloys shall not be used outside the enclosures.
- 4.18 To facilitate maintenance and testing of all electrical equipment:
- a) Disconnecting links shall be provided where necessary.
 - b) All cable lugs and terminals shall be numbered in a permanent form corresponding to the wiring diagram.
 - c) Easy access and adequate working space shall be provided around all motors, panels, limit switches etc. safety railing shall be provided, where necessary.

5.0 EQUIPMENT SPECIFICATION

5.1 Power Connection

- 5.1.1 The main supply shall be obtained by flexible cable or otherwise as per requirement.
- 5.1.2 In case of overhead bare conductors, they shall be of copper and mounted on side of the crane bridge. Four number of gunmetal type current collector with renewable carbon inserts shall be used for power connection. One end of the bare conductor shall be connected to the owner's isolator by means of fixed cable.
- 5.1.3 In case of flexible cable arrangement, the cable shall be connected at one end of the crane and the other end to owner's isolator. The cable shall be hung at intervals by festooned type arrangement.
- 5.1.4 In either case the power fed to the trolley shall be by means of flexible cables fixed and supported by festooned arrangement.
- 5.1.5 The arrangement of fixing and supporting the flexible cables shall be such that the cable is not damaged due to repeated travelling of the crane and trolley. Supporting G.I. wire shall be provided, wherever required.
- 5.1.6 The collector rollers and shoes shall be designed to avoid sparking.

5.2 Power Control Panel

- 5.2.1 The panel shall house all the necessary electrical equipment for distribution of power and control of individual equipment / circuit.
- 5.2.2 The panel shall be totally enclosed, floor mounting, dead front, free standing type in cubicle construction.
- 5.2.3 The panel shall house the following:
- i) For incoming supply
 - Triple pole switch fuse units
 - Supply 'ON' signal lamps (LED Type)

	TALCHER FERTILIZERS LIMITED TECHNICAL SPECIFICATION - ELECTRICALS FOR OVERHEAD CRANES & HOISTS	PC183-TS-0819	0	
		Document No.	Rev	
		Sheet 6 of 10		

The above switch shall cut off all power driven and associated equipment on the crane except lighting and plug supply circuits.

- ii) For motors
 - Reversing type starter with necessary contactors and timers.
 - Other controlling relays and devices.
- iii) For lighting, control and plug supply
 - Single phase transformers
 - Isolating switch fuse units on primary and secondary sides.

5.2.4 All switches shall be motor duty type (AC 23) and rated for 1.5 times of the full load current of the circuit. The incoming switch shall be interlocked with the panel door.

5.2.5 All contactors shall be air break type and of AC4 utilization categories. The thermal rating of the contactor shall be 1.5 times the full load current of the circuit.

5.2.6 The power contactors shall be interlocked electrically and mechanically so that there shall be no possibility of simultaneous operation of two contactors for the same motor.

5.2.7 Electrical interlock shall be provided between main hoist and micro hoist motors.

5.2.8 All thermal overload relays shall have in-built single phasing feature and ambient compensated, separately mounting and hand reset type. The reset push bottom for thermal overload relays shall be provided on the cover of the control panel so that it is possible to reset the relay from outside without opening the cover of the panel. Also indication shall be provided for hoisting/travel motors tripping on overload.

5.2.9 The panel shall be installed on properly levelled base frame fabricated out of channels of suitable size.

5.3 Motors

5.3.1 The design and specification of all motors shall comply with requirements stated elsewhere in the specifications.

5.3.2 The power rating of the motors shall be 25% higher than the design requirement of the driven equipment, under the specified service and duty conditions.

5.3.3 All motors shall preferably be of squirrel cage type and so designed that smooth acceleration or deceleration of the load is possible without any jerks. Further a maximum displacement of 2 mm when starting and stopping the motor in quick succession shall be guaranteed.

5.3.4 The motors for main hoist and micro hoist shall be suitable for intermittent duty type S4 with 60% C.D.E. and 300 starts / stops per hour. The motors for long travel and cross travel shall be suitable for S2 duty for 60 minutes.

5.3.5 The motors shall be so located that all parts are accessible for inspection and maintenance without affecting normal ventilation.

5.4 Brakes

5.4.1 The brakes for each motor shall be suitable for duties as specified below:

- a) Main / Micro hoist S4 duty
- b) Long / cross travel S2 duty

5.4.2 The coil of the brake shall be wound with fibre glass covered annealed copper conductor suitable for class H application. An additional covering with glass taps shall

	TALCHER FERTILIZERS LIMITED TECHNICAL SPECIFICATION - ELECTRICALS FOR OVERHEAD CRANES & HOISTS	PC183-TS-0819	0	
		Document No.	Rev	
		Sheet 7 of 10		

be provided over the coil. The maximum temperature of the coil for continuous operation shall be limited to 140° C. The coil shall be vacuum impregnated.

5.4.3 For other design details refer mechanical engineering standard.

5.5 **Limit Switches**

5.5.1 Limit switches of both shunt and series type shall be used in control and power circuit.

5.5.2 These shall be heavy duty type and of sturdy construction in cast aluminium enclosure.

5.5.3 The mode of operation of these limit switches shall be positive and direct acting type.

5.5.4 The contacts shall be rated 50% more than the required current ratings.

5.5.5 The width of the roller of limit switches shall be sufficient to avoid slippage of contact with the striker.

5.5.6 The striker provided for operating these limit switches shall have rubber padding on surface which will make contact with roller to actuate it. The limit switches and its roller should be designed to withstand the frequent impact pressure.

5.5.7 Switches in which the contacts are operated by spring or gravity or both on the withdrawal of a chain or similar devices, shall not be used.

5.6 **Transformers**

5.6.1 These shall be of dry type, class H insulated, air cooled, double wound and mounted inside the panel.

5.6.2 The transformers shall be provided with switch fuse unit on their primary side of suitable rating. One side of secondary windings of the transformers shall be earthed and other shall be provided with fuse of suitable rating.

5.7 The rating of the transformers shall be at least 2.5 times the continuous load.

5.8 **Junction Box**

5.9 Junction boxes shall be of cast aluminium construction and adequately sized to enable easy termination of cables.

5.10 **Hand Lamps**

5.10.1 Provision shall be made in the crane for use of hand lamps by installing 2 nos. 24 volts, 2 pin metal clad switch sockets. One of the sockets shall be on the bridge (outside the panel) and the other on the trolley.

5.10.2 The transformer primary and secondary voltage shall be 250V and 25V respectively.

6.0 **CABLES, CABLE TERMINATION AND CONNECTIONS**

6.1 The cables used for fixed wiring shall be 1.1 KV grade PVC insulated armoured and PVC sheathed overall, and shall conform to IS: 1554 Part-I.

6.2 The flexible cable used for power supply to crane and also for interconnection of equipment mounted on moving and fixed part of the crane shall be 1.1 KV grade heavy duty type.

6.3 All cables shall be properly laid and supported with adequately sized aluminium clamps at 500 mm interval.

6.4 Cable entry on all electrical equipment e.g. panels, motors, limit switches, brakes, junction boxes etc. shall be through double compression type rolled aluminium cable glands.

6.5 The internal power wiring of panels shall be carried out by PVC insulated stranded copper flexible cable.

	TALCHER FERTILIZERS LIMITED TECHNICAL SPECIFICATION - ELECTRICALS FOR OVERHEAD CRANES & HOISTS	PC183-TS-0819	0	
		Document No.	Rev	
		Sheet 8 of 10		

- 6.6 The wiring shall be arranged in a neat fashion and supported on PVC channel or PVC stand of screw support.
- 6.7 For equipment mounted on the doors, the wiring shall be carried out with flexible stranded copper cables in such a way that no strain is put on the wires and equipment when the door is opened for inspection and maintenance.
- 6.8 External looping of wires shall be done through separate dust tight junction boxes.
- 6.9 The sizes of power cables to be used shall be subject to owner's approval. The minimum size of power and control cables shall be 16 sq. mm (Al) & 2.5 sq. mm (Cu) respectively.

7.0 EARTHING

- 7.1 The earthing of all electrical equipment shall be carried out in accordance with IS: 3043.
- 7.2 The enclosures of electrical equipment shall be connected to an aluminium earth ring on the crane which in turn shall have effective electrical connection with the bridge.
- 7.3 The crane bridge shall be earthed through the bridge travel runway rails on both sides which in turn shall be earthed to owner's earth ring located on the ground floor.
- 7.4 Further the power supply cable for the crane shall have an additional conductor for earth connection. Both sides of this conductor shall be earthed.
- 7.5 All earth conductors shall be of aluminium.
- 7.6 This size of earth conductor shall be equal to half the size of the power conductor subject to a minimum size of 10 sq. mm.

8.0 CONTROL DESK / CONTROL STATION

- 8.1 The crane shall be controlled either from the floor by means of a pendant control station or from bridge mounted control desk as indicated in the mechanical data sheet.
- 8.2 In either case, the units shall have the following control devices:
- Main off push button with padlocking arrangement.
 - Indication lamps for supply 'ON'
 - Control push buttons, as specified in the mechanical data sheet.
 - All other devices required for safe and proper operation of the crane / hoist.
- 8.3 All push buttons shall be momentary contact type, coloured as per IS: 6875 and have 1 NO and 1 NC contacts.
- 8.4 The bridge mounted control desk, where specified, shall be of totally enclosed and dust tight construction. All controlling equipment shall be mounted on the top. It shall be located at most convenient location to allow movement of the operator. The installation shall be equipped with adjustable chair, fan, light and main isolating switch.
- 8.5 The pendant control station, where specified, shall be in a single enclosure and in totally enclosed dust tight execution. The unit shall be suspended and supported from the bridge platform by flexible steel wire rope. The connection shall be made with a multi core flexible copper conductor cable and shall have 20% spare cores. One core shall be provided for earth connection of the circuit.

9.0 PAINTING

Enclosures of all electrical equipment shall be painted with two coats of epoxy based primers after suitable pre-treatment. Two coats epoxy based paint of approved colour shall be provided.

	TALCHER FERTILIZERS LIMITED TECHNICAL SPECIFICATION - ELECTRICALS FOR OVERHEAD CRANES & HOISTS	PC183-TS-0819	0	
		Document No.	Rev	
		Sheet 9 of 10		

10.0 TESTS AND INSPECTION

- 10.1 All equipment shall be routine tested as per relevant Indian Standard Specifications.
- 10.2 Additional tests, wherever specified, shall be carried out on one equipment of each rating.
- 10.3 All the above mentioned tests shall be carried out in presence of owner's representative.
- 10.4 The owner's inspection shall, however, not absolve the vendor from his responsibility for making good any defects which may be noticed subsequently.
- 10.5 Despatch of materials shall be subject to written consent of owner or his representative.

11.0 INSTALLATION, TESTING AND COMMISSIONING

- 11.1 The vendor shall undertake installation of all electrical equipment in accordance with latest code of practices, in conformity with recommendation of the respective equipment manufacturer, drawings approved by the owner or owner's representative, direction of Engineer-in-charge, statutory regulations and to the entire satisfaction of the owner.
- 11.2 The vendor shall arrange all the necessary erection tools and tackles, testing and measuring instruments and shall supply the required erection materials including structural steel.
- 11.3 Following tests shall be specifically conducted before commissioning in presence of owner's representative. All the test results shall be recorded and submitted to the owner.
- i) Insulation test.
 - ii) Continuity test.
 - iii) High voltage test.
 - iv) Simulation test.

12.0 DRAWINGS AND DOCUMENTS

- 12.1 Drawings and documents as per Annexure-I shall be supplied unless otherwise specified.
- 12.2 All drawings and documents shall have the following description written boldly :
- Name of client
 - Name of consultant
 - Enquiry / Order Number with plant / project name
 - Code No. and Description

13.0 SPARES

- 13.1 Commissioning Spares : Commissioning spares, as required, shall be supplied with the main equipment. Item-wise list of recommended commissioning spares shall be furnished for information.
- 13.2 Spares for 2 Years Operation (Mandatory), as specified shall be supplied.
- 13.3 List of Recommend Spares (other than Mandatory Spares) alongwith recommended quantity and item-wise price shall be furnished.
- 13.4 All spare parts shall be identical to the parts used in the equipment.

ANNEXURE - I

DOCUMENTATION FOR ELECTRICALS FOR OVERHEAD CRANES & HOISTS

Sl. No.	Description	Documents Required (Y / N)		
		With Bid	For Approval	Final
1.	Specification sheet and technical particulars	N	Y	Y
2.	Composite schematic diagram	N	Y	Y
3.	Dimensional drawing showing the mounting details and general arrangement for the following equipment			
	a) Motors	N	Y	Y
	b) Power control panel	N	Y	Y
	c) Control station	N	Y	Y
	d) Limit switches etc.	N	Y	Y
4.	Down shop lead and power supply arrangement with civil scope.	N	Y	Y
5.	Inter-connection with terminal diagram and cable details	N	Y	Y
6.	Operating and maintenance instruction manual	N	N	Y
7.	Catalogues of bought out items	N	N	Y
8.	Test certificates	N	N	Y

Note:

- 4 hard copies & 1 soft copy shall be supplied for approval after order within 4 weeks from the date of LOI.
- 8 hard copies & 2 soft copies in CD shall be submitted as final documents prior to despatch of the equipment. These shall be made in sets and supplied in fine plastic coated folder.

Y - Yes, N - No

- The tenderer shall also quote for any other spares as deemed necessary to be kept in stock for stipulated time.

	TALCHER FERTILIZERS LIMITED TECHNICAL SPECIFICATION - CAPACITOR BANK AND ASSOCIATED EQUIPMENT	PC183-TS-0822	0	
		Document No.	Rev	
		Sheet 1 of 12		

TECHNICAL SPECIFICATION

CAPACITOR BANK & ASSOCIATED EQUIPMENT



CONTENTS

SECTION NUMBER	DESCRIPTION
1.0	SCOPE
2.0	STANDARDS TO BE FOLLOWED
3.0	SERVICE CONDITIONS
4.0	OPERATING REQUIREMENTS
5.0	GENERAL DESIGN FEATURES
6.0	PROTECTIVE SCHEME (PROVIDED BY PURCHASER)
7.0	ACCESSORIES
8.0	PAINTING
9.0	TESTS AND INSPECTION
10.0	DRAWINGS AND DOCUMENTS
11.0	SPARES
12.0	PACKING
ANNEXURE - I	DOCUMENTATION FOR CAPACITOR BANK & ASSOCIATED EQUIPMENT

	TALCHER FERTILIZERS LIMITED TECHNICAL SPECIFICATION - CAPACITOR BANK AND ASSOCIATED EQUIPMENT	PC183-TS-0822	0	
		Document No.	Rev	
		Sheet 3 of 12		

1.0 SCOPE

- 1.1 This standard covers the technical requirements of design, manufacture, testing at works and delivery in packed condition of “ Indoor type Shunt Capacitor Bank & Associated Equipment” required for system power factor improvement.
- 1.2 This standard shall be read in conjunction with relevant part of Design Philosophy - Electrical.
- 1.3 The capacitor bank and associated equipment shall generally consist of the following.
- i) Basic Star connected capacitor bank
 - ii) Basic capacitor unit with built in fuse
 - iii) Discharge resistor
 - iv) Series reactor
 - v) Residual V. T. for mounting voltage unbalance
 - vi) Set of Raychem make heat insulated sleeved of suitable voltage rating for bus bars.
 - vii) Copper bus bar interconnecting the basic units.
 - viii) Set of supporting insulators
 - ix) Hot dip galvanised Steel stand/racks / cabinets of mounting capacitor units complete with interconnection insulator etc.
 - x) Door limit switch
 - xi) Control panel for automatic operation
 - xii) Any other equipment not specified, but required for safe & proper operation of the system.

2.0 STANDARDS TO BE FOLLOWED

- 2.1 The design, manufacture & testing of the equipment covered by this specification shall comply with the latest issues of following Indian standards, unless otherwise specified.

IS: 13925-1,2,3	/IEC	Shunt Capacitor for power system
60871		
IS:5553/IEC60289	/	Series reactors
IEC60076-6/IEC 726		
IEC60186		Voltage Transformers
IEC:593/IS 12672		Internal Fuse for shunt capacitor
IS/IEC:60947		Switch gear and control-gear for voltage up to & including 1000V & 1200V DC
IS/IEC:60947		General requirements for switchgear and control-gear for voltage not exceeding 1000V & 1200V DC
IS :9921		AC Isolator & Earthing switches for voltage above 1000V
IS 2099/ IEC 60137		Bushing for voltage above 1000V
IS 13067		Impregnant For power capacitors
IS 5		Colour of mixed paints
IS 2629		Recommended practice for Hot-Dip Galvanizing of Iron and Steel
IS 4759		Hot-dip zinc coatings on structural steels and other allied products.
IS 60270		High Voltage test technique-Partial Discharge measurements
IS 8084		Interconnecting Bus bars for AC voltage above 1 kV up to and including 36 kV.

	TALCHER FERTILIZERS LIMITED TECHNICAL SPECIFICATION - CAPACITOR BANK AND ASSOCIATED EQUIPMENT	PC183-TS-0822	0	
		Document No.	Rev	
		Sheet 4 of 12		

IEEE 1036	Guide for application of shunt power capacitors
IEEE 18	Standard for shunt power capacitors
IE Act	Indian Electricity Act

2.2 The design & operation features of equipment shall also comply with provision of the latest issue of the Indian Electricity Rules & other relevant statutory acts & regulation. The supplier shall, wherever, necessary, make suitable modification in the equipment to comply with the above.

2.3 Wherever, any requirement laid down in this standard differs, from that in Indian standard specification, the requirement specified herein shall prevail. Equipment complying with equivalent IEC standards shall also be acceptable.

3.0 SERVICE CODITIONS

3.1 Ambient Conditions

These shall be as indicated in Design Philosophy - Electrical.

3.2 System Details

These shall be as indicated in Design Philosophy - Electrical.

4.0 OPERATING REQUIRMENTS

4.1 The capacitor bank and associated equipment shall be suitable for operating at the specified rating continuously with the specified voltage and frequency variation under the ambient condition without exceeding the permissible temperature rise and without any detrimental effect on any part of equipment.

4.2 The capacitor bank and associated equipment shall be suitable for parallel switching and withstand the thermal and dynamic stresses caused by transient during switching operations.

5.0 GENERAL DESIGN FEATURES

5.1 Capacitor Unit

5.1.1 The capacitor bank / sub bank shall comprise of appropriate number of basic single phase units & which shall be connected in star formation to obtain rated KVAR at rated voltage.

5.1.2 Each unit shall have required number of capacitor elements housed in hermetically sealed, leak proof, sheet steel container. The container shall be provided with suitable brackets, supporting insulators, terminal & bushing for external connections.

5.1.3 Each element of basic units has its own built in fuse which shall isolate the faulty element automatically without affecting the healthy elements.

5.1.4 The capacitor units shall have overload capacity as per IS 13925. The capacitor bank shall be suitable for continuous operation at 110% of rated RMS voltage and at 130% of rated RMS current.

5.1.5 Capacitor units shall be all high grade All Polypropylene type with non-PCB base, bio degradable, non-toxic impregnant. The capacitors offered shall be built from best material and shall develop minimum losses. Capacitor bank losses shall be given at



TALCHER FERTILIZERS LIMITED
TECHNICAL SPECIFICATION - CAPACITOR BANK AND
ASSOCIATED EQUIPMENT

PC183-TS-0822

0

Document No.

Rev

Sheet 5 of 12



45°C. Capacitor shall be compact in size, metal enclosed and hermetically sealed. Internal silver wire fuses shall be provided for protection of each capacitor element.

- 5.1.6 The Capacitor bank and associated equipments shall be suitable for parallel switching and withstand the thermal and dynamic stresses by transient during switching operation.
- 5.1.7 All the fasteners and bolts shall be hot dip galvanized or zinc passivated.
- 5.1.8 Capacitors shall be provided with Overpressure protection as necessary for safety. Overpressure switches shall be fitted to the capacitor units and connected to trip the capacitor bank.
- 5.1.9 Each unit shall have required number of capacitor elements housed in sealed, leak proof, sheet steel container. The container shall be provided with suitable mounting brackets, supporting insulators, terminal & bushing for external connections.
- 5.1.10 The indoor capacitor bank units shall be installed in metallic housing with minimum IP-43 protection.
- 5.1.11 Each capacitor unit shall be mounted so that it can be easily removed from the racks and replaced without removing other units, de-assembling any part of the rack.
- 5.1.12 The outside of the capacitor units and other structures should have smooth and tidy look and should be coated with weather-proof, corrosion resistant epoxy paint of light gray shade, shade no. 631 of IS 5. The structure shall be suitably GI coated. Minimum coating shall not less than 600 micron / sq meters.
- 5.1.13 Each element of basic units has its own built in fuse which shall isolate the faulty element automatically without affecting the healthy elements. In case of one element failure, harmful over voltage shall not be generated across remaining elements and shall not make appreciable change in the operation of capacitor bank. An operation of a single fuse element does not cause cascaded fuse blowing. Permissible over voltages and surges do not cause fuse blowing.
- 5.1.14 The operating & design temperature category of the capacitor unit shall be +5°C as per IS-13925 part-1. Only 5°C temperature rise is permissible above the design temperature of 45°C. So maximum temperature in any case shall not exceed 50° C {i.e. 45°C (design) +5°C (temperature rise)}.
- 5.1.15 The capacitor shall have low value of loss which shall not exceed 0.2 watt per KVAR. The loss value of discharge device/resistor and capacitor unit shall be indicated. The tan delta characteristics of the capacitor units shall be furnished. The losses in watts for each capacitor unit including losses in fuses and discharge resistors forming integral part of the capacitors along with losses for series reactor shall be ensured. If these figures of capacitor losses exceed 0.2 watt per KVAR, the capacitors will be liable for rejection. However owner reserve the right to use the faulty capacitor unit till the same are replaced/ rectified. The loss temperature characteristics, characteristics and insulation resistance temperature characteristics shall also be furnished.
- 5.1.16 The bidder shall furnish calculations for rise in voltage in other units in the event of failure of element(s) of a capacitor unit. The maximum rise in voltage shall not be more than 10% of rated voltage even if the entire capacitor unit failed/short circuited and relevant calculations in support of this shall also be furnished.
- 5.1.17 The bidder shall furnish calculation of voltage drop at rated capacitor unit per phase & losses of the reactor.

	TALCHER FERTILIZERS LIMITED TECHNICAL SPECIFICATION - CAPACITOR BANK AND ASSOCIATED EQUIPMENT	PC183-TS-0822	0	
		Document No.	Rev	
		Sheet 6 of 12		

- 5.1.18 For both capacitor and reactor, mounting arrangement and minimum clearance required from live parts shall be indicated clearly and shall be as per Indian Electricity Act/BS162 & IS-13925-Part2 / IEC-60871-2.
- 5.2 **Discharge Device**
- 5.2.1 A suitable discharge resistor of adequate rating shall be permanently connected across the terminals inside the container to discharge the residual voltage to 50V or less within 1 minute for capacitor rated upto 650V and within 5 minute for capacitor rated above 650V.
- 5.3 **PROTECTIVE FUSES**
- 5.3.1 An internal current limiting fuse with high rupturing capacity conforming to relevant IS/IEC and the specific requirements mentioned in IS13925-Part-3/IEC 60871- 3, shall be provided. The characteristics of the fuse shall be such that it shall isolate the faulty unit only, and protect it against mechanical destruction due to internal failure. The fuses shall not melt or deteriorate when subjected to inrush currents which occur during the life of the bank.
- 5.3.2 The fuses shall not make any healthy capacitor element out of circuit, either in course of isolating the faulty element or due to any external fault.
- 5.3.3 The selection of fuse to be done in such a manner that characteristic of fuse shall match suitably with over-current withstand characteristic of associated capacitor unit.
- 5.3.4 The fuses shall be of adequate thermal capacity to cater for the increased heating which may occur due to harmonics and capacitor current fluctuations.
- 5.3.5 The number of externally connected capacitors and the available short-circuit current of the supply system should not affect the current-limiting of internal fuses.
- 5.3.6 It may be noted that provided internal fuses do not lead to case rupture.
- 5.4 **Series Reactor**
- 5.4.1 A suitable series reactor conforming to IS: 5553 to limit the inrush current and suppress the harmonics shall also be provided whenever required.
- 5.4.2 The reactor shall be copper wound, non-magnetically shielded, oil immersed, natural cooled, sealed type and shall be provided with following fittings.
- i) Oil sampling cum drain valves.
 - ii) Filter valves with plugs.
 - iii) Buchholz relay with shut off valves, air release device & alarm and trip contact.
 - iv) Oil temperature indicator with minimum marking.
 - v) Oil level indicator with minimum marking.
 - vi) Oil conservator complete with drain plugs and oil filling hole with cover.
 - vii) Silica gel breather with oil seal & connecting pipes.
 - viii) Explosion vent.
 - ix) Bi-directional rollers.
 - x) Thermometer pocket.
 - xi) Radiator with isolating valves.
 - xii) Marshalling box.
 - xiii) Rating plate, wiring diagram plate & terminal marking plate.
 - xiv) Lifting lugs.
 - xv) Earthing terminals.

	TALCHER FERTILIZERS LIMITED TECHNICAL SPECIFICATION - CAPACITOR BANK AND ASSOCIATED EQUIPMENT	PC183-TS-0822	0	
		Document No.	Rev	
		Sheet 7 of 12		

xvi) Air release device.

xvii) Cable termination arrangement for incoming & outgoing device.

5.4.3 Dry type/ Oil filled reactor shall only be offered. Such reactors shall be class F/H insulated.

5.4.4 The reactor shall have linear volt ampere characteristics upto 150% of rated capacitor current.

5.5 Residual voltage transformer

5.5.1 3 phase dry type residual voltage transformer of adequate capacity to facilitate neutral unbalance protection and rapid discharging of capacitor shall be provided.

5.5.2 The primary winding of voltage transformer shall be star connected while the secondary winding shall be in open delta for connection to neutral phase displacement relay.

5.5.3 The accuracy class shall be 3P for protection & 1 for metering.

5.5.4 RVT shall have primary and secondary windings made of copper.

5.6 Door limit switch

5.6.1 A door limit switch suitable for mounting on the door frame of the capacitor room shall be provided for each bank. This door limit switch shall be used to trip the power supply to capacitors with initiation of opening action of the door of the capacitor room.

5.6.2 A door limit switch shall be totally enclosed in the aluminium / cast iron housing, fully oil, water & dust tight and shall conform to utilization category AC11 / DC11 as per IS: 6875. This shall be fast actuation type provided with 6 sets of 1 NO & 1 NC contacts rated for 5 amps at 415V AC and 1A at 220V DC.

5.7 Capacitor control panel

5.7.1 Capacitor control panel for control, protection and automatic switching operation of MV capacitor bank shall be provided.

5.7.2 Capacitor control panel shall be of dust, damp & vermin proof construction having enclosure class IP-51 as per IS/IEC:60947.

5.7.3 The enclosure shall be fabricated out of the cold rolled sheet steel having minimum thickness of 2 mm. the doors shall have concealed hinges & provided with neoprene gaskets.

5.7.4 The panel shall be liberally designed. All the components shall be accessible from the front. It shall be possible to attend any component without the necessary removing adjacent ones. All the relays, meters, push buttons including lamps etc. shall be flush mounted. The mounting height of components requiring operation & observation shall not be lower than 300 mm & higher than 1800 mm.

5.7.5 The capacitor control panel shall control the capacitor bank which in turn shall have a number of sub banks for easy of control & to maintain the desired power factor under varying load conditions.

The owner shall arrange C.T supply to sense the power factor. Necessary C.T., selector switch, power factor meter and power factor correction relay shall be provided in the control panel. In addition, the control panel shall have Photo manual selector switch and P.F. raise lower push buttons for manual operation. These common features shall be located near the incoming unit.

	TALCHER FERTILIZERS LIMITED TECHNICAL SPECIFICATION - CAPACITOR BANK AND ASSOCIATED EQUIPMENT	PC183-TS-0822	0	
		Document No.	Rev	
		Sheet 8 of 12		

- 5.7.6 Each control shall be provided with TPN switch, voltmeter with selector switch, Ammeter with selector switch and other auxiliaries, as required to receive the incoming power.
- 5.7.7 No. of out going feeders for the control panel shall be decided as per the no. of sub banks to be controlled by it. Each feeder shall be provided with TP switch, fuses, contacts, "ON"& "OFF" indication lamps and other auxiliaries as required.
- 5.7.8 Required no. and size of heavy duty double compression type Aluminium cable glands suitable for incoming and out going power and control cables shall be mounted on removal gland plate provided at a minimum height of 75 mm from the bottom of the panel. Crimping type Aluminium and copper lugs for aluminium and for copper cable respectively shall be provided for termination of cables.
- 5.7.9 The control panel shall be complete with its base channels, foundation bolt etc.
- 5.7.10 A continuous earth bus of aluminium, running along the entire length of the lower part of the control panel shall be provided with lugs at two ends for connection with external earth grid. The minimum size of earth bus shall be 150 sq. mm.
- 5.7.11 Components Details
- 5.7.11.1 The switches shall be of capacitor duty type rated for 1.5 times the rated capacitor current with a minimum rating of 25 A and shall conform to IS/IEC:60947.
- 5.7.11.2 The fuses shall be of non-deteriorating HRC link type and suitably rated for capacitor switching. These shall conform to IS: 13703.
- 5.7.11.3 All contactors shall be of capacitor duty type rated for 50% higher than rated capacitor current & shall conform to IS/IEC:60947. Control supply voltage shall be 240V single phase AC unless otherwise stated. One set of NO & NC potential free contacts shall be made available as spare.
- 5.7.11.4 Ammeter, Voltmeter & power factor meter shall be of accuracy class 1.5 as per IS: 1248 of minimum 96 sq.mm size & shall have 0-240⁰ scale.
- 5.7.11.5 The push buttons & selector switches shall conform to utilisation category AC11/ DC11 as per IS: 6875. Contacts shall be rated for 5A at 415V AC and 1A at 220V DC. The push button shall be of momentary contact spring loaded type with a set of 1 NO & 1 NC contacts. The selector switches shall be stay put type and provided with oval shaped handles.
- 5.7.11.6 The signal lamps shall be LED type. Colour of lamp shall be "Red" for "ON" & "Green" for "OFF" signals.
- 5.7.11.7 Terminal blocks shall be pressure clamp type up to 35 sq. mm. cable and bolted lugs type for higher sizes of cables. The minimum current rating of terminal block shall be 16A. 20% extra terminals shall be provided in the terminal block.
- 5.8 **Bus Bars**
- 5.8.1 All bus bars interconnecting the basic units shall be of copper and shall be fully insulated by using Raychem make heat shrinkable sleeves. All bus bar joints and tap-off connections shall be provided with removable FRP shrouds. The sleeves shall be rated to withstand the system Line-to-Line voltage for 1 minute.
- 5.8.2 The minimum clearances shall be as per relevant standards suitable for the nominal voltage of capacitor banks.
- 5.9 **External cable termination**

	TALCHER FERTILIZERS LIMITED TECHNICAL SPECIFICATION - CAPACITOR BANK AND ASSOCIATED EQUIPMENT	PC183-TS-0822	0	
		Document No.	Rev	
		Sheet 9 of 12		

- 5.9.1 Each capacitor bank / sub bank shall be provided with proper termination arrangement where terminal connection from all the three phases shall be brought for connection with external cable. The termination arrangement shall include cable glands, cable lugs, termination kits, supporting arrangements etc. complete in all respect.
- 5.9.2 A cable box for termination of control cables shall be provided on the RVT. The cable boxes shall be provided with adequately sized cable entries and suitable double compression cable glands made of stainless steel. Tinned copper lugs shall be provided for the connection of all cable cores.
- 5.10 **Interlocks**
All necessary interlocks to ensure correct & safe operation of capacitor banks shall also be provided.
- 5.11 **Earthing**
Each basic capacitor unit shall be connected to the earth strip provided on the steel racks which in turn shall be connected to the main earth grid through two nos. suitable earth terminals provided on the racks.
- 6.0 **PROTECTIVE SCHEME (PROVIDED BY PURCHASER)**
- 6.1 The vendor shall confirm the adequacy of these protective devices and also suggest the setting and any other additional protective devices required.
- 7.0 **Accessories**
The supply shall include the following accessories.
- 7.1 **Control panel space heater**
The control panel shall be provided with a thermostatically controlled space heater, rated for 240V, 50Hz & controlled through double pole miniature circuit breaker.
- 7.2 **Name plate**
- 7.2.1 All the equipment shall be provided with name plates containing all the information's as per relevant standard.
- 7.2.2 All control switches, push buttons, lamps etc. shall have functional identification labels.
- 7.2.3 Name plate of capacitor control panel shall be of black prespex with white engraving and of minimum 3 mm thickness while those on other equipment shall be of stainless steel.
- 7.3 **Warning Plates**
- 7.3.1 Warning plates shall be provided on the door and inside of the equipment, comprising following information:
CAUTION: HIGH VOLTAGE CAPACITORS.
AT BLOWN FUSES, CHARGES MAY REMAIN
- 7.3.2 The warning plates shall be UV resistant engraved plastic.
- 7.4 **Steel racks**
- 7.4.1 Sheet steel racks shall be provided to house the capacitor units, residual P. T. etc. in tier formation.
- 7.4.2 The racks shall be suitable for assembly at site. The racks & hardware used for assembly shall be hot dip galvanized.
- 7.4.3 The rack shall be complete with rack insulators, foundation bolts or any other hardware etc. for assembly into complete bank.

	TALCHER FERTILIZERS LIMITED TECHNICAL SPECIFICATION - CAPACITOR BANK AND ASSOCIATED EQUIPMENT	PC183-TS-0822	0	
		Document No.	Rev	
		Sheet 10 of 12		

7.4.4 Complete assembly of capacitor bank shall be mounted on a pedestal GI frame, which shall be 300 mm high.

7.4.5 Any other accessories required but not specified, shall be supplied to make the capacitor installation complete in all respect and ensure safe & proper operation.

8.0 PAINTING

8.1 The sheet steel enclosure after degreasing, pickling in acid, cold rinsing, phosphatising passivating etc. shall be painted with two coat of anti-rust paints followed by two coats anti corrosive paints.

8.2 Epoxy based paint shall be used.

8.3 All paint shall be carefully selected to withstand tropical heat and extremes of weather. The paint shall not scale off, crinkle or be removed by abrasion due to normal handling.

8.4 Unless otherwise specified, the finishing shade shall be light gray shade no. 631 as per IS: 5.

9.0 TESTS AND INSPECTION

9.1 All capacitor banks and control panel shall be subjected to routine tests as per IS: 2834 and its associated equipment as per relevant standards.

9.2 Additional tests, wherever specified, shall be carried out.

9.3 All the above tests shall be carried out in presence of purchaser's representative. In addition, the equipment shall be subjected to stage inspection during process of manufacture at works & site inspection.

9.4 These inspections shall, however, not absolve the vendor from his responsibility for making good any defect which may be noticed subsequently.

10.0 DRAWINGS AND DOCUMENTS

10.1 Drawings and documents as per Annexure-I shall be supplied, unless otherwise specified.

10.2 All drawings and documents shall have following description written boldly.

- Name of client
- Name of consultant
- Enquiry / Order Number with plant / project name
- Code No. and Description

11.0 SPARES

11.1 Commissioning Spares : Commissioning spares, as required, shall be supplied with the main equipment. Item-wise list of recommended commissioning spares shall be furnished for information.

11.2 Spares for 2 Years Operation (Mandatory), as specified shall be supplied.

11.3 List of Recommend Spares (other than Mandatory Spares) alongwith recommended quantity shall be furnished.

	TALCHER FERTILIZERS LIMITED TECHNICAL SPECIFICATION - CAPACITOR BANK AND ASSOCIATED EQUIPMENT	PC183-TS-0822	0	
		Document No.	Rev	
		Sheet 11 of 12		

- 11.4 All spare parts shall be identical to the parts used in the equipment
- 12.0 **PACKING**
- 12.1 All the equipment shall be properly packed before despatch to avoid damage during transport, storage & handling.
- 12.2 The packing box shall contain a copy of the installation, operation & maintenance manual.
- 12.3 A sign to indicate the upright position on the position of the package to be placed during transport and storage shall be clearly marked. Also proper arrangement shall be provided to handle the equipment.

ANNEXURE - I

DOCUMENTATION FOR CAPACITOR BANK & ASSOCIATED EQUIPMENT

Sl. No.	Description	Documents Required (Y / N)		
		With Bid	For Approval	Final
1.	Specification Sheet	N	Y	Y
2.	Technical Particulars	N	Y	Y
3.	General Arrangement Drgs. with Overall dimensions of the following equipment. - Capacitor bank - Reactor - Control panel	N	Y	Y
4.	Foundation plan indicating certified dimensions floor opening, weight, clearance etc. - Capacitor bank - Reactor - Control panel	N	Y	Y
5.	Schematic & wiring diagram	N	N	Y
6.	Descriptive literature of Various equipment	N	N	Y
7.	Installation, operation & maintenance manual	N	N	Y
8.	Guarantee certificate	N	N	Y
9.	Test certificate	N	N	Y
10.	Spare parts list with identification marks	N	N	Y

Note:

1. 4 hard copies & 1 soft copy shall be supplied for approval after order within 4 weeks from the date of LOI.
2. 8 hard copies & 2 soft copies in CD shall be submitted as final documents prior to despatch of the equipment. These shall be made in sets and supplied in fine plastic coated folder.

Y - Yes, N - No



**TALCHER FERTILIZERS LIMITED TECHNICAL
TECHNICAL SPECIFICATION - AUXILIARY SERVICE
TRANSFORMER**

PC183-TS-0829

0

Document No.

Rev

Sheet 1 of 7



**TECHNICAL SPECIFICATION
AUXILIARY SERVICE TRANSFORMER**

CONTENTS

SECTION NUMBER	DESCRIPTION
1.0	SCOPE
2.0	STANDARDS TO BE FOLLOWED
3.0	SERVICE CONDITIONS
4.0	OPERATING REQUIREMENTS
5.0	GENERAL DESIGN FEATURES
6.0	CONSTRUCTIONAL FEATURES
7.0	FITTINGS
8.0	PAINTING
9.0	TESTS AND INSPECTION
10.0	DRAWINGS AND DOCUMENTS
11.0	SPARES
12.0	PACKING
ANNEXURE - I	DOCUMENTATION FOR AUXILIARY SERVICE TRANSFORMERS

	TALCHER FERTILIZERS LIMITED TECHNICAL TECHNICAL SPECIFICATION - AUXILIARY SERVICE TRANSFORMER	PC183-TS-0829	0	
		Document No.	Rev	
		Sheet 3 of 7		

1.0 SCOPE

- 1.1 This standard covers the technical requirements of design, manufacture, testing at works and despatch in well packed condition of auxiliary service transformers.
- 1.2 This standard shall be applicable for 3 phase / single phase, separate winding transformers of rating below 315 KVA used for Auxiliary services such as lighting, control, Instrument supply etc.
- 1.3 This standard shall be read in conjunction with the relevant specification sheet.

2.0 STANDARDS TO BE FOLLOWED

- 2.1 The design, manufacture and testing of the equipment covered by this standard shall comply with the latest issue of following Indian Standards. Equipment complying with equivalent IEC standards shall also be acceptable.
- | | | |
|-----------------------|----|---|
| IS: 1180 Part - 1 & 2 | -- | Outdoor type 3 phase distribution transformers up to and including 100 KVA, 11 KV |
| IS: 2026 | -- | Power transformers |
| IS: 2026 part 11 | -- | Dry type power transformers |
- 2.2 The design and operational features of the equipment offered shall comply with the provisions of the latest issue of the Indian Electricity Rules and other relevant statutory acts and regulations. The supplier shall, wherever necessary, make suitable modifications in the equipment to comply with the above.
- 2.3 Wherever any requirement, laid down in this standard, differs from that in Indian Standard Specifications, the requirement specified herein shall prevail.

3.0 SERVICE CONDITIONS

- 3.1 Ambient Conditions
These shall be as indicated in Design Philosophy – Electrical.
- 3.2 System Details
These shall be as indicated in Design Philosophy – Electrical.

4.0 OPERATING REQUIREMENTS

- 4.1 The transformer shall be suitable for operating at the rated capacity continuously at any of the taps, under the ambient conditions and with the voltage and frequency variations as indicated in specification sheet without exceeding the permissible temperature and without any detrimental effect on any part.

5.0 GENERAL DESIGN FEATURES

- 5.1 Rated voltage and frequency
These shall be as indicated in Design Philosophy – Electrical.
- 5.2 **Phase connections**
- 5.2.1 Three phase transformer
The primary winding shall be connected in delta and secondary winding in star with neutral point earthed (Vector group Dyn-11)
- 5.2.2 Single phase transformer
Primary winding shall be connected between two phases of a 3 phase system or to the three phases in open delta execution as specified in specification sheet and secondary



**TALCHER FERTILIZERS LIMITED TECHNICAL
TECHNICAL SPECIFICATION - AUXILIARY SERVICE
TRANSFORMER**

PC183-TS-0829

0

Document No.

Rev

Sheet 4 of 7



single phase winding shall have one terminal earthed with the tank through link inside the secondary terminal box.

5.3 Tapping

5.3.1 The transformers shall be provided with off circuit tap changer with tapping of $\pm 2.5\%$ and $\pm 5\%$.

5.3.2 For transformers having primary 3.3 KV and above, tap changing shall be effected with an externally operated handle, capable of being padlocked in any position on the primary side.

5.3.3 For transformers having primary 415V and below, tap changing shall be effected by means of links in the terminal chamber on the primary side.

5.4 Impedance voltage

The impedance voltage of the transformer at 75°C shall be 4% unless indicated otherwise in specification sheet.

5.4.1 Losses

The losses shall be indicated by the vendor and shall be guaranteed, within tolerable limits specified in IS: 2026 at rated voltage and frequency.

5.4.2 Terminal Arrangement

The primary and secondary side terminals shall be brought outside the tank through porcelain bushing in dust and weather proof terminal boxes, with links for tap changing where required and suitable heavy duty double compression type aluminium cable glands and cable lugs for receiving cables as indicated in specification sheet. The neutral point of the secondary winding shall be brought out separately and earthed to the transformer body through test link. Terminal board for the primary and the secondary winding shall be amply sized and made of SRBP/ FRP materials.

5.4.3 Resistance to short circuit

The transformers shall be able to with stand electrodynamic stresses due to terminal short circuit of the secondary assuming primary side fed from the infinite bus.

5.4.4 Cooling System

Transformers rated up to 50 KVA shall be natural air cooled type and above 50 KVA shall be natural oil cooled / natural air cooled type as indicated in specification sheet.

6.0 CONSTRUCTIONAL FEATURES

6.1 Core

The transformer core shall be of high grade non ageing electrical silicon cold rolled magnetic sheet steel of low hysteresis loss and high permeability. The maximum flux density in any part of the core and yoke at rated voltage and frequency shall not exceed 1.7 Tesla for oil cooled transformers and 1.3 Tesla for air cooled transformers.

6.1.1 The tank for oil cooled transformer shall be made of mild steel plate of adequate thickness. Cooling tubes, where necessary, shall be provided.

6.1.2 Air cooled transformer shall be sheet steel enclosed having minimum thickness of 2.0 mm and shall be provided with suitable reinforcement as required. The minimum degree of protection for the enclosure shall be IP: 31. Ventilating louvers, if provided, shall be covered by fine wire mesh.

6.1.3 All external hardware shall be cadmium plated.

	TALCHER FERTILIZERS LIMITED TECHNICAL TECHNICAL SPECIFICATION - AUXILIARY SERVICE TRANSFORMER	PC183-TS-0829	0	
		Document No.	Rev	
		Sheet 5 of 7		

6.2 Windings

- 6.2.1 Coil shall be made out of electrolytic grade copper conductor.
- 6.2.2 Class-F / class-H insulating material shall be used for air cooled transformers.
- 6.2.3 For oil cooled transformer class-A insulating material shall be used. Mineral oil shall comply with IS: 325. 10% extra oil shall be supplied along with transformer in non-returnable drums.
- 6.2.4 Winding assembly shall be dried and impregnated in vacuum with tested insulating oil / varnish.

6.3 Bushing

The bushing insulators shall be rated for the maximum system voltage and shall comply with the requirement laid down in IS: 2099 / IS: 7421. The minimum current rating shall be 250A.

7.0 FITTINGS

7.1 Following fittings shall be provided for air cooled transformers.

- i) Rating and diagram plate
- ii) Lifting lug
- iii) Primary and secondary cable boxes with heavy duty double compression type aluminium cable glands and lugs.
- iv) Earthing terminals
- v) Rollers (for 25 KVA and above)

7.2 In addition to the above following fittings shall be provided for oil cooled transformer.

- i) Oil conservator complete with drain plug, oil filling hole with cover and oil level indicator with minimum marking.
- ii) Silica gel breather
- iii) Dial type thermometer
- iv) Oil sampling cum drain valve
- v) Explosion vent
- vi) Air release plug

7.3 Any other fittings which may be necessary for satisfactory operation of the transformer shall also be provided.

7.4 All fittings shall conform to relevant Indian Standards.

8.0 PAINTING

8.1 The surface shall be painted after removing all dust, scale and foreign adhering matter. All traces of oil and greases should be removed by suitable treatment.

8.2 All steel surfaces in contact with insulating oil shall be painted with heat resistant oil insoluble insulating varnish.

8.3 All steel surfaces exposed to outside shall be painted with suitable anti rust and anti corrosive paints. Epoxy paints shall be used, if indicated in specification sheet.

8.4 All paints shall be carefully selected to withstand tropical heat and extremes of weather. The paint shall not scale off, crinkle or be removed by abrasion due to normal handling.

	TALCHER FERTILIZERS LIMITED TECHNICAL TECHNICAL SPECIFICATION - AUXILIARY SERVICE TRANSFORMER	PC183-TS-0829	0	
		Document No.	Rev	
		Sheet 6 of 7		

8.5 Unless otherwise specified, the finishing shade shall be light grey shade no. 631 as per IS: 5.

8.6 1 litre paint per air / oil cooled transformer shall be supplied for touch up at site.

9.0 TESTS AND INSPECTION

9.1 All transformers shall be routine tested as per IS: 2026.

9.2 Additional tests, wherever specified, shall be carried out on one transformer of each rating.

9.3 All the above mentioned tests shall be carried out in the presence of purchaser's representative. In addition, the transformer shall be subjected to stage inspection at works and inspection at site for final acceptance.

9.4 These inspections shall, however, not absolve the vendor from his responsibility for making good any defect which may be noticed subsequently.

10.0 DRAWINGS AND DOCUMENTS

10.1 The drawings and documents as per Annexure-I shall be supplied, unless otherwise specified.

10.2 All drawings and documents shall have the following descriptions written boldly.

- Name of client
- Name of Consultant
- Enquiry / Order No. with plant / project name
- Equipment Code no. and Description

11.0 SPARES

11.1 Commissioning Spares : Commissioning spares, as required, shall be supplied with the main equipment. Item-wise list of recommended commissioning spares shall be furnished for information.

11.2 Spares for 2 Years Operation (Mandatory), as specified shall be supplied.

11.3 List of Recommend Spares (other than Mandatory Spares) alongwith recommended quantity shall be furnished.

11.4 All spare parts shall be identical to the parts used in the equipment.

12.0 PACKING

12.1 The transformers shall be suitably packed in wooden crates to avoid damage in transit. Oil cooled transformers shall be properly sealed so as to completely exclude oxygen and moisture from coming in contact with oil.

12.2 The packing box shall contain a copy of the installation, operation and maintenance manual.

ANNEXURE – I



DOCUMENTATION FOR AUXILIARY SERVICE TRANSFORMERS

Sl.No.	Description	Documents Required (Y / N)		
		With Bid	For Approval	Final
1.	Specification Sheet, duly completed	N	Y	Y
2.	Technical Particulars, duly filled-in	N	Y	Y
3.	Dimensional drawing with terminal arrangement details	N	Y	Y
4.	Illustrative and descriptive literature	N	N	Y
5.	Installation, Operation and maintenance manual	N	N	Y
6.	Test Certificates	N	N	Y
7.	Guarantee certificate	N	N	Y
8.	Spare parts list with identification marks	N	N	Y

Note :

1. 4 hard copies & 1 soft copy shall be supplied for approval after order within 4 weeks from the date of LOI.
2. 8 hard copies & 2 soft copies in Pendrive shall be submitted as final documents prior to despatch of the equipment. These shall be made in sets and supplied in fine plastic coated folder.



Y - Yes, N - No

	TALCHER FERTILIZERS LIMITED TECHNICAL SPECIFICATION – ELECTRICAL ERECTION, TESTING & COMMISSIONING	PC183-TS-0843	0	
		Document No.	Rev	
		Sheet 1 of 47		

TECHNICAL SPECIFICATION - ELECTRICAL ERECTION, TESTING & COMMISSIONING

CONTENTS

SECTION NUMBER	DESCRIPTION
1.0	Scope
2.0	Codes and Standards
3.0	Equipment Specification
4.0	General Procedure for Erection
5.0	Specification for Electrical Erection
6.0	General Procedure for Testing & Commissioning
7.0	Testing & Commissioning Specifications
8.0	Documentation
9.0	Handing over to Owner
10.0	Obligations & Responsibilities of Contractor
11.0	Terms and Conditions
12.0	Measurement
13.0	Prior Approval of the material to be supplied by Contractor
14.0	Recovery Against Owner's Un-reconciled Materials
15.0	Statutory Approvals
16.0	Guidelines for Safety Measures

	TALCHER FERTILIZERS LIMITED TECHNICAL SPECIFICATION – ELECTRICAL ERECTION, TESTING & COMMISSIONING	PC183-TS-0843	0	
		Document No.	Rev	
		Sheet 3 of 47		

1.0 SCOPE

1.1 This standard covers the technical requirements of erection, testing and commissioning of all Electrical equipments at site.

1.2 This standard shall be read in conjunction with the relevant technical specifications and other references specified therein.

1.3 Scope of Work

1.3.1 The scope of work shall generally include supply (wherever specified), handling, transportation, unpacking, checking, reporting of damages/defects, storage, assembling, erection, installation, including fabrication, alignment, levelling, grouting, welding, bolting, painting, etc., testing and commissioning of various electrical equipments and machineries, illumination system, earthing system, lightning protection and fabrication & installation of steel structural etc. required for the complete electrical system as per drawings & documents, specifications, standards & codes, prevalent rules & regulations and best engineering practices.

1.3.2 Detailed Scope of Work (Supply and Erection) shall be as indicated in project specific Technical Specifications.

1.3.3 The entire electrical installation work shall be carried out in accordance with the following:



- a) Indian Electricity Rules & all applicable Statutory Acts & Regulations
- b) This specification
- c) The latest issue of approved drawings of vendors / consultant
- d) The recommendation of the manufacturers
- e) Latest issue of Relevant IS
- f) The direction of the site engineers

Any additional revision made to the drawings at a later stage, which in the opinion of the consultant / owner is necessary, will be binding on the contractor and shall have to be carried out.



1.3.4 The contractor shall be responsible for:

- a) Obtaining approval from the Electrical Inspector / Factory inspector or any other Statutory Authority for equipment, plant design / drawings and complete installation work.
- b) Carrying out modifications in the equipment & installation as required to comply with the above.
- c) Submitting installation certificates on completion of installation to Electrical Inspector & obtaining certificates of approval of the installation.

These jobs shall be carried at the contractor's own cost and the work shall be deemed to have not completed unless the approved certificates mentioned under (c) are submitted to the owner.

	TALCHER FERTILIZERS LIMITED TECHNICAL SPECIFICATION – ELECTRICAL ERECTION, TESTING & COMMISSIONING	PC183-TS-0843	0	
		Document No.	Rev	
		Sheet 4 of 47		

- 1.3.5 No erection material shall be supplied by the owner. All materials like clamps and tags for cable/ conduit and earthing including hardware material, all tools and tackles required for erection, testing and commissioning such as, but not limited to jacks, welding sets, oxygen/ acetylene gas, cutting set, drilling machines, grinders, pipe bending machine, dies for pipe threading, scaffolding materials, cables, switches for erection power supply and workshops, temporary lightning protection, cable jointing tools, megger, earth tester, primary and secondary injection test sets, substandard meters for calibration of ammeters & voltmeters etc. and any other tools required shall have to be arranged by the contractor.
- 1.3.6 Consumable materials required for the erection jobs such as, but not limited to kerosene, cotton waste, jute, duster shims for alignment & levelling, cement, concrete, bricks, welding electrodes, paints, carbon tetrachloride, unleaded petrol, solder, flux, raul-plug, phill-plug, nylon-plug, anti corrosive grease for copper, aluminium contacts etc. shall also have to be arranged by the contractor.
- 1.3.7 Cleaning of site after completion of erection as well as regular clearance of unwanted material from site, returning of all packing materials, & excess of other material supplied by owner back to owner's stores shall also be covered under the scope of work.
- 1.3.8 All equipments and instruments shall be inscribed with proper number, nomenclature, cautionary signals & other instructions as may be necessary.
- 1.3.9 The contractor shall supply and touch-up any surface of switchgear and other electrical equipments which are scratched and / or damaged during transportation and erection. The paint used shall match exactly the surface being touched up.
- 1.3.10 Major civil engineering works pertaining to electrical equipment like foundation and plate inserts etc., if excluded from the scope of work, the contractor shall check their correctness as per latest manufacturer's drawing and carry out minor civil jobs such as, but not to limited to, grouting of base plates, channels, supports and foundation bolts, cutting holes in wall and ceiling, chipping of floor and ceiling, sealing of cable entries and making good the same after installation of the equipment, levelling and any other minor similar civil works advised by site engineer has to be carried out by the contractor with out any extra charges.
- 1.3.11 The contractor shall furnish all supervision, labour, tools, rigging material and incidental material such as bolts, welding electrodes, anchors etc. required to install, test and adjust the equipment.
- 1.3.12 The contractor shall employ all skilled, semi-skilled and non-skilled labourers for erection, installation & testing as required. All Electricians, cable jointers, wiremen, welder and other employed shall be suitably qualified possessing valid certificates/ licenses recognized by the complement authorities. The owner at its own discretion, put any electrician, wireman, cable jointer to test about competency of technician concerned and the contractor shall have to replace any such staff found incompetent in the opinion of the owner, to execute the job as per the requirement.
- 1.3.13 The contractor shall also furnish a list of Engineers / Supervisors and staff employed by him for erection and installation jobs giving in brief qualification and experience of such staff and indicating whether they hold such competency



	TALCHER FERTILIZERS LIMITED TECHNICAL SPECIFICATION – ELECTRICAL ERECTION, TESTING & COMMISSIONING	PC183-TS-0843	0	
		Document No.	Rev	
		Sheet 5 of 47		

certificates / licences to supervise the electrical installation jobs as required under Indian Electricity Rules & State Electrical Inspectorate Rules.

- 1.3.14 The contractor shall set up his own work-shop and other facilities at site allocated place to undertake fabrication jobs, pipe bending, threading etc.
- 1.3.15 The contractor shall be responsible for recording of all readings and observations during erection, testing and commissioning in registers or on prescribed Performa. These shall be carried out in the presence of owner's representative. All such test data and records shall be duly signed by the contractor's Engineer / Owner's representative and shall be submitted to owner in triplicate.
- 1.3.16 The contractor shall hand over completed job. Minor details not specifically mentioned in the scope or schedule of quantities but required for completeness of the job shall have to be carried out by the contractor with out any extra cost.
- 1.3.17 The contractor shall commission all Electrical equipments and carry out all tests inclusive of load test as per the performance guarantee and will be responsible for final adjustment of relays, instruments, meters, breakers etc.
- 1.3.18 The specifications given under Cl. Nos. 5 & 7 are only guidelines and doesn't give the details entirely. It shall be the responsibility of the contractor to execute the work without any extra cost to owner, in accordance with the standard code of practices, the relevant manufacturer's drawings, owner's drawings, consultant's drawings and as per Site engineer's directions. Further, the stipulations of general conditions of the contract shall prevail over all other conditions stipulated in this specification.

2.0 CODES AND STANDARDS

- 2.1 The erection, testing & commissioning of the equipment shall comply with the latest issues of all relevant Indian Standards and Codes of practices. Design, manufacture, testing & installation of supply items shall also comply with the relevant standards. Equipments complying with equivalent IEC standards shall also be acceptable.
- 2.2 Some of the relevant Indian Standards are as follows:
- | | |
|-------------------|--|
| IS: 10028(Part-2) | Code of practice for selection, installation and maintenance of transformers |
| IS: 6600 | Guide for loading of oil immersed transformers. |
| IS: 10118(Part-3) | Code of practice for selection, installation and maintenance of Switchgear and controlgear |
| IS: 11039 | Requirements for mounting on rails in switchgear and controlgear installations. |
| IS: 1255 | Code of practice for installation and maintenance of power cables upto and including 33 KV rating |
| IS: 14782 | Code of practice for maintenance and testing of large lead-acid batteries for generating systems and substations |
| IS: 2309 | Code of practice for protection of buildings and allied structures against lightning |
| IS: 2551 | Danger notice plates |

	TALCHER FERTILIZERS LIMITED TECHNICAL SPECIFICATION – ELECTRICAL ERECTION, TESTING & COMMISSIONING	PC183-TS-0843	0	
		Document No.	Rev	
		Sheet 6 of 47		

IS: 3043	Code of practice for Earthing
IS: 5216	Recommendations on safety procedures and practices in electrical work
IS: 8437	Guide on effects of current passing through human body
IS: 14786	High voltage / Low voltage prefabricated substations
IS: 900	Code of practice for installation and maintenance of induction motors
IS: 15429	Storage, installation and maintenance of DC motors – Code of practice
IS: 13408	Code of practice for the selection, installation & maintenance of electrical apparatus for use in potentially explosive atmospheres (other than mining application or explosive process manufacture)
IS: 14665(Part 2)	Electric Traction Lifts: Code of practice for installation, operation and maintenance

2.3 The contractor shall observe safety rules and take all necessary safety precautions to carry out the work in the plant.

3.0 EQUIPMENT SPECIFICATION

3.1 All equipments shall conform to the relevant specifications indicated in project specific Technical Specifications. They shall be suitable for specified site & climatic conditions.

3.2 Make of equipments shall be as per project specific requirements. Make of equipment not specified shall be as indicated and shall be subject to Owner / Consultant's approval.

3.3 Drawings and documents for various equipments shall be submitted as per Documentation Schedule indicated in relevant specifications.

4.0 GENERAL PROCEDURE FOR ERECTION



The general procedure governing "Transfer of equipment and materials to Contractor", erection and Final acceptance of Owner/ Consultant are given below:

4.1 Drawal of Equipment from Owner's stores

All equipment and materials, excepting, equipment / erection materials included in Contractor's scope of supply, shall be issued from Owner's store. Contractor shall arrange to draw the necessary equipment / material in the sequence required for erection and transports the same to contractor's store or directly to erection point.

4.2 Contractor's inspection at Owner's stores / Site

On receipt of any material (supplied by the owner) at site, before removing any issued item, contractor shall fully unpack and inspect all equipment received for completeness, signs of damages, defect etc. in the presence of owner's representative and shall get all discrepancies (damage / short supply) duly recorded by owner's/ consultant's authorised representative on the issue note,

	TALCHER FERTILIZERS LIMITED TECHNICAL SPECIFICATION – ELECTRICAL ERECTION, TESTING & COMMISSIONING	PC183-TS-0843	0	
		Document No.	Rev	
		Sheet 7 of 47		

failing which, no claim by the contractor shall be entertained at a later date and he shall be required to make good/replace/repair the defective/ damaged items at no extra cost.

4.3 **Handling and cleaning**

4.3.1 Contractor shall be responsible for proper handling and cleaning of all materials / equipment drawn / supplied by him until Owner / Consultant finally accepts the erected equipment.

4.3.2 Equipment shall be handled with care by experienced riggers under guidance of competent supervisors and as per rigging marks given on cases. Dragging on floor shall be avoided and crane/suitable rollers shall be used for moving the equipment at any times.

4.3.3 The contractor shall be fully responsible for the safe keeping of equipment issued to him till these are erected, tested, commissioned by him and accepted by owner/ consultant.

4.4 **Transportation**

This involves transportation of various electrical equipments / materials from owner's stores / store siding to erection site / Contractor's stores & Contractor's Stores to erection site. When transporting the equipment, it shall be loaded on suitable trailer / trucks as per capacity and size of equipment, and shall be properly supported on the trailers / trucks by means of ropes / stoppers to avoid damage or tilting due to heavy jerks and vibration. Precautions, if any, displayed on equipment shall be strictly observed.

4.5 **Storage**

Whenever materials are required to be stored by the Contractor in his own stores at site, the contractor shall strictly observe the following requirements: -

4.5.1 The contractor shall keep a proper record of the materials handed over to him by owner / consultant at the initial start of the work and the materials drawn by him and kept in his stores.



4.5.2 All equipment and materials shall be properly stored by the contractor at site in the designated storage area provided by the owner.

4.5.3 The contractor shall ensure that all the materials drawn / supplied by him are stored indoor / under shade. However, if a package is temporarily stocked outdoor due to unavoidable reasons, this shall be ensured that the storage area is dry, hard and well-drained area.

4.5.4 Goods must not be placed directly on the floor / ground but shall be kept on blocks, 60 mm to 120 mm above the floor level such that the bottom is well ventilated.

4.5.5 In case of outdoor storage, the contractor at his own cost shall provide waterproof PVC sheets / tarpaulin to cover all goods so as to protect them from rain etc. These sheets / tarpaulin shall be removed for inspection once in a week and if found moist or mouldy, shall be dried in direct sunlight.

4.5.6 In addition to the above, the equipment manufacturer's storage instructions, if any, shall be strictly followed.

	TALCHER FERTILIZERS LIMITED TECHNICAL SPECIFICATION – ELECTRICAL ERECTION, TESTING & COMMISSIONING	PC183-TS-0843	0	
		Document No.	Rev	
		Sheet 8 of 47		



4.6 **Erection Requirements**

- 4.6.1 All work shall be carried out as per drawings supplied. Placing of equipment on foundation, aligning, grouting, connecting, fixing danger notice plate / board on equipment shall be done as specified. Meggering, labelling and painting shall form part of erection requirements.
- 4.6.2 Fixing of supporting frames / pedestals, grouting, cutting and dressing holes in walls / ceiling and any other minor civil work necessary for installation and levelling of electrical equipment are included in electrical erection scope.
- 4.6.3 The scope of erection also includes cable dressing/ clamping/ minor rerouting, minor relocation of fittings, internal cleaning of equipment, overhauling and minor repairs.
- 4.6.4 Fabrication of clamps from the materials specified and clamping of cables on racks, trays etc. fixing of single core cables in tri-foil formation in aluminium clamps, earthing of cable armour and lead sheath, wherever necessary (and as per the details given by Consultant) fall under erection scope of work.
- 4.6.5 Marking of cables by fixing / grouting the cable marks / number tags for every 25 meters along entire route of cables is included in the scope of work. The tags shall be made of Aluminium Strips.
- 4.6.6 The contractor shall without any extra cost, touch up with paint all electrical equipment which are damaged / scratched during handling, erection or repair. The paint used shall match exactly the painted surface of the equipment on which touch-up is done, and shall be epoxy based.
- 4.6.7 The descriptions given above are only to give a preliminary idea about the scope of work and they do not limit the entire scope to these descriptions only. Hence all other parts of the tender document shall be read in conjunction with the referred standards, associated drawings, specification sheets and schedule of materials & services to assess actual scope of work.
- 4.6.8 The contractor shall undertake erection of all equipment specified herein in accordance with good engineering practices in conformity with statutory regulations and Code of Practice and to the entire satisfaction of the purchaser/ owner.
- 4.6.9 The contractor shall arrange all the necessary erection tools, tackles, testing and measuring instruments and shall supply all erection materials as required.

4.7 **Services of Suppliers' Erectors**

For guiding / supervising erection of sophisticated equipment, services of main equipment supplier's engineers / erectors may be made available free of cost to Contractor as per discretion of Owner/ Consultant. However, this will not absolve the contractor from his responsibility nor his obligation to provide his own supervisors or technical personnel.

The contractor shall comply with all the directions, drawings etc. issued to him within the scope of his contract by Supplier's Engineer / Erector.

	TALCHER FERTILIZERS LIMITED TECHNICAL SPECIFICATION – ELECTRICAL ERECTION, TESTING & COMMISSIONING	PC183-TS-0843	0	
		Document No.	Rev	
		Sheet 9 of 47		

4.8 Installation Certificate

On completion of work the contractor shall submit installation certificates in prescribed Performa as required under prevailing Electricity Act/ Rules to Electrical Inspector or other competent statutory body and obtain certificates of acceptance/ approval of Electrical Installation carried out by him.

5.0 SPECIFICATION FOR ELECTRICAL ERECTION

5.1 General

5.1.1 These specifications lay down the erection procedures to be followed for each type of equipment, over and above the general "Erection Requirements".

5.1.2 The contractor shall also follow manufacturer's instructions and any other instructions of consultant / owner / Statutory bodies during erection.

5.1.3 Suggestive Erection Drawings shall be supplied to the successful bidder for Lighting, Earthing, Cable Tray Routing, etc. These drawings may be suitably modified, if required, to suit site requirement with the approval of owner / consultant.

5.1.4 As-Built Drawings shall be prepared by the Erection Contractor and supplied to owner / consultant.

5.2 Prefabricated Sub-Stations

5.2.1 New emerging technologies for Electrical Power Distribution Systems have brought in the concept of Modular / Transportable Sub-Stations instead of conventional RCC Sub-Stations.



5.2.2 Transportable Sub-Stations shall comprise of pre-fabricated transportable modules made of galvanized steel, duly installed with electrical equipment like HV & LV switchboards, distribution boards, lighting transformers, battery, battery chargers, I/O racks, etc. and complete with air conditioning system, illumination, earthing & lightning protection, fire protection & management system, communication system, interconnecting cabling and cable tray support system, etc. within itself.

5.2.3 Most of the work shall be completed and tested at works. After testing, for safe delivery to site, the battery electrolyte shall be removed and all equipments shall be secured.

5.2.4 Due to local transport restrictions, some of the pre-fabricated buildings may be required to be split into units / modules of suitable size for delivery. Splitting shall be done by providing several units placed side by side, each unit complete in itself or a large sub-station split in modules with false walls in between modules for transportation, which shall be removed at the time of assembly at site.

5.2.5 The modules / units shall be assembled at site to complete an Electrical Sub-Station with minimum work required to be done at site. Following work shall be carried out at site:

- a) Transportable building shall be put on prepared foundations and anchored.
- b) Transportation fixtures and temporary walls shall be removed.
- c) Different sections of the transportable buildings shall be joined together.

	TALCHER FERTILIZERS LIMITED TECHNICAL SPECIFICATION – ELECTRICAL ERECTION, TESTING & COMMISSIONING	PC183-TS-0843	0	
		Document No.	Rev	
		Sheet 10 of 47		

- d) Staircases shall be assembled and placed in position.
- e) Cable Trays shall be fixed.
- f) Re-connection of fire protection & internal lighting system.
- g) Internal wiring between sections of the transportable buildings shall be connected.
- h) Connection to ground & lightning protection system.
- i) Installation of panels within transportable building, if supplied by Owner.
- j) Re-testing & commissioning of all the installed panels.

5.2.6 The installation works shall be carried out as per manufacturer's instructions.

5.3 **Transformers**



5.3.1 Contractor's inspection

Particular attention is to be paid to the following while inspecting / examining the transformers for any sign of damage:

- a) Tank side and cooling tubes dented
- b) Cooling Tubes damaged
- c) Any sight glasses broken (including explosion vents)
- d) Bushings cracked / broken
- e) Bolts loose
- f) Oil leakage (particularly along welds)
- g) If gas filled, whether gas pressure O.K.
- h) Valves leakage
- i) Any other damage



5.3.2 Handling

- a) Lift the transformers by lugs or shackles provided for the purpose.
- b) Use lugs and shackles to avoid unbalance while lifting.
- c) Lifting chains not to interfere with any part of the transformer.
- d) Check cover bolts for tightness. Tighten fully (if found loose) before handling. Care shall be taken that the bolt does not rotate to avoid damage of the gasket.
- e) In case use of jacks is necessary, use jacks only on jacking pads provided for the purpose. (Jacks shall never be used under valves or radiator tubes).
- f) Do not keep transformer on bare ground. Where it is not possible, unload transformer directly on the foundation. This can be done with the permission of consultant/ Owner.
- g) Never leave the transformer without putting stoppers of the wheels.

	TALCHER FERTILIZERS LIMITED TECHNICAL SPECIFICATION – ELECTRICAL ERECTION, TESTING & COMMISSIONING	PC183-TS-0843	0	
		Document No.	Rev	
		Sheet 11 of 47		

5.3.3 Erection

- a) Foundation of the transformer shall be prepared and checked for its level as per Drg. before shifting / transferring the transformers from the stores.
- b) Transformer shall be placed on the prepared foundation only.
- c) For transformers of high rating (above 1000 KVA) place the transformer on foundation (channels / rails already grouted on the foundation) as per drawing. Proper time shall be given for curing the level of rails. Rails must be checked and adjusted.
- d) Wheels shall be fixed before placing of the transformer in position. Wheels of the transformers shall be checked for its proper/ free movement on the rails / plates. Greasing shall also be done on the shaft of wheel before placing the wheels in position. Split pins must be used / placed in position before its rolling. It shall also be levelled & aligned with the bus ducts, if bus ducts are to be connected on the LT side of the transformer.
- e) Clamp stoppers to the transformer wheels, immediately after alignment to prevent any movement.
- f) Clean all the accessories like radiators, cooling fans, valves, conservator tanks, explosion vent pipe, bushing and other accessories.
- g) Flush the radiators with hot oil before assembly.
- h) Cloth only shall be used for cleaning purposes (CAUTION: While working on the transformers with hand-holes or bushing holes, take care that no tools or any other foreign matters are dropped into the tanks. All the loose tools shall be properly tied and secured).
- i) Assemble all accessories such as radiators, conservator, valves, explosion vents, Buchholz relay, HV and LV bushings, cable-end termination boxes, marshalling kiosk/box, instruments, capillary tubes, silica gel breathers with dried silica gel, fans etc. as per vendor's drawings and instructions.
- j) Prior to topping up of oil, check for proper tightness of all gaskets joints and operation of shut-off valves. Also fix thermometers.
- k) Test oil samples from each drum for dielectric strength before topping. (Do not fill oil from the drums, which cannot with stand 40 KV for 1 minute).
- l) Filter oil before filling.
- m) Oil shall be filled through filtering machine using metallic hose.
- n) Fill oil to the transformer tank through bottom drain valve to prevent aeration in oil.
- o) Ensure during oil filling operation that no air pockets are left in the tank, and that no dust or moisture enters the oil. Open all air vents. Reduce oil flow rate when oil level is almost up to the bottom of the main cover to prevent internal pressure from rupturing the diaphragm of pressure relief pipe. Allow sufficient time for all air bubbles to escape. Release any air bubble accumulated in Buchholz relay. Close vent plugs.
- p) In case of gas filled transformers, the oil to be filled up under vacuum as per manufacturer's instructions.

	TALCHER FERTILIZERS LIMITED TECHNICAL SPECIFICATION – ELECTRICAL ERECTION, TESTING & COMMISSIONING	PC183-TS-0843	0	
		Document No.	Rev	
		Sheet 12 of 47		

- q) Connect cables to HV terminals and cables/ bus duct to LV terminals of transformer.
- r) Connect control cables / power cables to the marshalling box. Connect Stop push button mounted on the wall of transformer room to trip the transformer.
- s) Transformer body, HV cable box and MV / LV cable box to be earthed at 2 separate points to the main earthing grid.
- t) Transformer neutral to be earthed to separate and distinct neutral earth pits (through Neutral Earthing Resister, where applicable) as per design and drawings.
- u) Provide danger notice board conforming to IS: 2551 and IE Rules 1956 on enclosure or door of the enclosure.
- v) Earth Transformer Room's door / enclosures as per IE Rules, 1956.
- w) Provide Safety items i.e. fire extinguishers, shock treatment chart, fire buckets with screened sand etc.

5.4 **Switch Boards**

5.4.1 Handling



- a) As far as possible lifting of switchboards is to be done by making use of eyebolts provided. Ensure that before lifting, all eyebolts are fully tightened and that panel supports, nuts and bolts are in tact and tight.
- b) If lifting arrangement is not provided / not feasible and final positioning by sliding is unavoidable, retain packing base as long as possible and rolled on suitable pipes. Avoid sliding / dragging panel directly on floor by crowbars.
- c) Maximum care shall be taken to avoid any damage to insulator, bushings, meters and protective equipment.

5.4.2 Erection

- a) Check the foundation according to the drawings. Ensure that all pockets have been rightly made. Fix the datum level, and level the foundation by chipping in such a way that the prescribed point of cubicle base plate is flush with finished floor.
- b) Check the individual cubicle for any deformity and ensure that all faces are straight. Any dent on sheet steel frame is rectified before placing on foundation.
- c) Wherever separate base frames are supplied level and the foundation in both directions (lateral and transverse) and ensure that these have been correctly levelled throughout. In case of runner rails, check the rails for level in both the directions and ensure that they are parallel to each other.

Wherever base frame is fixed to cubicle, place the cubicle on foundation ensuring that holding down bolts are directly over the foundation pockets.

- d) Obtain correct level of panel with respect to floor / existing bus-bar by putting shims below base frame (as per drawing). Shims are to be supplied by the contractor. Measure the level of each frame with reference to datum and ensure that level difference between the two ends of the switchboard base frame is within ± 2 mm.

	TALCHER FERTILIZERS LIMITED TECHNICAL SPECIFICATION – ELECTRICAL ERECTION, TESTING & COMMISSIONING	PC183-TS-0843	0	
		Document No.	Rev	
		Sheet 13 of 47		



Owner shall provide a level benchmark in each sub-station. All levels shall be checked with this mark by Theodolite and the Contractor shall keep a record.

- e) Cubicle shall be so adjusted that front face of all the panels are in one plane, all sides are plumb and corresponding horizontals on all panel faces (e.g. minimum lines, door edges, inter cubicle joints) line up in the same horizontal line(s). Match the cubicles and adjust properly. Provide gasket between edges, if required, so that no inter-panel gaps are seen.
- f) Bolt adjacent cubicles and base frame together. (Drill new holes where corresponding holes of cubicles do not match after levelling, if found necessary).
- g) Grout the foundation bolts with mortar. Also run grouting mixture under base of the cubicle frame and ram to ensure solidity. After grout has set properly, tighten the foundation bolts.
- h) Fix bushing/ insulators of bus-bars as per drawing if these have been despatched loose.

In case of extension panels for existing boards, this must be done before step (d).

5.4.3 Bus Connections and Installation of Loose items

- a) Fix bus bar links and inter panel bus-bar connections with coupling bolts/ supporting insulators. Clean the contact surface of bus bars and links and smear with contact grease before bolting.
- b) Wherever recommended, fix shroud on the joints and fill compound, or compound may be put on joint to form smooth homogenous & spherical shaped mass and then wrapped with tape. Simple taping of joints may also be done. Recommendation of manufacturer/ consultant/ owner shall be followed in this respect.
- c) In case of misalignment of bus bars, adjustments may be necessary. The connecting pieces may have to be re-drilled or re-fabricated.
- d) Check tightness of bus bars bolts connections with torque wrench. Follow vendor's recommendations in this regard.
- e) Install all loose relays, instruments, cable boxes, metering and protective CTs, PTs etc. Before fixing the relays, make sure that they are cleaned and all packing materials have been removed from them and proper operation. Clean the contacts.
- f) Connect all inter-panel bus wiring. Connections of relays and instruments shall be done as per drawings. Check the wiring according to wiring diagram.
- g) Connect all earthing bus bar between the cubicles and it shall be connected at two points by Al/ GI strip or cable to the main earthing ring. Fix all glands for incoming and outgoing and control cable connections on the holes provided for the purpose, as per drawings.

	TALCHER FERTILIZERS LIMITED TECHNICAL SPECIFICATION – ELECTRICAL ERECTION, TESTING & COMMISSIONING	PC183-TS-0843	0	
		Document No.	Rev	
		Sheet 14 of 47		

- h) Drill holes for fixing cable glands/ cable boxes as per drawings, if such holes are not provided. All spare holes, gaps etc. shall be blanked as per instructions of Owner/ Consultant.

5.4.4 Cleaning

After erection is complete all cubicles, switches, starters, CTs, PT Chambers, Bus Bar Chambers etc. shall be cleaned by blowing air (preferably hot air). Surface of the insulation shall be cleaned with cloth soaked in CTC/ Benzene.



5.4.5 Circuit Breaker installation

5.4.5.1 Air Circuit Breaker

- a) Clean the contacts properly with both soaked in CTC/ Benzene etc. Clean and lubricate the operating mechanism, check and rectify the main insulating contacts and bushings and also secondary contact for any damage/ misalignment. Check the locking mechanism.
- b) Manually close and trip the breaker several times and check contact alignment and pressure. Adjustment, if required, shall be done according to the manufacturer's instruction. The arc chute if despatched separately shall be fixed properly, only after checking of contact alignment etc. After fixing the Arc Chute, operate manually the breaker and check the contacts make properly. Measure contact resistance with ductor. Check the operation of OFF-ON indicator.

5.4.5.2 Vacuum Circuit Breaker / SF6 Circuit Breaker

- a) Check the breaker frame for any damage. In case of vertical isolation type, raise and lower the breaker several times and ensure that breaker moves freely on guide, lubricate the mechanism.
- b) Check the operation of locking mechanism. Check the secondary isolating contacts for any deformity. Check HT bushings for any damage and repair if it is minor.
- c) Manually close and trip the breaker several times. Adjust the mechanism as per manufacturer's instruction. Measure the contact resistance with ductor. Check the oil level in the chamber. If level is low, due to leakages, rectify and fill up as per manufacturer's instruction. Check the operation of ON-OFF Indicator.
- d) Check that safety shutter open and close smoothly. Remove the lock if provided before racking in the circuit breakers. Put the circuit breaker inside the cubicles. If cubicle is aligned properly, the circuit breaker shall go smoothly inside the cubicle.
- e) In case of horizontal isolation type circuit breaker, engage the racking mechanism and put the interlock mechanism operates smoothly and adjustment if required shall be done. Slowly rack in the breaker to service position. While racking in, ensure that safety shutters open smoothly. Check the mechanical interlock mechanism. Also check that the main and secondary isolating contacts mesh properly. Conduct this operation a few times to ensure proper functioning and alignment of all mechanism.

	TALCHER FERTILIZERS LIMITED TECHNICAL SPECIFICATION – ELECTRICAL ERECTION, TESTING & COMMISSIONING	PC183-TS-0843	0	
		Document No.	Rev	
		Sheet 15 of 47		

- f) For vertical isolation type circuit breaker, put it first at the test position and check interlock mechanism and also the secondary isolating contacts engaged properly. Put it at service position, and slowly raise it to fully raised position. Ensure that main isolating contact bushings enter bush bars spouts smoothly and contacts mesh properly. Conduct the raising/ lowering operation several times to ensure a smooth functioning of all mechanism. Any other allied work thought necessary for completion of the erection will have to be done by the Contractor.

5.4.5.3 Oil Circuit Breaker

- a) Check the breaker frame for any damage. In case of vertical isolation type, rise and lower the breaker several times and ensure that breaker moves freely on guide, lubricate the mechanism.
- b) Check the operation of locking mechanism; check the secondary isolating contacts for any deformity. Check HT bushings for any damage and repair if it is minor.
- c) After detaching tank, slowly close the breaker manually and check that moving and fixed contacts match properly. Adjustments, if required, shall be done according to manufacturer's instruction. Since contact movements and alignment etc. are adjusted at manufacturer's work, any further adjustment shall be done very carefully.

Do not operate the breaker when there is no oil in the tank. Measure the contact resistance with doctor. While operating the CB manually, check the operation of ON-Off indicator.

- d) Oil filling-Detach the tank and thoroughly clean tank inside with cloth and then with the insulating oil. Fill the tank with insulating oil upon the level. The dielectric strength of oil shall be as per latest IS. In case of supplied in drum not withstanding the dielectric strength as per IS, filter it before filling in the tank. Secure the tank with bolt the top place to ensure good joint.



5.4.6 General Checks

- a) Ensure that all gaskets are in position, replace the same if found damaged.
- b) All opening covers and rear doors shall be bolted with required number of bolts. Take care that no bolt/ nut/ washer gets lost during handling and erection.
- c) Check inter-changeability of breakers of same rating.

5.5 Motor Control Centre / Power & Motor Control Centre (MCC / PMCC)

Erection of MCC / PMCC, if required, is to be carried in accordance with Cl. No. 5.4 above. In addition, the following points are to be observed:

- a) Cable glands shall be fixed in cable gland plates/ cable alloys (Drilling of holes in gland plates are to be done at site as required).
- b) Cable entries are to be made vermin proof.



	TALCHER FERTILIZERS LIMITED TECHNICAL SPECIFICATION – ELECTRICAL ERECTION, TESTING & COMMISSIONING	PC183-TS-0843	0	
		Document No.	Rev	
		Sheet 16 of 47		

5.6 Panelled Equipment

These include AC/ DC Distribution Boards, Thyristor Control Panels, Inverters etc. In addition to the procedure laid down in Clause Nos. 4.0 & 5.3, any other instruction given by the manufacturer shall also be followed.

5.7 Storage Batteries

- a) Installation work for storage battery cells on steel / wooden racks shall be done strictly as per supplier's drawings and instructions.
- b) Steel / wooden racks shall be installed in the battery room on support insulators. The racks shall be plumbed and aligned properly.
- c) Each cell shall be inspected for any damage of its positive, negative plates, containers etc. Cell shall be cleaned properly and all packing materials removed as per manufacturer's instructions.
- d) The cells after assembling the plates, indicators etc. shall be placed on cell insulators over racks and interconnected to each other so as to avoid strain on cell-terminals.
- e) The electrolyte shall be prepared in large glass/ PVC or special jars as per manufacturer's instructions. The jars shall be cleaned with distilled water. The concentrated sulphuric acid shall be added to the distilled water slowly (never add water to sulphuric acid) and electrolyte stirred constantly with PVC rod. Temperature and specific gravity of electrolyte shall be as per manufacturer's instruction.
- f) All necessary safety precautions shall be taken while preparing the electrolyte i.e. goggles, rubber apron, and gloves etc. shall be used.
- g) No foreign materials, dust or dirt etc. shall be allowed to fall in the electrolyte and it shall be kept duly covered.
- h) Connection to the battery charger shall be made.
- i) Prepared electrolyte shall be filled in cells up to mark level of at least 10 mm above upper edge of the plates in a manner approved by manufacturer. Electrolyte shall be allowed to cool down.
- j) While giving initial charges to the cells, instructions of the manufacturer's regarding rate of charging shall be strictly followed and care taken that charging unit is not over loaded more than the rated capacity. During the period of charging, the cells must be topped up as often as necessary to prevent the electrolyte falling below the required level. Distilled water to be used for topping purposes and quantity of distilled water used for topping up of the cells shall be noted.
- k) After initial charging battery shall be discharged at specified rate. Thereafter battery shall be recharged.
- l) Record all battery voltage of each cell, specific gravity, temperature, charging current during charging/discharging and shall be kept in Performa supplied by the supplier or in a form approved by the consultant/Owner. Discharging and recharging operations shall be done as recommended. After final charging the battery shall be put on float charge.

	TALCHER FERTILIZERS LIMITED TECHNICAL SPECIFICATION – ELECTRICAL ERECTION, TESTING & COMMISSIONING	PC183-TS-0843	0	
		Document No.	Rev	
		Sheet 17 of 47		

- m) No naked flame or sunlight shall be permitted in battery room and smoking shall be strictly prohibited.
- n) During initial charging and discharging battery shall not be left unattended.
- o) It is to be assured that battery room is properly ventilated with an exhaust fan / blower.



5.8 Cable Installation

5.8.1 General

- a) Fabrication of chequered plates for trench covers, cutting of all types of Al / GI Cable trays to desired length, laying, spacing, fixing etc. of all types of cables, trays, supports, hangars etc. shall be according to the drawings or according to the instructions given by consultant / owner.
- b) Contractor shall keep accurate record of cable drums issued to him, the drum nos. and actual length of cable taken out of each drum. Each cable length shall be cut from a specific drum as per approved schedule of cable. Length of cable runs shown in the cable schedules is the calculated length only and the actual lengths shall be measured at site before laying and cutting the cable. The contractor shall take extreme care to adjust cable runs from drums so that joints in the cable are avoided and wastage reduced to minimum.
- c) For purpose of measurement of cable run for payment the length of cable between and terminations only will be considered.

5.8.2 Laying

- a) The cable drums shall be properly mounted on jack / on a cable wheel. Make sure that the spindle is suitable for carrying weight of the drum without bending. Check that spindle is laying horizontal on the bearing so as to prevent the drum creeping to one side or to the other while rotating.
- b) Unroll the cables from the drum in correct direction. Rotate drum only as per arrow mark given in the cable drum. Ensure that the end protection box attached to the flange of the drum is removed and securing rope cut to allow cable and move freely. Rotate the cable drum and simultaneously pull cable steadily and with even pulls and not with unnecessary jerk or strain. In no case the cable shall be allowed to twist or kink since this is likely to spring the armour and fracture the insulation and outer serving of the cable.
- c) Do not drag the cable on floor or hard surface. Use only wooden / steel cable rollers for this purpose.
- d) Cable shall not be bent sharply to a small radius. The cable bending radius shall be as large as possible and will not be less than 12 times the outside diameter for paper insulated cables, 8 times for PVC cables and 15 times for XLPE cables. At joint termination, the individual core of cable shall not be bent with bending radius of less than 15 times the diameter over the insulation.
- e) Where cables are laid on the MS racks, trays etc. ensure that trays / racks / supports are fixed properly in an approved manner or according to the

	TALCHER FERTILIZERS LIMITED TECHNICAL SPECIFICATION – ELECTRICAL ERECTION, TESTING & COMMISSIONING	PC183-TS-0843	0	
		Document No.	Rev	
		Sheet 18 of 47		

drawings. Check from drawings that for horizontal runs of cable, bracket, risers, supports and angles are grouted or fixed in formation as required.

- f) In sub-station where large no. of cables rise to panels / switchboards, it shall be ensured that these risers and rising cables do not interfere with cables on racks and rising cables do not cross the other cables in horizontal runs. Risers are to be properly supported so that weight of cable does not fall on terminations. All cable crossings shall be avoided. Cable cross section / power layout drawings shall be followed.
- g) Cable laid in trenches shall be sealed at the entry to hazardous area/non-hazardous area as per details given by Consultant / Owner / Engineer-in-charge.
- h) Openings in substation / MCC rooms and floors for entry of cables shall be sealed after the cables are laid.
- i) Cables shall be clamped as shown in the drawings Care to be taken to space clamps to such intervals as to prevent buckling of cables.
- j) Cables are laid in concrete trenches built by Consultant / Owner having covers of concrete of slabs or chequered plates. The laying of the cable on the racks shall be done in an approved manner and according to the drawings supplied.
- k) Where cables are laid in open concrete trenches / slits, the trench / slits after laying cables shall be filled with sand & lean cement mixture and plastered so that surface flushes with top of trench / slit.
- l) Care shall be taken that cables are not laid in waterlogged area as far as practicable. When laid above ground, cables shall be properly supported on rigid poles at least 2M high. At road crossing, minimum head clearance of 6M shall be provided.

5.8.3 Laying of Cables in underground pipes

- a) Laying of cables in underground pipes shall include excavation of earth along the cable route, laying of pipes, back-filling, ramming and removing extra earth including supply of bricks and sand.
- b) Ground trenches which shall be dug for laying of pipes such as to ensure that depth of the top of the pipe below the ground level shall be 600 mm min. Bottom of the trench shall be properly levelled up and all odd and sharp materials removed. HDPVC / GI pipe shall be laid in the trenches. Proper bends & pull boxes wherever required shall be provided.
- c) After laying of pipes, fill up earth in trench and ram properly. Remove all extra earth from the sides.
- d) Lay the cables as per drawings and instructions of site engineer.
- e) Fix cable markers at 100 M apart and at joints on the entire route length of the cables. The cable markers shall be made of pre-cast concrete block of 300 x 350 x 350 mm size with letter HT Cable, LT Cable, depth of the cable, arrow marks etc. inscribed. These shall have to be supplied by contractor at no extra cost and fixed as per the directions of the Consultant / Owner. The top of the above concrete slab shall have a smooth finish with cement only.

	TALCHER FERTILIZERS LIMITED TECHNICAL SPECIFICATION – ELECTRICAL ERECTION, TESTING & COMMISSIONING	PC183-TS-0843	0	
		Document No.	Rev	
		Sheet 19 of 47		

f) Laying of cables under road crossing shall be avoided to the extent possible. If required, it shall be done in pipes. When a larger number of pipes are laid across the road, manholes shall be built on either side to terminate the surface of road. Backfilled soil shall be rammed thoroughly to prevent road surface cracking due to settlement of loose soil.

g) Railway Crossing

Where the cable is laid under railway track, it shall be laid through cast iron pipe or spun concrete pipe of suitable diameter and strength. The pipe shall be laid not less than 1 M below the surface of the formation level. Pipes shall be laid with the gradient to facilitate drainage of water. Pipes shall be laid up to a minimum distance of 3 M from the centre of the end tracks on either side. The work shall have to be carried out in accordance with the rules and regulations of railways for cable crossings.

Where number of pipes is to be laid along road / rail crossing, these shall be laid in horizontal formation.

Masonry pipes to be constructed at both ends of road / railway crossing pipe and specified notice to be erected at crossing as per railway rules.

5.8.4 Directly buried Cables

- a) Laying of underground cables shall include excavation of earth along the cable route, laying of cables, back-filling, ramming and removing extra earth including supply of bricks and sand.
- b) Where cables are laid directly into ground trenches which shall be dug up for laying cables such as to ensure that depth of the top of the entire cable below the ground level shall be 750 mm min. for medium and low voltage, 900 mm min. for cables from 3.3 KV to 11 KV grade, 1050 mm min. for cables from 22 KV to 33 KV grade and 1000 mm min. for cables at road crossing and at railway level crossing respectively.
- c) Bottom of the trench shall be properly levelled up and all odd and sharp materials removed. Trench bottom shall then be bedded with a 75 mm thick layer of sand. Before laying the cable over this bed, approval of consultant / owner for preparation of bed shall be taken. Cable shall be laid in the trenches in straight run, care shall be taken that any kinks or bend are not formed. After laying the cables, bricks shall be placed lengthwise on both the sides of the cable along the entire length to form through.
- d) Fill up space between bricks with sand to height of the bricks.
- e) Place bricks closely width wise on the top of the sand filled through. Fill up earth in trench and ram properly. Remove all extra earth from side. Do not use broken bricks. Only Class-I (of relevant IS) bricks shall be used.
- f) If new cables are to be laid crossing existing cables, the new cables will be laid under existing cable at depth of not less than 200 mm from the existing cable. Ensure that the approach of the new cable to the crossing is uniform and gradually sloped.
- g) Lay the cables as per drawings and instructions of site engineer.

	TALCHER FERTILIZERS LIMITED TECHNICAL SPECIFICATION – ELECTRICAL ERECTION, TESTING & COMMISSIONING	PC183-TS-0843	0	
		Document No.	Rev	
		Sheet 20 of 47		

- h) Fix cable markers at 100 M apart and at joints on the entire route length of the cables. The cable markers shall be made of pre-cast concrete block of 300 x 350 x 350 mm size with letter HT Cable, LT Cable, depth of the cable, arrow marks etc. inscribed. These shall have to be supplied by contractor at no extra cost and fixed as per the directions of the consultant / owner. The top of the above concrete slab shall have a smooth finish with cement only.

5.8.5 Laying in Trenches

- a) RCC slabs and chequered plates lifted from trenches for laying cables shall be put back in position at close of work every day to avoid accident & damage to cables in the trench.
- b) When cables pass through pipes, ends shall be sealed by pouring bitumen compound or any other approved compound as required.
- c) Pipes shall be provided for protection of the cables entering from the floor, trench etc. in the switchgears, MCCs, and pipes shall be sealed against water ingress.

5.8.6 Laying of single core HT un-armoured cables shall be done in manner stated hereunder. Cables shall be arranged in trefoil formation and clamped with suitable clamps. The clamps shall be fixed on cable hanger, racks etc. The cables shall be laid with extreme care without causing any damage to the sheathing cables in trefoil formation shall be bounded at a regular interval and earthed. Where necessary the bounding on trefoil groups shall be interconnected. The cables shall in no case be drawn through metallic pipe, ducts etc.

5.9 Cable Joining & Termination



5.9.1 General

The scope of work includes:

- a) Soldering / crimping of sockets / ferrules and connections at all joints / terminations as per specifications. Sockets shall be provided at all terminations except where pressure clamp type terminals are provided.
- b) Glanding of cable and fixing of cable boxes.

5.9.2 Specifications

- a) All PVC cables shall be terminated in conventional type cable boxes, fitted with wiping gland / compression type gland / clamps with rubber bush. For outdoor terminations double compression type gland and for indoor terminations single compression cable gland shall be used. Boxes may be filled with bituminous compound, epoxy M-seal, as and where specified.
- b) For XLPE cables, special termination kits (heat shrink type) shall be used.
- c) All paper-insulated cables shall be terminated in compound filled type cable boxes using conventional compound filling methods or in special cases resin oil filled or epoxy M-seal cable boxes. Wiping gland / clamp with rubber bush are fitted to the cable box.
- d) All LT and control cables shall be terminated through compression type gland.

	TALCHER FERTILIZERS LIMITED TECHNICAL SPECIFICATION – ELECTRICAL ERECTION, TESTING & COMMISSIONING	PC183-TS-0843	0	
		Document No.	Rev	
		Sheet 21 of 47		

- e) In explosion proof equipment sealing accessories, where provided in cable box, are to be used for sealing the cable entry to the box and termination.
- f) All lighting and control cables shall be provided with crimped Al / Cu Sockets before termination in junction boxes.
- g) In case of LT cables, armours shall be suitably earthed in compression type glands. For HT cables, this shall be done either in glands or by any other suitable means like bonding the armour with suitable wire and connecting same to the earth terminals inside cable box.

5.9.3 Crimping

All cable lugs for Cu conductor's sizes up to 400 sq. mm shall be of crimped type solder less Cu lugs, which shall be crimped by special hand / hydraulic crimping tools. Cable lugs for conductor sizes exceeding above shall be conventional soldering type, heavy duty. All the control cables, which shall be of copper conductor, shall be terminated without any additional lugs in screwed type terminals provided in various equipments. Before crimping the socket inhibiting grease shall be smeared over the conductor. Conductor shall be shaped properly before sliding the socket over it. Crimping shall be done in an approved manner.

5.9.4 Jointing

- a) The jointing shall be done in an approved manner with proper jointing kits. Care shall be taken not to damage the insulation when opening the cable for jointing. Taped / temporary joints shall be avoided.
- b) In case of LT PVCA cables, armours shall be suitably earthed in compression type glands. For HT cables, this may be done either in glands or by any other suitable means, like bounding the armour with suitable wire and connecting same to the earth terminals inside cable box.
- c) Before commencing soldering of the socket, conductor shall be thoroughly cleaned and insulation protected. The ferrules shall be thoroughly cleaned. Ferrule and each strand of the cable shall be thoroughly sweated with solder to completely tin them and fill the conductor gaps and to remove all air pockets. Soldering materials of approved quality as per IES practice shall be used. Taping of the conductors shall be done in an approved manner after crimping / soldering.
- d) Filling up compounds and sealing the cable box, shall never be done in one operation. After the first pouring of compound, it shall be topped up again with compound and then sealed.
- e) Straight through Joints

Jointing of XLPE & PVC / HRPVC cables shall be done with extreme care and manufacturer's instructions shall be strictly followed. Soldering of ferrules shall be done with extreme care as stated earlier.

Earth continuity wire shall be plumbed and or clamped. Compound shall be filled according to the instruction of manufacturer of terminating kit / cable. Joints made inside trench or racks shall be properly supported. Wherever, joints are made inside the ground, brick masonry work shall be done around the joint box and filled with sand and thereafter covered with earth at no extra cost.

	TALCHER FERTILIZERS LIMITED TECHNICAL SPECIFICATION – ELECTRICAL ERECTION, TESTING & COMMISSIONING	PC183-TS-0843	0	
		Document No.	Rev	
		Sheet 22 of 47		

- f) A tent shall be used in all circumstances where jointing work is being done outdoor for protection against rain and to prevent dust from being blown into exposed joint and jointing materials. Extreme care shall be taken to maintain proper phase sequence while terminating at equipment ends. Record of connection details shall be maintained. Conductor shall be shaped properly while terminating and no sharp bend shall be given. Where numbers of cables are connected in parallel, proper tests shall be done before connecting so that no cross connection is made. No phase crossing shall be allowed for making the connection.
- g) Cables shall be supported adequately at the entry to cable box / equipment so that load of cable does not come on cable gland.
- h) All cables shall be meggered (checked for insulation resistance) before and after jointing and insulation resistance values recorded.
- i) While terminating at equipment end, each core shall be properly tagged with numbering ferrules as per nomenclature given in the drawings. Wires shall be dressed and clamped neatly. Bolting shall be done properly.

5.10 Earthing

5.10.1 General

- a) Painting of all earth strip joints with anti-corrosive paint shall be carried out as per details given in the respective drawings / specifications and instructions of owner / Engineer-in-Charge.
- b) All electrical equipment rated 415V and above shall be connected to earth bus by two separate and distinct earth connections. All equipment rated 240V and below shall be earthed with single earth conductor.

5.10.2 Specifications

- a) Earthing conductor above ground shall be of aluminium / copper wire bare or insulated or strip. Earthing conductor buried in ground shall be of G.I. or PVC insulated aluminium / copper cables. Sizes of earthing conductors shall be according to specified drawings. All earthing installations shall conform to IS: 3043 and other relevant standards.
- b) The earthing wires or strips shall be laid along the cable racks, cable trenches, risers and supports. Underground conductors shall run at a depth of 600 mm below ground level. Where these conductors run along with cables, they shall be laid at the same depth as cables. Where conductors run on wall, ceilings, they shall be laid on clamps or brackets made out of Al/ GI strips.
- c) Wherever earthing conductor is passing through floor, walls etc., the conductor shall be taken through PVC / GI pipes.
- d) All paints, enamel etc. shall be removed from point of contact before making connections.
- e) Connections between Al/ GI strips shall be done by welding for connecting Al/ Cu/ GI wire. For connecting Al/ Cu/ GI wires, tinned Cu Socket shall be crimped on the wire. At the equipment end, connections shall be done by bolting. However, connections between GI strips shall be done by welding.



	TALCHER FERTILIZERS LIMITED TECHNICAL SPECIFICATION – ELECTRICAL ERECTION, TESTING & COMMISSIONING	PC183-TS-0843	0	
		Document No.	Rev	
		Sheet 23 of 47		

Connection between Al/ Cu & GI shall be done by bolting. Graphite grease shall be applied on contact surfaces.

- f) Epoxy resin paint or bitumen shall be applied on welded or bolted joints to prevent corrosion and taping done as indicated in the drawing. Connections between Al / Cu wires shall be done by crimping weak back Al / Cu ferrules.
- g) Earth electrodes shall be provided as per drawings / specifications. Work includes excavation of earth, installation of electrodes and test links etc. supply and filling of charcoal and common salt, back filling of earth and removal of extra earth. It also includes making brick wall around the electrode and cover according to drawings / specifications. The testing links shall be grouted on brick wall and connections with earth electrode and conductors shall be made. Distance between two electrodes shall not be less than 10 meters and may be located 4 M away from building foundation.
- h) Earth pits for equipment earthing, transformers neutral earthing and lightning protection shall be separate. However, these pits shall be inter-connected.

5.11 **Lightning Protection**

- 5.11.1 Air termination rod shall be installed as indicated in drawings.
- 5.11.2 Fixing of termination rod on roof with Al sheet shall be done with crank bolt and watertight compound provided.
- 5.11.3 Laying of down conductors and connection shall be done as per drawings. Lightning Protection installations shall conform to relevant IS.
- 5.11.4 Earthing of static equipment like vessels, chimneys etc. where no termination rod and down conductor is provided, shall be done by connecting the equipment base to earth pit by GI / Al strip or PVC insulated Al / Cu wire. Clamps shall be bolted or welded to the base of the equipment.
- 5.11.5 Structures for the storage, protection or use of highly inflammable solids, vapour or gases or in which highly inflammable or explosive dusts or vapour may be present shall be protected against lightning. Such protection is to be carried out as per prevailing Indian / IEC Standards. The following shall be taken care of:
 - a) All major members of metallic structure shall be bonded together and connected to the lightning protective system. Such connections shall be made at least in 2 places.
 - b) Metallic pipe, electrical cable sheath, steel ropes, rails etc. entering the structure but not in electrical contact with earth, shall be bonded to the lightning protective system.
 - c) All metal forming part of the structure, its reinforcement or its equipment shall be bonded or welded together and connected in two places with the lightning protective system.
 - d) The bonding ring conductor shall be run externally about 0.5 M above ground level in order to provide a convenient point for the connection. The ring conductor shall be visible throughout its length. The arrangement of bonding shall be such as to avoid possible sparking.



	TALCHER FERTILIZERS LIMITED TECHNICAL SPECIFICATION – ELECTRICAL ERECTION, TESTING & COMMISSIONING	PC183-TS-0843	0	
		Document No.	Rev	
		Sheet 24 of 47		

5.12 **Plant Lighting**



- 5.12.1 The electrical installation covered by this specification shall conform to relevant Indian Standards and Codes of practices.
- 5.12.2 Where a number of cables are run together inside or outside the plant, the wiring shall be supported on GI / Al trays / steel structures.
- 5.12.3 Erection of light fittings, plug sockets etc. - Fabrication of supports for lighting fittings, sockets, junction boxes shall be done as per the relevant drawings / instructions given by the consultant / owner and same shall be grouted to walls, ceiling or welded to insert plates, steel structures etc. Insert plates on ceilings shall normally be provided. However, if required, the contractor shall, under instruction of the consultant / owner weld such supports to the reinforcement rods after exposing by chipping off concrete at no extra cost. Installation of lighting fittings includes control boxes, where supplied separately, and shall be done as per drawings. Before installation, checking of internal parts, assembly of accessories shall be done as per manufacturer's instruction / drawings.
- 5.12.4 The explosion-proof fittings shall be earthed through third core of the cable used for wiring. The third pin and body of 15 amps switch sockets shall be earthed similarly.
- 5.12.5 Installation of explosion proof equipment shall be done strictly following manufacturer's instruction or relevant Standards. Cable termination shall be done as per relevant drawings. No drilling of holes or any change in construction of equipment or part thereof shall be done.
- 5.12.6 Wiring for AC supply light and plugs may be fixed in the same brackets but wiring for emergency DC supply lights will be fixed separately. In a circuit controlled by one switch in Group Control Switchboard, there will be a number of points. Drawings for lighting layout give only tentative location of fittings and wiring route shall be decided in consultation with consultant / owner. Wiring of circuit shall be bunched together to the extent possible in the same route.
- 5.12.7 For wiring and laying of cables, Cl. 5.8 shall be referred. Cable for wiring, light points, socket outlets, shall normally be laid along wall, ceilings and structures on suitable brackets made out of M.S. / Al sheets or strips. Connections to the points in one circuit shall be taken through junction boxes. Junction boxes shall be suitably located for branching off from the circuit to the individual point. Wherever indicated, cables may be laid directly on walls, ceilings etc. by clamping on saddles.
- 5.12.8 Terminations shall be done in a manner as detailed in Cl. 5.9. Wherever indicated, the wire can be drawn through PVC bushings provided in the fittings. Relevant drawings may also be referred to.
- 5.12.9 Lamps shall be installed after installation of fittings and wirings.
- 5.12.10 All light fittings and corresponding control switches shall be numbered in a permanent way as instructed by consultant / owner / engineer-in-charge.

5.13 **Street Lighting**

In addition to the requirements stated in Clause No. 5.12, the following are also involved:

	TALCHER FERTILIZERS LIMITED TECHNICAL SPECIFICATION – ELECTRICAL ERECTION, TESTING & COMMISSIONING	PC183-TS-0843	0	
		Document No.	Rev	
		Sheet 25 of 47		

- 5.13.1 Excavation of earth, pouring of concrete foundations, erecting, aligning and grouting of poles.
- 5.13.2 Assembly of arms, fixing of lighting fittings, accessories like fuse carrier, control box etc.
- 5.13.3 Laying of cables directly underground as per Cl. 5.8 and connecting to Junction boxes and lighting fittings as per Cl. 5.9.
- 5.14 **Installation of Cable Trays / Risers / Supports**
- 5.14.1 The fabrication work shall be done as per drawings / specifications / sketches in an approved manner and to the complete satisfaction of consultant / owner / engineer-in-charge. The contractor shall take necessary care to avoid wastages. Scrap shall never exceed the permissible limit.
- 5.14.2 Erection of fabricated racks, risers, cable supports etc.
- a) Erection of racks and risers for cable supports shall be done along the cable routes as indicated in the drawings. The contractor before erection shall check the route for any obstruction like process pipelines, structures, equipment etc. In case obstructions are noticed, the matter shall be brought to the notice of consultant/ Owner in writing and racks shall be re-routed as per his instructions.
 - b) As and where indicated in the drawings, supports for racks, risers etc. shall be clamped/ welded on the steel structure, such as MS beams, pipe trestles, insert plates provided in the RCC column etc. for erection of racks.
 - c) Wherever indicated, supports for racks, risers, shall be grouted on walls. Racks & risers shall be installed on such supports and these shall be welded properly.
 - d) Opening on walls / floors shall be provided where racks / risers are crossing floors / walls.
 - e) Heavy channels, risers may also be grouted on the floors in addition to supports provided from walls, ceilings and steel structures.
 - f) As indicated in the drawings, racks and risers shall be erected either in multi-tier or single-tier formation.
- 5.14.3 Erection of supports in Trench
- a) Supports and Hangers shall be grouted with rag bolts on the walls of prepared concrete trench. Insert plates shall be supplied by owner / consultant.
 - b) Pockets on walls, floors for erection of racks, etc. shall be provided where such racks, risers are crossing floors and walls. In prepared trench wall, pockets shall be provided for grouting rag bolts. But if needed the contractor shall arrange to make suitable pockets or modify pockets already provided for grouting the cable supports and/ or erection of riser, racks etc. at no extra costs.
 - c) Wherever insert plates are not provided, but required for support of cable rack, the contractor shall weld such plates to the reinforcement MS rods.

	TALCHER FERTILIZERS LIMITED TECHNICAL SPECIFICATION – ELECTRICAL ERECTION, TESTING & COMMISSIONING	PC183-TS-0843	0	
		Document No.	Rev	
		Sheet 26 of 47		

This shall be done by chipping the concrete for exposing the reinforcement MS rods and thereafter welding the plates and making good the concrete chipping by plastering.

- 5.14.4 The pipes will have to be bent (wherever required) and fixed / embedded in floor, wall and ground for laying the cables. Neoprene bushes shall have to be fixed at the end of such pipes.
- 5.14.5 GI / Al trays of different sizes shall be cut in size and fixed on racks and risers. Supports for the main cable racks shall be provided by the owner. However, supports for small branch cable racks & risers may have to be fabricated by the contractor. Fixing of trays shall only be done after erection / welding / painting of the supports as required.
- 5.14.6 Erection of support frames for miscellaneous equipments, base channels for transformers and switchboards etc. shall be carried out at no extra cost.
- 5.14.7 Dismantling of steel fabrication and re-erecting as required by consultant/ owner/ engineer-in-charge shall have to be carried out.
- 5.14.8 Dismantling of cable racks and re-erecting shall have to be carried out.

6.0 GENERAL PROCEDURE FOR TESTING & COMMISSIONING

- 6.1 Before proceeding with the work, contractor shall fully inspect all installed Electrical Equipment for completeness, signs of damages, defects etc. and shall get all discrepancies duly recorded by Owner / Consultant, failing which no claims by the contractor shall be entertained at a later date and shall be required to make good / repair / replace the damaged components at no extra cost.

6.2 Cleaning and Regular Maintenance

Till the commissioned equipment is finally accepted by Owner / Consultant / Engineer-in-Charge, Contractor shall be responsible for regular cleaning and maintenance of all electrical equipment. The maintenance job is to be done in consultation with or on advice from the Owner / Consultant.

6.3 Testing & Commissioning Requirements

- 6.3.1 All works shall be carried out in accordance with the drawings, suppliers' instructions / manuals for equipment and as per relevant standards and codes of practices.
- 6.3.2 Before conducting test on any equipment, the contractor shall obtain permission from Owner / Consultant / engineer-in-charge and all tests shall be conducted in their presence.
- 6.3.3 Records / results of each test shall be recorded by the contractor immediately after the test on approved Performa and counter signed by both the contractor and the owner's authorised representative.
- 6.3.4 Copies of the record shall be handed over to Owner / Consultant / engineer-in-charge.
- 6.3.5 The contractor shall commission all electrical equipment and carry out all pre-commissioning / commissioning tests inclusive of no-load and on-load tests on motors / generators and shall be responsible for final adjustments of relays,

motors, instruments, starters, breakers etc. as per operational data supplied and as per directions of Engineer-in-Charge.

6.3.6 Painting

The contractor shall without any extra cost, touch up with paint all electrical equipment which are damaged/ scratched during testing and commissioning work. The paint used shall match exactly painted surface of the equipment on which touch up is done.

6.3.7 All terminations, cable joints, which are opened for testing purposes shall be re-terminated and re-insulated to restore their original state.

7.0 TESTING & COMMISSIONING SPECIFICATIONS

7.1 These specifications lay down the testing and commissioning procedures to be followed for each type of equipment, over and above the general requirements laid down in specifications for erection.

Manufacturer's instructions and any other instructions of consultant / owner / Statutory bodies shall also be followed by the contractor during testing and commissioning.

The contractor shall maintain and furnish the records of all equipments i.e. HT/LT panels, motors, transformers, CT, PT, relays etc. including any special test as per manufacturer's manual.

7.2 Transformers



7.2.1 The final testing shall be done in cold condition after drying out (Disconnect H.V. and L.V. side cables by removing links in disconnecting chamber, bus ducts or cables and also earth connections to neutral).

7.2.2 The insulation between windings and between winding and earth shall be measured with a motorized 2500/1100V megger. Compare the test result with the manufacturer's Test Certificates (for 11 KV windings, polarisation index to be noted). Auxiliary power cables and control wiring shall be tested with 500V megger and values shall be preferably more than 2 MΩ.

Polarization Index shall be recorded as below to determine whether drying is necessary or not:-

$$PI = \frac{IR\ 10\ Min}{IR\ 1\ Min}$$

Evaluation of insulation condition based	Base on PI	Drying on PI
-----	-----	-----
Hazardous	< 1	Mandatory
Bad	1-1.5	Mandatory
Doubtful	1.5 - 2	Recommended
Adequate	2 - 3	No
Good	3 - 4	No

	TALCHER FERTILIZERS LIMITED TECHNICAL SPECIFICATION – ELECTRICAL ERECTION, TESTING & COMMISSIONING	PC183-TS-0843	0	
		Document No.	Rev	
		Sheet 28 of 47		

Excellent > 4 No

7.2.3 Oil Tests

Crackle test: Cleaned Iron piece shall be heated red hot and put in the oil taken in a pot. In case of crackle sound, presence of moisture is indicated.

Dielectric strength test: It shall be carried out as prescribed in Appendix 'C' of IS: 335. The oil should withstand minimum of 40 KV for 1 minute.

Even if the oil condition after final topping up is found to be satisfactory, it is advisable that as an additional precaution, the transformers shall be dried out as per following procedures.

7.2.4 Drying out

Drying out of the transformers shall be carried out in accordance with IS: 10028 and other relevant standards / manufacturer's recommendation or as advised by consultant / owner.

a) Before drying out, check for the following:

- Any oil leakage through bushings and radiators.
- Transformer tank is connected to earth.
- Temperature indicators are suitably calibrated.
- Capillary tube connections made to respective temperature indicators.
- MOG, if provided, is working properly.

b) Precautions when drying

- i) Use only Alcoholic type thermometers for temperature measurement. Mercury Thermometers shall only be used where pockets are provided for this purpose.
- ii) Maximum sustained temperature shall not be more than 80°C. Do not leave the transformer unattended during drying out period. Watch the transformer during drying out process and record carefully all observations viz. oil temperature winding temperature and insulation resistance of H.V. and L.V. windings.
- iii) Drying out to be continued till the insulation resistance value is steady prescribed in standard code of practice and IS: 10028 Part-II and that the steady value remains constant for 12 hours. Within the above period, several samples of oil are to be tested to ascertain dielectric strength. Record all readings (hourly / half hourly as advised by consultant / owner) of insulation resistance and temperature of oil & winding. Collect samples of oil from transformers from bottom only after the oil has been allowed to settle for at least 24 hours (collection of oil will be done in accordance with code of practice).
- iv) It may be desirable that transformer oil shall be filtered by using filtration machine and Breakdown Voltage shall be measured before and after the filtration. The minimum Breakdown Voltage shall be 45KV for one minute.

	TALCHER FERTILIZERS LIMITED TECHNICAL SPECIFICATION – ELECTRICAL ERECTION, TESTING & COMMISSIONING	PC183-TS-0843	0	
		Document No.	Rev	
		Sheet 29 of 47		

- v) In case the insulation resistance does not improve by the above method, it may be desirable to run the transformer for few hours on short circuit applying low voltage, approximately equal to impedance voltage, to the HV side after short-circuiting the LV side. During this process take regular readings of insulation resistance of the winding to earth, winding to winding and temperature against time and record.
- vi) If found necessary/ depending upon the manufacturer's recommendations, a vacuum pressure of 635 mm of mercury shall be applied for the removal of air bubbles.
- vii) After drying out process, release hot air by opening vent cocks / screws. Close vent cocks and screws after release of air.

7.2.5 Ratio Test

Apply 3 phase 415 V supply on H.V. side for every tap position. Measure the voltage at L.V. side at all tap positions. Switch off supply before changing tap in case of off-load tap changer for every tap changing.

7.2.6 Polarity Test

Apply 3 phase 415 V supply to H.V. side. Join one terminal of H.V. side to corresponding terminal of L.V. side, say A-a, Measure voltage across A-a, A-b, A-c, B-a, B-b, B-c, C-a, C-b, C-c, N-a, N-b, N-c. Ascertain vector group from above test.

7.2.7 Magnetizing Current

Apply 3 phase 415 V supply to H.V. side and simultaneously measure the current readings of the three phases using low range A.C. ammeters of the same accuracy class.

7.2.8 Phasing of Transformers (for paralleling)

Connect two transformers in parallel on primary side. Connect secondary terminal 'a' to the bus bar which corresponds to the equivalent terminal of second transformer. Ensure that both transformers are at same tap. Then apply 415V 3-phase supply on the primary side. Close circuit breaker of second transformer. Measure voltage between corresponding secondary terminals of two transformers a1-a2, b1-b2, c1-c2. This voltage shall be zero in case both the transformers are of same polarity and phase displacement.

Use voltmeter having range double the reading of secondary voltage under test conditions.



In case of star connected secondary windings having star point earthed, secondary terminals need not be connected as stated earlier.

7.2.9 Buchholz relay testing

Insert air pressure through petcock gently till alarm contacts make. Pressurise further till trip contacts make. Check whether trip contacts make in case of low oil level.

7.2.10 Temperature indicators

Calibrate temperature indicator and test whether alarm contacts make properly.

	TALCHER FERTILIZERS LIMITED TECHNICAL SPECIFICATION – ELECTRICAL ERECTION, TESTING & COMMISSIONING	PC183-TS-0843	0	
		Document No.	Rev	
		Sheet 30 of 47		

7.2.11 Checks before commissioning

Before commissioning transformers, the following points shall be checked and ensured for safe energising of the transformer.

- a) General Inspection
 - i) Check assembly with reference to accessories and mountings according to relevant drawing.
 - ii) Check tightness of all cover bolts, flange connections etc.
 - iii) Check oil leakage through bushings, valves etc.
 - iv) Check shut off/open marking of radiator valves.
- b) Oil Level
 - i) Check for correct level in conservators.
 - ii) Check for oil level in disconnecting chamber & pockets for thermometers.
- c) Buchholz relay
 - i) Check that floats are at normal position and unlocked.
 - ii) Check shut off valve between relay and conservator is open.
- d) Breather
 - i) Check that protective cover on air passage removed.
 - ii) Check oil level in seal chamber and condition of silica gel.
- e) Explosion vent
 - i) Check diaphragm is intact and no oil visible in gauge glass.
 - ii) Check equaliser pipe valve between vent and conservator open.
- f) Radiator
 - i) Check that all valves between banks and main tank open.
- g) Thermometer
 - i) Check CT and Heater element connection for winding temperature indicator.
- h) Wiring
 - i) Check wiring from instruments to Marshalling Kiosk & to switchboard / control panel.
 - ii) Check wiring of driving mechanism and control gears for tap-changer.
 - iii) Check wiring of cooling fans & pump circuits.
- i) HV and LV bushing & Connections
 - i) Clean bushing and check connections with incoming / outgoing lines etc.
 - ii) Check oil level in bushings (in case oil filled & HV bushings) and release air.

	TALCHER FERTILIZERS LIMITED TECHNICAL SPECIFICATION – ELECTRICAL ERECTION, TESTING & COMMISSIONING	PC183-TS-0843	0	
		Document No.	Rev	
		Sheet 31 of 47		

iii) Check & adjust gap of arcing horn (HV bushings).

- j) Check & release air through screwed petcocks, cocks etc. from Main tank, Radiator banks, Buchholz relays etc.
- k) Check & release air through screwed petcocks, cocks etc. from Main tank, Radiator banks, Buchholz relays etc.
- l) After all checking is found O.K., the breaker for incoming of transformer shall be made ON for charging the transformer. It shall be watched for at 24 hours without load. Then it can be loaded after finding every thing O.K.

7.3 **Switch Boards**

7.3.1 General Checks

- a) Check all auxiliary contacts of breakers for proper make-break operation.
- b) If necessary, make minor adjustments to circuit breakers mechanism, auxiliary contacts etc. for proper operation of circuit breakers. Proper greasing and lubrication or mechanism must also be done before final commissioning.
- c) Check for termination of control circuit wiring as per drawing and ensure that the terminals at equivalent and panel are mechanically sound.
- d) Ensure proper operation of all test operation switches and push button.
- e) Check wiring of all space heaters, indication lamps bells, buzzers etc.

7.3.2 Insulation resistance test

- a) Measure the insulation resistance of main bus-bars (Phase to phase & Phase to earth) with 5000 V, 2500 V and 1000 V Megger (IR values shall generally be not less than 100 M Ω , 50 M Ω and 10 M Ω respectively in case of 11 KV, 6.6 / 3.3 KV & 415 V).
- b) Insulation resistance of circuit breaker shall be measured with 1000 V Megger.
- c) Control wiring shall be tested with 500 V Megger (IR values shall not be less than 2 M Ω).



7.3.3 High voltage Test

The test shall be conducted on switchgear rated 3.3 KV and above. Test voltage shall be as per relevant Indian Standard. However, for AC High voltage test, the value shall be twice the working voltage of the switchgear plus 1000 V. This voltage shall be maintained for one minute. Each phase shall be tested in turn, with remaining phases earthed. After high voltage test, a further Megger test shall be made to make sure that insulation resistance to earth has not altered appreciably. The reading of second megger test shall be consistent with that of the first.

AC test voltage for 1 minute duration shall be as follows:

24 KV for 11 KV panel, 15 KV for 6.6 KV panel and 8 KV for 3.3 KV panel

7.3.4 Testing of current transformer

	TALCHER FERTILIZERS LIMITED TECHNICAL SPECIFICATION – ELECTRICAL ERECTION, TESTING & COMMISSIONING	PC183-TS-0843	0	
		Document No.	Rev	
		Sheet 32 of 47		

- a) Insulation resistance to earth of secondary winding shall be tested with 500V megger (remove earth connection before test).
- b) Check the polarity of C.T. – Connect zero centre voltmeter in the secondary winding, connect 6 V batteries with switch in the primary. Close the switch and from the kick of the voltmeter, ascertain the polarity.
- c) Ratio test shall be carried out by injecting current in the primary and subsequently secondary side current shall be checked.

7.3.5 Testing of P.T. Insulation.

Testing of HT & LT side of PT shall be done with 1000 V & 500 V megger respectively (the value shall not be less than 100 M Ω , 50 M Ω & 10 Ω , respectively for the voltage rating 11KV, 6.6KV & 400V).

7.3.6 Testing of Relays

- a) Checking of wiring shall be done according to Manufacturer's drawings. Check relay continuity at all taps also ensure plug bridge contact satisfactory.
- b) Secondary injection test.
Use secondary injection test set incorporating timer. Testing of all protective relays such as but not limited to over current, earth fault differential, motor protection, directional feeder protection, under voltage relays etc. shall be done as per the procedure set by the manufacturers of the relays. All time delay relays shall be tested to verify their characteristics for IDMT and instantaneous relay pick up and drop off values shall be noted at various taps. Relays shall be tested at all taps. Errors shall be calculated and compared with permissible limits specified by manufacturers. Adjustment, such as in establishing circuit, shall be done as recommended by manufacturer. After testing, relays shall be set at values given by Consultant.
- c) Timer relay shall be tested and calibrated and set properly.
- d) All auxiliary relays shall be tested for proper operation.

7.3.7 Testing of Instruments

All indicating and recording instruments like Ammeter, Voltage meter, KWh meter etc. shall be calibrated. Zero error of each instrument shall be corrected.

7.3.8 Operational Tests

Conduct the following operational tests after putting the circuit breaker at test and service position. Check that the fuses of proper rating are put in control circuit as per wiring diagram.

- a) Close and trip the circuit breaker several times with power or manually. In case of motor operated spring charged closing mechanism, check the operation of charging motor. Ensure that it cuts in / off properly.
- b) Check the indication scheme: 'ON', 'OFF', trip circuit healthy, auto-trip indication etc.

	TALCHER FERTILIZERS LIMITED TECHNICAL SPECIFICATION – ELECTRICAL ERECTION, TESTING & COMMISSIONING	PC183-TS-0843	0	
		Document No.	Rev	
		Sheet 33 of 47		

- c) Trip the breaker by operating the protective relays (operate contact manually).
- d) Check the trip free feature.
- e) Check the anti-pumping feature.
- f) Check operation of voltage selector relay scheme for supply.
- g) Check annunciation scheme for AC/DC power supply failure.

7.4 **Motor Control Centres / Power & Motor Control Centres**

In addition to checks and tests (wherever applicable) detailed under Clause No. 7.3 above, the following shall also be carried out:

- 7.4.1 Insulation resistance test of the main bus bars, starter units control wiring etc. shall be done with 500 V megger.
- 7.4.2 Each motor starter shall be tested for correct operation. All operational tests to verify sequence of operation, inter-locking and alarm indication schemes (by simulating the connection) shall be done.
- 7.4.3 Bi-metallic type thermal over load relay shall be tested at different settings. Current shall be injected through the thermal elements (three elements can be connected in series) at twice and thrice the set value and tripping time shall be noted. The values shall be compared with the data supplied by manufacturer.
- 7.4.4 Single-phase prevention relays shall be tested for proper operation.
- 7.4.5 Check that fuses of specified ratings are put in various outlets.

7.5 **Soft Starter Panel**

In addition to the procedure laid above in Clause Nos. 7.3 & 7.4, any other instruction given by the manufacturer shall also be followed.



7.6 **Panelled Equipments**

These include relay and alarm panels, Rectifier panels, Battery charger panels DC / AC distribution boards, conveyors / control cum power supply panels, UPS, inverter static power supply, Variable Frequency Drive and PLC. Details shall be indicated in project specific Schedule of Rates.

- 7.6.1 Test insulation resistance with 500 V megger.
- 7.6.2 All operational tests to verify function of each component like relays, switches etc. and sequence of operation, interlock, alarm system as per circuit diagram.
- 7.6.3 Invertors / Thyristor controlled panels, static power supply system units, Variable Frequency Drive and PLC panels shall be tested as per the instructions of manufacturer.

7.7 **Cables**

- 7.7.1 All HT (11KV, 6.6KV & 3.3KV) cables shall be tested for insulation resistance with 5KV / 2.5KV motorized meggers and LT cables shall be tested for insulation resistance with 1000 V megger before and after termination. IR shall be measured between phases and between phase and earth. The voltage shall be applied for 1 minute.

	TALCHER FERTILIZERS LIMITED TECHNICAL SPECIFICATION – ELECTRICAL ERECTION, TESTING & COMMISSIONING	PC183-TS-0843	0	
		Document No.	Rev	
		Sheet 34 of 47		

7.7.2 All the 3.3KV, 6.6 KV and 11 KV cable joints shall be tested on high voltage as per IS: 1255 after making all termination and joints followed by IR test.

7.8 Lighting

7.8.1 Before energising any lighting circuit, the IR values (phase/ phase and phase/ earth) shall be recorded for entire wiring installation. The testing shall be done with 500 V megger. After switching on the power supply, load of each circuit shall be measured.

7.8.2 Illumination levels shall be tested and same shall not be less than the levels mentioned below for specific areas, unless otherwise specified elsewhere:

- | | | | |
|----|------------------------------------|---|---------|
| a) | Control room, Laboratory | : | 500 Lux |
| b) | Office area / operators / UPS room | : | 300 Lux |
| c) | Switchgear room | : | 200 Lux |
| d) | Cable cellar | : | 70 Lux |
| e) | General process area | : | 60 Lux |
| f) | Cooling tower | : | 60 Lux |
| g) | Battery room | : | 150 Lux |
| h) | Compressor area | : | 150 Lux |
| i) | Pump house, sheds | : | 100 Lux |
| j) | Loading areas and staircases | : | 60 Lux |
| k) | Roads and tank farm | : | 10 Lux |

7.9 Earthing

The continuity of earthing and resistance of each earth pit and grid shall be measured with earth megger. The resistance of grid connecting all earth pits shall be less than one ohm.

7.10 Miscellaneous Equipment

Under this are included, exhaust fans, blowers, limit switches, vibrators, electro-magnets, air pressurisation unit etc. The following tests shall be conducted:

7.10.1 Measurement of insulation resistance

7.10.2 Check up the direction of rotation.

7.10.3 Operational test

7.11 Motors / Generators

7.11.1 General Checks

- a) Check the alignment of motor/generator with the driven equipment/prime mover.
- b) Check and calibrate motors/generators, safety switches, bearings/ air temperature indicators, winding temperature indicators, water flow/ air flow pressure meters, lubricating oil pump motors.
- c) Check operation of space heaters.

	TALCHER FERTILIZERS LIMITED TECHNICAL SPECIFICATION – ELECTRICAL ERECTION, TESTING & COMMISSIONING	PC183-TS-0843	0	
		Document No.	Rev	
		Sheet 35 of 47		

d) For motor/generator standing idle for a long time, carry out overhauling, re greasing and drying.

- 7.11.2 Check the condition of grease in bearings and if required replace completely with fresh grease after proper cleaning of bearings. This work shall preferably be taken up before final alignment of motor with driven equipment.
- 7.11.3 In case of oil lubricated bearings, the bearing housing shall be flushed with oil and then filled up to the specified level. Check that oil ring rotates freely along with motor. In case of pedestal type journal bearing, it may be necessary to open the top cover, and check the bearings.
- 7.11.4 Fix up all accessories like techno-generators, water pressure relay, temperature detectors and any other safety switches after calibration.
- 7.11.5 Check that the shaft rotates freely. This shall be done after decoupling the motor from driven equipment.
- 7.11.6 Check air gap between rotor and stator (wherever possible) at three places at 120° apart on both sides of drive and verify with the figures furnished by the manufacturers. The variation shall not exceed 10% of average value.
- 7.11.7 Check the tightness of foundation bolts. Ensure pins are fitted before commissioning of motor.
- 7.11.8 Check that power and control cables are properly connected and tightened. All earth connections of the machine shall be checked.
- 7.11.9 In case of forced ventilated motor, clean the ventilation duct. Ensure that recommended flow and pressure of air is available to produce the required cooling effect. If the motor is provided with air to water heat exchanger, check for the adequate flow of water. If necessary, clean the exchanger to remove any obstruction to water flow. Check that there is no leakage from water cooler, pipe connections.
- 7.11.10 Check the space heater circuit. Space heaters shall be provided on all HT and special type LT motors. Switch on spare heater supply at least one week before the commissioning of motor. Wherever drain plugs are provided in motor body, open and check for water accumulation inside motor.
- 7.11.11 Testing

a) Insulation Resistance Test

The insulation resistance of LT motors shall be measured between the winding of the machine and its frame by means of 500 / 1000V megger. A minimum value of 1 MΩ for 400 V motors shall be considered a safe value.

3.3KV, 6.6KV and 11KV motors / generators shall be tested for insulation by 1000 5000 V megger and its value shall not be less than 1 MΩ for each KV. However, it is desirable that before commissioning the motors, the insulation resistance shall be improved substantially above the lower limits. The contractor shall carry out heating of winding as per the advice of the consultant/Owner. The following methods may be adopted.

b) Drying

i) Blowing hot air

	TALCHER FERTILIZERS LIMITED TECHNICAL SPECIFICATION – ELECTRICAL ERECTION, TESTING & COMMISSIONING	PC183-TS-0843	0	
		Document No.	Rev	
		Sheet 36 of 47		

- ii) Placing heater or lamps around and inside, in case of small motors after making suitable guarding and covering arrangement so as to conserve that heat.
- iii) Heating by injecting low voltage in the winding low voltage output of welding set shall be used. The winding shall be inter-connected so that current flows through each phase, and particular care shall be exercised to prevent local over heating. The voltage applied shall be suitably adjusted. The maximum temperature of winding, while drying, shall be 70° to 80°C by thermometer or 90o to 95°C by resistance method. Heating shall be done slowly first till steady temperature of winding is reached (may be within 4 to 8 hours depending upon size of motor) once the steady temperature is reached, maintain it for some time.
- iv) Check the insulation resistance which will drop first and then become steady. Hourly reading of IR shall be taken and temperature shall be recorded 1/2 hourly. If IR is reasonably steady, supply can be switched off. Measure IR under cold condition. Never keep the motor unattended during drying process.
- v) For checking polarisation index of HT motor, use electric driven megger. Note IR value after 1 minute and 10 minutes. The ratio shall be compared with data supplied by manufacturer (but shall be not less than 2.5).

7.11.12 Operational Test



- a) Check control gear and set the protective relays as per settings supplied by Consultant. It is preferable that before first no-load run, the settings may be kept lower than 100%. However, during load running, settings shall be restored to Normal. Simulation test shall be conducted on motor starter, circuit breaker (main fuses removed on CB at test position). All interlock shall be incorporated in the control system. Testing shall be done from local and remove control station and shall be ensured that the control system works satisfactorily. In case of any defect in the integrated control wiring the contractor shall locate and rectify such defects.
- b) Any other tests recommended by the manufacturer for special type equipment like variable speed motors etc. shall be done.

7.11.13 No-load Test

Finally the motor shall be started on no load after decoupling. Check the direction of rotation and change if required. The motor shall be run for 8 to 10 hours. Voltage, starting current, and starting time shall be noted. Hourly reading of current, winding and bearing temperature, (for small motors body temperature to be measured by thermometer) shall be noted. Note vibration, excessive noise if any.

In case of variable speed motor, variation of speed shall be checked and regulation of speed noted.

7.11.14 After switching off the motor, the insulation resistance shall be measured under hot and cold condition.

	TALCHER FERTILIZERS LIMITED TECHNICAL SPECIFICATION – ELECTRICAL ERECTION, TESTING & COMMISSIONING	PC183-TS-0843	0	
		Document No.	Rev	
		Sheet 37 of 47		

7.11.15 If the no-load trial run is found satisfactory, the motor shall be run on load after adjusting the protective relay setting to 100% value. Note the starting time, load current, winding temperature etc. The temperature rise shall not be more than the specified value. Check for any excessive vibration or noise.

7.11.16 Generator shall be tested in the presence of manufacturer's representative only as per their instructions.

8.0 DOCUMENTATION

8.1 For the purpose of completion certificate, the following documents will be deemed to form completion document:

- i) The technical documents according to which the work was carried out.
- ii) Final check-list and completion report.

8.2 Three sets of construction drawings showing therein the modifications and correction made during the course of execution signed by Owner/ Consultant/ Engineer-in-charge.

8.3 Test certificates for the materials purchased by Contractor.

8.4 Material appropriation statement for the materials issued by Owner for the works and list of surplus materials returned to Owner's stores duly supported by necessary documents.

8.5 No claim certificate by the Contractor certifying that the entire work done by him under the contract has been measured and accepted for the final bill to his satisfaction and that he will have no claim(s) concerning any work(s) or part thereof performed by him under the Contract, to Owner except otherwise indicated in the final bill.

8.6 The completion certification shall be issued by Owner within 30 days of the Contractor furnishing documents listed in this clause jointly certified by Owner/ Consultant and Contractor's Site Engineer.

9.0 HANDING OVER TO OWNER



9.1 The contractor shall hand over the complete installation as a whole. Minor details not specified or mentioned in the scope or schedule of rates but required to complete the job as a whole will have to be done by the contractor without extra cost. Any equipment/ installation shall not be deemed as handed over to Owner until the same is complete in all respect and is accepted in writing by the Owner/Consultant.

9.2 The final acceptance of the work shall be after the demonstration of guarantees by the Contractor and Owner shall issue the final acceptance/ taking over certificate upon fulfilment of the guarantees.



10.0 OBLIGATIONS & RESPONSIBILITIES OF CONTRACTOR

The contractor's obligations and responsibilities shall include but not limited to the following:

10.1 To deploy skilled, semi skilled and unskilled personnel in requisite numbers and as per scheduled programme so as to complete the WORK as per overall project schedule.

	TALCHER FERTILIZERS LIMITED TECHNICAL SPECIFICATION – ELECTRICAL ERECTION, TESTING & COMMISSIONING	PC183-TS-0843	0	
		Document No.	Rev	
		Sheet 38 of 47		

- 10.2 To deploy suitably qualified supervisors and engineers in requisite numbers to assure execution of good quality job as per best engineering practices and to the full satisfaction of Owner / Consultants / Engineer-in-charge.
- 10.3 To prepare detailed planning and execution schedule considering the availability of fronts and materials. This shall be reviewed by Owner & consultant and Contractor shall be required to keep updating the same (as per the instructions of Owner / Consultant / Engineer-in-charge) to take care of any changes in the availability of fronts and materials and to complete all jobs as per the overall project schedule. Owner / Consultant / Engineer-in-charge shall in no way be held responsible for such changes because such changes are deemed quite a common feature in any project of this size.
- 10.4 To check for quantity compliance between bill of materials and drawings for cable, structural, earthing materials etc. and intimate Owner / Consultant / Engineer-in-charge sufficiently in advance regarding discrepancies, if any.
- 10.5 Construction power shall be made available at one point. Arrangement for distributing the same to various areas for construction shall be the contractor's responsibility.
- 10.6 To arrange and supply all tools and tackles, consumables, instruments, erection materials & machineries etc. for handling erection, testing & commissioning of complete electrical installation. List of major tools and tackles required are as listed below:
- i. Cranes, winches, chain pulley blocks etc. in required quantity and of suitable capacity.
 - ii. Trailers with prime mover/Tractor trailers.
 - iii. D-Shackles, slings, wire ropes etc.
 - iv. Transformer welding sets
 - v. Water level, spirit level etc. for levelling and alignment.
 - vi. Gas cutting sets
 - vii. Drilling/Grinding machines
 - viii. Jacks with spindles (for cable drums)
 - ix. Pipe bending machine
 - x. Hydraulic crimping tools set
 - xi. Hand crimping tools set
 - xii. Air blower/vacuum cleaner
 - xiii. Streamline transformer oil filtration machine with temperature and pressure gauges.
 - xiv. Transformer oil dielectric strength testing machine, portable type.
 - xv. High voltage testing set.
 - xvi. Secondary injection testing set
 - xvii. 5 KV motorised Megger Insulation tester

	TALCHER FERTILIZERS LIMITED TECHNICAL SPECIFICATION – ELECTRICAL ERECTION, TESTING & COMMISSIONING	PC183-TS-0843	0	
		Document No.	Rev	
		Sheet 39 of 47		

- xviii. 500 V to 2.5 KV each rating hand operated 'Megger' Insulation tester
 - xix. Earth resistance tester with leads and spikes
 - xx. Clip on ammeters/tong testers
 - xxi. Tachometers/ Tacho-generators (for RPM checking)
 - xxii. Phase sequence meter
 - xxiii. Primary injection set up to 2000 amps., if required
 - xxiv. Grease gun for greasing of motors
 - xxv. Wooden sleepers of proper size and in adequate numbers.
 - xxvi. Scaffolding materials as required.
 - xxvii. Any other tools and tackles and facilities required completing all the jobs as per ITB to the best engineering practices.
 - xxviii. Drilling M/C for drilling hole in RCC Roof/ Column for grouting expansion bolts.
 - xxix. DG set for construction power
- 10.7 To arrange and supply all consumables (required for executing the under question) such as but not limited to the following in sufficient quantity, of required quality and in time to meet the schedules:
- Electrodes, filler wires, industrial gases, such as oxygen, acetylene, diesel, petrol, kerosene, CTC, standard grease/ lubricant for motor bearings, insulating tapes, compounds, solders, fluxes, rawl plugs, phil plugs, saddles & bars, ferrules, bricks, sand, cement, stone chips, clamps, tags, shims, hard wares, paints, thinners (as required), salt and charcoal (for each electrode pits), copper lugs for GI earth wires, cotton waste, marking cloth, sand papers, emery papers, thread, nylon ropes.
- 10.8 To arrange and supply storage tanks for drinking water so as to avoid any inconvenience that may be caused due to interruption in water supply at times.
- 10.9 To provide proper storage and security arrangements for Contractor's tools, tackles, equipments, materials etc. as well as equipment and materials issued by Owner/ Consultant to Contractor. Owner/ Consultant shall not be responsible for any loss or damage to items in the custody of Contractor at site for any reason whatsoever.
- 10.10 Completion of all repairs arising out of defective work done by Contractor Owner/ Consultant / Engineer-in-charge may at his discretion require the Contractor to rectify certain defects in materials caused due to bad workmanship of supplier and/or during transportation. For such work of course, the payment modalities shall be settled by mutual agreement before starting such rectification jobs.
- 10.11 To maintain all the records for men, materials and execution of job as required by law as well as Owner / Consultant / Engineer-in-charge.
- 10.12 To get his work inspected by Owner / Engineer-in-charge and approved from statutory agencies such as but not limited to Electrical Inspector, Factory Inspector etc.

	TALCHER FERTILIZERS LIMITED TECHNICAL SPECIFICATION – ELECTRICAL ERECTION, TESTING & COMMISSIONING	PC183-TS-0843	0	
		Document No.	Rev	
		Sheet 40 of 47		

All co-ordination with Statutory Authorities shall be contractor's responsibility. Only statutory fee required for approval shall be paid by the owner.

- 10.13 To make arrangements for services such as transport, medical, lighting, canteen etc. for working round the clock.
- 10.14 In addition to safety regulations indicated in this enquiry Owner / Consultant / Engineer-in-charge may issue certain safety directives, which shall have to be followed meticulously without any reservation.
- 10.15 To undertake and execute work and supply as per scope of work, scope of supply, to follow Technical Conditions including specification for electrical erection, specification for electrical testing and commissioning and as per schedule of rates. In honour all other obligations listed in other sections and sub-sections of this enquiry.
- 10.16 Reconciliation of materials issued to Contractor as directed by Owner / Consultant / Engineer-in-charge.
- 10.17 Handing over of the completed works to Owner / Consultant / Engineer-in-charge as per procedure laid down by Consultant.
- 10.18 To submit documentation forming part of request for issue of completion certificate.
- 10.19 Clearing the site after cleaning the areas where the Contractor executed the job, stored the materials and built his office, fabrication shop etc.

11.0 TERMS AND CONDITIONS

11.1 All the work shall be carried out in accordance with drawings supplied to the contractor and the entire installation shall conform to the Indian Electricity Rules/ Regulations/ Acts and with latest issue of relevant IS, Specifications, drawings & documents supplied by Consultant/ Supplier/ Owner and as per the directions of Owner / Consultant / Engineer-in-charge.



11.2 Contractor's Staff

The contractor shall employ all skilled, semi-skilled, non-skilled labourers necessary for erection, installation testing and commissioning. All electricians, cable jointer, wire man and others employed by the contractor shall be suitably qualified and must possess valid certificates / licences recognised by the competent authorities.

Engineer-in-charge at his own discretion may put any electrician / wireman / wire cable jointer to test for ascertaining the competence of the technician concerned and the contractor shall have to replace any staff found incompetent to execute the jobs as per requirements, in the opinion of the Owner / Consultant / Engineer-in-charge. The contractor shall also furnish a list of such staff and indicating whether he holds such competence certificate to supervise electrical installation jobs as required under Indian Electricity Rules and Regulations, and State Inspectorate Rules.

11.3 Contractor's Workshop

The Contractor shall set up his own workshop having facilities to undertake all jobs connected with, Erection, Testing and Commissioning. He shall provide all facilities at site to undertake steel fabrication work e.g. fabrication of cable racks/

	TALCHER FERTILIZERS LIMITED TECHNICAL SPECIFICATION – ELECTRICAL ERECTION, TESTING & COMMISSIONING	PC183-TS-0843	0	
		Document No.	Rev	
		Sheet 41 of 47		

trays, cable supports/brackets/ frameworks/ base frames for electrical equipment etc.

The contractor will be required to provide workshop and other facilities to undertake minor fabrication work, including conduit bending and threading, fixing rawl plugs, welding supports, making brackets, small foundation bolts, protective guards, and such other miscellaneous items as may be necessary for completing the erection, testing and commissioning jobs. The contractor shall also, on his own, set up adequate office, stores, godowns etc. for his work in the area / space provided by the Owner / Consultant / Engineer-in-charge.

11.4 **Tools and Tackles**

The contractor shall have to arrange all tools, tackles including various erection machineries and instruments for measuring, testing, calibrating etc. required for erection as well as for Testing and commissioning on his own, such as compressors, cranes, winches, jacks, chain pulley blocks, welding sets, oxygen, acetylene gas cutting set, drilling machines, grinders, pipe bending machines, dies for pipe threading, scaffolding materials, cable jointing/ crimping tools, megger, ductor, filtering machines, earth tester, secondary injection sets, sub-standard meters for calibration of ammeters, voltmeter, oil testing-sets, Multi meters, phase sequence meters, HT test set, primary injection (if required), clip on ammeters (tong testers), techo-generators etc.



11.5 **Materials**

11.5.1 All materials shall be in contractor's scope of supply, unless indicated to be supplied by Owner. The contractor shall have to arrange at his own expenses all consumables required by him for erection as well as for testing and commissioning like Kerosene oil, petrol, CTC, grease, petroleum jelly, rawl plug, phil plug, screws/nails, wires for portable tools, lights, plugs, cotton waste, jute dusters, shims for alignment / levelling, cement, sand, stone chips, bricks, reinforcement rods, welding electrodes paint, insulating taps, compounds, solders fluxes, ferrules, nut bolts, washers, cable clamps, cable tags and such other materials contractor might need to execute the complete job. The contractor might need to execute the complete job. The contractor shall also provide foundation bolts, for all floor/ wall mounting equipment as per requirement at site. All hard wares supplied by the contractor shall be of GI. All GI materials shall have a minimum zinc coating of 800 g/m² at any point on the surface.

11.5.2 All equipment and materials including Instruments / meters required for measuring, checking, testing and commissioning are included in the scope of the contractor and shall be arranged and supplied by the contractor himself

11.6 **Inspection**

11.6.1 Electrical Installation work shall be subject to inspection by Owner's/ Consultant's engineers, statutory bodies like Electrical Inspector, Factory Inspector, and wherever applicable by equipment supplier's engineer. The contractor shall carry out without extra cost all damages/rectification/modification desired by the above engineers/ inspectors or to make the installation conform to relevant Electricity Rules etc.

	TALCHER FERTILIZERS LIMITED TECHNICAL SPECIFICATION – ELECTRICAL ERECTION, TESTING & COMMISSIONING	PC183-TS-0843	0	
		Document No.	Rev	
		Sheet 42 of 47		

11.6.2 Further the Owner/ Consultant may reject any portion of the work considered defective or of poor workmanship and contractor shall make good these defects without extra cost.

11.6.3 Owner/ Consultant reserves the right to get such repairs/replacements done from any other agencies in case the contractor fails to do the job within a period of 7 days after the request has been made to him in writing and the cost of such alteration/ repair/ testing shall be recovered from the contractor and will be adjusted against any bill due to the contractor.

11.7 **Completion of work**

Work shall be deemed to be incomplete until such certificates as required under statutory regulations are obtained and delivered to Owner / Consultant / Engineer-in-charge.

11.8 **Clearing of Site**

The contractor will be responsible for the final clearing of site after completion of erection works as well as after completion of jobs connected with testing and commissioning. He will return all excess materials such as cables, earthing materials etc. to the Stores under instructions from Owner / Consultant / Engineer-in-charge. All empty cable drums, packing materials, cut-pieces of cables, steel scraps, and other materials, supplied by Owner for the job shall be shifted to a suitable place by contractor as per instruction of Owner / Consultant / Engineer-in-charge. Contractor will also be responsible for demolition and clearance of temporary sheds and structures put up by him.

All clearance of unwanted materials shall regularly be done as per advice of the Owner / Consultant / Engineer-in-charge.

11.9 **Materials utilisation statement and permissible wastage**

After completion of the erection, the contractor shall submit to the Owner / Consultant a statement giving details of materials drawn from stores and quantity used in erection, balance quantity returned to stores and quantity of scraps for his checking & approval.



The scraps of steel shall not be more than 2% of total quantity used for erection. For cables, the quantity of scrap allowable is as follows:

- | | |
|---|------------------------------|
| a) 11 KV and 6.6 KV cables | : 1% of actual quantity laid |
| b) 1000 volts & below grade
power and control cables | : 2% of actual quantity laid |
| c) Lighting cables only | : 3% of actual quantity laid |

Any cable cut piece less than 5 mtrs. and structural steel less than 1 mtr. shall be considered as scrap.

11.10 **Civil Foundation**

Owner / Consultant will give necessary civil foundations ready complete with location of foundation bolts, sleeves etc. before the contractor is expected to commence his work. Minor rectifications and chipping etc. may, however, have to be carried out by the contractor, if found necessary while grouting the foundation bolts. Contractor shall check the foundations cleared by other agency; Owner /

	TALCHER FERTILIZERS LIMITED TECHNICAL SPECIFICATION – ELECTRICAL ERECTION, TESTING & COMMISSIONING	PC183-TS-0843	0	
		Document No.	Rev	
		Sheet 43 of 47		

Consultant shall not be responsible for any delay. But all concrete cutting and chipping work necessary for fixing and grouting of base channels for switchgear and control panels will have to be done by the contractor.

12.0 MEASUREMENT

12.1 For all payment purposes, the measurement will be based on physical measurement. Wherever it is not possible to take physical measurement, payment shall be made on the basis of drawing. The contractor in the presence of Owner/ Consultant/ Engineer-in-charge will take physical measurement.

12.2 Measurement of weight / length / area / volume will be in metric system corrected to nearest kilogram / centimetre / square centimetre / cubic centimetre.

12.3 For structural steel works measurement and payment will be made on weight basis.

12.4 Measurement for cable laying shall be made on the basis of length actually laid between end terminations including that of loops provided and paid accordingly.

13.0 PRIOR APPROVAL OF THE MATERIAL TO BE SUPPLIED BY CONTRACTOR

All items to be supplied by the contractor shall be of superior quality and shall be of approved make. These shall be as per specifications and conforming to relevant Standards.

14.0 RECOVERY AGAINST OWNER'S UN-RECONCILED MATERIALS

The contractor shall be responsible for material utilisation statement. Any equipments or materials not reconciled shall be charged back to the contractor.

15.0 STATUTORY APPROVALS

All co-ordination at site with statutory authorities (including inspection of completed WORKS from statutory authorities) shall be in the scope of CONTRACTOR. Only statutory fees deposited by CONTRACTOR for approval of installations and works shall be reimbursed to the CONTRACTOR on production of documentary evidence.

16.0 GUIDELINES FOR SAFETY MEASURES

Requirement of electrical power for any construction activity is of prime importance. The utilization of power in any construction site shall be done with utmost care to avoid accidents due to electrical shocks, fire due to electrical short circuits. Electrical installation increase the risk of such accidents, if it is exposed to adverse environmental conditions i.e. presence of hazardous gases. Hence, it is absolutely essential to take extra precaution for such installation to ensure safety of personnel and equipments.

This standard gives details of required safety measures to be adopted for the electrical installations by all contractors during construction activities. Following are some general guidelines & check points that should be followed:

16.1 All electrical connections for electrical installations shall be carried out as per provisions of the followings latest codes and standards in addition to the requirements of statutory authorities and IE rules:

OISD – STD – 173 : Fire prevention and protection system for electrical installations

	TALCHER FERTILIZERS LIMITED TECHNICAL SPECIFICATION – ELECTRICAL ERECTION, TESTING & COMMISSIONING	PC183-TS-0843	0	
		Document No.	Rev	
		Sheet 44 of 47		

IS – 30 : National electric code



- 16.2 All electrical connections shall be done by a competent electrician having valid license and to the satisfaction of Engineer-in-charge and one competent licensed electrician shall be made available by contractor at site round the clock to attend the normal / emergency jobs.
- 16.3 All necessary personal protective equipment (PPE), Safety equipment shall be made available to use for persons employed by the contractors on the site and shall be maintained in condition suitable for immediate use. Protective equipment for head protection, body protection, eye protection, hand protection, hearing protection & respiratory protection shall be made available by the contractor. No loose clothing shall be allowed.
- 16.4 When workers are employed on electrical installations, adequate safety items / charts viz. fire extinguishers, insulating mats, hand gloves, multilingual (English, Hindi & local languages) caution boards, shock treatment charts and instruction plate containing location of isolation point for incoming supply, name and telephone number of contact person in emergency shall be provided in substation and near all distribution boards / local panels. The workers shall not wear any rings, watches & carry keys or other materials, which are good conductors of electricity.
- 16.5 When work has to be done on elevated places, towers, roofs, pipe racks & other lofty positions where plat-forms & other fall guards are not there, use of SAFETY BELT is compulsory. Safety Nets will prove very helpful in case somebody slipped from height.
- 16.6 All welding machines and switchboards shall be kept in well-ventilated and covered shed. The shed shall be elevated to avoid water logging. Use of flammable material shall be prohibited for construction shed; also flammable material shall not be stored in and around electrical equipments. Adequate clearance and operational space shall be provided around the equipment.
- 16.7 No work, however, small should be undertaken / started without obtaining valid work permit from the concerned department. Confined space entry should be done only by valid entry permit from the Engineer-in-charge. Safety permit shall be obtained before taking the temporary electrical equipment inside the hazardous area.
- 16.8 No work must be carried out on any live equipment. Electrical equipment should be considered live unless it is ensured that they are isolated & made dead / safe. A 'permit-to-work' shall be issued before any work is carried out. Don't tamper with any type of electric switches / equipments or any other appliances or moving machinery installed in factory area without permission.
- 16.9 Before the contractor connects any electrical appliance to any plug / socket belonging to the other contractor / owner, he shall:
- i) Indicate to the Engineer-in-charge that the appliance is in good working condition.
 - ii) Inform the Engineer-in-charge of the maximum current rating, voltage and phase of appliance.

	TALCHER FERTILIZERS LIMITED TECHNICAL SPECIFICATION – ELECTRICAL ERECTION, TESTING & COMMISSIONING	PC183-TS-0843	0	
		Document No.	Rev	
		Sheet 45 of 47		

- iii) Obtain the permission of the owner dealing the sockets to which the appliance may be conducted.
- 16.10 The Engineer-in-charge shall not grant permission to plug-in until he is satisfied that:
- i) The appliance is in good working condition and is fitted with a suitable plug.
 - ii) The appliance is fitted with a suitable cable having earth conductors.
- 16.11 All temporary installation shall be tested before energizing to ensure proper earthing, bonding and suitability of protection system and adequacy of feeders / cables.
- 16.12 Voltage for all portable equipment viz. drilling machine, temporary lighting etc. will not exceed 240 volts.
- 16.13 Earth leakage device shall be checked for operation regularly by temporarily connecting the series lamps. The operating current of earth leakage device shall not exceed 30mA.
- 16.14 All the electrical equipments should be properly earthed as per Indian Electricity Rules.
- 16.15 Use of hoisting machines & tackle including their attachments, anchorage & supports shall be good of mechanical construction, sound materials & adequate strength & free from patent defect & shall be kept in good condition & in good working order.
- 16.16 No welding / grinding / cutting / soldering or open flare / fire etc. should be done without valid safety permit issued by the Engineer-In-charge. While welding / grinding / cutting make sure that sparks & molten slag etc. don't fly or come into contact with combustible materials surrounding equipments, valves etc. i.e. make provision for collection of sparks by using 'Fire Blankets'.
- 16.17 Use of SAFETY APPLIANCES like safety goggles, canvas hand gloves, welding helmet, chrome-leather hand gloves, safety shoes, etc. during welding/ chipping/ grinding should be enforced.
- 16.18 The following design features shall be ensured for all electrical installation during construction phase:
- i) Each installation shall have a main switch with a protective device, installed in enclosure adjacent to the metering point. The operating height of the main switch shall not exceed 1.5M. The main switch shall be connected to the point of supply by means of armoured cables.
 - ii) The out going feeders shall be double or triple pole switch with fuses / MCB. Loads connected to three phase circuit shall be balanced as far as possible and load on neutral shall not exceed 20% of load in the phase.
 - iii) The installation shall be provided adequate protection against overload, short circuit and earth leakage by using suitable protective devices. Fuses wherever required, shall be of HRC type only. Use of rewirable fuses shall be strictly prohibited.
 - iv) Connections to the welding receptacles / hand tools shall be taken through proper switches, sockets and plugs.

	TALCHER FERTILIZERS LIMITED TECHNICAL SPECIFICATION – ELECTRICAL ERECTION, TESTING & COMMISSIONING	PC183-TS-0843	0	
		Document No.	Rev	
		Sheet 46 of 47		

- v) It shall be ensured that all single phase sockets shall be 3-pin type only and all unused sockets shall be provided with socket caps.
 - vi) Contractor shall use 3 core (P+N+E) overall sheath flexible cables with minimum conductor size of 1.5 sq. mm. copper for all hand tools.
 - vii) Metallic distribution boxes with double earthing shall be used only at site. No wooden boxes shall be used.
 - viii) It shall be ensured that cables to be used for installation purpose shall be free from insulation damage.
 - ix) An independent earthing facility should preferably be provided within the temporary premises.
 - x) For local earthing, separate earth electrodes shall be installed near the supply point and earth continuity wire shall be connected to local earth plate for further distribution to various appliances. All insulated wires for earthing shall have insulation of green colour.
 - xi) It shall be ensured that structures shall not be used as a neutral. Separate core shall be provided for neutral earth.
 - xii) ON / OFF position of all switches shall be clearly marked / painted for easy isolation in emergency.
- 16.19 Don't check gas leaks with lighter, matches or other flame. Always keep gas cylinders away from direct rays of sun, hot place, welding, grinding & cutting sparks. Valves on cylinders should not be lubricated. Gas cylinders should be kept away from work place & Acetylene cylinders should be kept vertical. Cylinder should not be rolled on roads for transportation from stores or one place to another place, use suitable handcart for the purpose. It is prohibited to carry gas cylinder up-stair in the plant or in-side the vessel or confined spaces for cutting / welding job.
- 16.20 Permission of a supervisor before any excavation is a must. Also the presence of underground electric cables or any pipelines must be taken care of during excavation. Excavated earth must not be dumped within five feet. The further the better.
- 16.21 All the sewers or openings / cut-outs should be kept covered to avoid pit falls. Red illuminated signal should be displayed so that nobody goes near the pit / opening during dark hours. Proper approaches / scaffoldings / ladders etc. must be provided to avoid falls.
- 16.22 Be careful to keep all aisles, passageways and stairways clean & unobstructed. All discarded metal & other scrap should be collected. Storage area for keeping equipments, machines & other raw materials should be isolated & properly protected. Combustible materials like wooden pieces, cotton waste, bags etc. should be immediately removed to safe places.
- 16.23 Sitting or walking on rail tracks, crossing between wagons, taking rest under stabled wagons, crossing the rail through the openings underneath the stationary wagons shall be strictly prohibited. Standing under a suspended load is very dangerous. It may slip & fall on you thereby causing serious injury & even death.

	TALCHER FERTILIZERS LIMITED TECHNICAL SPECIFICATION – ELECTRICAL ERECTION, TESTING & COMMISSIONING	PC183-TS-0843	0	
		Document No.	Rev	
		Sheet 47 of 47		

- 16.24 Hands should be thoroughly washed before touching anything that goes in your mouth. All concerned personnel at site should maintain a high standard of 'Cleanliness'. Smoking & carrying matchbox, cigarettes, lighter, bidis etc. shall be prohibited.
- 16.25 Unauthorized entry into any battery limit of plant shall be strictly prohibited. Reckless driving or other non-observance of traffic safety rules shall result into withdrawal of permission to carry vehicles in side factory.

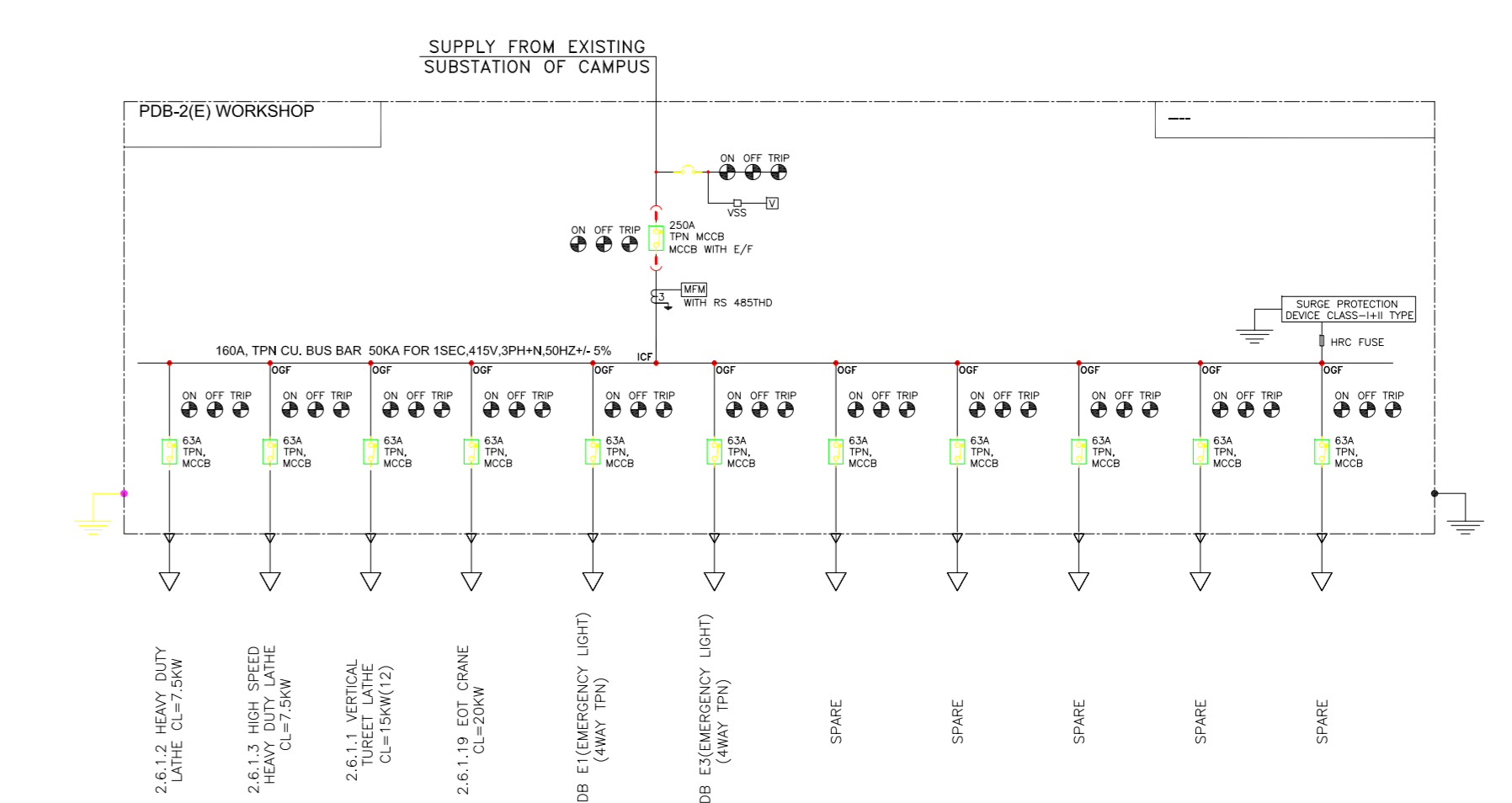
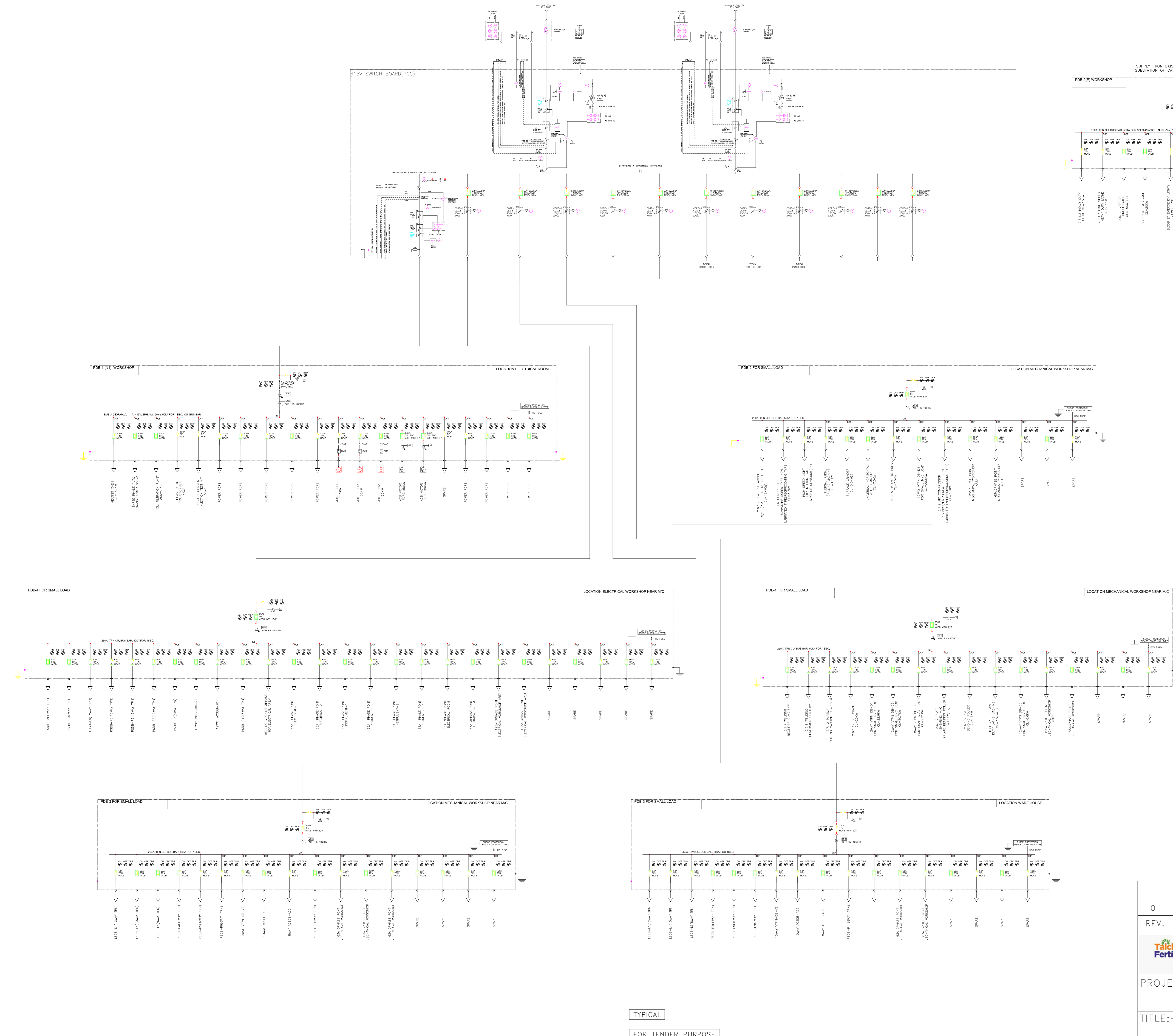

TYPICAL
FOR TENDER PURPOSE

0	06.03.23	ISSUED FOR TENDER	SS	SS	SKB
REV.	DATE	DESCRIPTION	PPD.	CKD.	APPD.
			CLIENT:- TALCHER FERTILIZER LIMITED		
PROJECT:- ELECTRICAL & INSTRUMENT SUPPLY CUM ERECTION WORKS			REV. 0 SHEET 1 OF 2 SCALE: N.T.S.		
TITLE:- TYPICAL SINGLE LINE DIAGRAM			DRG. NO.- PC183-1251 FILE:		
प्रोजेक्ट्स एंड डेवलपमेंट इंडिया लिमिटेड नोएडा PROJECTS & DEVELOPMENT INDIA LTD.-NOIDA					

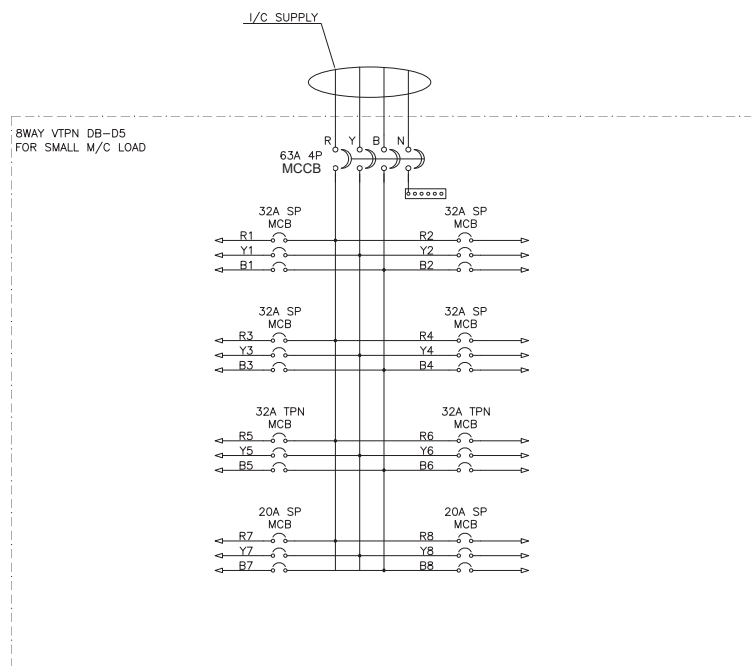
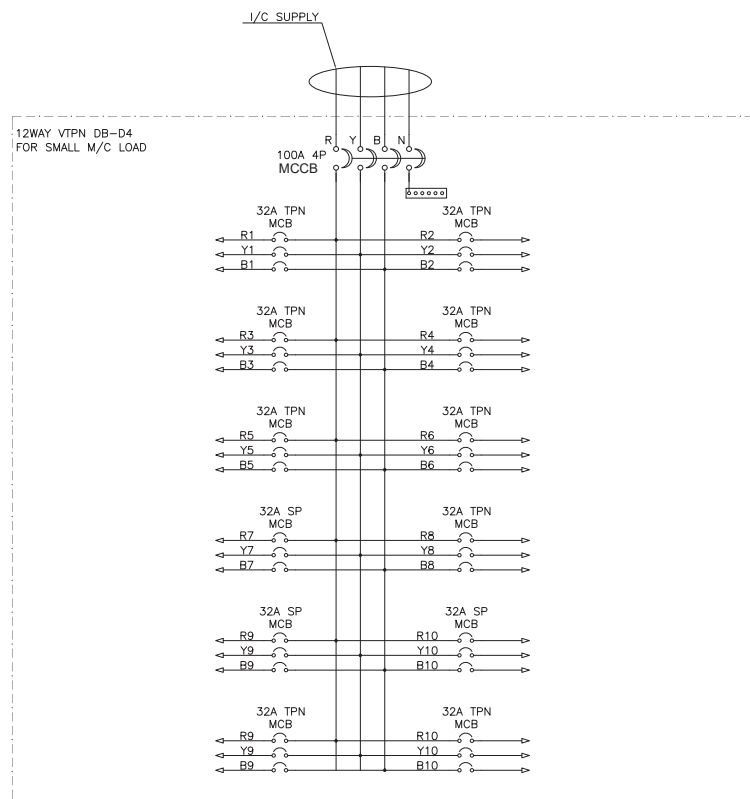
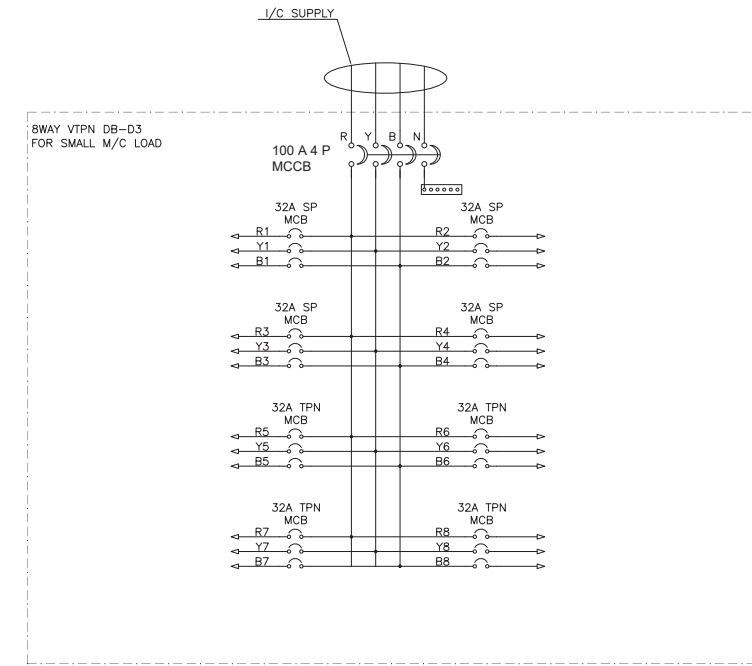
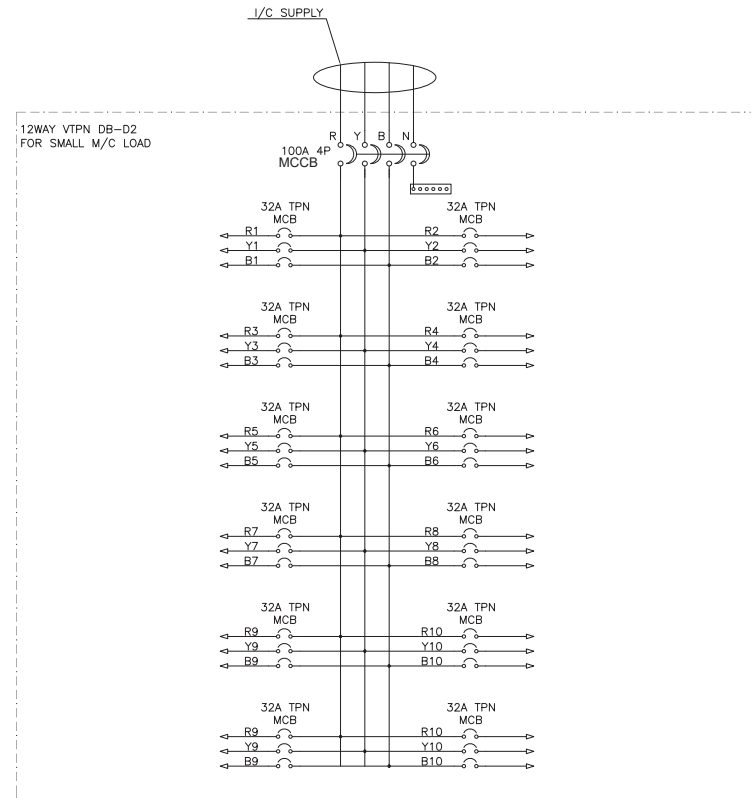
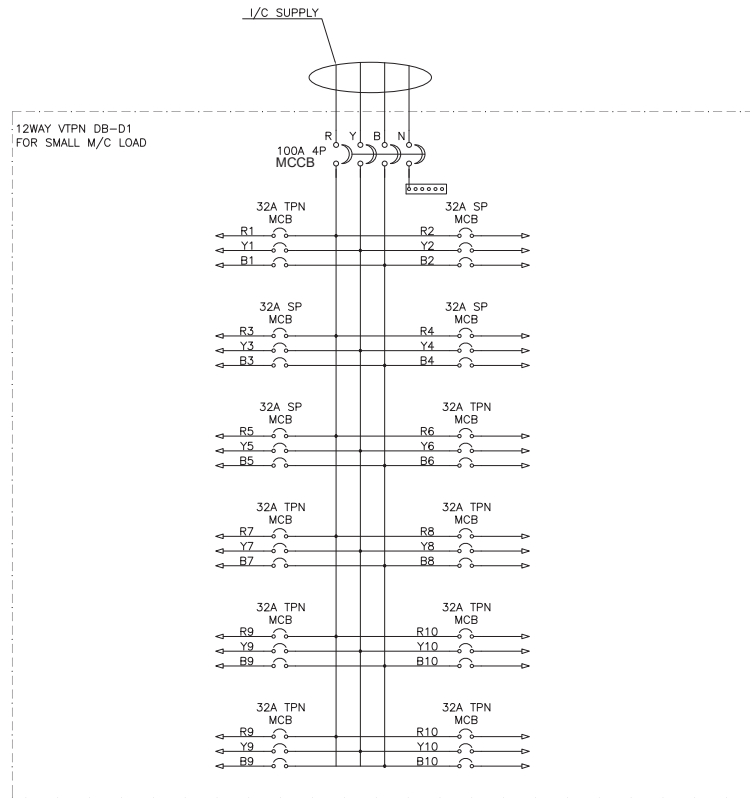

TYPICAL

FOR TENDER PURPOSE

0	06.03.23	ISSUED FOR TENDER	SS	SS	SKB
REV.	DATE	DESCRIPTION	PPD.	CKD.	APPD.
		CLIENT:- TALCHER FERTILIZER LIMITED	REV.	0	
			SHEET	2	OF
PROJECT:-		ELECTRICAL & INSTRUMENT SUPPLY CUM ERECTION WORKS	SCALE: N.T.S.		
TITLE:-			TYPICAL SINGLE LINE DIAGRAM	DRG. NO.- PC183-1252	
		PROJECTS & DEVELOPMENT INDIA LTD.-NOIDA			

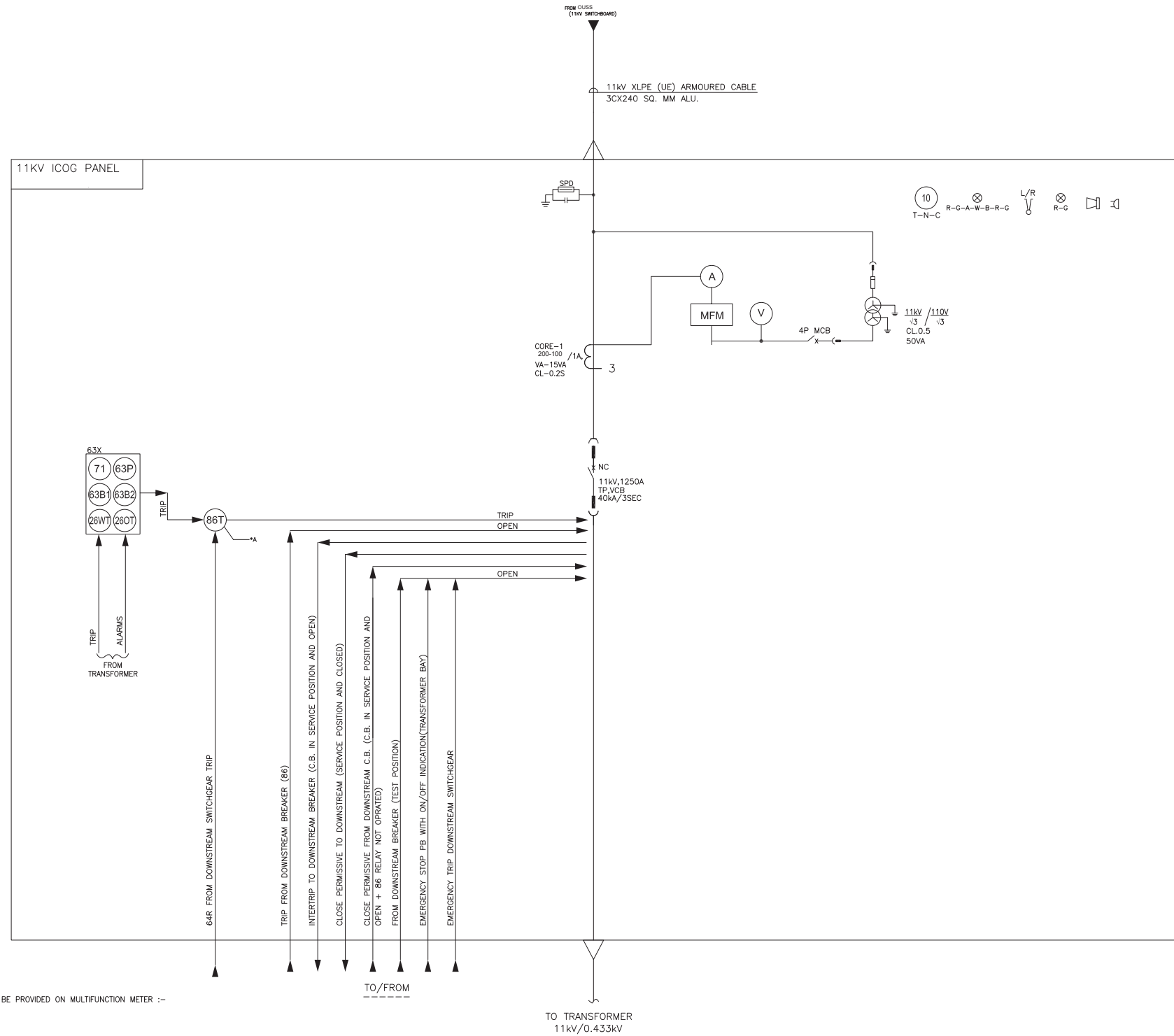

LEGENDS:-

⊕	MULTI FUNCTION METER	⊕	VOLTMETER ALONG WITH VSS
⊕	IMFL OVER CURRENT RELAY	⊕	AMMETER ALONG WITH ASS
⊕	IMT EARTH FAULT RELAY	⊕	POWER FACTOR METER
⊕	TRIP CIRCUIT SUPERVISION RELAY	⊕	SLUDGE PROTECTION DEVICE
⊕	UNDER VOLTAGE RELAY	⊕	TIMER
⊕	SYNCHRO CHECK RELAY	⊕	ISOLATOR
⊕	LINE DIFFERENTIAL RELAY	⊕	TRI VECTOR METER
⊕	DIRECTIONAL OVER CURRENT RELAY	⊕	LIGHTNING ARRESTOR
⊕	BACKUP EARTH FAULT RELAY		
⊕	LOCK OUT RELAY		
⊕	TNC SWITCH		
⊕	OIL LEVEL INDICATOR WITH CONTACTS		
⊕	PRESSURE RELAY DAPPHRAM		
⊕	TEMP. RELAY FOR WINDING		
⊕	TEMP. RELAY FOR OIL		
⊕	LOCK OUT RELAY(W/RESE) -TRANSFORMER		
⊕	INSTANT OVER CURRENT		
⊕	INSTANT OVER CURRENT GROUND FAULT RELAY CONNECTED IN RESIDUAL WAY		
⊕	OVER VOLTAGE RELAY		
⊕	DC SUPPLY FAILURE		
⊕	UNDER VOLTAGE RELAY TO INTIATE MOTOR FOR TRIP		
⊕	VT FAILURE		

- NOTE:-
- FOLLOWING MINIMUM METERING SHALL BE PROVIDED ON MULTIFUNCTION METER :-
 -3 PHASE CURRENT
 -LINE VOLTAGES
 -POWER FACTOR & FREQUENCY
 -KW,KVAR,KVA,KWH, & KVARH
 - LAMP TEST PUSH BUTTON SHALL BE PROVIDED.
 - SIGNALS/INDICATIONS TO/FROM 11kV ICOG ARE INDICATIVE. AND SHALL BE CONFIRMED DURING DETAIL ENG.
 - CIRCUIT BREAKER 'ON', 'OFF' INDICATION SHALL BE PROVIDED AT THE BACK OF EACH PANEL. ALTERNATIVELY ALARM SHALL BE PROVIDED IN CASE PANEL BACK DOOR IS OPENED WITH BREAKER 'ON'.

FOR TENDER PURPOSE

0	06.03.23	ISSUED FOR TENDER	SS	RK	SKB
REV.	DATE	DESCRIPTION	PPD.	CKD.	APPD.
		CLIENT:- TALCHER FERTILIZER LIMITED	REV.	0	
			SHEET 1 OF 1		
			SCALE: N.T.S.		
PROJECT:-		ELECTRICAL & INSTRUMENT SUPPLY CUM ERECTION WORKS	DRG. NO.- PC183-1254		
TITLE:-		SINGLE LINE DIAGRAM (11KV ICOG PANEL)	FILE:		
		प्रोजेक्ट्स एंड डेवलपमेंट इंडिया लिमिटेड नोएडा PROJECTS & DEVELOPMENT INDIA LTD.-NOIDA			



FOUNDATION DETAIL OF 11/.433 KV TRANSFORMER

PC183 PDS: E113

0

DOCUMENT NO.

REV

SHEET 1 OF 1

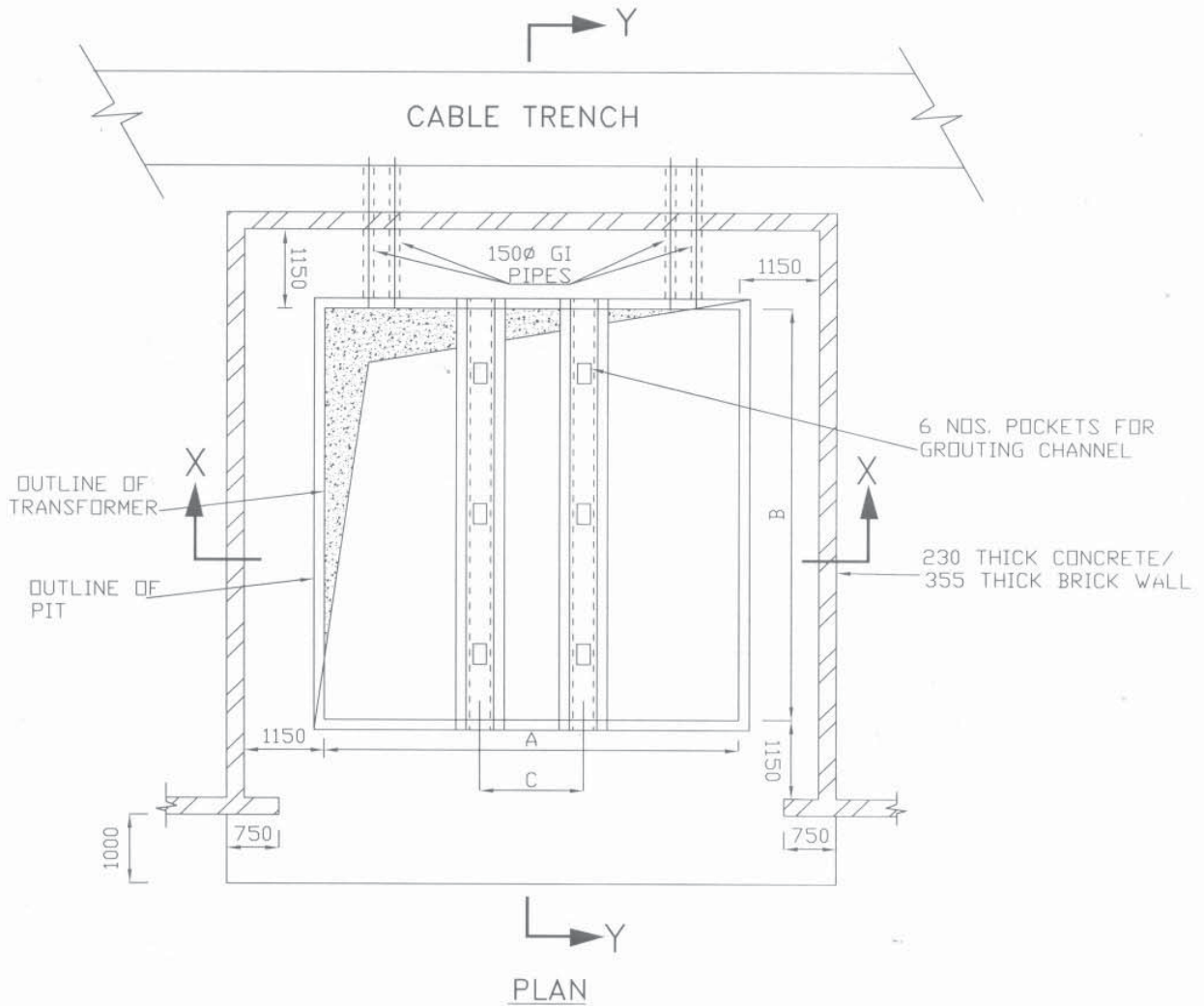

TYPICAL DETAIL OF 11/.433KV T/F

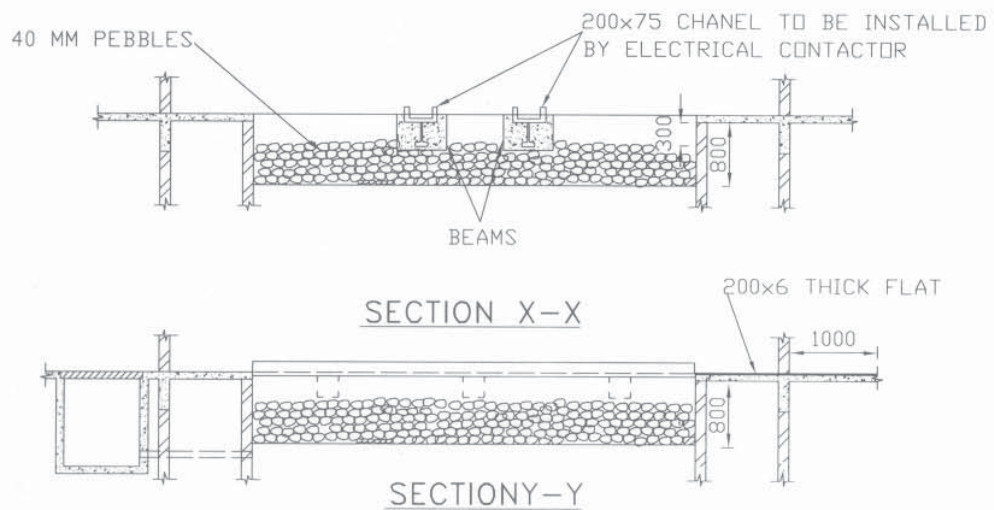

NOTE :

TRANSFORMERS RATED ABOVE 10MVA SHALL BE MOUNTED ON 200MM x 8MM THICK PLATES.



TYPICAL DETAILS OF TRANSFORMER ROOM DOOR

PC183 E 115

0

DOCUMENT NO.

REV

SHEET 1 OF 1

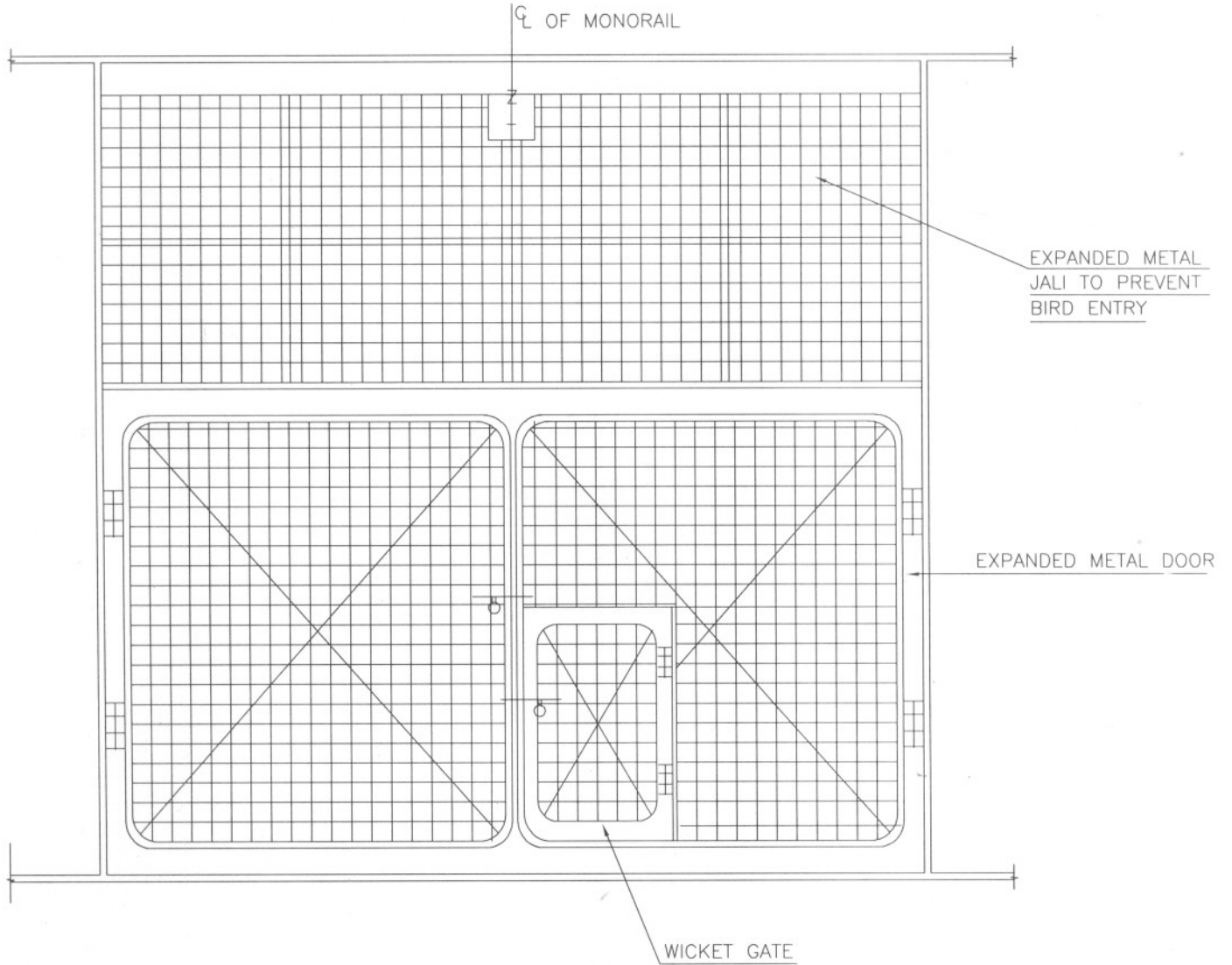

NOTE :-

1. THIS STANDARD IS INDICATIVE ONLY, THE EXACT DIMENSIONS SHALL BE DECIDED AS PER TRANSFORMER SIZE & SUB-STATION LAYOUT.
2. TRANSFORMER GATE HEIGHT SHALL BE 250MM MORE THAN THE TRANSFORMER HEIGHT AND SHALL BE OPENABLE OUTSIDE.

0	20.01.07	01.02.07	ISSUED FOR IMPLEMENTATION	<i>Shankar</i> RUNDA/AV	<i>SC</i> SC	<i>Rishu</i> BB
REV	REV.DATE	EFF.DATE	PURPOSE	PREPD	REVWD	APPD



SUMP PIT FOR TRANSFORMER OIL

PC183 PDS: E116	1
DOCUMENT NO.	REV
SHEET 1 OF 1	

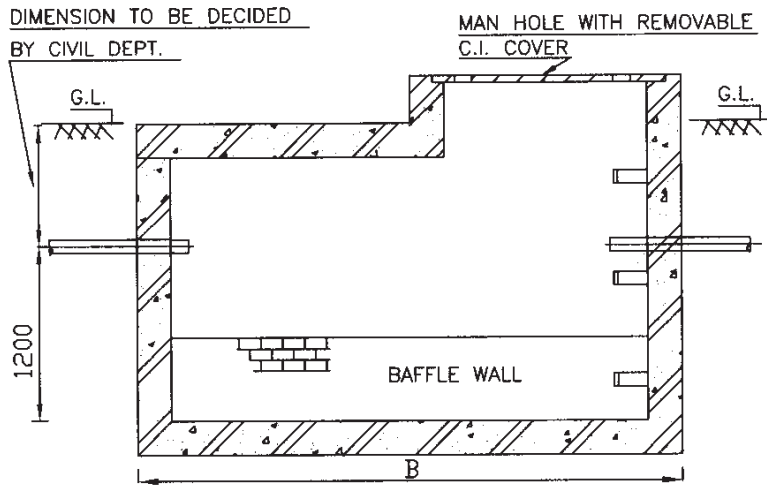

SECTION X-X

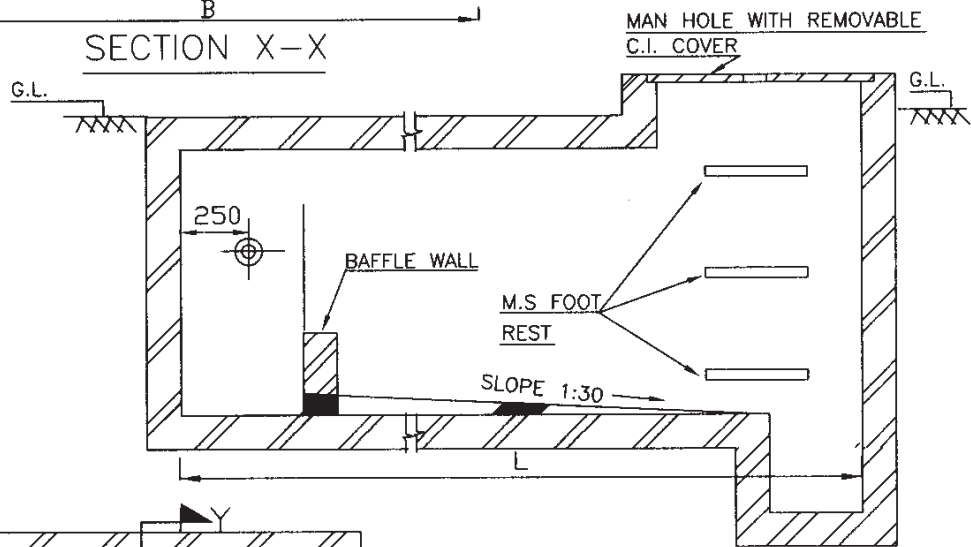

SECTION Y-Y

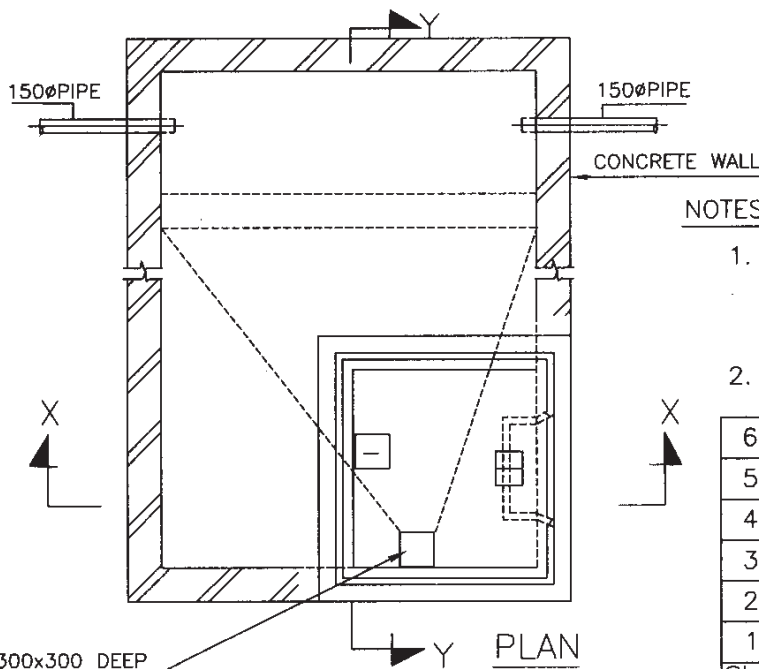

300x300x300 DEEP
SUNCTION PIT

PLAN

NOTES:-

- DIMENSION 'L' AND 'B' SHALL BE DECIDED BASED ON OIL VOLUME OF HIGHEST RATED TRANSFORMER.
- ALL DIMENSIONS ARE IN mm

6	2000	1.5	1.5
5	3000	1.5	2
4	5000	2.5	2
3	7000	3.0	2.5
2	8000	3.5	2.5
1	10000	4.0	2.5
SL. No.	OIL CAPACITY	L	B

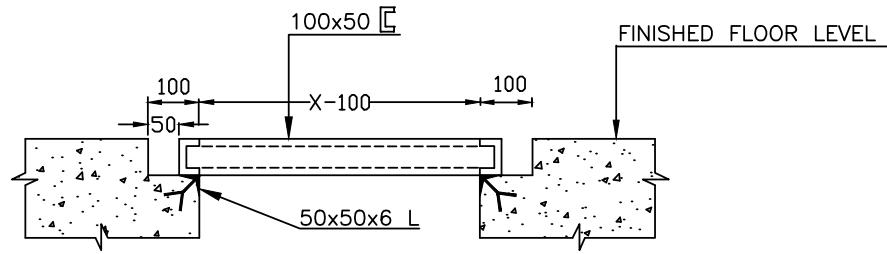

SECTION-A A

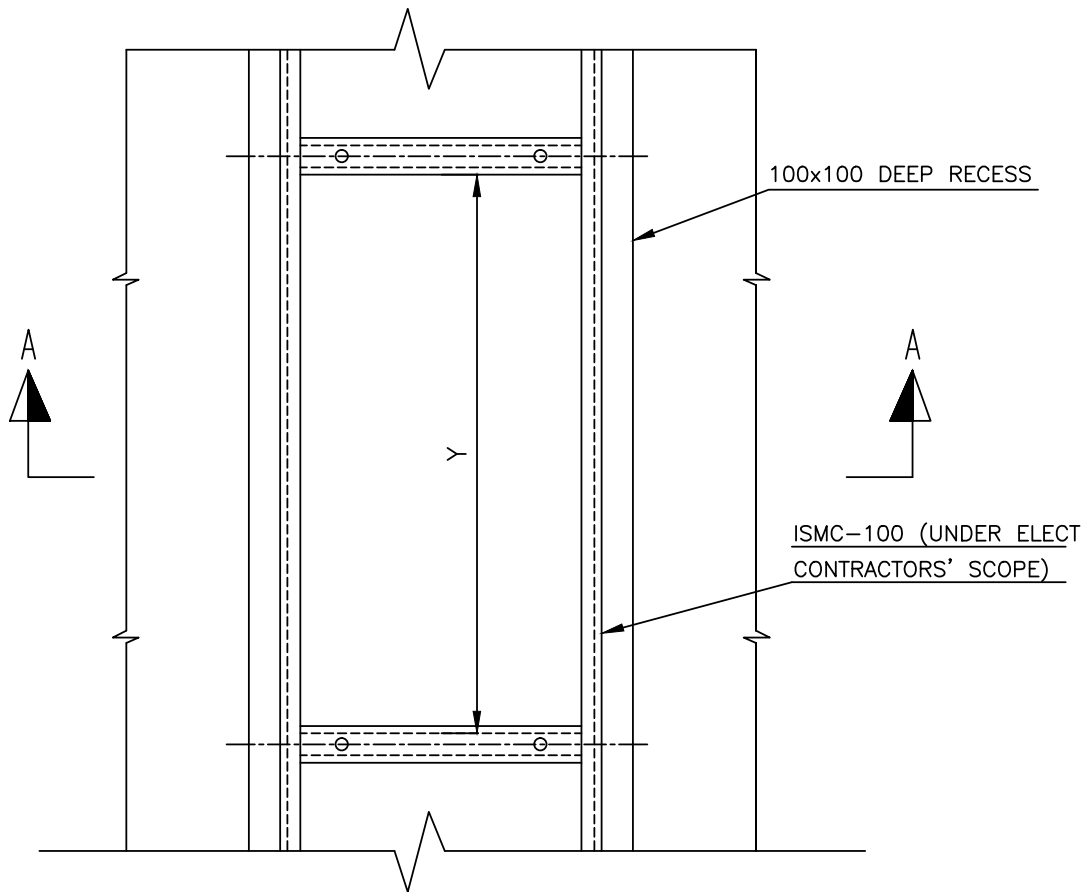

PLAN

X- DEPTH OF PANEL

Y- LENGTH OF TWO PANELS

NOTES:-

1. THIS ARRANGEMENT SHALL BE APPLICABLE FOR M.C.C., DISTRIBUTION BOARDS, CONTROL PANELS ETC.
2. PANELS AFTER ERECTION SHALL BE TAG WELDED TO FOUNDATION CHANNELS

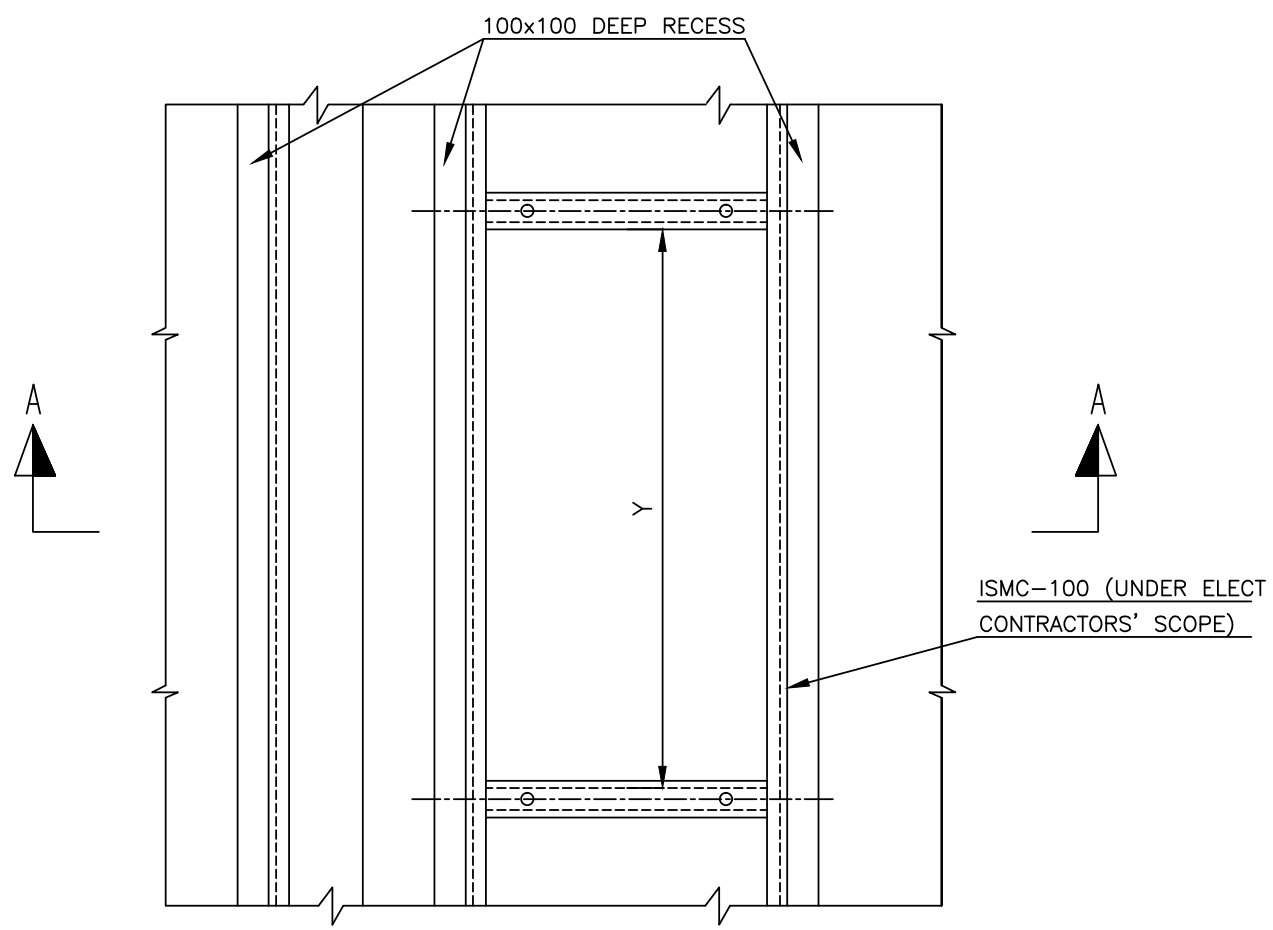
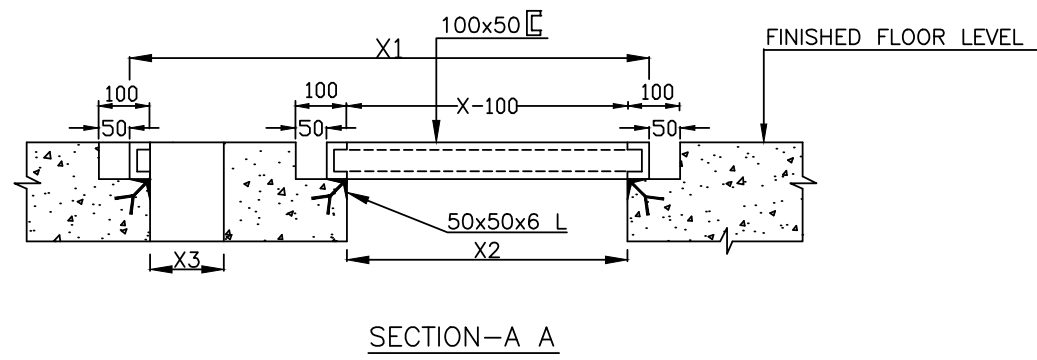

X1 = DEPTH OF PANEL
X2 = FOOR OPENING
X3 = FOOR OPENING
Y = LENGTH OF PANEL

- NOTES:-
1. PANELS AFTER ERECTION SHALL BE BOLTED TO FOUNDATION CHANNELS
 2. POWER & CONTROL CABLES SHALL ENTER THROUGH OPENING X2
 3. DEPENDING UPON THE FINAL DATA FROM THE VENDOR, ONLY TWO CHANNELS MAY BE NECESSARY IN WHICH CASE THE 3RD. RECESS SHALL BE FILLED AT SITE.

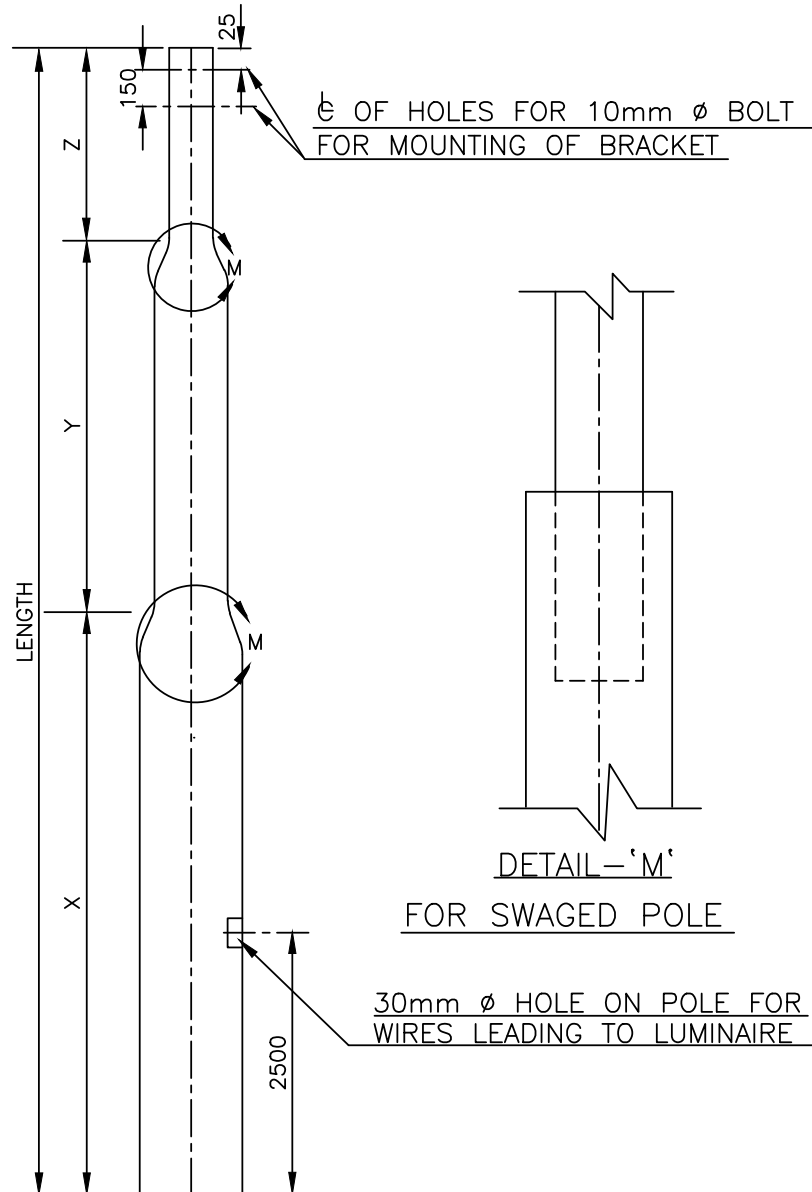

POLE DESIGNATION	LENGTH(M) $X+Y+Z=L$	PLANTING DEPTH(M)	DIAxTHICKNESS BOTTOM(mm)	DIA MIDDLE(mm)	DIA TOP(mm)	WEIGHT OF POLE (Kg)
410 TP3/SP3	$X+Y+Z=7$	1.25	114.3x4		78.1	87/85
410 TP12/SP12	$X+Y+Z=8$	1.5	114.3x4		78.1	101/97
410 TP13/SP13	$X+Y+Z=8$	1.5	139.7x4		88.9	125/119
410 TP27/SP27	$X+Y+Z=9$	1.5	114.3x4		76.1	113/108
410 TP30/SP30	$X+Y+Z=9$	1.5	139.7x4		88.9	140/133
410 TP33/SP33	$X+Y+Z=9$	1.5	165.1x4		114.3	170/184

NOTE:-

1. TP REFER TO STEPPED POLE.
2. SP REFER TO SWAGED POLE.
3. POLE DESIGNATION IS AS PER IS: 1239

SWAGED POLE TYPE 'B'

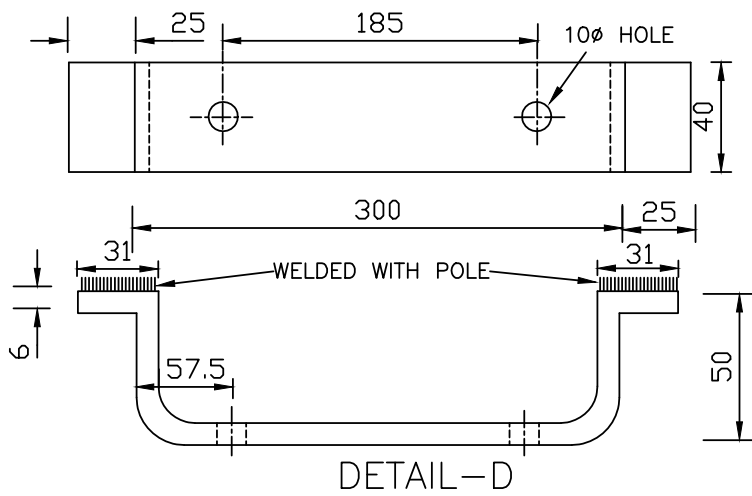
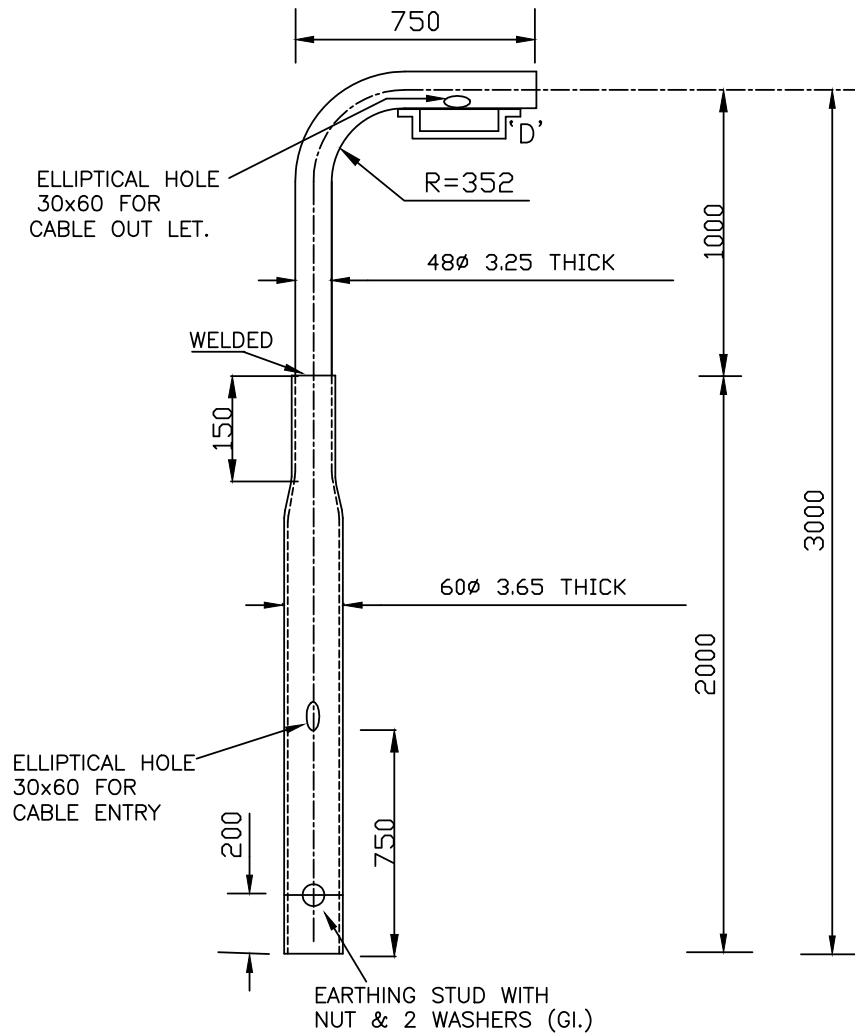

NOTE:-

1. ALL DIMENSIONS ARE IN mm

SWAGED POLE TYPE 'C'
(FOR PLANT GROUND MOUNTING)

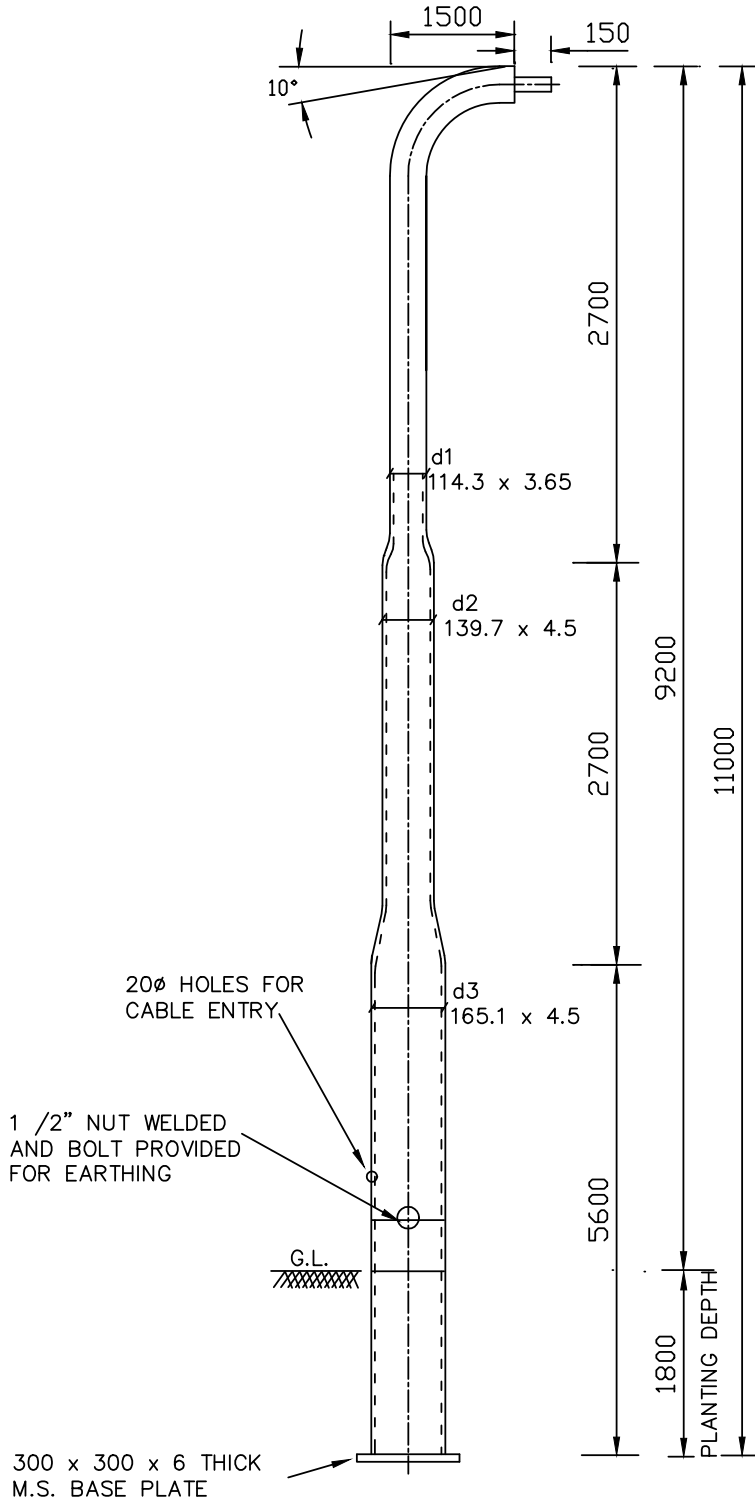

NOTES: -

1. NIPPLE OF DIA. 45 (NIPPLE TO BE PREPd. BY DIRECT REDUCTION OF DIA OF TOP PIPE WITHOUT USE OF ANY WASHER)
2. POLE MATERIAL MS AS PER IS 1239 ABOVE GROUND PORTION TO BE PAINTED 2 COATS OF RED OXIDE PRIMER, UNDER GROUND PORTION PAINTED BITUMINUS PAINT.
3. FOR FLOOD LIGHTING POLE THE TOP PORTION NOT TO BE TILTED BUT A 300 x 300 x 6mm THICK M.S. PLATE WELDED AT THE TOP SHALL BE PROVIDED TO MOUNT FLOOD LIGHT.
4. ALL DIMENSIONS ARE IN mm

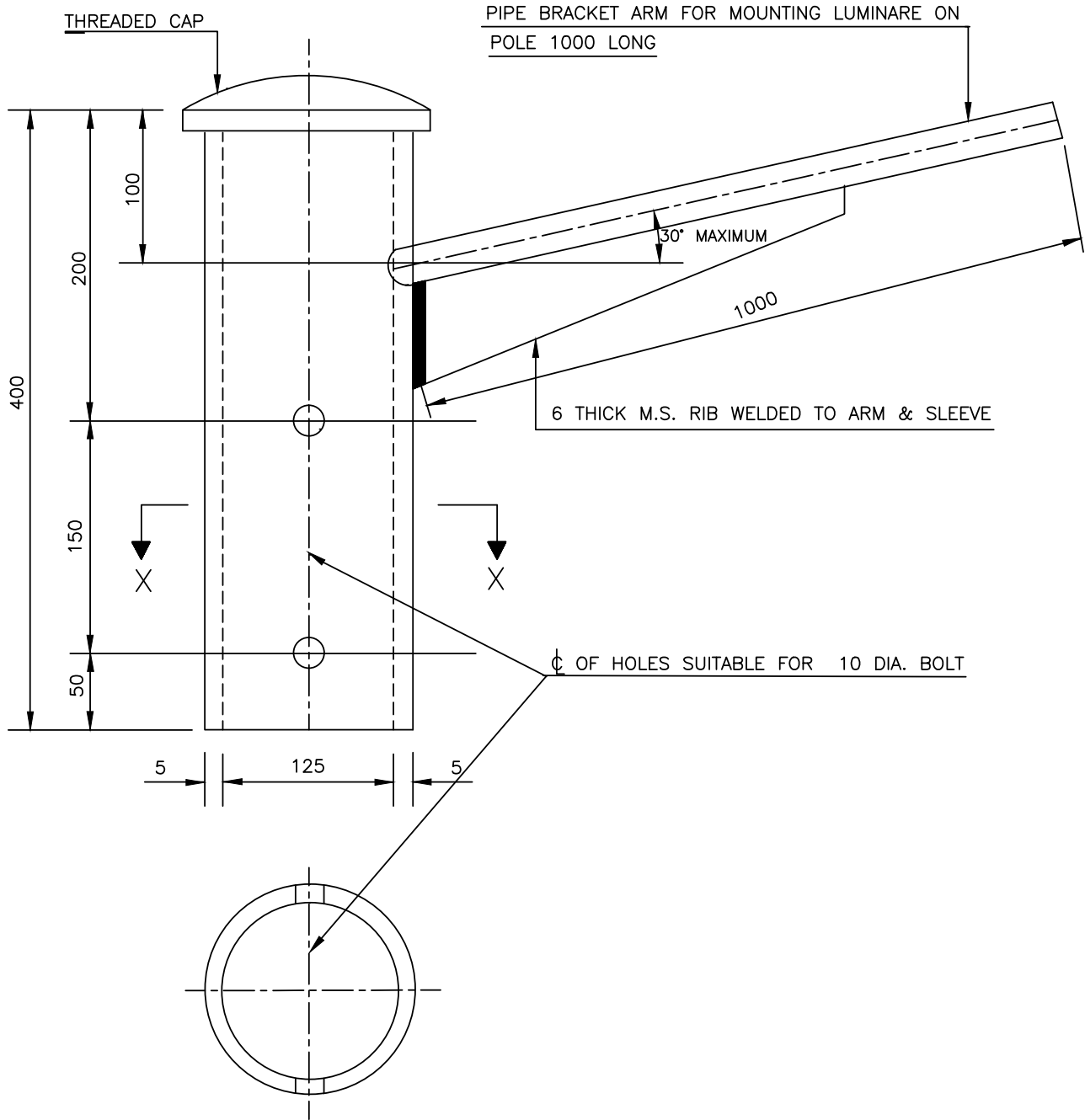

NOTES:-

1. SIZE OF PIPE SHALL BE 30mm FOR TL/80W HPL FIXTURES,
40mm FOR 70W SON/125W HPL FIXTURES AND 50mm FOR
150W SON/250W HPL FIXTURES.
2. ALL DIMENSIONS ARE IN mm.

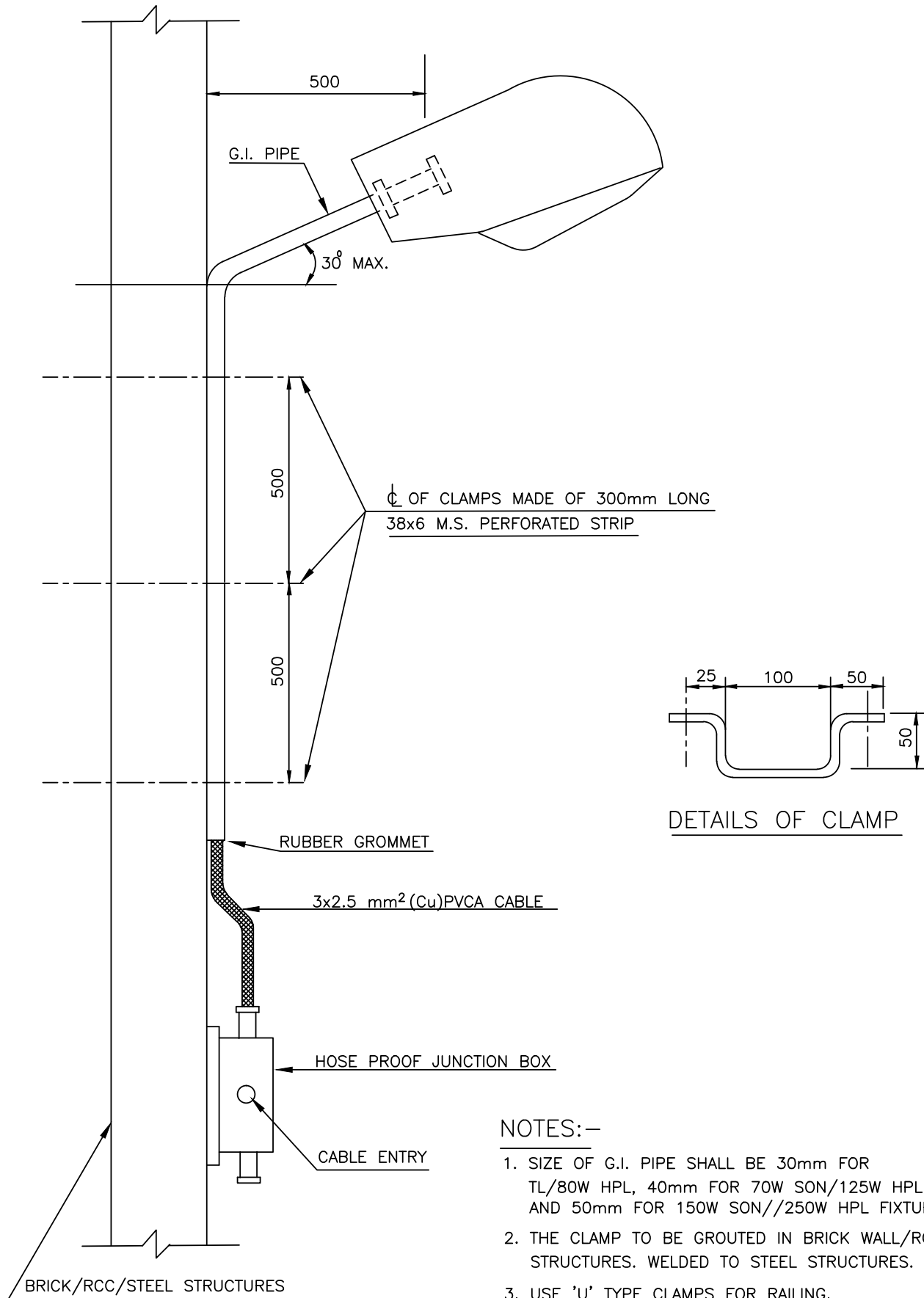

NOTES:—

1. SIZE OF G.I. PIPE SHALL BE 30mm FOR TL/80W HPL, 40mm FOR 70W SON/125W HPL AND 50mm FOR 150W SON//250W HPL FIXTURES.
2. THE CLAMP TO BE GROUTED IN BRICK WALL/RCC STRUCTURES. WELDED TO STEEL STRUCTURES.
3. USE 'U' TYPE CLAMPS FOR RAILING.
4. ALL DIMENSIONS ARE IN mm.

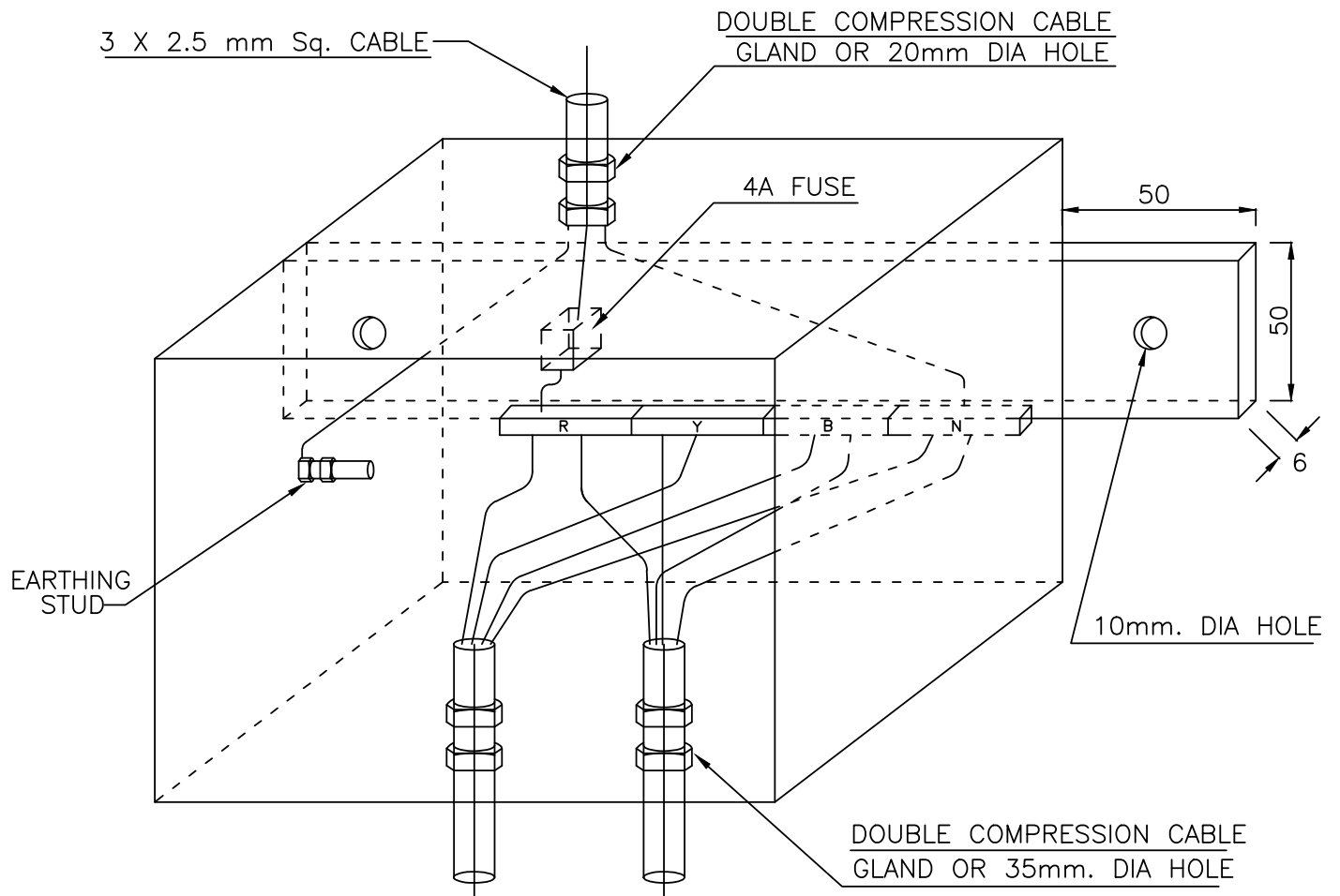

NOTE:-

1. THE MINIMUM INTERNAL DIMENSION OF THE J.B. SHALL BE 152 X 152 X 152.
2. THE FRONT DOOR SHALL BE HINGED & LOCKABLE TYPE.
3. THE CONNECTION OF FUSE TO THE PHASE 'R' IS TYPICAL ONE THE EXACT PHASE TO WHICH CONNECTION SHALL BE MADE SHALL BE DECIDED AT SITE.
4. FOR HAZARDOUS AREA'S THESE JUNCTION BOXES SHALL BE INCREASED SAFETY TYPE AND THE FUSE NEED NOT BE PROVIDED.
5. FOR POLE MOUNTED JUNCTION BOXED THE CABLE GLAND SHALL BE SIDE MOUNTED.
6. ALL DIMENSIONS ARE IN mm.

TYPICAL STREET LIGHTING POLE

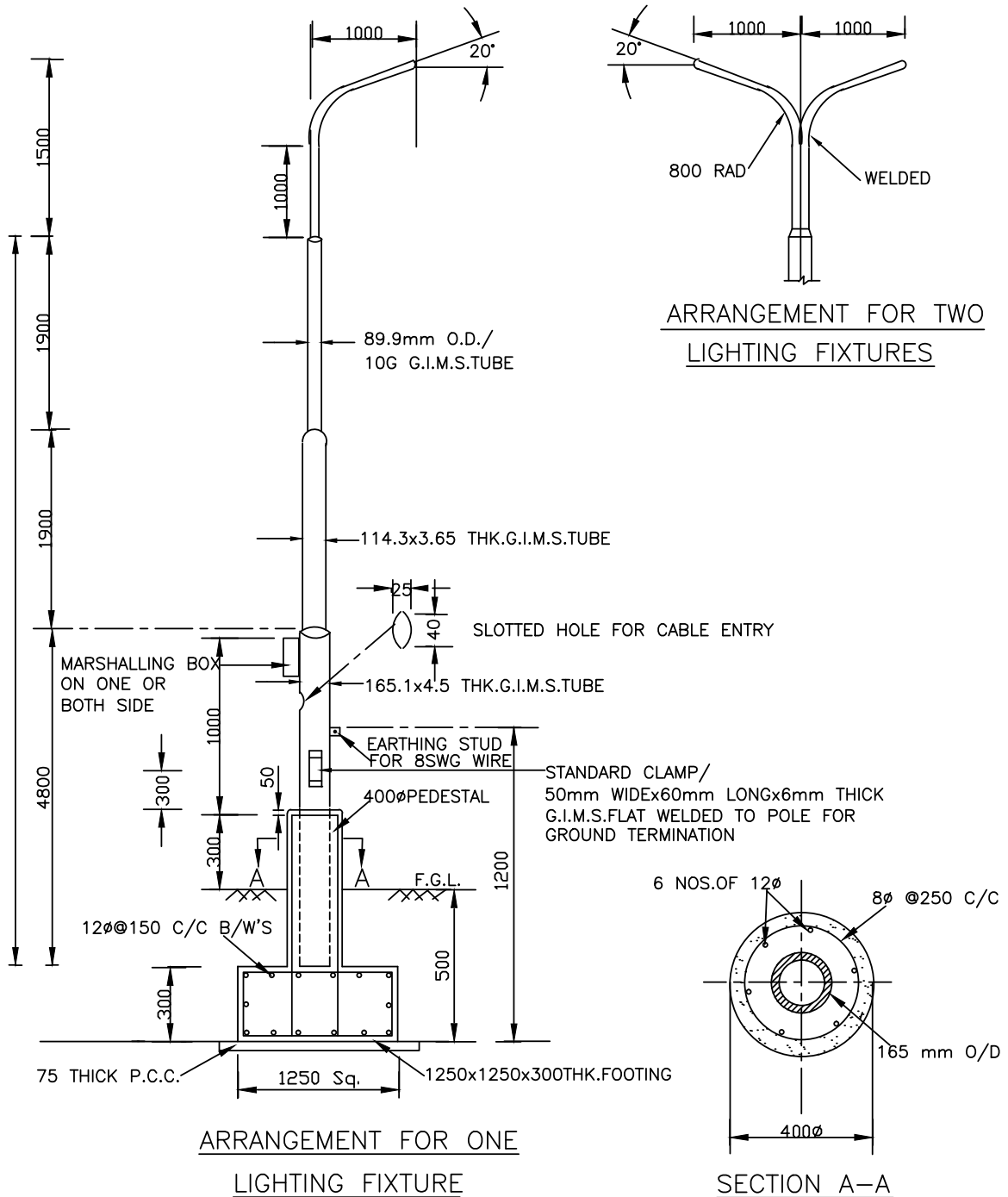

NOTE :-

1. CONCRETING AND APPROVED MOUNTING HARDWARE FOR LIGHTING FIXTURES ARE INCLUDING IN SCOPE OF SUPPLY.
2. CONCRETE FOUNDATION OF GRADE M15 SHALL BE PROVIDED.

ALL DIMENSIONS ARE IN mm.

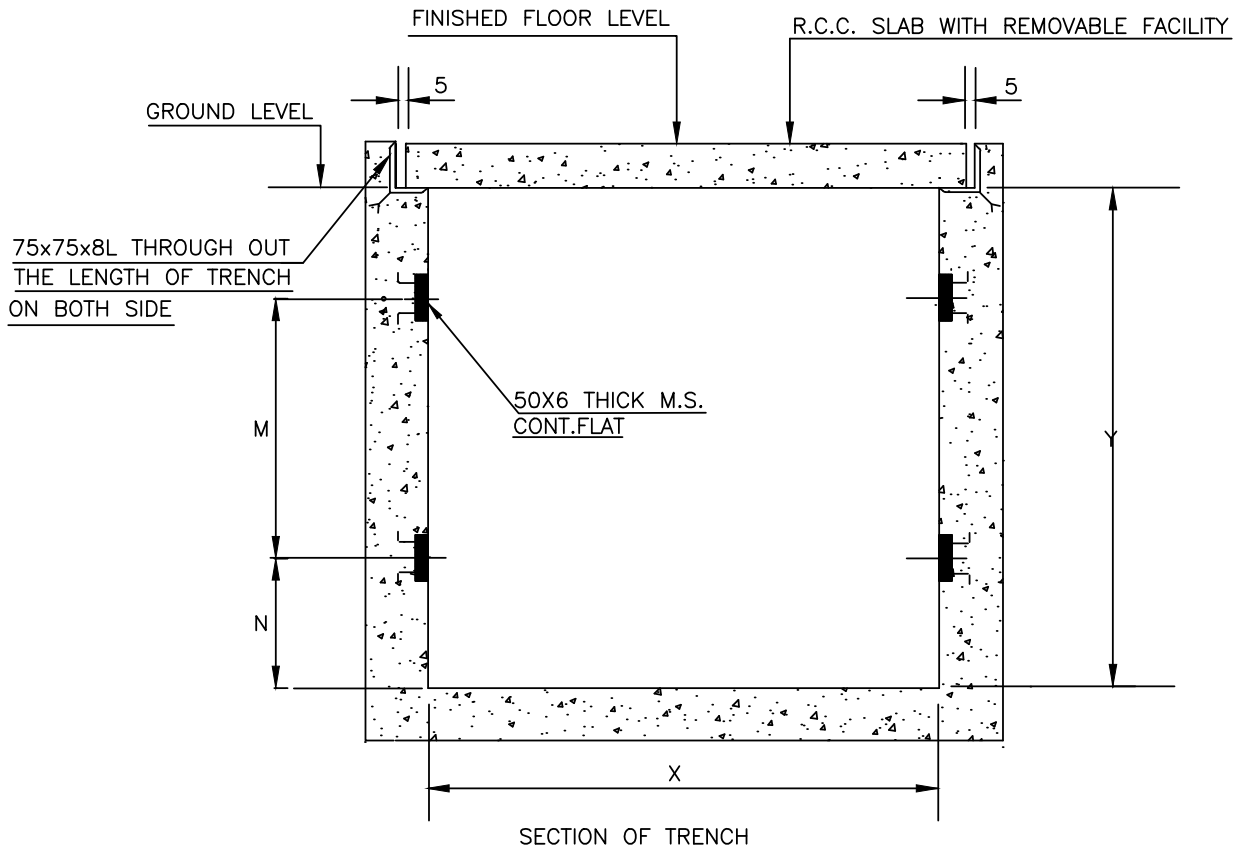

DESIGN TYPE	X	Y	N	M
5T 350DS.	1400	1500	400	650
4T 350DS.	1400	1200	250	650
3T 350DS.	1400	900	250	300
5T 350SS.	1000	1500	400	650
4T 350SS.	1000	1200	250	650
3T 350SS.	1000	900	250	300
5T 250DS.	1200	1500	400	650
4T 250DS.	1200	1200	250	650
3T 250DS.	1200	900	250	300
5T 250SS.	900	1500	400	650
4T 250SS.	900	1200	250	650
3T 250SS.	900	900	250	300

NOTES:—

1. THE TOP OF TRENCH SHALL MATCH THE FLOOR LEVEL IN PLANT AREA.
2. IN INDOORS INSTEAD OF RCC SLAB, 20mm. THICK AL. EXTRUDED PLANK OR 10mm. THICK M.S. CHEQUERED PLATE SHALL BE USED AS PER PDS:E 507.
3. PROPER SLOPE TO BE GIVEN IN THE TRENCH FOR NATURAL DRAINAGE.
4. SS—SINGLE SIDE CABLE SUPPORTS.
5. DS—DOUBLE SIDE CABLE SUPPORTS.
6. ALL DIMENSIONS ARE IN mm.

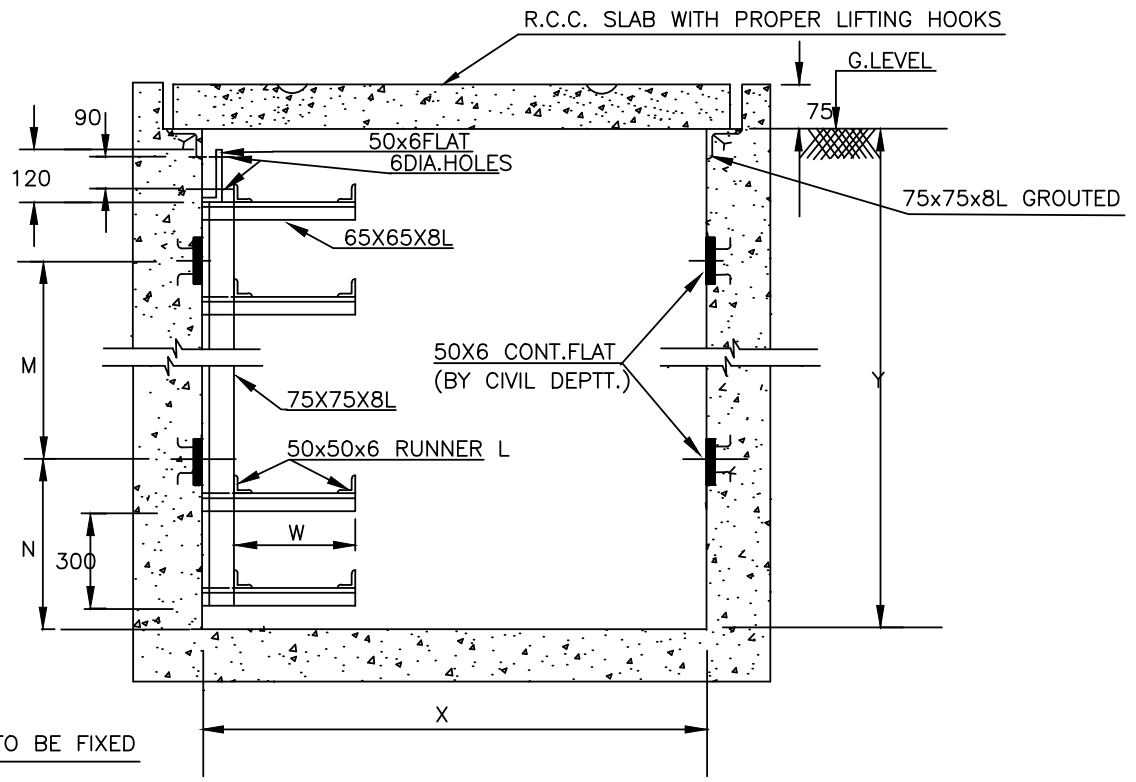

CABLE SUPPORTS TO BE FIXED
@ 1500 INTERVAL

SECTION OF TRENCH

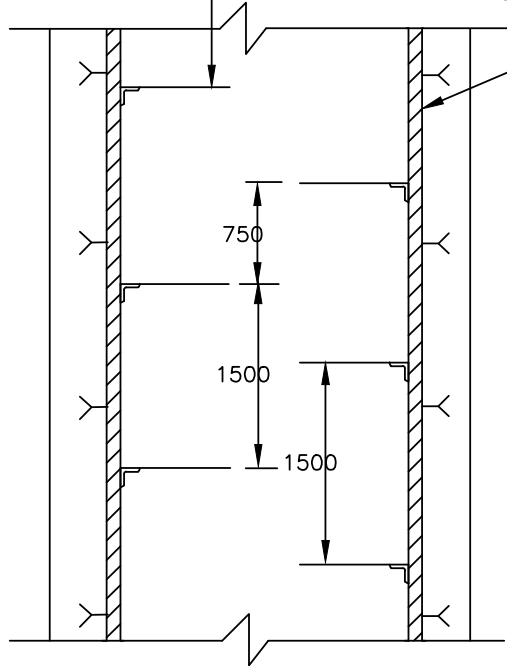

TYPICAL PLAN OF TRENCH

DESIGN TYPE	X	Y	N	M	W
5T-350-DS.	1400	1500	400	650	350
4T-350-DS.	1400	1200	250	650	350
3T-350-DS.	1400	900	250	300	350
5T-350-SS.	1000	1500	400	650	350
4T-350-SS.	1000	1200	250	650	350
3T-350-SS.	1000	900	250	300	350
5T-250-DS.	1200	1500	400	650	250
4T-250-DS.	1200	1200	250	650	250
3T-250-DS.	1200	900	250	300	250
5T-250-SS.	900	1500	400	650	250
4T-250-SS.	900	1200	250	650	250
3T-250-SS.	900	900	250	300	250

NOTES:-1. SS-SINGLE SIDE CABLE SUPPORT.
2. DS-DOUBLE SIDE CABLE SUPPORT.
3. ALL DIMENSIONS ARE IN mm.

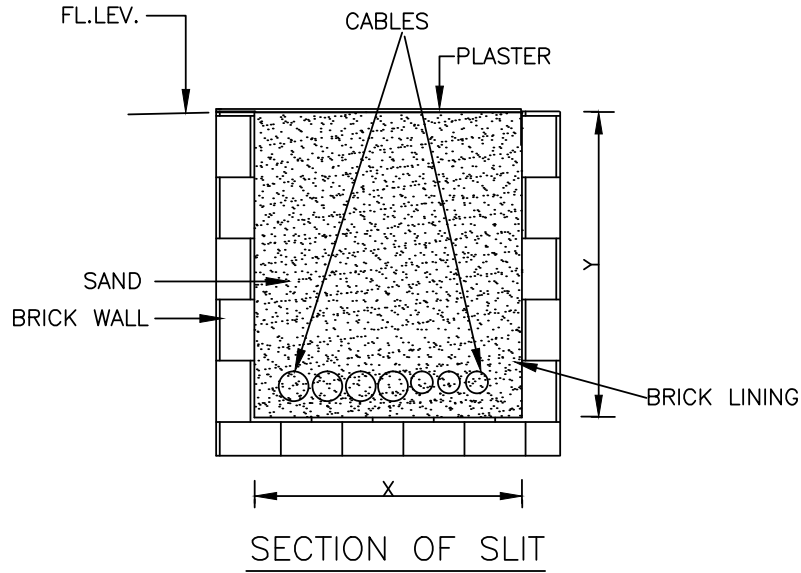

DESIGN TYPE	X	Y
S 300	300	300
S 200	200	200

NOTE:-

1. CABLE SLITS SHALL BE FILLED WITH SAND AND PROPERLY PLASTERED WITH LEAN CONCRETE AFTER LAYING OF CABLES.
2. WHEREVER CABLES ARE COMING OUT OF THE SLIT, SUITABLE MECH.PROTECTION TO BE PROVIDED.

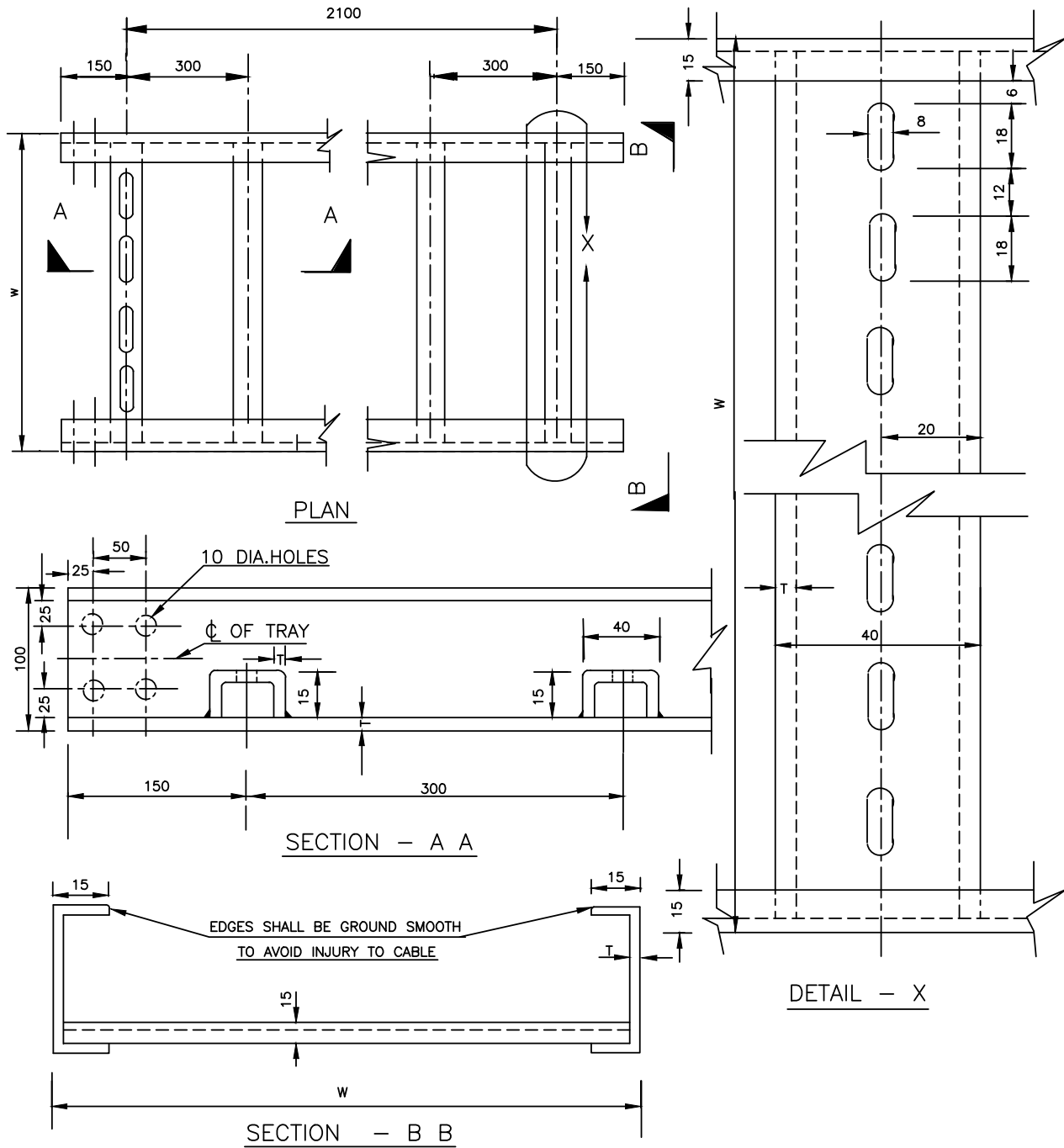

DESIGN TYPE (WIDTH)	MAX.SUPPORTING SPAN		WEIGHT/METER APPROX. IN Kg.	
	G. I.	A. L	G. I.	A. L
SR 900	2000	2000	10.5	3.6
SR 600	2000	2000	8.9	3.05
SR 450	2000	2000	8.0	2.75
SR 300	2000	2000	7.6	2.6
SR 150	2000	2000	6.8	2.33

NOTE:-

THICKNESS " T " SHALL BE 3mm FOR G.I AND 4mm.FOR AL.

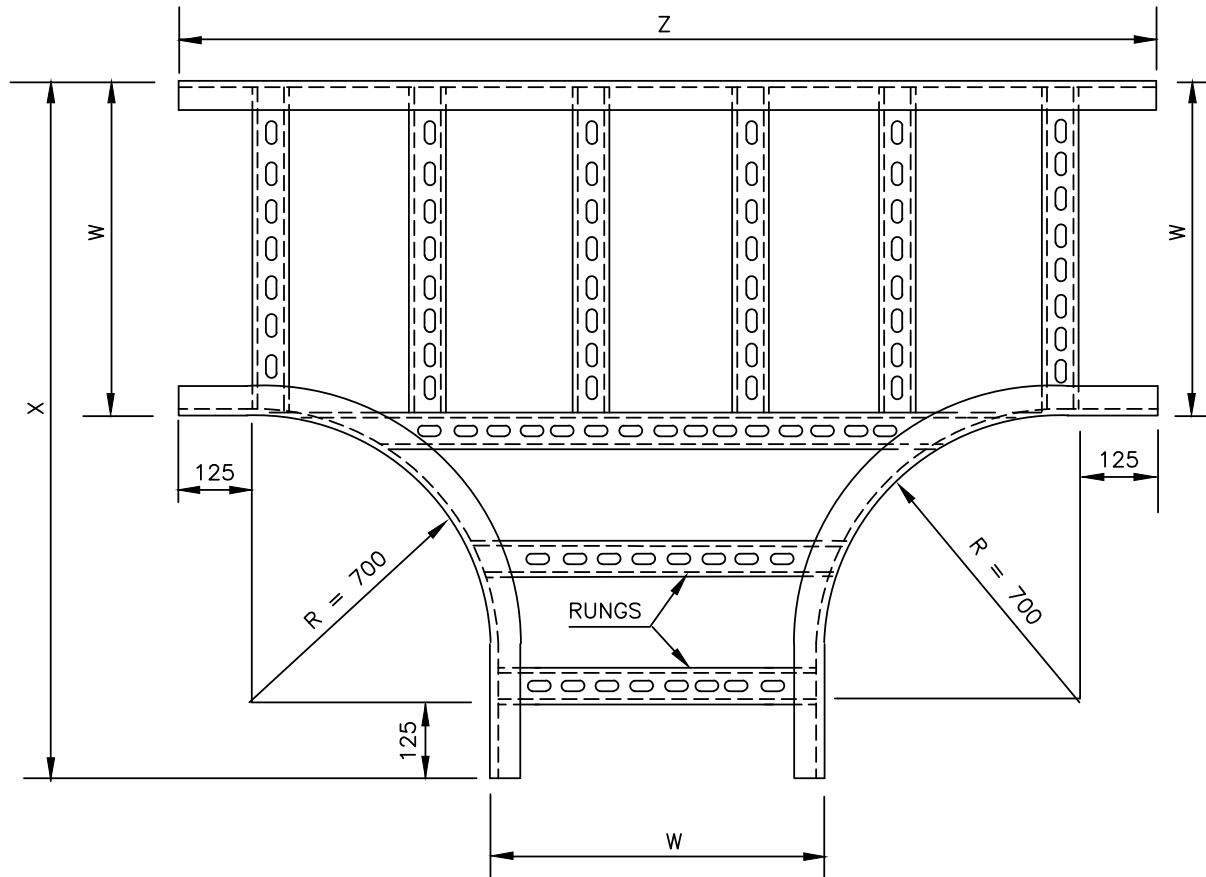

PLAN

DESIGN TYPE	W	$X=R+W+125$	$Z=2R+W+250$
HT 900	900	1725	2550
HT 600	600	1425	2250
HT 450	450	1275	2100
HT 300	300	1125	1950

NOTES :-

1. DISTANCE BETWEEN TWO RUNGS SHOULD BE APPROX. 300mm.
2. ALL DIMENSIONS ARE IN mm.

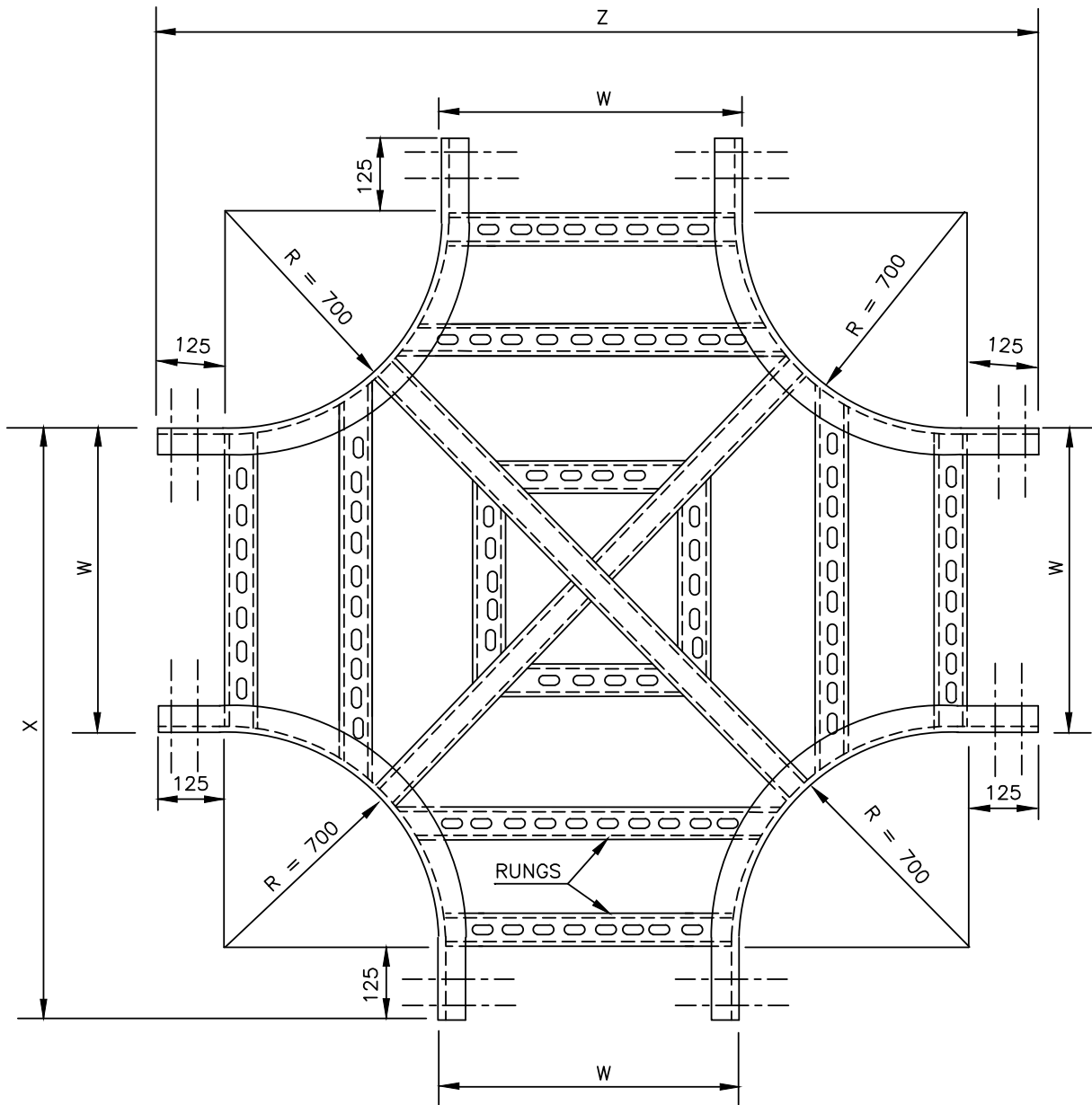

PLAN

DESIGN TYPE	W	$X=R+W+125$	$Z=2R+W+250$
HC 900	900	1725	2550
HC 600	600	1425	2250
HC 450	450	1275	2100
HC 300	300	1125	1950

NOTES :-

1. DISTANCE BETWEEN TWO RUNGS SHOULD BE APPROX. 300mm.
2. ALL DIMENSIONS ARE IN mm.

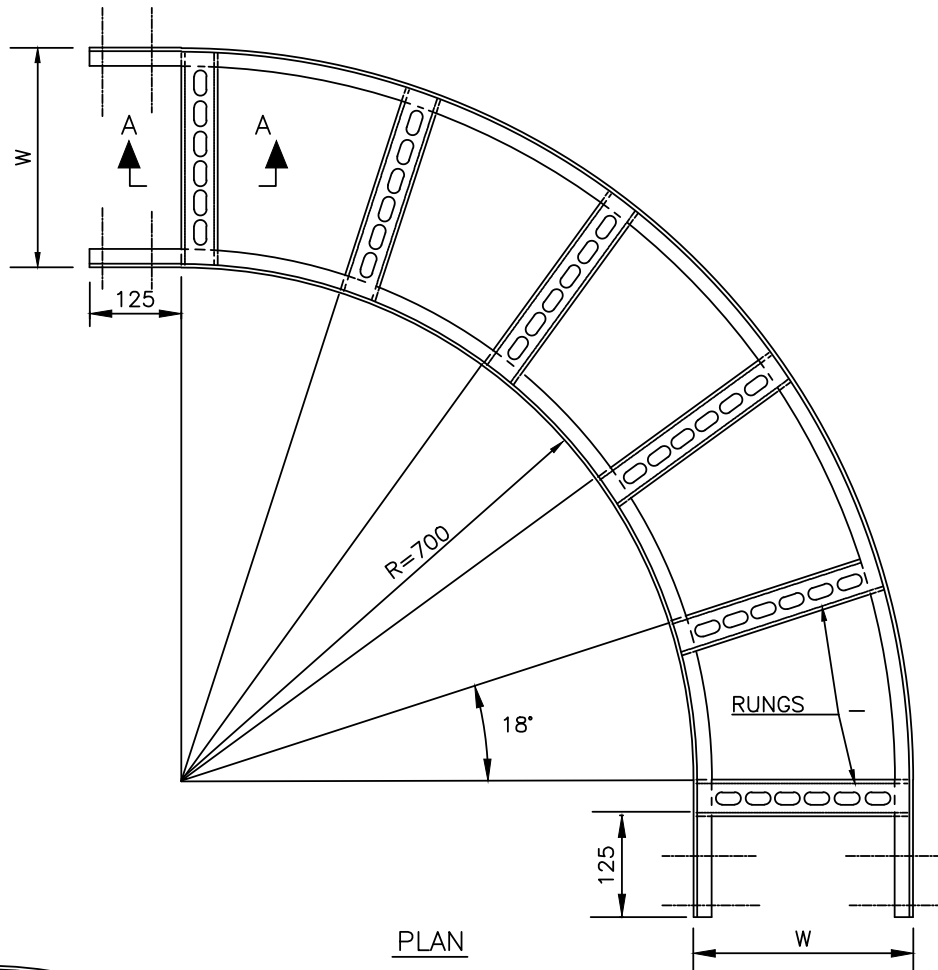

PLAN
(700R BEND)

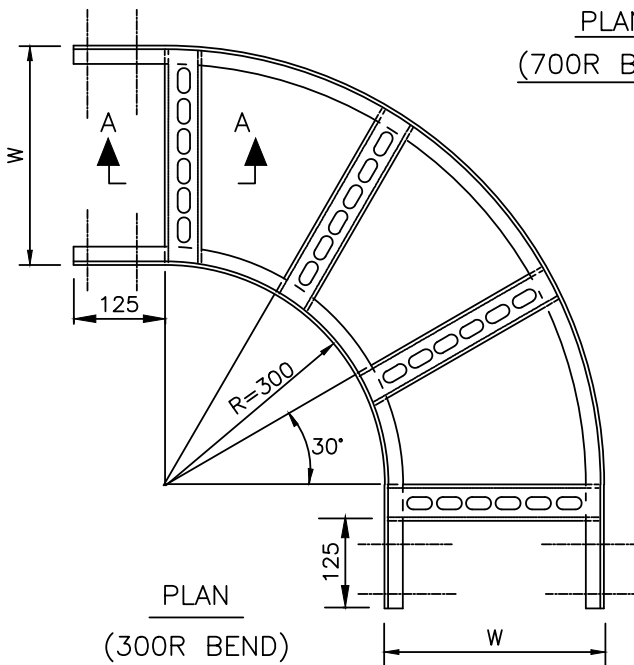

PLAN
(300R BEND)

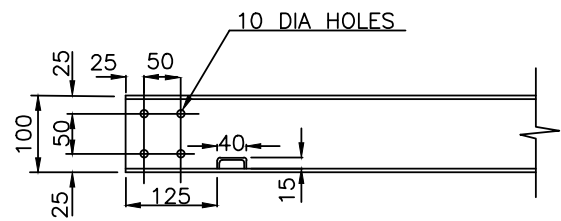

SECTION A-A

ALL DIMENSIONS ARE IN mm.

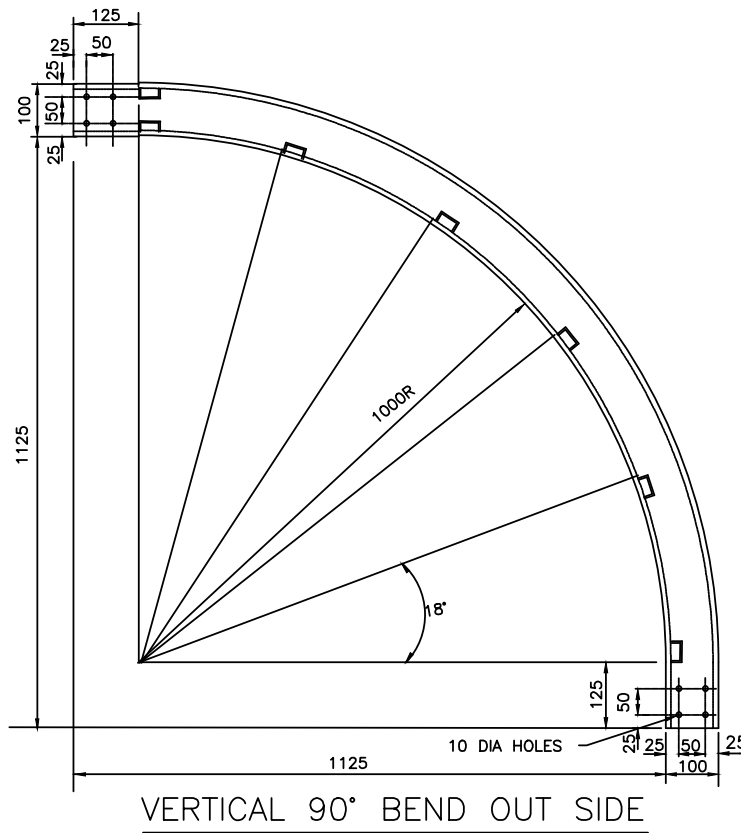
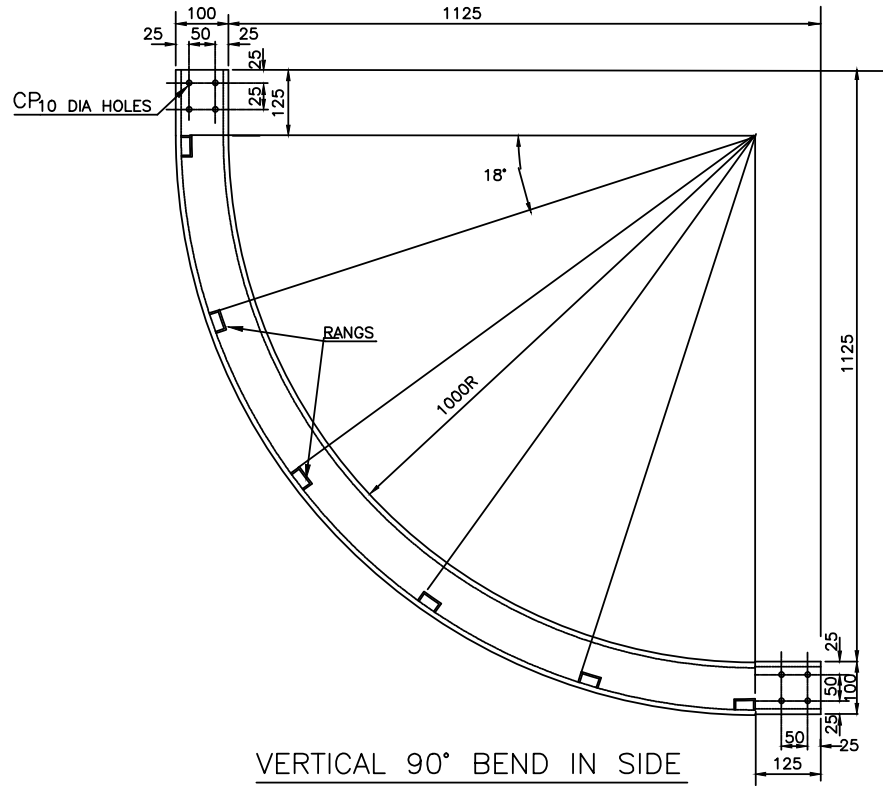

DIMENSIONS ARE IN mm.

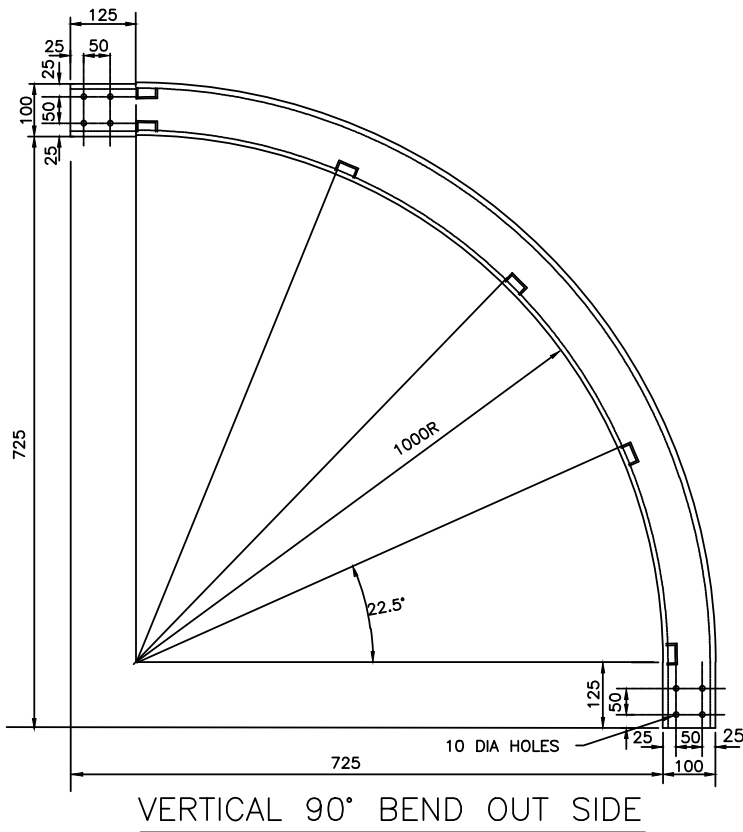
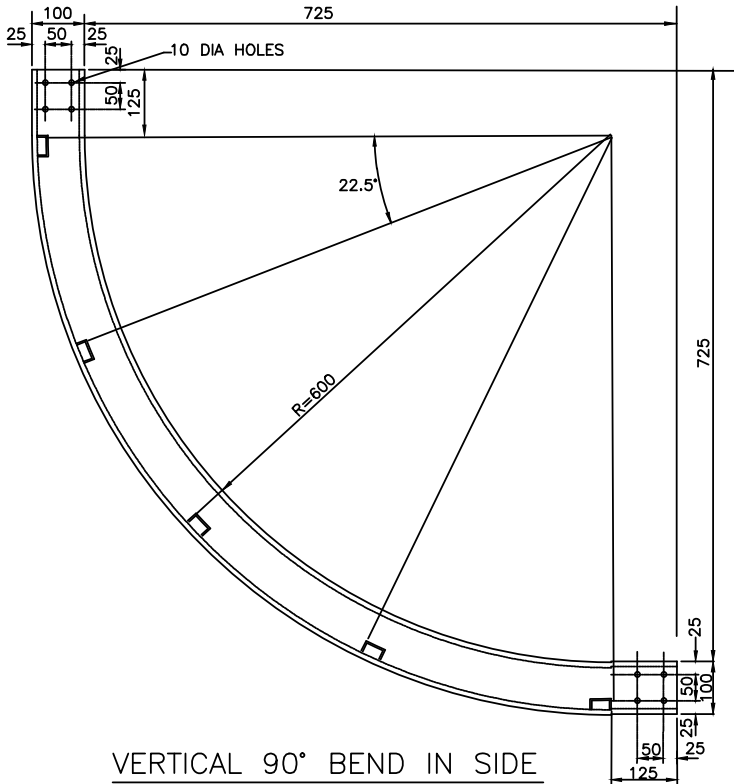

ALL DIMENSIONS ARE IN mm.

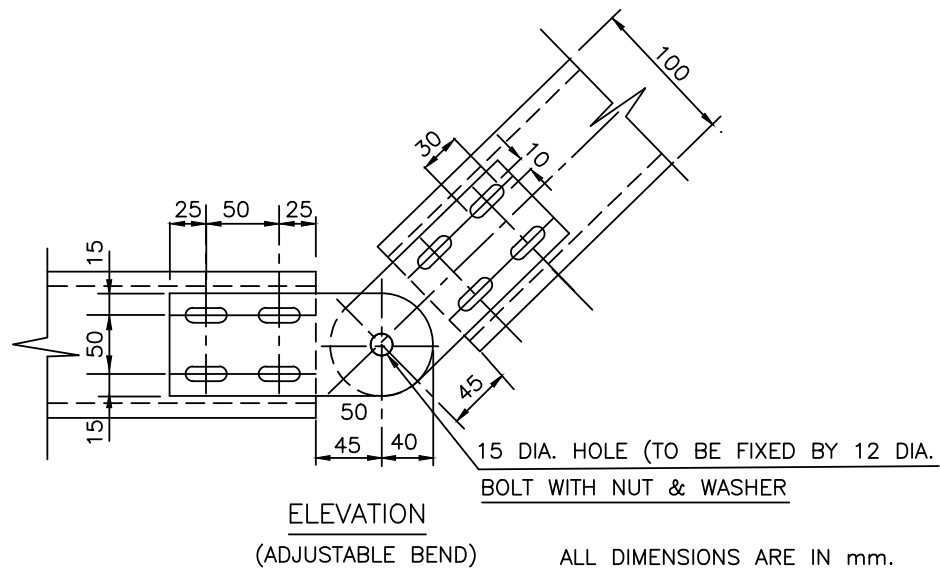
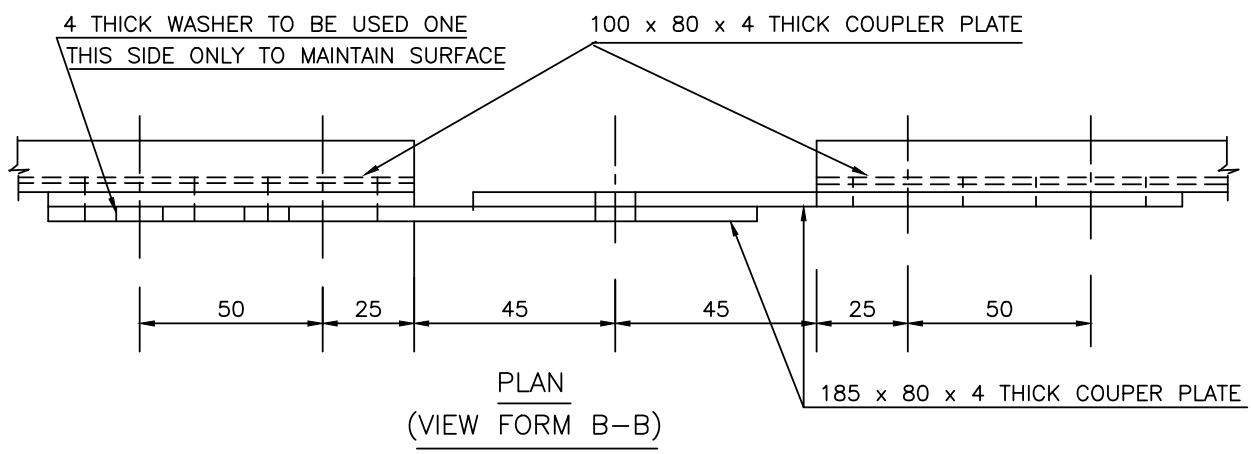
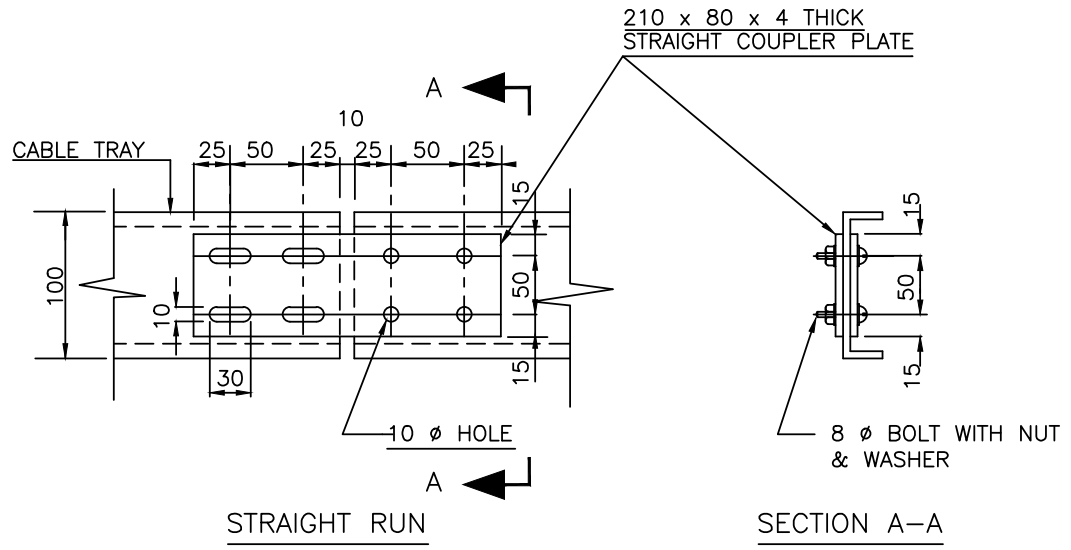

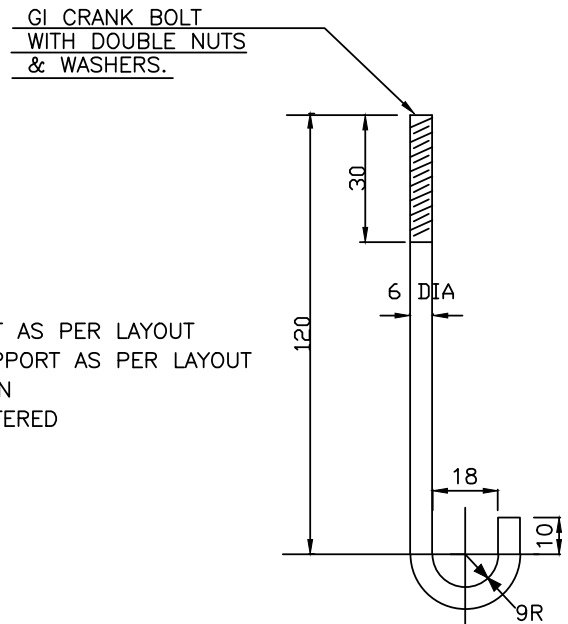
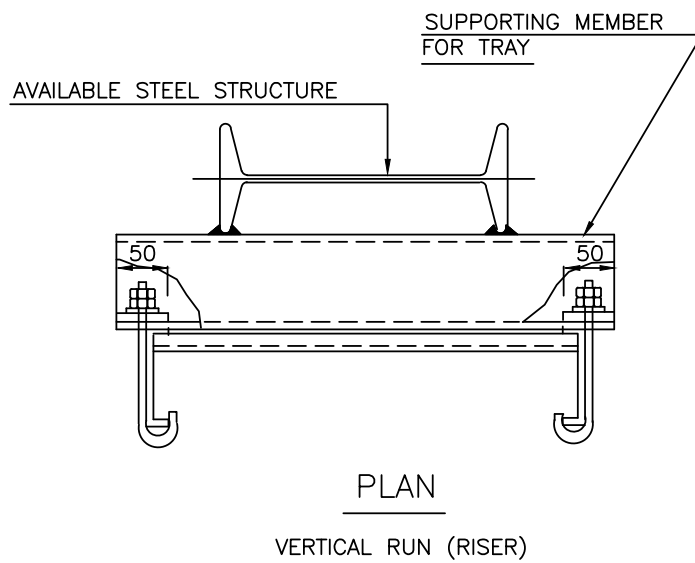
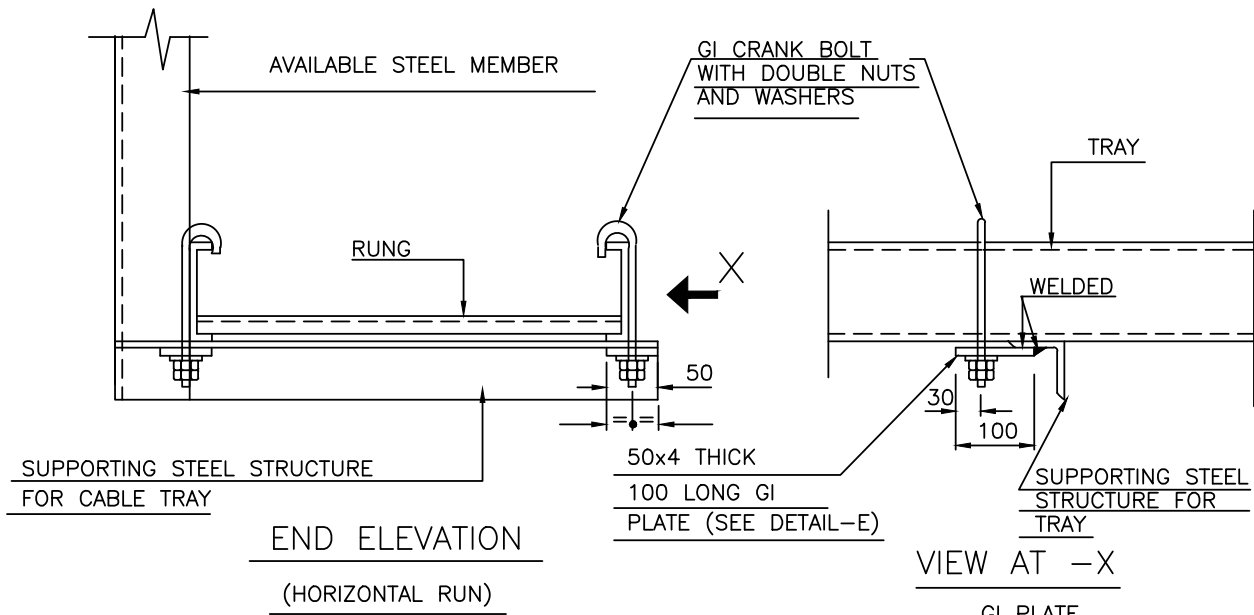

NOTES:-

1. HORIZONTAL RUN TO BE CLAMPED WITH EVERY SUPPORT AS PER LAYOUT
2. VERTICAL RUN/ RISER TO BE CLAMPED WITH EVERY SUPPORT AS PER LAYOUT
3. EACH CRANK HOOK SHALL BE SUPPLIED WITH ONE PLAIN WASHER, ONE SPRING WASHER AND TWO DOUBLE CHAMFERED HEX NUTS. THESE SHALL BE GALVANISED ITEMS.
4. ALL DIMENSIONS ARE IN mm.

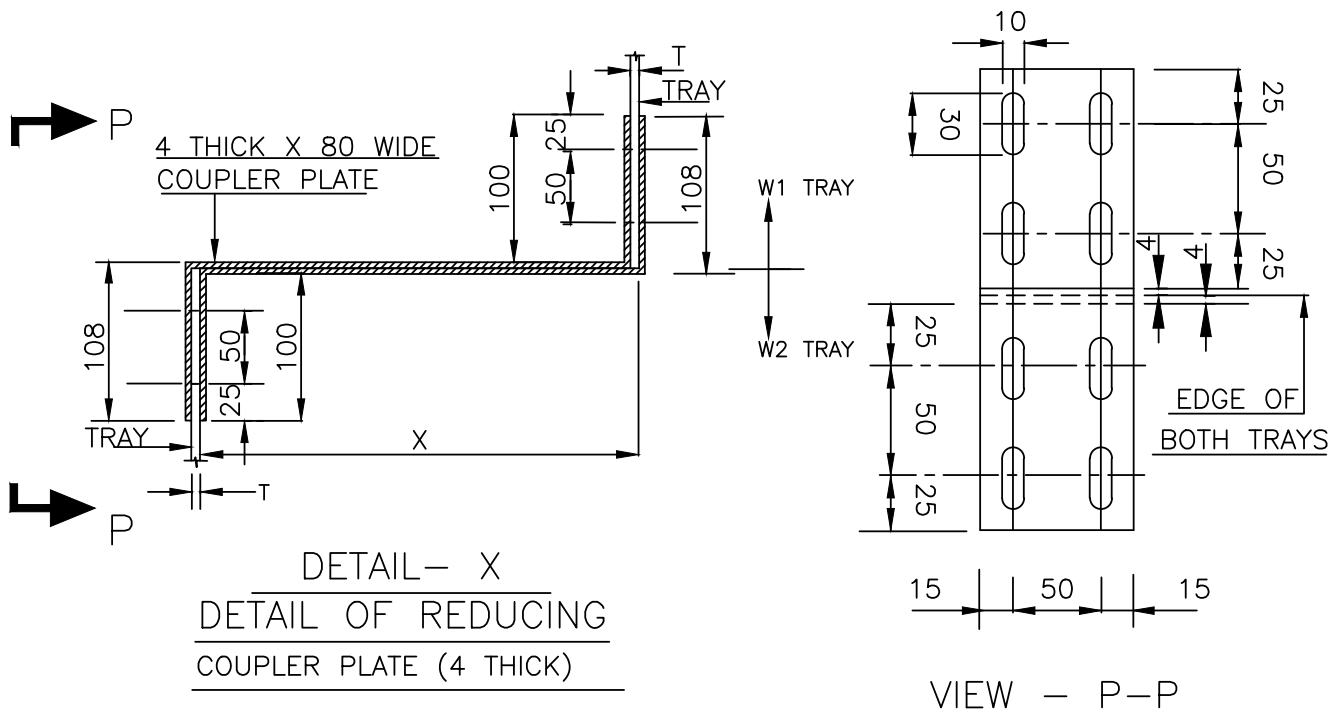
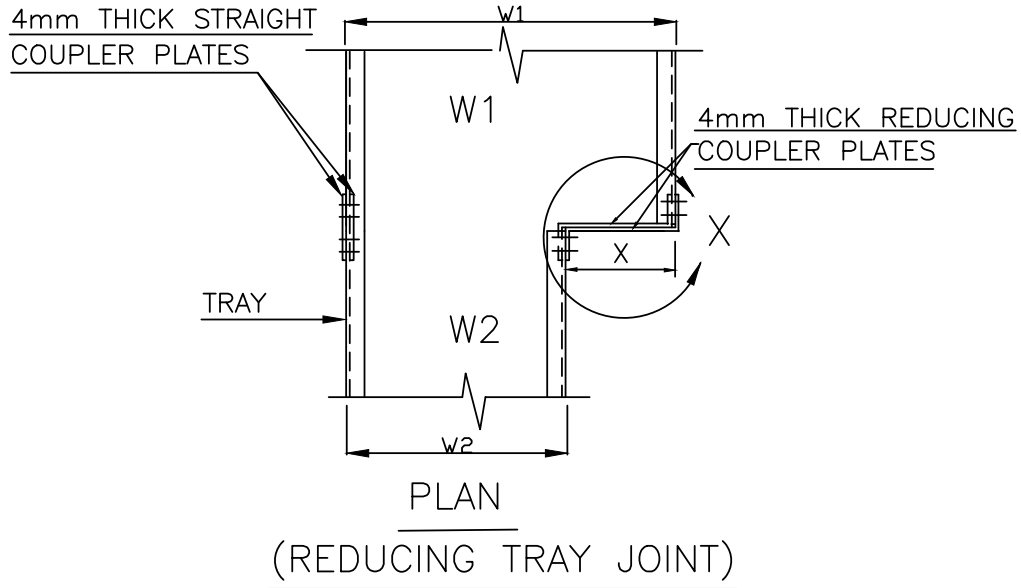

ALL DIMENSIONS ARE IN mm.

SL. NO.	W1	W2	X
1	900	600	300
		450	450
		300	600
2	600	450	150
		300	300
3	450	300	150
		150	300



GENERAL NOTES ON EARTHING AND LIGHTNING PROTECTION

PDSE: 601	0
DOCUMENT NO.	REV
SHEET 1 OF 2	

A. GENERAL

1. EARTHING AND LIGHTNING PROTECTION SHALL BE CARRIED OUT IN ACCORDANCE WITH IS : 3043 AND IS : 2309 RESPECTIVELY AND SHALL ALSO CONFORM TO THE REQUIREMENTS OF INDIAN ELECTRICITY RULES.
2. THESE NOTES SHALL BE READ IN CONJUNCTION WITH EARTHING & LIGHTNING PROTECTION LAYOUT DRGS. AND RELEVANT EARTHING STANDARDS (PDSE)
3. THE SIZE OF EARTH CONDUCTORS & SYMBOLS SHOWN IN THE LAYOUT DRGS. SHALL AS PER PDSE: 602
4. AS FAR AS POSSIBLE, THE EARTH CONDUCTORS SHALL BE TAKEN ALONG POWER & CONTROL CABLE ROUTES.
5. EARTHING CONDUCTORS BURIED UNDER THE GROUND SHALL BE LAID ATLEAST 500 MM BELOW THE GROUND LEVEL UNLESS REQUIRED OTHERWISE, e.g FOR CROSSING ANY UNDER GROUND PIPE OR TRENCH ETC. WHERE THE EARTHING CONDUCTORS SHALL RUN AT A MINIMUM DEPTH 300 MM BELOW THE BOTTOM OF THE PIPE/TRENCH.
6. BARE ALUMINIUM CONDUCTORS SHALL NOT BE BURIED DIRECTLY UNDER THE GROUND.
7. TAPPING FROM THE UNDER GROUND EARTH GRID SHALL BE TAKEN ONLY FROM EARTH PIT OR A PIT WITHOUT ELECTRODE PROVIDED FOR THIS PURPOSE.
8. JOINTING OF UNDERGROUND EARTHING STRIPS SHALL BE AVOIDED TO THE EXTENT POSSIBLE. HOWEVER, IF JOINTING IS TO BE DONE DUE TO UNAVOIDABLE REASONS, THIS SHALL BE DONE BY ELECTRIC ARC WELDING.
9. TERMINAL JOINTING & CLAMPING ARRANGEMENT SHALL BE AS SHOWN IN PDSE:603. ALL WELDED OR BOLTED JOINTS SHALL BE PAINTED WITH EPOXY RESIN PAINT OR BITUMINOUS PAINT.
10. EARTH BUSES, AS PER CONVENIENCE, SHALL BE PROVIDED IN PLANTS FOR EARTHING GROUPS OF EQUIPMENT TO EARTHING GRID. THESE EARTH BUSES, SHALL BE AS SHOWN IN PDSE: 615.
11. DETAILS OF EARTH PIT CONNECTIONS & ACCESSORIES FOR EARTH ELECTRODES SHALL BE AS SHOWN IN PDSE :604, 605 , 610 AND 611.
12. EARTH PITS FOR EQUIPMENT EARTHING, SYSTEM NEUTRAL EARTHING & LIGHTNING PROTECTION SHALL BE SEPARATE. HOWEVER, THESE PITS SHALL BE INTERCONNECTED.
13. SPACING BETWEEN TWO EARTH PITS SHALL NOT BE LESS THAN 10 M & THESE MAY BE LOCATED ABOUT 4M AWAY FROM THE BUILDING / STRUCTURE.
14. TYPICAL ARRANGEMENT OF NEUTRAL & EQUIPMENT EARTHING SHALL BE AS SHOWN IN PDSE: 617.

B. SYSTEM NEUTRAL EARTHING

1. THE NEUTRALS OF H.T & L.T SYSTEMS SHALL BE EARTHED BY USING 2 NOS. 150 SQ. MM ALUMINIUM CABLE OF RESPECTIVE VOLTAGE GRADE. EACH EARTH CONNECTION SHALL BE TERMINATED ON SEPERATE EARTH PITS. HOWEVER, FOR ECONOMY REASONS, 2 EARTH CONNECTIONS OF 2 DIFFERENT EQUIPMENT CAN BE TERMINATED ON THE SAME EARTH PIT AS SHOWN IN PDSE: 617.
2. THE NEUTRAL OF H.T. SYSTEM SHALL BE CONNECTED TO EARTH PIT AS ABOVE THROUGH THE NEUTRAL EARTHING RESISTOR (N.E.R.) AS REQUIRED, WHERE AS THE NEUTRAL OF L.T. SYSTEM SHALL BE SOLIDLY EARTHED THROUGH RESPECTIVE L.T. SWITCH BOARD.
3. FOR D.C. SYSTEM, POSITIVE POLE SHALL BE EARTHED THROUGH HIGH IMPEDANCE IN BATTERY CHARGER.

C. ELECTRICAL EQUIPMENT EARTHING

1. ALL EQUIPMENT RATED ABOVE 250V SHALL HAVE TWO EXTERNAL EARTH CONNECTIONS & THOSE RATED 250V & BELOW SHALL HAVE ONE EXTERNAL EARTH CONNECTION.
FLAME PROOF EQUIPMENT, IN ADDITION, SHALL HAVE ONE INTERNAL EARTH CONNECTION THROUGH ADDITIONAL CORE OF POWER / CONTROL CABLE.

0	03.01.07	15.01.07	ISSUED FOR IMPLEMENTATION			
REV	REV.DATE	EFF.DATE	PURPOSE	PREPD	REVWD	APPD



GENERAL NOTES ON EARTHING AND LIGHTNING PROTECTION

PDSE: 601	0
DOCUMENT NO.	REV
SHEET 2 OF 2	

- EARTHING CONNECTION TO INDIVIDUAL EQUIPMENT SHALL BE TAPPED ONLY FROM THE EARTHING GRID / RING OR EARTH BUS EXCEPT FOR EQUIPMENT RATED 250V & BELOW, FOR WHICH THE CONNECTION MAY BE TAKEN FROM THE NEAR BY EARTH CONDUCTOR OF A LARGER EQUIPMENT OR FROM THE BODY OF THE LARGER EQPT.
- EARTHING ARRANGEMENT OF MOTOR AND ASSOCIATED LOCAL CONTROL STATION SHALL BE AS SHOWN IN PDSE: 608.
- EARTHING ARRANGEMENT OF RAILS SHALL BE AS SHOWN IN PDSE: 609 WITH BOTH ENDS EARTHED.
- CABLES RACKS/RISERS/TRAYS SHALL BE ELECTRICALLY CONTINUOUS BY BONDING THE JOINTS BETWEEN THE RUNNER MEMBERS OF THE ADJACENT SECTIONS. THE CABLE RACKS SHALL BE CONNECTED TO THE EARTHING GRID AT SUITABLE INTERVALS.
- EARTHING ARRANGEMENT OF LIGHTING FIXTURES & PLUG SOCKETS RATED 250V AND BELOW SHALL NOT BE SHOWN IN THE EARTHING LAYOUT DRGS. HOWEVER, PLUG SOCKETS SHALL BE EARTHED BY 10 SWG SIZE G.I./AL. CONDUCTOR TAKEN FROM THE NEAREST EARTHING GRID/CONDUCTOR AND LIGHTING FIXTURES SHALL BE PROVIDED EARTHING THROUGH CABLE ARMOURS.
- IN SWITCH YARD AND GENERATING STATIONS SUITABLE EARTHING MAT SHALL BE PROVIDED TO REDUCE THE VALUE OF STEP/TOUCH POTENTIAL TO PERMISSIBLE VALUE.
- SWITCH YARD FENCE SHALL BE CONNECTED TO EARTH AT A REGULAR INTERVAL, NOT EXCEEDING 10 M.

D. STATIC EARTHING

- ALL PROCESS EQUIPMENT WHICH ARE LIKELY TO GET STATICALLY CHARGED, e.g. STORAGE TANKS, HIGH PRESSURE & MEDIUM PRESSURE VESSELS/PIPES, HIGH PRESSURE COMPRESSORS. HIGH PRESSURE STEAM EJECTORS ETC. SHALL BE EARTHED AGAINST STATIC CHARGE ACCUMULATION.
- EARTHING ARRANGEMENT ACROSS PIPE JOINTS/VALVES SHALL BE AS SHOWN IN PDSE: 612
- DETAILS OF EARTHING OF VESSELS SHALL BE AS SHOWN IN PDSE: 613.
- MOBILE EQUIPMENT, REQUIRING EARTHING AGAINST STATIC CHARGE, SHALL BE TEMPORARILY EARTHED AS SHOWN IN PDSE: 608.
- PIPE TRESTLE CARRYING PIPES WITH HYDRO CARBONS SHALL BE CONNECTED TO EARTH GRID AT REGULAR INTERVALS, NOT EXCEEDING 25 M.
- WHEREVER PROCESS EQUIPMENT ARE MOUNTED ON STEEL STRUCTURE, THE BASE OF THE STRUCTURES SHALL BE EARTHED INSTEAD OF EARTHING THE INDIVIDUAL EQUIPMENT.

E. LIGHTNING PROTECTION

- FIXING ARRANGEMENT ON AIR TERMINATION AND ROOF/DOWN CONDUCTOR FOR LIGHTNING PROTECTION SYSTEM SHALL BE AS SHOWN IN PDSE: 614.
- FOR LIGHTNING PROTECTION OF TALL STEEL STRUCTURES/VESSELS/TANKS, DOWN CONDUCTOR SHALL BE TAKEN FROM THE BASE AND CONNECTED TO EARTH PITS. AIR TERMINATION ROD SHALL NOT BE REQUIRED.
- LIFT SHAFT SHALL NOT BE USED FOR FIXING THE DOWN CONDUCTOR.
- IN CASE EARTH PITS FOR CONNECTING THE DOWN CONDUCTORS ARE NOT AVAILABLE IN THE BEGINNING OF FABRICATION/ERECTION OF SUCH STRUCTURES/VESSELS / TANKS. THEIR BASES SHALL TEMPORARILY BE CONNECTED TO NEAR BY STEEL COLUMN. ELECTRICAL CONTINUITY OF THE STRUCTURES, HOWEVER, SHALL BE CHECKED AND ENSURED.
- FOR ALL HIGH RISE CONCRETE STRUCTURES, TEMPORARY LIGHTNING PROTECTION NEED BE PROVIDED DURING CONSTRUCTION AND MAINTAINED TILL PERMANENT LIGHTNING PROTECTION IS INSTALLED. FOR THIS PURPOSE THE VERTICAL REINFORCEMENT, PROJECTING OVER EACH LIFT, SHALL BE CONNECTED TO EARTH PITS BY MEANS OF 2 NOS. FLEXIBLE COPPER CONDUCTOR CABLES. EACH OF THE FLEXIBLE CABLE SHALL BE OF 95 Sq. mm SIZE HAVING ONE END PERMANENTLY CONNECTED TO EARTH PIT AND OTHER END PROVIDED WITH A CLAMP FOR CONNECTING TO THE EXPOSED REINFORCEMENT.

0	03.01.07	15.01.07	ISSUED FOR IMPLEMENTATION	<i>US</i> NKR	<i>Amul</i> AV	<i>BB</i> BB
REV	REV.DATE	EFF.DATE	PURPOSE	PREPD	REVWD	APPD

SL. No.	EQUIPMENT TO BE EARTHED	FAULT LEVEL (MVA)	G.I. STRIPS/WIRES		ALUMINIUM			REMARKS			
			MIN. SIZE (mm ²)	SIZE TO BE USED (mm ²)	SYMBOL	MIN. SIZE (mm ²)	STRIPS/WIRES SIZE TO BE USED (mm ²)		SYMBOL		
1A.	FOR PLANTS HAVING SWITCHYARDS/ GENERATING STATION										
I.	SWITCH YARD EQUIPMENT, GENERATORS, H.T. SWITCH BOARDS, TRANSFORMERS, MAIN EARTHING GRID, CONNECTION FROM EARTH BUS TO EARTHING GRID.	750 AT 11KV	706	2-50x8	2	491	2-38.1x6.35=484	2	500	21	AS PER CLAUSE 17.3.2 OF IS:3043
II.	SWITCH YARD EQUIPMENT, GENERATORS, H.T. SWITCH BOARDS, TRANSFORMERS, MAIN EARTHING GRID, CONNECTION FROM EARTH BUS TO EARTHING GRID.	500 AT 11KV 300 AT 6.6KV 150 AT 3.3KV	471	60x8	1	328	50.8x6.35=323	11	400	22	-D0-
III.	SWITCH YARD EQUIPMENT, GENERATORS, H.T. SWITCH BOARDS, TRANSFORMERS, MAIN EARTHING GRID, CONNECTION FROM EARTH BUS TO EARTHING GRID.	250 AT 6.6KV 125 AT 3.3KV	392	50x8	2	272	50.8x6.35=323	11	300	23	-D0-
IV.	SWITCH YARD EQUIPMENT, GENERATORS, H.T. SWITCH BOARDS, TRANSFORMERS, MAIN EARTHING GRID, CONNECTION FROM EARTH BUS TO EARTHING GRID.	350 AT 11KV 200 AT 6.6KV 100 AT 3.3KV	330 314 314	50x8	2	229 218 218	38.1x6.35=242	12	240	24	-D0-
V.	SWITCH YARD EQUIPMENT, GENERATORS, H.T. SWITCH BOARDS, TRANSFORMERS, MAIN EARTHING GRID, CONNECTION FROM EARTH BUS TO EARTHING GRID.	250 AT 11KV 150 AT 6.6KV 75 AT 3.3KV	235	50x6	3	163	31.75x4.78=152	13	185	25	-D0-
1B	FOR PLANTS WITHOUT SW. YARD/GENERATING STN. H.T. SWITCH BOARDS, TRANSFORMERS, MAIN EARTHING GRID, CONNECTION FROM EARTH BUS TO EARTHING GRID.	ANY FAULT LEVEL AT ANY VOLTAGE	210	50x6	3	120	38.1x3.18=121	14	120	27	AS PER CLAUSE 12.3.2 OF IS:3043
1C	ALL M.V. SWITCH BOARDS		210	50x6	3	120	38.1x3.18=121	14	120	27	AS PER CLAUSE 12.3.2 OF IS:3043
2	H.V. MOTORS		210	50x6	3	120	38.1x3.18=121	14	120	27	-D0-
3	TRANSFORMER NEUTRALS		-	-	-	120	-	-	150	26	-
4	M.V. MOTORS RATED 75KW & ABOVE		210	50x6	3	120	38.1x3.18=121	14	120	27	AS PER CLAUSE 12.3.2 OF IS:3043
5	M.V. MOTORS ABOVE 30KW & LESS THAN 75KW		175	35x6	4	93	31.75x3.18=101	15	95	28	-D0-

SL. No.	EQUIPMENT TO BE EARTHED	FAULT LEVEL (MVA)	G.I. STRIPS/WIRES		ALUMINIUM STRIPS/WIRES			REMARKS			
			MIN. SIZE (mm ²)	SIZE TO BE USED (mm ²)	SYMBOL	MIN. SIZE (mm ²)	SIZE TO BE USED (mm ²)		SYMBOL		
6	M.V.MOTORS ABOVE 5.5KW & LESS THAN 30KW 63A SW.SOCKETS,BATTERY CHARGERS,LIGHTING SUB-DIST.BDS.,D.C.BDS.		44	25x6	5	25	2 SWG=38.6	17	25	29	AS PER CLAUSE 12.3.2 OF IS:3043
7	M.V.MOTORS RATED 5.5KW & BELOW		7	8 SWG=13	6	5	10 SWG=8.3	18	6	30	-D0-
8	ALL MINOR EQUIPMENT RATED FOR 250V & BELOW		-	10 SWG=8.3	7	-	10 SWG=8.3	18	6	30	
9	NON ELECTRICAL EQUIPMENT,SUCH AS VESSELS STRUCTURES IN HAZARDOUS AREA & LIGHTNING PROTECTION CONDUCTORS		32x6	35x6	4	-	25.4x3.18=81	16	-	-	AS PER IS:2309

NOTE :--EARTHING CONDUCTOR SIZES FOR ITEMS AT SL.No.4,5,6 & 7 SHOULD BE CHOSEN AS HALF THE POWER CABLE SIZES ACTUALLY USED.

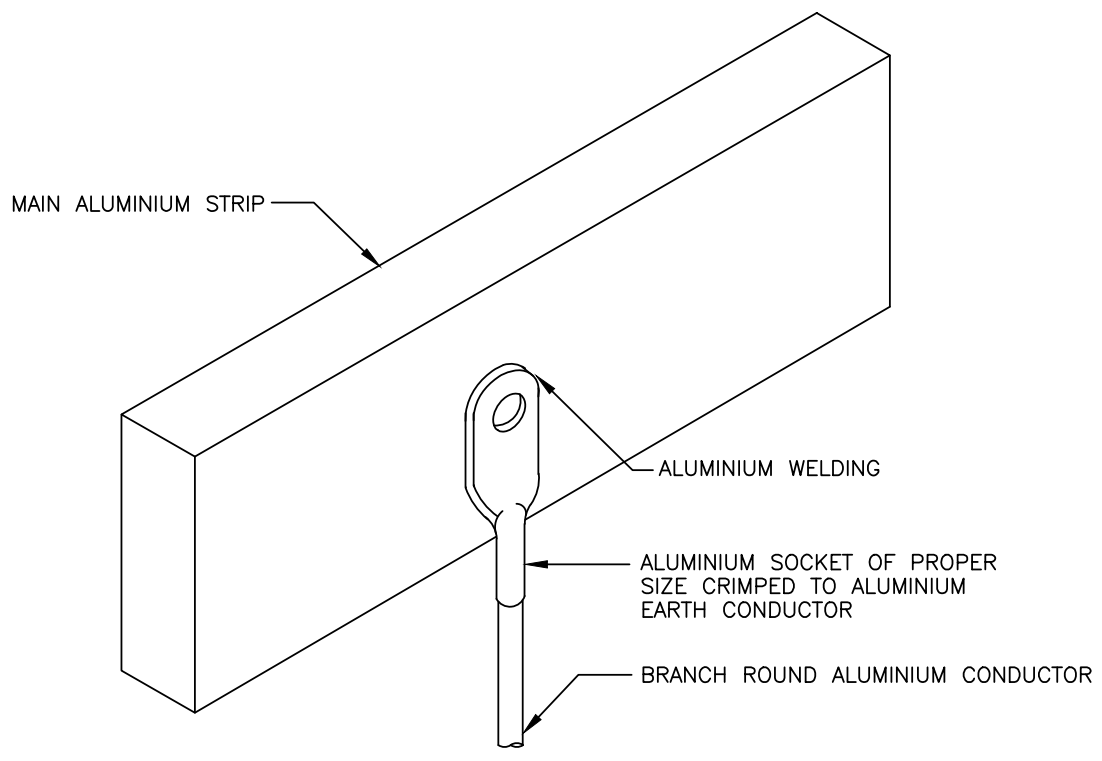

' T ' JOINT ALUMINIUM STRIP TO ROUND ALUMINIUM CONDUCTOR

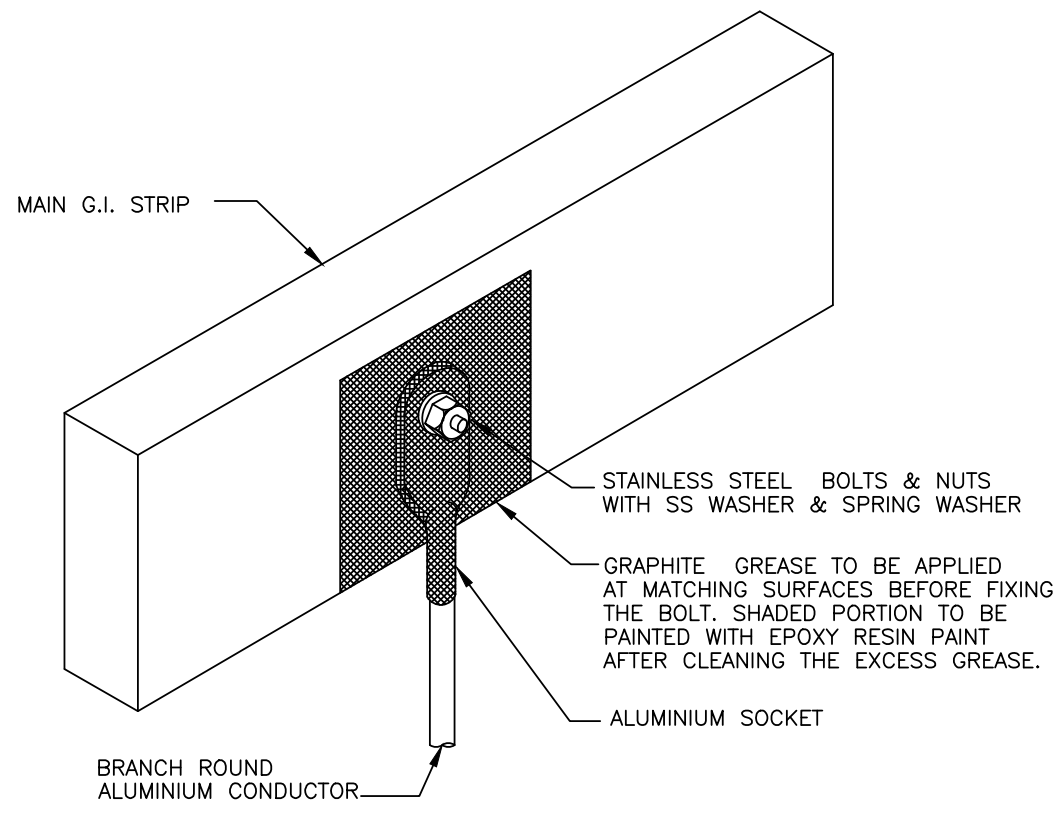

' T ' JOINT G.I. STRIP TO ROUND ALUMINIUM CONDUCTOR

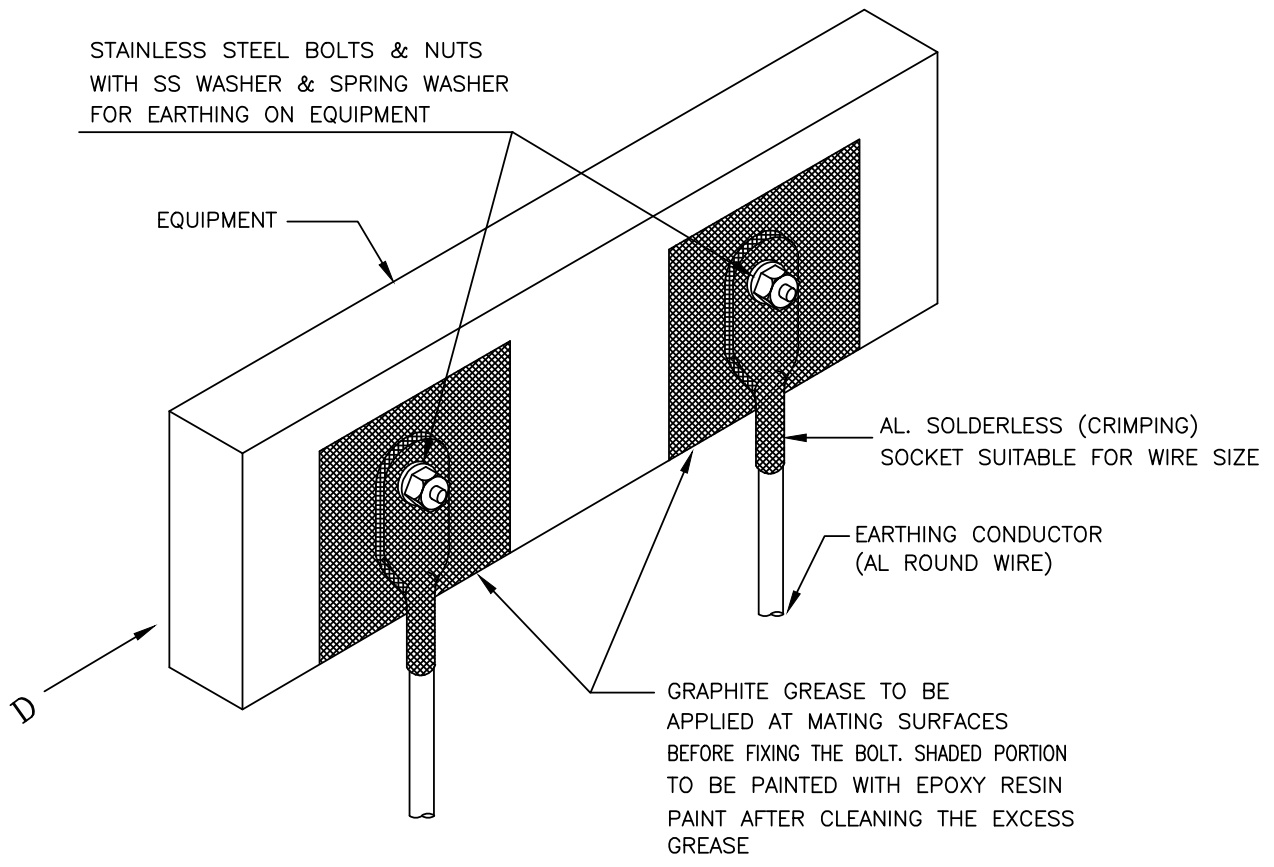

ARRANGEMENT OF DOUBLE EARTH CONNECTIONS TO EQUIPMENT

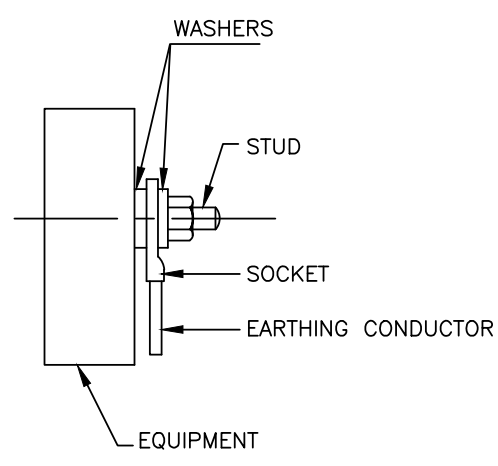

V I E W F R O M - D

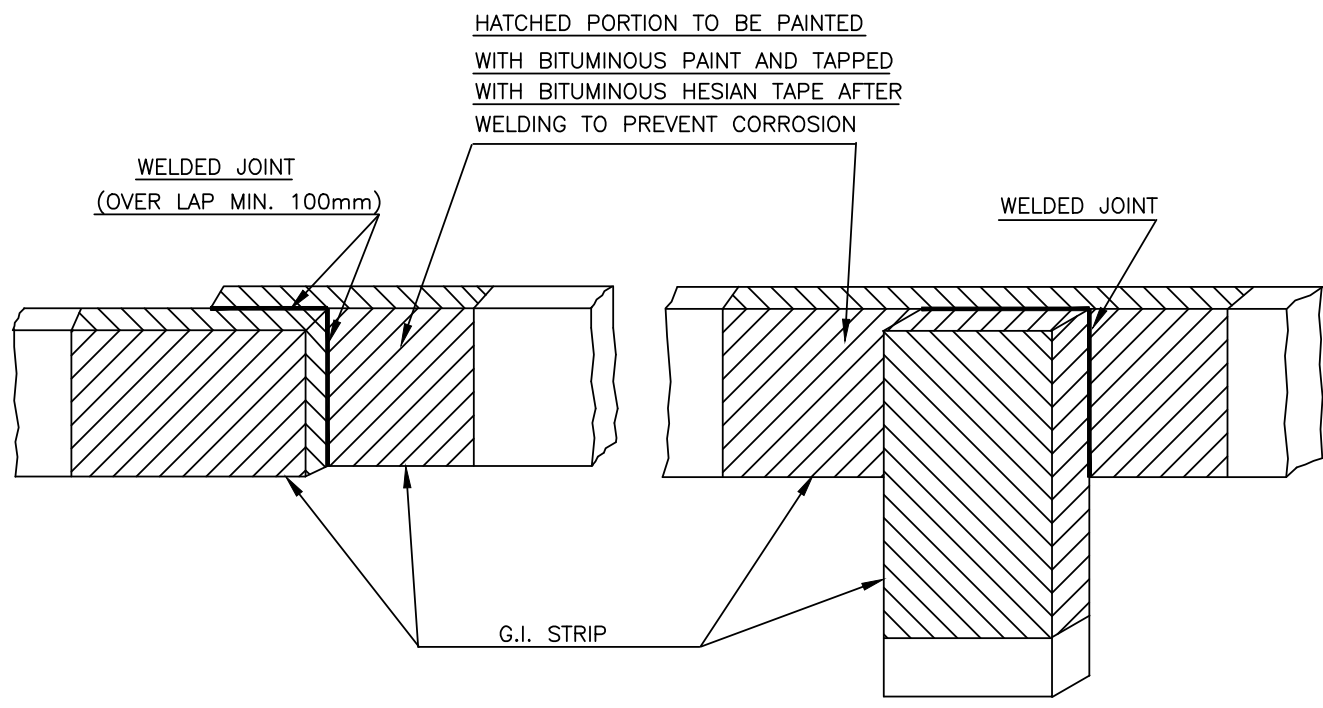

STRAIGHT JOINT G.I TO G.I. STRIP

" T " JOINT G.I. TO G.I. STRIP

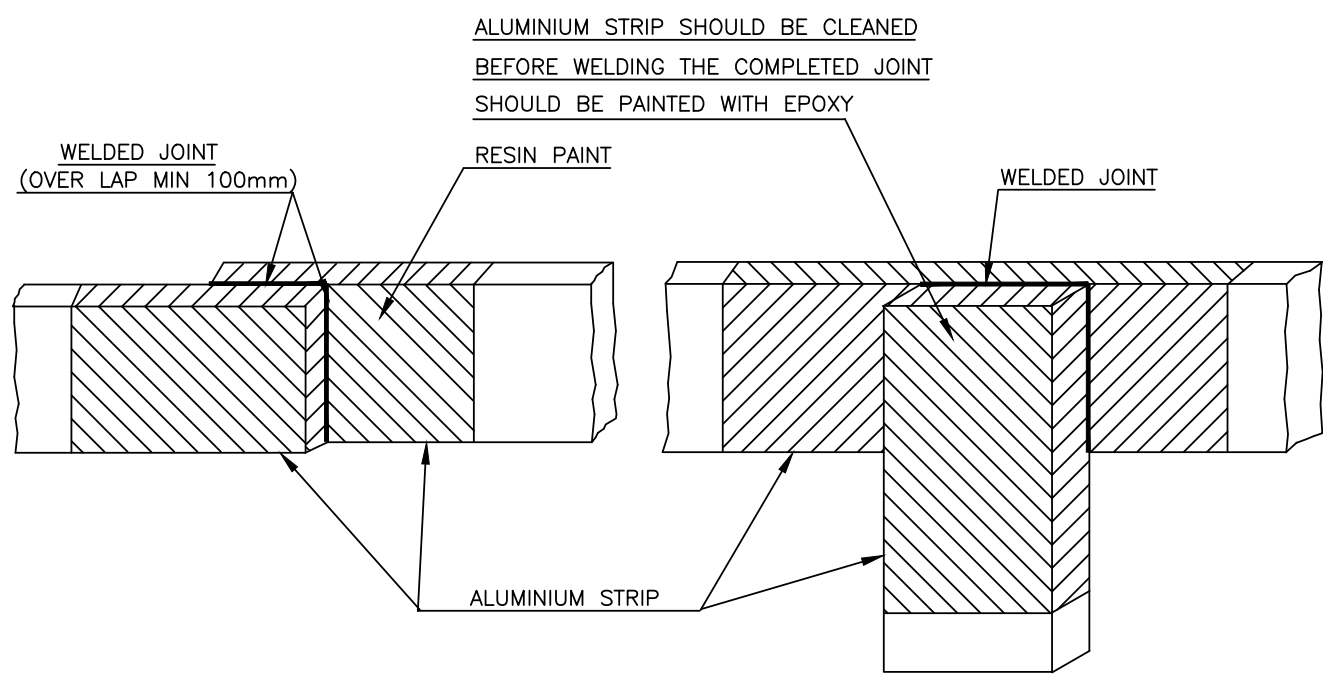

STRAIGHT JOINT AL. TO AL. STRIP

" T " JOINT AL TO AL STRIP

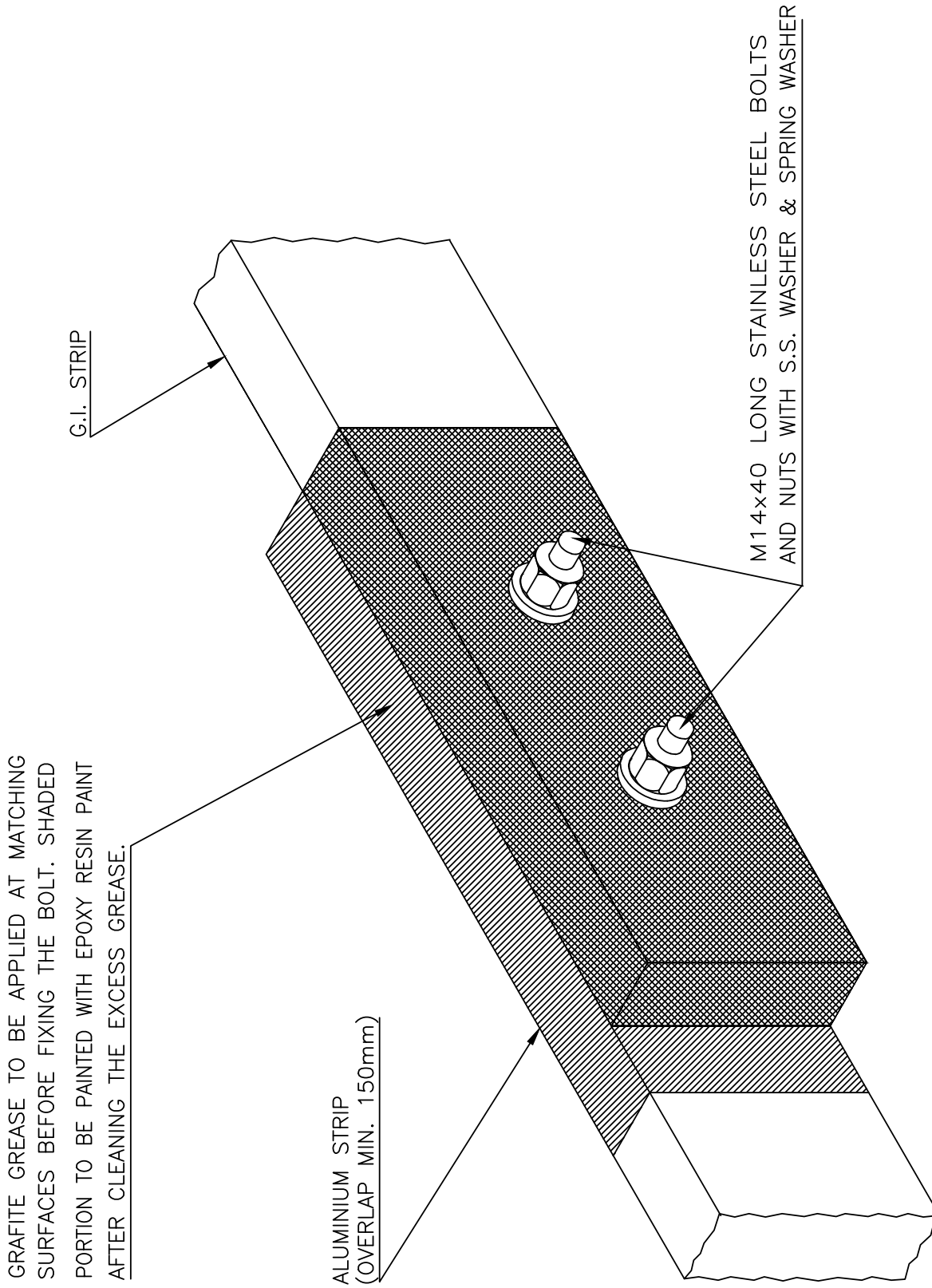

ARRANGEMENT OF LAP JOINT BETWEEN
AL. EARTH STRIP TO G.I. EARTH STRIP

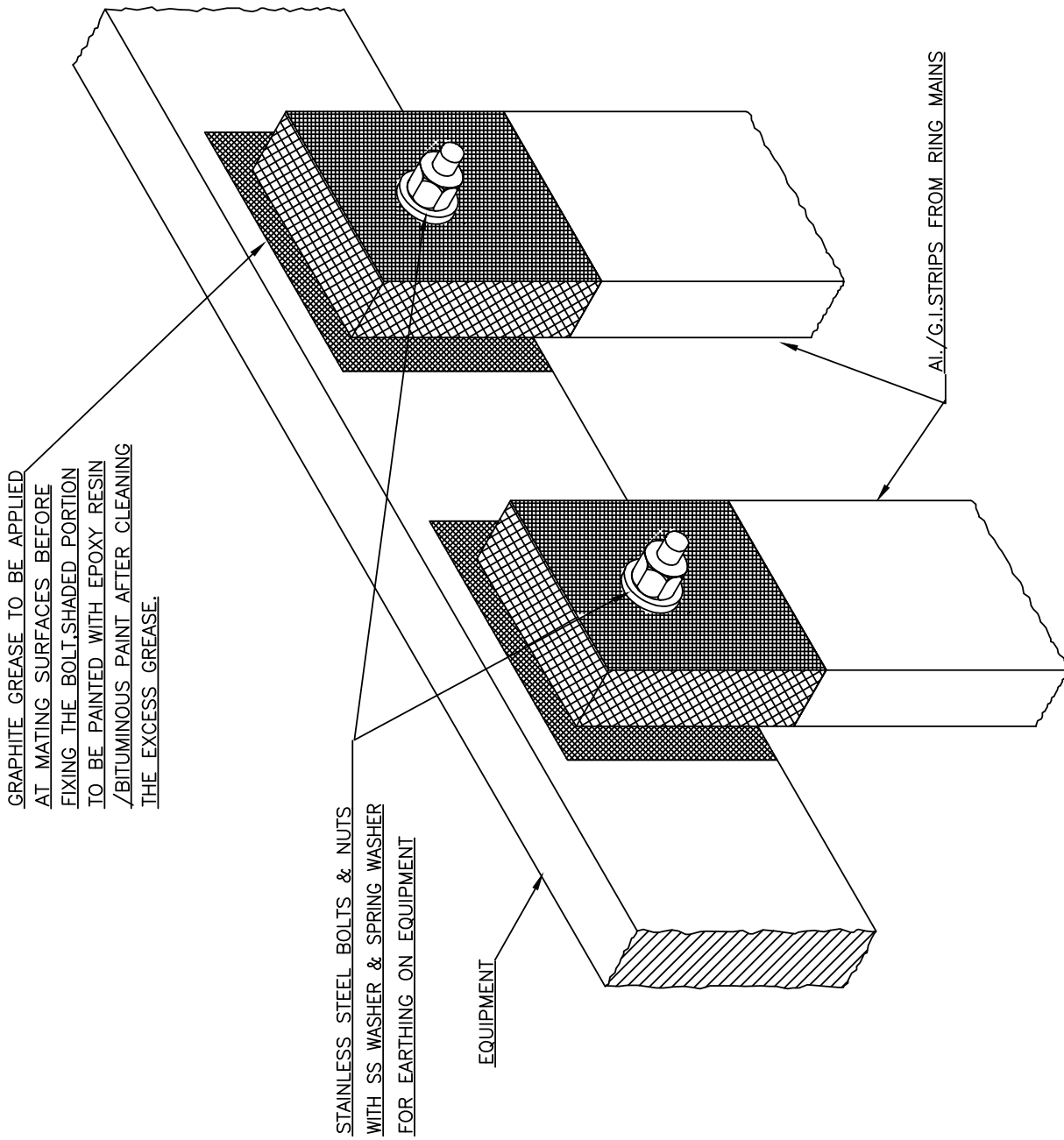

ARRANGEMENT OF DOUBLE EARTH CONNECTION ON EQUIPMENT

NOTE:-

EPOXY RESIN PAINT SHALL BE USED FOR AL STRIP AND BITUMINOUS PAINT FOR G.I. STRIP.

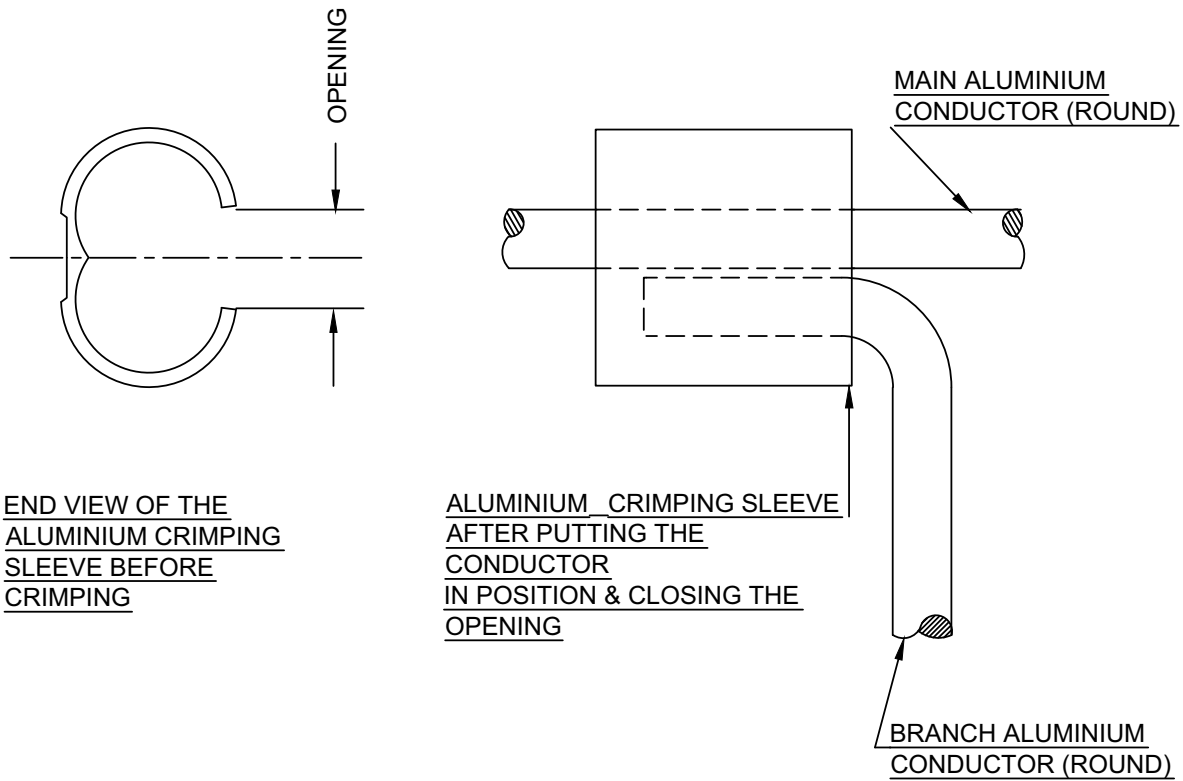

"T" JOINT ROUND ALUMINIUM CONDUCTOR TO ROUND ALUMINIUM CONDUCTOR (CRIMPING TYPE)

NOTE :-

USE CORRECT SIZE OF COMPRESSION DIES.

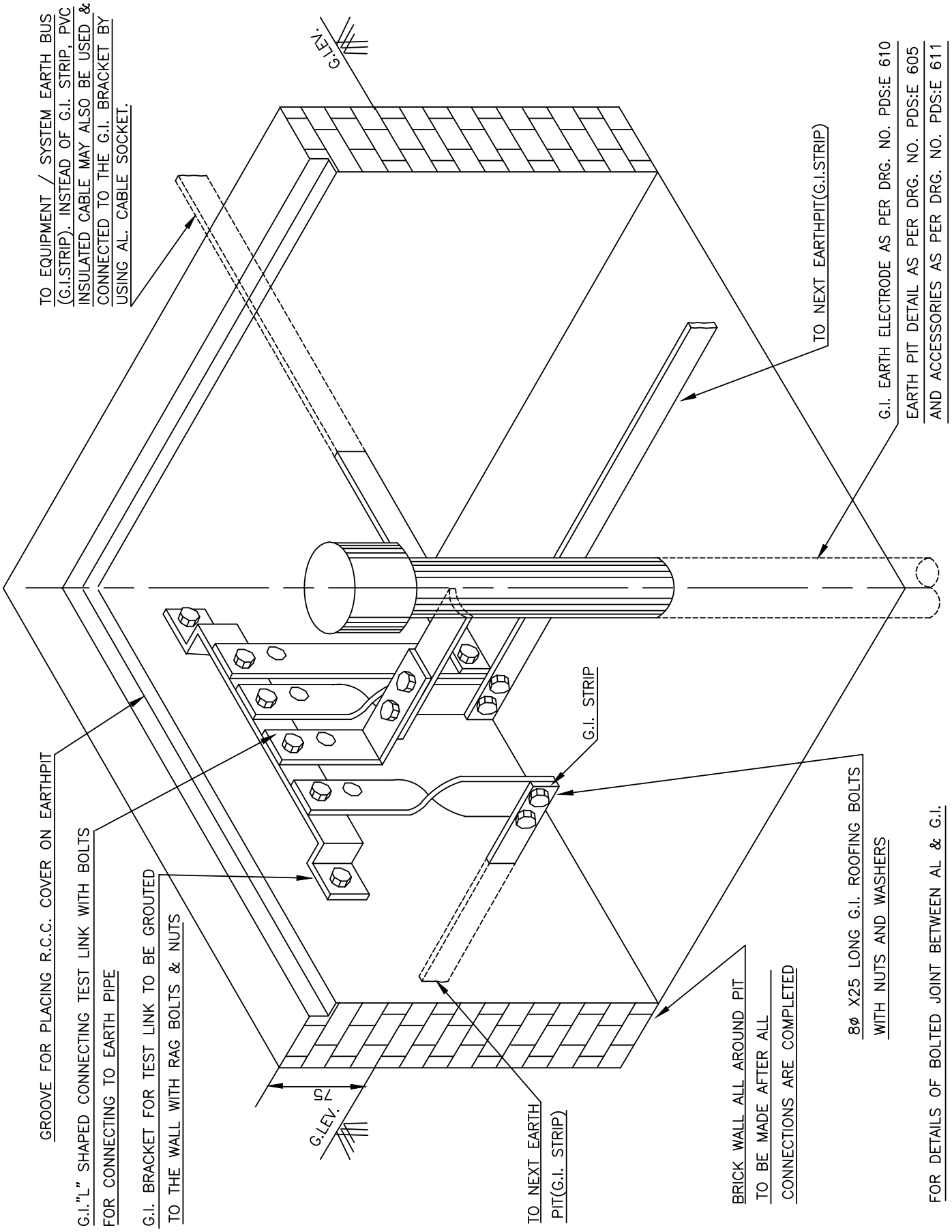

GROOVE FOR PLACING R.C.C. COVER ON EARTH PIT

G.I. "L" SHAPED CONNECTING TEST LINK WITH BOLTS FOR CONNECTING TO EARTH PIPE

G.I. BRACKET FOR TEST LINK TO BE GROUDED TO THE WALL WITH RAG BOLTS & NUTS

TO NEXT EARTH PIT (G.I. STRIP)

BRICK WALL ALL AROUND PIT TO BE MADE AFTER ALL CONNECTIONS ARE COMPLETED

8φ X25 LONG G.I. ROOFING BOLTS WITH NUTS AND WASHERS

FOR DETAILS OF BOLTED JOINT BETWEEN AL & G.I. REFER PDS:E 603 (SHEET 4 OF 6)

TO EQUIPMENT / SYSTEM EARTH BUS (G.I. STRIP). INSTEAD OF G.I. STRIP, PVC INSULATED CABLE MAY ALSO BE USED & CONNECTED TO THE G.I. BRACKET BY USING AL. CABLE SOCKET.

TO NEXT EARTH PIT (G.I. STRIP)

G.I. EARTH ELECTRODE AS PER DRG. NO. PDS:E 610
EARTH PIT DETAIL AS PER DRG. NO. PDS:E 605
AND ACCESSORIES AS PER DRG. NO. PDS:E 611

G.I. LEV.

G.I. LEV.

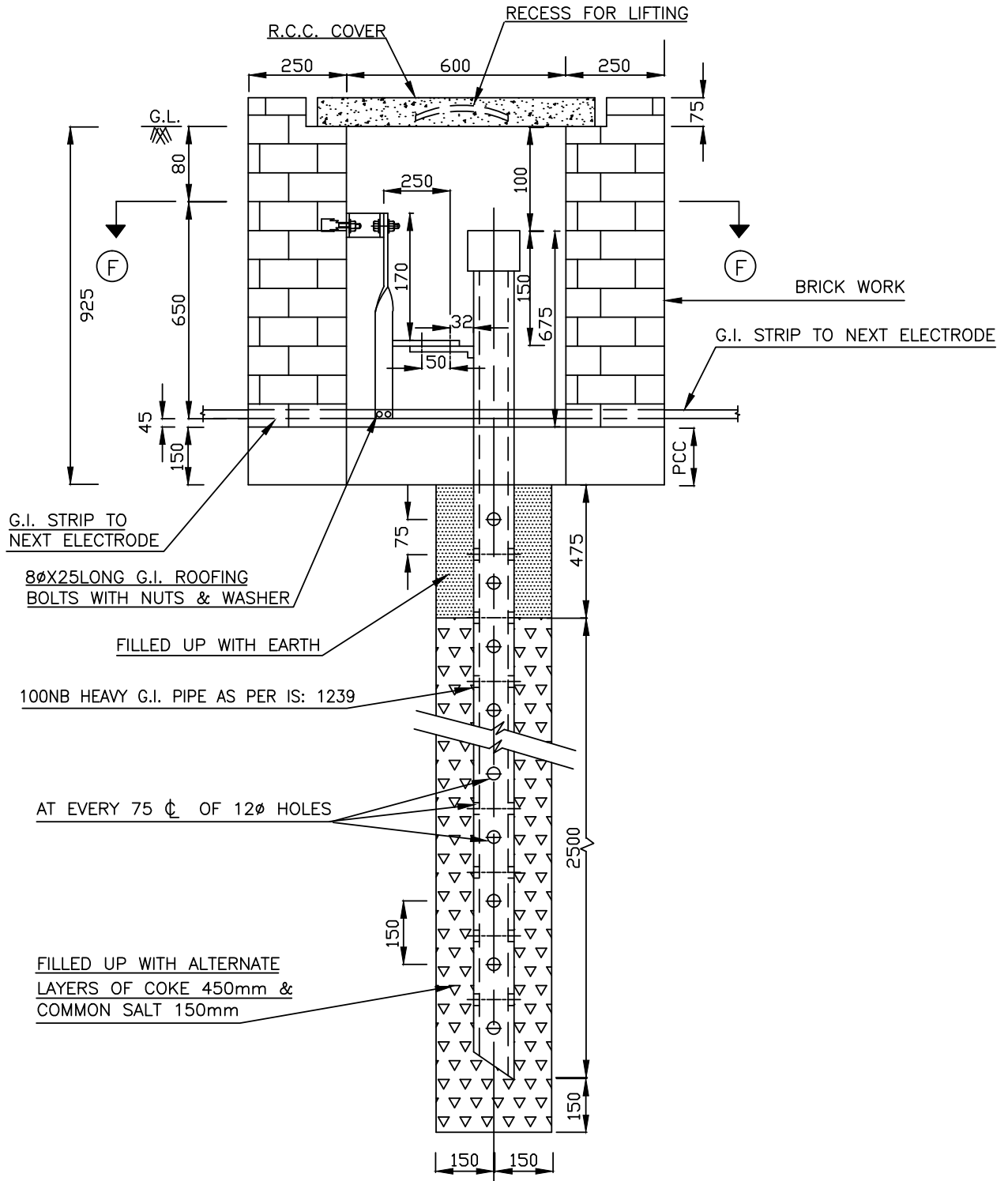

SECTIONAL ELEVATION OF EARTH PIT

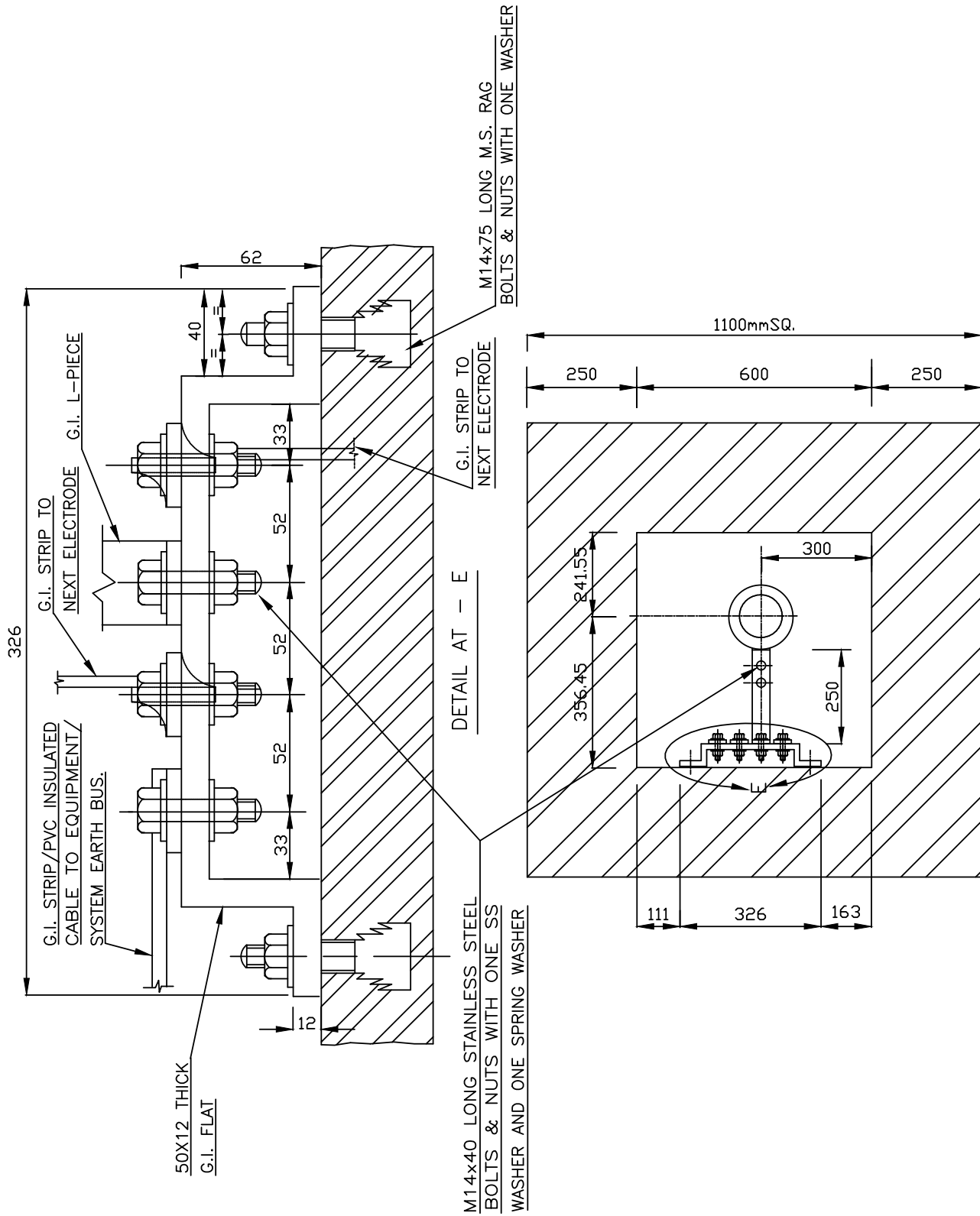

PVC INSULATED CONDUCTOR/ G.I.WIRE/
AL. WIRE FOR EARTHING OF MOTOR

2 NOS. EARTHING CONDUCTORS

POWER CABLE

CONTROL CABLE

CABLE CLAMPING
ARRANGEMENT

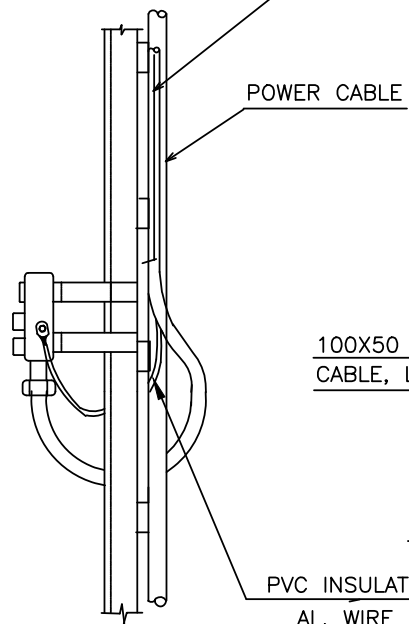

100X50 M.S CHANNEL FOR SUPPORTING
CABLE, LOCAL CONTROL STN.

HOSE PROOF/DUST PROOF
LOCAL CONTROL STN.

PVC INSULATED CONDUCTOR/G.I. WIRE/
AL. WIRE FOR EARTHING OF L.C.S.

VIEW AT-A

MOTOR TERMINAL BOX

RUBBER BUSHING

50X6 FLATS WELDED TO
THE CHANNEL @ 300
INTERVAL

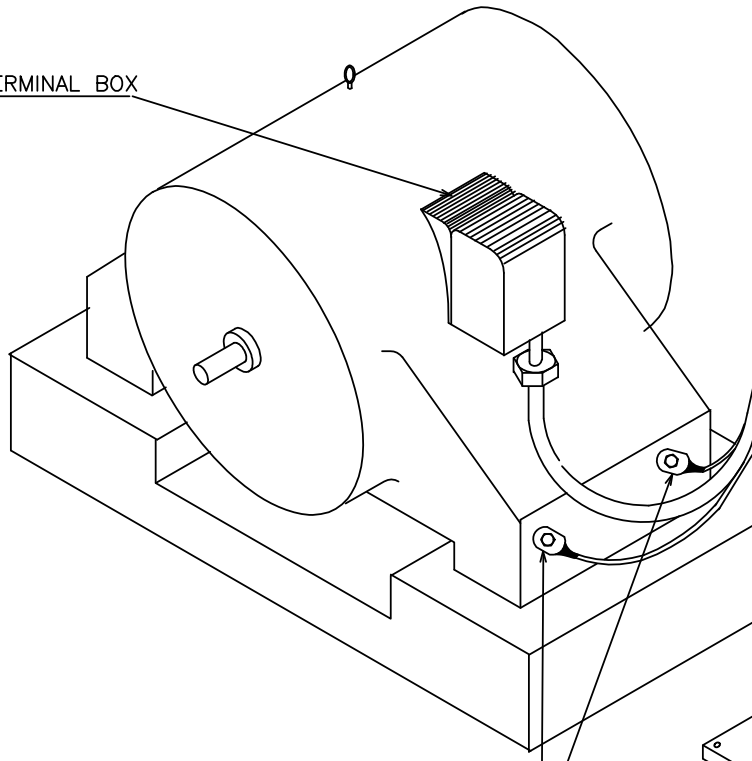

EARTH TERMINALS-TERMINATION
OF AL. CONDUCTOR THROUGH
AL. CABLE SOCKET
(FOR DETAILS REFER PDS:E 603 SH.2)

200x200x10 THCK PLATE
GROUTED FLUSHING WITH
FINISH FLOOR LEVEL

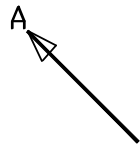

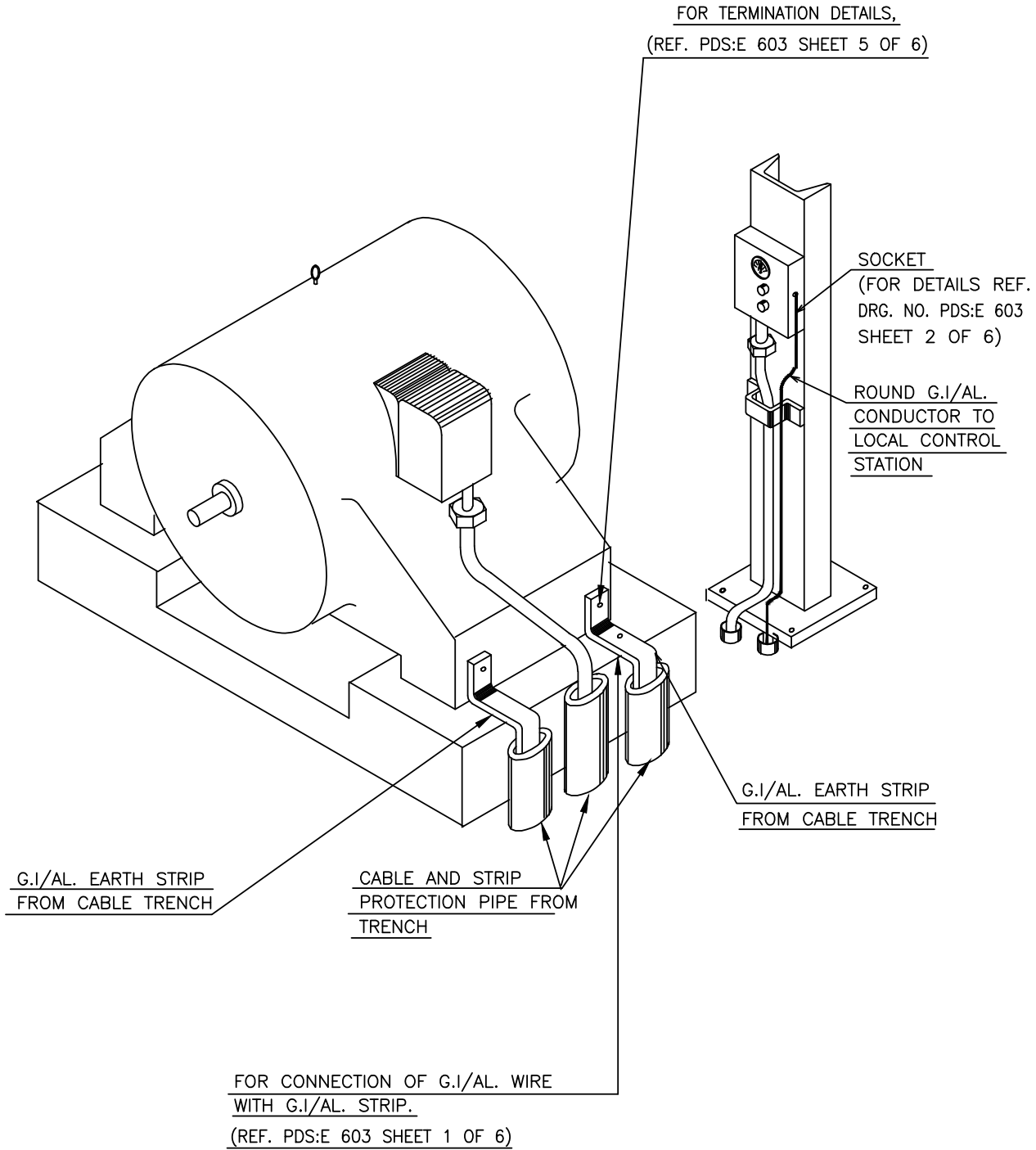

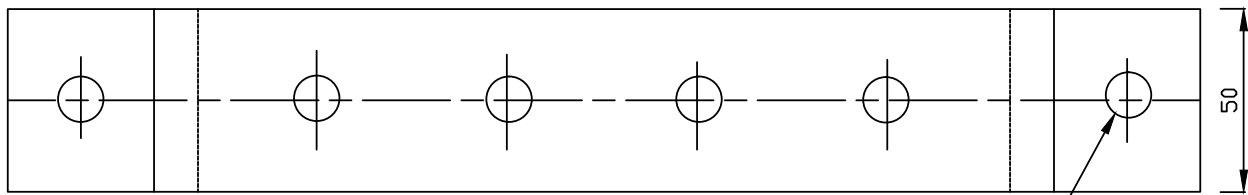
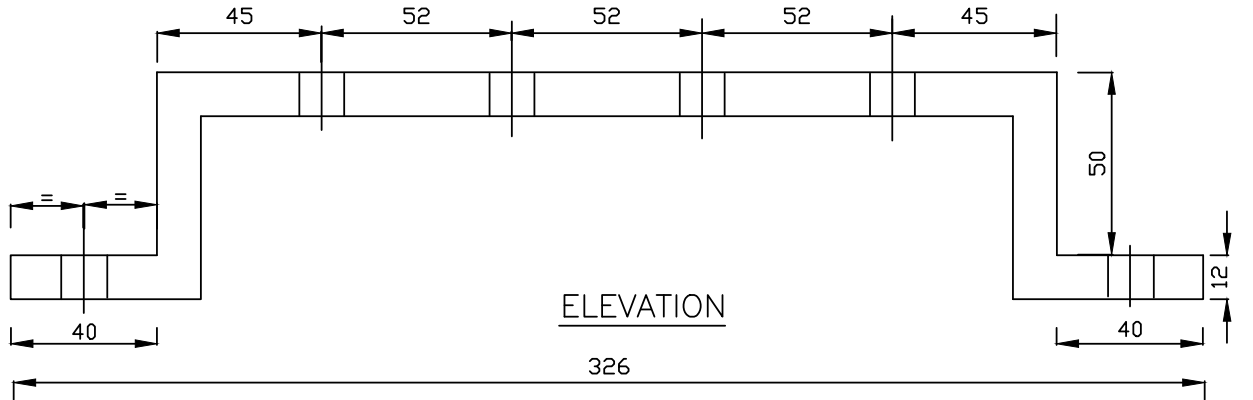

G.I. TEST LINK

HOLES SUITABLE FOR 12 ϕ (M14) BOLTS

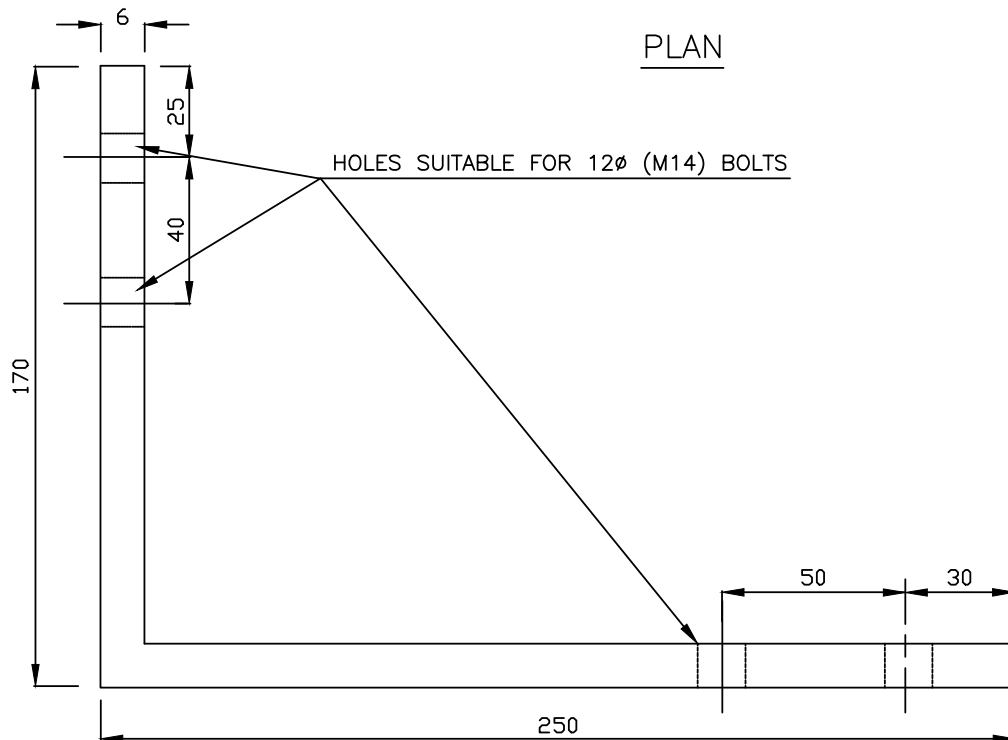
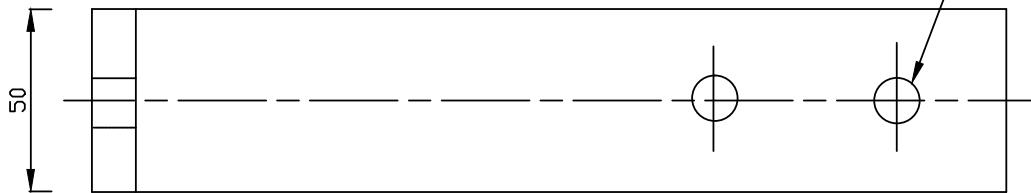

G.I. 'L' PIECE

HOLES SUITABLE FOR 12 ϕ (M14) BOLTS

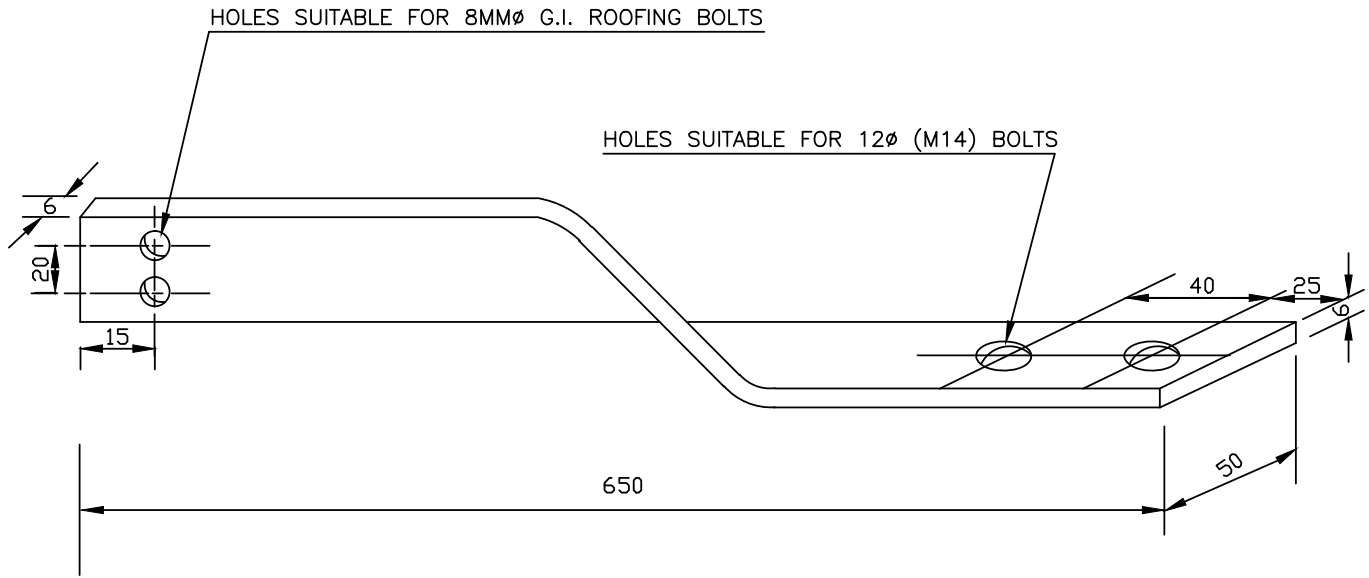

CONNECTING TWISTED ALUMINIUM FLAT PIECE

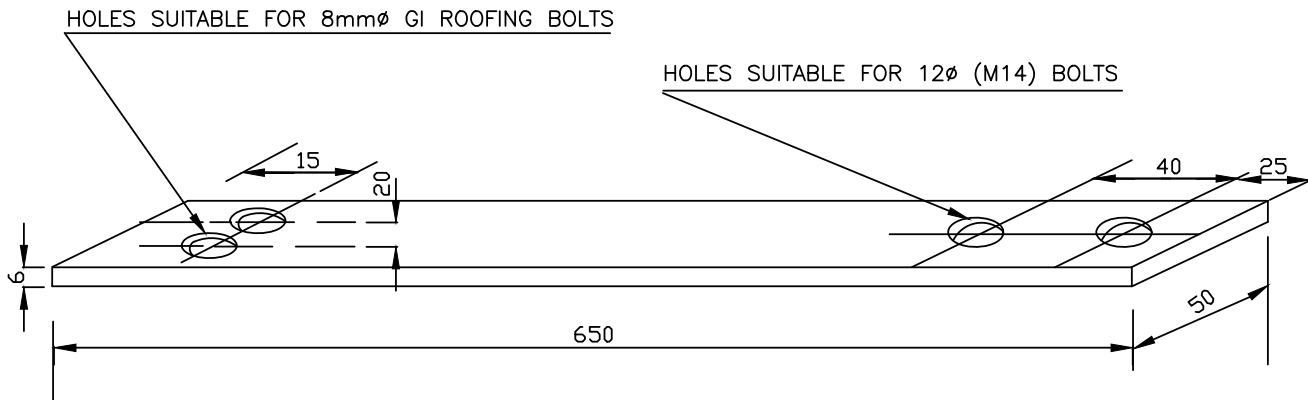

CONNECTING ALUMINIUM / G.I. FLAT PIECE

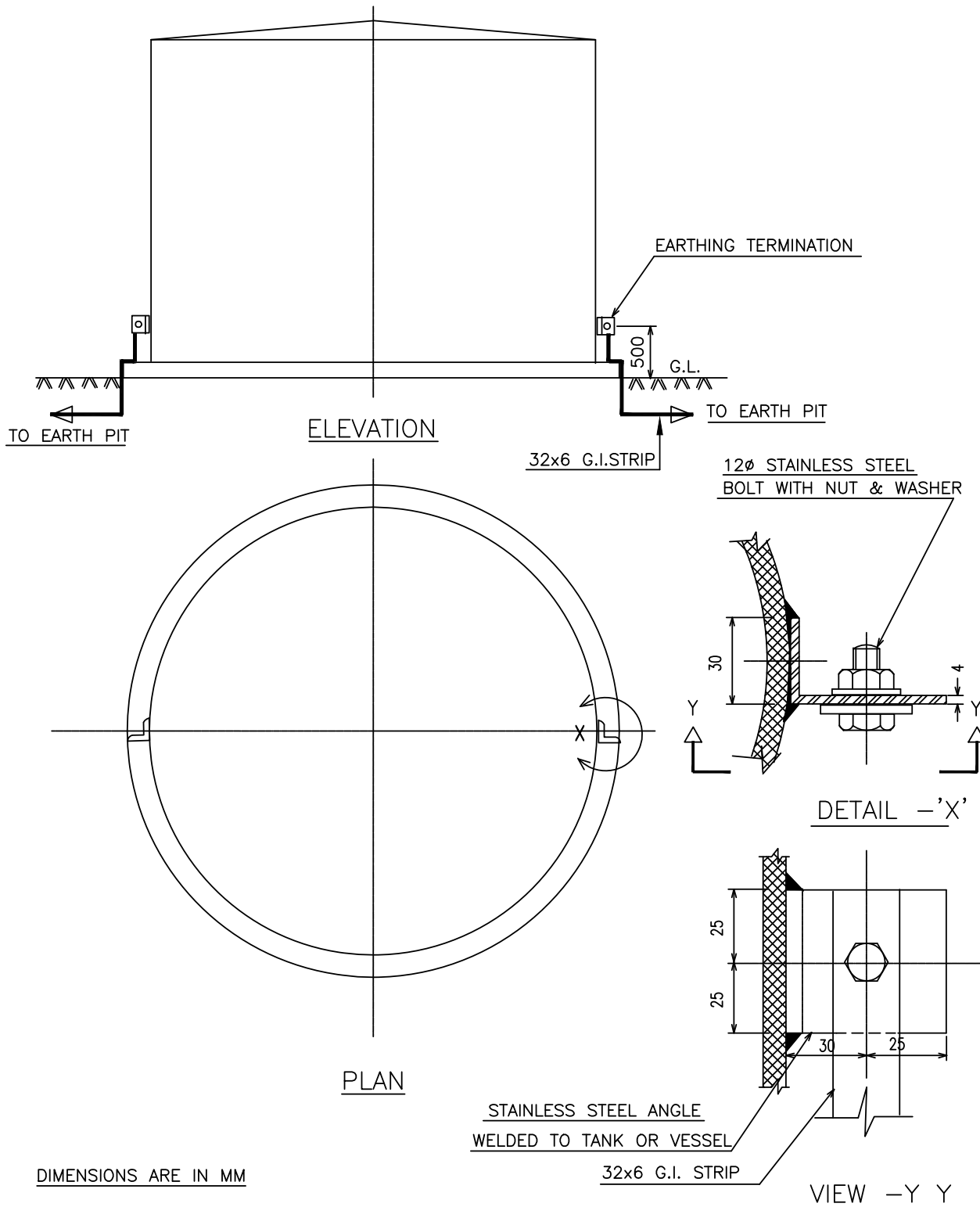

THE NO. OF EARTH CONDUCTOR SHALL BE AS FOLLOWS

EQUIPMENT WITH ANY DIMENSION	HAZARDOUS AREA	NON-HAZARDOUS AREA
≤ 3 Mts.	1	1
> 3 Mts. ≤ 30 Mts.	2	1
> 30 Mts.	3	2

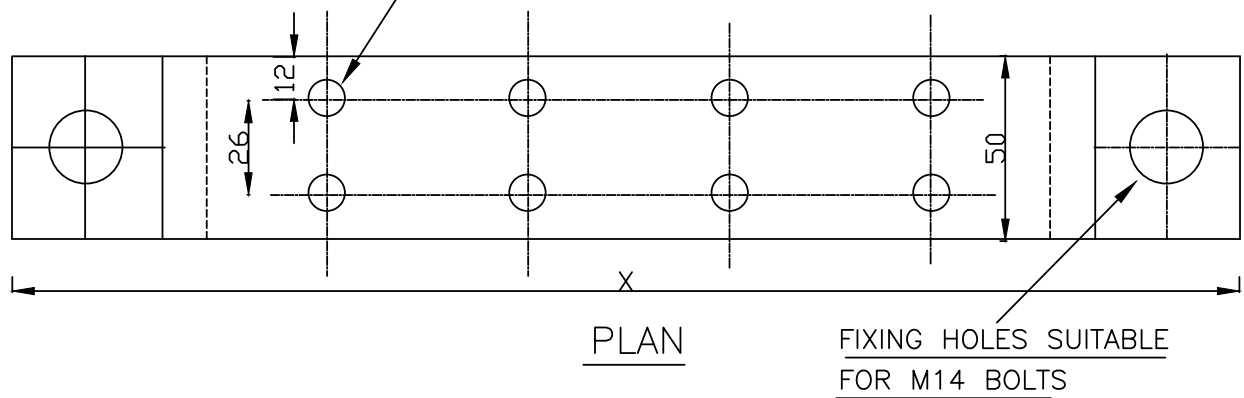
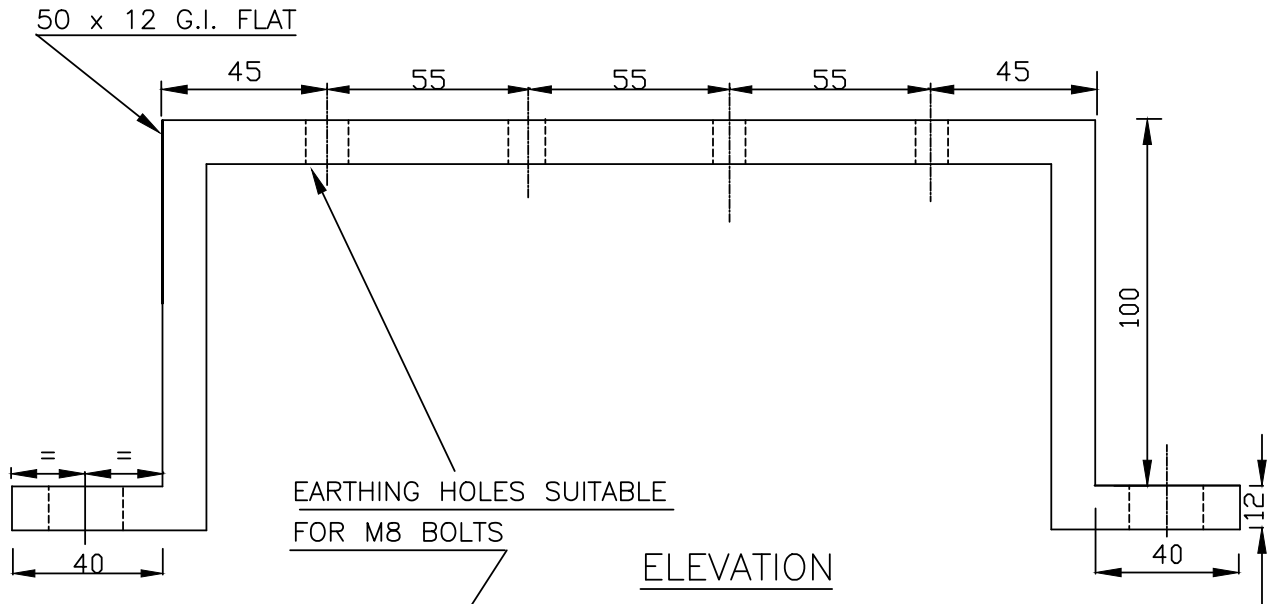

TYPE OF EARTH BUS	NO.OF EARTHING HOLES	OVERALL LENGTH x (mm)
1	8	335
2	10	390





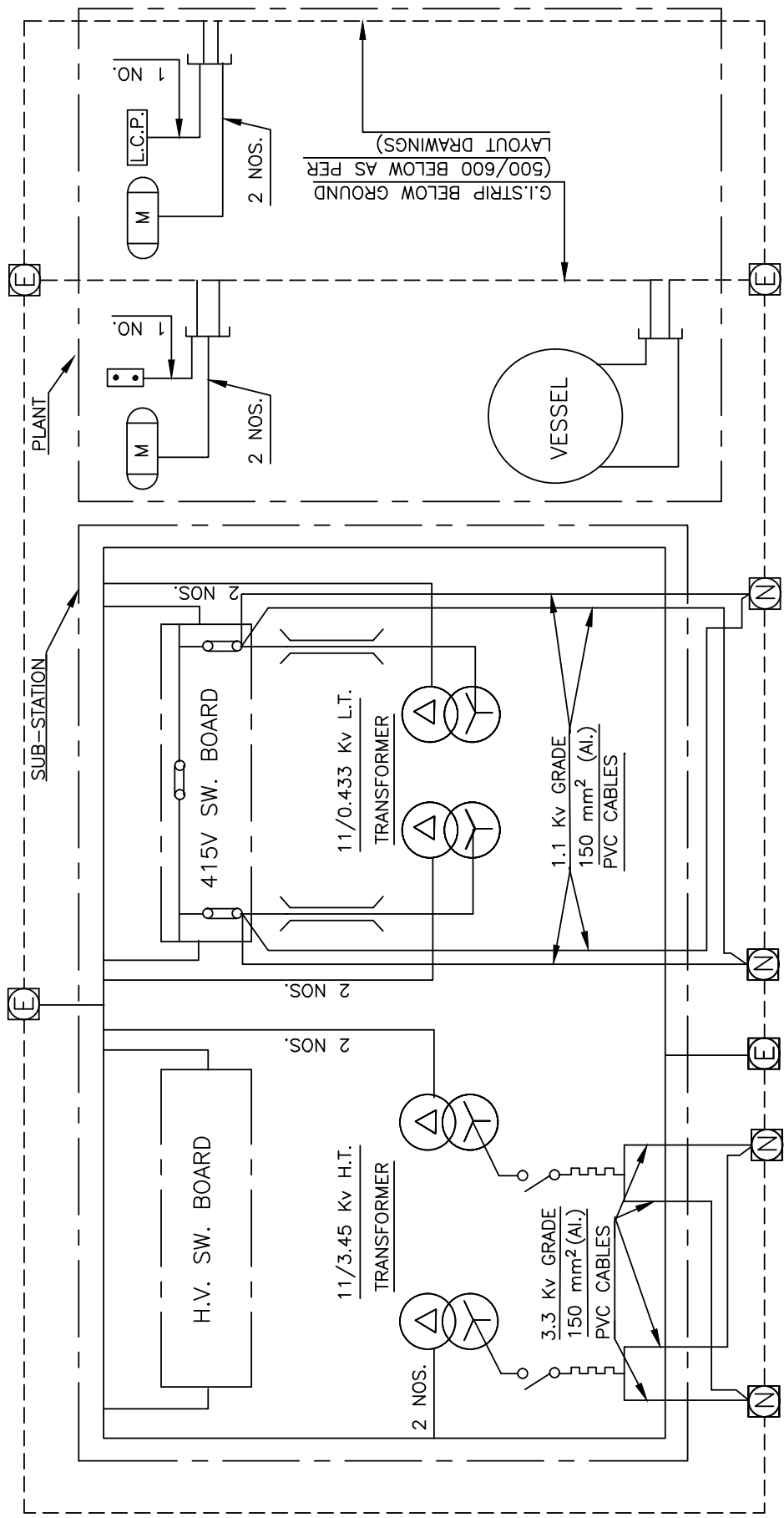





NOTES:-

1. LOCATION OF EARTH BUS TO BE DECIDED AS PER EQUIPMENT POSITION AT SITE.
2. EARTH BUSES SHALL BE LOCATED ON STRUCTURES/COLUMNS WALLS/EQUIPMENT FOUNDATION ETC.
3. MOUNTING HEIGHT OF EARTH BUS SHALL NOT BE LESS THAN 500mm FROM FINISHED FLOOR LEVEL
4. ALL DIMENSIONS ARE IN mm

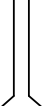

REF. DRGS.
1. EARTH PIT DETAILS - PDS:E 605
2. EARTH CONDUCTOR SIZES - PDS:E 602 (2 SHEETS)

NOTE :-
EARTH BUS SHALL BE 500 ABOVE FROM FLOOR LEVEL

- L E G E N D
-  MOTOR
 -  LOCAL CONTROL PANEL
 -  LOCAL CONTROL STATION
 -  NEUTRAL EARTH PIT
 -  EARTH PIT FOR SYSTEM
 -  NEUTRAL LINK
 -  TPN BUS DUCT
 -  NEUTRAL EARTHING RESISTOR
 -  SWITCH
 -  EARTH BUS

 PROJECTS & DEVELOPMENT INDIA LIMITED	PC183/E/8003/SecVI-3.0		
	Document No.	Rev	
	Sheet 1 of 33		

TECHNICAL SPECIFICATION & SCOPE

INSTRUMENTATION WORKS (SUPPLY, ERECTION, TESTING & COMMISSIONING)

**PLANT : ELECRTICAL & INSTRUMENTATION SUPPLYCUM
ERECTION WORKS**

**PROJECT : INTEGRATED COAL BASED FERTILISER COMPLEX,
AT TALCHER, ANGUL DISTRICT,ODISHA (INDIA)**

€	07.03.2023		Issued for Tender	SG	SG	RKR
P-1	15.10.2022		Issued for Client' Review & Comments	SG	HS	SKT
REV	REV DATE	EFF DATE	PURPOSE	PREPD	REVWD	APPD

CONTENTS

CLAUSE NO.	DESCRIPTION	
1.00	Scope	
2.00	Applicable Standards / Codes / Rules	
3.00	Technical Conditions	
4.00	Works Included	
5.00	Execution Methodology (Site)	
6.00	Painting	
7.00	Calibration, Testing And Functional Checking	
8.00	Loop Checking	
9.00	Commissioning	
10.00	Scope Of Supply For Erection Material, Structural Steel & Consumables	
11.00	Tools And Tackles	
12.00	Obligations Of PDIL/TFL	
13.00	Obligation And Responsibilities Of Bidder	
14.00	Documentation	
15.00	Material Reconciliation And Wastage Allowance	

LIST OF ATTACHMENTS

ATTACHMENT NUMBER	DESCRIPTION	NUMBER OF SHEETS
ES-7013/7014/7015/7016/7017/7018	ENGINEERING STANDARDS (INSTALLATION DRAWINGS –TYPICAL)	
	SCOPE AND GENERAL GUIDELINES FOR CCTV NETWORK SYSTEM	
	TECHNICAL SPECIFICATION OF TELEPHONE & LAN SYSTEM	
	Technical Specification JBs & CG	
	VALVES & FITTINGS SPEC	
	ES FOR PRESSURE TESTING	
	TECHNICAL SPECIFICATION CABLE TRAY	
	TECHNICAL SPECIFICATION FOR INSTRUMENT CABLES	
	TECHNICAL SPECIFICATION FOR PRESSURE, D/P & TEMPERATURE TRANSMITTER	
	FRP CANOPY	
	TECHNICAL REQUIREMENTS FOR SHOP & SITE APPLICATION OF PAINT & PROTECTIVE COATING	
	FORMATS OF REPORTS	
	SOR for Supply, Erection, Commissioning & Functional Check for Instrumentation	
	PLOT PLAN_REV_1	
	BUILDINGS DETAILS	

 पो डी आई एल PDIL	PROJECTS & DEVELOPMENT INDIA LIMITED	PC183/E/8003/SecVI-3.0	
		Document No.	Rev
		Sheet 4 of 33	



1.0 SCOPE – As a minimum but not limited to:-

- 1.1 The scope includes work/service for engineering, manufacture, testing at works, Third Party Inspection, supply, dispatch, storage, handling, calibration , loop checking , cable supply, cable laying, erection material supply, erection, testing at site and commissioning of complete Instrumentation systems (Field instrumentation, CCTV system , EPBAX system, GPS system etc.) and its associates items as defined elsewhere in this tender for 'Electrical & Instrumentation Supply Cum Erection Works'.
- 1.2 The scope is also includes of this Instrumentation Job consist of Installations required for operation and monitoring of Off-sites & Utilities as per this document , P & I diagrams, various Installation Drawings / Documents and other relevant documents. Bidder to note that some instruments may provide instrument as loose supply, installation of all instruments, cables, JB, termination, panel erection, loop checking and commissioning is also in bidder's scope of work.
- 1.3 The scope includes Supply of Instrument Erection Materials, Installation of Instruments alongwith Bidder supplied as well as free issue erection materials;, transporting & Storing of Instruments & materials as per requirements, Hook-up, testing calibration ,commissioning, reconciliation of materials & handing over to PDIL/TFL of Complete Instrumentation System.
- 1.4 Preparation of drawings/ document/ to suit Project implementation schedule.Preparation of drawings/ documents/ calculations/ formats/ test reports/ test certificates; Erection, Testing & Commission Manuals/ Operations & maintenance Manuals/ Reports/ QAP etc for approval/ Review/ reference/ record and/ or for any other requirement; submission to Owner/ Consultant in requisite sets, getting approval from Owner/ Consultant, making approved copies available to manufacturers, inspectors, erection & commissioning engineers, supervisors, owner/Consultant etc as required in requisite sets well before those are actually required by them to fulfil their obligations.
- 1.5 Design, manufacture, testing of equipment/ cables/ cable trays/ earthing and othererection materials etc at manufacturer's works, submission of documents with manufacturer's test reports/ type test reports to Owner/ Consultant prior to inspection call.
- 1.6 In case of discrepancy between different documents / clauses of DOCUMENT Specifications the most stringent/appropriate one that meet the Plant requirement as decided by Engineer-in-charge shall be considered as applicable. For same its bidder responsibility to take prior approval from PDIL/TFL for such cases.
- 1.7 Unpacking, handling, physical checking, cleaning and drawal of instruments, instrument accessories and erection materials from PDIL/TFL's stores and/or from places of storage anywhere within the boundary wall of project/plant premises and return of the leftover materials to PDIL/TFL's stores with suitable return notes.
- 1.8 Transportation and Handling of instruments, instrument accessories and erection materials at PDIL/TFL's stores and/or at places of storage anywhere within the boundary wall of project/plant premises and existing factory and transporting from there to work sites and/or Bidder's stores.

 PROJECTS & DEVELOPMENT INDIA LIMITED	PC183/E/8003/SecVI-3.0	Rev	
	Document No.	Rev	
	Sheet 5 of 33		

- 1.9** Dust free and air conditioned storage of electronic instruments is essential at Bidder's Stores. Air-conditioning need not be provided for fully mechanical type of instruments, accessories and erection materials.
- 1.10** The scope of work also includes supply of erection materials like Cable tray, Junction box & cable gland, Instrument valves, Pipe fittings ,Compression fittings, and other related hardware's including consumables as mentioned in this document.
- 1.11** Depute OEM / vendor /supplier representative during erection & commissioning for supervision.
- 1.12** Bidder is expected to visit the site, ascertain the location, environment, rules/regulations/laws of the plant/Municipal Corporation/State.
- 1.13** Bidder is also expected to utilise their expertise / experience in assessing the extent of Engineering involved including likely variations in locations of Installations.
- 1.14** Quantities indicated in the Schedule of Rates (SOR) are approximate and these may increase or decrease or some items may even be deleted at the time of actual execution.
- 1.15** The prices quoted shall be inclusive of above factors.
- 1.16** **UPS & Non_UPS power supply** shall be provided at single point. Further distribution through PDB to all items as per scope shall be done by bidder. PDB cabinet is also in bidder scope. PDB design shall be as per actual requirements and shall be floor mounted. All power cables , MCB, MCCB etc. supply laying shall be in bidder scope.

2.0 APPLICABLE STANDARDS / CODES / RULES –

The instrumentation including erection, calibration and testing shall be carried out in accordance with national, international and Indian Standards & Good Engineering Practices .The Standards referred herein and mentioned below shall be of the latest edition valid on the date of issue of this DOCUMENT :-

- ◆ AS Indian standards
- ◆ API American Petroleum Institute RP -- Recommended Practices
- ◆ ISA Instrumentation, Systems and Automation Society. Standards, Recommended Practices and Technical Reports
- ◆ ASME / ANSI American Society of Mechanical Engineers
- ◆ PDIL standards and drawings attached with this DOCUMENT (1065-0207-0784-A01)
- ◆ Manufacturer's Standards and Practices
- ◆ Factories and Labour Act and other statutory requirements, acts and rules of India
- ◆ CCTV System for Surveillance of whole fertilizer complex-As applicable
- ◆ EPBAX – Telephone system of Non-Plant building /Other building –As applicable
- ◆ GPS System –As applicable

 पो डी आई एल PDIL	PROJECTS & DEVELOPMENT INDIA LIMITED	PC183/E/8003/SecVI-3.0 Amended	 Talcher Fertilizers	
		Document No.		Rev
		Sheet 6 of 33		

3.0 TECHNICAL CONDITIONS

3.1 The complete job shall be in accordance with good international practice following local Indian standards & regulations and latest relevant drawings and documents of PDIL/TFL and reference standards mentioned in the attached sheet, to the full satisfaction of the PDIL/TFL.

3.2 DELETED

3.3 25T and 75T crane facility for unloading and erection purpose may be provided by PDIL/TFL subject to availability.

3.4 The bidder shall quote the schedule of Supply/labour rates in accordance with Performa attached in Schedule of Rates.

3.5 For field checking and calibration of the instruments, the bidder shall arrange nitrogen gas cylinders if dust and moisture free instrument air is not available.

3.6 The bidder shall obtain in writing the clearance from PDIL/TFL for any portion of work before its execution. Any change in the drawing/documents arising out of locational requirements will be made available by PDIL/TFL Engineer and to be obtained in writing before the execution of a job.

3.7 The bidder shall supply instrument air from his own compressor for pre-erection calibration. The compressor should be able to produce 7 bar g dry air pressure, otherwise Nitrogen cylinders shall be used as mentioned above. These Nitrogen cylinders shall be supplied by the bidder at his own cost.

3.8 Manpower will be arranged as per requirement of the job whenever needed. No substitution or the reduction of the staff will be accepted without prior approval of the PDIL/TFL Engaging any Sub-Bidder's shall be with PDIL/TFL 's approval.

3.9 Any minor modification job during erection, calibration and loop checking of instruments will be done without any extra cost to PDIL/TFL. Major modification job, reading job if certified by Engineer- in-Charge will be done by PDIL/TFL on per diem rate basis, if required.

4.0 WORKS also INCLUDED

4.1 To make arrangements for services such as transport, medical, lighting, canteen etc. for working round the clock for own staff. To arrange, store in tanks and supply drinking water to the Bidder's own staff .

4.2 To arrange at own cost , all tools, tackles , jigs , fixtures etc. including heavy lifting equipments like cranes etc.

4.3 To make arrangement and supply of consumable like welding electrodes, industrial gases, cleaning fluids (such as CTC, Kerosene etc.), primer for structural, Teflon tape, insulation tapes, sealing compound;

 PROJECTS & DEVELOPMENT INDIA LIMITED	PC183/E/8003/SecVI-3.0		
	Document No.		Rev
	Sheet 7 of 33		

- 4.4** Supply of erection materials such as MS structural; Inst supports ; clamping materials like aluminium strips, screws, washers, clamps, GI nuts and bolts of different sizes, for cables, tubes, trays, racks, impulse tubes ; cable lugs, all identification ferrules for cables/wires, etc. In addition to other erection materials as per DOCUMENT attached.
- 4.5** For the instruments installed during the erection period, proper protection should be given to the instruments. Bidder is responsible to replace damaged Insts/items till handing-over to PDIL/TFL. Liability for damages in non-protected instruments will be debited to Bidder
- 4.6 ERECTION OF FIELD MOUNTED INSTRUMENTS –**
- 4.6.1** Installation of field mounted instruments such as pressure/vacuum gauges, dial thermometers, pressure switches, blind switches, manometers, differential pressure indicators, local flow indicators/recorders, local indicating controllers, different transmitters, level gauges, level switches, etc. whichever is applicable.
- 4.6.2** Installation of instruments on vendor's equipment.
- 4.6.3** Installation of analysis instruments and its sample system and zero and span gas cylinders.
- 4.6.4** Installation of miscellaneous instruments with accessories such as flame safeguard instruments, changeover switches, air sets, T/C assemblies, thermo-resistance assemblies, purge type level measuring systems, electronic level instruments, solenoid valves and transducers, local panels etc.
- 4.6.5** Installation of instruments on moving machinery i.e. Axial displacement, vibration, speed key phasor, probe, proximeter etc.
- 4.6.6** Installation of vessel mounted instrument such as ordinary level gauge, torque tube level instruments, biocolour level gauge, mechanical and electronic type transmitters, level switches, dial thermometers, pressure gauges, thermocouples (including skin type) etc. Bidder shall check & ensure the centre to centre distance of level instrument and nozzle provided on equipment.
- 4.6.7** Installation of Canopies for erected instruments.
- 4.6.8** Installation of Instrument Panels
- 4.6.9** Arranging all necessary test and calibration equipment as per details provided in this specification.
- 4.6.10** Fabrication of pipe nipples, as necessary including threading as per installation standards.
- 4.6.11** Drilling of holes in blind flanges including cutting threads as required.
- 4.6.12** Cutting of gaskets of various materials to suitable sizes including making additional cut outs on panels (if required) at no extra cost.

 पी डी आई एल PDIL	PROJECTS & DEVELOPMENT INDIA LIMITED	PC183/E/8003/SecVI-3.0	Rev	
		Document No.	Rev	
		Sheet 8 of 33		

- 4.6.13** Filling of seal pots with filling liquids as per the instructions of Engineer-in-Charge.
- 4.6.14** Back/seal welding of screwed fittings as required by standards or as per the instructions of Engineer-in-Charge. This may involve welding of dissimilar materials using appropriate electrodes.
- 4.6.15** Civil works including the casting of foundation as required for instrument supports where paved surfaces do not exist. (Including cementing works)
- 4.6.16** Minor civil works like chipping of pavement, grouting of instrument panels/supports/stanchions on the pavement, laying of conduits below pavement after chipping and refinishing of pavement as necessary.
- 4.6.17** Degreasing of hand wheels of control valves, stud bolts, nuts of side and bottom flange of control valves, skid bolts and flanges of orifice plates/or other primary elements and degreasing of any other instrument as per manufacturers instructions or as required by Engineer-in-Charge.
- 4.6.18** Degreasing of impulse lines, valves, instruments and other instrument items in Oxygen and Chlorine service as per manufacturer's instructions or as required by Engineer-in-Charge.
- 4.6.19** Rotation of top works of Displacer type level instruments wherever required.
- 4.6.20** Rotation of control valve bonnet wherever required
- 4.6.21** Reversing the action of control valves either by replacement of actuator springs, accessories or Electro-Pneumatic (Pneumatic) positioner wherever required as per manufacturer's instructions.
- 4.6.22** Minor modification/repairs (restricted to insts listed in SOR/specs) required to be carried out on the instruments namely, replacement of dial, glass for pressure gauges / temperature gauges or any other similar instrument, replacement of rotameter tubes and level gauge glass; replacement of damaged signal tubes on control valves; tapping of damaged threads on couplings, tees and other fittings; cleaning of nozzles and relays in pneumatic instruments.
- 4.6.23** The Structural work includes, Fabrication, Erection of supports with structurals (M.S) like flats, plates, angles, channels etc. for trays, pipes, junction boxes, instruments, ducts, mounting stand, JB etc.
- 4.6.24** Painting of all structural supports for trays, pipes, junction boxes, instruments, ducts, mounting stand, JB etc.. as per painting specification or as instructed by Engineer-in-Charge.
- 4.6.25** Identification of instruments / impulse lines/manifold connected with alarm/trip circuit with approved colour of paint
- 4.6.26** Punching of tag numbers on items or tag plates wherever required as per instructions of Engineer-in-Charge.

 पी डी आई एल PDIL	PROJECTS & DEVELOPMENT INDIA LIMITED	PC183/E/8003/SecVI-3.0	
		Document No.	Rev
		Sheet 9 of 33	



- 4.6.27** Fabrication and installation of pipe stanchion as per Instrument support standards including casting of concrete pedestal, grouting, welding etc. as necessary.
- 4.6.28** Drilling holes for providing glands/grommets on panels, shut down cabinets, power supply cabinets, local control panels, pneumatic enclosures, junction boxes etc. wherever required for cables entry.
- 4.6.29** Installation cable tray, cable, junction box, air distribution pot, multicable transit inlet system etc.
- 4.6.30** Grounding of shields of shielded cables to respective instrument earth bus provided in the control room/local panel/thermocouple head etc. as required and instructed by Engineer-in-Charge, if required.
- 4.6.31** Laying and termination of Earthing Cable at both ends between instrument earth bus provided in control/room/local panel / Instrument to instrument earth pits provided by other Bidders unless specified otherwise, if required
- 4.6.32** Grounding of one of the thermocouple lead in the head using 10 K Ohm resistance including of supply of resistance for grounded thermocouples , if required.
- 4.6.33** Supply of all types of consumables required for the execution of the job without any exception.
- 4.6.34** Sealing of safety valves with standard lead seals after final setting in the presence of Engineer-in-Charge.
- 4.6.35** Whenever stand pipe is to be installed for level installation the following requirements are mandatory –
stand pipe isolation valves shall be provided ,
stand pipe bottom drain and top vent shall be provided,
stand pipe bottom connections shall be taken from side , not from the bottom of Vessel.
The Bidder shall check the above requirements are met.
- 4.6.36** Terminal Connection Diagram wrapped in cover shall be provided inside J.B.
- 4.6.37** Complete CCTV system- surveillance purpose installation and successfully commissioning for whole complex (Independent from main Plant system)
- 4.6.38** Complete EPBAX Exchange with telephone set system and LAN Network & system installation and successfully commissioning for Non-plant building / other buildings and interface with Main EPBAX exchange as well Govt. PSTN Lines. LAN network shall be interfaced with main System located in Admin / Technical building.
- 4.6.39** Coordination during installation, pre-commissioning and commissioning with mechanical and other sub-Bidders for proper installation of in-line mounted instruments like control valve, orifice assemblies, turbine meters, PD (positive displacement) meters, magnetic flowmeters, mass flowmeters etc. which involve removal of instruments, disconnection of tubes/cables; reconnection of same for alignment and proper installation.

 PROJECTS & DEVELOPMENT INDIA LIMITED	PC183/E/8003/SecVI-3.0		
	Document No.	Rev	
	Sheet 10 of 33		

4.6.40 Coordination during pre-commissioning/commissioning with mechanical and other Bidder for proper installation of vessel/equipment mounted instruments like level transmitters, level gauges, level switches etc. which involves removal of instruments, disconnection of tubes/cables, reconnection of the same for alignment and proper installation etc.

4.6.41 Coordination during pre-commissioning/commissioning with System Vendors for DCS , PLC/ESD, CCTV vendor, EPBAX vendor, LAN vendor, other Bidder etc. for proper functioning of the Control & Instrumentations.

4.6.42 Submission of final material appropriation statements for all the materials issued by the PDIL/TFL

4.6.43 Installation of line mounted instruments like direct pressure reducing valves, control valves, flow nozzles, turbine meters, orifice plate assemblies , annubars, variable area flowmeters, magnetic flowmeters etc.

4.6.44 Installation of safety valves, breather valves, flame arresters, rupture discs.

4.6.45 First block valve for instrument tapping points on piping and equipments.

4.6.46 Insulation of steam traced instrument primary impulse lines.

4.6.47 Lighting in control room

4.6.48 Installation of UPS, Power supply to UPS, outlet from UPS to Inst PDB

4.6.49 Additional Work:

Where requested by PDIL/TFL /Engineer-in-Charge or his Authorized representatives, all or any of the works not detailed shall also be executed

5.0 EXECUTION METHODOLOGY (SITE)

5.1 IMPULSE TUBING / PIPING

5.1.1 Fabricating, laying and supporting of impulse tubing/piping and sample lines for the analysers etc. Laying of level gauge drain pipes (if required). Manifold fabrication is not included in impulse pipe rate.

5.1.2 All impulse lines of the instruments shall be subjected to hydraulic test with pressure modality required for the test line. Every impulse line is to be tested before preparation of inspection report. In case of repairs of any line the tests will be repeated again.

5.1.3 Steam tracing of impulse lines wherever necessary and final connections to steam jacketed instruments. Piping connections for internal washing of instruments and purging of instrument casings.

 PROJECTS & DEVELOPMENT INDIA LIMITED	PC183/E/8003/SecVI-3.0	0	
	Document No.	Rev	
	Sheet 11 of 33		

- 5.1.4** All impulse lines shall be installed in the best workman like manner and shall follow installation standards in each case. Where there is no installation standard, the instruction of the Engineer-in-Charge shall be followed.
- 5.1.5** Horizontal and vertical lines shall be installed using levels and plumb bobs.
- 5.1.6** Unless otherwise specified in the drawings, impulse lines shall have a slope of not less than 1 in 12 on the horizontal runs.
- 5.1.7** All welding shall be carried out as per welding procedures and codes approved by Engineer-in-Charge. Welding Electrodes shall be as per approved vendors only. Only qualified welders approved by Engineer-in-Charge shall carry out welding.
- 5.1.8** However, any materials like electrode, equipments, testing charges for various tests etc. required for initial qualification of the welder/welders shall be borne by the Bidder.
- 5.1.9** Wherever welding of dissimilar materials are envisaged for any process hookup, the Bidder's scope includes these welding alongwith supply of weld materials.
- 5.1.10** Impulse pipes/tubes shall be bent using pipe/tube benders only ; hot bending will be prohibited. Pipes/tubes shall be cut using pipe cutting device. Hot cutting will not be allowed.
- 5.1.11** Piping/tubing for steam tracing shall be installed according to the standards without any pocket so as to avoid formation of the condensate pockets.
- 5.1.12** All threaded joints shall be jointed with PTFE tape only. No other pipe jointing compound shall be used except on high temperature service where graphited sealing compounds shall be used.
- 5.1.13** All impulse lines shall be properly supported at regular intervals of 1 metre. Wherever insert plates are not available, supports on concrete structures or on ceilings shall be fixed with a minimum of 10 mm expansion bolts.
- 5.1.14** Angle supports shall be fabricated from 50 mm x 50 mm x 6 mm MS angles, as a minimum. Channels shall be ISMC 100.
- 5.1.15** Measurement of impulse tube / pipe work for billing purpose will be done from joint to joint basis starting after the first/2nd isolation valve (Installed by mechanical Bidder) to the instrument including the vents and drain piping. Charges for fixing of fittings and valves, syphons, condensate pots etc. will not be paid separately but they will be included in the impulse piping / tubing work. The same shall include hydrostatic test/pmi as per specifications.
- 5.1.16** Impulse tubing / piping erection rate will be on meter basis inclusive of all fittings, valves, syphons and condensate pots etc. used for erection and for testing.

 PROJECTS & DEVELOPMENT INDIA LIMITED	PC183/E/8003/SecVI-3.0	0	
	Document No.	Rev	
	Sheet 12 of 33		

5.2 AIR HEADER PIPING, SS TUBING AND ADP

- 5.2.1** Air supply from the main air header take off valve to individual instruments/AD pots shall be through SS pipes and tubes as per drawings.
- 5.2.2** Individual take off valves shall generally be located on top of the main air header. Hook-up points to be considered as per the Layout Drawings.
- 5.2.3** Supporting of instrument air headers piping from header to air distribution pot -The pipe shall be supported at a minimum interval of 1.5 meters with MS angles.
- 5.2.4** There shall be one isolation valve at each instrument end. Final connection to the instrument shall be SS tubing as per tubing hookup/ secondary dwgs.
- 5.2.5** Identification tag plates shall be provided on either side of tubing as per AD pot drawing.
- 5.2.6** Laying and supporting of single run tubing on racks/trays inclusive of connecting of tubes with connectors. Tube laying rate shall include connection by connectors.
- 5.2.7** The practice of flattening tubes for clamping purposes shall not be permitted.
- 5.2.8** Instrument air tubing connections are mainly by connectors. The Bidder shall quote the same in the Schedule of rates.
- 5.2.9** Cleaning and blowing of air distribution lines, pneumatic tubing, impulse tubing, piping and sample lines for analysers etc. (jobs on main air header are not included in scope of work of instrument Bidder).
- 5.2.10** Testing of air distribution lines, pneumatic tubing , impulse tubing / piping and sample lines for any leakage and proper connection (only air shall be used for testing air/pneumatic lines) shall be done.
- 5.2.11** Mounting of air distribution pot (the mounting U clamp, nut, bolt and washers in Bidder's scope).
- 5.2.12** Laying of distribution air header, supporting, fixing, cleaning and painting of distribution air header lines and its testing (the rate shall be inclusive of fittings, flanges, valves, etc. on the air header).
- 5.2.13** Air header piping shall be tested pneumatically at 10 bar pressure.
- 5.2.14** SS tubing supply line leakage shall be tested Pneumatically at 10 bar.
- 5.2.15** SS tubing signal line leakage shall be tested with bubbler.

5.3 CABLE LAYING WORK

 पी डी आई एल PDIL	PROJECTS & DEVELOPMENT INDIA LIMITED	PC183/E/8003/SecVI-3.0	0	 Talcher Fertilizers
		Document No.	Rev	
		Sheet 13 of 33		

- 5.3.1** Laying and supporting of multicore and single core power cables, multipair / triad and single pair signal / extension cables, optical fibre cables and any other special cables on racks/trays.
- 5.3.2** All cable routes shall be carefully measured and cables cut to the required lengths, leaving sufficient amount for the final connection of the cable to the terminals on either end. The various cable lengths cut from the cable reels shall be carefully selected to prevent undue wastage of cables.
- 5.3.3** Before laying, cable/multicable on drums shall be meggered and tested to ascertain the transit damages
- 5.3.4** Bidder to consider provision of tray in general for branch cable above ground line. Due to site requirement if cables are crossing road , laying underground etc. , proper protection to be provided .
- 5.3.5** A detailed planning shall be submitted prior to cable laying, giving drum number, cable number, lengths which shall be approved by Engineer-in-Charge.
- 5.3.6** Cables shall have complete uncut lengths from one termination to the other.
- 5.3.7** All cables shall be indicated close to their termination point by cable number as per cable schedules/junction boxes schedules. PVC ferrule/tag plate shall be used and these identification tags shall be securely fastened to the cables.
- 5.3.8** All cores of electrical cables shall be identified by their wire numbers by means of the PVC ferrules. Wire numbers shall be as per dwgs. All temporary ends of cables shall be protected against dirt and moisture. For this purpose, ends of all PVC insulation cables shall be taped with an approved PVC or rubber insulating tape.
- 5.3.9** The bending radius of cables shall be maintained as per manufacturer's recommendation. Cables installed above ground shall be run exposed on walls, ceilings, structures and shall run parallel or at right angles with beams, walls or columns
- 5.3.10** Glanding and termination of all field/MCC cables including its ferruling and fixing of lugs, thimbles etc. of proper sizes in Marshalling/Auxiliary Cabinets located in main control rooms, in local control panels and panels in various substation / MCC rooms.
- 5.3.11** The testing of the field cables and cables coming from MCC and checking of the voltage for healthiness of the signals. However, this job will be carried out by Instrument Bidder in control room.
- 5.3.12** Intrinsically and non-intrinsically safe circuits to be separated in wiring.
- 5.3.13** Testing of power cable, extension / compensating cable, signal cables and any special cables for proper connections, continuity and insulation shall be done.
- 5.3.14** Sealing of cable and tube entries to control panel/control rooms to be done.
- 5.3.15** Any minor modification job during installation of instruments at no extra cost to PDIL/TFL. Major modification jobs, major redoing of jobs (if certified by engineer-in-charge as major) will be done by Bidder on existing or per diem rate basis.
- 5.3.16** Power supply cable to individual instruments, instrument local panel and other location in the field shall be done by the Bidder , if required.
- 5.3.17** Identification and proper ferruling of individual cores during field cable termination.
- 5.3.18** Dressing, Clamping and termination of control/instrument cables to the entire satisfaction of the Engineer-in-charge. Cables shall be rigidly supported on structural steel and masonry individually or in groups as required using PVC covered galvanised

 PROJECTS & DEVELOPMENT INDIA LIMITED	PC183/E/8003/SecVI-3.0	0	
	Document No.	Rev	
	Sheet 14 of 33		

clips, multiple cable supports or cable trays material to be used for tying of cables with trays must be corrosive resistant. If drilling of steel must be resorted to approval must be obtained and steel must be drilled where the minimum of weakening of the structured wall result. Cables shall be supported at every 500 mm on vertical runs and every 100 mm on horizontal .Cable tag list shall be put at every 50 meter.

5.3.19 All special cables and power supply cables will be laid direct to the field instrument without any junction boxes, unless otherwise specified

5.3.20 Charges for laying cables shall be inclusive of glanding, terminations and identification ferrules etc. at both ends and megger testing of field cables and clamping also.

5.3.21 Co-ordination and interconnection of all cables coming from MCC/field to control room, megger testing of field cables and induced voltage checking especially for cables coming from Electrical Terminal Board.

5.3.22 Final Covering of false floor after removing as per original floor plan.

5.3.23 Any modification required prior to commissioning.

5.3.24 Final termination drawing with all modification is to be done by the Bidder and handed over to PDIL/TFL.

5.3.25 Burying /Ducting:

Where laying above ground is not possible /advisable , cables may have to be laid below ground either in concrete trenches or buried.

Making Concrete trenches are outside This Bidder's scope.

Ducting shall be applicable only while laying in Hazardous area if specifically asked .

Sufficient separation also shall be maintained among low signal cables , control cables and H.T. Electrical Cables . For this purpose Vendor shall develop necessary cable layout drawings approved by PDIL/TFL.This is essential in view of possibilities of presence of existing pipes /cables.

Each underground cable (either in concrete trenches or buried) shall be provided with identifying SS tag plate securely fastened every 30 m of its underground length with at least one tag at each end before the cable enters the ground.

Directly buried cables shall be laid underground wherever required.

On completion of every group of cable laying, every cable shall be subjected to insulation test in the presence of Engineer-in-Charge. Defective cables shall be replaced.

Cable route markers of SS 100mm dia,2mm thk indicating number of cables, depth and direction will be placed enroute,at appr 30 meter intervals ,on crossovers/ turnings etc, to mark the cable route; without Obstructing passage.

Cable Markers / Flag Plate, at both ends to be provided by Bidder. Plates of 304 SS 100x100x2 mm bolted to 50x50x6 Ms painted angle using SS bolts,Nuts. Plates shall have details such as depth of burial & type of cables punched /engraved.

Engineer-in charge to be consulted as to locations .

 PROJECTS & DEVELOPMENT INDIA LIMITED	PC183/E/8003/SecVI-3.0	0	
	Document No.	Rev	
	Sheet 15 of 33		

At each road crossings and other places, where cables enter pipe sleeves, adequate bed of sand shall be given so that the cables do not slack and get damaged by pipe ends after back filling. After laying, the pipe sleeves shall be sealed using sealing compounds.

At the entry into concrete blocks at road crossings cable loops shall be provided at either ends to prevent any damage to cables. Each cable shall have one tag at each end before the cable enters/leaves conduit pipes.

5.4 MULTI-CABLE TRANSIT (MCT)

- 5.4.1** **MCT supply and its installation in not in Bidders scope**, After laying of all the cables, the cable entry to control room shall be suitably filled with MCT Blocks with Frames and sealed so as to achieve a positive seal against the entry of gas, water. On completion of cable laying in case of concrete trenches, the trenches shall be filled with sand and pre cast concrete slabs shall be placed on the trench.
- 5.4.2** Bidders scope includes installation/laying of cables through MCT, as per instruction from Engineer incharge , MCT supply will be done by others.
- 5.4.3** Vendor shall take care of all type of cables entering into Control Room. The installation shall be complete with Frames , insert blocks of each cable type, of each cable outer diameter (O.D.) and all other necessary hardwares like myler tape etc. necessary to fit the supplied MCT blocks in frames.
- 5.4.4** The power cables for instruments 115 V A.C shall be suitably separated from other cables within the MCT frame.
- 5.4.5** In general , MCT frame considered for instruments shall not be used for electrical cables.
- 5.4.6** Separate MCTs shall be used for electrical cables coming and
- 5.4.7** The earthing cables for instrument Panels shall be suitably separated from other cables within the MCT frame.
- 5.4.8** The MCT shall be installed as per recommended practice of supplier.
- 5.4.9** No spare space shall be left uncovered in the frame.
- 5.4.10** In addition to insert blocks as per actual requirements Bidder shall also provide 20% spare entry by supplying installed spare blocks in each cable size / O.D.

5.5 FRP PERFORATED CABLE TRAY with cover and SS installation accessories

- 5.5.1** Perforated trays/angle trays with cover shall be used for cable run. Laying, supporting, alignment of cable trays to be done by Bidder.
- 5.5.2** Fabrication of frames, supports, mounting stands, clamps, brackets, cable racks, cable trays and corners, Tees and crossings etc. for the racks and trays.
- 5.5.3** Laying, supporting of tray cover
- 5.5.4** Laying alignment & supporting alignment of cable racks and trays. The Bidder shall quote the unit rate per meter length of cable tray.
- 5.5.5** Generally supports for cable trays are provided by other agency However, in critical areas, where additional supports are required to be provided in the opinion of the site-in-charge ,the same shall be provided by Bidder free of charge. It should be covered in quoted price.

 PROJECTS & DEVELOPMENT INDIA LIMITED	PC183/E/8003/SecVI-3.0	0	
	Document No.	Rev	
	Sheet 16 of 33		

- 5.5.6** The perforated trays/angle trays shall be properly supported at a regular interval of maximum of 500 mm centres,
- 5.5.7** Trays themselves may be supported by structures used for above ground cables/trays from insert plates or steel structures. Wherever insert plates are not available supports on concrete structures and ceilings shall be fixed with minimum 10 mm diameter expansion bolts. Angle supports for perforated trays/angle trays shall be fabricated from 50 mm x 50 mm x 6 mm MS angles as a minimum.
- 5.5.8** All supports shall be cut with hacksaw only. Any work executed by gas cutting for making holes or cutting pieces will be totally rejected. Free ends of angle support shall not have sharp edges and shall be properly rounded off.
- 5.5.9** Width of trays shall be selected according to number of tubes and cables. Trays shall be laid generally as per site conditions with the approval of Engineer-in-Charge.
- 5.5.10** Weldings of structures shall be full welding on all sides so as to avoid entry of moisture through gaps.
- 5.5.11** For welding, if required, following procedure shall be followed as a minimum:
- 5.5.12** After welding, clean the welded portion for any slug and sharp edge.
- 5.5.13** Welded portion and supports shall be painted as per painting specification.

5.6 INSTALLATION OF FRP-JUNCTION BOX

- 5.6.1** Fixing in position flameproof junction boxes, electrical junction boxes, distribution boxes and relay boxes in the field and behind control panels, conduit pipes, fittings and flameproof boxes are to be ensured. Drilling/tapping of junction boxes, selector switch casings, fixing of terminals in the JB shall also be a part of job of installation of junction boxes/panel as the case may be.
- 5.6.2** Cables shall enter into the J.B. through double compression type Ex-proof cable glands or non-exproof cable Gland as specified.
- 5.6.3** Proper care to be taken to be taken for sealing of Cable entries after proper insertion , installation & terminations of cables. Special care in this regards to be taken for the installations in Hazardous Area.
- 5.6.4** The unused spare entries of the J.B. are to be plugged properly as per the practice and norms of J.B. installation.
- 5.6.5** Any civil jobs involved are to be attended in the installation of supports mounting stands, control panels, junction boxes and relay boxes.

5.7 CONTROL CABINETS, PANELS / CONSOLES , INTERFACE WITH OTHER SYSTEM

- 5.7.1** Installation, alignment, grouting and interconnections various cabinets namely of marshalling cabinets, I/O cabinets, system cabinets , consoles , control panels,PDBs, cubicle and boards, control desks mounted in field and in the control rooms. Proper grounding and relevant measures to prevent noise pickup is necessary.

 PROJECTS & DEVELOPMENT INDIA LIMITED	PC183/E/8003/SecVI-3.0	0	
	Document No.	Rev	
	Sheet 17 of 33		

- 5.7.2** Connection of PDB to uninterrupted power supplies. Termination of various cables in PDB.
- 5.7.3** Interconnection of different cabinets and consoles in control room. Interconnection of field and panel mounted instruments etc. to local panels and control panels, connection of control signals.
- 5.7.4** All panels/cabinets shall be properly levelled and secured firmly with the base supporting structure in case they are not self standing type. However, the consoles stands need not be secured to base structure.
- 5.7.5** Bidder scope includes making cut-outs in false-floors for cable entries as needed.
- 5.7.6** All other installation guidelines as recommended by system manufacturer and Indian norms shall be followed.
- 5.7.7** Minor civil jobs involved in this regard are to be attended in the installation of panel.
- 5.7.8** Interface with other third party specification including all hardware and software like CCTV system , EPBAX system , PLC system is also in bidder's scope .

5.7.9 Grounding

Each cabinet, console and other equipment supplied as a part of system shall have earthing lugs which shall be secured to the 'AC mains earthing grid'.

All circuit grounds, shields and drain wires shall be connected to the 'system ground' bus which is isolated from 'AC mains earth'.

Bidder scope includes making system earthpit(s) and inter connecting as needed, as per system vendor recommendations. The total resistance of system ground shall be less than 1 ohms unless otherwise recommended by system manufacturer.

Earthing cables shall be stranded Tinned Cu conductors min 10 sq.mm, Green outer sheath.

Safety barriers, if used, shall be secured to 'Safety ground' which shall have typically ground resistance of less than 1 ohm. The bus shall be designed considering a fault level of 0.5 A at 250 V r.m.s. per barrier

Interface with other third party specification like CCTV system , EPBAX system , PLC system is also in bidder's scope

 PROJECTS & DEVELOPMENT INDIA LIMITED	PC183/E/8003/SecVI-3.0	0	
	Document No.	Rev	
	Sheet 18 of 33		

6.0 PAINTING

- 6.1** This part of the specification is applicable to cable ducts. MS cable ways, angle trays, instrument supports/perforated trays, all structural supports for the above items etc.
- 6.2** The surface to be painted shall be thoroughly cleaned with wire brush, sand paper to remove all scales. After cleaning, the surface is painted as per specifications for painting enclosed.
- 6.3** Paints shall be epoxy based and corrosive resistant.
- 6.4** It shall be noted that final second coating on external surfaces not covered by cables, copper tubes etc. shall be applied just before handing over the plant or commissioning of the plant whichever is earlier.
- 6.5** The name of manufacturer, colour and quality of all types of primer paint shall be as per standards enclosed elsewhere in this tender and subjected to approval of Engineer-in-Charge.
- 6.6** Transportation of structural steel for sand blasting to sand blaster's shop and bringing it back to erection site is responsibility of Bidder.

7.0 CALIBRATION, TESTING AND FUNCTIONAL CHECKING

- 7.1** Bidder shall have a dust free and air conditioned room for the calibration of all electronic Instruments. Before start of the calibration, Bidder shall get approval for testing facilities, and accuracy of test instruments etc. from the Engineer-In-Charge of PDIL/TFL.
- 7.2** Calibration, testing and functional checking of all instruments and its accessories to the entire satisfaction of PDIL/TFL.
- 7.3** Bidder shall remove the instruments supplied in mounting condition on machinery, equipments, local panel etc. for calibration and install it back after calibration. No separate charge shall be paid for removal of Instruments.
- 7.4** Bidder shall make arrangement for transportation of the safety valves and control valves from PDIL/TFL's store, mechanical Bidder's store/Yard and return it back to PDIL/TFL/Mechanical Bidder's store after calibration.
- 7.5** A suitable sticker shall be fixed on the instruments after calibration, that will indicate the date of calibration, instrument range, Sr.No. etc.
- 7.6** Calibration test proforma duly filled and witnessed by PDIL/TFL's representative shall be provided by the Bidder to Engineer-in-Charge of PDIL/TFL.

 पो डी आई एल PDIL	PROJECTS & DEVELOPMENT INDIA LIMITED	PC183/E/8003/SecVI-3.0	0	 Talcher Fertilizers
		Document No.	Rev	
		Sheet 19 of 33		

- 7.7** All impulse lines shall be tested hydrostatically at 1.5 times the maximum operating pressure. Ensure that instrument and vessel/piping is isolated during this test.
- 7.8** Inst air lines shall be Pneumatically tested at 1.1 times design Pr..(Hydraulic testing of Inst Air lines PROHIBITED)
- 7.9** In case of special instruments/items where hydrotesting is not permitted due to service conditions, the impulse lines testing shall be carried out by using air or Nitrogen.
- 7.10** All external case type level instruments shall be tested upto 1.5 times operating pressure by using Nitrogen only.
- 7.11** After pressure testing, all these impulse lines shall be drained and dried with dry air to remove any traces of moisture, oil and dust.
- 7.12** Instrument air lines shall be duly tested for any leak after pressurising and isolating the main root valve by soap solution. After isolation, the rate of fall in pressure shall be less than 1 kPa for every 4.4 metre (1 psi for each 100 feet) of tubing for a test period of 2 minutes.
- 7.13** Pneumatic signal tubes shall be flushed and tested with instrument air for any leak at a pressure of 1.5 bar. After pressurising the line, the source of pressure is cut off and rate of fall in pressure shall be less than 1 kPa for every 4.4 metre (1 psi for each 100 feet) of tubing for a period of 2 minutes.
- 7.14** All instrument cables shall be tested for continuity and insulation. While meggering the cables for insulation testing, ensure that all instruments and barriers are isolated at both ends.
- 7.15** Calibration & test equipments shall be traceable to Indian standard with valid certification. Accuracy of standard inst. shall be at least two times better than inst. under test.
- 7.16** All instruments shall be calibrated for 0%, 25%, 50%, 75%, 100% and vice versa.
- 7.17** All temperature gauges shall be calibrated using temperature baths.
- 7.18** All thermocouple input instruments shall be calibrated by generating millivolts by a potentiometer.
- 7.19** All transmitters shall be calibrated as per instrument ranges.
- 7.20** All displacer type level transmitters shall be calibrated with water or suitable fluids and corrected for specific gravity.
- 7.21** All alarm and trip switches shall be calibrated over the entire range and finally set and checked for alarm/trip points and reset points as per the alarm/trip set point schedule. After setting these shall be sealed.
- 7.22** Rotameter transmitters shall be calibrated by moving pointer to 0%, 25%, 50%, 75% and 100% and vice versa range and monitoring the output at the respective flow range.
- 7.23** Bubble tight shut-off control valves and shut down valves shall be checked for seat leak test and gland leak test.
- 7.24** Solenoid valve shall be checked functionally for its operation.
- 7.25** Safety valves and relief valves shall be set/tested by using dry air/nitrogen. For high set pressure hydraulic test bench shall be used. Leakage if any shall be removed by proper lapping of seat and disc.
- 7.26** All electronic/pneumatic receiver instruments shall be calibrated as per the manufacturer's instructions. Controllers shall be aligned properly.
- 7.27** All special instruments like analyzer shall be checked and calibrated as per manufacturer's instructions. Prior to testing all analyzer sample lines shall be thoroughly cleaned by carbon tetra chloride or any other cleaning liquid. After cleaning, these lines shall be thoroughly purged with dry Nitrogen.
- 7.28** No oil should be used in Oxygen and Chlorine service lines.
- 7.29** If no instrument air is available vendor shall provide necessary N2 cylinders to carry out the above activity

 PROJECTS & DEVELOPMENT INDIA LIMITED	PC183/E/8003/SecVI-3.0	0	
	Document No.	Rev	
	Sheet 20 of 33		

- 7.30** Procedure for calibration of different items are as outlined below. However, the detailed procedure shall be submitted to Engineer-in-Charge for approval before proceeding with calibration.
- 7.31** All pressure and differential pressure transmitters shall be calibrated to the settings as per instrument data/specification sheets and instruction of Engineer-in-Charge.
- 7.32** All thermocouple receiver instruments shall be calibrated by generating millivolt signals suitable for span and type of thermocouple specified.
- 7.33** Receiver instruments programmed shall be calibrated and aligned using test hook-up as per instructions from manufacturer/Engineer-in-Charge.
- 7.34** Filled system instruments shall be calibrated for 0%, 25%, 50%, 75% and 100% range using standard thermo-oil.
- 7.35** The external displacer type of level instruments shall be dry calibrated as per manufacturer's instructions or calibrated by filling the displacer chamber with water for level 0%, 25%, 50%, 75% and 100% and draining the water at 100%, 75%, 50%, 35% and 0% of ranges after applying suitable specific gravity corrections of the process fluid as per data sheets.
- 7.36** The internal displacer/float type level instruments shall be dry calibrated as per manufacturer's instruction or using calibration chamber fabricated out of steel pipes and filling the same with water after applying specific gravity corrections of process fluid as per data sheets.
- 7.37** The level switches (external cage type) shall be set by filling the cage with water to the desired alarm/trip level. While setting the switches, it shall be ensured that the micro switches do not reset for full rated travel of the float.
- 7.38** Tank level indicators shall be calibrated at 0%, 25%, 50%, 75% and 100% and vice versa of ranges wherever practicable.
- 7.39** Control valves and positioners shall be checked for hysteresis and linearity and shall be calibrated for rated strokes. Prior to calibration, valves calibration readings shall be recorded in the enclosed format and submitted to Engineer-in-Charge for approval. Where significant deviations from specifications are obtained, the matter shall be brought to the immediate notice of the Engineer-in-Charge for corrective action.
- 7.40** The control valve be cleaned externally. The stem is then lubricated if required and stroked few times to extreme positions of plug to ensure that movement is free from friction. The valve shall then be calibrated for rated stroke and linearity also. Subsequently the valves shall be checked for hysteresis to the accuracy of 1% full scale with positioner and 5% full scale without positioners. Stroke speed has to be evaluated for trip/shutdown valves as per safety requirements identified by Engineer-in-Charge.
- 7.41 Testing of Panel / Cabinets / System**
All the system functions shall be checked thoroughly for proper functioning, whenever required and specifically asked for. These shall include but not limited to the following tests :-
- Visual and Mechanical
 - Complete system configuration loading
 - Demonstration of all system functions
 - Checking of all systems displays
 - Checking of correct functioning of all keyboards
 - Demonstration of all system diagnostics
 - Checking of proper functioning of all printers, hardcopy unit and printing of all reports.
 - Checking of all disc drives

 PROJECTS & DEVELOPMENT INDIA LIMITED	PC183/E/8003/SecVI-3.0	0	
	Document No.	Rev	
	Sheet 21 of 33		

Complete checking of logic system, loading of under's program and checkout of results.

Checking of correct change-over of the back-up / redundant units in case of failure of main units.

- 7.42** The input signals shall be simulated by disconnecting the field wires for all inputs. Wherever control room mounted Transmitters/Converters/ Receiver switches are used the functioning of same shall also be checked.
- 7.43** All test results shall be recorded in the approved format.
- 7.44** Conversion from one unit to another for the purposes of calibration is not allowed.

8.0 LOOP CHECKING

	PROJECTS & DEVELOPMENT INDIA LIMITED	PC183/E/8003/SecVI-3.0	0	
		Document No.	Rev	
		Sheet 22 of 33		

- 8.1** Open/Close loop shall be checked by giving actual input to the instrument end and check the readings in display instrument in control room and back to control valve. Bidder shall re-calibrate the loop instrument, if found any error in reading during loop checking. No separate charge for re-calibration of instrument shall be paid.
- 8.2** The accuracy of overall loop shall be within + 1% .
- 8.3** After performing the calibration of all instruments, the entire loop shall be checked for proper operation.
- 8.4** Simulation checking of alarms and safety interlocks by simulating all input parameters, creating a fault and checking the output status. The entire shutdown scheme shall be simulated from the process trip switches and the scheme shall be tested for its proper operation prior to start up of the unit.
- 8.5** Loop checking Performa duly filled and witnessed by PDIL/TFL's representative shall be submitted to Engineer-in-Charge.
- 8.6** Loop checking shall be performed after calibration, interconnection and leak testing of signal lines is carried out for all instruments. Loop tests are conducted to check the functional performance of all elements comprising the loop, thereby ensuring proper interconnections and operations.
- 8.7** Before proceeding for loop checking, the calibration results of individual elements shall be recorded on the Performa and shall be approved by Engineer-in-Charge for correctness of installation, measurements and calibration results.
- 8.8** Loop testing for all control loops shall be generally by simulating process conditions for at least 0%, 25%, 50%, 75% and 100% of full scale inputs. Detailed procedure shall be submitted to Engineer-in-Charge for approval before proceeding with the loop checking.
- 8.9** In case of shutdown systems, field/receiver switches are simulated for abnormality by disconnecting the wires at terminals. Function of all associated systems are checked including performance of solenoid valves. On/Off type control/shutdown valves including proper functioning of limit switches and other accessories. Adjustment of limit switches wherever necessary also form part of checking of loop performance.
- 8.10** Performance of individual loops shall be accepted for an overall accuracy of + 1.5%. Where deviation is found to exist more than specified limit, Bidder shall recalibrate the instruments which shall also form part of loop testing, at no extra cost.
- 8.11** After the loop test is complete, the Bidder shall connect back any terminations and connections removed for loop checking.
- 8.12** A loop shall be considered as handed over only after measurements in that particular loop are completed and certified by Engineer-in-Charge, in addition to loop sheets being duly filled in all respects, approved and accepted by Engineer-in-Charge .
- 8.13** In case of loops in which certain instruments of the loops are calibrated by other agency, loop checking shall be performed in coordination with the agency involved. If a defect in the calibration of the instruments in Bidders scope is observed, same shall be rectified to the satisfaction of the Engineer-in-Charge. However, if defect is detected in the calibration of the instruments in the scope of other agency, same shall be rectified by the agency involved. After the calibration has been rechecked by other agency/agencies, the loop checking would be performed to the satisfaction of Engineer-in-Charge. This is part of the Bidder scope of work.
- 8.14** Final certified loop sheets shall be submitted in required copies to the Engineer-in-Charge.
- 8.15** Whenever the installation of central control system like Distributed Control System/Programmable logic controllers etc. in control room is carried out by any other

 PROJECTS & DEVELOPMENT INDIA LIMITED	PC183/E/8003/SecVI-3.0	0	
	Document No.	Rev	
	Sheet 23 of 33		

agency, Bidder scope of work for the loops connected to these system shall include the following :-

- 8.16** Laying of all related cables upto the designated panel/cabinets/console, dressing , glanding & terminations of cables as per Terminal Connection Diagram, identification of cables and cores/pairs of each cable, coordination with control system vendor during glanding and termination.
- 8.17** Calibration of all field instrument independently.
- 8.18** Providing all assistance to control system vendor during loop checking. This shall include providing signals from the field instruments and checking all operations with the output provided from control system to enable control system vendor to verify loop performance.
- 8.19** Coordination with control system vendor to meet loop checking schedule. It shall be Bidder's responsibility to demonstrate/ prove measuring signal levels of field instrument output in control room in the respective identified pair in case of any problem.
- 8.20** Rectification/recalibration of field instruments if found defective during loop checking.
- 8.21** However, checking of interconnection between instrument/equipments inside control room, ferruling/tagging of interconnecting cables inside control room and performing loop checking with coordination of Bidder shall be in the scope of control system vendor.
- 8.22** It shall be Bidder's responsibility to complete all entries in the 'Loop Sheet' related to field instrumentation including calibration, installation checks, interconnection of tubing and cabling, hydrotest etc. and get it duly signed by the Engineer-in-Charge. All loop sheets duly filled and signed shall be handed over to control system vendor for overall loop checking records.
- 8.23** In some of the cases the Control Panel / System checking to be carried out by the Bidder. In those cases all the above activities as mentioned for the System Vendors to be carried out by the Bidder.
- 8.24** It shall be vendor's responsibility to complete the loop check column in loop sheet after Engineer-in-Charge accept the loops and hand over the sheets in required copies to PDIL/TFL. All field related assistance shall be provided by Bidder during all these activities.

9.0 COMMISSIONING

- 9.1** This activity shall be carried out in a systematic manner so as to avoid any accident to plant and operating personnel.
- 9.2** During the plant start up all the instruments calibration, controller alignment, trip point settings shall be trimmed so as to meet the operation requirements.
- 9.3** Prior to guarantee run of any package unit, the vital instruments as required by vendor have to be recalibrated and the results recorded.

10.0 SCOPE OF SUPPLY FOR ERECTION MATERIAL, STRUCTURAL STEEL & CONSUMABLES

The procurement and supply in sequence and at the appropriate time of all materials as per SOR & Engineering Drawings, consumables except for the materials specifically enlisted under PDIL/TFL's scope of supply shall be entirely the Bidder's responsibility and his rates for execution shall be inclusive for all these items.

 PROJECTS & DEVELOPMENT INDIA LIMITED	PC183/E/8003/SecVI-3.0	0	
	Document No.	Rev	
	Sheet 24 of 33		

10.1 SUPPLY OF INSTRUMENT ERECTION MATERIAL

Procurement and supply including proper storage and handling till the erection of following Instrument erection material shall be included in the scope of erection Bidder.

All Instrument Erection materials to be supplied by the Bidder shall be as per Scope of Work & Technical Conditions and conform to the Specifications mentioned in the DOCUMENT.

- a) Cable tray (As per SOR and tech spec)
- b) Junction box & Cable gland (As per SOR and Tech Spec)
- c) Instrument valve (As per SOR and Tech Spec)
- d) Pipe fittings (As per SOR and Tech Spec)
- e) Compression fittings (As per SOR and Tech Spec)
- f) Multi cable transit inlet system (As per SOR and Tech Spec)

10.2 SUPPLY OF STRUCTURAL STEEL

- a) Supply of structurals (M.S) like flats, plates, angles, channels etc. will be in the scope of supply of the Bidder. For structurals the Bidder shall quote for supply in Schedule of Rates.
- b) Structural will mean angles, channels, flats, plates and structural, pipes of all sizes used for making and supporting tray/racks, mounting and supporting of instruments and its accessories. Structurals will be measured and paid on metric ton basis. MS angles shall be used to support single pair cables and instrument tubing.

10.3 SUPPLY OF CONSUMABLES MATERIALS

These are as but not limited to the following :-

- 10.3.1** Materials to be supplied by the Bidder at his own cost, as part of this specification - Construction power, water shall be given at a single point only and shall be provided by PDIL/TFL on chargeable basis. Further distribution shall be arranged by construction Bidder.
- 10.3.2** All industrial gases like Oxygen, acetylene or inert gases, compressed air and all types of electrodes, brazing rods, flux etc. for welding purpose with necessary facilities for testing the welded joints.
- 10.3.3** PTFE tape and other pipe jointing compounds for threads and material for sealing of cable entries to control room, local panels, insulation tapes, sealing compounds for flame proof conduit fittings.
- 10.3.4** Bolts and nuts for supports, U-bolts with nuts, clamps for tubes and pipes, anchor bolts for panels, expansion bolts (pinch anchor/ rawl bolts) of various sizes for fixing to concrete structures. Materials for Protection of instruments against rain.
- 10.3.5** Paints, primers and solvents.
- 10.3.6** Tags for identifications of tubes/wires at panel junction boxes.
- 10.3.7** All materials for minor civil works like grouting etc.
- 10.3.8** Pipe etc. required for fabrication or instruments supports and tray supports wherever required.
- 10.3.9** All accessories for electrical wiring like cable lugs, ferrules for identification etc.
- 10.3.10** Stanchions for Instrument mounting and pole and all other structure for camera mount. Minor civil also in bidder's scope.
- 10.3.11** Mounting accessories for the above like bolts, supports etc.
- 10.3.12** Spool pieces and blinds for testing wherever required.
- 10.3.13** Any other item not specified, but required for the completion of the job.
- 10.3.14** The Bidder shall submit in sealed packets samples of all consumables like bolts, nuts, lubricants, ferrules lugs and any other materials included in their scope of supply for approval of Engineer-in-Charge which then forms the standards for erection work.
- 10.3.15 SPECIFICATIONS OF CONSUMABLES -**
The Bidder will arrange to supply the following materials as minimum as per the specifications given below. Nothing extra shall be paid to the Bidder on this account. The erection rate quoted by the Bidder in "Schedule of Rates" shall be inclusive of these materials. However, Bidder shall supply all necessary consumables to complete the erection work as described. These materials must be approved by site engineer of PDIL/TFL prior to commencement of the job.

Sl. No	Description	Size
1	PVC Ferrule Sleeves (Yellow colour)	Suitable for core size of 1.5mm ² , 2.5mm ² and 0.5mm ² .
2	PVC Ferrule Sleeves (Yellow colour)	Suitable for cable diameters of 12mm to 27mm
3	PTFE sealing tapes	10mm to 25mm width
4	Rag Bolts, washers and nuts (M.S. Galvanised)	a)M10 X 100 b)M10 X 150 c)M12 X 100
5	Cable lugs (sleeves)(tinned copper)	Suitable for 0.5mm ² and 1.5mm ² core cable

6	'O' clamping bolts, washers and nuts (M.S.Galvanised)	a) M8 -suitable for 1/2" NB b) M10-, 1" NB c) M12- 2" & above pipe.
6a	S.S. sleeves (for brazing 1/4" / 1/2" OD Tube (if required)	
7	'O' 'J' bolts, washers and nuts (M.S. Galvanised)	M8 X 75 Thread length 40mm suitable for 1/2" NB Pipe.
8	Nuts, bolts and washers (cold forged galvanised)	a) M6 X 20 b) M6 X 40 c) M6 X 65 & above d) M16X 30 Nuts suitable for M12
9	Machine screws (M.S.Galvanised) with mushroom heads complete with washers and nuts according to British Association standard thread or British whitworth standard thread	a) OBC X 1/2" b) 2BA X 1" c) 4BA X 1/2" d) 4 BA X 1" e) 1/2" BSWX 1.2" f) 1/4" BSWX 1/2"
10	Aluminium strips in coiled form made of HE-9M alloy and temper conforming to relevant Indian standard.	a) 20+0.3.mm x2 + 0.2 mm b) 2.5 + 0.3 mm Thick 3 mm + 0.2 Mm
11	G.I.stand pipe for conduiting application for crossing walkways and roads conforming to relevant Indian standard	2"G.I.Grade-B
12	Plates (M.S)	a) 25mm X 3mm b) 50mm X 6mm c) 25mm X 6mm
13	Plates (M.S) Wash Plates and insert plates	a) 150mm X 150mm X 10mm b) 250mm X 250mm X 6mm
14	Plates (M.S) for covering stand pipe and for ribs	a) 6mm thick b) 3mm thick
15	Angle (M.S)	a) 25mm X 25mm X 3mm b) 50mm X 50mm X 6mm
16	Channel (M.S.)	a) 100mmX 50mm X 6mm b) 75mm X 40mm X 6mm c) 125mm X 75mm X 6 mm
17	Octagonal Hot Dip Galvanized Poles with all mounting and installation hardware	8, 10, 12, 20 Mtrs Hot Dip Galvanized as per BSEN ISO 1461
18	All other materials required as specified in Bidder's obligations.	

12.10 TOOLS AND TACKLES

12.11 Tools, tackles and calibrating instruments have to be arranged by the Bidder as mentioned below :

The Bidder shall furnish complete information regarding tools, tackles and testing equipment that will be deployed for the job. All test equipments and kits shall be approved by competent Indian authorities and shall have valid calibration report:-

Accuracies of Test equipment shall be at least Two times better than Inst under Test.

The accuracy of certain testing instruments is given as under. The testing instrument shall include but not limited to the following:-

Sl.No	Description	Accuracy
1.	Controller test stands	Mfr. Standard
2.	Indicator/recorder test stands	Mfr. Standard
3.	Portable Pneumatic calibrator	+/- 0.2% of full scale
4.	Squeeze bulb (Flow calibrator) Range : 0 to -10.000 mm H ₂ O	--
5.	Oil bath for temperature instrument calibration Max. temperature 350 ^o C	Mfr. Standard
6.	Standard mercury in glass thermometers Range : -50 to +50 ^o C, 0 to 100 ^o C	± 0.2%
7.	Deleted	
8.	Deleted	
9.	Dead weight tester for ranges upto 350 bar	+ 0.1%
10.	Standard gauges for ranges upto 350 bar	+ 0.25%
11.	Hydraulic Gauge Tester	+/-0.5% of measured pressure
12.	Multifunction Calibrator/simulator with pump	
13.	Air hydro pump/hydraulic pump	--
14.	Vacuum pump	--
15.	Instrument air compressor with filters an regulators and deoilers	--
16.	D.C.Potentiometer	+/- 0.1%
17.	Decade resistance boxes	+/- 0.1%
18.	Multimeters	+ 0.05 mV
19.	Hand held configurator	
20.	Meggers 500 V / 1000 V	--
21.	Current generator (Instrument checker)	--
22.	4-20 mA DC (Yokogawa make or equivalent) with 24 V DC power source	--

12.12 It must be clearly understood that PDIL/TFL shall not be responsible for arranging or supplying any equipment, instruments, tools and tackles. List of major tools and tackles required are as listed below :-

 पी डी आई एल PDIL	PROJECTS & DEVELOPMENT INDIA LIMITED	PC183/E/8003/SecVI-3.0	0	 Talcher Fertilizers
		Document No.	Rev	
		Sheet 28 of 33		

- i. Cranes, winches, chain pulley blocks etc. in required quantity and of suitable capacity.
- ii. Trailers with prime over/Tractor trailers.
- iii. D-Shackles, slings, wire ropes etc.
- iv. Transformer welding sets.
- v. Water level, spirit level etc. for leveling and alignment.
- vi. Gas cutting sets.
- vii. D.G.Welding Machines.
- viii. Drilling/Grinding Machines.
- ix. Jacks with spindles (for cable drums).
- x. Pipe/tube bending machine.
- xi. Hydraulic crimping tools set.
- xii. Hand crimping tools set.
- xiii. Air Blower/Vacuum Cleaner.
- xiv. Pump for hydro testing complete with associated piping, calibrated Pr.guages, temporary fasteners, valves etc.
- xv. Earth resistance tester with leads and electrodes.
- xvi. Clip on ammeters/tong testers.
- xvii. Wooden sleepers of proper size and in adequate numbers.
- xviii. Scaffolding materials as required
- xix. Safety Valve Calibration test rig and hydraulic pump.
- xx. Any other tools, tackles and facilities required to complete all the jobs as per ITB to the best engineering practices.

12.0 OBLIGATIONS OF PDIL/TFL

12.1 To allot a plot of land near working SITE to enable the Bidder to build his office, store, fabrication shop, urinal and latrine etc. at his own cost.

12.2 To provide construction power at site as per the provisions of Site Working and Safety Conditions

 पी डी आई एल PDIL	PROJECTS & DEVELOPMENT INDIA LIMITED	PC183/E/8003/SecVI-3.0	0	
		Document No.	Rev	
		Sheet 29 of 33		

- 12.3 To provide construction water at site as per the provisions of Site Working and Safety Conditions**
- 12.4 To issue hot and cold work permits to Bidder if and when required.**
- 12.5 To facilitate issuance of gate passes and night/special passes to workmen of Bidder, for their entry to work site through security gate.**
- 12.6 To facilitate issuance of gate passes to Bidder for entry of his materials and equipment including tools and tackles etc. for entry to work site through security gate.**
- 12.7 To function as a medium of co-ordination between various Bidders for facilitating smooth progress of work.**
- 12.8 To provide all clarifications and technical matter for expediting the job.**
- 12.9 To lay down the system for issue of materials from PDIL/TFLs Stores/ Storage Yard.**
- 12.10 To provide information regarding availability of fronts and materials to be issued by PDIL/TFL so as to enable the Bidder to plan and organise the execution of work under his scope as per the overall project schedule.**
- 12.11 To provide necessary drawings and documents to Bidder for execution of the work.**

13.0 OBLIGATION AND RESPONSIBILITIES OF BIDDER

13.1 Completeness of job -

Bidder shall ensure that system is complete in all respect, the models and prices quoted include all components, accessories, services, documentation and other cost required to meet these specification, so that the system can be commissioned and put in line without any further additional accessory/ service(s).

If after placement of order, it is found necessary that vendor has to change the model number, add accessories/components or additional services are required to meet the requirements, Bidder shall do so at their cost, even if model nos. might have been approved.

Bidder alone is fully responsible for correctness of the models offered.

Bidder shall include any work, not specifically listed, but necessary for the successful completion of instrumentation work defined in this specification. If after getting the order it is found that Bidder has missed to take into account cost of any item(s) necessary to complete the work ,he shall complete the work as per specifications without any cost implication to PDIL/TFL .

 पो डी आई एल PDIL	PROJECTS & DEVELOPMENT INDIA LIMITED	PC183/E/8003/SecVI-3.0	0	
		Document No.	Rev	
		Sheet 30 of 33		

13.2 The Bidder's obligations and responsibilities shall include but not limited to the following:

- 13.2.1** To prepare detailed planning and execution schedule considering the availability of fronts and materials. This shall be reviewed by PDIL/TFL and Bidder shall be required to keep updating the same (as per the instructions of PDIL/TFL) to take care of any changes in the availability of fronts and materials and to complete all jobs as per the overall project schedule. PDIL/TFL shall in no way be held responsible for such changes because such changes are deemed quite a common feature in any project of this size.
- 13.2.2** To dispatch all materials well within the schedule & to receive at Site. After receipt, Bidder must store all the items properly till their use or handing over (of balance items) to PDIL/TFL after completion of work.
- 13.2.3** To check for quantity compliance between bill of materials and drawings for cable, structurals, earthing materials etc. and intimate PDIL/TFL sufficiently in advance regarding discrepancies, if any.
- 13.2.4** To arrange and supply all tools and tackles, which are required for the execution of jobs as per the best engineering practices and within the targeted schedule.
- 13.2.5** To arrange and supply storage tanks for drinking water so as to avoid any inconvenience which may be caused due to interruption in water supply at times.
- 13.2.6** To provide proper storage and security arrangements for Bidder's tools, tackles, equipments, materials etc. as well as equipment and materials issued by PDIL/TFL to Bidder. PDIL/TFL shall not be responsible for any loss or damage to items in the custody of Bidder at site for any reason whatsoever.
- 13.2.7** Completion of all repairs arising out of defective work done by Bidder. PDIL/TFL may at his discretion require the Bidder to rectify certain defects in materials caused due to bad workmanship of supplier and/or during transportation. For such work of course, the payment modalities shall be settled by mutual agreement before starting such rectification jobs.
- 13.2.8** To maintain all the records for men, materials and execution of job as required by law as well as PDIL/TFL.

 पो डी आई एल PDIL	PROJECTS & DEVELOPMENT INDIA LIMITED	PC183/E/8003/SecVI-3.0	0	 Talcher Fertilizers
		Document No.	Rev	
		Sheet 31 of 33		

- 13.2.9** In addition to safety regulations indicated elsewhere in the tender document, PDIL/TFL may issue certain safety directives which shall have to be followed meticulously without any reservation.
- 13.2.10** To undertake and execute work and supply as per scope of work, scope of supply, to follow Technical Conditions including Instrument erection specification for Instrument testing and commissioning and as per schedule of . To honour all other obligations listed in other sections and sub-sections of this DOCUMENT.
- 13.2.11** Reconciliation of materials issued to Bidder as directed by PDIL/TFL.
- 13.2.12** Handing over of the completed works to PDIL/TFL as per procedure laid down by PDIL/TFL.
- 13.2.13** To submit documentation forming part of request for issue of completion certificate as per the instructions of PDIL/TFL.

13.3 Protection

- 13.3.1** Bidder shall protect all Instruments supplied by them or free-issued to them from damages which may occur due to bad site conditions.
- 13.3.2** Bidders responsibility shall be upto the hand-over of complete instrumentation within their scope of supply and works as per the documents / specs given.
- 13.3.3** Bidder alone shall be fully responsible for protection of the Instrumentation items.
- 13.3.4** Bidder shall supply necessary commissioning spares for all Instruments supplied by them, without any additional cost implication.
- 13.3.5** In case of damage, Bidder shall replace the Instruments / components damaged upto the period of handing – over, without any further cost implications . These shall be limited to the Instruments supplied by them.

13.4 Progress monitoring

- 13.4.1** If any time in the opinion of Engineer-in-Charge, the Bidder has fallen behind the construction schedule, the Engineer-in-Charge may, without any extra cost to PDIL/TFL require the Bidder to take such steps as may be necessary to improve his progress (such as but not limited to) (i) employ additional man-power, resources (ii) work additional hours, (iii) increase the number of shifts, (iv) work on Sundays and Holidays.
- 13.4.2** The Bidder in such case, shall demonstrate to PDIL/TFL. The manner in which he proposes to meet the construction schedule and make up the loss time.
- 13.4.3** Failure of the Bidder to comply with the above shall be considered a failure to execute the contract with due diligence. Then PDIL/TFL has the right without prejudice to any other right or remedy which shall have accrued or shall accrue thereafter, may offload the balance job in part or in full to others at Bidder's risk & Cost.

14.0 DOCUMENTATION

14.1 ERECTION / EXECUTION DOCUMENT

 PROJECTS & DEVELOPMENT INDIA LIMITED	PC183/E/8003/SecVI-3.0	0	
	Document No.	Rev	
	Sheet 32 of 33		

Bidder shall prepare and hand over the following documents as per performa approved by Engineer-in-Charge when work/activity is completed.

- i) Erection completion report
- ii) Calibration report
- iii) Loop Checking report
- iv) Hydrotest report of Impulse piping
- v) Leak list report of air header & tubing
- vi) Cable meggar listing for insulation and core to core.

14.2 DOCUMENTS FOR SUPPLY ITEMS

- a) Unpriced copies of all the purchase orders should be submitted to PDIL/TFL as well as identified inspection agency for further necessary action regarding inspection.
- b) Copies of all the supplier's drawings for valves, strainers, traps etc. which are to be approved by Bidder must be marked to PDIL/TFL for information and comments, if any.
- c) Approval from PDIL/TFL must be obtained before accepting any deviations/substituted materials or items even if the alternative material or item is superior to the original material/item.
- d) All the materials must be procured from any of the Vendors specified by PDIL/TFL. Procurement from vendor's other than approved vendor is not allowed.
- e) Material/item test certificate/inspection reports must be submitted .
- f) Manufacturers installation, operation & Maintenance manuals.
- g) Release Note - Materials must be dispatched to Site only after inspection and issue of release note from concerned Inspection agency.

14.3 AS-BUILT DRAWINGS AND DOCUMENTS TO BE SUPPLIED after EXECUTION

Bidder to modify / update all documents and Drawings incorporating changes made during execution including filling up terminal details & making addl, dwgs.as required.

Bidder scope includes preparation & submission to Engineer-In-Charge As-built drawings and documents as detailed below:

- a) General layout plan for all units.
- b) Installation , hook up ,Terminal Connection, Loop, Wiring dwgs
- c) Control Room Layout Drawing showing Equipments, False Floor , False Ceilings .
- d) The drawings for materials that are included in their scope of supply namely trays, junction boxes, local cabinets.
- e) Bill of Materials.
- f) Final material appropriation statement for all the free issue instruments & materials indicating shortages if any in the Performa duly approved by Engineer-in-Charge.
- g) Final material reconciliation statement for erection materials – indicating shortages if any in the Performa duly approved by Engineer-in-Charge.

 PROJECTS & DEVELOPMENT INDIA LIMITED	PC183/E/8003/SecVI-3.0	0	
	Document No.	Rev	
	Sheet 33 of 33		

All materials must be dispatched to & received by Bidder at Site. After receipt, Bidder must store all the items properly till their use or handing over (of balance items) to PDIL/TFL after completion of work.

15.0 MATERIAL RECONCILIATION AND WASTAGE ALLOWANCE

15.1 The following shall be treated as usable balance material and will be accepted by PDIL/TFL provided that they are returned in good condition :

Pipes and tubes	- 1M and above
Cables	- 5M and above
Structurals	- 2M and above
Structurals Plates	- 0.25 sq.m and above
Aluminium trays/flats	- 0.5M and above

The Bidder must return surplus and left over materials to PDIL/TFL's Stores.

15.2 Unaccountable wastage shall not be more than -

- 1/2% of the executed length for S.S. and alloy steel pipes and tubes, cables.
- 1% of the executed length for G.I. Pipe, C.S. Pipe, flexible conduits and aluminium flats and aluminium trays.
- 2% for structural materials, G.I. machine screws/flats, nuts, bolts and washers.

No wastage will be allowed on valves, fittings, cable glands, anchor fasteners and terminal blocks.

15.3 No scrap will be taken out of the project premises. The use of gasket material shall be economical and the Bidder shall ensure that no undue wastage is permitted. Wastage over and above that mentioned above shall be charged at prevailing market price + 20% handling charge.

	PFC>97 HG'5 B8 '89J9 @CDA9BH @) @ '00 @-) ' u7Ohk\ K-#u	Doc No	ENGINEERING STANDARDS	
		Date	05.05.2018	
		Rev	0	

INSTRUMENT INSTALLATION DRAWINGS (TYPICAL)

0	05.10.2018	For Clients Comments	GAP	MN	MN
Rev	Date	Purpose	Prepd	Rewd	Apprd

SUPPORTING DETAILS FOR FIELD MOUNTED INSTRUMENTS

GROUND / FLOOR MOUNTED (SINGLE INSTRUMENT)

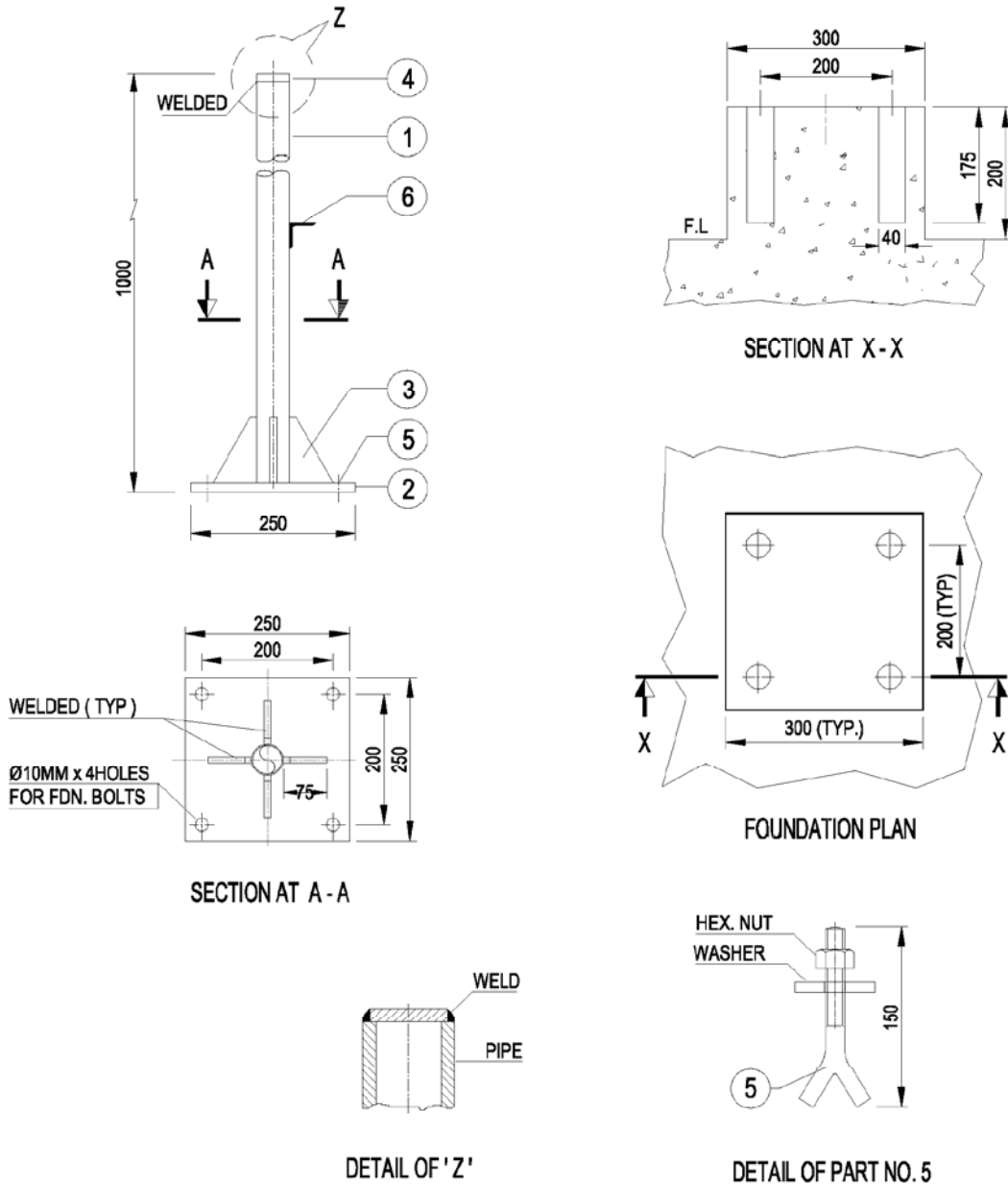

NOTE :

1. THE LENGTH OF PIPE SHALL BE 1200MM. WHERE RAISED CONCRETE PLATFORM IS NOT REQUIRED.
2. GALVANISING / PAINTING AS REQUIRED.
3. BOQ UNDER INSTRUMENT ERECTION CONTRACTOR'S SCOPE.

PART NO.	DESCRIPTION	SIZE	MATL.	QTY.	REMARKS
6	ANGLE IRON	50 x 50 x 6	M.S	0.3 MTR.	FOR AIR FILTER REGULATOR IF REQUIRED
5	FOUNDATION BOLTS, NUTS & WASHER	Ø10MM x 150L	M.S	4 NOS.	
4	COVER PLATE	4MM THK.	M.S	1 NO.	
3	RIBS (PLATE)	6MM THK.	M.S	4 NOS.	
2	BASE PLATE	250 x 250 x 6	M.S	1 NO.	
1	PIPE	DN 50	G.I	1.0 MTR.	

P	16.07.2001	CONSTRUCTION DRAWING	DCCPN	CISC	DHPV
REV	DATE	PURPOSE	PREPARED	REVIEWED	APPROVED

SUPPORTING DETAILS FOR FIELD MOUNTED INSTRUMENTS

GROUND / FLOOR MOUNTED (TWO INSTRUMENTS)

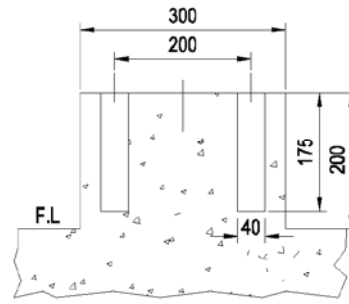
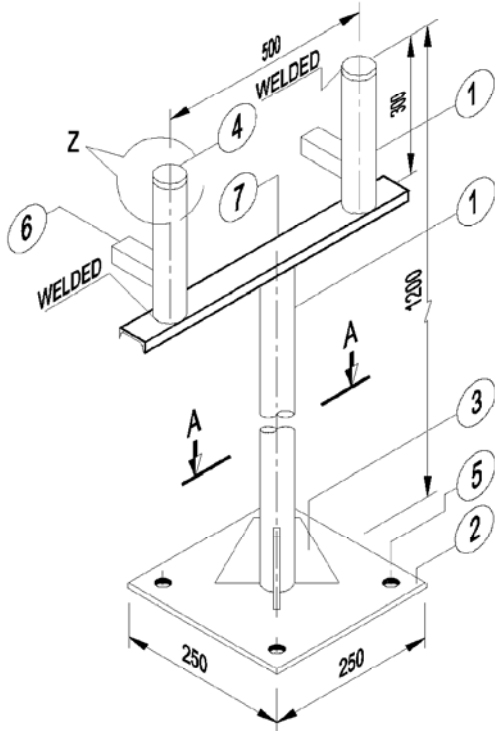

SECTION AT X - X

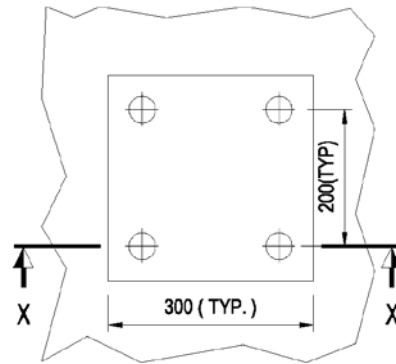

FOUNDATION PLAN

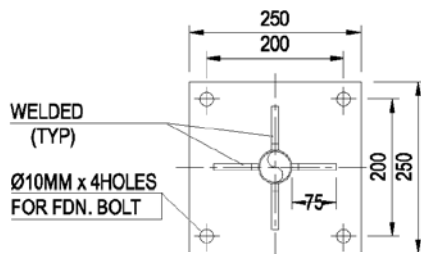

SECTION AT A - A

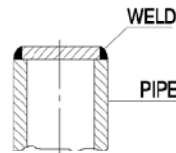

DETAIL OF 'Z'

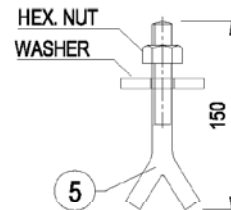

DETAIL OF PART NO. 5

NOTE :

1. THE LENGTH OF PIPE SHALL BE 1200MM. WHERE RAISED CONCRETE PLATFORM IS NOT REQUIRED.
2. GALVANISING / PAINTING AS REQUIRED.
3. BOQ UNDER INSTRUMENT CONTRACTORS SCOPE.

PART NO.	DESCRIPTION	SIZE	MATL.	QTY.	REMARKS
7	CHANNEL	100 x 50	M.S	0.7 MTR.	
6	ANGLE IRON	50 x 50 x 6	M.S	0.6 MTR.	FOR AIR FILTER REGULATOR IF REQUIRED
5	FOUNDATION BOLTS, NUTS & WASHER	Ø10MM x 150L	M.S	4 NOS.	
4	COVER PLATE	4MM THK.	M.S	2 NOS.	
3	RIBS (PLATE)	6MM THK.	M.S	4 NOS.	
2	BASE PLATE	250 x 250 x 6	M.S	1 NO.	
1	PIPE	DN 50	G.I	1.5 MTR.	

P	16.07.2001	CONSTRUCTION DRAWING	DDCPN	CISC	DHPV
REV	DATE	PURPOSE	PREPARED	REVIEWED	APPROVED

SUPPORTING DETAILS FOR FIELD MOUNTED INSTRUMENTS

GROUND / FLOOR MOUNTED (MULTI INSTRUMENTS)

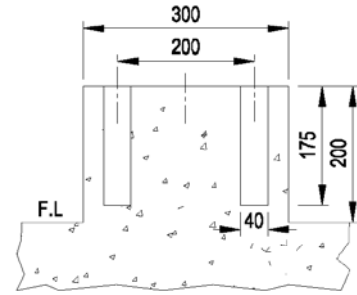
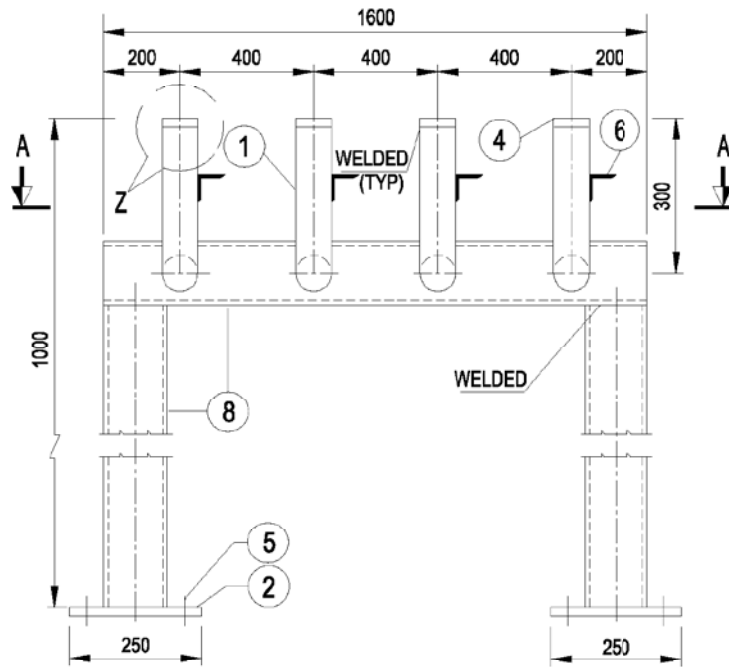

SECTION AT X - X

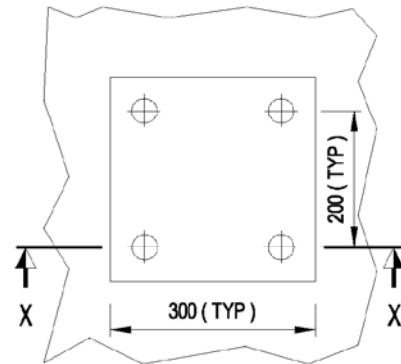

FOUNDATION PLAN

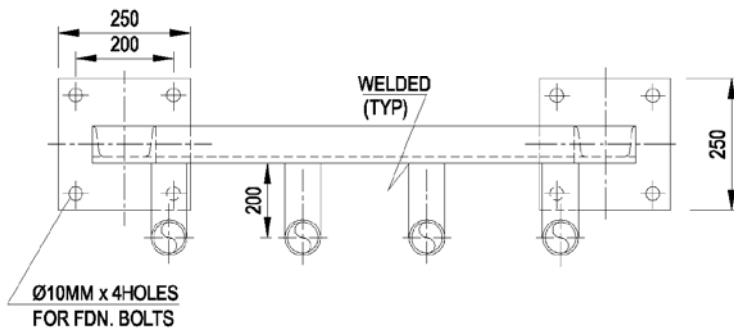

SECTION AT A - A

Ø10MM x 4 HOLES
FOR FDN. BOLTS

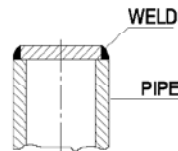

DETAIL OF ' Z '

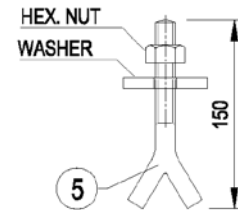

DETAIL OF PART NO. 5

NOTE :

1. THE LENGTH OF PIPE SHALL BE 1200MM. WHERE RAISED CONCRETE PLATFORM IS NOT REQUIRED.
2. GALVANISING / PAINTING AS REQUIRED.
3. BOQ UNDER INSTRUMENT CONTRACTOR'S SCOPE.

PART NO.	DESCRIPTION	SIZE	MATL.	QTY.	REMARKS
8	CHANNEL	150 x 75	M.S	8 NOS.	FOR AIR FILTER REGULATOR IF REQUIRED
6	ANGLE IRON	50 x 50 x 6	M.S	1.2 MTR.	
5	FOUNDATION BOLTS, NUTS & WASHER	Ø10MM x 150L	M.S	8 NOS.	
4	COVER PLATE	4MM THK.	M.S	4 NOS.	
2	BASE PLATE	250 x 250 x 10	M.S	2 NOS.	
1	PIPE	DN 50	G.I	2.0 MTR.	

P	16.07.2001	CONSTRUCTION DRAWING		DCCPN	CISC	DHPV
REV	DATE	PURPOSE		PREPARED	REVIEWED	APPROVED

SUPPORTING DETAILS FOR FIELD MOUNTED INSTRUMENTS

PLATFORM MOUNTED

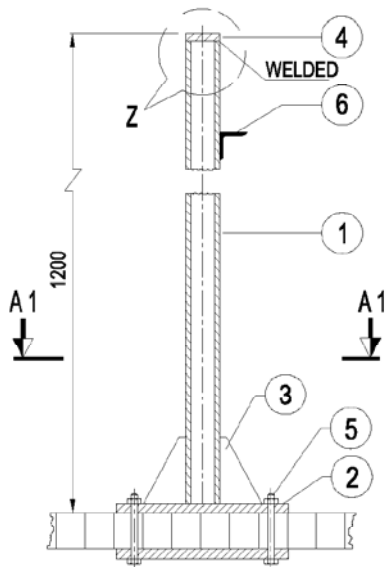

SECTION AT Z1 - Z1

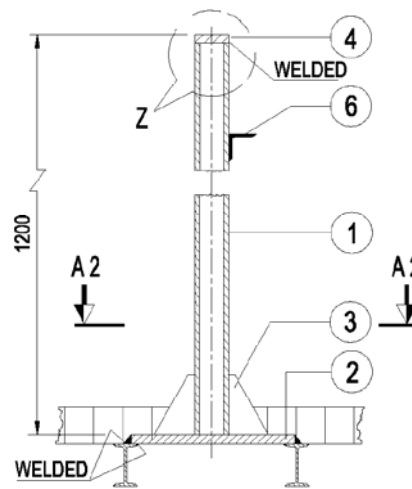

SECTION AT Z2 - Z2

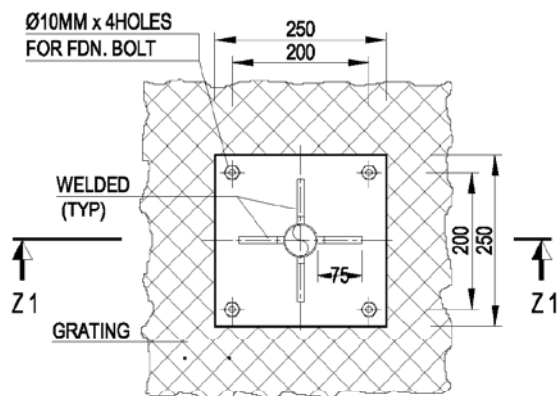

**SECTION AT A1 - A1
TYPE - A**

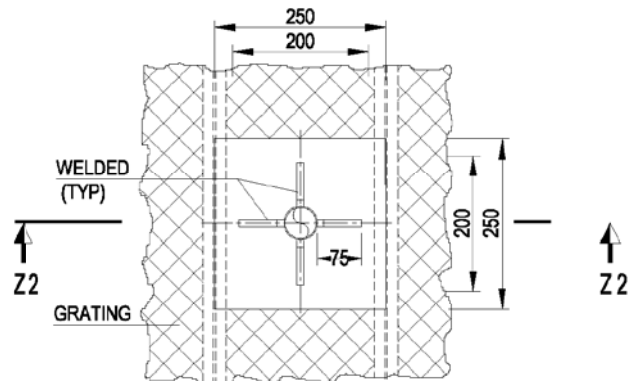

**SECTION AT A2 - A2
TYPE - B**

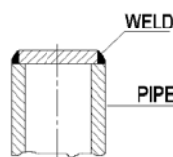

DETAIL OF 'Z'

NOTE :

1. GALVANISING / PAINTING AS REQUIRED.
2. BOQ UNDER INSTRUMENT CONTRACTOR'S SCOPE.

PART NO.	DESCRIPTION	SIZE	MATL.	QTY.		REMARKS
				TYPE-A	TYPE-B	
6	ANGLE IRON	50 x 50 x 6	M.S	0.3 MTR.	0.3 MTR.	FOR AIR FILTER REGULATOR IF REQUIRED
5	FOUNDATION BOLTS, NUTS & WASHER	Ø10MM x 85L	M.S	4 NOS.	-	
4	COVER PLATE	4MM THK.	M.S	1 NO.	1 NO.	
3	RIBS (PLATE)	6MM THK.	M.S	4 NOS.	4 NOS.	
2	BASE PLATE	250 x 250 x 6	M.S	2 NOS.	1 NO.	
1	PIPE	DN 50	G.I	1.2 MTR.	1.2 MTR.	

P	16.07.2001	CONSTRUCTION DRAWING		DCCPN	CISC	DHPV
REV	DATE	PURPOSE		PREPARED	REVIEWED	APPROVED

SUPPORTING DETAILS FOR FIELD MOUNTED INSTRUMENTS

STEEL COLUMN MOUNTED (L SHAPE)

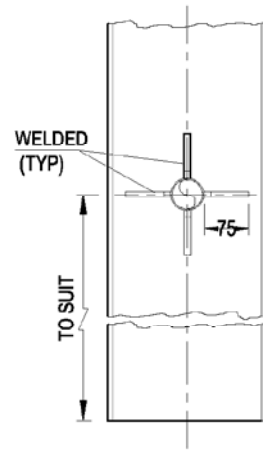
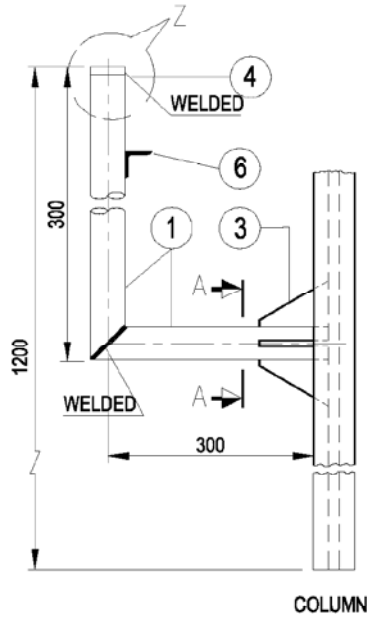

SECTION AT A-A

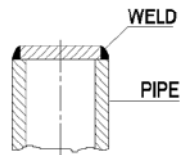

DETAIL OF ' Z '

NOTE :

1. GALVANISING / PAINTING AS REQUIRED.
2. BOQ UNDER INSTRUMENT CONTRACTOR'S SCOPE.

PART NO.	DESCRIPTION	SIZE	MATL.	QTY.	REMARKS
6	ANGLE IRON	50 x 50 x 6	M.S	0.3 MTR.	FOR AIR FILTER REGULATOR IF REQUIRED
4	COVER PLATE	4MM THK.	M.S	1 NO.	
3	RIBS (PLATE)	6MM THK.	M.S	4 NOS.	
1	PIPE	DN 50	G.I	0.8 MTR.	

P	16.07.2001	CONSTRUCTION DRAWING	DDCPN	CISC	DHPV
REV	DATE	PURPOSE	PREPARED	REVIEWED	APPROVED

SUPPORTING DETAILS FOR FIELD MOUNTED INSTRUMENTS

R.C.C. COLUMN / WALL MOUNTED

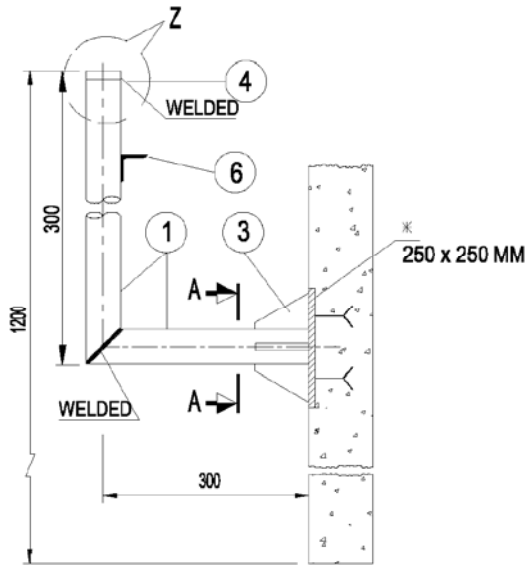

R.C.C. COLUMN

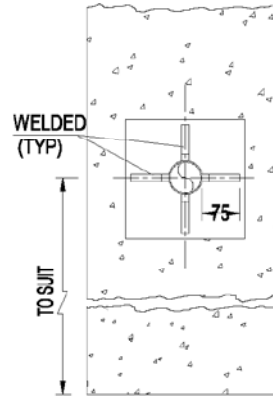

SECTION AT A - A

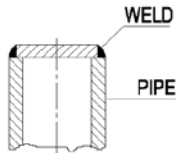

DETAIL OF 'Z'

NOTE :

1. * INSERT PLATE IS UNDER CIVIL SCOPE OF SUPPLY.
2. GALVANISING / PAINTING AS REQUIRED.
3. BOQ UNDER INSTRUMENT CONTRACTOR'S SCOPE.

PART NO.	DESCRIPTION	SIZE	MATL.	QTY.	REMARKS
6	ANGLE IRON	50 x 50 x 6	M.S	0.3 MTR.	FOR AIR FILTER REGULATOR IF REQUIRED
4	COVER PLATE	4MM THK.	M.S	1 NO.	
3	RIBS (PLATE)	6MM THK.	M.S	4 NOS.	
1	PIPE	DN 50	G.I	0.8 MTR.	

P	16.07.2001	CONSTRUCTION DRAWING	DDCPN	CISC	DHPV
REV	DATE	PURPOSE	PREPARED	REVIEWED	APPROVED

SUPPORTING DETAILS FOR FIELD MOUNTED INSTRUMENTS

R.C.C. COLUMN (WITH ANGLE IRON IN CORNER) MOUNTED

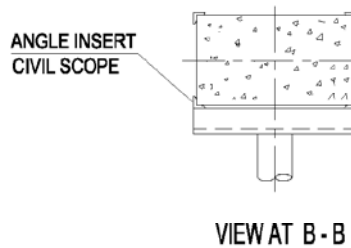
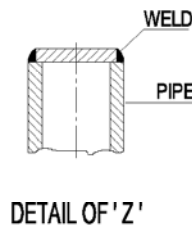
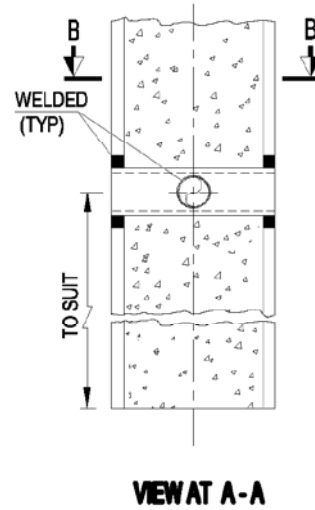
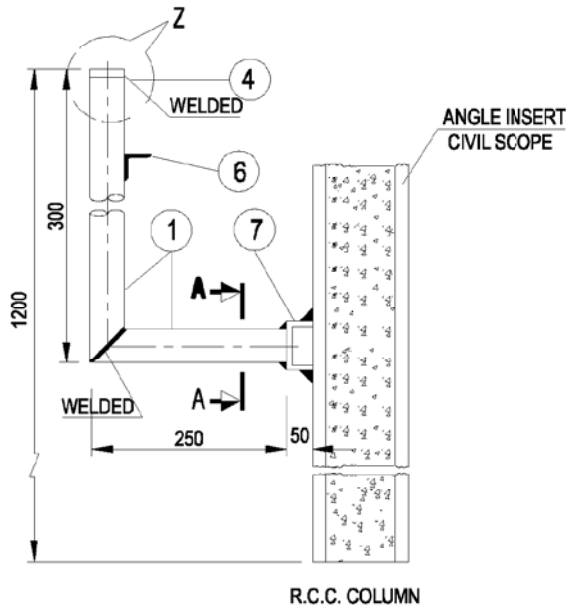

NOTE :

1. GALVANISING / PAINTING AS REQUIRED.
2. BOQ UNDER INSTRUMENT CONTRACTOR'S SCOPE.

PART NO.	DESCRIPTION	SIZE	MATL.	QTY.	REMARKS
7	CHANNEL		M.S	1 NO.	
6	ANGLE IRON	50 x 50 x 6	M.S	0.3 MTR.	FOR A/R FILTER REGULATOR IF REQUIRED
4	COVER PLATE	4MM THK.	M.S	TO SUIT	
1	PIPE	DN 50	G.I	0.8 MTR.	

P	16.07.2001	CONSTRUCTION DRAWING	DDCPN	CISC	DHPV
REV	DATE	PURPOSE	PREPARED	REVIEWED	APPROVED

SUPPORTING DETAILS FOR FIELD MOUNTED INSTRUMENTS

STEEL COLUMN MOUNTED

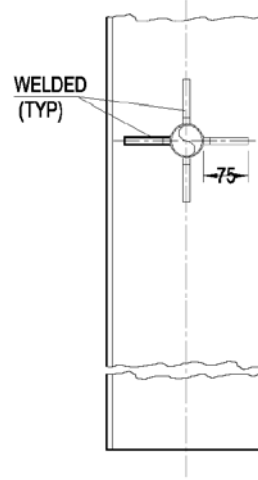
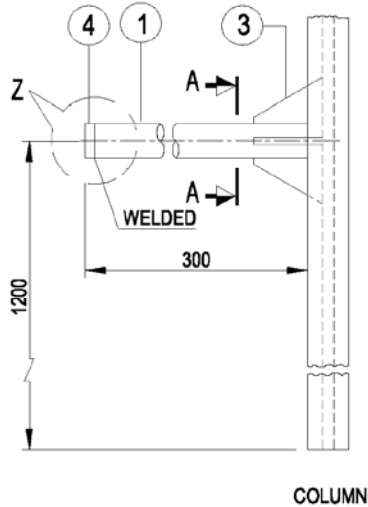

SECTION AT A - A

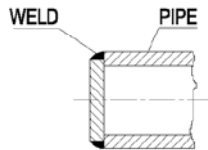

DETAIL OF 'Z'

NOTE :

1. GALVANISING / PAINTING AS REQUIRED.

PART NO.	DESCRIPTION	SIZE	MATL.	QTY.	REMARKS
4	COVER PLATE	4MM THK.	M.S	1 NO.	
3	RIBS (PLATE)	6MM THK.	M.S	4 NOS.	
1	PIPE	DN 50	G.I	0.5 MTR.	

P	16.07.2001	CONSTRUCTION DRAWING	DDCPN	CISC	DHPV
REV	DATE	PURPOSE	PREPARED	REVIEWED	APPROVED

SUPPORTING DETAILS FOR FIELD MOUNTED INSTRUMENTS

ES - 7013	P
DOCUMENT NO.	REV
SH.....09.....OF.....11.....	

PROTECTIVE BOX FOR FIELD MOUNTED INSTRUMENTS (FULLY ENCLOSED)

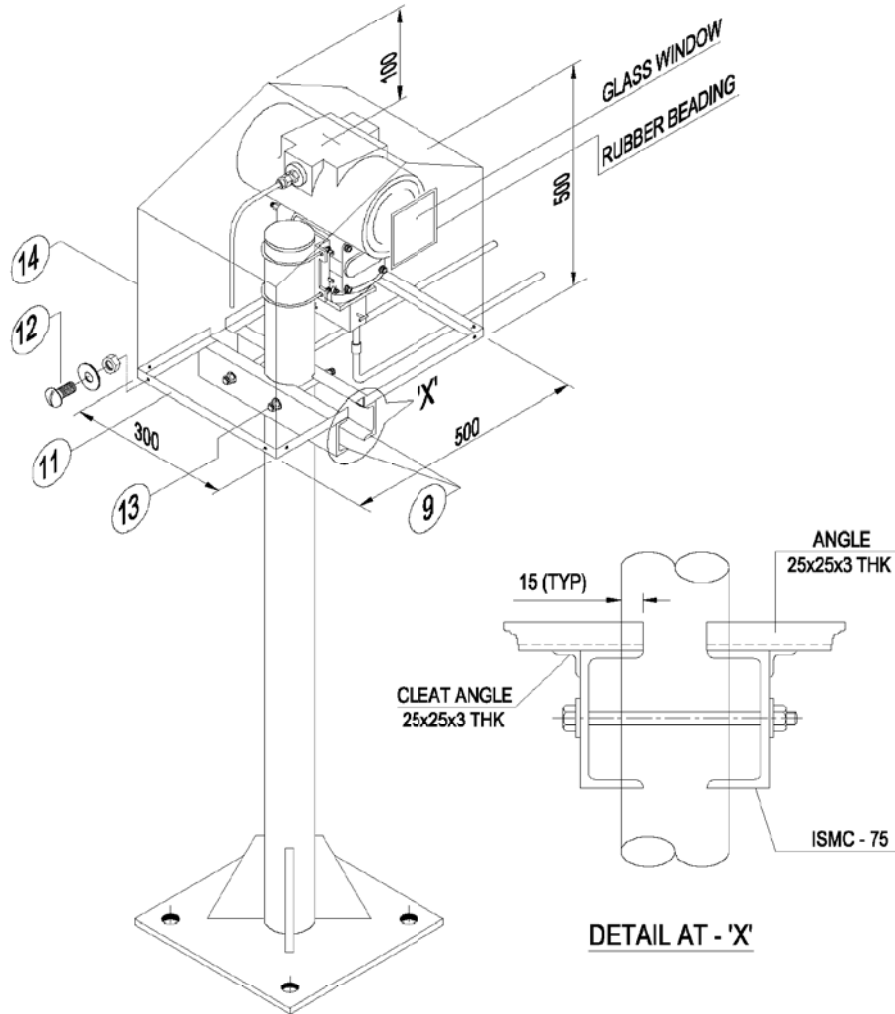

NOTE :

1. BOQ UNDER INSTRUMENT ERECTION CONTRACTOR'S SCOPE.

PART NO.	DESCRIPTION	SIZE	MATL.	QTY.	REMARKS
14	COVER SHEET	3MM THK.	ALUMINIUM	1.0 M ²	
13	BOLTS, NUTS AND WASHER	M-10 x 150MM LG	M.S	2 NOS.	
12	SCREW, NUT AND WASHER	M-4 x 15MM LG	M.S	8 NOS.	
11	ANGLE IRON	25 x 25 x 3	M.S	1.6 MTR.	
9	CHANNEL	75 x 40	M.S	0.6 MTR.	

P	16.07.2001	CONSTRUCTION DRAWING	DDCPN	CISC	DHPV
REV	DATE	PURPOSE	PREPARED	REVIEWED	APPROVED

SUPPORTING DETAILS FOR FIELD MOUNTED INSTRUMENTS

PROTECTIVE BOX FOR FIELD MOUNTED INSTRUMENTS (OPEN CANOPY TYPE)

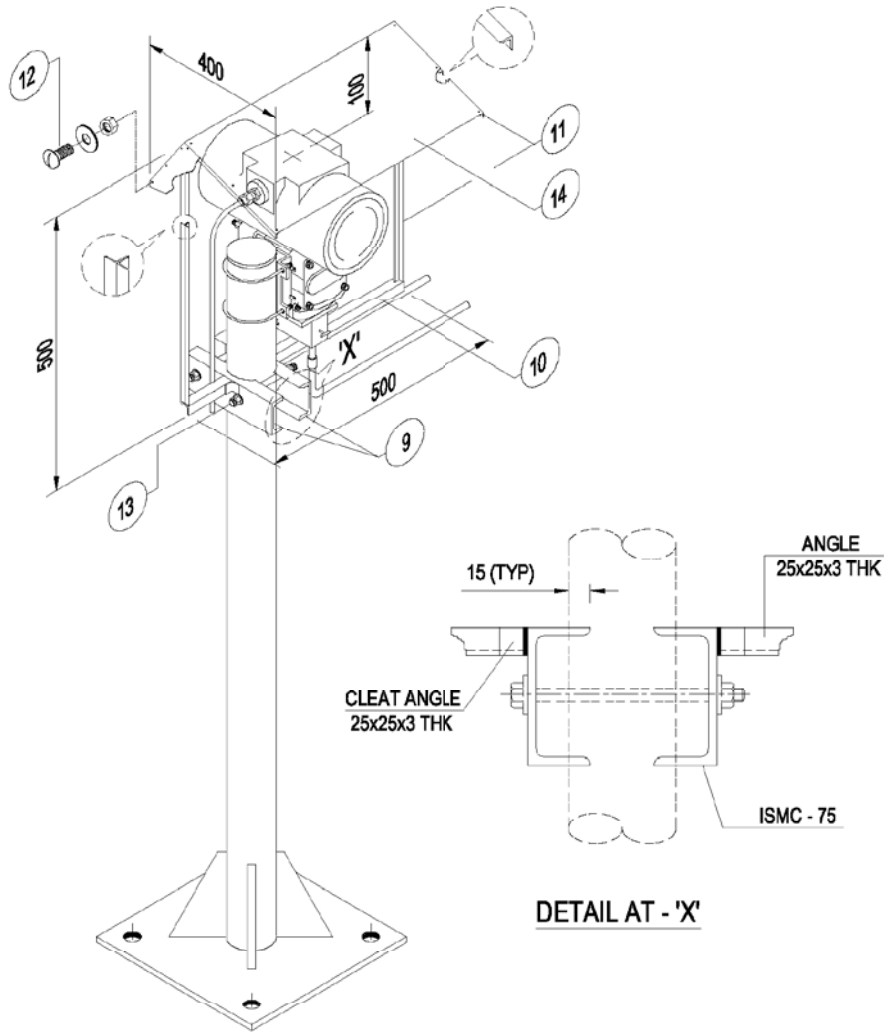

NOTE :

1. BOQ UNDER INSTRUMENT ERECTION CONTRACTOR'S SCOPE.

PART NO.	DESCRIPTION	SIZE	MATL.	QTY.	REMARKS
14	COVER SHEET	3 NM THK.	ALUMINIUM	1.0 M ²	
13	BOLTS, NUTS AND WASHER	M-10 x 150MM LG	M.S	2 NOS	
12	SCREW, NUT AND WASHER	M-4 x 15MM LG	M.S	24 NOS	
11	ANGLE IRON	25 x 25 x 3	M.S	3.0 MTR.	
10	ANGLE IRON	50 x 50 x 6	M.S	0.5 MTR.	
9	CHANNEL	75 x 40	M.S	0.3 MTR.	

P	16.07.2001	CONSTRUCTION DRAWING	DDCPN	CISC	DHPV
REV	DATE	PURPOSE	PREPARED	REVIEWED	APPROVED

PROTECTIVE BOX FOR FIELD MOUNTED INSTRUMENTS (ONE SIDE OPEN)

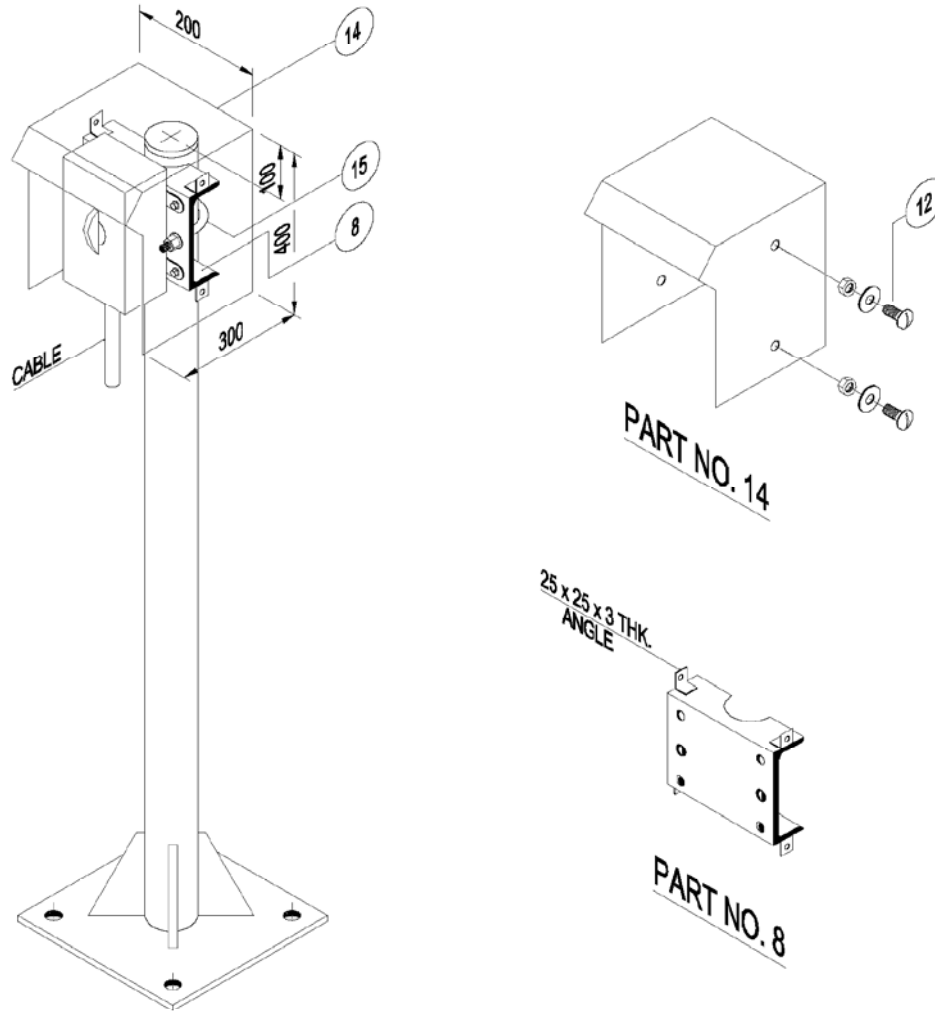

NOTE :

1. BOQ UNDER INSTRUMENT ERECTION CONTRACTOR'S SCOPE.

PART NO.	DESCRIPTION	SIZE	MATL.	QTY.	REMARKS
15	U - BOLT, NUTS & WASHERS	Ø10 MM	M.S.	1 NO.	
14	COVER SHEET	3 MM THK.	ALUMINIUM	0.3 M ²	
12	SCREW, NUT & WASHER	M-4 x 15 MM LONG	M.S.	4 NOS.	
8	CHANNEL	150 x 75	M.S.	0.2 MTR.	

P	16.07.2001	CONSTRUCTION DRAWING	DDCPN	CISC	DHPV
REV	DATE	PURPOSE	PREPARED	REVIEWED	APPROVED

CLAMPS FOR TUBES / CABLES

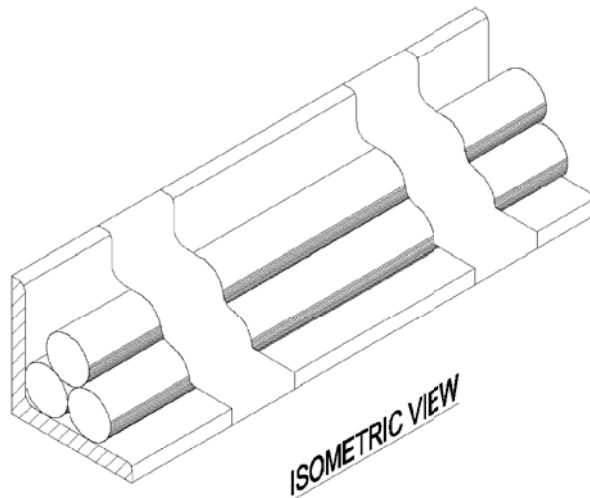

NOTE :

1. CLAMPS SHALL BE USED AT EVERY 1.0 METER INTERVAL.
2. BOQ UNDER INSTRUMENT CONTRACTOR'S SCOPE.

PART NO.	DESCRIPTION	SIZE	MATL.	QTY.	REMARKS
3	CLAMPING STRIP	20 MM WIDTH x 2MM THK.	AL	A/R	
2	ANGLE IRON	50x50x6	M.S	A/R	
1	ANGLE IRON	25x25x3	M.S	A/R	

P	16.07.2001	CONSTRUCTION DRAWING	DCCPN	CISC	DHPV
REV	DATE	PURPOSE	PREPARED	REVIEWED	APPROVED

CABLES TRAY SUPPORT

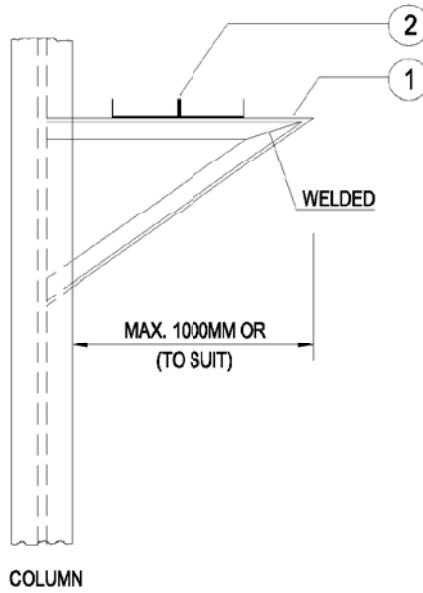

NOTE :

1. BOQ UNDER INSTRUMENT CONTRACTOR'S SCOPE.

PART NO.	DESCRIPTION	SIZE	MATL.	QTY.	REMARKS
2	CABLE TRAY	AS REQUIRED	AL	A/R	
1	ANGLE IRON	50 x 50 x 6	M.S	A/R	

P	16.07.2001	CONSTRUCTION DRAWING	DDCPN	CISC	DHPV
REV	DATE	PURPOSE	PREPARED	REVIEWED	APPROVED

CABLES TRAY SUPPORT

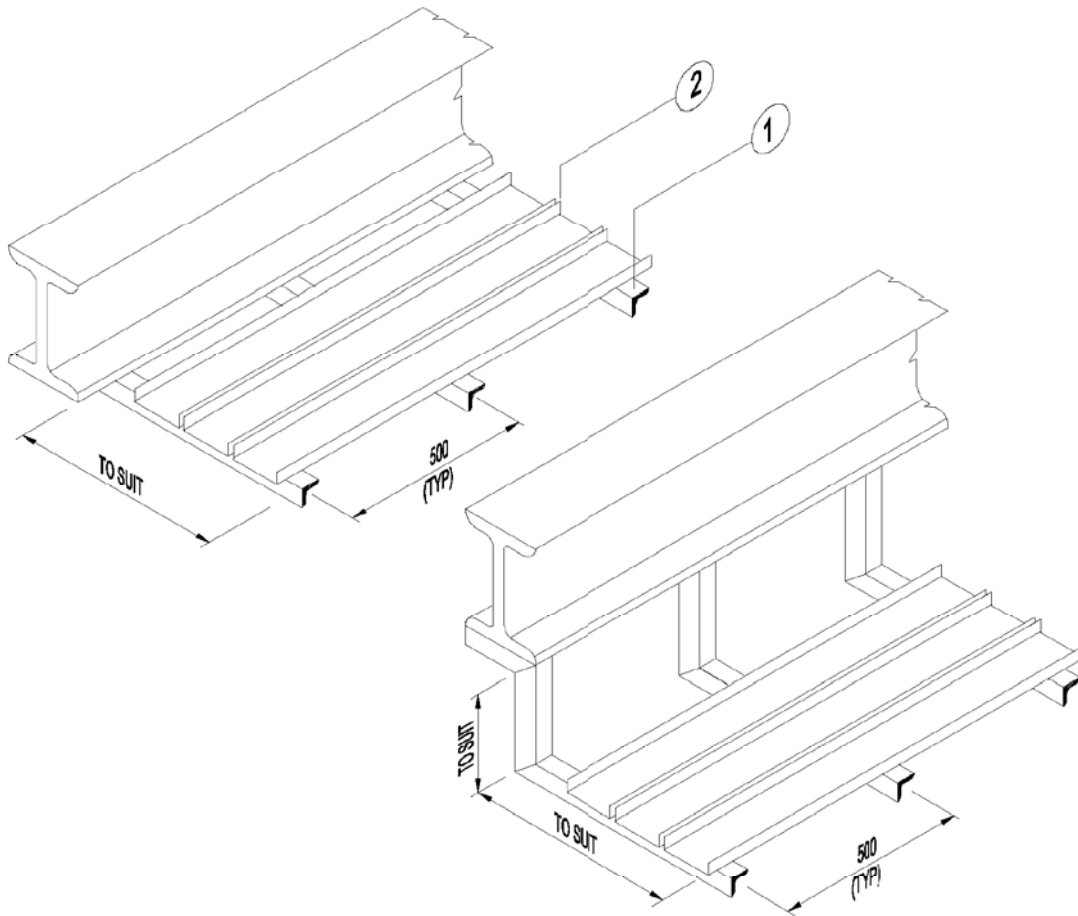

PART NO.	DESCRIPTION	SIZE	MATL	QTY.	REMARKS
2	CABLE TRAY	ASREQUIRED	AL	A/R	INST. CONTR. SCOPE
1	ANGLE IRON	50 x 50 x 6	M.S	A/R	CIVIL SCOPE

P	16.07.2001	CONSTRUCTION DRAWING	DDCPN	CISC	DHPV
REV	DATE	PURPOSE	PREPARED	REVIEWED	APPROVED

CABLES TRAY SUPPORT

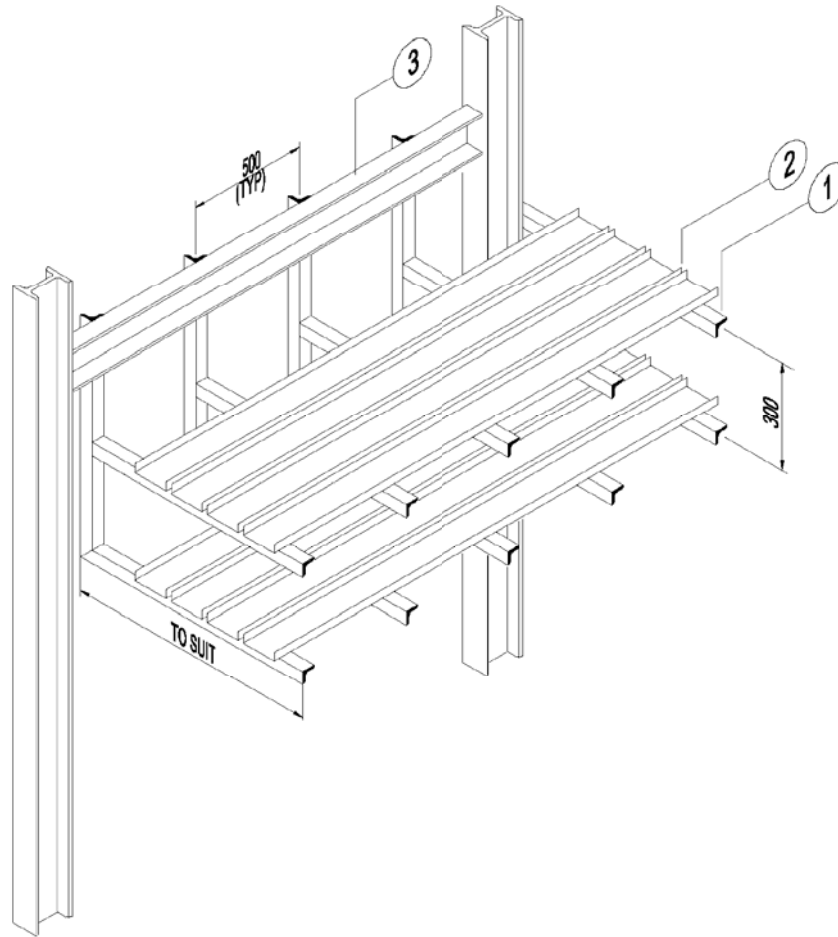

PART NO.	DESCRIPTION	SIZE	MATL.	QTY.	REMARKS
3	CHANNEL	MC 100	M.S	A/R	CIVIL SCOPE
2	CABLE TRAY	AS REQUIRED	AL	A/R	INST. CONTR. SCOPE
1	ANGLE IRON	50 x 50 x 6	M.S	A/R	CIVIL SCOPE

P	16.07.2001	CONSTRUCTION DRAWING	DDCPN	CISC	DHPV
REV	DATE	PURPOSE	PREPARED	REVIEWED	APPROVED

CABLES TRAY SUPPORT

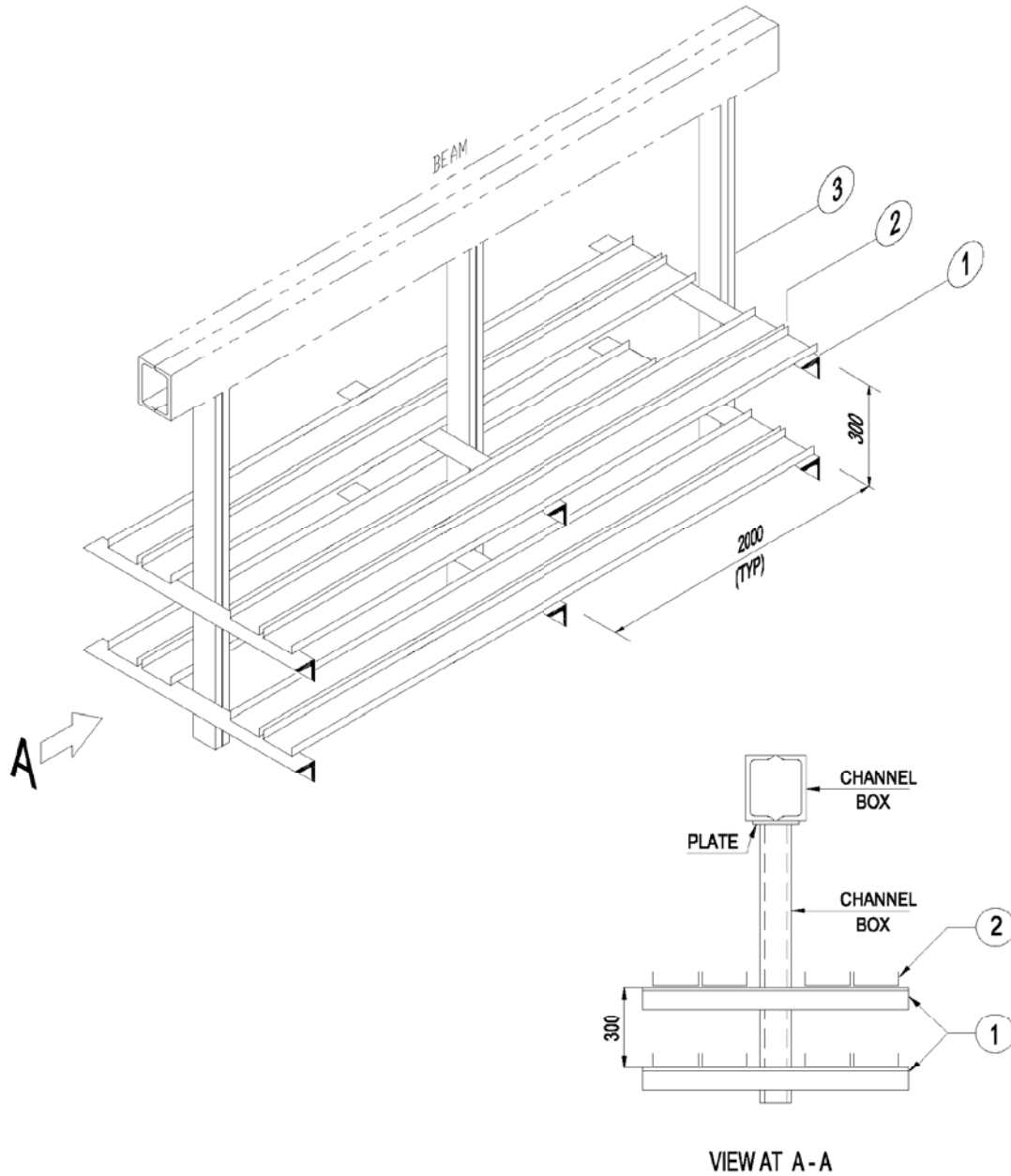

PART NO.	DESCRIPTION	SIZE	MATL.	QTY.	REMARKS
3	CHANNEL	MC 100	M.S	A/R	CIVIL SCOPE
2	CABLE TRAY	AS REQUIRED	AL	A/R	INST. CONTR. SCOPE
1	ANGLE IRON	50 x 50 x 6	M.S	A/R	CIVIL SCOPE

P	16.07.2001	CONSTRUCTION DRAWING	DDCPN	CISC	DHPV
REV	DATE	PURPOSE	PREPARED	REVIEWED	APPROVED

CABLES TRAY SUPPORT

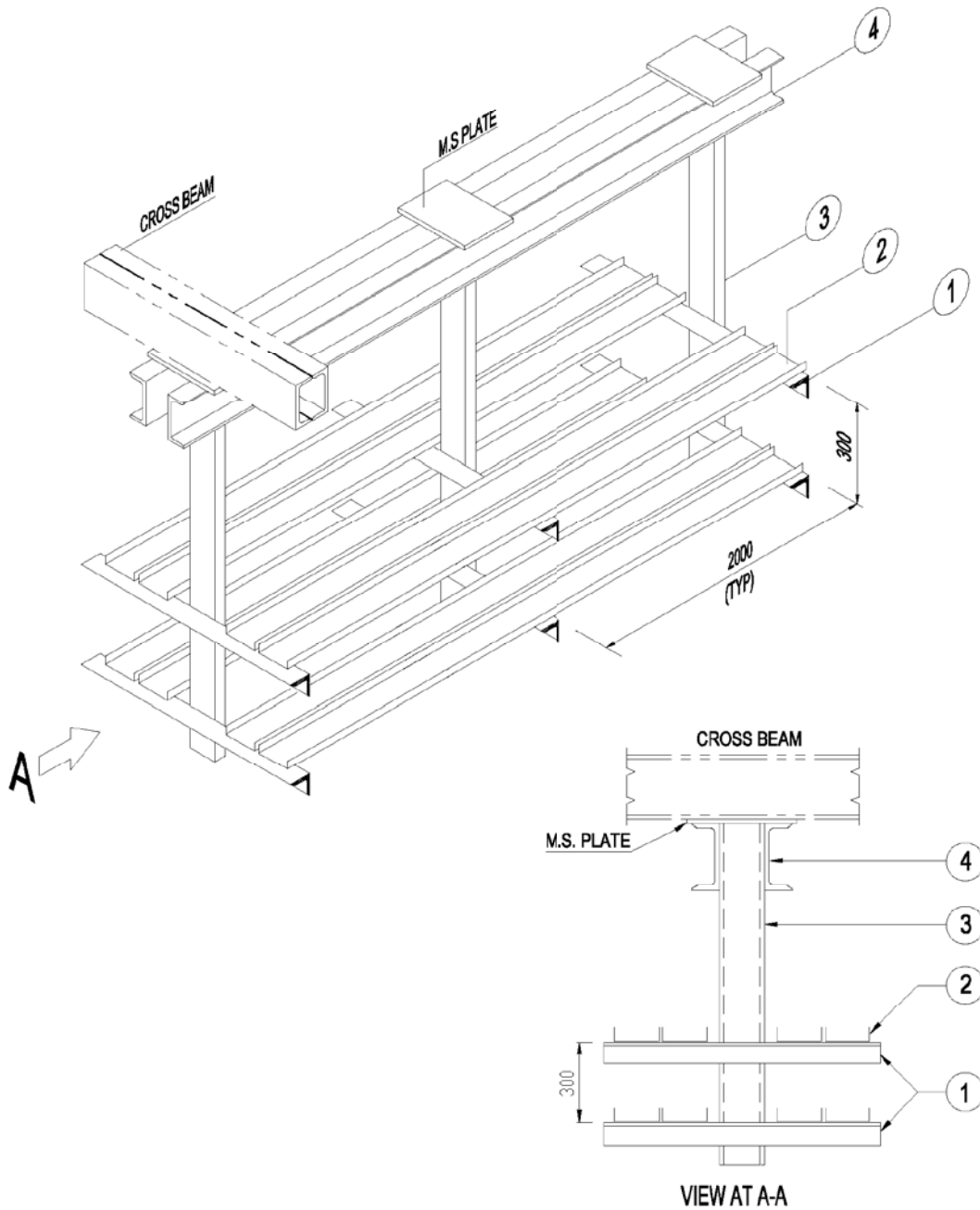

4	CHANNEL	MC 150	M.S	A/R	CIVIL SCOPE
3	CHANNEL	MC 100	M.S	A/R	CIVIL SCOPE
2	CABLE TRAY	AS REQUIRED	AL	A/R	INST. CONTR. SCOPE
1	ANGLE IRON	50 x 50 x 6	M.S	A/R	CIVIL SCOPE
PART NO.	DESCRIPTION	SIZE	MATL.	QTY.	REMARKS

P	16.07.2001	CONSTRUCTION DRAWING	DDCPN	CISC	DHPV
REV	DATE	PURPOSE	PREPARED	REVIEWED	APPROVED

CABLES TRAY SUPPORT

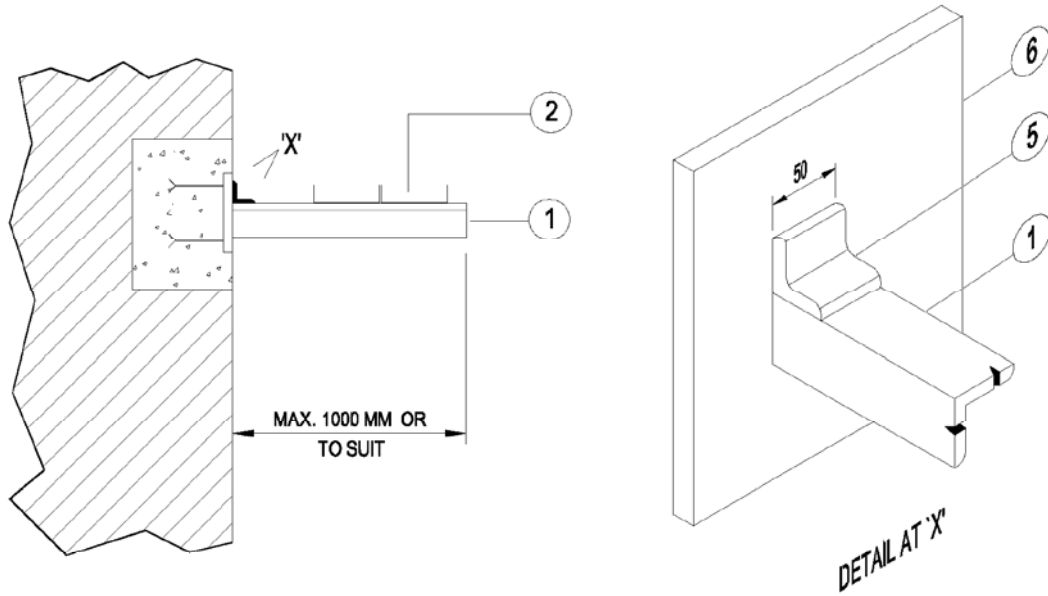

PART NO.	DESCRIPTION	SIZE	MATL.	QTY.	REMARKS
6	INSERT PLATE	150x150x6	M.S	A/R	CIVIL SCOPE
5	CLEAT ANGLE IRON	25x25x3	M.S	A/R	INST. CONTR. SCOPE
2	CABLE TRAY	AS REQUIRED	AL	A/R	INST. CONTR. SCOPE
1	ANGLE IRON	50x50x6	M.S	A/R	INST. CONTR. SCOPE

P	16.07.2001	CONSTRUCTION DRAWING	DDCPN	CISC	DHPV
REV	DATE	PURPOSE	PREPARED	REVIEWED	APPROVED

CABLES TRAY SUPPORT

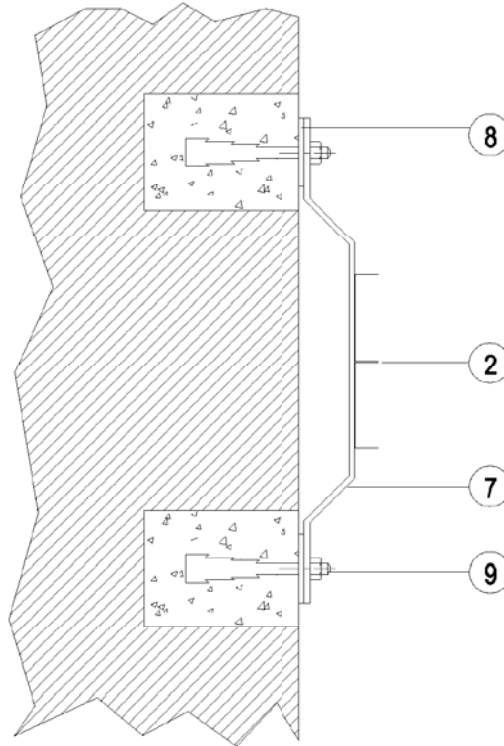

NOTE :

1. BOQ UNDER INSTRUMENT CONTRACTOR'S SCOPE.

PART NO.	DESCRIPTION	SIZE	MATL.	QTY.	REMARKS
9	RAG BOLT	Ø10MMx150MM LG.	M.S	2 NOS.	
8	WASHER	Ø25MMx3MM THK.	M.S	2 NOS.	
7	FLAT	50 x 4	M.S	A/R	
2	CABLE TRAY	AS REQUIRED	AL	A/R	

P	16.07.2001	CONSTRUCTION DRAWING	DDCPN	CISC	DHPV
REV	DATE	PURPOSE	PREPARED	REVIEWED	APPROVED

FIXING DETAIL OF TRAY

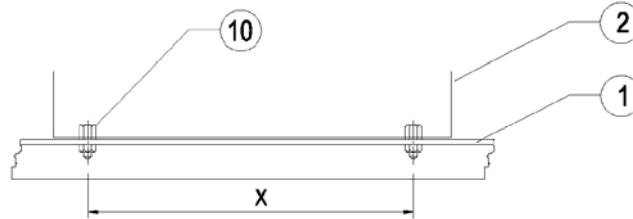

SECTION A - A

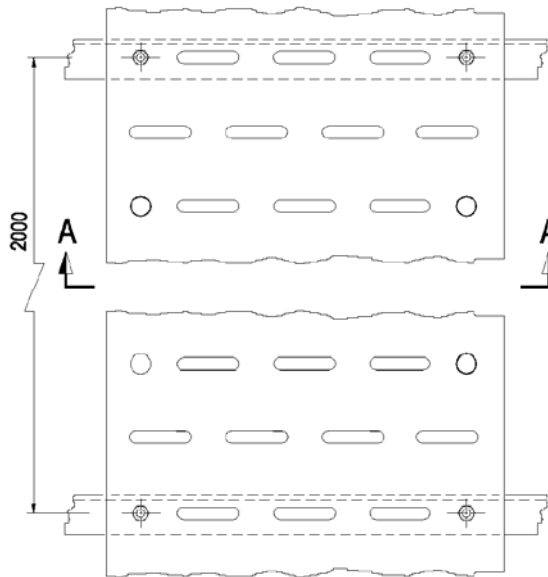

NOTE :

1. DIMENSION 'X' VARY ACCORDING TO SIZE OF TRAY.
2. BOQ UNDER INSTRUMENT CONTRACTOR'S SCOPE.

PART NO.	DESCRIPTION	SIZE	MATL.	QTY.	REMARKS
10	BOLTS & NUTS WITH WASHER	Ø6MMx30LG	M.S	A/R	
2	CABLE TRAY	AS REQUIRED	AL	A/R	
1	ANGLE IRON	50x50x6	M.S	A/R	

P	16.07.2001	CONSTRUCTION DRAWING	DDCPN	CISC	DHPV
REV	DATE	PURPOSE	PREPARED	REVIEWED	APPROVED

CABLES TRAY CONNECTIONS

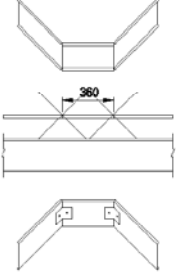
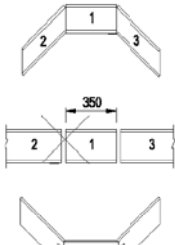
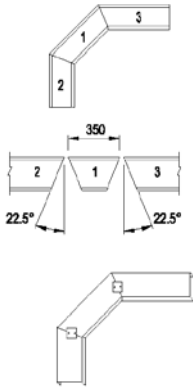
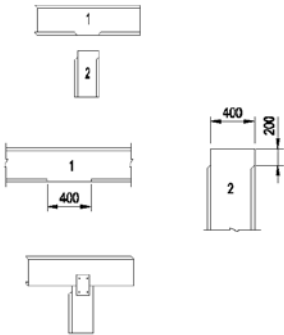
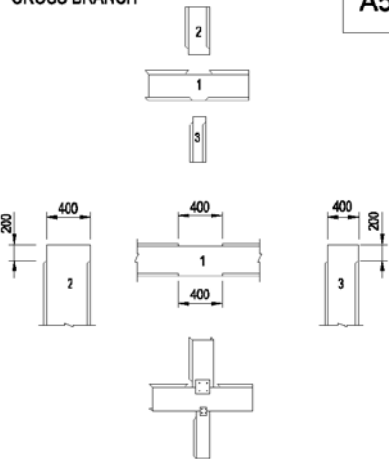
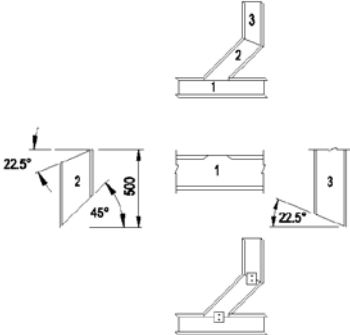
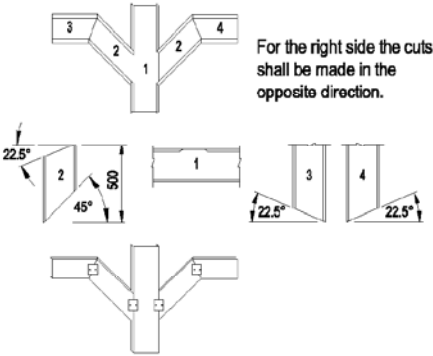
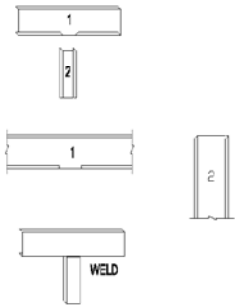
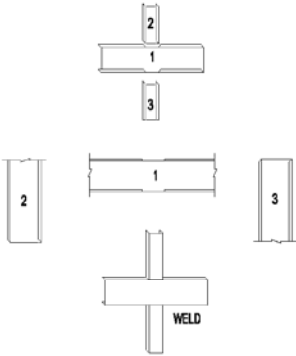
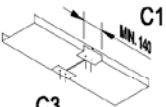
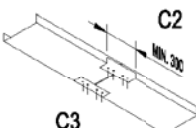
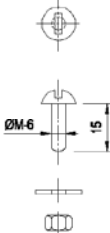
<p>90° CONNECTION</p>  <p>Connecting plate bend to an angle of 135°</p>	<p>90° CONNECTION</p>  <p>Connecting plate bend to an angle of 135°</p>	<p>90° CONNECTION</p> 			
<p>TEE BRANCH</p> 	<p>CROSS BRANCH</p> 	<p>TEE BRANCH WITH CONNECTION</p> 			
<p>CROSS BRANCH WITH CONNECTION</p>  <p>For the right side the cuts shall be made in the opposite direction.</p>	<p>TEE BRANCH WITH STRUCTURAL SHAPES</p>  <p>WELD</p>	<p>CROSS BRANCH WITH STRUCTURAL SHAPES</p>  <p>WELD</p>			
<p>CONNECTING PARTS</p>  <p>C3</p> <p>Coupling of two raceway section (Max. width 150 mm) the connection shall made by only one point (C1)</p>	<p>CONNECTING PARTS (FOR CAPACITIES OVER 50KG/M)</p>  <p>C3</p> <p>Coupling of two raceway section (min. width 200 mm) the connection shall made by two point (C2)</p>	<p>FASTENING SCREW</p> 			
<p>P</p>	<p>16.07.2001</p>	<p>CONSTRUCTION DRAWING</p>	<p>DDCPN</p>	<p>CISC</p>	<p>DHPV</p>
<p>REV</p>	<p>DATE</p>	<p>PURPOSE</p>	<p>PREPARED</p>	<p>REVIEWED</p>	<p>APPROVED</p>

EXAMPLES OF REALIZATION OF RACEWAY ROUTING WITHOUT USING SPECIAL ELEMENTS

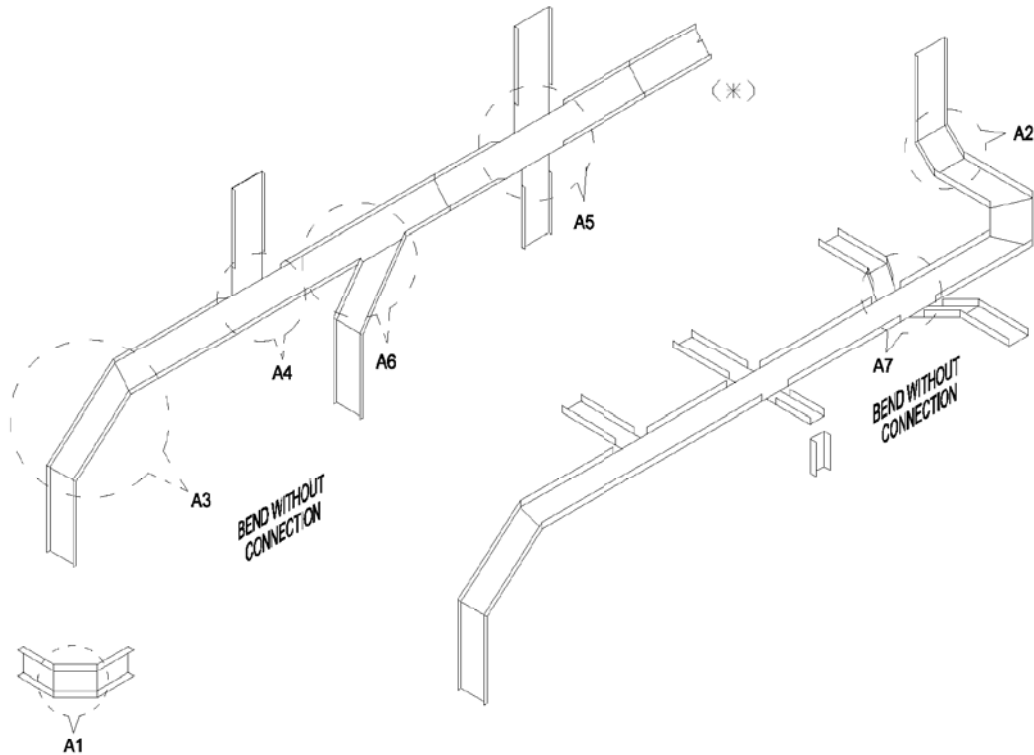

EXAMPLES OF REALIZATION OF RACEWAY ROUTING WITHOUT USING SPECIAL ELEMENTS

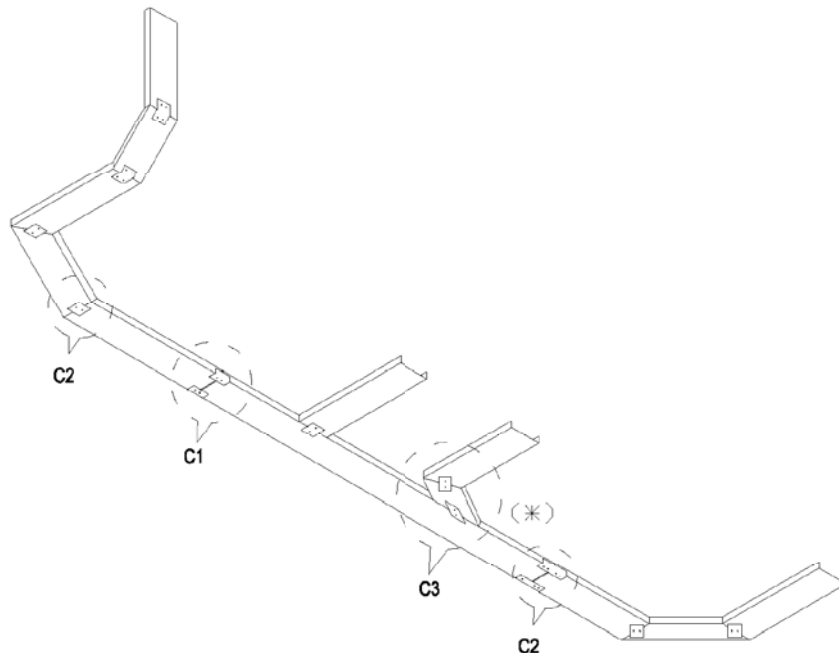

NOTE :

* Realization to be performed for installation of raceways on different orthogonal planes.

P	16.07.2001	CONSTRUCTION DRAWING	DDCPN	CISC	DHPV
REV	DATE	PURPOSE	PREPARED	REVIEWED	APPROVED

CABLES TRAY CONNECTIONS

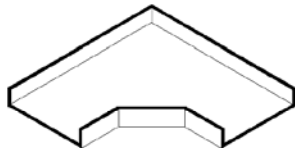
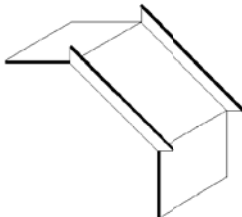
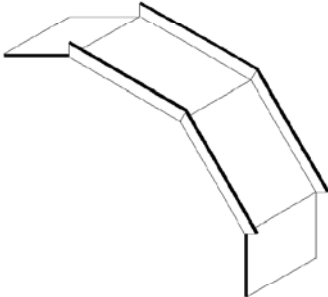
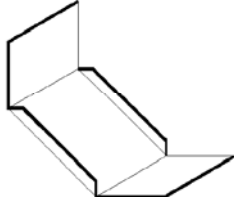
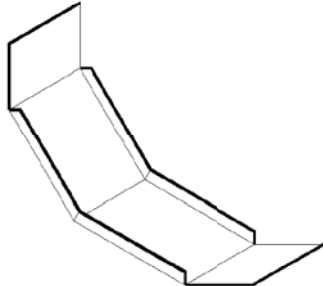
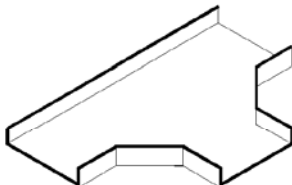
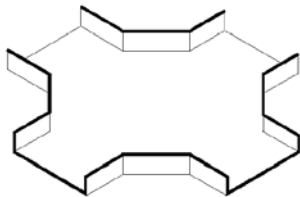
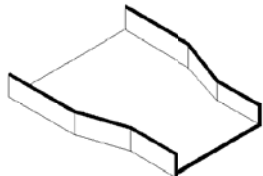
<p>90° CONNECTION</p> <p style="text-align: right;">B1</p> 	<p>90° CONNECTION</p> <p style="text-align: right;">B2</p> 	<p>90° CONNECTION</p> <p style="text-align: right;">B3</p> 
<p>90° CONNECTION</p> <p style="text-align: right;">B4</p> 	<p>90° CONNECTION</p> <p style="text-align: right;">B5</p> 	<p>TEE BRANCH</p> <p style="text-align: right;">B6</p> 
<p>CROSSING</p> <p style="text-align: right;">B7</p> 	<p>REDUCER</p> <p style="text-align: right;">B8</p> 	<p style="text-align: right;">B9</p>

P	16.07.2001	CONSTRUCTION DRAWING	DDCPN	CISC	DHPV
REV	DATE	PURPOSE	PREPARED	REVIEWED	APPROVED

EXAMPLE OF REALIZATION OF RACEWAY WITH THE USE OF SPECIAL ELEMENTS

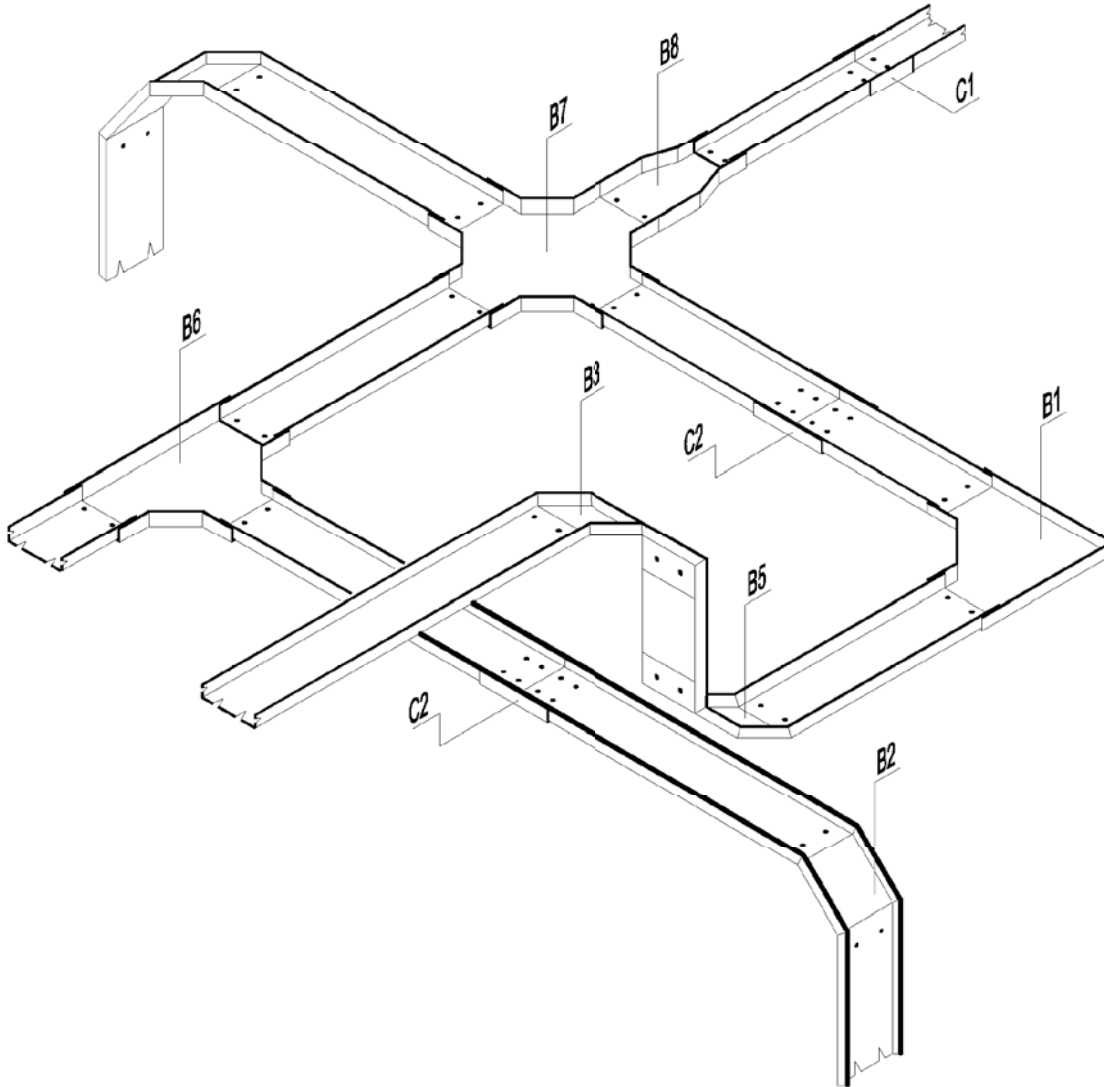

P	16.07.2001	CONSTRUCTION DRAWING	DDCPN	CISC	DHPV
REV	DATE	PURPOSE	PREPARED	REVIEWED	APPROVED

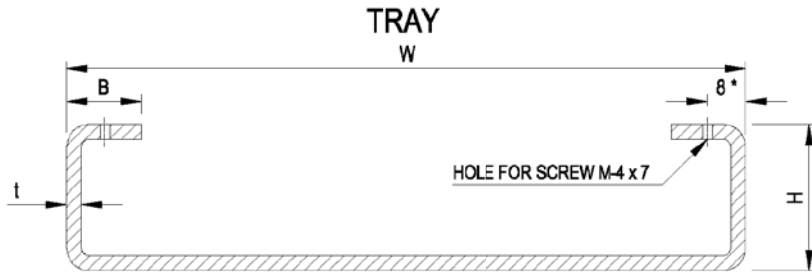

* FOR TRAYS OF 200MM , 300MM & 400MM

W (mm)	H (mm)	B (mm)	t (mm)	REMARKS
50	20	5	2	2500 mm LENGTH
100	35	10	2	2500 mm LENGTH
150	35	10	2	2500 mm LENGTH
200	55	15	3	2500 mm LENGTH
300	65	20	3	2500 mm LENGTH
400	65	20	3	2500 mm LENGTH

TRAY COVER

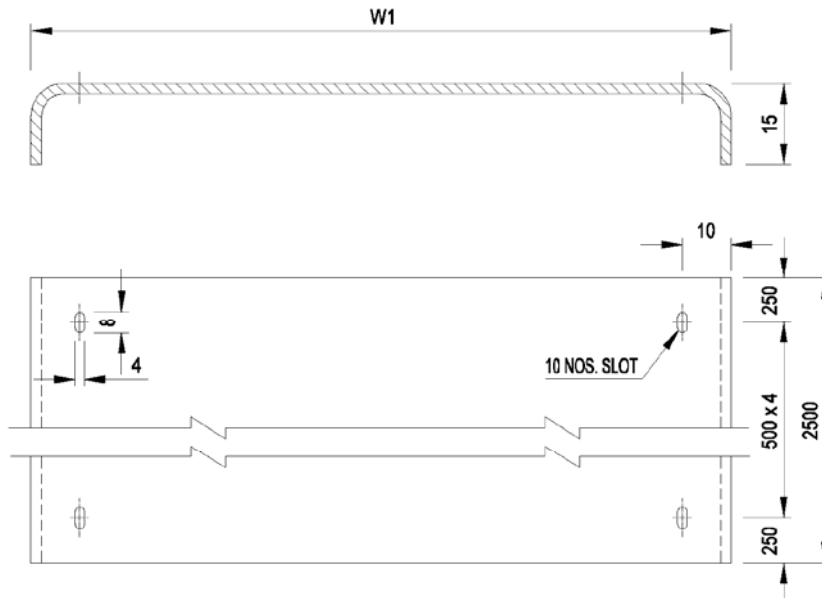

W1 (mm)	THICKNESS (mm)	REMARKS
204	2	2500 mm LENGTH
304	2	2500 mm LENGTH
404	2	2500 mm LENGTH

P	16.07.2001	CONSTRUCTION DRAWING	DDCPN	CISC	DHPV
REV	DATE	PURPOSE	PREPARED	REVIEWED	APPROVED

DETAILS OF TRENCH FOR UNDER GROUND INSTRUMENTS CABLES

ES - 7017	P
DOCUMENT NO.	REV
SH.....01.....OF.....01.....	

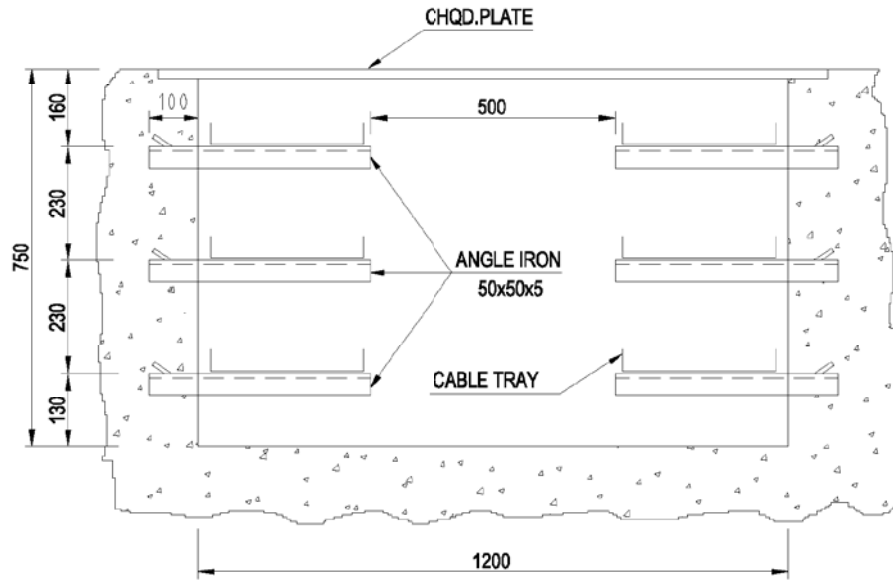

TYPE - A

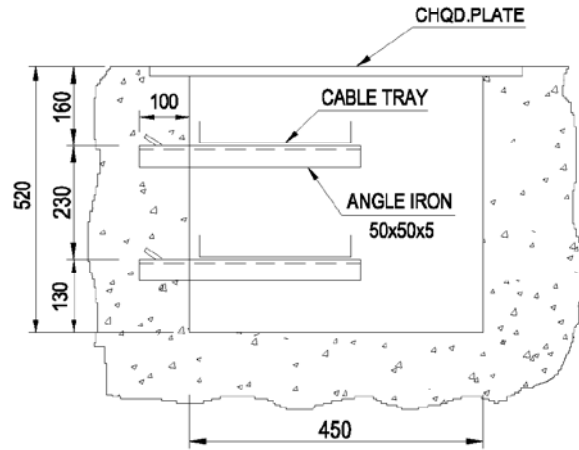

TYPE - B

NOTE :

- 1. TRAY SUPPORTS WILL BE PROVIDED AT 1000MM. INTERVALS.**

P	16.07.2001	CONSTRUCTION DRAWING	DDCPN	CISC	DHPV
REV	DATE	PURPOSE	PREPARED	REVIEWED	APPROVED

MOUNTING DETAILS OF JUNCTION BOX

ES - 7018

P

DOCUMENT NO.

REV

SH. 01 OF 03

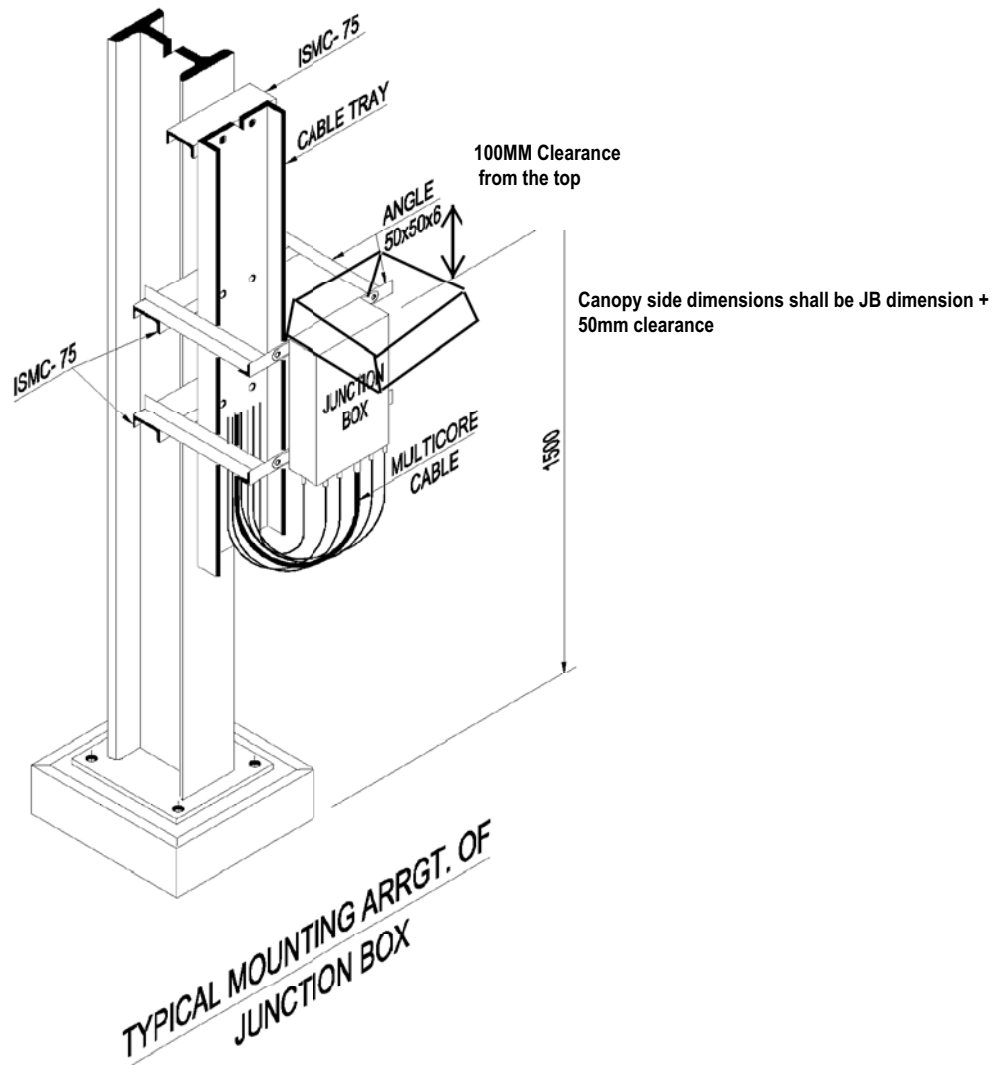

NOTE :

1. ALL ITEMS UNDER INSTRUMENT CONTRACTOR'S SCOPE.

P	16.07.2001	CONSTRUCTION DRAWING	DDCPN	CISC	DHPV
REV	DATE	PURPOSE	PREPARED	REVIEWED	APPROVED

MOUNTING DETAILS OF JUNCTION BOX

ES - 7018

P

DOCUMENT NO.

REV

SH. 02 OF 03

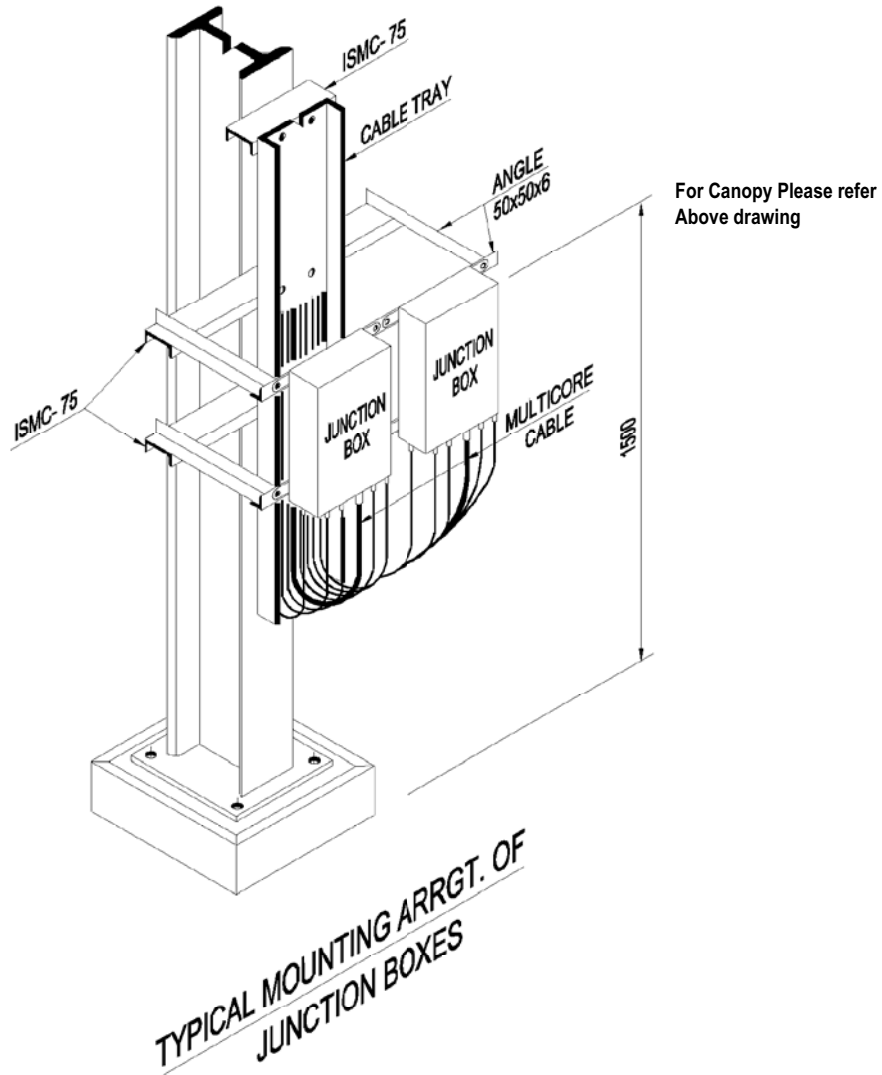

NOTE :

1. ALL ITEMS UNDER INSTRUMENT CONTRACTOR'S SCOPE.

P	16.07.2001	CONSTRUCTION DRAWING	DDCPN	CISC	DHPV
REV	DATE	PURPOSE	PREPARED	REVIEWED	APPROVED

MOUNTING DETAILS OF JUNCTION BOX

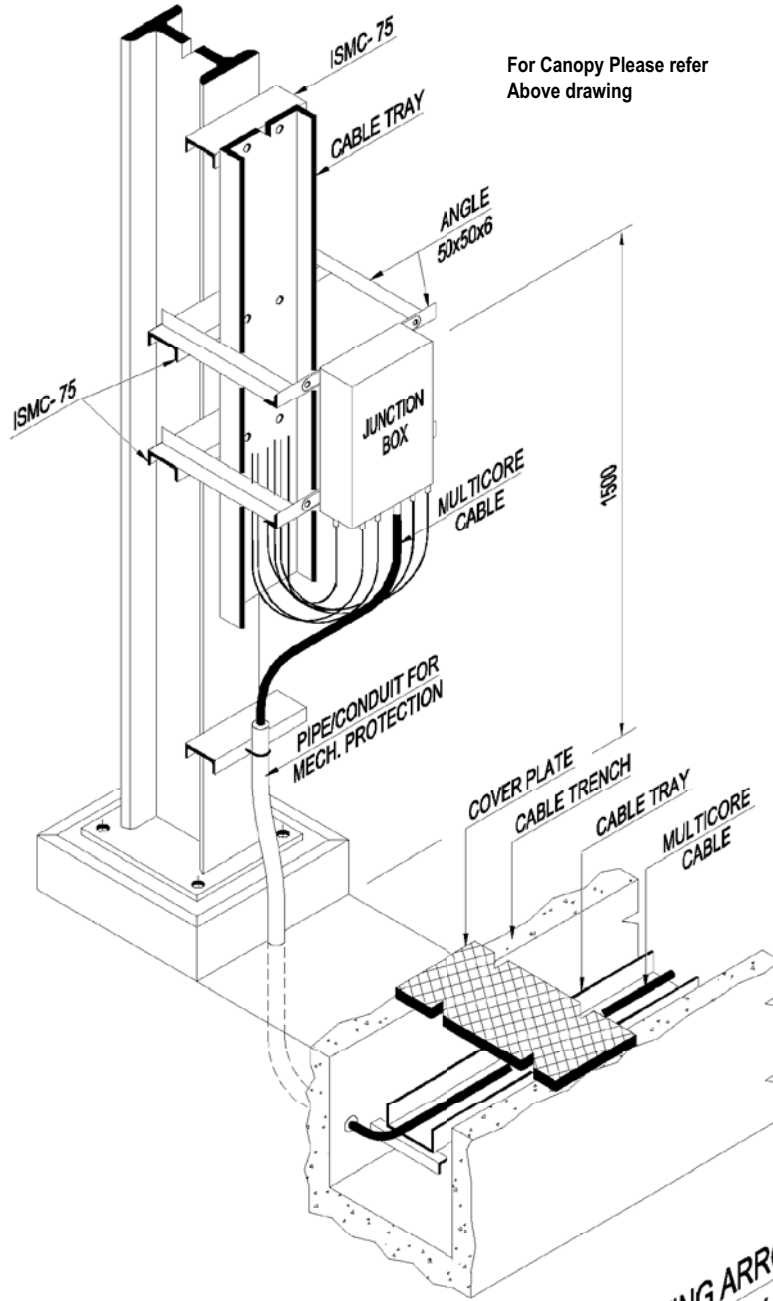

**TYPICAL MOUNTING ARRGT. OF
JUNCTION BOX**

NOTE :

1. ALL ITEMS UNDER INSTRUMENT CONTRACTOR'S SCOPE.

P	16.07.2001	CONSTRUCTION DRAWING	DDCPN	CISC	DHPV
REV	DATE	PURPOSE	PREPARED	REVIEWED	APPROVED

	PROJECTS & DEVELOPMENT INDIA LTD	E-7099	0
		DOCUMENT NO.	REV
		SHEET 1 OF 17	

SCOPE AND GENERAL GUIDELINES FOR CCTV NETWORK SYSTEM



Prepared by
PROJECTS & DEVELOPMENT INDIA LTD
(A GOVT OF INDIA UNDERTAKING)
 PMC BHAWAN, A-14,
 SECTOR 1, NOIDA

	PROJECTS & DEVELOPMENT INDIA LTD	E-7099	0
		DOCUMENT NO.	REV
		SHEET 2 OF 17	

A. SCOPE OF THE TENDER

This specification defines the minimum requirements of design, configuration, manufacturing, Engineering, programming, inspection and testing, documentation, installation, commissioning and shipping of CCTV system which shall be installed in OSBL facilities and surveillance of Talcher Fertilizer complex . Selected system shall be latest & proven model with minimum one year proven track record (PTR) . All equipment's / instruments / system oriented items (with all its sub-systems) shall be of field proven quality both with respect to design and materials. Prototype instruments or instruments of an experimental nature shall not be offered or supplied. No instrument requiring special maintenance or operating facilities shall be offered or supplied as far as possible. PTR shall be one year.

B. DEFINITION

OWNER: TFL

CONSULTANT: PDIL

BIDDER: SUPPLIER OR MANUFACTURER OF EQUIPMENT AND SERVICES.

C. REFERENCE STANDARD

The following publications shall form a part of this Specification. Unless otherwise specified herein, use the latest edition or revision.

ANSI/ASME	American National Standards Institute/American Society of Mechanical Engineers.
B 1.20.1	Pipe Threads General Purpose (Inch)
B 16.5	Steel Pipe Fittings and Flanged Fittings, NPS 1/2" through NPS 24
EN-I 0204	Inspection Documents For Metallic Products
IEC-60079	Electrical Apparatus for Explosive Gas Atmospheres
IEC- 60529	Degree of Protection Provided by Enclosures (IP Code)
rs- 13947	Specification for Low Voltage Switchgear and Control gear
IS- 2148	Electrical Apparatus for Explosive Gas Atmosphere - Flameproof enclosures'd'
ISA S-5 .1	Instrumentation Symbols and Identification
ANSI/ ISA S71.04	Environmental conditions
EN-50-014/020	Electrical Apparatus for Potentially Explosive Atmospheres
IEC 529	Environmental Protection of equipment
IS 2148	Flameproof enclosure of electrical apparatus?

D. SCOPE OF SUPPLY

Complete CCTV System with all accessories like Cameras, power supply , JB , LIU, media convertor, OFC convertor, 22" LED workstation , server, VMS ,NAS for 365 days storage , one LED 72" ceiling mounted with 100 windows , software , license , surveillance software , analytical software , all cables, all mounting accessories , poles , civil works etc. (Also refer SOR also).

- Fixed cameras & PTZ cameras
- Encoders, Fiber Optic convertors etc shall be considered by CCTV Vendor as per his system configuration requirement etc.

	PROJECTS & DEVELOPMENT INDIA LTD	E-7099	0
		DOCUMENT NO.	REV
		SHEET 3 OF 17	

- Junction box for CCTV camera.
- Bidder shall locate all the electronics in the CCTV panel
- All types of video signal cable between camera and CCTV cabinet, junction box etc.
- All network accessories such as FO converters, LIU's, patch cord and other accessories required for FO connectivity shall be considered by Vendor.

E. DESIGN REQUIREMENTS

This is meant only for Original Equipment Manufacturer (OEM) of IP Surveillance Cameras, Video Management software and other electronic security system along with other necessary hardware and software for Video Recording purpose.

The manufacturers proposed by the bidders should meet the following basic pre-qualification conditions:

1. All Surveillance Equipment such as CCTV Cameras, Network Video Recording & Management Software, CCTV Recording application shall be from the same OEM/Brand to avoid compatibility related issues and ensure smooth operation, maintenance.
2. The parent company of OEM or OEM itself shall have at least ISO 9001:2015 certified software Research & Development center in India.
3. All CCTV cameras offered in the project for safe area shall be UL & CE and FCC certified. RoHS is mandatory certification for cameras in compliance to "E-Waste Rule, 2011". OEMs with Manufacturing facility in India must comply with "E-Waste Rule, 2011" requirement for manufacturing facility.
4. As per cyber security process offered cameras must be free for known high vulnerabilities. The cameras proposed in this tender shall also provide secure data streams by encrypted firmware. Also CCTV OEM shall certify that MAC ID (identity of camera) of camera is registered with their name and has not been altered.
5. All cameras, hardware and software does not comply to GB28181, GB/T28181-2011, GBT28181-2011, GBT standards & protocols. Neither there is no option to activate/deactivate GB/T28181 in the camera web page & settings.
6. All the CCTV cameras shall be ONVIF compliant to maintain the open/heterogeneous environment. The ONVIF compliance shall be of latest standards i.e. Profile S, G,T.
7. OEM of Camera & Software shall be full member of ONVIF Committee. There should be no ONVIF membership restrictions on Camera & VMS OEMs, this means that OEMs can participate in ONVIF committees which include ONVIF new profile development and maintenance. Similarly, OEMs can use new ONVIF tools and software for camera testing. The bidder shall submit a declaration in this regard from the OEM.
8. OEM listed on ONVIF certificate should not be from countries sharing land border with India.

	PROJECTS & DEVELOPMENT INDIA LTD	E-7099	0
		DOCUMENT NO.	REV
		SHEET 4 OF 17	

9. The CCTV OEM should be an official HEVC Licensee for using the genuine legal H.265 compression. The Bidder shall submit documentary proof in this regard
10. OEM for CCTV shall have authorized CCTV service/repair facility in nearest metropolitan city. OEM shall have Toll free call center for technical support.
11. OEM of Camera & Software shall have its own registered company in India for more than 10 years. The acceptable country of origin of Parent Company or Promoter of OEM shall not belong to countries sharing land border with India. Any OEM having joint venture or subsidiary relationship with companies belonging to countries sharing land border with Indiashall not be acceptable.
12. The CCTV OEM shall have completed minimum 10 years of business operations by March 2021, in India. If the OEM is part of larger group/parent company diversified into multiple manufacturing business, only CCTV division would be taken into account for qualification purpose. Any representation through a channel/business/Joint-Venture partner or dealer or distributor shall not be considered as OEM.
13. Certificate of registration in India shall be submitted as documentary proof. Origin of parent company has to be declared.
14. Offered CCTV solution shall be seamlessly integrated with Access Control System as a future requirement of project.
15. The Indian subsidiary of OEM of CCTV camera should have past track record of minimum 6 years in selling, maintaining and providing customer support on IP based Cameras in India. The Bidder has to submit the declaration from CCTV OEM in this regard.
16. Successful Technical bids shall mean the bidder declared technically successful strictly based on the layout, design parameters, OEM technical requirements, terms & conditions and specifications given in the tender document.
17. OEM shall submit compliance on all above points with technical bid. Technical bid shall not be acceptable without confirming these points.
18. All the documents submitted shall be ink signed and stamped by competent authority or authorized signatory. The Authorized Signatory shall be liable under applicable laws for submission of any forged documents.

The CCTV camera unit shall be capable of withstanding plant vibration level of 2. 1 G (within the frequency range of 5 Hz to 200 Hz) and sudden shocks of level 5 G (with frequency of 2 Hz). Any vibration pads required to meet this requirement shall be in Vendor's scope of supply. Network switches (Layer-2 Managed) of reputed make. All cable glands, as required, for camera enclosure, pan tilt unit, junction boxes, CCTV cabinet etc. shall be Ex-proof, SS316 double compression type.

	PROJECTS & DEVELOPMENT INDIA LTD	E-7099	0
		DOCUMENT NO.	REV
		SHEET 5 OF 17	

Technical Specification

1. Camera Specification

CCTV System shall have the following features:

- End to End Encryption with AES-128/256 & TLS 1.2
- Denial of service protection
- Encrypted database communication
- Video Encryption
- Restriction of ports, protocols and services
- System auditing, alerting and management
- Customizable user access and permissions
- Housing of Cameras shall be from the same OEM as of cameras
- All CCTV cameras and VMS shall be ONVIF compliant to maintain the open/heterogeneous environment. The ONVIF compliance shall be of latest standards. There should be no ONVIF membership restrictions on OEMs of CCTV Cameras and VMS, this means that OEMs can participate in ONVIF committees which include ONVIF new profile development and maintenance. Similarly, OEMs can use new ONVIF tools and software for camera testing. The bidder shall submit a declaration in this regard from the OEM.
- The CCTV OEM should be an official HEVC Licensee for using the genuine legal H.265 compression. The Bidder shall submit documentary proof in this regard.
- All the Cameras / components / parts / assembly / software used in the offered hardware and software must not be complying to GB28181, GB/T 28181-2011; GBT 28181-2011 protocols/ standards and there should be no option to activate or deactivate GB/T 28181 standards in the camera web page/Settings.
- To avoid any kind of patent infringement claims, all software products, hardware products, firmware, use of patented technology etc. offered should be licensed to OEM's name.
- Video Management Software, Joystick and all type of Cameras shall be from same OEM.

1.1 IP Weather-Proof Varifocal Camera

S. No.	Parameter/ Component	Minimum Specification
1.	General	IP, True Day/Night, Outdoor, 5MP Varifocal Motorized Camera, POE Enabled, ONVIF Compliant, aluminum construction and factory fitted housing of same make
2.	Lens focal length	Min 2.7- 13.5 MM lens, Motorized zoom and focus
3.	Image Sensor	1/2.8" or higher size CCD/CMOS/MOS sensor
4.	Resolution	Min 5 MP (2592 X 1944) @ 25 fps or better
5.	Minimum illumination	Normal Mode: Min 0.08 Lux Night Mode: Min 0.005 Lux IR ON: 0 Lux (IR distance up to 60 Meters)
6.	S/N Ratio	50 dB
7.	Video streaming	Three streams: 1. Primary (View): H.265 – Min 2592 X 1944, 1920x1080

	PROJECTS & DEVELOPMENT INDIA LTD	E-7099	0
		DOCUMENT NO.	REV
		SHEET 6 OF 17	

		2. Secondary (Storage): H.265 -Min 1280x720 3. Tertiary: H.265/H.264/MJPEG- Min 640x480
8.	Image features	BLC, 1/30000 ~ 1/30 shutter speed
9.	WDR	120 dB
10.	Protocols	IPv4, IPv6, TCP / IP, HTTP, IGMP, DHCP, NTP, DDNS
11.	Video Analytics	Camera shall have following video analytics as minimum: Intrusion Detection, Loitering Detection and Smart Motion Detection Video Analytics event linkage shall be available in camera with event notification using digital output, email and micro-SD card recording
12.	Operating temperature	-30°C - 60 °C or better
13.	Ingress Protection	IP67 and IK10 Impact Resistance or Better
14.	Audio	Line input and Line output, Dual-Channel
15.	Audio Compression	G.711a/ G.711u
16.	Alarm Terminal	Minimum 1 input, 1 relay output
17.	Defog	Required (ON/OFF), Selectable
18.	Local storage	Minimum 256GB SDXC/SDHC/ Micro SD card slot along with 128GB SD card
19.	Certification	UL 62368-1/IEC 62368-1, CE, FCC, RoHS BIS:13252
20.	Interchangeability	All cameras of this particular type should be of the same Make & Model and fully interchangeable with each other
21.	Cyber Security Compliance:	Multiple user access levels should be available with enhanced password policy, Data Security Standard compliance, Digest authentication, Stream Encryption, IP Filtering, AES 256-bit Encryption, IEEE 802.1x. The cameras offered must be cyber security certified with NDAA/UL Cyber security certificate/NIST/TPM/Cybersecurity Chipset/ Any other cyber security certificate from Indian Government body for mitigating cyber security risk"
22.	ONVIF Compliance	ONVIF Profile S, G, and T (ONVIF approved certificate / ONVIF conformant devices listed on the ONVIF global website). There should be no ONVIF membership restrictions on CCTV OEMs, this means that Camera OEMs can participate in ONVIF committees which include ONVIF new profile development and maintenance. Similarly, OEMs can use new ONVIF tools and software for camera testing. The bidder shall submit a declaration in this regard from the OEM.
23.	Non-compliance to GB28181, GB/T28181-2011 standards and there should be no option to activate or deactivate GB/T 28181	The bidder to submit undertaking from OEM

	PROJECTS & DEVELOPMENT INDIA LTD	E-7099	0
		DOCUMENT NO.	REV
		SHEET 7 OF 17	

	standards in the camera web page/ settings	
24.	Compliance to official HEVC Licensee for using the genuine legal H.265 compression.	The Bidder to submit documentary proof in this regard
25.	Prohibited Protocols	FTP, Telnet, GB/T 28181, SSH. There should not be any provision to enable or disable these protocols in the default firmware from manufacturer. Any special firmware developed to disable these features will not be allowed.

1.2 IP Weather-Proof PTZ Camera

S. No.	Parameter/ Component	Minimum Specification
1.	General	IP, True Day/Night, Outdoor, 5MP PTZ Camera, POE Enabled, ONVIF compliant, aluminum construction and factory fitted housing of same make
2.	Lens	Auto Focus, Motorized Focus and Zoom Lens 4.3 to 5.3 mm - 135mm with Min 30x Optical Zoom and 16X digital Zoom
3.	Image Sensor	1/2.8" or higher size CCD/CMOS/MOS sensor
4.	Resolution	Min 5 MP (2592 X 1944) @ 25 fps or better
5.	Range	Pan: 360° continuous rotation Tilt: 180° or better
6.	Presets/ Preset Positions	Minimum 256 or better
7.	Preset Tour/ User defined Patterns	Minimum 6 or more
8.	Alarm Inputs and Outputs	2 Nos. and 2 nos.
9.	Minimum illumination	Normal Mode: Min 0.08 Lux Night Mode: Min 0.005 Lux IR ON: 0 Lux (IR distance up to 150 Meters)
10.	Video streaming	1. Primary (Analytics): H.265 – Min 2592x1944 2. Secondary (Storage): H.265 -Min 704 x 576 3. Tertiary: H.265/H.264/MJPEG- Min 640x480
11.	Image features	BLC, 1/30000 ~ 1/30 shutter speed
12.	WDR	120 dB
13.	Protocols	IPv4, IPv6, TCP / IP, HTTP, IGMP, DHCP, NTP, DDNS
14.	Video Analytics	Camera shall have following video analytics as minimum: Intrusion Detection, Loitering Detection and Smart Motion Detection Video Analytics event linkage shall be available in camera with event notification using digital output, email and micro-

	PROJECTS & DEVELOPMENT INDIA LTD	E-7099	0
		DOCUMENT NO.	REV
		SHEET 8 OF 17	

		SD card recording
15.	Operating temperature	-30°C - 70 °C or better
16.	Heater & Fan	Required
17.	Ingress Protection	IP67 and IK10 Impact Resistance or Better
18.	Defog	Required (ON/OFF), Selectable
19.	Electronic Image Stabilization	Required (ON/OFF), Selectable
20.	Local storage	Minimum 256GB SDXC/SDHC/ Micro SD card slot along with 128GB SD card
21.	Audio	Line input and Line output, Dual-Channel
22.	Audio Compression	G.711a/ G.711u
23.	Certification	UL 62368-1/IEC 62368-1, CE, FCC, RoHS, BIS:13252
24.	Interchangeability	All cameras of this particular type should be of the same Make & Model and fully interchangeable with each other
25.	Cyber Security Compliance:	Multiple user access levels should be available with enhanced password policy, Data Security Standard compliance, Digest authentication, Stream Encryption, IP Filtering, AES 256-bit Encryption, IEEE 802.1x. The cameras offered must be cyber security certified with NDAA/UL Cyber security certificate/NIST/TPM/Cybersecurity Chipset/ Any other cyber security certificate from Indian Government body for mitigating cyber security risk"
26.	ONVIF Compliance	ONVIF Profile S, G, and T (ONVIF approved certificate / ONVIF conformant devices listed on the ONVIF global website). There should be no ONVIF membership restrictions on CCTV OEMs, this means that Camera OEMs can participate in ONVIF committees which include ONVIF new profile development and maintenance. Similarly, OEMs can use new ONVIF tools and software for camera testing. The bidder shall submit a declaration in this regard from the OEM.
27.	Non-compliance to GB28181, GB/T28181-2011 standards and there should be no option to activate or deactivate GB/T 28181 standards in the camera web page/ settings	The bidder to submit undertaking from OEM
28.	Compliance to official HEVC Licensee for using the genuine legal H.265 compression.	The Bidder to submit documentary proof in this regard
29.	Prohibited Protocols	FTP, Telnet, GB/T 28181, SSH. There should not be any provision to enable or disable these protocols in the default firmware from manufacturer. Any special firmware developed to disable these features will not be

	PROJECTS & DEVELOPMENT INDIA LTD	E-7099	0
		DOCUMENT NO.	REV
		SHEET 9 OF 17	

		allowed.
--	--	----------

2.0 Network Recording and Management Software

Specification	
1.1	SYSTEM DESCRIPTION
A.	NVMS Server: The NVMS Server shall contain the recording engine, database of all network-connected cameras and encoders, integrated components and their configurations. Server shall be provided as a combined hardware and software device.
B.	Workstation Software: The Client software shall render video and act as a main human/machine interface.
C.	The NVMS shall include 5 concurrent client software licenses.
1.2	FUNCTIONAL REQUIREMENTS
A.	The NVMS shall provide a user-friendly graphical user interface (GUI) to configure the cameras, create schedules for recording, perform video surveillance and recording operations, and view various reports.
B.	The NVMS must support Virtualization by which VMware virtualization can be applied
C.	The NVMS shall support the configuration to store and to view images captured by 48 cameras.
D.	The NVMS shall have following major capabilities:
1.	The NVMS shall have license of 128 cameras based on site location.
2.	The NVMS shall have live viewing HD video on remote desktop clients with support for monitoring of up to 23 1080p HD cameras in real time at 1080p HD. NVMS server is also capable to act as client to view and playback cameras.
3.	Powerful investigation and video archive search tools from local or remote client.
5.	Dual Authentication Support While performing playback operation at least two people from different roles should authenticate. For an Administrator, user authentication is not required and can do any playback operation. For an operator user, a popup is displayed and an Administrator user or any other User with different role needs to authenticate to perform playback operation.
6.	The NVMS must support Hashing function to increase the security of system whereas credentials are hashed. Upon upgrade user password, will be set to expire in 90 days. User shall be able to control these settings in NVMS configuration. This guards against the possibility that someone who gains unauthorized access to the database can retrieve the passwords of every user in the system.
7.	The NVMS shall have native device integrations with 4K decoding with GPU rendering, H.265 video compression codec, 3D PTZ control, 360° camera support, and intelligence events.

	PROJECTS & DEVELOPMENT INDIA LTD	E-7099	0
		DOCUMENT NO.	REV
		SHEET 10 OF 17	

8.	The NVMS shall capable of managing motion detection-based recording with pre-event and post-event recording based on camera based motion detection or Server based motion detection events (SMART VMD) and “advanced” search on recordings from local or remote client.
9.	The NVMS shall have feature of preview and calendar search permitting search for videos and events based on user-selected date and time from local or remote client. SMART motion search — fast and efficient forensic search and investigation for objects/motion on recorded video using SMART motion detection Analytics algorithms on the client PC without impacting the NVMS Server load.
10.	Simultaneous use of multiple video compressions including MJPEG, MPEG-4, H.265 and H.264.
11.	The NVMS supports the following languages: French, German, Russian, Italian, Spanish, Dutch, Arabic and English.
12.	Email configuration is available in NVMS on alarm.
13.	The NVMS shall have snapshot feature, operator can playback the video with reference of snapshot.
14.	Dynamic IP Camera Discovery – Automatically discover all compatible cameras connected to NVMS and multi-level user access rights for viewing and managed access to the recorder functions.
15.	The NVMS can manage continuous, scheduled, manual, event-based, and alarm-based recording features.
16.	Advanced security features with encryption support for communication between desktop client to NVMS or network video recorder and secure https login for Web Client and mobile apps.
17.	The NVMS shall support for web client for control the camera from remote location without installing application software.
D.	The NVMS shall have the option of two modes of user logins:
1.	Windows Authentication: Uses Windows logged-in user name.
2.	User DB Authentication: Uses preconfigured user name and password.
E.	NVMS client application shall provide the following operator options:
1.	Configuration: The operator (with Administrator privileges) shall have the option to configure the NVMS. Live update of all configurations is supported. The following configurations shall be possible:
a.	System Configuration: Provide options to configure the system level settings. Bulk Configuration: This feature allows to perform configuration of multiple cameras for main and sub streams, to ease the effort of configuring multiple cameras on single go at site. Operator can perform the following using Bulk configuration screen: <ul style="list-style-type: none"> • General Settings • Schedule Settings • Preference Settings • Stream Settings including child stream configurations specific to camera • Video Motion Detection Configuration
b.	Camera Configuration: Provide options to add/edit/delete IP cameras and encoders.

	PROJECTS & DEVELOPMENT INDIA LTD	E-7099	0
		DOCUMENT NO.	REV
		SHEET 11 OF 17	

c.	Schedules: Provide options to configure schedule-based recording for cameras connected to the NVMS.
d.	Input and Output: Provide options to configure camera input and output.
e.	Sequences: Provide options to group a fixed number of cameras to view video.
f.	Users and Roles shall provide option to add/edit/delete users.
g.	Password Complexity and Expiry Enhancements The following are the enhancements: <ul style="list-style-type: none"> • Improved change of password security by introducing complexity requirements. The following are the password requirements. • The password should have a minimum length of 8 characters. • The password should consist of at least one number, one uppercase letter and one special character
h.	Clip Deletion Settings: Provide the ability to automatically utilize more storage on event-initiated recording.
i.	Independent deletion setting for continuous recording.
j.	Independent deletion setting for event recording.
k.	Provide option to grant a user the ability to view a single camera surrounded by the cameras programmed as the "Surrounding Cameras".
l.	The user shall be able to view a specific object in the live video in a 3-dimensional view. This feature is available in the Context menu options. 3D positioning options include: Click-based camera positioning, Rectangle selection 3D positioning, and Restore to last PTZ position.
m.	Multi-zoom views on HD video and support to create virtual cameras by digitally zooming into the field of view. For example: zooming in on a cash register in one view of the HD camera while at the same time monitoring the cashier in the zoomed-out view of that HD camera.
n.	Configurations for cameras connected to NVMS:
1.	Camera Configuration: The user shall be able to configure the following parameters for each camera connected to the NVMS.
a.	Camera Name
b.	IP Address
c.	Camera Type
d.	Fixed/PTZ
e.	Continuous Recording: All cameras added shall be defaulted to "24/7" recording with the option to select other recording modes.
f.	Event Based Recording: Shall be "None" by default, with the option to select motion-based recording.
g.	User name: Shall display and enable setting the user name for a camera.
h.	Password: Shall enable setting the password for a camera.

	PROJECTS & DEVELOPMENT INDIA LTD	E-7099	0
		DOCUMENT NO.	REV
		SHEET 12 OF 17	

<p>i. The NVMS shall have advance setting of camera to enable configuration of Video Format, Compression Format, Resolution, Compression, Video Frame Rate, GOP, Record Quality Settings, Clip Deletion Settings, Launching Web View of camera for Advanced Setup, Motion detection zones configuration for Server based motion detection, Video Archival Settings, Multi-Stream Settings and Video Preview. Shall enable configuration of RTSP URL for cameras or encoders added with camera type – Generic RTSP.</p>
<p>2. The following video recording options shall be supported:</p>
<p>a. Scheduled based recording: The system shall support the ability to schedule recordings for each individual camera for times in the future. By default, the NVMS shall be pre-loaded with the following four schedules: 24x7, Weekday, Daytime, and Nighttime, which cannot be edited. A maximum of 50 schedules can be created in the NVMS.</p>
<p>b. User based recording: The user shall be able to configure user activated settings for recording moments of interest while viewing live video from a camera. After configuring the user activated settings, the operator can start recording of video when needed. The video is recorded for the time period specified in the System settings for user activated recording. The User based Recording Time Duration shall be selectable from a list of values ranging between 30 seconds and 5 minutes.</p>
<p>c. Event based recording: Event based recording shall be possible on SMART Video Motion Detection and alarm triggers. The NVMS must be capable of managing motion detection-based recording with pre-event and post-event recording based on camera and Server-based motion detection events. The server-based SMART VMD analytics must be object-based and not traditional pixel-based, reducing false alarms due to changing light conditions, video noise, rain or other false alarm triggers that occur using pixel-based (traditional) VMD.</p>
<p>G. The NVMS Client shall have the following minimum capabilities:</p>
<p>1. Main video viewing screen capable of showing 1, 2x2, 1x5, 2x8, 1x12, 3x3, 4x4 split layouts of live or recorded video. Standard presets shall be customizable to the user preferences.</p>
<p>2. Capable of saving current salvo as a View and allowing the user to drag this view at any later point in time.</p>
<p>3. Capable of configuring and running scan sequences.</p>
<p>4. Capable of adjusting the contrast, brightness, and saturation settings for each camera independently in live and playback.</p>
<p>5. Capable of exporting user selected image or video clips in simple .wmv/.avi, .asf and .bmp formats. Capable of attaching a digital signature for authentication of exported clips in .wmv/.avi format.</p>
<p>6. Capability to play back the video clips exported. Each video channel that is being recorded by the recording system shall be overlaid with text and a time stamp that is customizable by the user.</p>
<p>7. Allow the user to initiate recording through the GUI or a controller.</p>
<p>8. Video Container format support — only playable in desktop clients and standalone Clip Player. Features quicker exports of raw video and support for estimating clip size and split to multiple clips to ensure clip storage media matches. Include the clip player with exported clip for easier review of video evidence and efficient</p>

	PROJECTS & DEVELOPMENT INDIA LTD	E-7099	0
		DOCUMENT NO.	REV
		SHEET 13 OF 17	

<p>investigation. Clip Player — Portable standard secure player for archived and exported clips, 360 camera de-warping and 2x2 Salvo support. Smooth playback support with up to 256x review speed. No software needed to run on a Windows PC, with the option to include the clip player with the exported clip.</p>
<p>9. The NVMS shall have capability of complete alarm management for the alarms coming from the camera and recording server.</p>
<p>10. Facility of surrounding camera view.</p>
<p>Option to perform various operations through context menu on a particular video (live/recorded/sequence). These operations include: Full screen, point and drag, maintain aspect ratio, toggle text, digital PTZ, mark in, mark out, save image, save image as, show surrounding cameras</p>
<p>11. Ability to manage timeline control of the recording device, which provides camera recording statistics. Timeline control shall have the following features: Mark input (with looping facility), snapshot, time slider, time jump, play controls.</p>
<p>12. Timeline control shall have the following features: Mark input (with looping facility), snapshot, time slider, time jump, play controls</p>
<p>13. Preference configuration including: frame rate of unselected panels, rendered type, preview pane, text display format.</p>
<p>H. Search: The Search facility shall include search for recorded video and events based on date and time.</p>
<p>I. Reports: The Report facility shall include event history report and audit log report.</p>
<p>K. NVMS INTEGRATIONS NVMS shall have the ability to access and manage necessary functions through the NVMS client interface, such as live video, recorded video, camera configuration, PTZ control and other associated functions.</p>
<p>NVMS shall be compatible with the following interoperability standards:</p>
<p>2. Open Network Video Interface Forum -ONVIF Profile G, T</p>
<p>3. Real Time Streaming Protocol (RTSP)</p>
<p>4. Electronic Access Control System Integration</p>
<p>5. IP Surveillance Control Keyboard</p>
<p>L. Restrictions on countries sharing land border with India The VMS Offered should not be Developed/ manufactured by an entity in which the majority shareholding of the entity is from a Country sharing a Land Border with India. OEM shall provide a declaration in this regard as a Documentary Evidence.</p>
<p>M. Cyber Security Compliance: The VMS software should be developed by OEM as per OWASP guidelines for cyber security.</p>

3.0 Windows based Network Recorder Server for 128 Cameras

The Server shall operate with no performance degradation using the following minimum hardware and operating system configuration:

Server Specification
1. Processor: Xeon 6 Core Processor, 2.2Ghz or Better

	PROJECTS & DEVELOPMENT INDIA LTD	E-7099	0
		DOCUMENT NO.	REV
		SHEET 14 OF 17	

2. Memory: 16 GB DDR4
3. OS Partition: 240 GB SAS/SSD for OS and application in RAID1
4. Operating system: Windows Server 2019 / Windows 10 Enterprise 64 bit
5. Storage capacities: 4 bays with max 20 TB SATA hard drives each (Internal Storage)
6. RAID Controller: Yes
7. RAID Levels: 0, 1, 5, 6, 10
8. Video Storage Hard Disk: Minimum 40 TB usable storage or hard disk size for 30 days recording at 720p resolution 25 fps whichever is higher, RAID 5 size will be extra
9. Serial Connection: 4x USB Ports
10. Network interface: 2 x 1 Gigabit Ethernet included
11. Human Interface: keyboard and a mouse pointing device
12. Monitor Output: VGA Display Port
13. Electrical
<ul style="list-style-type: none"> • INPUT VOLTAGE: 100~220 VAC 50/60Hz
14. Environmental
<ul style="list-style-type: none"> - Operating Temperature: 10° to 35° C - RELATIVE HUMIDITY: Operating: 10% - 85%, non-condensing
15. REGULATORY: CE, FCC, UL and RoHS
16. Hardware Cyber Security: TPM 2.0
16. 21"/22"/23" LED Display Monitor
17. The Server shall support for configuring one (1) preferred stream for continuous recording and one (1) preferred stream for live video/motion-based recording per camera. Support for Audio with live, playback and clip export on NVMS client.
18. The Server application shall provide a user-friendly graphical user interface (GUI) to configure the cameras, create schedules for recording, perform video surveillance and recording operations, and view various reports
19. The Server application shall contain the recording engine, database of all network-connected cameras and encoders, integrated components and their configurations.
20. Native device integrations supporting new features: 4K resolution, H.265 video compression codec, 3D PTZ control, 360° camera support, and intelligence events.
21. The Server application shall simultaneous use of multiple video compressions including MJPEG, MPEG-4, H.265 and H.264.
22. The Server application shall automatically discover all compatible cameras connected to NVMS and multi-level user access rights for viewing and managed access to the recorder functions.
23. Support for web client and mobile apps.
24. CCTV Camera and Software should be from the same OEM.

	PROJECTS & DEVELOPMENT INDIA LTD	E-7099	0
		DOCUMENT NO.	REV
		SHEET 15 OF 17	

25. Bidder may quote the Network Video Recording Server of same make as cameras offered

4.0 Client Workstation

SPECIFICATION	
Operating System	Windows 10 Professional 64 bit
Processor	Intel i7 10700
Processor Chipset	IntelQ470 or Bidder to Specify
Memory	16 GB
Hard Drive	500 GB SSD
Optical Drive	DVD-RW
Graphics	Intel 630 UHD + NVIDIA P620 Graphics
Ethernet Port	1 x RJ-45 10/100/1000 Mbps
Audio	Line-out audio port
	Line-in audio port
Input Voltage	100~240 VAC 50/60 Hz
Dimensions	Bidder to Specify
Regulatory	CE, FCC, UL and RoHS
Bidder may quote the workstation of same make as cameras offered.	

5.0 Joystick Keyboard Controller

Joystick controller should have variable speed joystick, LCD display for programming and it should be able to control the speed dome for PAN/TILT/Zoom. Joystick Controller must have PoE interface.

PTZ Joystick Controller	
Baud Rates	Min 1200, 1800, 2400, 4800, 9600 or better
Distances	LAN: 100 m RS485: 1200 m
Joystick	3-axis proportional control
Keys	Laser cut
Touch Wheel	Layout selection/control
Standard Keys	0-9, View, Split Screen, Ent
Camera Function Keys	View, Tour, PTZ Call, Alt, Set, Iris, Focus
Power	12VDC and Power Over Ethernet
LAN	10Base-T, 100Base-TX, RJ45 used for web browser configuration and firmware updates
Temperature	Operating: -10° to 45°C
Relative Humidity	0-90% non-condensing
Regulatory	CE, FCC, and UL

	PROJECTS & DEVELOPMENT INDIA LTD	E-7099	0
		DOCUMENT NO.	REV
		SHEET 16 OF 17	

F. VENDOR'S TECHNICAL OFFER SHALL INCLUDE THE FOLLOWING:

- 1 Clause wise Compliance to the specifications.
- 2 Detailed specification sheet for each item providing all the details regarding make and model, type, construction, Maximum and minimum viewable distance, Maximum tilt or pan angle possible, Pan and tilt speed, Allowable Voltage and frequency variations, Interconnecting cable and transceiver module specifications, utility requirement, Network Bandwidth requirements and calculations to support the same considering bus loading as' 50% maximum, Hardware, software and licensing requirements, Storage calculations for video recorders.
- 3 Block-diagram showing all units with model numbers
- 4 Interconnection wiring diagram between the various components of CCTV system, including location of each item. The diagram shall show the size of cable and brief specification of the cable
- 5 All associated accessories and cables.
- 6 Power consumption and heat load calculations

Detailed FAT procedure shall be presented to the Client/PMC for approval during the time of bidding.

G. SPARE PARTS AND CONSUMABLE

CCTV Vendor shall supply following spares:

1. CCTV camera, camera station, lens with zoom pan and tilt, receiver unit, electronic unit, power supply unit, any other unit - 10% or minimum 1 of each item
2. Junction Box with all required hardware - 10% or minimum 1 of each type.
3. Media Convertors for Both types (Field and Control Room) - 10% or minimum 1 of each type
4. All other vendor supplied items shall be considered for mandatory spares - 10% or minimum 1 of each type.

All junction boxes and cable glands shall be weather proof minimum IP67 Certification

All electric equipment and accessories shall be certified by CENELEC, FM, ATEX, UL, CMRI (or equivalent) in the country of origin .

H. PACKING AND PREPARATION FOR SHIPMENT

- All Instruments shall be properly packed as for their specific construction and technical characteristic to avoid damages during shipment and storing in the warehouse before installation in the plant.
- All threaded openings and cable entries shall be suitably protected to prevent entry of foreign material.
- Any glass item shall be protected with foam sheet to protect against damage during transportation.
- Each cabinet and accessory shall be suitably packed and protected from damage due to transportation, unloading and loading.
- Each component part requiring identification for proper assembly at site shall be piecewise marked.

I. SITE ACCEPTANCE TEST (SAT)

SAT is inspection for checking that all the conditions are good after installation at site. Prior to notice of SAT to Purchaser, Vendor shall submit all the "As-Shipped" documentation incorporating all the correction. Prior to start SAT, all the cabinets,

	PROJECTS & DEVELOPMENT INDIA LTD	E-7099	0
		DOCUMENT NO.	REV
		SHEET 17 OF 17	

equipment and components of CCTV shall be installed in proper location as designed. Vendor shall demonstrate all the function of CCTV working properly in SAT. Each test shall be carried out on the procedure and its criteria reviewed and accepted by Purchaser. Test certificate shall be issued by Vendor at the successful end of the test activities. All the hardware and software failures and problems shall be documented. SAT shall be identical to FAT but at reduced amount to check hardware without any damage, installation completed properly and interfaces working properly. Vendor shall provide special tools and test equipments (if required).

J. SITE SUPPORT

Vendor shall provide adequate personnel having at least two (2) years of Experience of CCTV commissioning to support all installation, power-on, system start-up and inspection and testing activities at site. Vendor's personnel shall be available at site 24 hours a day during commissioning of the CCTV System. Vendor shall consider 10 days site support in base offer.

 पी डी आई एल PDIL	PROJECTS & DEVELOPMENT INDIA LTD		P	
		DOCUMENT NO	REV	
		SHEET 1 OF 7		

TECHNICAL SPECIFICATION OF TELEPHONE & LAN SYSTEM

**PROJECT: INTEGRATED COAL BASED FERTILISER COMPLEX, AT TALCHER,
ANGUL DISTRICT, ODISHA (INDIA)**

REV	REV DATE	EFF DATE	PURPOSE	PREPD	REVWD	APPD

	TELEPHONE & LAN SYSTEM	P		
		DOCUMENT NO		REV
		SHEET 2 of 7		

1.0 TELEPHONE EXCHANGE AND LOCAL AREA NETWORK

2.0 SCOPE

The bidder scope includes selection, design, supply and installation of complete telephone Network and LAN system & Telephone system & network shall be state the art full IP based network system based on POE (Power over Ethernet). LAN & Telephone network shall be separate; ie; separate cables (Cat6A minimum), face plate etc shall be provided following buildings as minimum.

1. Existing Fire Station converted into First Aid Room
2. Admin Building (Existing)
3. Technical Building (Existing)
4. Canteen
5. Central Store (Existing)
6. Elect & Inst Workshop (Existing)
7. Mech Workshop (Existing)
8. Training Centre (Existing)
9. Urea Silo (26 Mtrs x 190 Mtrs) (Existing)
10. 132 kV Substation (Existing)
11. Electrical Distribution System (Main Receiving Substation - MRSS)
12. Electrical Distribution System (Offsite & Utilities Substation - OUSS)
13. Emergency Diesel Generators Building
14. First Aid Room
15. Security Room 1 (Existing)
16. Security Room 2
17. Guest House Ground Floor (Existing)
18. Guest House 1st Floor (Existing)
19. Police Station
20. CISF Barracks (6 Nos. Buildings) (Existing)
21. Trainee Hostel (Existing)

For Telephone network bidder to refer Annex A for detailed AMC / license / Spare philosophy. For LAN network bidder responsibility is limited to installation of LAN network up to network switch this includes OFC cables, Ethernet cables, face plates ,Network Switch, media converter, FRP Cable trays(300m width perforated) etc including any other equipments which is necessary for proper working of LAN & Telephone Network . (Servers/Personal computers/printers etc shall not be in bidder's scope).

Bidder scope includes all the consumables such as HDPE conduits, Conduit pipes, FRP trays (300m width perforated) and its accessories, supports, PVC boxes, Junction boxes (if any) etc for the above works.

	TELEPHONE & LAN SYSTEM	P		
		DOCUMENT NO		REV
		SHEET 3 of 7		

Telephone and LAN network shall be independent network no common electronics shall be used. A common OFC cable (Redundant) interface can be used for distant communication using different fibres. All cables used for EPBX & LAN shall be Cat6A minimum, UTP cables are not acceptable.

At the Admin & Technical building FRP cable tray (300m width perforated) shall be used for cable laying for LAN & EPBX system inside the false ceiling. While branches can be laid through PVC conduit pipes.

3.0 TELEPHONE NETWORK

BASIS OF DESIGN

The system and all the equipment shall conform with all relevant and the latest edition of Indian, International, OISD and CCITT/ ITU standards as applicable. As a minimum, the following standards shall apply. Whole network including network switches at different locations shall be powered with UPS, UPS shall be in bidders scope (sizing shall be done on basis of 1Hr backup)

- a. IS: 2148 flameproof enclosures for electrical apparatus.
- b. IS: 13346 General requirements for electrical apparatus for explosive gas atmospheres.
- c. IS: 5572 Classification of hazardous areas (other than mines) for electrical installation areas having flammable gases & vapours.
- d. IEC: 79 (Applicable parts) Electrical apparatus for explosive gas atmosphere.
- e. IS: 13408 Code of practice for the selection, installation & maintenance of electrical apparatus for use in potentially explosive atmospheres.
- f. IS: 13408 Code of practice for the selection, installation & maintenance of electrical apparatus for use in potentially explosive atmospheres.
- g. IS: 5571 Selection of equipment for Hazardous areas.

Telephone Network shall be fully IP based state of the art system, there must be two categories of phones shall be supplied along with the EPBX system ie; IP based Basic phone & IP based hybrid type of phones

The telephony system shall also be connected to the Public Switched Telephone Network (PSTN) through the PABX, and shall comply with the entire telecommunication carrier's

	TELEPHONE & LAN SYSTEM	P		
		DOCUMENT NO		REV
		SHEET 4 of 7		

requirements; technical compatibility between the public and private networks shall be ensured. It is bidder's responsibility to provide **suitable UPS for powering the EPBX** system. Bidder has to ensure the power requirement shall full fill extra 100 lines as future load. Bidder to note that FRP trays (300m width perforated) shall be used for cable laying in Admin & Technical building inside false ceiling.

AREA CLASSIFICATION

The exchange shall be fit operate on the following power supply.

- a) UPS Supply **voltage 115V A.C. ±10%**
- b) Supply frequency 50 Hz ±3%

DETAILS OF DESIGN

The system shall comprise of fully microprocessor based digital central exchange. Consisting of system control hardware, it should be an expandable system. The offered system shall have capacity of 200 extensions/users .Bidder shall provide the details of licenses as per Annex 1.

Telephone network shall be state the art full IP based network system based on POE (Power Over Ethernet). The main unit shall be installed in ADMIN building A redundant interface shall be provided for connecting to Telephone Exchange in the central control room. The Exchange shall have facility of connection to the LAN system with POE/non-POE switches.The Telephone Exchange shall be interfaced with FGS system via 2 wire, RS-485 serial interface over MODBUS. The EPBX and a Main Distribution Frame (MDF) shall be located Admin Building Ground Floor.

UPS with battery power shall be in bidder's scope of supply, sizing shall be done considering he future load of 100 lines in addition to the spare lines. Complete supply, erection of the exchange system shall be in bidder scope. Bidder has to provide complete system in fully working condition.

1 No of Laptop installed with all configuration software, antivirus etc shall be provided along with **EPBX** system (please refer Annex 1 for Laptop Configuration)

	TELEPHONE & LAN SYSTEM	P		
		DOCUMENT NO		REV
		SHEET 5 of 7		

Cable inside the Admin, technical and training buildings shall be laid through FRP cable trays (300m width perforated) and inside the room it shall be concealed. Standard RJ 45 phase plate shall be provided inside the rooms. While in case of Guest house & bungalows it shall be laid through PVC conduit pipes.

The main unit shall be connected to Technical building, training centre, Bungalows and Guest house through 12 Fibre single modes Redundant OFC cables. (Along which both LAN as well as EPBX shall be connected. This shall be laid through HDPE conduit.

CENTRAL EXCHANGE

The central exchanges shall be fully digital, microprocessor based freely programmable exchange.

It shall be possible to program / re-program the exchange through external laptop PC, using text/graphic editor, via USB/RS 232/Ethernet or other suitable interface.

Complete hardware racks for this exchange shall be accommodated inside control room panel/cabinet. The cabinet shall be fabricated out of minimum 16-gauge sheet steel, naturally ventilated, dust and vermin proof with IP-41 enclosure as a minimum. The panel shall be with swing out assembly of plug-in-card racks. It shall be possible to locate faults by monitoring from the central cabinet.

The exchange shall have a completely non-blocking type switching system and associated circuitry for call recognition and acknowledgement. The offered system shall be flexible and modular in construction with the possibility of expanding to a bigger system in the future. Suitable Panel Shall be provided to accommodate whole circuitry & associated electronics.

The central exchanges shall have built-in fault diagnostic unit using test and monitoring modules. It shall be possible to locate faults by visual signalling and monitoring by means of test plugs from the central cabinet.

All hardware necessary for fault isolation and troubleshooting shall be supplied as a part of the cabinet along with each exchange.

Bidder has to supply the following number of telephones as a minimum.

	TELEPHONE & LAN SYSTEM	P
		DOCUMENT NO
		REV
SHEET 6 of 7		

Table:1

	IP Phone with built in camera & TFT LCD display for video conferencing as well as capable to connect an external IP camera (Type 1)	Standard IP Phone with TFT LCD display with optional expansion module. (Type 2)	IP Based Basic desktop phones (Type 3)
Admin building	3	22	30
Technical building	3	22	30
D Type Bungalows	0	0	4
Vikrampur guest house	0	0	32
Training centre	1	3	12
All other building	5	20	20

**One number of front desk SIP phone shall also be provided for Admin building.*

In addition to the above quantity bidder shall provide spares as per Annex 1

4.0 LOCAL AREA NETWORK (LAN)

The Bidder shall design, supply and lay the LAN required for the Admin building, Technical building, Guest House, training centre and bungalows. This includes all the cables (Cat6A), connectors, Media converter cards if any, Network switches etc. Whole network including network switches at different locations shall be powered with UPS, UPS shall be in bidders scope (sizing shall be done on basis of 1Hr backup)

BASIS OF DESIGN

The system shall have as a minimum the following.

1. Manageable L2- 48 port switch, with min 2 SFP ports with 1G/10G port with 48 port Jack panel with cable manager
2. One redundant Fibre Optic Port shall be used for connection to main servers (by others).
3. Cabling shall be CAT6A cabling
4. 3 m/Cat 6A or 6 m cat 6A patch cords for end user
5. UTP CAT6A cabling shall be done with one spare cable.
6. Cable and passive components shall be from AMP.
7. Whole network shall be UPS powered considering 1Hr backup time (this include network switches/converters at different locations)

	TELEPHONE & LAN SYSTEM	P
		DOCUMENT NO
		REV
SHEET 7 of 7		

A common OFC (redundant) for LAN as well as EPBX shall be used for communications from Admin building to all other buildings. Bidder to note that the servers (supplied by others) will be located in Admin building. Suitable location is already shown in the drawing.

Building	No of users(for Desktop)	PORT (for Wi-Fi) *
Admin building	61 Nos	6 No's
Technical building	61 Nos	6 No's
D Type Bungalows		1 (each) total 4 No's
Vikrampur guest house	4 No's	14 No's
Training centre	14 No's	2 No's
All other building	20	20

**Ports for Wi-Fi Router connection shall be located above floor in the ceiling level.*

	TECHNICAL SPECIFICATION JUNCTION BOXES & ACCESSORIES	PDIL DOC. NO.		JUNCTION BOX
		DATE		18.10.2022
		REV	P	SHEET 1 OF 7

**TECHNICAL SPECIFICATION
FOR
JUNCTION BOXES & ACCESSORIES**

P	18.10.2022	18.10.2022	For Client's Comments	SG	HS	SKT
REV	REV DATE	EFF DATE	PURPOSE	PREPD	REVWD	APPD

All rights reserved

	TECHNICAL SPECIFICATION JUNCTION BOXES & ACCESSORIES	PDIL DOC. NO.		JUNCTION BOX
		Date		18.10.2022
		REV	P	SHEET 2 OF 7

1. SCOPE

- 1.1 These specifications and the data sheet cover requirement for design, engineering, manufacturing, assembly, and supply, documentation, testing at manufacture's works, packing and shipping of the **JUNCTION BOXES & ACCESSORIES**. In case of any conflict between these specifications, the data sheets, related codes and standards etc. bidder shall refer the matter in writing to the purchaser, and shall obtain clarification in writing before submitting the offer.
- 1.2 Enclosed data sheets specify the material for junction boxes. Unless specifically indicated otherwise, alternate superior material of construction shall also be acceptable provided vendor assumes complete responsibility for the selected materials for their compatibility with the specified fluid and its operating conditions.

2. REFERENCE CODES & STANDARDS

- | | | |
|----|--|--|
| a. | ASME
B 1.20.1 | American Society of Mechanical Engineers.
Pipe Threads General purpose (Inch) |
| b. | EN
10204 | European Standards
Inspection Documents For Metallic Products |
| c. | IS/IEC
IS/IEC 60529
IS/IEC 60079
IS-5 | Indian Standard/International/Electro-technical Commission
Degree of Protection Provided by Enclosures (IP Code)
Electrical Apparatus for Explosive Gas Atmosphere.
Colours for ready mixed paints and enamels. |

3. DESIGN AND CONSTRUCTION

Design Requirements for Junction Boxes

- 3.1 Junction boxes, Cable Glands and Plugs shall be of the following type:-
- a. FRP Weather proof and flameproof
- 3.2 Unless otherwise specified, the Junction Box, Cable Glands and Plugs shall conform to the Following standards:
- a. Weatherproof housing: IP 65 to IS/IEC -60529 and
 - b. Flameproof housing: Flameproof/Ex (d) (to Zone-1 IIA/B as minimum) as per IS/IEC-60079.
- 3.3 Number of entries and their location shall be as per data sheets. Junction boxes with top entries shall not be offered. The size of cable entries shall be as per the cable sizes / Cable gland sizes indicated in the data sheet.
- 3.4 Junction boxes shall be provided with telephone sockets and plugs for connection of Hand powered telephone set.
- 3.5 The materials of construction of junction boxes shall be cast light metal alloy preferably die cast aluminium (LM6)
- 3.6 Flameproof junction box shall have detachable cover, which shall be fixed to the box by means of cadmium plated triangular head/ hexagonal head screws.
- 3.7 Terminals shall be spring loaded, vibration proof, screw type, mounted on nickel plated steel rails complete with end cover and clamps for each row.

	TECHNICAL SPECIFICATION JUNCTION BOXES & ACCESSORIES	PDIL DOC. NO.		JUNCTION BOX
		Date		18.10.2022
		REV	P	SHEET 3 OF 7

- 3.8 All terminals used in the junction boxes shall be suitable for accepting cable sizes between 0.5 mm² and minimum 6mm².
- 3.8.1 Junction Boxes shall have 1 entries for Multi pair and 12 entries for single pair/ triad cables. The junction boxes shall be supplied with cable glands with PVC Shrouds/ and plugs for all the entries.
- 3.9 All Cable glands shall be double compression type for use with armoured cables. The cable glands shall be of nickel plated brass, as a minimum.
- 3.10 Unless higher number of terminals is specified in the purchaser's data sheet, the number of terminals in the junction boxes shall be 48 Nos in two rows duly numbered.
- 3.11 The colour of the terminals shall be Blue/ Grey.
- 3.12 Junction boxes shall be provided with external earthing lugs.
- 3.13 Sizing shall be done with due consideration for accessibility and maintenance in accordance with the following guidelines:
- a) 50 mm (minimum) gap shall be maintained between terminals/ terminal strip and sides/ top/ bottom of the Junction box.
 - b) 100 mm (minimum) gap shall be maintained between the terminal strips
- 3.14 Surface shall be prepared for painting. It shall be smooth and devoid of rust and scale.
- 3.15 Two coats of lead-free base primer and two final coats of lead free epoxy based paint shall be applied both for interior and exterior surfaces. The colour shall be Light Blue/ Light Gray as per datasheet.

5.0 INSPECTION & TESTING

The detailed scope of Third party inspection and testing is as given below:

The Bidder shall develop inspection and testing procedure (ITP) for each type of item with respect to all specific requirements as applicable to ensure compliance with codes and applicable standards .Bidder shall submit ITP for approval from OWNER.

- 5.1 Bidder shall carryout 100% inspection for compliance with requirements of specifications at every stage of manufacturing. Bidder shall maintain records / documents of all the inspection / tests carried out and shall satisfy itself about the acceptability of the item before offering for third party inspection.
- 5.2 Immediately after the completion of electrical tests , the ends of the cable shall be sealed to prevent ingress of moisture with suitable PVC/ rubber caps.
- 5.3 OWNER reserves the right to review / inspect / witness the items at any stage of inspection.
- 5.4 **The list of approved inspection agency is:-**
- a) Engineering India Limited
 - b) Lloyds Register of Shipping

	TECHNICAL SPECIFICATION JUNCTION BOXES & ACCESSORIES	PDIL DOC. NO.		JUNCTION BOX
		Date		18.10.2022
		REV	P	SHEET 4 OF 7

- c) Project & Development India Limited
- d) Mecon Limited
- e) SGS India Pvt. Ltd.
- f) RITES Limited
- g) Det Norske Veritas
- h) TUV Rhineland (I) Pvt. Ltd.
- i) TUV India Pvt. Ltd

6.0 DOCUMENTATION

- 6.1 All the data sheet , documents and drawings etc. shall be submitted to OWNER. The purchase order initiation will not be considered complete until all the documentation has been submitted by the Bidder and has been accepted by the OWNER.
- 6.2 All the documents shall be A4 or A3 size only; all the document prints larger than A4 shall be folded to A4 size with identification data visible at the bottom right.
- 6.3 All the documents submitted shall be clearly marked with following information;-
- a) OWNER purchase order number, item no. and identification tag no.
 - b) Bidder job no., document no. and revision no.

7.0 IDENTIFICATION AND MARKING

Name Plate on Junction Boxes Consist of

- a. Tag No. as per purchaser's datasheet
- b. Manufacturer's name.
- c. Manufacturers serial no. and model no.
- d. Type of protection for use in hazardous area (This should be stamped on individual cable glands and plugs also)
- e. Junction box shall have a warning engraved on cover as "ISOLATE POWER SUPPLY ELSEWHERE BEFORE OPENING"

Other details as per MR shall also be suitably indicated on the Junction Box.

8.0 SPECIAL INSTRUCTION TO BIDDER

- 8.1 In case of any conflict between "Technical Specifications for **JUNCTION BOXES & ACCESSORIES**" and the data sheets, the latter shall govern.
- 8.2 Bidder to submit documents (as specified in this specification) along with the offer submitted for technical evaluation.
- 8.3 Bidder to submit soft copies of all document & drawing. Bidder shall not be proceeding with manufacturing without document approval from OWNER.

	TECHNICAL SPECIFICATION JUNCTION BOXES & ACCESSORIES	PDIL DOC. NO.		JUNCTION BOX
		Date		18.10.2022
		REV	P	SHEET 5 OF 7

8.4 Bidder to submit soft copies of the catalogues, manufacturer material test certificates, TPI test certificates to OWNER one week before dispatch of material for review/verification.

8.5 The owner reserves the right to reject or accept any tender without assigning any reasons whatsoever. The offer shall be in following format only. Each section shall be separately segregated & highlighted with distinct Marker / Flags between the sections. Offer submitted in any other format shall not be considered for evaluation & summarily rejected.

Section 1: Signed and stamped (on each page) copy of complete specifications shall be submitted as a confirmation of acceptance of this tender specification without any deviations

Section 2: Deviations to specification if any shall be clearly listed under this section. If there are no deviations, Bidder shall say "**NO DEVIATIONS**" under this section. Deviations mentioned elsewhere in the offer shall be considered null and void and shall not be considered for offer evaluation. In absence of any written deviation clearly specified in the offer under this section, it will be assumed that all the specifications and requirements of the subject tender are complied with and No deviations whatever will be accepted after the placement of order.

Section 3: Complete technical catalogues, calculation sheets, dimensional and installation drawings of the offered instrument shall be attached against this section. Wherever asked to furnish details under the technical specifications, the same shall be included in this section. Offer without calculation sheets (if applicable) & Dimensional drawings of each item shall not be accepted.

Section 4: The offer shall only be submitted in the SOR Format provided. Offer submitted in any other format is not acceptable & may be liable for rejection.

Section 5: Check list confirmation

	TECHNICAL SPECIFICATION INSTRUMENT VALVES & ACCESSORIES	PDIL DOC. NO.		INST VALVES & FITTINGS
		DATE		18.10.2022
		REV	P	SHEET 1 OF 3

TECHNICAL SPECIFICATION FOR TUBES , PIPE, FITTINGS , INSTRUMENT VALVES & ACCESSORIES

PREPARED BY



PROJECTS & DEVELOPMENT INDIA LIMITED

(A GOVT. OF INDIA UNDERTAKING)
PDIL BHAWAN, A-14, SECTOR -1
NOIDA – 201301
DISTT. GAUTAM BUDH NAGAR
UTTAR PRADESH, INDIA

P	18.10.18	18.10.18	For Client's Comment	GAP	MN	SKT
REV	REV DATE	EFF DATE	PURPOSE	PREPD	REVWD	APPD

All rights reserved

	TECHNICAL SPECIFICATION INSTRUMENT VALVES & ACCESSORIES	PDIL DOC. NO.		INST VALVES & FITTINGS
		Date		18.10.2022
		REV	P	SHEET 2 OF 3

❖ GENERAL

This specification define the minimum technical requirement for the supply of impulse pipe, tubing, fittings, instrument valves, gauge valves etc. marking, documentation, testing-inspection and packing.

1. FITTINGS

1.1 The fittings shall be manufactured, tested and supplied strictly as per ANSI and ASTM materials grade mentioned against each item.

Dimension	: ANSI B 16.11
Rating	: ANSI Class 3000# and 6000# as specified.
Material	: As indicated against each part no.
Surface	: The surface or seats (conical or spherical) shall not have roughness and/or scoring ascertained on sight or on touch.
Tolerance	: As per ANSI B 16.11
Threading	: AS per ANSI 2.1
Marking	: As per ANSI B 16.11

1.2 All carbon steel and alloy steel fittings shall be protected against rusting using suitable paint.

2. SS TUBE SEAMLESS

2.1 Tolerance in delivered quantities

Tolerance = ± 1 length / $\pm 1\%$ whichever is less.

Tubes shall be delivered standard length Of 6 meters as specified in the specification sheet.

Tube shall be delivered in 6 meters of length properly capped at both ends.

2.2 Manufacture

The seamless stainless steel tubes as per ASTM-A-269 shall be made by the seamless process. Tubes shall be cold finished. Tubes shall be white pickled free from scale and soft annealed and suitable for bending. The finished tube should be reasonably straight and free from dents and injurious defects and shall have good finish and smooth ends. Tubes shall be SANDVIK make only.

2.3 Material composition of test requirements

Material test certificates as per clause 3.1 B of EN 10204.

	TECHNICAL SPECIFICATION INSTRUMENT VALVES & ACCESSORIES	PDIL DOC. NO.		
		Date		
		REV	P	SHEET 3 OF 3

3. CS PIPE

3.1 Tolerance in delivered quantities

Only positive tolerance are acceptable upto +5%.

Pipe shall be delivered in 5-7 meters of length properly capped at both ends.

3.2 Manufacture

The pipe shall be made by the seamless process.

It shall be free from scale and finish should be smooth.

3.3 Material composition of test requirements

ANSI B36.10 1985 shall apply for CS pipe.

4. SS PIPE

4.1 Tolerance in delivered quantities

Only positive tolerance are acceptable upto +5%.

Pipe shall be delivered in 5-7 meters of length properly capped at both ends.

4.2 Manufacture

The pipe shall be made by the seamless process.

It shall be free from scale and finish should be smooth.

4.3 Material composition of test requirements

ANSI B36.19 1985 shall apply for SS pipe.

	TECHNICAL SPECIFICATION	Doc No		
		Date		
		Rev		

TECHNICAL SPECIFICATION FOR INSTRUMENT WORKS ITEMS

0	05.01.2018	For Clients Comments	GAP	VS	RKR
Rev	Date	Purpose	Prepd	Rewd	Apprd



TABLE OF CONTENT

CHAPTER-01: TECHNICAL SPECIFICATION FOR VALVES AND INSPECTION TEST PLAN

CHAPTER-02: TECHNICAL SPECIFICATION FOR SEAMLESS PIPE & TUBE AND INSPECTION TEST PLAN

CHAPTER-03: TECHNICAL SPECIFICATION FOR BUTT WELDED, SOCKET WELDED AND SCREWED FITTINGS AND INSPECTION SCOPE

CHAPTER-04: TECHNICAL SPECIFICATION FOR FLANGES, SPECTACLE BLINDS & DRIP RINGS AND INSPECTION SCOPE

CHAPTER-05: TECHNICAL SPECIFICATION FOR GASKETS and INSPECTION TEST PLAN

CHAPTER-06: TECHNICAL SPECIFICATION FOR BOLTS & NUTS AND INSPECTION & TEST PLAN

CHAPTER-07: TECHNICAL SPECIFICATION FOR VALVE MANIFOLDS



CHAPTER-1

TECHNICAL SPECIFICATION FOR VALVES

And

INSPECTION TEST PLAN

1.0 GENERAL

- 1.1 Vendor shall quote in strict accordance with the valves data/ specification sheets, subject technical notes and all other enclosures to the requisition. Any deviation to be highlighted clearly.
- 1.2 Vendor shall supply valves along with auxiliaries, if any, such as gear operator, bypasses, drains etc. wherever specified in the specification sheets, subject notes and other enclosures to the requisition.
- 1.3 All applicable codes and standards for manufacture, testing, inspection etc. shall be of latest editions.
- 1.4 All cast valves though specified as per various BS standards shall also meet pressure temperature conditions of respective class as per ASME B16.34 and vendor shall certify the same.
- 1.5 The offered valves to various ASTM/ ASME standards shall also meet requirements of Metric unit system of relevant code e.g. ASTM A105 shall also meet requirements of ASTM A105M.

2.0 DOCUMENTATION

- 2.1 Vendor shall submit the following with the offer:
 - 2.1.1 Detailed dimensional, cross section drawing with parts/ material lists, weight etc. for the gate, ball, plug, butterfly valves, diaphragm valves, check valves & valves to manufacturer's standard.
 - 2.1.2 One copy of Valve datasheet signed as accepted by the manufacturer with all deviations marked clearly, if taken.
 - 2.1.3 Drawings for valves with accessories like gear operator/ hydraulic/ pneumatic operator, extension bonnet; extended stems with stands bypass etc. giving major salient dimensions.
- 2.2 Vendor shall submit the following documents along with dispatch documents. :
 - 2.2.1 Test reports shall be supplied for all mandatory tests as per the applicable code. Test reports shall also be furnished for any supplementary tests.
 - 2.2.2 Material test certificates (physical property, chemical composition & heat treatment report) of the pressure containing parts shall be furnished for the valves supplied. Material test certificates for the other parts shall also be furnished for verification during inspection. For alloy

steel valves mill test certification containing above information shall be furnished.

NDT test reports, PMI & any additional test as applicable.

3.0 DESIGN & CONSTRUCTION

3.1 Valve shall be designed, manufactured, tested, inspected and marked as per the manufacturing standards; design codes and standards (latest editions) indicated in the respective valve specification sheets.

3.2 Face to face and end to end dimension of steel valves of sizes up to 24" shall conform to ASME B16.10 to the extent covered under standard.

3.3 All flanged valves shall have flanges integral (except forged valves) with the valve body. Forged valves with flanged connection will be supplied by welding flanges along with nipple with 100% radiography/ DP/ MP whichever is applicable. Flange face finish shall be normally specified in the valve specification sheet as serrated finish, 125 AARH etc. The interpretation for range of face finish shall be as follows:

- Stock Finish : 1000 μ in AARH max.
- Serrated Finish / Smooth : Serrations with 125 to 250 μ in AARH
- Finish / 125 AARH
- Extra Smooth Finish / 63 : 32 TO 63 μ in AARH
- AARH

3.4 PMI test: Positive material identification test to be performed at vendor's works on pressure containing parts i.e. body & bonnet / cover of alloy steel, stainless steel valves. However for stainless steel valves PMI test is to be performed on stem also. The extent of PMI examination will be 100%.

3.5 For all weld end valves with bevel ends as per ASME B 16.25, the contour of bevel shall be as follows:

Materials	Wall thickness	Weld contour
Carbon steel [except low temp carbon steel]	up to 22 mm	Fig 2 type A
	> 22 mm	Fig 3 type A
Alloy steel, SS & low temp carbon steel	up to 10 mm	Fig 4
	> 10 mm to 25 mm	Fig 5 type A
	> 25 mm	Fig 6 type A

Inside contour shall be sloped to in line with ANSI B16.25 i.e. when the thickness is greater than that of matching pipe.

3.6 For flanged valves with ring joint flange the hardness shall be as follows:

Flange material	Min. Hardness of Groove (BHN)
Carbon Steel	140
1% Cr to 5% Cr	150
Type 304, 316, 321, 347	160
Type 304L, 316L	140

3.7 Following requirements for check valves shall be met over and above the valve spec sheet requirements:

3.7.1 Unless specified otherwise in the data sheet all swing check valves 3" & above shall have a drain boss at location "G" (0.5" size for valve sizes 3" & 4" and 0.75" size for valves 6" & larger) (Refer Fig.No.1 of ASME B16.34). A tapped drain hole (except in CRYO valves and 900#, 1500# & 2500# rating valves where tapping shall not be done in boss) with plug shall be provided as per ASME B16.34. Threads shall be as per ASME B1.20.1 (Taper) NPT.

3.7.2 Swing check valves shall be provided with limit stops to prevent disc from remaining in open position.

Wherever check valve disc assembly is supported from the cover of the check valves the following shall be ascertained:

- i. Positive location/ positioning of cover must be provided to ensure correct alignment of the valve disc.
- ii. Hinge pin design must permit accurate alignment of the disc and valve seat.

3.7.3 The check valves having disc assembly supported from the cover of the check valves are not acceptable.

3.7.4 For heavy check valves, provisions shall be available for lifting by way of lugs, eye bolts and other such standard devices.

3.8 If an overlay weld-deposit is used for the body seat ring seating surface, the corrosion resistance of the seat ring base material shall be at least equal to the corrosion resistance of the material of the shell. However, provision given in valve data sheet will supersede in case of any contradiction.

3.9 For gate valves:

ANSI Class	SIZE
150 Class	26 inch and above
300 class	16 inch and above
600 class	6 inch and above
900 class	4 inch and above
1500 class	4 inch and above
2500 class	3 inch and above

By- pass valve shall be globe valve. The sizes shall be :

On main valve < 4" or = 4" = 1/2" or more
 >4" but <10" = 3/4" or more
 = 10" or >10" = 1" or more

- 3.9.1 Vendor shall supply the bypass valve duly tested and fitted to the main valve. Valves with bypass shall have the direction of flow marked on the main valve. Bypass attachment to the main valve body shall not be screwed. All fillet welds for bypass installation shall be 100% examined by DP/MP test.
- 3.9.2 The bypass piping arrangement shall be such that clearance between main valve body & bypass assembly shall be the minimum possible for layout reasons. Basic design of bypass shall be to MSS-SP-45 & ASME B16.34.
- 3.10 Valve body/ bonnet shall be forged/ cast as specified. Forgings are acceptable in place of casting but not vice versa.
- 3.11 Material of construction of yoke shall be minimum equivalent to body/ bonnet material.
- 3.12 Stem shall be forged or machined from forged/ rolled bar. No casting is permitted. However, integral stem of cast stainless steel ball valves is acceptable.
- 3.13 Butt welding and socket welding carbon steel valves shall have 0.25% maximum carbon content, free machining steel is not acceptable.
- 3.14 The valve packing shall meet type testing for fugitive emission as per API 622.
- 3.15 All Teflon packing, seats, seals, lining etc. shall be virgin Teflon-Top grade.
- 3.16 All forged chrome moly valves shall be furnished in normalized and tempered condition in accordance with ASTM A182.
- 3.17 Stellite/ hard-facing by deposition, shall be minimum 1.6mm. Finished thickness after final machine condition. In case of renewable seat rings the same shall be seal welded for valves of size 3" and above to prevent loosening in service.

- 3.18 For all Austenitic stainless steel valves, Inter Granular Corrosion (IGC) test shall have to be conducted as per following:
- 3.18.1 ASTM A 262 practice "B" with acceptance criteria of 60 mils/ year (max.) for all materials forged, rolled, wrought and casting.
- Or
- ASTM A262 practice "E" with acceptance criteria of "No cracks as observed from 20X magnification" for all materials other than castings. "Microscopic structure to be observed from 250X magnification" in addition.
- 3.18.1 When specifically asked for in MR for high temperature application of some grades of austenitic stainless steel (e.g. SS309, 310, 316, 316H etc.) ASTM A 262 practice "C" with acceptance criteria of '15 mils/ year (max)" shall be conducted.
- 3.18.2 For the IGC test as described in Clause as above two sets of samples shall be drawn from each solution annealing lot. One set shall correspond to the highest carbon content and the other to the highest pressure rating. When testing is conducted as per practice "E", photograph of the microscopic structure shall be submitted for record.
- 3.19 All types of 321 or 347 stainless steel valves shall be in a stabilized heat treated condition. Stabilising heat treatment shall be carried out subsequent to the normal solution annealing. Soaking temperature and holding time for stabilizing heat treatment shall be 900 C and 4 hours respectively.
- 3.20 Spiral wound bonnet gaskets are to be provided with inner/ outer ring except when encapsulated gaskets type body-bonnet joints are employed. In case of non-circular gasket used in 150# valve, the same will be either corrugated metal laminated with flexible graphite or tanged gasket with SS-316 inserts.
- 3.21 Body bonnet joint is to be design to ASME SECTION-VIII DIV-1 APPENDIX-2.
- 3.22 In case of gate valve, stem to gate connection shall be accommodated within Gate only.
- 3.23 Wear travel mentioned in API 600 has to be maintained and recordd.
- 3.24 In case of gear operated globe valve, stem will be non rotating type and guides are to be provided to minimize wear & to maintain stem movement aligned in all valve orientations.
- 3.25 Ball/ Plug/ Butterfly Valves:**
- 3.25.1 As a pre qualification fire safe test as per API-607/ API 6FA/ BS 6755 Part II shall be carried on all kinds of ball (soft seated or metal seated), plug, butterfly valves and also on lubricated plug valves. The test shall

be witnessed & certified by third party inspection agency. The vendor has to submit test certificate for the particular design / type of the valve offered.

- 3.25.2 The operating levers or handles on ball valves shall indicate, by their position, whether the valve is open or closed. The open position shall be indicated when the lever or handle points in a direction parallel to the flow through the valve. In addition, it shall be impossible to reverse the indicating position inadvertently during reassembly of the valve.
- 3.25.3 Ball and plug valve shall be drilled to relieve pressure from plug port area to upstream of valve when valve is closed.
- 3.25.4 Each valve shall be supplied with a lever/wrench except for gear operated/motor operated valves.
- 3.25.5 All ball valves (soft seated or metal seated) shall be supplied with antistatic device.
- 3.25.6 Soft-seated BW/ SW end ball valves shall have a 100 mm long seamless pipe nipple (compatible to body material) welded to each end of the valve. Nipples are to be welded prior to assembling Teflon seats/ seals. Schedule of nipple shall be indicated in the valve specification sheet.
- 3.25.7 Face to face dimension of all ball valves shall be same as those of the corresponding ANSI class of gate valves (except 10 inch onwards in class 150 where the face-to-face dimensions shall be as per API 6D long pattern).
- 3.25.8 The ball shall be solid and shall not protrude outside the end of flanges of the valves.
- 3.25.9 The ball valve shall be floating ball type/trunion mounted as per following:

Rating	Size	Type
150 #	8" & below	Floating ball
	10" & above	Trunion mounted
300 #	4" & below	Floating ball
	6" and above	Trunion mounted
600 # and above	1.5" & below	Floating ball
	2" & above	Trunion mounted

- 3.25.10 Unless otherwise specified in the data sheets, bore of all reduced bore ball valves shall be limited to one size lower than the nominal bore. If not specified in the data sheet the ball valve shall be supplied with full bore.

- 3.25.11 Butterfly valves if specified/used in other than cooling water lines (Cat.'D' services) shall be high performance fire safe design to API-609.
- 3.25.12 Unless otherwise specifies, plug valve shall be pressure balance type.
- 3.25.13 Whenever the term STELLITE' is mentioned it mean facing of Seat and Disc or Wedge by Cobalt- Chromium-Tungsten alloy. Stelliting should be able to maintain hardness of 375 BHN at high temperatures. Whenever the term' HARD' is mentioned with reference to Seat or Disc of valve, it should be 350-500 BHN (min).
- 3.26 The MOVs are to be installed in an open area and the actuators shall be suitable for all weather conditions. The testing of complete assemblies of MOVs along with the actuators shall be done by the supplier at his works.
- 3.27 Ends of flanged valve of 22" size shall match corresponding flanges to MSS-SP44 unless otherwise specified.

4.0 .OPERATION

- 4.1 Generally the valves are hand wheel or lever operated. Gear operation shall be provided as under:

For sizes lower than these ranges, hand wheel/ lever/ wrench shall be provided.

For pressure balance plug valves the gear operator shall be as per manufacturers recommendation. For sizes lower than these ranges, hand wheel/ lever/ wrench shall be provided.

- 4.2 Gear operator shall be as under, with position indicators for open/ close positions, with limit stops (limit stops are not applicable for gate and globe valves)

For gate/ globe/ diaphragm valves	Totally enclosed bevel gear in grease case with grease nipples/ plugs.
For ball/ plug/ butterfly valves	Totally enclosed helical worm or combination of helical and spur gear in grease case with grease nipples/ plugs.

- 4.3 Where gear operator is not called for as above but vendor recommends a gear operator, he shall highlight such case (s).
- 4.4 Gear operator shall be so designed to operate effectively with the differential pressure across the closed valve equal to the cold non-shock pressure rating.
- 4.5 Ball, plug and butterfly valves even with wrench or lever operators shall have “open” position indicators with limit stops.
- 4.6 Hand wheel diameter shall not exceed 750 mm and lever length shall not exceed 500mm on both sides. Effort for normal operation shall not exceed 35 kgs at hand wheel periphery but for opening & or closing, the effort shall be as per EN 12570 Clause 5.1. However failing to meet the above requirements vendor shall offer gear-operated valve and quote as above.

5.0 IBR CERTIFICATION

- 5.1 For valve described “IBR”, valves shall be in accordance with the latest IBR (Indian Boiler Regulation) including the requirements specified in the specification.
- 5.2 For SW / BW end carbon steel valves under IBR, the chemical composition shall conform to the following:

Carbon (max.) : 0.25%
 Others (S, P, Mn) : as per IBR regulations

The above composition is not valid for non-IBR valves.

- 5.3 Valves coming under the purview of “IBR” (Indian Boiler Regulations) shall each be individually accompanied by IBR certificate original in Form III-C duly approved by IBR authority/ local authority empowered by the central boiler board of India. Photocopy of original certificate

duly attested by the local boiler inspector where the supplier is located is the minimum requirement for acceptance.

6.0 SPECIAL REQUIREMENT FOR VALVES IN HYDROGEN SERVICES:

6.1 GENERAL

- 6.1.1 All cast valve flanges & bodies with flange rating of Class 900 or greater shall be examined in accordance with paragraphs 7.2 through 7.5 of Appendix-VII of ASME SEC-VIII, DIV.1, regardless of casting quality factor.
- 6.1.2 All casting for body/bonnet shall be 100% radio-graphed irrespective of pressure, temperature, class & rating.
- 6.1.3 All Weld repairs shall be subjected to PWHT.
- 6.1.4 Body/bonnet/cover joints and stuffing box of all valves shall have low emission. One valve per metallurgy, per rating, per size shall be helium leak tested as per ASME Sec. V, Subsection A, Article 10 (Detector/Tracer Probe Technique), Appendix V at a minimum of 25% of the allowable (rated) cold working pressure. Selection of valves for helium leak test shall be at random. Test duration shall be as follows:

Test Duration in Minutes					
Normal size	Pressure Class				
	Upto 300	600	800&900	1500	2500
Upto 2"	3	6	9	12	12
3" to 6"	6	9	12	15	18
8" to 16"	9	9	12	15	18
18" to 24"	9	12	15	18	21

The valve shall show no leakage. No leakage is defined as a total leakage rate of less than 0.0001 ml/s of helium.

- 6.1.5 Only normalized and tempered material shall be used in the following specifications:

- Castings : A217 Gr. WC1, A217 Gr. WC4, A217 Gr. WC5, A217 Gr. WC6, A217 Gr. WC9, A217 Gr.C5, A217 Gr.C12
- Forgings : A182 Gr. F11 Cl.2

6.2 CS & AS VALVES

- 6.2.1 Bend test and magnetic particle inspection of the entire surface of body and bonnet casting shall be in accordance with ASTM A 217. Supplementary requirement S3 & S4 evaluation of magnetic particle, inspection shall be in accordance with ANSI B16.34/ MSS-SP-53 except that no linear discontinuities shall be allowed.
- 6.2.2 The Brinell hardness of heat-treated casting shall not exceed 200 BHN for carbon steel & 225 for alloy steel.
- 6.2.3 Repair to defective casting shall be outlined in writing to the purchase before repair starts. Repair method to be approved prior to welding.
- 6.2.4 Casting shall be preheated to a minimum of 400 degree F prior to welding and all Chromium Molybdenum alloys shall be post weld heat treated after welding is complete. Stress relieving is essential for welds.
- 6.2.5 Carbon steel shall be normalized and alloy steels shall be normalized and tempered.
- 6.2.6 Dye Penetrant Test of welds shall be in accordance with ASTM B165 Procedure B-2. Interpretation as per Appendix-8 of ASME-VIII Div.1.
- 6.2.7 The tensile stress for AS shall be less than 100,000 PSI.
- 6.2.8 Charpy V-notch impact testing is to be done for valve material (average 20 ft-lb for set of 3 [minimum value 15 ft-lb] at 30⁰F) to be ensured.
- 6.2.9 For radiography and acceptance criteria for valve casting, clause no. 6.3.2 will be applicable.

6.3 SS VALVES

- 6.3.1 Valve casting shall be in solution heat treated and pickled condition.
- 6.3.2 Critical body and bonnet casing section typically defined by ASME B16.34 shall be radiographed and shall meet ASTM E446 (upto 2" thick) Category A, B & CA Level 2, Category CB, OC & CD Level 3, Category D, B & F Level 0. For wall thickness 2" to 4.5" comparable plates of ASTM E186 shall be used. ASTM E94 and ASTM E142 shall be used for recommended practice & controlling quality of radiography as guide. The entire surface of all castings shall be dye penetrant inspected after pickling.
- 6.3.3 Welds shall be 100% radiographed and evaluated in accordance with paragraph 344.5 of ASME B31.3 with a minimum casting quality factor of 0.95. Dye penetration test shall be as per ASTM E165 Procedure B-2, interpretation as per Appendix-8 of ASME-VIII Div.1.

7.0 VALVES IN NACE SERVICE

7.1 Valves under this category shall meet the requirements given in NACE MR-0103-2007 and the special requirements as per material requisition by the respective refineries.

8.0 LOW TEMPERATURE & CRYOGENIC VALVES

8.1 Scope

All valves of Low Temperature Carbon Steel (LTCS) and all grades of austenitic SS (CRYO) material are categorized as cryogenic valves. All these valves shall have extended bonnet as per BS 6364 except check valves. Valves shall be suitable for installation in position (on vertical, horizontal or skewed pipeline).

8.2 Qualification Criteria

Both cryogenic test and reference list together, as indicated herein, shall be considered for vendor qualification and vendor shall furnish the same, along with his offer of particular type / rating of valves. Cryogenic test certificates of Higher size of valves w.r.t MR submitted by the vendors, also qualifies the valves of lower size of valves.

Vendors whose current supply does not cover valves of all sizes, materials and ratings (cryogenic test and reference list) required by specification, should confirm/ furnish the following for consideration of their offer:

1. Evidence of having conducted successfully at least one cryogenic test as per BS 6364. Test certificate and reference list shall be furnished with the offer.
2. Vendor shall confirm to conduct cryogenic test as per clause 8.2.1 for the remaining valves not later than 12 weeks from the date of purchase order.

Offers of vendors who do not comply with above requirement would be rejected.

Cryogenic test need not to be conducted for every order. Test conducted previously of particular type/rating is acceptable but test certificates of particular type / rating to be furnished along with the offer. Also, IRN should include the reviewing of cryogenic test certificates by the third party inspection agency.

8.2.1 Cryogenic Test:

Vendors to furnish copies of cryogenic test certificate for tests conducted as per details given below:

1. Shall be as per BS 6364.
2. Test temperature, unless specifically called for otherwise in the individual MR, shall be -45°C for LTCS and -196°C for all grades of austenitic stainless steel.
3. Tests carried out on a particular size of one type of valve, pressure rating and material shall qualify all sizes equal to and below the test valve size for the same type, pressure rating and material. In case of austenitic SS any one grade would qualify for all other grades of austenitic SS.
4. Tests shall have to be witnessed and certified by any one of the approved third party inspection agencies.

8.2.2 Reference List:

Vendor shall furnish reference list for valves supplied for cryogenic service indicating the name of client, year of supply, size, material, pressure rating, type of valve and quantity.

8.2.3 Post Order Testing Procedure:

1. Before conducting post order testing, vendor shall submit the following for approval.
 - a) Test procedure (as per BS 6364).
 - b) Cross-section drawing of the valve with material of construction.
 - c) Schematic of test rig (as per BS 6364) with complete details.
2. Test has to be conducted on largest size of order for each type of valve and for each material and class rating. Vendor shall offer one, two or three valves for selection of test valve by inspector depending upon whether quantity of largest valve in the order is one, two or three and more than three respectively.

In the event of failure of the test valve to meet the specification requirements, the vendor shall conduct test on two more valves. If the other two valves which pass test successfully, are of lower size, then the qualification will be valid only to sizes upto which test has been conducted successfully.

3. In case of non-conductance of cryogenic test(s) within 12 weeks or failure in the test(s) conducted after receipt of order, the owner reserves the right to invoke any of the provisions of the purchase order including cancellation of the purchase order at the risk and cost of vendor.
- 8.3 Bonnet extension, wherever specified in the valve sheet to BS 6364 shall be for "non cold box application" unless otherwise specified in the MR. Even if not called for in valve sheet, valves indicated as "LT" or "CRYO" shall be supplied with bonnet extension.
- 8.4 Bonnet and Gland extension joints shall be of butt welded construction.
- 8.5 Repair welding procedure for austenitic stainless steel valves in "CRYO" service shall have to be qualified for impact test as per ASME B31.3. Minimum acceptable impact energy shall be 20J or lateral expansion of 0.38 mm at temperature of (-) 196⁰C.
- 8.6 Wherever impact test of CS studs/ nuts is called for in the data sheet, the impact value shall be 27J at the intended service temperature specified in the data sheets.
- 8.7 Repair welding procedure for low temperature carbon steel valves in "LT" service shall have to be qualified for impact test as per ASME B31.3.

9.0 SCOPE OF INSPECTION & TESTING OF TPI

Every valve shall be subjected to all the mandatory tests and checks called in the respective codes/ data sheets by TPI/ IBR agency.

9.1 Forged Valves

1. Visual and dimensional inspection.
2. Review of material test certificates.
3. Any mandatory or supplementary test.
4. Hydrostatic test on 10% valves selected on random basis.
5. Strip check is required for 1% of total order quantity of valves of each type, class & material of construction of body & bonnet irrespective of sizes (sample selection will be generally in highest sizes in the lot) in similar category. However, strip check is not required for CS/ Brass/ Bronze material valves with 13% Cr/ Brass/ Bronze trims.

9.2 Cast steel valves

1. Visual and dimensional inspection.
2. Review of material test certificates.

3. Review of radiographs/ radiographic reports or any other NDT tests wherever applicable as per data sheet.
 4. Any mandatory or supplementary test.
 5. Hydrostatic test 100% for body, 10% other test.
 6. Strip check is required for 1% of total order quantity of valves of each type, class & material of construction of body & bonnet irrespective of sizes (sample selection will be generally in highest sizes in the lot) in similar category. However, strip check is not required for CS/ Brass/ Bronze material valves with 13% Cr/ Brass/ Bronze trims.
- 9.3 In case of motor operated or actuator-operated valves, functional/ operational checks as per the requirements of the specifications shall be made on each valve.
- 9.4 Third party inspection is also required for IBR valves which will be prior to IBR inspection, the TPI will verify the documents and dimensional check-up.
- 9.5 RCF reserves the right to review / inspect / witness the items at any stage of inspection.
- 9.6 The list of approved inspection agency is:-
- a) Engineering India Limited
 - b) Lloyds Register of Shipping
 - c) Project & Development India Limited
 - d) RITES Limited
 - e) Det Norske Veritas
 - f) TUV Rhineland (I) Pvt. Ltd.
 - g) TUV India Pvt.

10.0 RADIOGRAPHY OF CAST VALVES:

10.1 Valve castings shall undergo radiographic examination as specified in individual valve material spec sheet. Radiography specified as random 10% or 20% etc. in the respective **valve data sheet** implies 10% or 20% etc. of number of valves ordered against each item number with a minimum of one valve against each item.

Material	Rating	Size range	Radiography
All	150#	24" and below	NIL**
		26" and above*	100%
	300#	16" and below	NIL**
		18" and above*	100%
	600# & above	All sizes	100%

* No radiography is required for valves of size 26" in cooling water service (A3A).

** For sizes 24" & below in 150# and 16" & below in 300#, radiography percentage if specifically mentioned in individual valve material spec sheet shall govern.

- 10.2 Radiography procedure, areas of casting to be radiographed shall be as per ASME B16.34 and acceptance criteria shall be as per ASME B16.34 Annexure-B. However for areas of casting to be radiographed for types of valves not covered in ASME B16.34, vendor shall enclose details of areas to be radiographed in the line with ASME B16.34.
- 10.3 For random radiography wherever specified in individual data sheets, the sampling shall be per size of the quantity ordered for each foundry.

- 10.4 Radiography wherever specified in the data sheets or as above shall be done by X-ray/ γ -ray to get the required sensitivity.
- 10.5 Over and above the stipulations laid down above all valve castings when sourced indigenously shall only be procured from approved & reputed foundries.

11.0 MARKING

- 11.1 Valve markings, symbols, abbreviations etc. shall be in accordance with MSS-SP-25 or the standard referred in specification sheet as applicable. Vendors name, valve rating, material designation, nominal size, direction of flow (if any) etc. shall be integral on the body.
- 11.2 Each valve shall have a corrosion resistant tag giving size, valve tag/ code no, securely attached on the valve body.
- 11.3 Paint or ink for marking shall not contain any harmful metal or metal salts such as zinc, lead or copper which causes corrosive attack on heating.
- 11.4 Carbon steel/ Alloy steel valves shall be painted with one coat of inorganic zinc silicate (minimum DFT 65 to 75 microns).
- 11.5 All alloy steel high temperature valves shall be painted with heat resistant silicone paint suitable for intended temperature.
- 11.6 All 3½ Ni steel/ LTCS valves shall be painted with one coat of inorganic zinc silicate coating.
- 11.7 Non –IBR CS valves shall be painted with two coats of Aluminum paint.
- 11.8 IBR valves shall be painted with two coats of Red paint in body bonnet/ body cover joint.
- 11.9 NACE valves shall be painted in yellow colour (synthetic enamel) in body bonnet/ body cover joint.

12.0 DESPATCH

- 12.1 After inspection valves shall be dry, clean and free from moisture, dirt and loose foreign material of any kind.
- 12.2 Valves shall be protected from rust, corrosion and any mechanical damage during transportation, shipment and storage.
- 12.3 Rust preventive on machined surfaces to be welded shall be easily removable with petroleum solvent or which shall not be harmful to welding.

12.4 Each end of valves shall be protected with the following materials:

Flange Face	:	Wood, Metal or Plastic cover
Beveled End	:	Wood, Metal or Plastic cover
SW & SCRD End	:	Plastic Cap

12.5 For special service valve additional requirement (if any) of dispatch shall also be met.

12.6 End protectors of wood/ plastic to be used on flange faces shall be attached by at least three bolts and shall not be smaller than the outside diameter of the flange. However, plastic caps for SW & SCRD end valves shall be press fit type.

12.7 End protectors to be used on beveled end shall be securely and tightly attached.

12.8 All alloy materials tested by PMI shall be identified using either of the following methods by indicating "PMI OK"

- a) Bar Code/ Hologram Sticker
- b) A low stress stamp marking
- c) Any other method

**INSPECTION AND TEST PLAN
FOR
VALVES**

INSPECTION & TEST PLAN FOR VALVES

1.0 SCOPE

This Inspection and Test Plan covers the minimum testing requirements of Valves.

2.0 Reference Documents

PO/ PR/ Standards referred therein/ Job specifications/ Approved documents.

3.0 INSPECTION AND TEST REQUIREMENTS

SL. NO.	STAGE/ ACTIVITY	CHARACTERISTICS	QUANTUM OF CHECK	RECORD	SCOPE OF INSPECTION		
					SUB SUPPLIER	SUPPLIER	TPIA
1.0	Procedure						
1.1	Hydrostatic Test, Heat Treatment, NDT, Helium Leak Test and Other Procedures	Documented Procedures	100%	Procedure Documents	-	H	R
1.2	WPS, PQR & WPQ	Welding Parameters & Qualification Record	100%	WPS, PQR & WPQ	-	H	W-New R-Existing
1.3	Pre-Qualification Tests	Fire safe, Cryogenic & Other Test as applicable	As per PR/ Purchase Specification	Acceptance Report	-	H	H (If New)
2.0	Material Inspection						

SL. NO.	STAGE/ ACTIVITY	CHARACTERISTICS	QUANTUM OF CHECK	RECORD	SCOPE OF INSPECTION		
					SUB SUPPLIER	SUPPLIER	TPIA
2.1	Castings & Forgings (Body, Bonnet, Disc, Stem, Body Ring)	Chemical, Mechanical, Heat Treatment, NDT, IGC & Other Properties as applicable	100%	Test Certificate	H	R	R
2.2	Castings & Forgings (Body, Bonnet, Disc, Stem, Body Ring)	Visual & Dimension	100%	Inspection Report	H	H	-
2.3	Body and Bonnet Castings	Radiography Examination	As per PR/ Purchase Specification	Films and report	H	R	R
2.4	Bars for Trim material	Chemical Analysis	Each Heat	Test Certificates & Lab Report	H	R	-
2.5	Gaskets, Gear units, Fasteners, Gland, Packings, etc.	Physical/ Chemical Properties	100%	Test Certificates & Lab Report	H	R	-
2.6	Actuators as applicable	Performance, Statutory Certificates as applicable	100%	Test Certificates, Inspection Report	H	H	R
3.0	In Process Inspection						
3.1	Welding	Welding Parameters	100%	Inspection	-	H	-

SL. NO.	STAGE/ ACTIVITY	CHARACTERISTICS	QUANTUM OF CHECK	RECORD	SCOPE OF INSPECTION		
					SUB SUPPLIER	SUPPLIER	TPIA
		as per WPS/ PQR		Reports			
3.2	Machining of components	Visual/ Dimension	100%	Inspection Reports	H		-
4.0	Final Inspection						
4.1	Hydrostatic/ Pneumatic Test and Helium Leak test as applicable	Leak Check	As per PR/ Purchase Specification	Test Report	H		RW (Note-1)
4.2	Visual/ Dimension	Surface & Dimension Check	100%	Test Report	H		RW (Note-1)
4.3	Functional Test for Actuator Operated Valves	Satisfactory Performance	100%	Test Report	H		RW
4.4	PMI Check	Chemical	As per PR/ Standard	Inspection Report	H		RW
4.5	Strip Check (As applicable)	Verify Components & Differential hardness if applicable	As per PR/ Purchase Specification	Inspection Report	H		RW (Note-1)
4.6	Final Stamping	Stamping Of Accepted Valves	Stamping of Valves which are witnessed by TPIA	Inspection Report	H		RW (Note-1)
5.0	Painting						
5.1	Painting and Color coding as	Visual/ DFT Check	100%	Inspection Report	H		-

SL. NO.	STAGE/ ACTIVITY	CHARACTERISTICS	QUANTUM OF CHECK	RECORD	SCOPE OF INSPECTION		
					SUB SUPPLIER	SUPPLIER	TPIA
	applicable						
6.0	Documentation & IC						
6.1	Documentation & Inspection Certificate (IC)	Review of Inspection Test Reports & Issue of IC	100%	Supplier TC & IC	-	H	H

Legend: H – Hold (Do not proceed without approval), P – Perform, RW – Random Witness (As specified or 10% (min. 1 no. of each size and type of Bulk item), R – Review, W – Witness (Give due notice, work may proceed after scheduled date).

NOTES (AS APPLICABLE):

1. For Non NACE & Non Hydrogen service Carbon Steel Valves up to size 12” will be accepted on review of Supplier Test Certificates. Supplier Test Certificate to be reviewed by CLIENT/ TPIA.
2. This document describes the generic test requirements. Any additional test or Inspection scope if specified in contract documents shall also be applicable (unless otherwise agreed upon).
3. Acceptance Norms for all the activities shall be as per PO/ PR/ Standards referred there in/ Job specification/ approved documents.



CHAPTER-2

**TECHNICAL SPECIFICATION FOR SEAMLESS PIPE &
TUBE**

AND

INSPECTION TEST PLAN

1.0 GENERAL

1.1 All pipes and their dimensions, tolerances, chemical composition, physical properties, heat treatment, hydro-test and other testing and marking requirements shall conform to the latest codes and standards specified in the material description. This section contains certain additional & special requirements.

1.2 The offered pipes to various ASTM/ ASME standards shall also meet requirements of Metric unit system of relevant code e.g. ASTM A312 shall also meet requirements of ASTM A312M and ASME B36.10 shall also meet requirements of ASME B36.10M.

1.3 Testing:

1.3.1 Test reports shall be supplied for all mandatory tests as per the applicable material specification.

1.3.2 Material test certificates (physical property, chemical composition & heat treatment report) shall also be furnished for the pipes supplied. For alloy steel pipes Mill test certificate containing above information shall be furnished.

1.3.3 All C.S. pipes with wall thickness greater than 24.5 mm shall be impact tested. If welding is used in manufacture, impact test of Heat Affected Zone (HAZ) and weld material shall also be carried out. Testing shall be according to Para 323.3 of ASME B31.3.

1.3.4 Where the pipe material is specified as A312TP304/316L with suffix-RT the pipe shall be radiographed in accordance with A312 supplementary requirement S5.

1.3.5 Where the pipe material is specified as A312TP304/316L with suffix-'spot radiographed' the pipe shall be spot radiographed in accordance with requirement of ASME B31.3 para 341.5.1.

1.3.6 Pipes with a positive quality tolerance of maximum one random length shall be acceptable (no tolerance on negative side).

1.3.7 PMI test: Positive material specification to be performed at vendors works on alloy steel pipes and clad pipes. The extent of PMI examination as follows:

- 100% (for pipes procured from traders).
 - 2 random samples drawn from each size/ heat/ lot (for pipes procured directly from Mills).
- a) For welded pipes PMI shall be performed on base metal as well as weldments.

- b) Whenever any sample drawn to PMI test on the basis of percentage selection fails to meet specification requirements, 100% of items of lot shall be tested for PMI.

1.3.8 For Hydrocarbon service, EFSW pipes confirming to ASTM A 672 shall be 100% radiograph.

1.4 Manufacturing processes:

1.4.1 Steel made by acid Bessemer process shall not be acceptable.

1.4.2 Spirally welded pipes below 24 inch shall not be acceptable.

1.5 Pipes shall be supplied in single or double random lengths of 4 to 7 and 7 to 14 meters respectively.

1.6 Welding joints:

1.6.1 Seamless and E.R.W pipes shall not have any circumferential seam joint in a random length. However, in case of E.FS.W pipe, in one random length one welded circumferential seam of same quality as longitudinal weld is permitted. This weld shall be at least 2.0 m from either end. The longitudinal seams of the two portions shall be staggered by 90⁰ single random length in such cases shall be 5 to 7M.

1.7 Unless otherwise mentioned in the respective material code, E. FS. W /SAW pipes < 36” shall not have more than one longitudinal seam joint and E.FS.W/SAW pipes ≥ 36” shall not have more than two longitudinal seam joints.

1.8 Pipe with screwed ends shall have NPT external taper pipe threads conforming to ASME/ ANSI B1.20.1/ IS554 for 2” to 6” NB.

1.9 Pipe shall be bevelled in accordance with ANSI B16.25, except for nominal sizes NPS ≤ 1½” shall be cut square/ plain end & dimensions as per ANSI B 36.10. Weld contours shall be as follows:

Material	Wall thickness	Weld contour
Carbon steel (Except low temp. carbon steel)	Upto 22mm	Figure 2 Type A
	> 22mm	Figure 3 Type A
Alloy steel, stainless steel & low temperature carbon steel	Upto 10mm	Figure 4
	> 10mm & upto 25mm	Figure 5 Type A
	> 25mm	Figure 6 Type A

1.10 Galvanized pipes shall be coated with zinc by hot dip process conforming to ASTM A123/ IS 4736.

1.11 All austenitic stainless steel pipes shall be supplied in solution annealed condition. All types of 321 or 347 stainless steel pipes shall

be in a stabilized heat-treated condition. Stabilizing heat treatment shall be carried out subsequent to the normal solution annealing. Soaking time & holding temperature for stabilizing heat treatment shall be 900⁰C & 4 hrs respectively.

1.12 All the seamless carbon steel pipes of size 1½” NPS and under shall be Cold-drawn/ hot finished. Carbon steel seamless pipes of size 2” & over shall be furnished hot finished. Seamless pipes cold-drawn from higher thickness pipes are not acceptable.

1.13 I.G.C Test for Stainless Steels:

1.13.1 For all austenitic stainless steel pipes inter-granular corrosion test shall have to be conducted as per following:

ASTM A262 Practice “B” with acceptance criteria of 60 mils/year(max.)

Or

ASTM A262 Practice “E” with acceptance criteria of “No cracks as observed from 20X Magnification” & “Microscopic structure to be observed from 250X magnification”.

1.13.2 When specifically asked for high temperature application for some grades of austenitic stainless steel (e.g. SS309, 310, 316, 316H etc) ASTM A262 Practice “C” with acceptance criteria of “15 mils/year (max.)” shall have to be conducted.

1.13.3 For the IGC test as described as above, two sets of samples shall be drawn from each solution annealing lot; one set corresponding to highest carbon content and the other set corresponding to the highest pipe thickness. When testing is conducted as per Practice ‘E’ photograph of microscopic structure shall be submitted for record.

1.14 All welded pipes indicated as ‘CRYO’ & ‘LT’ shall be impact tested as per requirement and acceptance criteria of ASME B31.3. The impact test temperature shall be –196C & -45C for stainless steel and carbon steel respectively unless specifically mentioned otherwise.

1.15 Specified heat treatment for carbon steel and alloy steel and solution annealing for stainless steel pipes shall be carried out after weld repairs. Number of weld repairs at the same spot shall be restricted to maximum two by approved repair procedure.

1.16 For black or galvanised pipes to IS 1239, the minimum percentage of elongation shall be 20%.

1.17 All 1Cr-0.5 Mo and 1.25 Cr-0.5Mo seamless pipes shall be normalized and tempered.

1.18 For all weld Alloy steel pipes with mandatory requirement of heat treatment and radiography, radiography shall be performed after heat treatment.

2.0 PIPES IN HYDROGEN SERVICES:

2.1 All Carbon Steel pipes having wall thickness 9.53 mm (0.375") and above shall be normalized. Cold drawn pipes shall be normalized after the final cold draw pass for all thickness.

2.2 All alloy steel (Cr-Mo) pipes shall be normalized and tempered. The normalizing and tempering shall be a separate heating operation and not a part of the hot forming operation. The maximum room temperature tensile strength shall be 100,000 psi.

2.3 All carbon steel pipes having wall thickness 19 mm (0.75") and above shall be post weld heat-treated.

2.4 All alloy steel (Cr-Mo) pipes shall be post weld heat treated irrespective of type or thickness of weld.

2.5 All austenitic stainless steel grades shall be solution annealed after welding. 100% radiography of welded joints shall be done both before and after PWHT.

2.6 For carbon steel pipes hardness of weld and HAZ shall be 200 BHN (max.). For alloy steel pipes, hardness of weld and HAZ shall be 225 BHN (max.).

2.7 For all austenitic stainless steel, the weld deposit shall be checked for Ferrite Content (FN). A FN not less than 3% and not more than 10% is required to avoid sigma phase embrittlement during heat treatment. FN shall be determined by Ferrite-scope prior to post weld heat treatment (PWHT).

2.8 For all Carbon Steel (CS) and Alloy Steel (AS) pipes with wall thickness over 19 mm, Charpy V- notch impact testing shall be carried out in accordance with paragraph UG-84 of ASME Section VIII, Div 1 for weld metal and base metal from the thickest item per heat of material and per heat treating batch. Impact test specimen shall be in complete heat treated condition and accordance with ASTM A 370. Impact energies at 0⁰C shall average greater than 27 J (20 ft-lb) per set of 3 specimen, with a minimum 19 J (15 ft-lb).

2.9 If welding is used in manufacture, impact test of Heat Affected Zone (HAZ) and weld metal shall also be carried out.

3.0 NACE CARBON STEEL PIPES:

- 3.1 Pipes under this category shall meet the requirements given in NACE MR-0103-2007.
- 3.2 Steel must be fully killed carbon steel type and must have been produced by Vacuum Degassing process.
- 3.3 Steel shall be calcium treated for inclusion morphology control.
- 3.4 Ultimate strength of the steel shall be limited to maximum of 80,000 PSI. The yield versus UT strength shall be limited to maximum of 0.80.
- 3.5 Carbon equivalent in all CS material shall be calculated per the formula given below.

$$CE = C + Mn/6 + (Cr + Mo + V)/5 + (Ni + Cu)/15$$

- 3.6 The longitudinal seam of welded pipes shall be subjected to 100% radiography.
- 3.7 Only following American Specifications, as specified against each product are permitted:

ASTM A 106 Gr. B/API 5L GR-B Seamless
 API 5L Gr. B, SAW (LONGITUDINAL)
 ASTM A 333 GR 1 & 6 SEAMLESS

3.8 Chemistry Control

The chemical analysis shall be carried out on heat as well as on product as per relevant product material specifications and shall meet the requirements of Table-1.

SPECIFICATION			
	ASTM A 106 Gr.B/ API 5L Gr.B (Seamless)	API5L Gr. B (SAW)	ASTM A 333 GR 1 & 6
C	0.20% max.	0.20% max.	0.20% max
S	0.02% max.	0.003% max.	0.02% max
P	0.03% max.	0.02% max.	0.025% max
Ni	0.4 % max.	0.2 % max.	-
CE	0.42 max.	0.40 max.	0.42 max

- 3.9 Mechanical tests shall be as per specified material specification.

3.10 Hardness

- 3.10.1 Maximum hardness shall be limited to 200 BHN at all places including the weldments and measurement shall be as per ASTM E-18 or ASTM E-92 respectively.

3.10.2 Hardness test shall be conducted on a sample of each heat and on each finished product. Waiver may be given only for those products, which can get damaged due to hardness test. For small products which cannot be hardness tested individually, the manufacturer shall conduct test on a random basis by selecting components from production run or stores batches to ensure that the products complies fully with hardness requirements. The products for which hardness values are found in excess of specified value shall be rejected. If the hardness on the sample of a heat is more than the acceptable value, then the entire raw material from the heat shall be rejected.

3.10.3 For SS 316 material Moly% shall be 2.3% minimum.

4.0 IBR PIPES

4.1 Pipes under purview of IBR shall be accompanied with IBR certificate original in Form IIIA, duly approved and countersigned by IBR authority/ local authority/ manufacturer empowered by the central boiler board of India and issue inspection certificate in form-IIID. Photocopy of the original certificate duly attested by the local boiler inspector where the supplier is located is the minimum requirement for acceptance.

4.2 For materials 1¼ Cr- ½ Mo (ASTM A335 Gr. P11/ A691 Gr. 1¼ Cr) & 2¼ Cr - 1Mo (ASTM A335 Gr. P22/ A691 Gr. 2¼ Cr), Form III-A approved by IBR shall include the tabulation of E_t , S_c & S_r values for the entire temperature range given below. E_t , S_c & S_r values shall be such that throughout the temperature range

$$\begin{array}{l} E_t / 1.5 \geq \\ S_r / 1.5 \geq \\ S_c \geq \end{array} \quad \left| \quad S_A \right.$$

Where,

S_A : Allowable stress at the working metal temperature (As per latest addition of ASME B-31.3)

E_t : Yield pint (0.2% proof stress at the working metal temperature)

S_c : The average stress to produce elongation of 1%(creep) in 100000 hrs at the working metal temperature.

S_r : The average stress to produce rupture in 100000 hrs at the working metal temperature and in no case more than 1.33 times the lowest stress to produce rupture at this temperature.

4.3 For carbon steal pipes under IBR the chemical composition shall conform to the following:

Carbon (max) : 0.25%
Others (S, P, Mn) : As prescribed in IBR regulation.

The chemical composition as indicated in this clause is not applicable

for pipes other than IBR services.

4.4 No other third party inspection is required.

4.5 SS TUBE SEAMLESS

Tolerance in delivered quantities

Tolerance = ± 1 length / $\pm 1\%$ whichever is less.

Tubes shall be delivered in coils of length 15-20 metres or standard length

Of 4-7 meters as specified in the specification sheet.

Tube shall be delivered in 5-7 meters of length properly capped at both ends.

Manufacture

The seamless stainless steel tubes as per ASTM-A-269 shall be made by the seamless process. Tubes shall be cold finished. Tubes shall be white pickled free from scale and soft annealed and suitable for bending. The finished tube should be reasonably straight and free from dents and injurious defects and shall have good finish and smooth ends.

5.0 HYDROSTATIC TEST

- Irrespective of requirement specified in code all pipes shall be hydrostatically tested.
- The testing of A106, A333, A335, A358 & A672 shall be as per A530. A312 & A268 shall be as per A999.
- API5L shall be as per API5L.

5.1 Hydro-testing of pipes (at least one from each batch) shall be witnessed by TPI at vendor's shop. Hydro-testing of SS pipes shall be done with potable water with max. chloride content 250 ppmw (as per NACE RP-0170) where draining of test fluid is possible.

5.2 Calculation to establish hydro-test pressure shall be performed by vendor in accordance with the standards. Checking of calculation and witnessing of hydro-testing shall be performed by TPI agency.

6.0 SCOPE OF INSPECTION BY THIRD PARTY INSPECTION AGENCY

- 6.1 The scope of inspection shall be read with item description, codes stipulated in purchase requisition, requirement of test and inspection as per this technical specification.
- 6.2 Test to be witnessed:
- i) Testing for physical properties.
 - ii) Visual Inspection & Dimensional check
 - a) 10% random basis for each heat. Minimum one length in case of pipe is procured from manufacture.
 - b) 100% in case the pipe is procured from stockiest/ traders.
 - iii) Hydrostatic test
 - a) 10% random basis fro each heat. Minimum one length in case the pipe is procured from manufacture.
 - b) 100% in case the pipe is procured from stockiest / traders.
- 6.3 Review of documents:
- i) Mill test certificate of raw materials.
 - ii) Material identification reports.
 - iii) Radiographs (if required).
 - iv) Heat treatments (if required).
 - v) Material composition as per NACE (if required).
 - vi) Manufacturer's test certificate.
 - vii) Hydro-test 100%
 - viii) Supplementary test as required.
 - ix) Manufacturer's test certificates for 100% visual & dimension check in case of manufacturer
- 6.4 Third party inspection release note shall contain the information on test witnessed, documents reviewed, observations/ remarks, identifications, order status and date(s) of inspection. The original certificate shall be furnished with supply of material.
- 6.5 Third party inspector shall stamp each length of pipe based on the same performed by the manufacturer and shall mention the same in the inspection release note. For small bore i.e. 1½" and below, stamping on the bundle of pipes instead of each length may be considered.

- 6.4 The inspection and test plan for traders and manufacturer is enclosed.
- 6.5 RCF reserves the right to review / inspect / witness the items at any stage of inspection.
- 6.6 The list of approved inspection agency is:-
- a) Engineering India Limited
 - b) Lloyds Register of Shipping
 - c) Project & Development India Limited
 - d) RITES Limited
 - e) Det Norske Veritas
 - f) TUV Rhineland (I) Pvt. Ltd.
 - g) TUV India Pvt.

7.0 TECHNICAL SPECIFICATION AND SCOPE OF INSPECTION OF CLADDED PIPE

- 8.0 Acceptable method of fabrication of cladded pipe to be seamless or centrifugally cast CRA. The cladding should have metallurgical bond, mechanical bond will not be accepted.
- 8.1 Acceptable base material is A515 Gr 65 and 516 Gr 60/65/70 will be considered as equivalent.

- 8.3 TPI to review material test certificates for chemical composition, tensile, guided bend and flattening test as per API 5LD.
- 8.4 Molybdenum in the cladding to be minimum 2.5%.
- 8.5 Diameter of the pipe to be measured and variation to be within 0.75%. TPI to review the same.
- 8.6 Minimum thickness tolerance for pipe thickness to be -12.5%.
- 8.7 Intergranular corrosion test to be carried out as per API 5LD and result reviewed by TPI.
- 8.8 Hydro-test to be done as per $S = 2st/d$, limited to 3000 PSI and result to be witnessed by TPI.
- 8.9 Thickness of the cladding to be minimum 2.5mm, to be witnessed by TPI.
- 8.10 Pipe to be ultrasonically tested as per ASTM 578 level and results to be reviewed by TPI for acceptance.
- 8.11 PMI to be carried out and witnessed by TPI at least at both the ends at 180° apart.
- 8.12 Pipe to be checked visually and to be free from any visible defects, scales, dents, marks etc and to be straight. TPI to witness.

9.0 MARKING & DESPATCH

- 9.1 All pipes shall be marked in accordance with the applicable codes, standards & specifications. In addition RCF item code & special condition like "IBR", "CRYO", "NACE", "H2" etc shall also be marked.
- 9.2 Pipes under "IBR", "CRYO", "NACE", "H2" shall be painted in red strips, light purple brown stripes, canary yellow & sea green stripes respectively longitudinally throughout the length (25mm width) for easy identification. Marking of pipes circumferentially for sizes 1" and below at one metre interval along the length of pipes is also acceptable.
- 9.3 Paint or ink for marking shall not contain any harmful metal or metallic salts such as zinc, lead or copper which cause corrosive attack on heating.
- 9.4 Pipe shall be dry, clean and free from moisture, dirt, and loose foreign materials of any kind.
- 9.5 Pipes shall be protected from rust & corrosion.

- 9.6 Rust preventive shall be applied. These when used on machined surfaces to be welded shall be easily removable with a petroleum solvent and the same shall not be harmful to welding.
- 9.7 Both ends of the pipe shall be protected with the following material:
- | | | |
|--------------|---|-------------------------------|
| Plain end | : | Plastic cap |
| Bevel end | : | Wood, Metal or plastic cover |
| Threaded end | : | Metal or plastic threaded cap |
- 9.8 Pipes may be provided with plastic pushfit type end caps/ steel caps without belt wire.
- 9.9 Steel end protectors to be used on galvanized pipes shall be galvanized. Plastic caps can also be used as end protectors for galvanized pipe ends.
- 9.10 All alloy materials tested by PMI shall be identified using either of the following methods by indicating "PMI OK"
- a) Bar Code/ Hologram Sticker
 - b) A low stress stamp marking

INSPECTION & TEST PLAN

Sl. No.	Applicable codes and specifications : ASTM/P.O Technical specification/ Pipe Specification of	INSPECTION AND TEST PLAN FOR PIPES (FOR MANUFACTURER)										SPECIFICATION		Rev. 0
		Component	Characteristics	Method Check	Quantum of check	Reference Documents			Acceptance Norms	Records	Scope of inspection			
						Purchase requisition/ STD/ Technical Specification	ASTM- P.O	Purchase requisition/ P.O			Sub-Vendor	Vendor	TPI	
1a	Raw material inspection	Bullet/ Mother hollow	Marking and correlation with TC	Review records & visual	100%	Purchase requisition/ STD/ Technical Specification	ASTM- P.O	Purchase requisition/ P.O	Purchase requisition/ ASTM-STD/ Technical Specification	Inspection report		R		
1b	Raw material inspection	Bullet/ Mother hollow	Chemical composition	Spectro	One sample per heat	Purchase requisition/ STD/ Technical Specification	ASTM- P.O	Purchase requisition/ P.O	Purchase requisition/ ASTM-STD/ Technical Specification	Inspection report		R		
1c	Raw material inspection	Bullet/ Mother hollow	Internal soundness	Macro-etching	One sample per heat	Internal standard		Internal standard	Internal standard	Inspection report		R		
2	Pipe rolling heating, Hot rolling Straightening	Pipe	Process controls	As per internal plan	As per internal plan	Purchase requisition/ STD/ Technical Specification	ASTM- P.O	Internal standard	Internal standard	Inspection report		W		
3	Heat treatment (if applicable)	Pipe	HT cycle (Time & temperature)	Furnace recorder	100%	Purchase requisition/ STD/ Technical Specification	ASTM- P.O	Purchase requisition/ P.O	Purchase requisition/ ASTM-STD/ Technical Specification	Inspection report		W	R	
4	Non destructive testing (if applicable)	Pipe	Surface & internal imperfections	UT, Eddy current, MPI or other specified	Purchase requisition/ ASTM-STD/ P.O	Purchase requisition/ STD/ Technical Specification	ASTM- P.O	Purchase requisition/ P.O	Purchase requisition/ ASTM-STD/ Technical Specification	Inspection report, General record		W	R	
5	Destructive testing (Note special impact hardness)	Pipe	Chemical & Mechanical properties	Chemical tensile flattening bend,	Each HT lot/ each heat no/ size	Purchase requisition/ STD/ Technical Specification	ASTM- P.O	Purchase requisition/ P.O	Purchase requisition/ ASTM-STD/ Technical Specification	Lab report		W	H	

	requirements for H ₂ service)				hardness impact				Specification										
6	Destructive Testing (For SS materials)	Pipe	Corrosion properties		IGC test	Highest thickness highest carbon/HT lot	&	Purchase requisition/ STD/ Technical Specification	ASTM- P.O	Purchase requisition/ ASTM-STD/ Technical Specification	Lab report								H
7	Hydrotesting	Pipe	Leak check		Visual	100% vendor random TPI	by at by	Purchase requisition/ STD/ Technical Specification	ASTM- P.O	Purchase requisition/ ASTM-STD/ Technical Specification	Inspection report, Hydro-graph								H
8	Final inspection	Pipe	Surface condition, straightness, End finish Bevel angle, Root face. Outer dia, Thickness Length, End finish, Coating, marking Colour coding, End caps.		Visual dimensional	100%		Purchase requisition/ STD/ Technical Specification	ASTM- P.O	Purchase requisition/ ASTM-STD/ Technical Specification	Inspection report								H
9	Weight checking	Pipe	Weight		Weight scale	100%		Purchase requisition/ STD/ Technical Specification	ASTM- P.O	Purchase requisition/ ASTM-STD/ Technical Specification	Inspection report								W
10	Final inspection	Pipe	PMI check		X-ray Florescence/ Spectrometer			Purchase requisition/ STD/ Technical Specification	ASTM- P.O	Purchase requisition/ ASTM-STD/ Technical Specification	Inspection report								H

Legends: H- Hold(offer for witness & obtain clearance), W- Witness, R- Review, A- Approval, I- Information, X- submit PO-Purchase order, PR- Purchase Requisition

All the NDT/ Leak testing/ Heat treatment/ Special manufacturing procedures have to be specially approved or only previously approved procedures have to be used. In case of conflict between purchase specification, contract documents and QAP more stringent conditions shall be applicable. This document describes generally the requirements pertaining to all types of pipes. Requirements specific to the item are only applicable.

		Inspection and test plan for pipes (for Traders)				Specification	Rev 0
Applicable codes and specifications: ASTM/ P.O Technical Specification/ Pipe Specification Sheet						SCOPE OF INSPECTION	
A. Review of manufacturer material test certificates and TPI certificates issued to manufacturer.							
Sl. No.	Type	Characteristics	Reference documents	Acceptance norms	Record	Trader	TPI
1	Material testing	Chemical Composition	Purchase requisition/ ASTM-STD/P.O Technical specification	Purchase requisition/ ASTM-STD/P.O Technical specification	TPI certificates of materials at the manufacturer works	R	R & Endorse
2	Heat treatment (if applicable)	HT cycle (Time & temperature)	Purchase requisition/ ASTM-STD/P.O Technical specification	Purchase requisition/ ASTM-STD/P.O Technical specification	TPI certificates of materials at the manufacturer works	R	R & Endorse
3	Non destructive testing (if applicable)	Surface & internal imperfections	Purchase requisition/ ASTM-STD/P.O Technical specification	Purchase requisition/ ASTM-STD/P.O Technical specification	TPI certificates of materials at the manufacturer works	R	R & Endorse
4	Destructive Testing (Note special impact hardness requirements for H2 service)	Chemical & Mechanical properties	Purchase requisition/ ASTM-STD/P.O Technical specification	Purchase requisition/ ASTM-STD/P.O Technical specification	TPI certificates of materials at the manufacturer works	R	R & Endorse
5	Destructive testing (for SS materials)	Corrosion properties	Purchase requisition/ ASTM-STD/P.O Technical specification	Purchase requisition/ ASTM-STD/P.O Technical specification	TPI certificates of materials at the manufacturer works	R	R & Endorse
6	Final inspection	Hydro-testing condition, surface checking, dimension straightness, End finish, PMI check	Purchase requisition/ ASTM-STD/P.O Technical specification	Purchase requisition/ ASTM-STD/P.O Technical specification	TPI certificates of materials at the manufacturer works	R	R & Endorse

Legend: H- Hold (Offer for witness & obtain clearance), W- Witness, R- Review, A- Approval, I- Information, X- Submit, PO- Purchase Order, PR- Purchase Requisition.

		Inspection and test plan for pipes (for Traders)				Specification		Rev	
								0	
Applicable codes and Specification Sheet		ASTM/ P.O Technical Specification/ Pipe				SCOPE OF INSPECTION			
B. Review of manufacturer material test certificates and TPI certificates issued to manufacturer.									
Sl. No.	Type	Characteristics	Quantum of check	Reference documents	Acceptance norms	Record	Trader	TPI	
1	Tensile test	Mechanical properties	One sample from each lot of 100 length having same size, thickness, material & heat	Purchase Requisition/ ASTM-STD/ P.O Technical specification	Purchase requisition/ ASTM-STD/P.O Technical specification	Testing results of TPI-approved test house	W	Sample drawing-W Test results-R	
2	Product Analysis	Chemical Properties	One sample from each lot of 100 length having same size, thickness, material & heat	Purchase Requisition/ ASTM-STD/ P.O Technical specification	Purchase requisition/ ASTM-STD/P.O Technical specification	Testing results of TPI-approved test house	W	Sample drawing-W Test results-R	
3	Flattening test or Bend test	Mechanical properties	One sample from each lot of 100 length having same size, thickness, material & heat	Purchase Requisition/ ASTM-STD/ P.O Technical specification	Purchase requisition/ ASTM-STD/P.O Technical specification	Testing results of TPI-approved test house	W	Sample drawing-W Test results-R	
4	Hardness Test	Mechanical properties	One sample from each lot of 100 length having same size, thickness, material & heat	Purchase Requisition/ ASTM-STD/ P.O Technical specification	Purchase requisition/ ASTM-STD/P.O Technical specification	Testing results of TPI-approved test house	W	Sample drawing-W Test results-R	
5	Impact test – for LTCS and H2 Service	Mechanical properties	One sample from each lot of 100 length having same size, thickness, material & heat	Purchase Requisition/ ASTM-STD/ P.O Technical specification	Purchase requisition/ ASTM-STD/P.O Technical specification	Testing results of TPI-approved test house	W	Sample drawing-W Test results-R	
6	IGC Test – for SS only	Corrosion Properties	One sample from each lot of 100 length having same size, thickness, material & heat	Purchase Requisition/ ASTM-STD/ P.O Technical specification	Purchase requisition/ ASTM-STD/P.O Technical specification	Testing results of TPI-approved test house	W	Sample drawing-W Test results-R	

7	Inspection - for AS & SS only	PMI Check	To be carried out on every length of pipe	Purchase Requisition/ ASTM-STD/ P.O Technical specification	Purchase requisition/ ASTM-STD/P.O Technical specification	Inspection Report	W	H
8	Final Inspection	Dimensional checking & Hydrotesting	100% for each type and size	Purchase Requisition/ ASTM-STD/ P.O Technical specification	Purchase requisition/ ASTM-STD/P.O Technical specification	Inspection Report	W	H
9	TPI Clearance	Stamping Inspection release note	& 100%	---	---	Inspection Report	W	H

General Notes:

1. This is an indicative inspection and test plan for pipes. However, vendor has to develop their own inspection & test plan that will include all the above and special requirements specific to the pipes, if any, and submit the same for approval after P.O placement.
All the NDT/ Leak testing/ Heat treatment/ Special manufacturing procedures have to be specially approved or only previously approved procedures have to be used. In case of conflict between purchase specification, contract documents and QAP more stringent conditions shall be applicable. This document describes generally the requirements pertaining to all types of pipes. Requirements specific to the item are only applicable.



CHAPTER -3

TECHNICAL SPECIFICATION FOR BUTT WELDED, SOCKET WELDED AND SCREWED FITTINGS

AND

INSPECTION SCOPE

TECHNICAL NOTES FOR BUTT WELDED, SOCKET WELDED AND SCREWED FITTINGS

1.0 GENERAL

- 1.1 Chemical composition, physical properties, tests, dimensions and tolerances, heat treatment and marking shall conform to the applicable latest codes / standards / specifications as specified. For any special requirement please refer material requisition sheet.
- 1.2 The offered fittings to various ASTM standards shall also meet requirements of Metric unit system of relevant code e.g. ASTM A234 shall also meet requirements of ASTM A234M.
- 1.3 Nipples made of seamless pipes of corresponding metallurgy shall also be acceptable as alternative to forged nipples.
- 1.4 Dimensions of all Butt Weld Fittings shall be maintained per the requirements of ANSI B 16.9/ ANSI B 16.28 latest edition. Dimensions of steel BW fittings for sizes not covered in ANSI B16.9/ ANSI B16.28 shall conform to MSS-SP-48. The Butt Weld ends shall be prepared and finished in line with the requirements of ANSI B 16.25. Socket weld and threads for screwed fittings shall be in accordance with ANSI B16.11 and ANSI B1.20.1 respectively, unless otherwise specified.
- 1.5 All the Reducers, seamless as well as welded, concentric as well as eccentric, shall have knuckles and straight flanges at both the ends. Straight cone type reducers shall not be acceptable.

2.0 TESTING

- 2.1.1 Test reports shall be supplied for all mandatory tests as per the material specifications/ applicable code/ standards. Test reports shall also be furnished for any supplementary tests as specified. Material test certificates (physical properties, chemical composition & heat treatment report) shall also be furnished for fittings supplied. For alloy steel fittings Mill test certificate containing above information shall be furnished.
- 2.1.2 PMI test : Positive material identification test to be performed at vendors works on alloy steel fittings/ stainless steel and clad fittings. The extent of PMI examination will be 100%.
 - a) For welded fittings PMI shall be performed on base metal as well as weldments.
 - b) Whenever any sample drawn to PMI test on the basis of percentage selection fails to meet specification requirements, 100% of items of lot shall be tested for PMI.

- 2.2 All fittings shall be seamless in construction unless otherwise specified. If fittings are specified as welded, the same shall conform to clause 1.8. Seamless fittings are acceptable in place of welded fittings, however, welded fittings are not acceptable in place of seamless fittings.
- 2.3 Outside diameters and wall thickness (unless otherwise mentioned) of butt welded fittings shall be in accordance with ASME B36.10 and ASME B36.19 as applicable.
- 2.4 For reducing butt weld fittings having different wall thicknesses at each end, the greater wall thickness of the fitting shall be employed and inside bore at each end shall be matched with the specified inside diameter.
- 2.5 Beveled ends for all fittings shall conform to ASME B16.25. Contour of bevel shall be as follows:

Material	Wall Thickness	Weld Contour
Carbon steel (except low temperature carbon steel)	Upto 22 mm	Figure 2 Type A
	> 22 mm	Figure 3 Type A
Alloy steel, stainless steel and low temperature carbon steel	Upto 10 mm	Figure 4
	> 10 mm & upto 25 mm	Figure 5 Type A
	> 25 mm	Figure 6 Type A

2.6 Welded Fittings

- 2.6.1 All welded fittings shall be double welded. Inside weld projection shall not exceed 1.6 mm. Welds shall be ground smooth at least 25 mm from the ends.
- 2.6.2 For fittings made out of welded pipe, the welded pipe itself shall be double welded and shall be manufactured with the addition of filler metal.
- 2.6.3 Welded tees shall not be of fabricated (stub-in) type.
- 2.6.4 All welded fittings shall be normalized & all weld joints including parent material weld shall be 100% radiographed by X-ray by fittings manufacturer.
- 2.6.5 Welded pipes employed for manufacture of fittings shall be made by automatic welding only.
- 2.6.6 Specified heat treatment for carbon steel & alloy steel fittings shall be carried out again after weld repairs.
- 2.6.7 Irrespective of the material code requirement, all welded fittings indicated in specification as “Cryo” & “LT” shall meet impact test

requirements of ASME B31.3. The impact test temperature shall be (–) 196⁰C & (-) 45⁰C for stainless steel & carbon steel respectively unless specifically mentioned otherwise in the SPECIFICATION.

2.7 Welded fittings formed out of plate

- 2.7.1 The welded fittings (elbows, tees reducers) shall be manufactured in two-half construction; each half formed out of plate, followed by longitudinal weld on sides.
- 2.7.2 Steel plates used for production of welded fittings shall be normalized and ultrasonically examined as per the relevant codes/ standards.
- 2.7.3 The supplementary requirements S1 and S2 of A234/ A420 shall be fulfilled.
- 2.7.4 All welded fittings shall have maximum negative tolerance of 0.3mm.

2.8 Stainless Steel Fittings

- 2.8.1 All austenitic stainless steel fittings shall be pickled & passivated.
- 2.8.2 All stainless steel fittings shall be supplied in solution heat-treated condition.
- 2.8.3 Solution annealing for stainless steel fittings shall be carried out again after weld repairs.
- 2.8.4 For all stainless steel fittings Inter Granular Corrosion (IGC) test shall have to be conducted as per the following:

ASTM A262 Practice “B” with acceptance criteria of “60” mils/year (max.)”.

Or

ASTM A262 Practice “E” with acceptance criteria of “no cracks as observed from 20X magnification” & “microscopic structure to be observed from 250X magnification”.
- 2.8.5 When specifically asked for in specification for high temperature application of some grades of austenitic stainless steel (e.g. SS309, 310, 316, 316H etc.) ASTM A262 Practice “C” with acceptance criteria of “15 mils/year” shall have to be conducted.
- 2.8.6 For the IGC test as described in clauses as above, two sets of samples shall be drawn from each solution treatment lot, one set corresponding to the highest carbon content and other set to the highest fitting thickness. When testing is conducted as per ASTM A262 Practice “E”, photograph of microscopic structure shall be submitted for record.

- 2.9 Thickness/ schedule lower or higher than specified for the finished product shall not be accepted.

For manufacturing of elbows from pipes, same size of pipe as that of elbow shall be used and the normal wall thickness of the starting pipes shall have positive tolerance only. However, where the manufacturer has an established automatic/ semi-automatic process for the manufacturer of elbows, the starting pipe may be permitted to be of lower size with higher schedule as required. Starting pipe of higher size than that of the elbow shall not be permitted.

- 2.10 The gasket contact surfaces of stub ends shall be flat with face finish specified in the requisition. Interpretation on the specified face finish is as follows:

125 AARH : Serrations with 125 to 250 μ in AARH

- 2.11 Seamless stub ends shall not have any welds on the body. Stub ends shall be of long pattern type unless specified otherwise in the specification.
- 2.12 Galvanized fittings shall be coated with zinc by hot dip process conforming to ASTM A123 / IS4736. It is to be noted that ASTM A123 refers to ASTM 153 for galvanizing of threaded components. Hence, threaded galvanized fittings shall be coated with zinc by hot dip process conforming to ASTM A153.
- 2.13 Threaded ends shall have NPT taper threads in accordance with ASME/ ANSI B1.20.1 upto 1.5" NB & IS 554 from 2" to 6" NB.
- 2.14 Unless and otherwise specified in the specification, all socket welded and screwed fittings shall be in accordance with ASME B16.11 and ANSI B1.20.1 to the extent covered in the specification except for unions which shall be in accordance with MSS-SP-83.
- 2.15 Special fittings like nipple, elbowlet, latrolet, bosset, sweep-o-let etc. which are not covered in ASME, MSS-SP standards shall be as per manufacturer's std. Contour of these fittings shall meet the requirements of ASME B31.3. Manufacturer shall submit drawings/ catalogues of these items along with the offer.
- 2.16 All swages shall be of seamless construction.
- 2.17 Nipple length shall be 165 mm unless specified otherwise in the specification.
- 2.18 Length of all long half couplings shall be 100 mm unless otherwise specified in the SPECIFICATION.

- 2.19 All seamless & welded pipes employed for manufacturing of fittings shall be required to have undergone hydrotest. The testing of A53, A106, A333, A335, A358 and A672 shall be as per A530. A312, A268 as per A999. API5L shall be as per API5L. ASTM B series pipes e.g. B165, B167 shall be as per respective ASTM standard IS 3589, IS 1239 and others shall be as per respective IS Standards.
- 2.20 The bevel ends of all butt weld fittings shall undergo 100% MP/ DP test.
- 2.21 Abbreviations for ends of swages and nipples shall be as follows:
- | | | |
|-----|---|--------------------|
| PBE | : | Plain Both Ends |
| TBE | : | Threaded Both Ends |
| TOE | : | Threaded One End |
| TSE | : | Threaded Small End |
| TLE | : | Threaded Large End |
- 2.22 All types of SS321, SS347 or SS348 fittings shall be in stabilized heat treated condition. Stabilizing heat treatment shall be carried out subsequent to normal solution annealing. Soaking temperature and holding time for stabilizing heat treatment shall be 900⁰C and 4 hours respectively.

3.0 Hydrogen Service Fittings:

- a) All carbon steel fittings having wall thickness 9.53 mm (0.375”) and above shall be normalized. Cold drawn fittings shall be normalized after the final cold draw pass for all thicknesses. In addition, fittings made from forgings shall have Carbon–0.35% max. and Silicon–0.35% max. The normalizing heat treatment shall be a separate heating operation and not a part of the hot forming operation.
- b) All alloy steel (Cr-Mo) fittings shall be normalized and tempered. The normalizing and tempering shall be a separate heating operation and not a part of the hot forming operation. The maximum room temperature tensile strength shall be 100,000 psi.
- c) All carbon steel fittings having wall thickness 19 mm (0.75”) and above shall be post weld heat-treated.
- d) All alloy steel (Cr-Mo) fittings shall be post weld heat treated irrespective of type or thickness of weld.
- e) All austenitic stainless steel grades shall be solution annealed after welding. 100% radiography of welded joints shall be done both before and after PWHT.

- f) For carbon steel fittings, hardness of weld and HAZ shall be 200 BHN (max.) for alloy steel fittings, hardness of weld and HAZ shall be 225 BHN (max.).
- g) For all austenitic stainless steels, the weld deposit shall be checked for ferrite content. A Ferrite No. (FN) not less than 3% and not more than 10% is required to avoid sigma phase embrittlement during heat treatment. FN shall be determined by Ferritescope prior to post weld heat treatment.
- h) For all carbon steel and alloy steel fittings with wall thickness over 19 mm, Charpy-V Notch impact testing shall be carried out in accordance with paragraph UG-84 of ASME Section VIII, Div.-I for weld metal and base metal from the thickest item per heat of material and per heat treating batch. Impact test specimen shall be in complete heat treated condition and accordance with ASTM A370. Impact energies at 0⁰C shall average greater than 27J (20 ft-lb) per set of three specimens, with a minimum of 19J (15 ft-lb).
- i) If welding is used in manufacture, impact test of Heat Affected Zone (HAZ) and weld metal shall also be carried out.

3.1 For all welded alloy steel fittings with mandatory requirements of heat treatment and radiography, radiography shall be performed after heat treatment.

3.2 All 1Cr-0.5Mo & 1.25Cr-0.5Mo fittings shall be normalized and tempered. All 2.25Cr-1Mo, 5Cr-0.5Mo & 9Cr-1Mo welded fittings shall be normalized and tempered.

3.3 Fitting material as per ASTM A234 Gr.WP5/WP9, wherever specified, shall be as per Clause-1, unless otherwise specified.

3.4 Materials designated, as structural steel grades like IS 2062, SA 36 etc. or similar specification are not permitted for manufacture of fittings.

4.0 NACE CS FITTINGS

4.1 Fittings under “NACE” category shall meet the requirement of MR-01-03 and the special requirements as per purchase requisition specification.

5.0 IBR FITTINGS

5.1 Fittings under the purview of “IBR” (Indian Boiler Regulations) shall be accompanied with original IBR certificate in Form III-C duly approved and countersigned by IBR authority/ local authority/ manufacturer empowered by Central Boiler Board of India and issue inspection certificate. Photocopy of the original certificate duly attested by the

local boiler inspector where the supplier is located is the minimum requirement for acceptance.

- 5.2 For materials 1¼Cr – ½Mo (ASTM A234 Gr.WP11 & ASTM A234 Gr.WP11W) & 2¼ Cr-1Mo (ASTM A234 Gr.WP22 & ASTM A234 Gr.WP22W), where fittings are manufactured from pipe, Form III-C approved by IBR shall include the tabulation of E_t, S_c & S_r values for the entire temperature range given below. E_t, S_c & S_r values shall be such that throughout the temperature range.

$$\begin{array}{l} E_t/1.5 \\ S_r/1.5 \\ S_c \end{array} \geq \left| \begin{array}{l} \\ \\ \end{array} \right. S_A$$

- S_A : Allowable stress at the working metal temperature (as per latest addition of ASME B-31.3).
E_t : Yield point (0.2% proof stress at the working metal temperature)
S_c : The average stress to produce elongation of 1% (creep) in 100000 hrs at the working metal temperature.
S_r : The average stress to produce rupture in 100000 hrs at the working metal temperature and in no case more than 1.33 times the lowest stress to produce rupture at this temperature.

- 5.3 For carbon steel fittings described "IBR" chemical composition shall conform to the following:

Carbon (max.) : 0.25%
Others (S, P, Mn) : As prescribed in IBR regulations

The above composition is not valid for non-IBR fittings.

- 5.4 No other third party inspection is required.

6.0 INSPECTION REQUIREMENT FOR FITTINGS

- 6.1 All fittings shall be made from seamless pipes unless otherwise specified in purchase order.
- 6.2 The seamless pipes shall be verified with certificate for chemical and physical properties, hydro-test requirement (as stipulated in technical spec) issued by the manufacturer's quality control section and will be endorsed by Third Party Inspection as identification of material.
- 6.3 All fittings shall be supplied in heat-treated condition as per ASTM Standard mentioned in Purchase Order.

- 6.4 Visual inspection and dimensional checking of 100% fittings as per relevant ANSI, ASTM Standards, shall be carried out by Third Party Inspection (This includes thickness checking of 100% fittings).
- 6.5 Manufacturer shall provide the following reports as per relevant standards mentioned in the technical specifications & fittings purchase order.
- a) Chemical analysis reports.
 - b) Tensile test results.
 - c) Type of heat treatment.
 - d) Hardness Test results.
 - e) Impact test reports, radiography report, IGC test report, hydrotest (if required in the specified standard).

6.6 All fittings shall be stamped as per specified ASTM standard specified in purchase order.

7.0 SCOPE OF INSPECTION FOR THIRD PARTY INSPECTION AGENCY

7.1 This scope of inspection shall be read with item description, codes stipulated in purchase requisition, requirement of test and inspection as per this technical specification/ note.

7.2 Tests to be witnessed:

- i. Testing for physical properties for dia. 2" and above.
- ii. Visual inspection : 100%
- iii. Dimensional check : 100%
- iv. Thickness check : 100%
- v. Impact test, if applicable
- vi. IGC test, if applicable
- vii. Hydrostatic test (if specifically mentioned)

7.3 Review of documents:

- i. Mill T.C. of raw materials
- ii. Materials identification reports
- iii. Radiographs
- iv. Heat Treatment Charts
- v. Manufacturers test certificates
- vi. Chemical analysis reports
- vii. Tensile test results
- viii. Hardness test results

7.4 Third party inspection shall issue a release note on their letterhead giving correlation-marking details. The third party inspection shall contain the information on tests witnessed, documents reviewed, observations/ remarks, identifications, order status and date(s) of

inspection. All the documents along with original certificate & release note shall be furnished with supplies.

7.5 RCF reserves the right to review / inspect / witness the items at any stage of inspection.

7.6 The list of approved inspection agency is:-

- a) Engineering India Limited
- b) Lloyds Register of Shipping
- c) Project & Development India Limited
- d) RITES Limited
- e) Det Norske Veritas
- f) TUV Rhineland (I) Pvt. Ltd.
- g) TUV India Pvt.

8.0 MARKING AND DESPATCH

8.1 Each fitting shall be legibly and conspicuously stamped in accordance with MSS-SP-25 along with special condition like "IBR", "Cryo", "NACE" and "H₂" etc.

8.2 Steel die marking with round bottom punch may be permitted on body of butt weld CS and lower alloy steel fittings, but for SS & higher alloy steel fittings, the same should be marked by electro-etching only.

8.3 Paint or ink for marking shall not contain any harmful metals or metal salts such as Zinc, Lead or Copper which causes corrosive attack on heating.

8.4 Fittings shall be dry, clean and free of moisture, dirt and loose foreign materials of any kind.

8.5 Fittings shall be protected from rust, corrosion and mechanical damage during transportation, shipment and storage.

8.6 Rust preventive shall be applied. These when used on machined surfaces to be welded shall be easily removable with a petroleum solvent and the same shall not be harmful to welding.

8.7 Fittings under "IBR", "Cryo", "NACE" and "H₂" shall be painted in red, light purple, canary yellow and sea green stripes respectively for easy identification. Width of stripe shall be 25mm.

8.8 Each end of fitting shall be protected with a wood, metal or plastic cover/ sponge.

8.9 Each size of fitting shall be supplied in separate packaging marked with the purchase order number, item code number, material

specification, size and schedule/ thickness/ rating. For small quantities, fittings of different sizes may be packed in separate packings size-wise and these packings may be packed in a bigger package/ container clearly identifying the contents.

- 8.10 All alloy materials tested by PMI shall be identified using either of the following methods by indicating "PMI OK"
- a) Bar Code/ Hologram Sticker
 - b) A low stress stamp marking
 - c) Or by any other method



CHAPTER-4

**TECHNICAL SPECIFICATION FOR FLANGES,
SPECTACLE BLINDS & DRIP RINGS**

AND

INSPECTION SCOPE

TECHNICAL NOTES FOR FLANGES, SPECTACLE BLINDS AND DRIP RINGS

1.0 GENERAL

- 1.1 All items, their dimensions, tolerances, chemical composition, physical properties, heat treatment and testing etc. shall conform to the latest codes and standards specified in the requisition. For any special requirement please refer material requisition sheet.

2.0 TESTING

- 2.1.1 Test reports shall be supplied for all mandatory tests as per the relevant material specifications. Test reports shall also be furnished for any supplementary tests as specified in the requisition & clauses.
- 2.1.2 Material test certificates (physical property, chemical composition & heat treatment report) shall also be furnished for the flanges supplied.
- 2.1.3 PMI test: Positive material identification test to be performed at vendors works on alloy steel, stainless steel and clad flanges. The extent of PMI examination will be 100%.
- 2.2 Ends of weld neck flanges shall be beveled to suit the schedule/thickness of matching pipe, as specified in the requisition.
- 2.3 Bevel end details for welding neck flanges shall be as per ASME B16.25. Contour of bevel end shall be as follows:

Material	Wall Thickness	Weld Contour
Carbon steel (except low temperature carbon steel)	Upto 22 mm	Figure 2 Type A
	> 22 mm	Figure 3 Type A
Alloy steel, stainless steel and low temperature carbon steel	Upto 10 mm	Figure 4
	> 10 mm & upto 25 mm	Figure 5 Type A
	> 25 mm	Figure 6 Type A

- 2.4 Bore of socket weld flanges & reducing blind flanges shall suit the outside diameter and schedule / thickness of matching pipe.
- 2.5 Bore of slip on flanges shall suit the outside diameter of matching pipe.
- 2.6 Flange face finish shall be normally specified in the requisition as serrate finish, 125 AARH etc. The interpretation for range of face finish shall be as follows:

Stock finish : 1000 μ in AARH max.
Serrated finish/ smooth : Serrations with 125 to 250 μ in AARH
finish /125 AARH
63 AARH : 32 to 63 μ in AARH

- 2.7 Galvanized flanges shall be coated with zinc by hot dip process conforming to IS 4736 / ASTM A153.
- 2.8 Ends of screwed flanges unless otherwise specified shall have taper threads as per ASME / ANSI B1.20.1 (upto 1.5" NB) & IS 554 (for 2" to 6" NB).
- 2.9 For ring joint flanges, blinds and spacers the hardness shall be as follows:

Flange Material	Min. Hardness of Groove (BHN)
Carbon steel	140
1% Cr to 5% Cr	150
Type 304, 316, 321, 347	160
Type 304L, 316L	140

- 2.10 For ring joint flanges, blinds and spacers, the hardness shall be recorded in the test report.
- 2.11 All austenitic stainless steel flanges shall be supplied in solution annealed condition.

2.12 I.G.C. Test for Stainless Steels

- 2.12.1 For all austenitic stainless steel flanges, blinds, drip rings intergranular corrosion test shall have to be conducted as per following:

ASTM A262 Practice 'B' with acceptance criteria of "60 mils/ year (max.)".

OR

ASTM A262 Practice 'E' with acceptance criteria of "No cracks as observed from 20X magnification" & "Microscopic structure to be observed from 250X magnification.

- 2.12.2 When specifically asked for in requisition for high temperature application of some grades of austenitic stainless steel (like SS309, 310, 316, 316H etc.) ASTM A262 Practice 'C' with acceptance criteria of "15 mils/ year" shall have to be conducted. When testing is conducted as per Practice 'E', photograph of microscopic structure shall be submitted for record.
- 2.12.3 For the IGC test as described as above two sets of samples shall be drawn from each solution treatment lot; one set corresponding to highest carbon content and the other corresponding to the highest rating/ thickness.
- 2.13 All types of 321 or 347 stainless steel flanges shall be in a stabilized heat-treated condition. Stabilizing heat treatment shall be carried out subsequent to the normal solution annealing. Soaking temperature and

holding time for stabilizing heat treatment shall be 900⁰C and 4 hours respectively.

- 2.14 AWWA C207 flanges shall be hub type.
- 2.15 Dimensions for handle projection for spacers & blinds ½"-24" (150#, 300# & 600# FF) shall be as specified in Table-4 attached herewith and standard for spacers & blinds >=26" (150#, 300# & 600# FF) as specified in table 1, 2 & 3.
- 2.16 Dimensions standard for flanges shall be ASME/ ANSI B16.5 for size upto 24" (150# to 1500#) & upto 12" (2500#). For 26" and above (150# to 1500#) – ANSI B16.47 SERIES-B shall be applicable unless otherwise specified.
- 2.17 Flanges of 22" size shall be as per MSS-SP-44 unless otherwise specified.
- 2.18 Blind flanges, spacers & blinds if specified as plate material are acceptable in forging material also in the corresponding material grades.
- 2.19 All 1Cr-0.5 Moly & 1.25 Cr-0.5 Moly Flanges shall be normalized and tempered.

3.0 IBR REQUIREMENTS

3.1 IBR Documentation

- 3.1.1 Flanges coming under the purview of IBR (Indian Boiler Regulations) shall be accompanied with IBR Certificate original in Form-III C duly approved and countersigned by IBR authority / local authority empowered by Central Boiler Board of India. Photocopy of original certificate duly attested by the local boiler inspector where the supplier is located is the minimum requirement of acceptance.
- 3.1.2 For carbon steel flanges described as "IBR", chemical composition shall conform to the following:

Carbon (max.)	:	0.25%
Others (S, P, Mn)	:	As prescribed in IBR regulation

The chemical composition as indicated in this clause is not applicable for flanges other than IBR.

4.0 SPECIAL REQUIREMENT FOR HYDROGEN SERVICE

4.1 Method of Manufacture

- 4.1.1 All carbon steel flanges having wall thickness 9.53 mm and above shall be normalized. The normalizing heat treatment shall be a separate heat treatment operation and not a part of the hot forming operation.
- 4.1.2 All alloy steel (Cr-Mo) flanges shall be normalized and tempered. The normalizing and tempering shall be separate heat treatment operation and not a part of the hot forming operation.

4.2 Impact Test

- 4.2.1 For all carbon steels and alloy steels with wall thickness over 19mm, Charpy-V Notch impact testing shall be carried out in accordance with paragraph UG-84 of ASME Section VIII, Div-1 per heat of material and per heat treating batch. Impact test specimen shall be in accordance with ASTM A370. Impact energies at 0^oC shall average greater than 27J (20 ft-lb) per set of 3 specimens, with a minimum of 19J (15ft-lb).

5.0 NACE CARBON STEEL FLANGES

- 5.1 Flanges under this category shall meet the requirements given in NACE MR-0103-2007 and the special requirements as per purchase requisition specification.

6.0 INSPECTION REQUIREMENT FOR FLANGES

- 6.1 All raw materials shall be verified with certificate for chemical and physical properties issued by the manufacturer's quality control section and will be endorsed by Third Party Inspector as identification of material.
- 6.2 All flanges shall be supplied in heat-treated condition as per ASTM standard mentioned in technical specifications.
- 6.3 Visual inspection and dimensional checking of 100% flanges as per relevant ANSI, ASTM standards by Third Party Inspection Agency.
- 6.4 The manufacturer shall provide the following reports as per ASTM specification mentioned in enquiry/ Purchase Order. All reports to be endorsed by Third Party Inspection Agency.
 - a. Chemical analysis reports.
 - b. Tensile test results.
 - c. Heat treatment.
 - d. Hardness test results
 - e. Impact test report
 - f. IGC test report

6.5 All flanges shall be stamped as per relevant ASTM/ ANSI/ API standards.

7.0 SCOPE OF INSPECTION FOR THIRD PARTY INSPECTION AGENCY

7.1 The scope of inspection shall be read with item description, codes stipulated in the purchase requisition, requirement of test and inspection as per this specification.

7.2 Witness of:

- i. Tests for physical properties of materials.
- ii. Visual inspection : 100%
- iii. Dimensional check : 100%
- iv. PMI for SS / AS / Cladded only 100%

7.3 Review of:

- i. Mill certificates for identification of raw materials.
- ii. Heat Treatment Charts.
- iii. Manufacturers Test Certificates (to be endorsed).
- iv. Special test such as impact / IGC etc.

7.4 Third party inspection shall issue a release note on their letterhead giving correlation-marking details. The note shall contain the information on tests witnessed, documents reviewed, observations/ remarks, identifications, order status and date(s) of inspection. All the documents along with original certificate & release note shall be furnished with supplies also the released note shall mention compliance to special requirement such as hydrogen service/ NACE etc.

7.5 Third party inspection is also required for IBR flanges, spectacle blinds & drip rings which will be prior to IBR inspection, the TPI will verify the documents and dimensional check-up.

7.6 RCF reserves the right to review / inspect / witness the items at any stage of inspection.

7.7 The list of approved inspection agency is:-

- a) Engineering India Limited
- b) Lloyds Register of Shipping
- c) Project & Development India Limited
- d) RITES Limited
- e) Det Norske Veritas
- f) TUV Rhineland (I) Pvt. Ltd.
- g) TUV India Pvt.

8.0 MARKING AND DESPATCH

- 8.1 All items shall be legibly and conspicuously stamped in accordance with the requirements of applicable ASME, API and MSS Standards. In addition, EIL item code, purchase order number & special conditions like "IBR", "CRYO", "NACE", "H2" etc. shall also be stamped.
- 8.2 All items coming under the purview of "IBR", "CRYO", "NACE", "H2" (Hydrogen) shall be painted in red stripes, light purple stripes, canary yellow stripes & sea green stripes (25mm width) respectively for easy identification.
- 8.3 Paint or ink for marking shall not contain any harmful metal or metal salts such as zinc, lead or copper which cause corrosive attack on heating.
- 8.4 All items shall be dry, clean and free from moisture, dirt and loose foreign materials of any kind.
- 8.5 All items shall be protected from rust, corrosion and mechanical damage during transportation, shipment and storage.
- 8.6 Rust preventive on machined surfaces to be welded shall be easily removable with a petroleum solvent and the same shall not be harmful to welding.
- 8.7 Each end of flange shall be protected with the following materials:
- | | | |
|--------------------|---|--------------------------------------|
| Flange face | : | Wood, metal or plastic cover/ sponge |
| Beveled end | : | Wood, metal or plastic cover/ sponge |
| Threaded end | : | Plastic plug/ sponge |
| Socket welding end | : | plastic cover or plug/ sponge |
- 8.8 Each size of flanges, blinds etc. shall be supplied in separate packagings marked with the purchase order number, item code number, material specification, size and rating.
- 8.9 All alloy materials tested by PMI shall be identified using either of the following methods by indicating "PMI OK".
- Bar Code/ Hologram Sticker
 - A low stress stamp marking
 - Any other method



CHAPTER-5

TECHNICAL SPECIFICATION FOR GASKETS

AND

INSPECTION TEST PLAN

1.0 GENERAL

- 1.1 All gaskets shall conform to the latest codes / standards and specifications given in the technical specification and enquiry.
- 1.2 Process of manufacture, dimensions and tolerances not specified in requisition shall be in accordance with the requirements of the manufacturer's standards.
- 1.3 Testing
 - 1.3.1 Test reports shall be supplied for all mandatory tests for gaskets as per the standards specified in the technical specification and enquiry.
 - 1.3.2 Chemical composition and hardness of RTJ gaskets shall also be furnished in the form of test reports on samples.
 - 1.3.3 For Spiral wound material following shall be furnished:
 - a) Manufacturer's test certificate for filler material and spiral material as per the relevant material specifications.
 - b) Manufacturer's test certificate for raw materials and tests for compressibility/ seal-ability & recovery as per the relevant material specifications.
 - 1.3.4 Refer 'Inspection & Test Plan for Gaskets'.
- 1.4 Full face gaskets shall have bolt holes punched out.
- 1.5 Filler material for spiral wound gaskets shall not have any colour or dye. Expanded flexible graphite should be used in place of asbestos and asbestos filling is to be avoided.
- 1.6 All spiral wound gaskets shall be supplied with Outer ring. Material of the outer ring shall be CS unless otherwise specified in the technical specification and enquiry.
- 1.7 For spiral wound gaskets, material of Inner Compression ring shall be same as Spiral Strip material. In addition to the requirements as per code, inner rings shall be provided for the following:
 - a) Sizes 26" and above.
 - b) Class 900 and above.
- 1.8 Hardness of metallic RTJ gaskets shall not exceed the values specified below unless otherwise specified in MR:

Ring Gasket Material	Maximum Hardness (BHN)
Soft Iron	90
Carbon Steel	120
5Cr. ½Mo	130
Type 304, 316, 321, 347	140
Type 304L, 316L	120
Inconel	160

- 1.9 Face finish of metallic RTJ gaskets shall be 32 to 63 AARH.
- 1.10 Gaskets of different types and sizes shall be placed in separate shipping containers and each container clearly marked with the size, rating, material specification and item code.
- 1.11 All items shall be inspected and approved by RCF approved third party inspection agency.
- 1.12 Any additional requirements specified in the requisition, shall be fully complied with.
- 1.13 Non-metallic ring gaskets as per ASME B16.21 shall match flanges to ASME B16.5 upto 24" (except 22" size) and to ASME B16.47B above 24" unless specified otherwise. For 22" size, the matching flange standard shall be MSS-SP44 unless specified otherwise.
- 1.14 Spiral wound gasket as per ASME B16.20 shall match flanges to ASME B16.5 upto 24"(except 22"size) and to ASME B16.47B above 24" unless specifically mentioned otherwise. For 22" size, the matching flange standard shall be MSS-SP44 unless specified otherwise.
- 1.15 The following abbreviations have been used in the specification:
- (I) :Inner Ring
(O) :Outer Ring
CAF : Compressed Asbestos Fibre
GRAFIL : Grafoil Filler

2.0 Third party inspection shall be carried out from RCF approved TPIs only.

2.1 RCF reserves the right to review / inspect / witness the items at any stage of inspection.

2.2.1 The list of approved inspection agency is:-

- a) Engineering India Limited
- b) Lloyds Register of Shipping
- c) Project & Development India Limited
- d) RITES Limited
- e) Det Norske Veritas
- f) TUV Rhineland (I) Pvt. Ltd.
- g) TUV India Pvt.

INSPECTION AND TEST PLAN

FOR

GASKETS

Sl. No.	Stage	Component	Characteristics	Method of Check	Quantum of Check	Reference Documents	Acceptance Norms	Record	Sub-vendor	Vendor	TPIA	
1.0	CAF Gaskets											
1.1	Raw material inspection	CAF material	Physical	Visual dimensional, TC verification	100%	IS 2712 Gr. W/1	IS 2712 Gr. W/1	Manufacturer's TC	W	R	-	
1.2	In process inspection (punching & finishing)	CAF material	Identification, verification	Visual dimensional	As per internal QA plan	ANSI B16.21, PO, material specification	ANSI B16.21, PO, material specification	Inspection report	-	W	-	
1.3	Final inspection	Gasket	Identification, verification	Visual dimensional	100% by vendor at random by TPIA	ANSI B16.21, PO, material specification	ANSI B16.21, PO, material specification	Inspection report	-	W	R	
2.0	Spiral Wound											
2.1	Raw material inspection (review of mfr's certificate and check test)	Metallic spiral winding material, centering ring, inner ring	Chemical, visual dimensional	Lab check visual	100% of lots	Applicable material specification	Applicable material specification	Manufacturer's TC	-	W&R	-	
2.2	Raw material inspection (review of mfr's certificate and check test)	Non-metallic filler material	Physical	Visual, dimensional, TC verification	100%	Applicable material specification	Applicable material specification	Manufacturer's TC	-	W&R	-	
2.3	Raw material inspection	Spiral wound	Compression & recovery test	Test jig	Lots of every size/ rating	ANSI B16.20, PO, material specification	ANSI B16.20, PO, material specification	Inspection report	-	W	H	

Sl. No.	Stage	Component	Characteristics	Method of Check	Quantum of Check	Reference Documents	Acceptance Norms	Record	Sub-vendor	Vendor	TPIA
2.4	Final inspection	Gasket	Identification verification	Visual dimension, marking	100% by vendor, at random by TPIA	ANSI B16.21, PO, material specification	ANSI B16.21, PO, material specification	Inspection report	-	W	R
3.0	RTJ Gasket										
3.1	Raw material inspection (Document review)	Seam less ring gasket material	Properties	Chemical, dimension, visual, hardness	100%	ANSI B16.20, PO, material specification	ANSI B16.20, PO, material specification	TC Inspection report	W	R	R
3.2	Raw material inspection (Check test)	Ring gasket material	Properties	Dimension, visual, hardness	At random	ANSI B16.20, PO, material specification	ANSI B16.20, PO, material specification	Inspection report	-	W	-
3.3	Final inspection	Gasket	Identification, verification	Dimension, visual, hardness	At random	ANSI B16.20, PO, material specification	Material specification	TC Inspection report	-	W	H
3.4	Final inspection (Non CS)	Gasket	PMI check	X-Ray Fluorescence/ Emission Spectrometer	100% by vendor and 10% by TPIA			Inspection report	-	W	H
4.0	Jacketed Gasket										
4.1	Raw material inspection	Metal jacket	Properties	Chemical, dimension, thickness, visual	As per sampling plan	IS 513	IS 513	TC Inspection report	-	W	-
4.2	Raw material inspection	Filler	Properties	Dimension, visual, hardness	At random	ANSI B16.20, PO, material specification	ANSI B16.20, PO, material specification	Inspection report	-	W	-

Sl. No.	Stage	Component	Characteristics	Method of Check	Quantum of Check	Reference Documents	Acceptance Norms	Record	Sub-vendor	Vendor	TPIA
4.3	Final inspection	Gasket	Identification, verification	Dimension, visual, hardness	At random	ANSI B16.20, PO, material specification	ANSI B16.20, PO, material specification	TC Inspection report	-	W	H
4.4	Final Inspection (Non CS)	Gasket	PMI check	X-Ray Fluorescence/ Emission Spectrometer	100% by vendor and 10% by TPIA		Material specification	Inspection report	-	W	H

Legends: H – Hold (Offer for witness & obtain clearance), W – Witness, R – Review, A – Approval, I – Information, X – Submit, PO – Purchase Order.



CHAPTER – 6

TECHNICAL SPECIFICATION FOR BOLTS & NUTS

AND

INSPECTION & TEST PLAN

1.0 GENERAL

1.1 The process of manufacture, heat treatment, chemical & mechanical requirements and marking for all stud bolts, m/c bolts, jack screws & nuts shall be in accordance with the codes/ standards and specifications given in the requisition.

1.2 Testing

1.2.1 Test reports shall be supplied for all mandatory tests as per the relevant material specifications.

1.2.2 Material test certificate shall also be furnished. (Heat Analysis, Product Analysis and Mechanical Requirement)

1.2.3 Stress Rupture Test as detailed in ASTM A453 shall be carried out for all ASTM A453 bolting material irrespective of the temperature.

1.3 All bolting shall be as per ANSI B 18.2.1 for studs, M/c bolts and jackscrews and ANSI B18.2.2 for nuts.

1.4 Threads shall be unified (UNC for 1" dia. and UN for > 1" dia.) as per ANSI B.1 .I with class 2A fit for studs, M/c bolts and jackscrews and class 2B fit for nuts.

1.5 Stud bolts shall be threaded full length with two heavy hexagonal nuts. Length tolerance shall be in accordance with the requirement of latest ANSI B 16.5.

1.6 The nuts shall be double chamfered, semi-finished, heavy hexagonal type and shall be made by the hot forged process and stamped as per respective material specification.

1.7 Heads of jackscrews and m/c bolts shall be heavy hexagonal type. Jackscrew end shall be rounded.

1.8 Each size of studs & m/c bolts with nuts and jackscrews shall be supplied in separate containers marked with size and material specifications. 'CRYO' shall be marked additionally in case 'CRYO' is specified in the requisition.

1.9 The heat treatment for stud bolts & nuts shall be as per code unless mentioned otherwise.

1.10 All austenitic stainless steel bolts, nuts, screws shall be supplied in solution annealed condition unless specified otherwise in the material specification.

1.11 Any additional or special requirements specified in the requisition shall be fully complied with.

- 1.12 Stud bolts, nuts & jackscrews shall be impact tested wherever specified in the material specification and also where the material specification is indicated as "CRYO". For S.S. nuts and bolts minimum impact energy absorption shall be 27 Joules and test temperature shall be -196°C unless mentioned otherwise. For other materials impact energy and test shall be as per respective code.
- 1.13 Bolts/ nuts of material of construction B7M/2HM shall be 100% Hardness tested as per supplementary requirement S3 of ASTM A 193.
- 1.14 When specified as galvanized, the studs, M/C bolts and nuts shall be 'hot dip zinc coated' in accordance with requirements of 'class C' of 'ASTM A 153'. As an alternative, electro-galvanizing as per IS 1573, 'Service Grade Number 2' is also acceptable.
- 1.15 All Stud Bolts of Bolt diameter size 1" and above shall be provided with three nuts irrespective of whatever has been specified elsewhere in the MR.
- 1.16 PMI - Positive Material Identification test is to be performed at vendor works on SS & alloy steel materials. The extent of PMI examination as follows:

Lot Size	Sample Size
Upto 100	2% (minimum 2)
101 to 500	1% (minimum 3)
501 & above	0.5% (minimum 5)

Whenever, any sample drawn to PMI test on the basis of percentage selection & fails to meet specification requirements, 100% of items of lot shall be tested for PMI.

- 1.17 Magnetic particle test shall be carried out for ferritic materials as per supplementary requirement S7 of ASTM A193.

2.0 MARKING & DESPATCH

- 2.1 All nuts & bolts shall be marked in accordance with the applicable codes, standards & specifications.
- 2.2 All nuts & bolts shall be dry, clean and free from moisture, dirt, and loose foreign materials of any kind.
- 2.3 All nuts & bolts shall be protected from rust & corrosion.
- 2.4 Rust preventive shall be applied.

2.5 All alloy materials tested by PMI shall be identified using either of the following methods by indicating "PMI OK"

- a) Bar Code/ Hologram Sticker
- b) A low stress stamp marking
- c) Any other method

INSPECTION & TEST PLAN FOR BOLTING MATERIAL

Reference Documents

PO/ PR/ Standards referred there in/ job specifications/ approved documents.

Sl. No.	Stage/ Activity	Characteristics	Quantum of Check	Record	Scope of Inspection		TPIA
					Sub-supplier	Supplier	
1a	Raw material inspection	Marking and correlation with TC	100%	TC, Inspection report	-	W	R
1b	Raw material inspection (check test)	Chemical composition	One sample per heat	Inspection report	W	R	-
1c	Raw material inspection	Internal soundness	One sample per heat	Inspection report	W	R	-
1d	Raw material inspection	Spectro analysis	100%	Inspection report	-	W	R
2	Thread rolling, hot forging of nuts, machining	Process controls	As per internal QA plan	Inspection report	-	W	-
3	Heat treatment, if applicable	HT cycle (time & temperature)	100%	Inspection report	-	W	R
4	Selection of samples	Test piece marking	Heat of material/ heat treatment charge/ size	Inspection report	-	W	H
5	Non Destructive Testing (if applicable)	Surface & internal imperfections	100% by Supplier, at random by TPIA	Inspection report	-	W	H
6	Destructive testing	Mechanical properties	Each HT lot/ each heat no/ size	Lab report	-	W	H
7	Galvanizing (if applicable)	Thickness, embrittlement,	As listed in A153	Inspection/ lab report	-	W	R

Sl. No.	Stage/ Activity	Characteristics	Quantum of Check	Record	Scope of Inspection		
					Sub-supplier	Supplier	TPIA
8	Final inspection	adherence, finish & appearance Visual marking, colour coding, dimensions	100% by Supplier, at random by TPIA	Inspection report	-	W	H
9	Final inspection	PMI check	As per clause 1.16	PMI report	-	W	H

Legend:

CCE or CCOE – Chief Controller of Explosives, DT – Destructive Testing, HT – Heat treatment, H – Hold (Do not proceed without approval), IBR – Indian Boiler Regulations, ITP – Inspection and Test Plan, M – Monitor, NDT – Non Destructive Testing, P – Perform, PO – Purchase Order, PR – Purchase Requisition, PQR – Procedure Qualification Record, QAP – Quality Assurance Plan, Random – 10% (min.1 no.) of each size and type of bulk item, R – Review, RT – Radiography Testing, RW – Random Witness, TC – Test Certificate, TPI or TPIA – Third Party Inspection Agency, VDR – Vendor Data Requirements, WPS – Welding Procedure Specification, WPQ – Welders Performance Qualification, W – Witness (Give due notice, work may proceed after scheduled date).

NOTES (As applicable):

1. This document describes generally the requirements pertaining to all types of the item. Requirements specific to PO and the item are only applicable.



CHAPTER -7

TECHNICAL SPECIFICATION FOR VALVE MANIFOLDS

AND

INSPECTION SCOPE

TECHNICAL NOTES

1.0 GENERAL

- 1.1 Chemical composition, physical properties, tests, dimensions and tolerances, heat treatment and marking shall conform to the applicable latest codes / standards / specifications as specified. For any special requirement please refer material requisition sheet.
- 1.2 Supply of SS316 Make 2 Valve Manifold as specified in tender documents.
- 1.3 The threaded ends of shall be NPT as per ANSI B1.20.1.

2.0 INSPECTION REQUIREMENT FOR MANIFOLDS

- 2.1 All manifolds shall be supplied in heat-treated condition as per ASTM Standard mentioned in Purchase Order.
- 2.2 Visual inspection and dimensional checking of 100% fittings as per relevant ANSI, ASTM Standards, shall be carried out by Third Party Inspection (This includes thickness checking of 100% fittings).
- 2.3 Manufacturer shall provide the following reports as per relevant standards mentioned in the technical specifications & fittings purchase order.
 - a) Chemical analysis reports.
 - b) Tensile test results.
 - c) Type of heat treatment.
 - d) Hardness Test results.
 - e) Impact test reports, radiography report, IGC test report, hydrotest (if required in the specified standard).

3.0 SCOPE OF INSPECTION FOR THIRD PARTY INSPECTION AGENCY

3.1 This scope of inspection shall be read with item description, codes stipulated in purchase requisition, requirement of test and inspection as per this technical specification/ note.

3.2 Tests to be witnessed:

- i. Testing for physical properties for dia. 2" and above.
- ii. Visual inspection : 100%
- iii. Dimensional check : 100%
- iv. Thickness check : 100%
- v. Impact test, if applicable
- vi. IGC test, if applicable
- vii. Hydrostatic test (if specifically mentioned)

3.3 Review of documents:

- i. Mill T.C. of raw materials
- ii. Materials identification reports
- iii. Radiographs
- iv. Heat Treatment Charts
- v. Manufacturers test certificates
- vi. Chemical analysis reports
- vii. Tensile test results
- viii. Hardness test results

3.4 Third party inspection shall issue a release note on their letterhead giving correlation-marking details. The third party inspection shall contain the information on tests witnessed, documents reviewed, observations/ remarks, identifications, order status and date(s) of

inspection. All the documents along with original certificate & release note shall be furnished with supplies.

3.5 RCF reserves the right to review / inspect / witness the items at any stage of inspection.

3.6 The list of approved inspection agency is:-

- a) Engineering India Limited**
- b) Lloyds Register of Shipping**
- c) Project & Development India Limited**
- d) RITES Limited**
- e) Det Norske Veritas**
- f) TUV Rhineland (I) Pvt. Ltd.**
- g) TUV India Pvt. Ltd**

3.7 Vendors for Manifolds

- (a) SWAGELOK
- (b) PARKER
- (c) FLUID CONTROLS PVT. LTD.



PROJECTS & DEVELOPMENT INDIA LIMITED

ES : 6006

SHEET 1 OF 6

ENGINEERING STANDARD

PRESSURE TESTING OF PIPING

FORM NUMBER 02-0000-0021 F1 REV 0

This document is the property of Projects & Development India Limited (PDIL) and not to be copied or reproduced or shown to third parties without the written permission of PDIL.

REV.	DATE	PURPOSE	PREPARED	REVIEWED	APPROVED
2	26/04/2000	PARA 7.0 ADDED & OTHER REVISIONS			
1	28/09/1999	FOR IMPLEMENTATION	ENGG.COMM.		
0	FEB.'98	FOR IMPLEMENTATION	MKD. APP.		

1.0 SCOPE

All installed piping after completion of the applicable examinations, but prior to initial operation shall be pressure tested to ensure tightness in accordance with the requirements of this specification. However, piping built, in conformance with the ASME Boiler & PV code or Indian Boiler Regulation shall be pressure tested in compliance of such code or regulations.

Piping systems open to atmosphere, such as drains, vents, outlet piping for relief valves discharging to atmosphere and underground sewers shall not require any pressure testing. These lines shall be examined visually to determine that all joints are properly made up.

2.0 GENERAL REQUIREMENTS FOR LEAK/ PRESSURE TESTS

Following requirements apply to both hydraulic as well as pneumatic leak/pressure tests.

2.1 Limitations on Pressure

(a) *Stress Exceeding Yield Strength*

If the test pressure would produce a nominal pressure stress or longitudinal stress in excess of yield strength at test temperature, the test pressure may be reduced to the maximum pressure that will not exceed the yield strength at test temperature.

(b) *Test Fluid Expansion*

If a pressure test is to be maintained for a period of time and the test fluid in the system is subject to thermal expansion, precautions shall be taken to avoid excessive pressure.

(c) *Preliminary Pneumatic Test*

A preliminary test using air at no more than 170 kPa (25 psi) gauge pressure may be made prior to hydrostatic testing to locate major leaks.

2.2 Other Test Requirements

(a) *Examination for Leaks*

Test pressure during leak/pressure test shall be maintained for at least 10 min. and all joints and connections shall be examined for leaks.

(b) *Heat Treatment*

Leak tests shall be conducted after any heat treatment has been completed.

(c) *Low Test Temperature*

The possibility of brittle fracture shall be considered when conducting leak tests at metal temperatures near the ductile-brittle transition temperature.

2.3 **Special Provisions for Testing**

(d) *Piping Subassemblies*

Piping subassemblies may be tested either separately or as assembled piping.

(e) *Flanged Joints*

A flanged joint at which a blank is inserted to isolate other equipment during a test need not be tested.

(f) *Closure Welds*

The final weld connecting piping systems or components which have been successfully tested in accordance with this engineering standard need not be leak tested provided the weld is examined in process in accordance with para 344.7 of ASME B 31.3 (para 6.7 of ES:6005) and passes with 100% radiographic examination in accordance with para 344.5 of ASME B 31.3 (Para 6.5 of ES 6005) or 100% ultrasonic examination in accordance with para 344.6 of ASME B 31.3 (Para 6.6 of ES 6005).

2.4 **Externally Pressured Piping**

Piping subject to external pressure shall be tested at an internal gauge pressure 1.5 times the external differential pressure, but not less than 105 kPa (15 psi).

2.5 **Jacketed Piping**

(a) The internal line shall be leak tested on the basis of the internal or external design pressure, whichever is critical. This test must be performed before the jacket is completed if it is necessary to provide visual access to joints of the internal line.

(b) The jacket shall be leak tested on the basis of the jacket design pressure unless otherwise specified in the engineering design.

3.0 **PREPARATION FOR LEAK/PRESSURE TEST**

3.1 All joints, including welds and bends, shall be left uninsulated & exposed for examination during leak testing, except that joints previously tested may be insulated or covered. All joints may be primed and painted only after leak testing.

3.2 Major equipment, such as compressors, pumps, vessels and exchangers shall be isolated from pipe line during hydrostatic test. When necessary for practicability, exchangers and vessels may be included with the connected piping provided the piping test pressure is within the allowable cold pressure limits of the equipment.

3.3 All air present in the system to be tested shall be vented while admitting the test fluid.

All vent valves during filling up as well as during draining must be fully open.

- 3.4 Piping designed for vapour and gas shall be provided with additional temporary supports if necessary, to support the weight of test fluid.
- 3.5 Instruments, expansion joints, filters etc., for which the maximum permissible cold test pressures are lower than the specified hydrostatic test pressure for piping, shall be isolated and excluded from the test.
- 3.6 Lines containing check valves shall have source of test pressure on the up-stream side.
- 3.7 Valves shall not be subjected to a test pressure in excess of manufactures allowable test rating. When permitted, the installed valves shall be kept open.
- 3.8 Relief valves shall be excluded from the test and shall be suitably blanked off.

Orifice plates in horizontal lines shall not be installed till completion of test.

Control valves shall not be field tested. All flanged control valves shall be removed before hydraulic testing of the pipe lines. Welded end control valves shall be welded after hydraulic test, cleaning and blowing.

Indicating pressure gauges mounted locally may be tested with the lines provided the test pressure is not in excess of their scale ratings.

- 3.9 Instrument take-off piping up to the first block valve shall be tested with piping to which it is connected. Testing of remainder of lead line upto instrument can also be done at the same time provided instruments are blocked off from source of pressure and vented to atmosphere.
- 3.10 The test shall be carried out at ambient temperature and the water temperature shall not be less than 7°C.

4.0 **HYDROSTATIC LEAK/ PRESSURE TEST**

4.1 **Test Fluid**

The fluid shall be water unless there is the possibility of damage due to freezing or to adverse effects of water on the piping or the process. In that case another suitable nontoxic liquid may be used. If the liquid is flammable, its flash point shall be at least 49°C and consideration shall be given to the test environment.

4.2 **Test Pressure**

Except as provided in para 4.3, the hydrostatic test pressure at any point in a metallic piping system shall be as follows:

- (a) Not less than 1½ times the design pressure ;
- (b) For design temperature above the test temperature, the minimum test pressure shall be calculated by following equation except that the value of S_T / S shall not exceed 6.5 ;

$$P_T = \frac{1.5PS_T}{S}$$

Where

P_T = minimum test gauge pressure
 P = internal design gauge pressure
 S_T = stress value at test temperature
 S = stress value at design temperature

- (c) If the test pressure as defined above would produce a stress in excess of the yield strength at test temperature, the test pressure may be reduced to the maximum pressure that will not exceed the yield strength at test temperature.

4.3 Hydrostatic Test of Piping With Vessels as a System

- (a) Where the test pressure of piping attached to a vessel is the same as or less than the test pressure for the vessel, the piping may be tested with the vessel at the piping test pressure.
- (b) Where the test pressure of the piping exceeds the vessel test pressure, and it is not considered practicable to isolate the piping from the vessel, the piping and the vessel may be tested together at the vessel test pressure, provided the owner approves and the vessel test pressure is not less than 77% of the piping test pressure calculated in accordance with para 4.2(b).

4.4 Lines at Atmospheric Pressure

All liquid lines at atmospheric pressure ($\leq 1 \text{ Kg./cm}^2\text{g}$) shall be tested hydrostatically at $2 \text{ Kg/cm}^2\text{g}$.

5.0 PNEUMATIC LEAK/ PRESSURE TEST

Piping may be tested pneumatically if these cannot be safely filled with water or where traces of water cannot be tolerated or if these have been previously tested hydrostatically.

5.1 Precautions

Pneumatic testing involves the hazard of released energy stored in compressed gas. Particular care must therefore be taken to minimize the chance of brittle failure during a pneumatic leak test. Test temperature is important in this regard and must be considered when the designer chooses the material of construction.

5.2 Pressure Relief Device

A pressure relief device shall be provided, having a set pressure not higher than the test pressure plus the lesser of 345 kPa (50 psi) or 10% of the test pressure.

5.3 Test Fluid

The gas used as test fluid, if not air, shall be nonflammable and nontoxic.

5.4 Test Pressure

The test pressure shall be 110% of design pressure.

5.5 Procedure

5.6 The pressure shall be gradually increased until a gage pressure which is the lesser of one-half the test pressure or 170 kPa (25 psi) is attained, at which time a preliminary check shall be made, including visual examination of joints. Thereafter, the pressure shall be gradually increased in steps until the test pressure is reached, holding the pressure at each step long enough to equalize piping strains. The pressure shall then be reduced to the design pressure before examining for leakage in accordance with para 2.2.

5.7 Lines at Atmospheric Pressure

All gas lines at atmospheric pressure ($\leq 1 \text{ Kg/cm}^2\text{g}$) shall be tested pneumatically at $0.5 \text{ Kg.cm}^2\text{g}$.

6.0 VACUUM SERVICES

Lines in vacuum services shall be hydrostatically tested at a minimum internal pressure of $1.5 \text{ Kg/cm}^2\text{g}$ unless limited to a lower value by design. Where it is not possible to test hydrostatically, the pipe lines shall be tested pneumatically at $1 \text{ Kg/cm}^2\text{g}$.

7.0 SENSITIVE LEAK TEST

The test shall be in accordance with the Gas and Bubble Test method specified in the BPV Code, Section V, Article 10, or by another method demonstrated to have equal sensitivity. Sensitivity of the test shall be not less than $10^{-3} \text{ atm.ml/sec}$ under test conditions.

- a) The test pressure shall be at least the lesser of 105 kPa (15 psi) gage, or 25% or the design pressure.
- b) The pressure shall be gradually increased until a gage pressure the lesser of one-half the test pressure or 170 kPa (25 pai) is attained, at which time a preliminary check shall be made. Then the pressure shall be gradually increased in steps until the test pressure is reached, the pressure being held long enough at each step to equalize piping strains.



8.0 REPAIRS OR ADDITIONS AFTER LEAK TESTING

If repairs or additions are made following the leak test, the affected piping shall be retested, except that for minor repairs or additions the owner may waive retest requirements when precautionary measures are taken to assure sound construction.

9.0 TEST RECORDS

Records shall be made of each piping system during the testing, including :

- a) Date of Test
- b) Identification of the piping tested.
- c) Test Method
- d) Test Pressure and duration
- e) Certification of results by examiner *
- f) Approval by the Inspector

	FRP CABLE TRAY INSTRUMENTATION WORKS	Doc No	CABLE TRAY SPEC	
		Date	18.10.2022	
		Rev	0	

TECHNICAL SPECIFICATION CABLE TRAY

P	18.10.2022	ISSUED FOR CLIENT'S COMMENTS	SG	HS	SKT
Rev	Date	Purpose	Prepd	Rewd	Apprd





	FRP CABLE TRAY INSTRUMENTATION WORKS	Doc No	CABLE TRAY SPEC	
		Date	18.10.2022	
		Rev	0	

TABLE OF CONTENT

1. Introduction
2. Scope
3. Area Classification
4. Technical Specification Cable Trays with cover

	FRP CABLE TRAY INSTRUMENTATION WORKS	Doc No	CABLE TRAY SPEC	
		Date	18.10.2022	
		Rev	0	

1. SCOPE

Vendor shall supply the Tray & Accessories, as per the details mentioned below and as specified. This shall not absolve or limit the vendor's responsibility and Vendor shall be responsible for the correctness of the design, selection of model, material of construction and Cable Ducts, Tray & Accessories as per given process, design, functional and other requirements.

2. CODE & STANDARDS

Design, materials, manufacturing, examination, inspection, testing and documentation shall conform to the latest editions of codes & standards as mentioned below. Wherever edition is not mentioned, latest edition prior to the date of this enquiry shall be followed.

IS-1239	Specification for Free cutting brass bars, rods and sections
IS-5	Colours for ready mixed paints and enamels
IS-2074	Ready Mixed paints, air-drying, red oxide-zinc chrome
IS-2148	Flame proof enclosures for electrical apparatus for Explosive Gas Atmospheres – Flameproof Enclosures'd'.
IS-14927 (PART 1)	cable trunking and ducting systems for electrical installation
OSHA	Occupational Safety & Health Authority

3. CABLE TRAYS

The cable trays shall be Perforated FRP cable trays with its cover, SS mounting accessories . Cable tray couplers shall be provided for joining of cable trays. The couplers shall be of same material as cable tray. Perforated cable trays shall be fabricated out of minimum 4.0 mm thick of FRP All cable trays shall be provided with top covers wherever specified in SECTION-A. Cable Trays shall be suitable for a cable weight of 75 kg/m of running length of tray and generally shall be supported at every 2 meter intervals. In addition, trays shall be suitable for point load of 75 kg. (Equivalent to weight of a man working on the cable tray. All structural design shall be as per Indian Standards.)The side runner channel and all accessories shall have four holes on each end for fixing splice plates. Two splice plates (one on inside face and one on outside face) shall be provided for each side runner. The side runner shall also have suitable holes at every meter for clearing earthing strip. Suitable threaded holes shall be provided on the runner top and bottom for supporting and fixing tray covers at every meter. Hot dip galvanizing shall be done after fabrication as per the relevant IS specifications. The amount of galvanizing shall be 610 g/m².

The construction shall facilitate easy handling, assembly & installation at site. The cable tray standard length shall be 2.5 meter for ladder type cable trays & 2.5 meter for perforated cable trays. Any Burrs, sharp edges shall be removed before dispatch by vendor. The hardware shall conform to relevant IS specifications and shall be able to withstand maximum loading conditions as required. All hardware fittings shall be chromium or cadmium plated or Zinc passivated. The nuts, bolts and washer for cable trays assembly shall be supplied along with the cable trays and couplers. Straight portion of trays shall be pre-fabricated. However sections like Tees, bends, reducers etc. may be site fabricated as per actual site conditions.

Vendor shall submit the drawings for each type of cable tray and coupler.



**GENERAL SPECIFICATION
FOR
CABLE TRAY**

00	02.02.04		ISSUE FOR RFQ	SKS	AC	RDR
REV	REV DATE	EFF DATE	PURPOSE	PREPD	REVWD	APPD

	GENERAL SPECIFICATION FOR CABLE TRAY		
		DOCUMENT NO	REV
		SHEET 2 OF 5	

CONTENTS

SECTION NUMBER	DESCRIPTION	SHEET NUMBER
1.00	GENERAL	3
2.00	GENERAL REQUIREMENTS	3
3.00	INSPECTION, FACTORY TESTS AND APPROVAL	3
4.00	PACKAGING	4
5.00	IDENTIFICATION & MARKING	4
6.00	SPARES	4
7.00	DOCUMENTATION	5

	GENERAL SPECIFICATION FOR CABLE TRAY		
		DOCUMENT NO	REV
		SHEET 3 OF 5	

1.00 GENERAL

- 1.01 This general specification together with the Technical specification attached herewith defines the technical requirement for the supply of cable tray, marking, documentation, testing-inspection and packaging.
- 1.02 In the event of any conflict between general specification and Instrument specification the later shall prevail.
- 1.03 DELETED

2.00 GENERAL REQUIREMENTS

- 2.01 The material of construction for cable tray shall be Aluminium
- 2.02 The tray shall be box type with webs for top cover screwing and of 2.5 meter length.
- 2.03 Tolerance units shall be
Length : ± 5 mm
Width : ± 2 mm
Height : ± 1 mm
Bend : ± 1 mm
Thickness : ± 0.2 mm
Positive tolerance upto + 5% is acceptable for total quantity. Negative tolerance is not acceptable.
- 2.04 The thickness of trays shall be uniform and free from cracks, without any surface defects. Perforations shall be of staggered pattern with large uniform holes for adequate ventilation. Bend shall be smooth without too much of reduction area at corners, (bending radius shall be approx. 600mm),.
- 2.05 The design of the cable tray shall be such that apart from imparting sufficient mechanical strength under all conditions, the deflection of the tray shall not exceed 3mm. The trays shall be capable of withstanding the maximum permissible uniformly distributed loading. The coupler plate and bolting shall also be designed suitably.
- 2.06 Each tray/section shall be supplied with holes drilled on the four sides for the coupler plates / bolts for joining different lengths / sections. The trays shall be supplied with coupler plates ('L'- shape), bolts and nuts with washer. All coupler nuts and bolts shall be of SS.

3.00 INSPECTION, FACTORY TESTS AND APPROVAL

- 3.01 All assemblies shall be inspected & tested to ascertain that the supply is in accordance with approved specification. The inspections & tests shall not relieve the supplier/ manufacturer from his responsibilities for materials and construction.

Within two weeks of receipt of the Letter Of Intent (LOI) /order, vendor must contact the Inspection Agency specified in the order and finalise with them the Quality Assurance Plan (QAP) for carrying out Inspection and test. The vendor shall be responsible for adherence to relevant procedures and standards for inspection and testing of the material.

	GENERAL SPECIFICATION FOR CABLE TRAY		
		DOCUMENT NO	REV
		SHEET 4 OF 5	

In absence of any Inspection Agency the vendor must submit the Quality Assurance Plan for principal's approval. All tests, in such cases, shall be conducted by manufacturer's quality department and the results of tests shall be forwarded alongwith the supply.

Procedure and extent of tests shall be governed by QAP mutually agreed between the vendor and principal's inspection authority.

No assemblies shall be shipped until all the required tests are successfully completed and certified "Cleared for despatch" by the inspection authority.

4.00 PACKAGING

Requirement of packaging stated elsewhere in the bid document.

5.00 IDENTIFICATION AND MARKING

5.01 Self adhesive tapes or signs are not permissible for permanent marking on any assemblies.

5.02 The packing shall clearly be marked on the outside (on top side and ends) in indelible ink the following minimum details:

- part no.
- size of tray (Length x Width x Height)
- No. of trays / sections, total length
- material specification
- customer's name
- manufacturer's name

Also cable tray shall have lamicoid nameplate with 6 mm minimum size black letters on white background

6.00 SPARES

Spares quantities are included in the main item quantity.

	GENERAL SPECIFICATION FOR CABLE TRAY		
		DOCUMENT NO	REV
		SHEET 5 OF 5	

7.00 DOCUMENTATION

The following documents (Technical) are required to be submitted by the vendor alongwith bid, after placement of order for approval purposes and final documentation before despatch of consignment.

Sl. no.	Description of document	Alongwith bid	After placement of order	
			For approval/ information within two weeks	Final documents before despatch of consignment
1.	Consolidated list of drawing & documents supplied by vendor.	Yes	Yes (I)	Yes
2.	Catalogue/ technical literature of tray including cross-sectional view, dimensions, weights etc.	Yes	x	Yes
3.	Deviation if any, from the technical spec. giving justification for the same.	Yes	x	x
4.	Dimensional drgs. for each item with technical details like dimension, weight, material of components etc.	x	Yes(I)	Yes
5.	Chemical analysis and material test certificates from approved laboratory.	x	x	Yes
6.	Strength calculations for each type of tray and coupler joint.	x	x	Yes
7.	"As supplied" data sheet signed by qualified engineer	x	x	Yes
8.	Quality Assurance Plan	x	Yes(A) (within 2 weeks)	x

NOTES:

- (A) for Approval (I) for information
- Sl. No. 1 to 7 shall be forwarded to principal as per details outlined in enquiry/order.
- Sl. No. 8 shall be mutually finalised with Inspection Authority specified in the order as per clause no. 3.01.
- Number of sets shall be as stipulated elsewhere in the bid document. Final documentations shall be supplied in hard copies as well as soft copies in CD formats. Applicable software is MS Office, Word, Access, and Excel. The documentation language shall be English.

	PROJECTS & DEVELOPMENT INDIA LTD	Doc No	
		Date	
		Rev	0

TECHNICAL SPECIFICATION
 FOR
 INSTRUMENT CABLES

0	25.10.2018	For Clients Comments	GAP	MN	MN
Rev	Date	Purpose	Prepd	Rewd	Apprd

	PROJECTS & DEVELOPMENT INDIA LTD	Doc No	
		Date	
		Rev	0

TABLE OF CONTENT

1. INTRODUCTION
2. SCOPE
3. REFERENCE CODES AND STANDARDS
4. SPECIFIC REQUIREMENTS FOR FIRE RESISTANT CABLE
5. DESIGN AND CONSTRUCTION (Signal & Control Cables)
6. DESIGN AND CONSTRUCTION (T/C Extension Cables)
7. DESIGN AND CONSTRUCTION (TRIAD)
8. DRUM LENGTH AND LENGTH TOLERANCE
9. INSPECTION & TESTING
10. DOCUMENTATION
11. IDENTIFICATION AND MARKING
12. SPECIAL INSTRUCTIONS TO THE BIDDER

	PROJECTS & DEVELOPMENT INDIA LTD	Doc No	
		Date	
		Rev	0

60332	Tests on bunched wires and cables.
60092	Electrical Installations of Cables
60754	Test on Gases Evolved during Combustion of materials From Cables - Part 1,2. 2.4
60584-3	Extension and compensating cables - Tolerances and identification system
d. IS Indian Standards	
1554 Part 1	PVC insulated (heavy duty) electric cables-working Voltage up to and including 1100V.
3975	Mild steel wires, formed wires and tapes for armouring of cables.
5831	PVC insulation and sheath of electric cables.
6380	Elastomeric insulation and sheath of electric cables
6474	Polyethylene Insulation and sheath of electric cables
10810	Method of test for cables.
8784	Thermocouple Extension and compensating cables.
Part 40	Method for testing uniformity of coating on zinc coated articles.
Part 41	Mass of zinc coating on steel armour
Part 58	Oxygen Index test
Part 59	Determination of halogen acid gas evolved during Combustion of polymeric material taken from cables
Part 61	Flame Retardant test
Part 62	Flame Retardance test for bunched cables
Part 63	Smoke densities of electric cables under fire conditions
IS: 7098 (Part 1)	Specification for cross linked polyethylene insulated PVC sheathed cables

4. SPECIFIC REQUIREMENTS FOR FIRE RESISTANT CABLE

4.1 Instrument cables shall be FR type as specified.

4.2 The cables shall have circuit integrity as per IEC 60331.

4.3 Primary insulation shall be heat resisting elastomeric which can withstand temperature up to 90°C such as silicon rubber/mica glass tape/EPR (medium grade) as per IS 6380. Insulation thickness shall be 1.0 mm minimum and shall conform to IEC 60092.

	PROJECTS & DEVELOPMENT INDIA LTD	Doc No	
		Date	
		Rev	0

4.4 A wrapping of tape made of PETP (polyethylene terephthalate)/woven glass shall be provided over core insulation

4.5 Individual pair triad shall be shielded. The shield shall be aluminium backed by glass mica/ PETP tape with the metallic side down helically applied with 25% overlap on either side or 100% coverage. Minimum shield thickness shall be as per IEC 60092. Drain wire shall be 0.5mm² (7/0.3mm dia) multi-stranded bare tinned annealed copper conductors. Drain wire shall be in continuous contact with aluminium side of the shield

4.6 Inner and outer sheath shall be made of low smoke, heat resistant, oil resistant and flame retardant material with oxygen index over 30, temperature index shall be over 250°C. Acid generation shall be maximum 20% by weight as per IEC 60754. Smoke density rating not to exceed 60% as per ASTM D 2843.

4.7 The thickness of the sheath shall be as per IEC 60092. Inner and outer sheath colour shall be as specified in data sheet. A rip cord shall be provided for inner sheath.

4.8 Armour bedding over inner sheath shall be of special high oxygen index, low smoke halogen free fire resisting compound.

5. DESIGN AND CONSTRUCTION [Signal & Control Cable]

5.1 For PE insulated cables primary insulation shall be of 70 deg C Polyethylene. Thickness of primary insulation shall be 0.5 mm as a minimum.

5.2 Inner & outer sheath colour of signal cables shall be as per data sheet. The thickness of the sheath shall be as per IS 1554 part 1.

5.3 Inner and outer sheath of cable shall be flame retardant made of extruded PVC Type ST2 (90°C) as per IS 5831 and shall meet the following requirements:

- Minimum Oxygen index of PVC shall be 30 at 27 deg C +/- 2 deg C.
- Temperature index shall be over 250 deg C.
- Inner and Outer sheath shall meet flame retardant requirements for bunched cables as per IS108 10 (Part 62) category AF or IEC 60332 category A.
- A rip cord shall be provided for inner sheath.
- Outer sheath shall be suitable for protecting the cable against rodent and termite attack.

5.4 Armour over inner sheath shall be of galvanised steel wire/flat. The dimensions of armour shall be as per IS 1554 (Part 1). Requirement and methods of tests for armour material and uniformity of galvanisation shall be as per IS 3975 and IS 10810 (Part 40) respectively.

5.5 Each pair/triad shall be shielded. Shield shall be of aluminium backed by Mylar / polyester tape bonded together helically applied with metallic side down having 25% overlap on either side and 100% coverage. Minimum shield thickness shall be 0.05 mm. Drain wire shall be 0.5 mm² multi-strand bare tinned annealed copper conductor. The drain wire shall be in continuous contact with aluminium side of the shield.

5.6 Overall shield shall be of aluminium backed up by Mylar /polyester tape helically applied with the metallic side down with either side having 25% overlap and 100% coverage. Minimum shield thickness shall be 0.075 mm. Drain wire shall be similar to individual pair/triad drain wire and shall be over the overall shield.

	PROJECTS & DEVELOPMENT INDIA LTD	Doc No	
		Date	
		Rev	0

5.7 The cores of a pair triad shall be twisted with a minimum of 13-15 twists per metre of cable.

5.8 Sequential marking of the length of the cable in meters shall be provided on the outer sheath at every one meter. The embossing /engraving shall be legible and indelible.

5.9 Tolerance in overall diameter of cable shall be within +/- 2 mm over offered value.

5.10 Electrical Characteristics

5.10.1 Maximum DC (Direct. Current) resistance of the conductor of the finished cable shall not exceed 12.3 Q / km at 20°C for cables with 1.5 mm² conductors and 39.7 Q / km at 20°C for cables with 0.5 mm² conductors.

5.10.2 Capacitance

- a) Mutual Capacitance for PVC Insulated cables: The mutual capacitance of between pairs/triads or adjacent cores shall not exceed of 250 pF / metre at a frequency of 1 KHz.
- b) Mutual Capacitance for PE Insulated cables: The mutual capacitance between the pairs/triads shall not exceed of 100 pF / metre at a frequency of 1 KHz.
- c) Capacitance between any core or screen: The capacitance between any core and screen shall not exceed a maximum of 400 pF / metre at a frequency of 1 KHz.
- d) L/R ratio of adjacent core shall not exceed 40 $\mu\text{H}/\Omega$ for cables with 1.5 mm² conductors and 25 $\mu\text{H}/\Omega$ for cables with 0.5 mm conductors.
- e) The drain Wire resistance including shield shall not exceed 30 Ω / km.
- f) Electrostatic noise rejection ratio of the finished cable shall be over 76 dB.

5.10.3 Type I (Single pair/Triad shielded)

- a) Each core shall be 1.5 mm² made of 7 stranded annealed electrolytic copper conductor. Each strand shall be 0.54 mm diameter.
- b) Colour of core insulation shall be.. Other requirements of these specifications shall be complied.

5.10.4 Type-II (Multi-pair/ Multi-triad cable with individual pair/triad shield and overall shield)

- a) Conductor sizes shall be 1.5mm² made up of 7 strands of annealed electrolytic copper conductor. Each strand shall be of 0.54 mm diameter.
- b) A pair of communication wire shall be provided for multipair/ multitriad cables. Each wire shall be 0.5 mm² of plain annealed single or multistrand copper conductor with 0.4 mm thick 85°C PVC insulation . Insulation shall be as specified.
- c) A pair identification shall be with numbers at interval of not more than 250 mm. Other requirements of these specifications shall be complied.

6. DESIGN AND CONSTRUCTION [T/c Extension Cable]

	PROJECTS & DEVELOPMENT INDIA LTD	Doc No	
		Date	
		Rev	0

- 6.1 Type and material of extension cable core shall be as per IS 8784 and IEC 60584-3 as applicable.
- 6.2 Primary insulation for PVC insulated cables, shall be 85°C polyvinyl chloride Type C as per IS583 1. Thickness of primary insulation shall be 0.5 mm as a minimum.
- 6.3 Unless specified otherwise, insulation, inner sheath and outer sheath colour shall be as per IEC60584. However it is vendor's responsibility to re-confirm insulation and sheath colour with purchaser prior to manufacturing. The thickness of the sheath shall be as per IS 1554 part 1.
- 6.4 Inner and outer sheath of cable shall be flame retardant made of extruded PVC Type ST2 (90°C) as per IS 583 1 and shall meet the following requirements:
- Minimum Oxygen index of PVC shall be 30 at 27 deg C +/- 2 deg C.
 - Temperature index shall be over 250 deg C.
 - Inner and Outer sheath shall meet flame retardant requirements for bunched cables as per IS108 10 (Part 62) category AF or IEC 60332 category A.
 - A rip cord shall be provided for inner sheath.
 - Outer sheath shall be suitable for protecting the cable against rodent and termite attack.
- 6.5 Armour over inner sheath shall be of galvanised steel wire/flat. The dimensions of armour shall be as per IS 1554 (Part 1). Requirement and methods of tests for armour material and uniformity of galvanisation shall be as per IS 3975 and IS 10810 (Part 40) respectively.
- 6.6 Each pair shall be shielded. Shield shall be of aluminium backed by mylar / polyester tape bonded together helically applied with metallic side down having 25% overlap on either side and 100% coverage. Minimum shield thickness shall be 0.05 mm. Drain wire shall be 0.5 mm² multi-strand bare tinned annealed copper conductor. The drain wire shall be in continuous contact with aluminium side of the shield.
- 6.7 The cores of a pair shall be twisted with a minimum of 13-15 twists per metre of cable.
- 6.8 Sequential marking of the length of the cable in meters shall be provided on the outer sheath at every one meter. The embossing /engraving shall be legible and indelible.
- 6.9 Tolerance in overall diameter of cable shall be within +/- 2 mm over offered value.
- 6.10 Electrical Characteristics
- Thermoelectric specifications and limits of error shall be as per IEC 60584-3.
 - Mutual capacitance of the pairs or adjacent cores shall not exceed 250 pF / m at a frequency of 1 KHz.
 - Capacitance shall not exceed 400 pF / m between any core and screen at a frequency of 1 KHz.
 - Core inductance shall not exceed 4 mH / km.
 - The drain wire resistance including shield shall not exceed 30 ohm / km.
 - Electrostatic noise rejection ratio shall be over 76 dB.
- 6.11 Type I (Single pair/Triad shielded)
- Each core shall be made of 20 AWG solid conductors. Other requirements of this specification shall be complied.

7. DESIGN AND CONSTRUCTION [RTD/POWER Cable]

	PROJECTS & DEVELOPMENT INDIA LTD	Doc No	
		Date	
		Rev	0

- 7.1.1 Generally, LV Power cables shall be with standard copper conductor ,XLPE insulated, FRLS PVC inner sheathed , armored & FRLS PVC outer sheathed , Copper conductor shall be used up to and including 10mm² and for higher sizes aluminum conductor shall be used.
- 7.1.2 Size shall be 3Cx2.5 mm² .

8. Drum length and length tolerance

- 8.1.1 The length of the cables in each drum (drum length) shall be as specified in the purchaser data sheets. Where no drum length is indicated in the data sheet /material requisition, the following shall be apply:-
- Drum length for single pair/ single triad cable : As per DRUM Schedule
 - Drum length for multi-pair/ multi- triad cable : As per DRUM Schedule
- 8.1.2 Actual produced drum length shall not vary by more than + 5% from drum length. Tolerance over the total ordered length for a type of cable shall be as follows;
- + 5% for total length less than 5 km. , No negative tolerance.
 - + 2% for total length more than 5 km , No negative tolerance.

9. INSPECTION & TESTING

The detailed scope of Third party inspection and testing is as given below:

- 9.1.1 The Bidder shall develop inspection and testing procedure (ITP) for each type of item with respect to all specific requirements as applicable to ensure compliance with codes and applicable standards .Bidder shall submit ITP for approval from OWNER.
- 9.1.2 Bidder shall carryout 100% inspection for compliance with requirements of specifications at every stage of manufacturing. Bidder shall maintain records / documents of all the inspection / tests carried out and shall satisfy itself about the acceptability of the item before offering for third party inspection.
- 9.1.3 Immediately after the completion of electrical tests , the ends of the cable shall be sealed to prevent ingress of moisture with suitable PVC/ rubber caps.
- 9.1.4 OWNERL reserves the right to review / inspect / witness the items at any stage of inspection.
- 9.1.5 The list of approved inspection agency Is:-
- Engineering India Limited
 - Lloyds Register of Shipping
 - Project & Development India Limited
 - Mecon Limited
 - SGS India Pvt. Ltd.
 - RITES Limited
 - Det Norske Veritas
 - TUV Rhineland (I) Pvt. Ltd.
 - TUV India Pvt. Ltd

10. DOCUMENTATION

- 10.1.1 All the data sheet, documents and drawings etc. shall be submitted to OWNER. The purchase order initiation will not be considered complete until all the documentation has been submitted by the Bidder and has been accepted by the OWNER.
- 10.1.2 All the documents shall be A4 or A3 size only; all the document prints larger than A4 shall be folded to A4 size with identification data visible at the bottom right.
- 10.1.3 All the documents submitted shall be clearly marked with following information;-
- OWNER purchase order number, item no. and identification tag no.

	PROJECTS & DEVELOPMENT INDIA LTD	Doc No	
		Date	
		Rev	0

b) Bidder job no., document no. and revision no.

10.1.4 Bidder shall furnish at least following documents along with offer.

- a) Data sheets / Specification sheet
- b) Catalogues for the quoted cables

11. IDENTIFICATION AND MARKING

Each cable drum shall be marked with the following information at a visible palce:-

- a) Manufacturer's name.
- b) Type and size of the cable with cable indicated in material requisition.
- c) Length of the cable in meters contained in the drum.
- d) Gross weight
- e) Drum number
- f) Direction of rotation of drum for unwinding by means of an arrow Purchase order number.
- g) Purchase Order Number Above details shall be marked on each drum. Other details as per MR shall also be suitably indicated.

Above details shall be marked on each drum. Other details as per MR shall also be suitably indicated.

12. SPECIAL INSTRUCTION TO BIDDER

- 12.1 In case of any conflict between "Technical Specifications for INSTRUMENT CABLES" and the data sheets, the latter shall govern.
- 12.1 Bidder to submit documents (as specified in this specification) along with the offer submitted for technical evaluation.
- 12.1 Bidder to submit soft copies of all document & drawing. Bidder shall not be proceeding with manufacturing without document approval from OWNER.
- 12.1 Bidder to submit soft copies of the catalogues, manufacturer material test certificates,TPI test certificates to OWNER one week before dispatch of material for review/verification.
- 12.1 The owner reserves the right to reject or accept any tender without assigning any reasons whatsoever. The offer shall be in following format only. Each section shall be separately segregated & highlighted with distinct Marker / Flags between the sections. Offer submitted in any other format shall not be considered for evaluation & summarily rejected.

Section 1: Signed and stamped (on each page) copy of complete specifications shall be submitted as a confirmation of acceptance of this tender specification without any deviations.

Section 2: Deviations to specification if any shall be clearly listed under this section. If there are no deviations, Bidder shall say "NO DEVIATIONS" under this section. Deviations mentioned elsewhere in the offer shall be considered null and void and shall not be considered for offer evaluation. In absence of any written deviation clearly specified in the offer under this section, it will be assumed that all the specifications and requirements of the subject tender are complied with and No deviations whatever will be accepted after the placement of order.

Section 3: Complete technical catalogues, calculation sheets, dimensional and installation drawings of the offered instrument shall be attached against this section. Wherever asked to furnish details under the technical

 पी डी आई एल PDIL	PROJECTS & DEVELOPMENT INDIA LTD	Doc No	
		Date	
		Rev	0

specifications, the same shall be included in this section. Offer without calculation sheets (if applicable) & Dimensional drawings of each item shall not be accepted.

Section 4: The offer shall only be submitted in the SOR Format provided. Offer submitted in any other format is not acceptable & may be liable for rejection.

 पी डी आई एल PDIL	PROJECTS & DEVELOPMENT INDIA LTD	TRANSMITTER SPEC	0
		DOCUMENT NO	REV
		SHEET 1 OF 2	

TECHNICAL SPECIFICATION

FOR

PRSSURE, D/P & TEMPERATURE TRANSMITTER

REV	REV DATE	EFF DATE	PURPOSE	PREPD	REVWD	APPD
0	26.10.18	26.10.2018	ISSUE FOR ENQUIRY	GAP	MN	MN

	PROJECTS & DEVELOPMENT INDIA LTD		0
		DOCUMENT NO	REV
		SHEET 3 OF 2	

LIST OF ATTACHMENTS

SL. NO.	DRAWINGS/ DOCUMENTS.DESCRPTION	ATTACHMENT NO. / DOCCUMENT NO	No of Sheets
1.	ENGINEERING SPECIFICATIONS	ES-7308	08
2.	INSTRUMENT SPECIFICATION	EM162-7044-ISP-7308	06
<p>Bidder to see SOR, Section A for transmitter Types and ranges, Price shall be quoted there as per this specification.</p>			



PROJECTS & DEVELOPMENT INDIA LIMITED

ES-7309

0

DOCUMENT NO.

REV

SHEET 1 OF 6

This document is the property of Projects & Development India Limited(PDIL) and not to be copied or reproduced or shown to third parties without the written permission of PDIL.

**ENGINEERING SPECIFICATION
FOR
PRESSURE & DIFFERENTIAL PRESSURE
TRANSMITTERS WITH SEAL**

FORM NUMBER 02-0000-0021 F1 REV 0

0	26.10.2018	ISSUED FOR IMPLEMENTATION	GAP	MN	SKT
REV	DATE	PURPOSE	PREPARED	REVIEWED	APPROVED



**ENGINEERING SPECIFICATION FOR
PRESSURE & DIFF. PRESSURE TRANSMITTER
WITH SEAL**

ES-7309	0
DOCUMENT NO.	REV
SHEET 2 OF	6

CONTENTS

SECTION NUMBER	DESCRIPTION	SHEET NUMBER
1.0	GENERAL	
2.0	GENERAL REQUIREMENT OF PRESSURE TRANSMITTER	
3.0	INSPECTION, FACTORY TESTS AND APPROVAL	
4.0	PACKING	
5.0	IDENTIFICATION AND MARKING	
6.0	SPARES	
7.0	DOCUMENTATION	

LIST OF ATTACHMENTS

ATTACHMENT NUMBER	DESCRIPTION	NUMBER OF SHEETS



**ENGINEERING SPECIFICATION FOR
PRESSURE & DIFF. PRESSURE TRANSMITTER
WITH SEAL**

ES-7309	0
DOCUMENT NO.	REV
SHEET 3	OF 6

This document is the property of Projects & Development India Limited(PDIL) and not to be copied or reproduced or exhibited to third parties without the written permission of PDIL.

FORM NUMBER 02-0000-0021 F2 REV 0

1.00 **General**

- 1.01 This Engineering specification together with the Instrument specification attached herewith define the technical requirement for the supply of Pressure and Differential Pressure Transmitters with integral flush, extended or remote Seal, its spares, documentation and testing.
- 1.02 In the event of any conflict between this Engineering specification and Instrument specification the later shall prevail.

2.00 **General Requirements**

- 2.01 For all applications, the transmitter shall be supplied with “smart electronics”. The feature of “smart electronics” shall include selectable analog/digital output mode, remote re-ranging, self checking, diagnostics and configuration from hand held configurator or remote HART maintenance system. The transmitter must have provision for upgrading the communication protocol to ‘Foundation fieldbus’ in future.
- 2.02 Studs & nuts used in transmitter and seal assembly shall be of stainless steel if otherwise not specified in the data sheet. If no special requirements are stipulated all gaskets/'O' rings in contact with process fluid shall be of teflon or equivalent. For liquid ammonia service low temp application (sub-zero temp.), gaskets/'O' rings shall be EP-851 or equivalent.
- 2.03 The transmitter shall have protection against reverse polarity connection.
- 2.04 The transmitter shall be unaffected due to radio frequency interference. The supplied electronic part shall have susceptibility of less than 0.5% of span for a frequency range of 20-500 MHZ in a field strength of 20 volts/metre.
- 2.05 Cable entries shall be plugged during transit to avoid damage.
- 2.06 Mounting accessories shall be suitable for 2 inch NB vertical pipe.
- 2.07 Digital output gauge shall be integral with electrical housing but there shall be partition between electronics & output meter.
- 2.09 All transmitters with chemical seal shall have 1/2” NPT(F) connection on bottom chamber or flanged as specified in the individual instrument specification sheets and attached sketches. Capillary connection between transmitter and different types of seals shall be a part of Transmitter vendor.
- 2.10 The scope as per enclosed instrument specification sheets may include either Pressure or Differential pressure Transmitters with chemical seal or combination of any.
- 2.11 The electrical terminals shall be vibration proof . The transmitter terminals shall preferably be located in a compartment separated from field electronics. Flying leads are not acceptable.
- 2.12 Transmitters in hazardous areas shall either be ex-proof or intrinsic safe



**ENGINEERING SPECIFICATION FOR
PRESSURE & DIFF. PRESSURE TRANSMITTER
WITH SEAL**

ES-7309	0
DOCUMENT NO.	REV
SHEET 4 OF	6

This document is the property of Projects & Development India Limited (PDIL) and not to be copied or reproduced or exhibited to third parties without the written permission of PDIL.

conforming to area classification & execution specified against each item in the individual specification sheets.

Ex-proof/flame proof certification shall conform to CENELEC/FM/ BASEEFA/ IS standard. IS - 2148 certification must be supplemented with the temperature classification certification conforming to IS - 8239. However, any ex.proof/flame proof certification requiring sealing of cable entry with sealing compound or enclosures with sealed cable entry and flying leads are not acceptable. Intrinsic safe certification shall in general conform to CENELEC standard EN 500014 and EN 50020, if not otherwise specified in the individual specification sheet.

2.13 Components made of copper and copper alloys exposed to atmosphere and coming in contact with the operating fluid must not be used for ammonia & urea services.

3.00 Inspection, Factory tests and approval

3.01 Within two weeks of receipt of the LOI/order the vendor must contact the Inspection Agency specified in the order and finalise with them the Quality Assurance Plan for carrying out Inspection and test. In absence of any Inspection Agency the vendor must submit the quality Assurance Plan for PDIL/OWNER's approval. All tests, in such cases, shall be conducted by Vendor's Quality Department and the results of tests shall be forwarded alongwith the supply.

The manufacturer shall give clear 15 days notice informing readiness of the instrument at manufacturer's works. The vendor shall permit the authorised representative of PDIL/OWNER to inspect the manufacture and assembly of the instrument in various phases in compliance with mutually agreed quality assurance plan, standards and specifications.

The vendor shall make available to the authorised representative of PDIL / OWNER the results of all the checks/calibrations conducted before presenting for PDIL/Owner's inspection. The vendor to provide all necessary facilities free of cost to PDIL/Owner's representative for carrying out the checks/calibration as per standard/approved quality assurance plan. Under no condition inspection can be waived off without the written permission of PDIL.

3.02 No instrument/accessory shall be shipped until all the required tests are successfully completed and certified "Cleared for despatch" by the inspection authority.

3.03 The following physical checks, routine & type, shall be in line with ISA S 51.1. The procedure & extent of test shall be governed by Quality Assurance Plan mutually agreed and approved by Inspection Authority.

A. Physical Checks

1. Name Plate details
 - Tag no.
 - Model no.
 - Range
 - Execution (IP, IS, Ex'd' etc.)
2. Process connection
3. Manifold

B. Routine Tests



**ENGINEERING SPECIFICATION FOR
PRESSURE & DIFF. PRESSURE TRANSMITTER
WITH SEAL**

ES-7309	0
DOCUMENT NO.	REV
SHEET 5	OF 6

This document is the property of Projects & Development India Limited(PDIL) and not to be copied or reproduced or exhibited to third parties without the written permission of PDIL.

1. Calibration check for Linearity, Accuracy, Hysteresis, Repeatability
2. Zero-shift
3. Hydraulic test.

4.00 Packing

Each transmitter and its accessories shall be suitably packed and protected from damage due to transportation, loading and unloading.

The transmitters and their accessories along with spares (commissioning spares and 2 years spares for maintenance) shall be despatched as a single consignment. Commissioning and 2 years operation spares shall be packed separately.

5.00 Identification and Marking

5.01 Self adhesive tapes or signs are not permissible for permanent marking of any instrument.

5.02 All instruments shall have a tag plate in SS screwed to the transmitter case indicating make, model no., sl.no., tag no., adjustable range, set range etc. Besides the above each instrument to have a separate circular tag number plate in stainless steel with engraved tag number and calibration range and attached securely to the instrument with a soft stainless wire. The size of letters and figures shall be minimum 4 mm and the plate should be 25 mm diameter with 1-2 mm thick.

5.03 All spare parts to be supplied alongwith the main consignment shall be fitted with identification plate with the following data clearly printed and easily readable.

- Spare parts name, model number as per purchaser's Instrument specification sheet.

- Serial number

6.00 Spares

Complete transmitter of each type & range is included as spare in the specification sheet. Other Spares shall be as per enclosed spares list.



**ENGINEERING SPECIFICATION FOR
PRESSURE & DIFF. PRESSURE TRANSMITTER
WITH SEAL**

ES-7309

0

DOCUMENT NO.

REV

SHEET 6 OF 6

This document is the property of Projects & Development India Limited (PDIL) and not to be copied or reproduced or exhibited to third parties without the written permission of PDIL.

7.00 Documentation

The following documents (Technical) are required to be submitted by the vendor alongwith bid, after placement of order for approval purposes and final documentation before despatch of consignment.

SL. NO.	DESCRIPTION OF DOCUMENT	ALONGWITH BID	AFTER PLACEMENT OF ORDER	
			FOR APPROVAL/ INFORMATION WITHIN SIX WEEKS	FINAL DOCUMENTS BEFORE DESPATCH OF CONSIGNMENT
1.	Consolidated list of drawing & documents.	Yes	Yes (I)	Yes
2.	Catalogue & technical literature of Pressure transmitter alongwith their accessories.	Yes	x	Yes
3.	Deviation if any, from the technical spec. giving justification for the same.	Yes	x	x
4.	Chemical analysis and material test certificates from approved laboratory.	x	x	Yes
5.	Certificates from recognised authority for (a) degree of protection against environment (b) for Intrinsic safety/ Ex-proof execution.	Yes	x	Yes
6.	chemical seal sectional, dimensional drawing with material of construction	Yes (I)	Yes(A)	Yes
7.	Instruction Manual for maintenance.	x	x	Yes
8.	Calibration and performance test certificates.	x	x	Yes
9.	Quality Assurance Plan.	Yes	Yes(A) (within 2 weeks)	x

(A) for Approval

(I) for Information

Sl. no. 1 to 8 shall be forwarded to PDIL/ OWNER as per details outlined in enquiry/ order.
Sl. No. 9 shall be mutually finalised with Inspection Authority specified in the order.

Number of sets alongwith bid for approval and as final documentation shall be supplied as stipulated in the purchase order.

		PRESSURE/ DIFFERENTIAL PRESSURE TRANSMITTER					
PROJECT NO. :							VENDOR DEVIATIONS
PROJECT :	:						
PLANT :	:						
CUSTOMER :	:						
REQ. NO. :	:						
ORDER NO. :	:	P	26.10.2018	DRAFT ENQ.	GAP	MN	
MANUFACTURER :	:	REV	DATE	PURPOSE	PREP	CHKD	
Bidder to Refer SOR(supply) for Instrument Ranges for Different Types							
1	FUNCTION	PRESSURE & DIFFERENTIAL PRESSURE MEASUREMENT & TRANSMISSION					
2	FILL FLUID	SILICON OIL					
3	VERSION/COMMUNICATION	SMART WITH HART PROTOCOL					
4	MEASUREMENT PRINCIPLE/TYPE	CAPACITANCE/ PIEZORESISTIVE. (VENDOR TO SPECIFY).					
5	POWER SUPPLY	24 V DC 2 wire from panel instrument/ DCS as standard through isolator/ barrier					
6	TRANSMITTER OUTPUT	4-20 mA DC with digital communication through HART protocol as standard.					
7	LOAD RESISTANCE	550 OHMS MINIMUM AT 24V DC					
8	INTEGRAL DIGITAL OUTPUT INDICATOR	with configurable facility for digital indication of pressure, temperature, percentage					
9	ZERO & SPAN ADJUSTMENT	Continuously adjustable externally, non interacting type as standard.					
10	ZERO SUPPRESSION/ ELEVATION	100% of ,max. range in case of SMART.					
11	DAMPING	0-32 sec adjustable in various steps of time constants					
12	ACCURACY	± 0.05 % of span as standard for SMART Transmitters.					
13	ELECTRICAL CONNECTION	1/2" NPT (F) WITH SS PLUG					
14	MOUNTING	ON 2" NB VERTICAL PIPE MOUTING WITH SS CLAMPS and bolts					
15	HUMIDITY	0-95 % RH					
16	STABILITY	±0.1% of URL per 5 years					
17	OVER PRESSURE	a) PR. TRANSMITTER: Minimum 1.5 TIMES OF DESIGN PRESSURE b) DP TRANSMITTER: 250 Kg/ Cm2g					
18	PROCESS CONNECTION	NOTE-9					
19	O' RING	PTFE/ FOR AMMONIA EP851					
20	ENVIRONMENTAL PROTECTION CLASS	IP-67 or Better					
21	AREA CLASSIFICATION	ZONE 2, GR IIA, T1					
22	TURNDOWN RATIO	100:1					
23	STATIC PR. COMPENSATION	YES					
24	AMBIENT TEMPERATURE COMPENSATION	YES					
25	STATIC PR. SHIFT	NOTE 1					
26	AMBIENT TEMPERATURE SHIFT	NOTE 1					
27	AMB. TEMP. LIMIT	-5 TO +60 DEG C					
28	DRAIN OR VENT ARRANGEMENT	YES					
29	MATERIAL	A) SENSOR(CAPSULE): SS316L/HASTELLOY C					
30	EXECUTION	Exd IIA T1					
31	SELF TEST/ DIAGNOSIS	YES,WRITE PROTECTION SWITCH, NON VOLATILE MEMORY					
32	TRANSMITTER housing	Polyurethin covered Die cast Aluminum or BETTER					
33	TRANSMITTER DRAIN & VENT VALVE MATL.	SS 316					
34	TRANSMITTER BOLTS/NUTS/SCREW MATL.	YES, SS 316 / ABOVE 100 Kg/Cm2g SUS 610					
35	SQUARE ROOT EXTRACTION	CONFIGURABLE					
36	LOCAL DISPLAY	Built in 5 digit LCD type with					
37	LIGHTENING PROTECTION	YES					
38	OPTIONS						
	(A) MOUNTING ACCESSORIES	YES (2" NB VERTICAL PIPE MOUNTING WITH CLAMP & SS NUT BOLT)					
	(B) THREE VALVE MANIFOLD	YES, T-TYPE, SS316 MATERIAL					
	(C) CABLE GLAND	1/2" NPT SS , DOUBLE COMPRESSION TYPE, Ex- Proof					
	(D) TWO VALVE MANIFOLD	YES, SS316 MATERIAL					
NOTES :							
1. MANUFACTURER TO SPECIFY.							
2. Body rating selected by manufacturer shall be suitable for the given pressure & temp.							
3. YES, Mounting Bracket for mounting on 2" pipe with U-clamp & bolts, Matl.SS.							
4. In case of High Temp. i.e more than 200 deg. C, Suitable 'O' Ring material to be quoted by the manufacturer.							
5. Each transmitter shall be supplied with 1/2" NPT SS plug for auxiliary electrical connection.							
6. Vendor shall indicate full model codes for the transmitters offered and shall submit relevant decoding sheet also							
7. Valve manifold & transmitter body shall be tested Hydraulically separately							
8. HOLD. Vendor Data awaited . Data will be provided later.							
9. Transmitter process connection for both PT and DPT shall be 1/4", NPT (F), however it may be noted that the impulse pipe and oval flange will be 1/2". Accordingly supporting manifold of ss316 shall be provided.							
10. Drain/vent plug shall be integrated with transmitter. Vendor should not mak any external arrangement for the same as it will not be accepted.							
11. Process connection type of both PT and DPT should be side entry							
12. Maximum working pressure for PT will be 1.5 times of design pressure and for DPT it should be 250kg/cm2g.							



TEMPERATURE TRANSMITTER (HART)

PROJECT NO. :						
PROJECT :						
PLANT :						
CUSTOMER :						
REQ. NO. :	0	26.10.2018	ISSUE FOR ENQUIRY	GAP	MN	MN
ORDER NO. :						
MANUFACTURER :	REV	DATE	PURPOSE	PREP	CHKD	APPD

Bidder to Refer SOR(supply) for Insrument Ranges for Different Types

1	FUNCTION	TEMPERATURE MEASUREMENT & TRANSMISSION
2	TYPE	UNIVERSAL PROGRAMMABLE FIELD MOUNTABLE TYPE SUITABLE TO ACCEPT ALL TYPE OF T/C & RTD INPUTS 3 WIRE (DUAL COMPARTMENT)
3	COMMUNICATION	SMART WITH LATEST HART PROTOCOL
4	POWER SUPPLY	12.5-30V DC, 2 WIRE LOOP POWERED
5	POWER SUPPLY EFFECT	+/- 0.005% OF CALIBRATION SPAN PER VOLT
6	TRANSMITTER OUTPUT	4-20 mA DC + HART/ DIGITAL
7	LOAD RESISTANCE	600 OHMS FOR DIGITAL COMM. AND 1250 OHMS FOR ANALOG OPERATION
8	INTEGRAL DIGITAL OUTPUT INDICATOR	YES ,LCD DISPLAY, LINEAR SCALE, CONFIGURABLE IN ENGG. UNITS
9	ZERO & SPAN ADJUSTMENT	CONTINUOUSLY ADJUSTABLE FROM HAND HELD CONFIGURATOR OR PC
10	ACCURACY	± 0.15 % of calibrated span for RTD & T/C (INCLUDING LINERARITY , HYSTERESIS AND REPEATABILITY)
11	COLD JN. ACCURACY	+/- 0.5 deg C FOR T/C
12	UPDATE TIME	0.5 secs adjustable in various steps of time constants
13	ISOLATION	INPUT/OUTPUT/GND 500 V AC. MIN
14	SENSOR BACKUP FN	AUTOMATC SWTCH OVER TO SENSOR 2
15	ELECTRICAL CONNECTION	2 Nos. 1/2" NPT (F) (Note-2)
16	MOUNTING	ON 2" NB VERTICAL PIPE MOUTING WITH CLAMPS
17	HUMIDITY	0-100 % RH
18	AMB. TEMP. LIMIT	UPTO 85 ° C
19	STABILITY	+/- 0.1 % OF UPPER RANGE LIMIT FOR 5 years
20	BURNOUT FEATURE	USER SELECTABLE FOR HIGH OR LOW
21	ENVIRONMENTAL PROTECTION CLASS	IP-67
22	AREA CLASSIFICATION	Ex-Proof & INTRINSICALLY SAFE TO HAZARDOUS AREA Zone 1 Gr. IIA/B Temp Code T3 as per IEC.
23	EXECUTION	Ex(ia)
24	SELF TEST/ DIAGNOSIS	FEATURES SHALL BE INBUILT OF TRANSMITTERS
25	ELECTRICAL HOUSING	Matl.-Al Alloy Protecting Paint-Epoxy Polyster as standard
26	TRANSMITTER BODY MATL	SS 316
27	LIGHTENING PROTECTION	YES
28	BODY TRANSMITTER BOLTS/NUTS/SCREW MATL.	YES (SS 316/CS) IF ANY
37	ACCESSORIES	
	(A) MOUNTING ACCESSORIES	YES (2" NB VERTICAL PIPE MOUNTING WITH CLAMP & SS NUT BOLT)
	(B) CABLE GLAND	1/2" NPT SS , DOUBLE COMPRESSION TYPE, Ex- Proof

NOTES :

1. Manufacturer to Specify
2. All transmitters shall have two cable entries and one shall be supplied with 1/2" NPT gland and the other shall be plugged with SS plug.
3. Vendor shall indicate full model codes for the transmitters offered and shall submit relevant decoding sheet also

	<h1>FRP CANOPY</h1>	Doc No	FRP CANOPY
		Date	18.10.2022
		Rev	0

FRP CANOPY

Rev	Date	Purpose	Prepd	Rewd	Apprd

	<h1>FRP CANOPY</h1>	Doc No	
		Date	
		Rev	0

Technical Details:-

Material Of Construction	FRP (Fibre Reinforced Polyester) with U. V. Stabilised, Fire Retardant
Colour	RAL 7032
Thickness	3 mm to 5 mm
Dimension	As Per Drawings attached
Corrosion	Resistant to corrosion is required
Flammability	Shall be Low as per IS-6746
Oxygen Index	30+
Flame Spread Index	14 to 15

Mounting Arrangement & Accessories:-

Mounting Of Transmitter :-	S. S. Pipe 50 NB (Refer Attached Drawing)
View Glass :-	No
Breather :-	No
Hardware :-	S. S.

Mounting of Canopies

Canopies shall be mounted with 2 NOS of SS / Cadmium Coated U Clamps for 2" Pipe

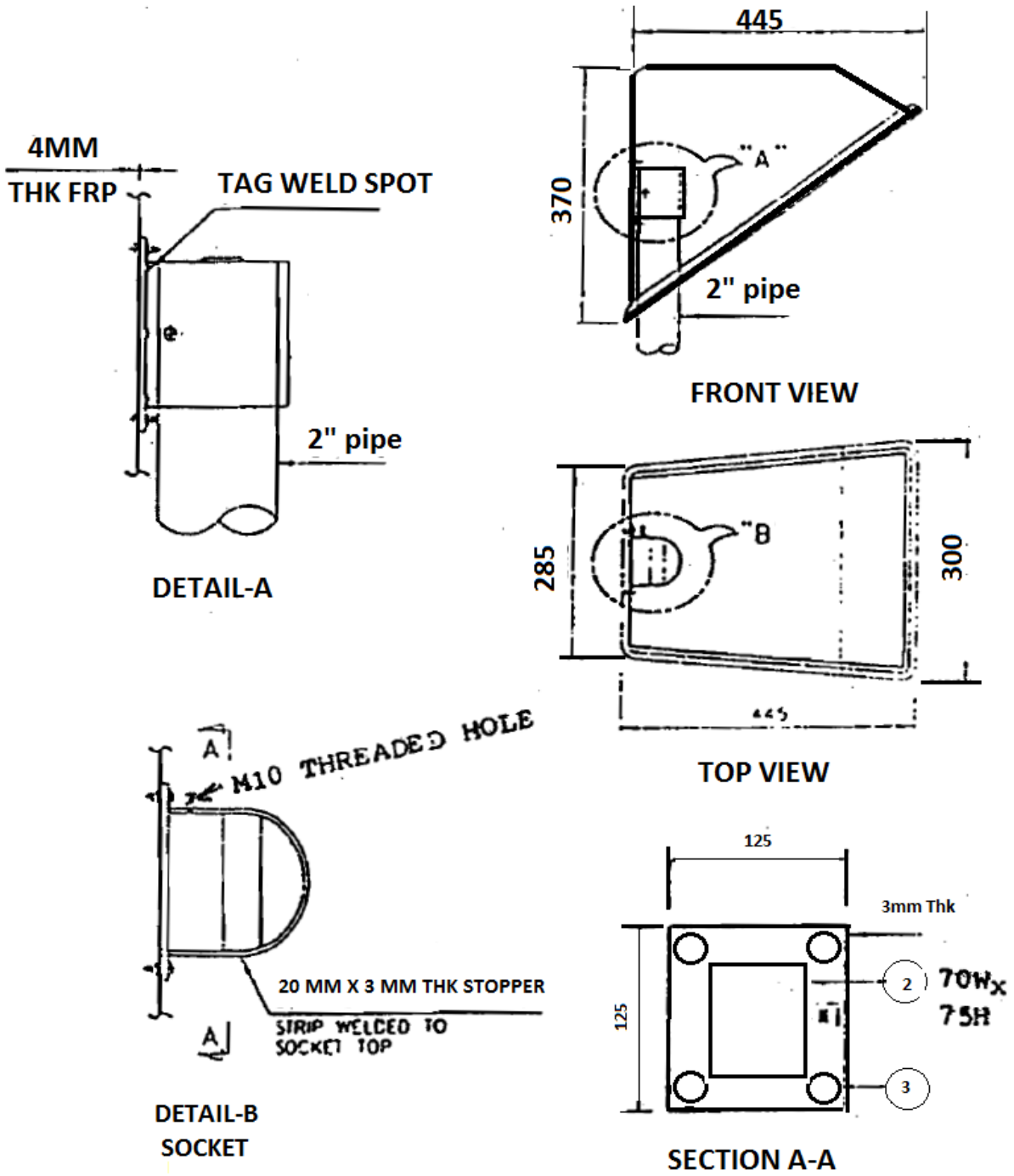

Socket Hex. head bolts & Nuts with washers shall be supplied with each unit to fix the sunshade as per site condition

Socket/Bracket shall be supplied in loose

	<h1>FRP CANOPY</h1>	Doc No	
		Date	
		Rev	0

SI No	Parts	Size	Material	Qty	Remarks
1.	Sun shade	As per dwng	FRP	As per SOR	Colour RAL 702
2	Socket to Suit 2" pipe (70Φ x75L) with MS plate	As per dwng	Ms powder Coated	As per SOR	
3.	Hexagonal Head Bolt/ stud with Washer	As per dwng M10 - 20L	SS	As per SOR	



PROJECTS & DEVELOPMENT INDIA LTD.

PDIL DOC.NO.		PNMP-TS-0904
SNC DOC.CODE		0000-46EG-0001
REV	02	Sheet 1 of 22

TECHNICAL REQUIREMENTS FOR SHOP & SITE APPLICATION OF PAINT & PROTECTIVE COATING

REV	REV DATE	EFF DATE	PURPOSE	PREPD	REVWD	APPD
00	18-10-18		ISSUED FOR ENQUIRY	GAP	MN	SKT

	APPLICATION OF PAINT & PROTECTIVE COATING	PDIL DOC.NO.	PNMP-TS-0904
		SNC DOC.CODE	0000-46EG-0001
		REV	02

CONTENTS

Section Number	Description	Sheet Number
1.0	GENERAL	4
1.1	Scope	4
1.2	Definitions	4
1.3	Safety Regulations	4
1.4	Material Safety Data Sheet	4
1.5	Materials	4
2.0	INDUSTRY STANDARDS	5
2.1	Deleted	5
2.2	International Standards	6
3.0	SURFACE PREPARATION	7
3.1	Metal Surface Preparation	7
3.1.1	Safety	7
3.1.2	Pre-cleaning	7
3.1.3	Surface Decontamination	7
3.1.4	Abrasive Blasting	7
3.1.5	Alternate Methods of Surface Preparation	9
4.0	APPLICATION	9
4.1	General	9
4.1.1	General Requirements for Shop Application	9
4.1.2	General Requirements for Site Application	10
4.1.3	Qualifications and Materials	10
4.1.4	Handling and Transport	10
4.2	Application of Coatings	11
4.2.1	General	11
4.2.2	Atmospheric Conditions	11
4.2.3	Conventional or Airless Spray	11
4.2.4	Brush Application	11
4.2.5	Roller Application	12
4.2.6	Thickness of Coatings	12
4.2.7	Multiple Coat Applications (Except Wet-on-Wet)	12
4.2.8	Protective Coating for Fasteners	12
4.3	Hot Dip Galvanising	13
4.4	Damaged or Inaccessible Surfaces	13
4.4.1	Damaged Paint Surface	13
4.4.2	Damaged Galvanised Surfaces	14
4.4.3	Inaccessible Surfaces	14
4.5	Surfaces Not to be Coated	14
4.6	Touch- up Painting	14
5.0	COATING SYSTEM SELECTION	15
5.1	Coating Systems for Piping and Equipment	15
6.0	INSPECTION AND TESTING	16

	APPLICATION OF PAINT & PROTECTIVE COATING	PDIL DOC.NO.	PNMP-TS-0904
		SNC DOC.CODE	0000-46EG-0001
		REV	02

LIST OF ATTACHMENTS

ATTACHMENT SECTION	DESCRIPTION	NUMBER OF SHEETS
Annexure-I Annexure-II	Colour / Coating Code for Piping, Equipments & Structures Thermo Indicative Paint	

	APPLICATION OF PAINT & PROTECTIVE COATING		PDIL DOC.NO.	PNMP-TS-0904
			SNC DOC.CODE	
	REV	02	Sheet 4 of 22	

1.0 GENERAL

1.1 Scope

This specification covers the technical requirements for shop and site application of paint and protective coatings and includes; the surface preparation, priming, application, testing and quality assurance for protective coatings of mechanical equipment, structural steelwork, plate work, tankage, guards, pipe work, handrails and associated metal surfaces, which will be exposed to atmospheric or buried conditions for the Burrup Fertilisers Ammonia Project.

01 The contractor should evaluate & apply the required Dry film thickness (DFT) of the complete painting system to provide a 10 (Ten) years warranty of the painting work (As required by EPC Deed).

02 1.2 Definitions

C.S.	- Carbon steel and low chrome (1- ¹ / ₄ Cr through 9 Cr) alloys
S.S	- Austenitic stainless steel, such as 304,316, 321, 347,
Non-ferrous	- Copper, aluminium, and their alloys.
High Alloy	- Monel, Inconel, Incoloy, Alloy 20, Hastelloy, etc.
DFT	-Dry Film thickness,the thickness of the dried or cured paint or coating film.

1.3 Safety Regulations

Protective coatings and their application shall comply with all federal, state, and local codes and regulations on surface preparation, coating application, storage, handling, safety, and environmental recommendations.

Sand or other materials producing silica dust shall NOT be used for any open-air blasting operations unless an application-specific waiver has been approved in writing by the principal and all necessary safety precautions are taken.

1.4 Material Safety Data Sheets

The latest issue of the coating manufacturer's product datasheet, application instructions, and Material safety data Sheets shall be available prior to starting the work and shall be complied with during all preparation and painting / coating operations.

1.5 Materials

All paints and paint materials shall be obtained from the company's approved manufacturer's list.All materials shall be supplied in the manufacturer's containers, durably and legibly marked as follows.

Specification number
Colour reference number
Method of application
Batch number
Date of Manufacture
Shelf life expiry date
Manufacturer's name or recognised trade mark.

	<p style="text-align: center;">APPLICATION OF PAINT & PROTECTIVE COATING</p>	PDIL DOC.NO.		PNMP-TS-0904
		SNC DOC.CODE		0000-46EG-0001
		REV	02	Sheet 5 of 22

2.0 INDUSTRY STANDARDS

The applicable standards and their dates of issue are as follows. Where a date is not shown the latest edition of the standard available shall be used.

2.1 Deleted

	APPLICATION OF PAINT & PROTECTIVE COATING	PDIL DOC.NO.	PNMP-TS-0904
		SNC DOC.CODE	0000-46EG-0001
		REV	02

2.2 International Standards

ISO 4628:	Paints and varnishes – Evaluation of degradation of paint coatings – Designation of intensity, quantity and size of common types of defect.
ISO 4628-3:	Paints and varnishes – Evaluation of degradation of paint coatings – Designation of degree of rusting
ISO 8501	Preparation of steel substrates before application of paints and related products – Visual assessment of surface cleanliness
ISO 8501-1	Rust grades and preparation grades of uncoated substrates and of steel substrates after the removal of all previous coatings.
ISO 8501-2:	Preparation grades of previously coated steel substrates after localized removal of previous coatings.
ISO 8501-3	Preparation grades of welds, cut edges and other areas with surface imperfections.
ISO 8502	Preparation of steel substrates before application of paints and related products – Tests for the assessment of surface cleanliness
ISO 8502-1:	Field test for soluble iron corrosion products.
ISO 8502-2:	Laboratory determination of chloride on cleaned surfaces.
ISO 8502-3:	Assessment of dust on steel surfaces prepared for painting (pressure-sensitive tale method)
ISO 8502-9:	Field method for the conductometric determination of water-soluble salts.
ISO 8502-10:	Field method for the titrimetric determination of water-soluble chloride.
ISO 8503	Preparation of steel substrates before application of paints and related products – Surface roughness characteristics of blast-cleaned steel substrates.
ISO 8503-1:	Specifications and definitions for ISO surface profile comparators for the assessment of abrasive blast cleaned surfaces.
ISO 8503-2:	Method for the grading of surface profile of abrasive cleaned steel – Comparator procedure.
ISO 8504	Preparation of steel substrates before application of paints and related products – Surface preparation methods
ISO 8504-1:	General principles
ISO 11124-1:	Preparation of steel substrates before application of paints and related products -- Specifications for metallic blast-cleaning abrasives -- Part 1: General introduction and classification
ISO 11124-2:	Preparation of steel substrates before application of paints and related products -- Specifications for metallic blast-cleaning abrasives -- Part 2: Chilled-iron grit
ISO 11124-3:	Preparation of steel substrates before application of paints and related products -- Specifications for metallic blast-cleaning abrasives -- Part 3: High-carbon cast-steel shot and grit
ISO 11124-4:	Preparation of steel substrates before application of paints and related products -- Specifications for metallic blast-cleaning abrasives -- Part 4: Low-carbon cast-steel shot
ISO 11126-1:	Preparation of steel substrates before application of paints and related products -- Specifications for non-metallic blast-cleaning abrasives -- Part 1: General introduction and classification

	APPLICATION OF PAINT & PROTECTIVE COATING		PDIL DOC.NO.	PNMP-TS-0904
			SNC DOC.CODE	
	REV	02	Sheet 7 of 22	

3.0 SURFACE PREPARATION

3.1 Metal Surface Preparation

3.1.1 Safety

All work in adjacent areas, which may negatively affect the quality of blast cleaning, and/or impose safety hazards, must be completed or stopped before the blasting operation starts.

3.1.2 Pre-cleaning

Prior to surface preparation all weld spatter shall be removed from the surface, all sharp edges ground down and all surfaces cleaned free of contaminants including chalked paint, dust, grease, oil, chemicals and salt in accordance with AS 1627.4 Clause 6. All shop primed surfaces shall be water washed by means of suitable solvent, by steam cleaning, with an alk aline cleaning agent if necessary or by high-pressure water, to remove contaminants prior to top-coating

3.1.3 Surface Decontamination

Surface decontamination shall be performed prior to paint application when uncoated surface is exposed to a corrosive environment or existing paint work is to be repaired.

Existing coatings shall be removed by abrasive blast cleaning, and then high pressure potable water shall be used to clean steel surfaces.

Prior to application of coatings, the surface shall be chemically checked for the presence of contaminants. A surface contamination analysis test kit (KTA, or approved equivalent) shall be used to measure the levels of chlorides, iron salts and pH in accordance with the kit manufacturer's recommendations.

Swabs taken from the steel surface, using cotton wool test swabs soaked in distilled water shall not be less than one swab for every 25m² of surface area to be painted.

Maximum allowable contaminant levels and pH range is as follows:

Sodium chloride, less than 50 microgram / cm²;

Soluble iron salts, less than 7 microgram / cm²; and

pH between 6 – 8

If the results of the contamination test fall outside the acceptable limits, then the wash water process shall be repeated over the entire surface to be painted, until the contaminant test is within the specified levels.

3.1.4 Abrasive Blasting

All C.S. materials shall be abrasive blast cleaned in accordance with AS1627.4. To reduce the possibility of contaminating S.S., blasting is not usually specified. However, for coatings which require a blast-cleaned surface for proper adhesion, S.S. may be blast cleaned in accordance with AS 1627.4 using clean aluminium oxide or other abrasives. (free from any chloride or Iron / Steel contamination). When hand or power tool cleaning is required on

	APPLICATION OF PAINT & PROTECTIVE COATING	PDIL DOC.NO.	PNMP-TS-0904
		SNC DOC.CODE	0000-46EG-0001
		REV	02

S.S., only S.S. wire-brushes (including 410 S.S.) which have not been previously used on C.S. surfaces, may be used.

The surface profile of steel surfaces after blasting shall be of preparation grade Sa 2-1/2 or better according to ISO 8501-1 and shall be measured using the replica tape method or the comparator method in accordance with AS 1627.4. Appendix –C.

The roughness (profile) of blast-cleaned surfaces shall be Medium (G) according to ISO 8503-2: 1988 (appendix 1) unless otherwise specified. Medium defines a surface profile with a maximum peak-to-valley height of 60-100 microns, and G indicates that the surface profile is obtained by (G)rit blasting. For the evaluation of surface roughness Comparator G shall be used.

Abrasive blast cleaning shall NOT be performed when the ambient or the substrate temperatures are less than 3 ° C above the dew point temperature. The relative humidity should preferably be below 50% during cold weather and shall never be higher than 60% in any case.

Abrasive blast cleaning shall be performed with a clean, sharp grade of abrasive. Grain size shall be suitable for producing the specified roughness. Abrasives shall be free from oil, grease, moisture and salts, and shall contain no more than 50ppm chloride. The use of silica sand, copper slag and other potentially silica containing materials shall not be allowed

The blasting compressor shall be capable of maintaining a minimum air pressure of 7 kPa at the nozzle to obtain the acceptable surface cleanliness and profile.

The blast cleaning air compressor shall be equipped with adequately sized and properly maintained oil and water separators. The air supply shall be checked to ensure no oil and water contamination at the beginning of each work shift.

Blast cleaning abrasive shall be stored in a clean, dry environment at all times. Recycling of used abrasive is prohibited.

After blast cleaning, the surfaces shall be cleaned in accordance with AS 1627.4 clause 6.3.

Assessment of the blast cleaned surfaces shall be carried out in accordance with AS 1627.4 clause 6.4.

Blast cleaned surfaces which show evidence of rust bloom or that have been left uncoated overnight shall be re-cleaned to the specified degree of cleanliness prior to coating.

All grit and dust shall be removed after blasting and before coating application. Removal shall be by a combination of blowing clean with compressed air, followed by a thorough vacuum cleaning with an industrial grade, heavy duty vacuum cleaner.

3.1.5 Alternate Methods of Surface Preparation

When open air blasting is not permitted on site, or when space limitations or surface configurations preclude blasting, the alternate cleaning methods listed below may be used with prior approval. Alternate cleaning methods shall consider the degree of surface cleanliness and roughness profile required by the specified coating system.

- Vacuum or suction head abrasive blast-cleaning , in accordance with AS 1627.4.
- Wet jet abrasive blast-cleaning, in accordance with AS 1627.4.

	APPLICATION OF PAINT & PROTECTIVE COATING		PDIL DOC.NO.	PNMP-TS-0904
			SNC DOC.CODE	
	REV	02	Sheet 9 of 22	

- Compressed-air wet abrasive blast cleaning, in accordance with AS 1627.4.
- Pressurized liquid blast-cleaning, in accordance with AS 1627.4.
- Power tool cleaning, in accordance with AS 1627.2
- Hand or power tool cleaning, in accordance with AS1627.2.

Hand and/or power tool cleaning shall only be used for spot repair where abrasive blasting is not permitted or is impractical, and on items which could be damaged by abrasive blasting. Power tool cleaning shall not be carried out with tools which polish the surface, e.g. power wire brushes.

4.0 APPLICATION

4.1 General

The final specification of paint systems to be used to suit the exposure conditions of equipment and steelwork, shall be as specified on the scope of work, equipment data sheets or the drawings.

All coatings shall be in accordance with Indian/international, the coating manufacturer's product data sheets and application instructions and the requirements contained in this specification.

4.1.1 General Requirements for Shop Application

All structural steelwork shall be prepared for painting and have the paint system applied before installation.

In all cases, where surfaces will be inaccessible after shop assembly, they shall be prepared and have the paint system applied before assembly is carried out. Drying times between successive coats shall be at least those recommended by the manufacturer.

All known field weld areas shall be given the specified abrasive blast surface preparation but left uncoated for a distance of 50mm from the weld line. Such areas shall be given the appropriate touch-up treatment after installation.

The manufacturer's directions for preparation and application of coatings shall be followed to ensure that the durability of the coating system is not impaired.

The Contractor shall submit the full details of the proposed surface preparation and paint systems prior to the commencement of any surface preparation.

4.1.2 General Requirements For Site Application

Paint shall be stored only in accordance with the manufacturer's instructions.

All materials used for the specific system being applied shall be products supplied by one manufacturer and details of such product shall be submitted for approval before commencement of work.

The contents of cans shall be thoroughly stirred before being poured into paint pots and shall be thinned only in the specified proportions in accordance with the manufacturer's instructions.

	APPLICATION OF PAINT & PROTECTIVE COATING		PDIL DOC.NO.	PNMP-TS-0904
			SNC DOC.CODE	
	REV	02	Sheet 10 of 22	

Finish coats may be applied by spraying except where any over spray is likely to affect finished surfaces or where spraying constitutes a health hazard to workmen in the other areas. Brush and roller application will require multiple coats to achieve the specified dry film thickness.

Brush application may be used only with the approval of the company.

Roller application shall only be used on relatively large surface areas (i.e. > 50m²) and only if spraying is not an option.

The Contractor shall complete the application of any one type of paint or each coat thereof, before beginning the next coat on that section.

In cases nominated as critical, the application of each coat shall be approved before application of the next coat can proceed, in accordance with 'hold' points nominated in the Inspection and Test Plans (ITPs)

All fittings within any given area are to be painted with the same system as the area unless otherwise specified.

4.1.3 Qualifications and Materials

All surface preparation, coatings application and inspection, shall be carried out by personnel experienced in that particular field. Contractors shall submit the names of subcontractors to be employed for the specific work together with the brand names of coating materials for approval prior to commencement of application.

4.1.4 Handling and Transport

All pipe work, steelwork and equipment that have been finish coated shall be handled with care to preserve the coating in the best practical condition.

Painted materials shall not be handled until the coating has completely cured and dried hard. Supports in contact with coated steel during transport and storage shall be covered with a soft material to prevent damage to the coating. Appropriate materials shall be used during transportation between coated steelwork and holding down chains to prevent damage to the coating.

4.2 Application of Coatings

4.2.1 General

The application method and type of equipment used shall be suitable for the paint specified and the surface being painted.

Paints and thinners shall be brought to the point of usage in unopened original containers bearing the manufacturer's brand name and colour designation and ready-mixed unless otherwise specified. Two-pack systems shall be mixed at the site of application to the paint manufacturer's recommendations. The mixed amount prepared shall be no more than the amount that can be applied during the stated pot life.

Paint shall be applied so that an even film of uniform thickness, tint and consistency covers the entire surface and is free of pin holes, runs, sags or excessive brush marks. Film finish shall be equal to that of first class brushwork.

	APPLICATION OF PAINT & PROTECTIVE COATING		PDIL DOC.NO.	PNMP-TS-0904
			SNC DOC.CODE	
	REV	02	Sheet 11 of 22	

Unless it is practical to do so, colour shades for primer, intermediate coat and finish coat must be different to identify each coat without any ambiguity.

Paint ingredients shall be kept properly mixed during paint application.

Equipment shall be kept clean to ensure dirt, dried paint and other foreign materials are not deposited in the paint film. Any cleaning solvents left in the equipment shall be completely removed before painting.

To ensure the required film thickness is achieved on angles, welds, sharp external edges, nuts and bolts, a coat shall be applied to such items/locations immediately prior to the application of each coating to the whole area.

Care shall be taken to ensure paint application into all joints and crevices.

The contact surfaces between steelwork to be fastened by means of friction grip bolting shall be abrasive blast cleaned and prime coated only, prior to erection.

4.2.2 Atmospheric conditions

Surface preparation and coating shall not be carried out in inclement weather and shall be carried out such that the surface being coated is free of moisture, wind-borne or blast cleaning dust.

Coatings shall not be applied if:

- The relative humidity exceeds 85%.
- The ambient temperature is less than 5°C (depending on local condition)
- The metal temperature is less than 3°C above the dew point.
- There is likely hood of an unfavourable change in weather conditions within two

hours after painting.

As a general rule, sufficient ventilation, dehumidification and heating capacity to cope with local climatic conditions must be secured before any coating – related work is started.

In any case, humidity, ambient and surface temperature conditions at the time of paint application, and curing and drying time before application of the next coat, shall be in accordance with the paint manufacturer's recommendations. These conditions shall be recorded in the Inspection Test Record (ITR) by the Contractor and be available for review.

4.2.3 Conventional or Airless Spray

Spray equipment shall be equipped with accurate pressure regulators and gauges. Spray gun nozzles and needles shall be those recommended by the paint manufacturer.

Air from the spray gun shall be clean and dry with no traces of oil or moisture.

Coatings shall be wet on contacting the painted surface. Areas of dry spray shall be removed and the correct system re-applied.

4.2.4 Brush Application

The method of "laying-off" shall be suited to the paint specified and shall ensure minimum brush marking.

	APPLICATION OF PAINT & PROTECTIVE COATING		PDIL DOC.NO.	PNMP-TS-0904
			SNC DOC.CODE	
	REV	02	Sheet 12 of 22	

4.2.5 Roller Application

A uniform method of application shall be adopted when painting large areas. The rolling direction shall minimise paint joint build up. Edges and areas subject to possible roller damage shall be brush-painted prior to rolling.

4.2.6 Thickness of Coatings

The maximum thickness DFT in any one application shall not exceed that specified in Technical specifications/ recommended by the paint manufacturer.

Wet film thickness gauges shall be used to make frequent checks on the applied wet film. The Contractor shall maintain at the site of painting operations, a dry film thickness tester of an approved type with a valid current calibration.

Coating thickness checks in accordance with AS 3894 shall be performed, and the Contractor shall undertake remedial action if the measured thickness is less than specified.

Build up of each material to required thickness shall be made prior to the application of the subsequent coat; final film build shall be the minimum specified.

4.2.7 Multiple Coat Applications (Except Wet-On-Wet)

Before successive paint coats are applied, intermediate coats shall be inspected for surface contamination. The presence of any grease or oil, shall be removed by a suitable solvent, and any salt and dirt adhering to the surface shall be removed by scrubbing with a solution of non-toxic detergent (except those prescribed by the manufacturer as "wet-on-wet"). Removal of contaminants shall only be performed after an intermediate coat has had sufficient time to cure.

The surface shall then be pressure hosed or dusted down by brush to disturb and remove deposits not apparent on visual inspection.

Coatings shall be applied only under the following conditions:

- The surface has been cleaned and is dry;
- The manufacturer's stated minimum time for re-coat has elapsed;
- The manufacturer's stated maximum time for re-coat has not elapsed. If the maximum time has elapsed then pre-treatment shall be in accordance with the paint manufacturer's recommendations; and

Damaged areas in preceding coat have been made good in accordance with this Specification.

4.2.8 Protective Coatings for Fasteners

Black and galvanised erection bolts and galvanised holding down bolts used in conjunction with Systems S5 and S8 shall be prepared and painted in accordance with Section 4.4 of this Specification.

Black high tensile bolts shall be painted after erection to the same paint system specification as the surrounding structural steel.

	APPLICATION OF PAINT & PROTECTIVE COATING		PDIL DOC.NO.	PNMP-TS-0904
			SNC DOC.CODE	
	REV	02	Sheet 13 of 22	

4.3 Hot Dip Galvanising

All galvanising shall be carried out by the hot dipping process and conform to the requirements of AS 4680.

All welding slag shall be removed by chipping, wire brushing, flame cleaning or abrasive blast cleaning where necessary.

For temporary identification, either water-soluble marking paints or detachable metal labels shall be used. For permanent identification, figures shall be heavily punched or embossed by the fabricator.

For galvanised items after pickling, the work shall be inspected and any defects that render the work unsuitable for galvanising shall be repaired. After such repairs, the work shall again be cleaned by pickling.

The coating mass of zinc shall be as specified on equipment data sheets and the Drawings, and shall be in accordance with Section 6 of AS 1650. Galvanised coatings shall be tested by the methods described in AS 2331.

After galvanising all material shall be cooled to air temperature in such a manner that no embrittlement occurs.

Galvanised coatings shall be smooth, uniform, adherent and free from stains, surface imperfections and inclusions.

All fixings including nuts, bolts and washers that are required to be galvanised, shall be hot dipped galvanised in accordance with AS 1214 and AS 1252 and all nut threads shall be re-tapped after galvanising and a lubricant applied in accordance with AS 1252. Cold working of galvanised steelwork shall be avoided.

4.4 Damaged or Inaccessible Surfaces

02 4.4.1 Damaged Paint Surface

Repair of damaged painted surfaces, as well as painting of galvanised and black bolts, and galvanised holding down bolts after erection shall comply with this Clause. The treatment shall be:

- Pre-clean the damaged or unpainted areas in accordance with Section 4.2.1 of this Specification;
- Disc or hand sand to clean bright metal;
- Inorganic zinc primers subject to mechanical damage or weld etc shall be power tool cleaned to AS 1627.2;
- Feather backs by sandpapering or whip blasting the original coatings surrounding the damaged area over a 50mm distance. A rough surface shall be obtained on epoxy coatings;
- Clean surface to remove all dust;
- Conduct surface contaminant test in accordance with Section 4.2.2 of this document; and
- Build up a new paint system over the affected area with paints equal to those originally used and having the same dry film thickness for each coat. As an exception, damaged inorganic zinc primers shall be repaired with epoxy organic

	APPLICATION OF PAINT & PROTECTIVE COATING	PDIL DOC.NO.	PNMP-TS-0904
		SNC DOC.CODE	0000-46EG-0001
		REV	02

zinc rich paint to AS 3750.9 **Type 2**, and shall be applied within four hours of blast cleaning. (Refer repair procedures stated for Paint Systems S1 and S10 in Appendix B)

The new coatings shall overlap the original coating over the 50mm prepared distance and shall be colour matched to the specified colour of the original coating.

02 4.4.2 Damaged Galvanised Surfaces

Damaged areas larger than 3mm in diameter, caused by oxy-cutting, welding or physical impact shall be treated as follows:

- Prepare the surface by removing any weld slag followed by vigorous power wire brushing of the coating surrounding the damaged area over a 50mm distance;
- Clean surface to remove all dust; and
- Apply two coats of organic zinc-rich primer conforming to AS 3750.9 **Type 2** to a minimum DFT of 100 microns.

The area to be reinstated shall be colour matched to the surrounding finish colour with 40 microns of aluminium paint to the manufacturer's written instructions.

4.4.3 Inaccessible Surfaces

Surfaces that will be inaccessible after erection of other elements of the structure, shall be fully painted prior to the installation of the obstructing item.

4.5 Surfaces Not To Be Coated

The following surfaces shall not be blasted or coated unless specifically directed:

- Machined surfaces, bearings, seals, grease fittings, adjusting screws and name plates, and identification tags.
- Valve stems;
- Raised faces on pipe and equipment flanges;
- Electrical cabling;
- Instrumentation, gauges and sight glasses;
- Titanium, stainless steel and non-metallic surfaces; and
- Field weld margins, 50mm either side of weld, on tankage and piping, prior welding.

The rear face of piping flanges shall be shop prime coated only. Flange holes for fasteners shall be fully coated

4.6 Touch-Up Painting

Prior to the application of any coat, all damage to the previous coat(s) shall be touched-up. Damage to finished work shall be thoroughly cleaned and re-coated.

Items supplied with the manufacturer's standard coating system shall be touched-up with the same generic coating system or recoated.

	APPLICATION OF PAINT & PROTECTIVE COATING	PDIL DOC.NO.		PNMP-TS-0904
		SNC DOC.CODE		0000-46EG-0001
		REV	02	Sheet 15 of 22

5.0 COATING SYSTEM SELECTION

5.1 Coating Systems for Piping and Equipment

The following Table 1 shall be used as a general guide for the selection of a paint system suitable for a particular plant area application. Paint systems specified on equipment data sheets and the Drawings shall take precedence over the general paint system area applications listed in Table 1.

02 TABLE 1

Ref. No.	Application	Generic Coating System	Minimum DFT	Surface
S1	Uninsulated C.S. to 400 °C where topcoat is NOT required. (to 120 °C if surface is repaired)	Primer: Inorganic ethyl zinc silicate primer to AS 3750.15 Interzinc 86/22 or Equivalent Repair of damaged paint surface: Two component, metallic zinc rich epoxy primer. Interzinc 52 or Equivalent	Primer: 75 micron Repair: 75 micron Total: 75 micron	AS 1627.4 Class 2 ^{1/2} minimum profile 50-70micron
S2	Uninsulated C.S. to 83 °C where topcoat IS required. (intermittent to 120 °C)	Primer: Epoxy zinc phosphate to AS 3750.13. Intergard 251 or Equivalent Finish: Recoat able high-build Epoxy Interseal 670 or Equivalent	Primer: 75 micron Finish Coat: 150 micron Total: 225 micron	AS 1627.4 Class 2 ^{1/2} minimum profile 50-70 micron
S3	Uninsulated C.S. to 260 °C where topcoat IS required.	Primer: Inorganic ethyl zinc silicate primer to AS 3750.15. Interzinc 86/22 or Equivalent Finish: High Temperature Silicone Acrylic Intertherm 875 or Equivalent	Primer: 75 micron 1st Coat: 40 micron 2nd Coat: 40 micron Total: 155 micron	AS 1627.4 Class 2 ^{1/2} minimum profile 50-70micron
S4	Uninsulated C.S. 201 °C to 540 °C where topcoat IS required.	Primer: Inorganic ethyl zinc silicate primer to AS 3750.15. Interzinc 86/22 or Equivalent Finish: Modified Silicone Aluminium 2 coats Intertherm 50 or Equivalent	Primer: 75 micron 1 st Coat: 25 micron 2 nd Coat: 25 micron Total: 120 micron	AS 1627.4 Class 2 ^{1/2} minimum profile 50-70micron
S5	Fireproofed equipment supports (-46 °C to 200 °C)	First Coat: Epoxy Thermal Barrier Coating Intertherm 46 or Equivalent Second Coat : Intumescent Epoxy Fire Proofing Chartek 7 or Equivalent	1 st Coat: ? mm 2 nd Coat ? mm	AS 1627.4 Class 2 ^{1/2} minimum profile 50-70micron
S6	Insulated C.S and S.S. normally to 200 °C, or having cyclic, intermittent or dual operating temperatures up to 230 °C.	Primer: High Temperature Phenolic Epoxy Finish: High Temperature Phenolic Epoxy Intertherm 228 or Equivalent	CS 1 st Coat: 100 micron 2 nd Coat: 100 micron Total: 200 micron SS 1 st Coat: 100 micron	CS = AS 1627.4 Class 2 ^{1/2} minimum profile 50-70micron. SS = Clean in accordance with AS 1627.1. Sweep or brush abrasive clean with non-metallic

	APPLICATION OF PAINT & PROTECTIVE COATING	PDIL DOC.NO.		PNMP-TS-0904
		SNC DOC.CODE		0000-46EG-0001
		REV	02	Sheet 16 of 22

			Total: 100 micron	abrasive to give the appearance of Class 3 abrasive blast.
S8	Insulated S.S. up to 540 °C.	Primer/Finish: Modified Silicone Aluminium Intertherm 50 or Equivalent	1 st Coat: 25 micron 2 nd Coat: 25 micron Total: 50 micron	Clean in accordance with AS 1627.1. Sweep or brush abrasive clean with non-metallic abrasive to give the appearance of Class 3 abrasive blast.
S9	Topcoat over equipment manufacturer's previously painted surface	Primer/Barrier Coat: Surface Tolerant Epoxy Interosseal 670HS or Equivalent Finish: Two pack Polyurethane Interthane 990 or Equivalent	Primer: 125 micron Finish: 60 micron	Clean to AS 1627.1, manual or power tool sand existing coating, bare areas to AS1627.2 Class 3.
S10	Structural Steelwork with operating temperature upto 90° C	Hot Dip Galvanising as per AS 4680		
S11	Penthouse area of Primary Reformer	Primer/Finish Coat : Intertherm 50 or Equivalent (Total 3 Coats)	Total: 75 micron	AS 1627.4 Class 2 1/2 minimum profile 50-70micron

6.0 INSPECTION AND TESTING

The inspection and testing requirements outlined in this section shall be performed for shop and site applied coating systems.

Preference shall be given to manufacturers and applicators that are quality certified to ISO 9001: 2000.

Documentation of coating material manufacturers and applicators shall be to AS 3894, and include daily inspection reports, equipment reports, and shall clearly identify and trace materials supply and testing performed on coated items and areas.

Inspection and Test Plans (ITPs), and quality control procedures used for application of coating systems shall form part of the Method Statement and shall be submitted for approval by the Principal prior to commencement of work.

The applicator shall appoint a certified inspector (to NACE, ACA or approved equivalent) of coatings for inspection and testing of coating systems.

Tests of coated areas and items shall form part of the ITPs and shall include but not be limited to the following:

- Surface contaminant tests in accordance with 4.2.2;
- Surface profile tests to AS 1627.4;
- Coating thickness tests (DFT) to AS3894.3;

	APPLICATION OF PAINT & PROTECTIVE COATING		PDIL DOC.NO.	PNMP-TS-0904
			SNC DOC.CODE	
	REV	02	Sheet 17 of 22	

- Tests for cure of coatings to AS 3894.4;
- Adhesion tests to AS 1580; and
- Continuity testing to AS 3894.1.
- Iron contamination – ISO 8502-1
- Chloride contamination – ISO 8502-2
- Dust Contamination – ISO 8502-3

All Inspection and Test Records (IT Rs) shall be submitted with the Manufacturer's Data Report (MDR) at the conclusion of the job.

Defective coated areas shall be suitably marked for rectification work to be performed in compliance with this specification.

Access shall be granted for inspection of all paint work, and witnessing of test work. This shall not however relieve the Contractor of their own QA/QC responsibilities.

	INSTRUMENT ON VESSEL CHECKING REPORT	ER-0742	
		DOCUMENT NO	REV
		SHEET	OF

JOB NO.

PLANT

VESSEL TAG	P&I	TRIM LINE
------------	-----	-----------

STAND PIPE OR PROLONGED PIPE ARRANGEMENT

INSTRUMENT	CONNECTION SKETCH	NOTE

MATERIAL REQUIRED FROM PIPING

INSTRUMENT	DESCRIPTION	SPECIFICATION	SIZE	MATERIAL	QUANTITY

Performed by Client _____ PDIL _____ Contractor _____	Witnessed by Client _____ PDIL _____ Contractor _____ <div style="display: flex; justify-content: space-between; margin-top: 10px;"> Signature Date </div>
---	---

CONTROL VALVE, MOTORISED VALVE, SOLENOID VALVE ERECTION REPORT	ER-7223	--
	DOCUMENT NO	REV
	SHEET 1 OF 1	

JOB NO.

PLANT

GENERAL					
VALVE		BODY			
CONTROL VALVE	GLOBE	BUTTERFLY	GATE	FLANGED	
MOTORISED VALVE	ANGLE	DISC		WELDED	
SOLENOID VALVE	BALL	PLUG		SCREWED	
ACTUATOR			ACCESSORIES		
PNEUMATIC DIAPHRAGM			POSITIONER	POSITION INDICATOR	
PNEUMATIC PISTON DOUBLE ACTING			LIMIT SWITCH	POSITION TRANS.	
PNEUMATIC PISTON SPRING RETURN			SOLENOID VALVE	QUICK OP/CL RELAY	
HYDRAULIC			HANDWHEEL	CAPACITY TANK	
MOTORISED					
CHECKED ELEMENTS					
CALIBRATION	HANDWHEEL OPERATION	POSITION TRANSMITTER			
INSTALLATION	SHUT DOWN OPENING TIME	LIMIT SWITCH			
	SHUT DOWN CLOSING TIME				
SECONDARY SKETCH			CABLE		
INSTALLATION	LEAKAGE TEST	INSTALLATION	CONTINUITY AND INSULATION		
LIST OF INSTALLED AND CHECKED INSTRUMENTS					
SL. NO	VALVE	LIMIT SWITCH/ SOL VALVE / POS TRANS	LOCATION	SERVICE	NOTE

Performed by <div style="text-align: right; padding-right: 20px;"> Client _____ PDIL _____ Contractor _____ </div>	Witnessed by <div style="text-align: right; padding-right: 20px;"> Client _____ PDIL _____ Contractor _____ Signature _____ Date _____ </div>
--	--

	INSTRUMENT HYDRAULIC TEST / LEAKAGE TEST REPORT	ER-7343	--
		DOCUMENT NO	REV
		SHEET 1 OF 1	

JOB NO.

PLANT

PRIMARY SKETCH HYDRUALIC TEST

AIR SUPPLY LINE LEAKAGE TEST

LEVEL INSTRUMENT HYDRAULIC TEST

SECONDARY PNEUMATIC SYSTEM TEST

TAG INSTRUMENT ADP	MAIN LINE SPC	MAX WORKING PRESS. Kg/cm2	HYDRAULIC TEST PRESSURE Kg/cm2	LEAKAGE TEST PRESS. Kg/cm2	DURATION OF TEST (minutes)	RESULT P=Positive N=Negative	NOTE

<p>Performed by</p> <p style="padding-left: 40px;">Client _____</p> <p style="padding-left: 40px;">PDIL _____</p> <p style="padding-left: 40px;">Contractor _____</p>	<p>Witnessed by</p> <p style="padding-left: 40px;">Client _____</p> <p style="padding-left: 40px;">PDIL _____</p> <p style="padding-left: 40px;">Contractor _____</p> <p style="padding-left: 40px;">Signature _____</p> <p style="padding-left: 40px;">Date _____</p>
---	--

CONTINUITY AND INSULATION RESISTANCE CABLE TESTING REPORT	ER-7332	--
	DOCUMENT NO	REV
	SHEET 1 OF 2	

JOB NO.

PLANT

MULTI CABLE	INTRINSIC SAFE	ARMoured	EXT. SHE. COLOUR					
SINGLE CABLE	NON INTRINSIC SAFE	SHIELED						
PART NUMBER	ARMOUR	SHIELD	SERVICE	COMPOSITION				
INSULATION GR.	RIBBON	GENERAL	SIGNAL	NO. OF WIRE/ PAIR/ TRIAD x SECT.				
	ROUND WIRE	BY PAIR	CONTROL					
	OVAL WIRE	BY TRIAD	EXTENSION SUPPLY					
INSULATION MATERIAL		CONDUCTOR		COMPENSATING CABLE				
WIRE	EXT	RIGID	STRAINED TIN	TYPE : THERMOUCOUPLE :				
Vo/V RAT. VOLT.			1) Cables without shield to test between each conductor and all remaining conductor and armour 2) Cables with general shield to test between each conductor and all remaining conductor, shield and arm 3) Cables shielded by pair or triad to test between each conductor and all remaining conductors in this particular shield and shield+ armour + gen. shield					
TEMPERATURE								
HUMIDITY								
INSULATION RESISTANCE $\geq 100M\Omega/Km$								
1) WIRES $W_N \rightarrow \Sigma W+A$ $W_N \rightarrow \Sigma W+A+S$					W=WIRE P=PAIR T=TRIAD A=ARMOUR GS=GEN. SHIELD S=IND SHIELD			
2) PAIRS GEN SHIELD $P_{N+} \rightarrow \Sigma W+A+S$ $P_{N-} \rightarrow \Sigma W+A+S$								
3) TRIAD $T_{N+} \rightarrow \Sigma W+A+S$ $T_{N-} \rightarrow \Sigma W+A+S$ $T_{NC} \rightarrow \Sigma W+A+S$								
4) PAIRS GEN. SHIELD + INDIVIDUAL SHIELD $P_{N+} \rightarrow P_{N-} +GS+S+A$ $P_{N-} \rightarrow P_{N+} +GS+S+A$								
5) TRIAD GEN. SHIELD + INDIVIDUAL SHIELD $T_{N+} \rightarrow T_{N-} +T_{NC} + GS+S+A$ $T_{N-} \rightarrow T_{N+} +T_{NC} + GS+S+A$ $T_{NC} \rightarrow T_{N+} +T_{N-} + GS+S+A$								
CABLE TAG	L(Km)	M Ω x Km AT 20 degC FOR CASE 1) 2) 3) 4) 5)					TEST	
							P	
							N	
Performed by		Witnessed by						
Client		Client	_____	_____				
PDIL		PDIL	_____	_____				
Contractor		Contractor	_____	_____				
			Signature			Date		

CONTINUITY AND INSULATION RESISTANCE CABLE TESTING REPORT	ER-7332	--
	DOCUMENT NO	REV
	SHEET 2 OF 2	

SIGNAL CABLE		MΩ x Km AT 20 degC FOR CASE 1) 2) 3)												
CABLE		JUNCTION BOX					CABLE		JUNCTION BOX					
TAG	L(m)				TEST		TAG	L(m)				TEST		
		+	-	C	P	N			+	-	C	P	N	

<p>Performed by</p> <p style="padding-left: 40px;">Client _____</p> <p style="padding-left: 40px;">PDIL _____</p> <p style="padding-left: 40px;">Contractor _____</p>	<p>Witnessed by</p> <p style="padding-left: 40px;">Client _____</p> <p style="padding-left: 40px;">PDIL _____</p> <p style="padding-left: 40px;">Contractor _____</p> <p style="padding-left: 80px;">Signature _____</p> <p style="padding-left: 80px;">Date _____</p>
---	--

	CALIBRATION RECORD SHEET TEMPERATURE ELEMENTS	CR-7323	--
		DOCUMENT NO	REV
		SHEET 1 OF 1	

JOB NO.

PLANT

Tag No. _____

Manufacturer / type no. _____

Serial no. _____

Range _____

Accuracy \pm _____

Calibration instruction _____

Calibration standard & serial no. _____

Temperature degC	Resistance / mV Output		Error degC
	Required Ω /mV	Actual Ω /mV	

One measurement shall be made at normal operating temperature

Remarks: _____

Test performed by Client _____ PDIL _____ Contractor _____	Witnessed by Client _____ PDIL _____ Contractor _____ Signature _____ Date _____
---	--

	CALIBRATION RECORD SHEET SWITCHES	CR-7312	--
		DOCUMENT NO	REV
		SHEET 1 OF 1	

JOB NO.

PLANT

Tag No. _____

Manufacturer / type no. _____

Serial no. _____

Full scale _____

Repeatability \pm _____ %F.S.

Dead Band _____ %F.S.

Calibration instruction _____

Calibration standard & serial no. _____

High / low switch _____

	Initial				Final		
	Setting (Process)		Switch		Setting (Process)		Switch
	Actual	Process value	Reading	Accuracy	Actual	Reading	Accuracy
Rising							
Falling							

Remarks: _____

Test performed by Client _____ PDIL _____ Contractor _____	Witnessed by Client _____ PDIL _____ Contractor _____ <div style="display: flex; justify-content: space-between;"> Signature Date </div>
--	---

	CALIBRATION RECORD SHEET TRANSMITTERS, INDICATORS, RECORDERS	CR-7308	--
		DOCUMENT NO	REV
		SHEET 1 OF 1	

JOB NO.

PLANT

Tag No.

Manufacturer / type no.

Serial no.

Range (span)

Accuracy

± _____ %span

Calibration instruction

Elevated / suppressed zero

Calibration standard & serial no.

Initial				Final			
Setting (Process)		Instrument		Setting (Process)		Instrument	
%	Actual	Reading	Accuracy	%	Actual	Reading	Accuracy
0				0			
25				25			
50				50			
75				75			
100				100			
75				75			
50				50			
25				25			
0				0			

Remarks: _____

Test performed by Client _____ PDIL _____ Contractor _____	Witnessed by Client _____ PDIL _____ Contractor _____ Signature _____ Date _____
---	--



**CONTROL VALVE, MOTORISED VALVE,
SOLENOID VALVE
CHECKING / CALIBRATION REPORT**

CR-7223

--

DOCUMENT NO

REV

SHEET 1 OF 1

JOB NO.

PLANT

TAG		ORDER		MANUFACTURER		VENDOR		
MODEL NUMBER		SERIAL NUMBER		SIZE		CONNECTIONS		
				BODY	TRIM	INPUT	OUTPUT	
BODY		ACTUATOR			TRIM			
GLOBE	BUTTERFLY	PNEUMATIC DIAPHRAGM			TYPE	CHARAC.		
ANGLE	BALL	PNEU. PISTON DOUBLE ACTING			SINGLE SEAT	LINEAR		
GATE	PLUG	PNEU. PISTON SPRING RETURN			DOUBLE SEAT	%		
DISC	2 WAY	HYDRAULIC			CONTOUR	QUICK OP.		
3 WAY	4 WAY	MOTORISED			CAGE			
					ASSIMETRIC			
CHARACTERISTIC				ACCESSORIES				
FLUID TEND TO		OPEN	CLOSE	POSITIONER				
FAILURE	VALVE TO POSITION			INPUT RANGE	OUTPUT RANGE	BYPASS		
SIGNAL	OPEN	CLOSE	STEADY			YES		
SUPPLY	OPEN	CLOSE	STEADY	SPLIT RANGE	ACTION DIRECT	REVERSE		
SUPPLY	PNEUMATIC		LIMIT SWITCHES					
	HYDRAULIC		OPEN POSITION		CLOSE POSITION			
	ELECTRIC		TAG	CONTACT	TAG	CONTACT		
SPRING RANGE	BENCH SETTING	LEAKAGE CLASS			OPEN CLOSE		OPEN CLOSE	
SOLENOID VALVE								
SOLENOID VALVE	ENERGISED	DE ENERGISED		TAG		SUPPLY		
VALVE TO	OPEN CLOSE	CLOSE OPEN		2 WAY	3 WAY	4 WAY		
MOTORISED VALVE COMMANDS				POS. TRANSMITTER		POS INDICATOR		
DCS	LOCAL	ESDS		QUICK OP/CL RELAY	BOOSTER RELAY			
CLOSE PB	OPEN PB	SET	OPEN CLOSE	CAPACITY TANK	HANDWHEEL	RUNN.		
		RESET	OPEN CLOSE	IND. CONTROL				
INPUT TO POSITIONER		INPUT TO ACTUATOR		STEAM / INDICATOR POSITION %		VALVE	REQUIRED	ACTUAL
Kg/cm2	%	Kg/cm2	%	VALVE OPENING	VALVE CLOSING	OPENING TIME		
						CLOSING TIME		
	0					LIMIT SWITCH SETTING	REQUIRED	ACTUAL
	25					OPEN POSITION	%	%
	50					CLOSE POSITION	%	%
	75					CHECKED & VERIFIED		
	100					SOLENOID VALVE ACTION MOTORISED VALVE RUNNING FAILURE SIGNAL / SUPPLY POSITION TRANSMITTER		
Performed by				Witnessed by				
Client				Client				
PDIL				PDIL				
Contractor				Contractor				
				Signature		Date		

	CALIBRATION RECORD SHEET SAFETY VALVE	CR-7234	--
		DOCUMENT NO	REV
		SHEET 1 OF 1	

JOB NO.

PLANT

Tag No. _____

Manufacturer / type no. _____

Serial no. _____

Calibration Instruction _____

Calibration standard & serial no. _____

Popping pressure _____

Superimposed back pressure _____

Set pressure _____

Set pressure tolerance _____

Cold set pressure _____

Test results :

Test No.	Reading	Adjustment		Tolerance
		Yes	No	
1				
2				
3				
4				
5				
6				

Notes :

1. Before putting the valve into operation, make sure that the test gag has been removed.
2. Two tests after adjustment shall be made satisfactorily.

Check blowdown ring position (Nos of teeth) _____

Check overpressure ring position (Nos of teeth) _____

Leak test at 90% cold set pressure _____

Remarks: _____

Test performed by Client PDIL Contractor	Witnessed by	
	Client _____	_____
	PDIL _____	_____
	Contractor _____	_____
	Signature	Date

JOB NO. _____

PLANT _____

Type of loop _____

Reference documents

Hook-up diagram Dwg. No. _____

Loop diagram Dwg. No. _____

Primary element type _____ Tag no. _____

Range / set point _____ Zero el/supp _____

Receiver type _____ Tag no. _____

Range / set point _____ Direct / reverse _____

Valve type _____ Tag no. _____

Failure action _____

Function test results :

Range %	Primary element input	Receiver / indicator			Controller output	Valve position		
		Desired	Actual	Error		Desired	Actual	Error
0								
25								
50								
75								
100								
75								
50								
25								
0								

Switches / alarms

Tag no.				
Set point				
Rising test				
Falling test				

Accessories

Solenoid valve -
Limit switches -
Burn out -

Others

Selector relay -
Computer relay -

Connection to other loops _____

Other checks performed / notes _____

Check of erection					Notes
Items checked	Not applicable	Not approved	Approved	See note	
Tapping point					
Primary element					
Impulse lead lines					
Impulse lead lines supports					
Tracing					
Inst. Supports					
Inst. Support painting					
Manifold					
Transmitter mounting					
Switch mounting					
Indicator mounting					
Converter mounting					
Cable and cable gland					
Cable supports					
Junction box					
Air supply tubing					
Signal tubing					
Tubing supports					
Control valve					
Local panel					
Control room panel rear					
Control room panel front					
Annunciator check					
Compliance to spec.					
Calibration checks					
Pressure test					
Leak test					
Function check					
Inspection 3 rd party					
Ready for start up					

Remarks: _____

Test performed by <div style="text-align: right; padding-right: 20px;"> Client _____ PDIL _____ Contractor _____ </div>	Witnessed by <div style="display: flex; justify-content: space-between; padding: 0 20px;"> <div style="text-align: right;"> Client _____ PDIL _____ Contractor _____ </div> <div style="text-align: right;"> _____ _____ _____ Signature Date </div> </div>
--	--

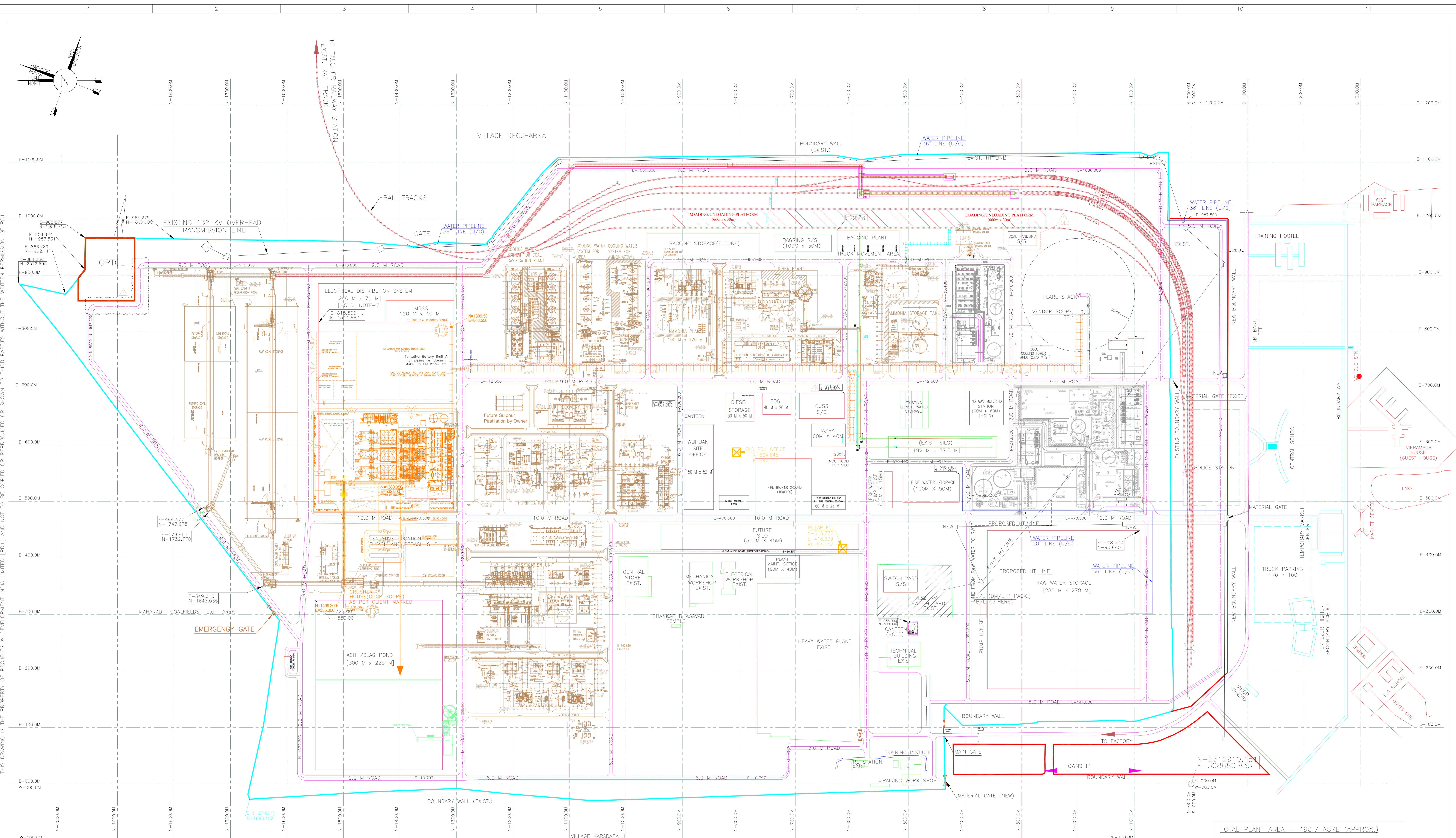

TOTAL PLANT AREA = 490.7 ACRE (APPROX.)
 AREA FOR NEW PLANT = 326.8 ACRE (APPROX.)
 TOTAL GREENBELT AREA = 163.9 ACRE (APPROX.)

- NOTES:-**
- ALL DIMENSIONS AND COORDINATES ARE IN METERS UNLESS OTHERWISE SPECIFIED.
 - REFERENCE BENCH MARK (⊕) POINTS IS W.R.T GLOBAL CO-ORDINATES HAVING N-2312910.151 & E-308680.833 (GRID COORDINATES N=000.00M, E=000.00M)
 - EL. 91.000M CORRESPONDS TO EL. 100.000M.
 - BLOCK SIZE OF FACILITIES ARE TO BE FINALIZED AFTER GETTING VENDOR INFO.
 - IT IS ASSUMED THAT 220 KV EXTERNAL POWER SUPPLY TIE-IN SHALL BE AT THE BOUNDARY WALL CLOSE TO THE LOCATION OF ELECTRICAL DISTRIBUTION SYSTEM BLOCK.
 - * INDICATES HOLD.

- LEGEND ~**
- PLANT BOUNDARY
 - PROPOSED FACILITIES (PDL/TFL)
 - PROPOSED FACILITIES (WUHAN)
 - EXISTING FACILITIES
 - RAILWAY LINE
 - PROPOSED ROAD
 - PROPOSED GREEN BELT
 - PIPE RACK

TABLE-1 LSTK FACILITIES/UNITS OF GASIFICATION PLANT

SL.NO.	BLOCK DESCRIPTION	SIZE IN METRE	REMARKS
1	AIR SEPARATION UNIT	210 M x 150 M	
2	GASIFICATION UNIT	280 M x 110 M	
3	PURIFICATION UNIT	203.7 M x 108 M	
4	SULFUR RECOVERY UNIT	70 M x 50 M	
5	COOLING WATER SYSTEM FOR GASIFICATION PLANT	98.5 M x 161.5 M	
6	INITIAL RAIN WATER BASIN-1	25 M x 38 M	
7	INITIAL RAIN WATER BASIN-2	17.8 M x 33.5 M	
8	COAL WASH WATER PRE-TREATMENT	12.5 M x 46.3 M	
9	ELECTRICAL SUB-STATION FOR GASIFICATION PLANT	71.5 M x 34 M	
10	ELECTRICAL SUB-STATION FOR COOLING WATER	27 M x 36 M	
11	HEAVY WATER PLANT	36 M x 28 M	
12	STEAM GENERATOR	31 M x 28 M	
13	ELECTRICAL SUB-STATION FOR ADS	37 M x 28 M	
14	GENERAL CONTROL BUILDING	40 M x 47 M	
15	RAW COPD STORAGE	90 M x 37.5 M	
16	PETCOKE/SLUDGE STORAGE	90 M x 97 M	
17	LABORATORY BUILDING	501.5 M x 21.5 M	

TABLE-2 LSTK FACILITIES/UNITS OF AMMONIA/UREA PLANT

SL.NO.	BLOCK DESCRIPTION	SIZE IN METRE	REMARKS
1	AMMONIA UNIT	300 M x 100 M	
2	UREA UNIT	156 M x 53 M	
3	COOLING WATER SYSTEM FOR AMMONIA	320.5 M x 135 M	
4	COOLING WATER SYSTEM FOR UREA	59 M x 140 M	
5	COOLING WATER SYSTEM FOR AMMONIA STORAGE	20 M x 27 M	
6	COIL WATER TREATMENT SYSTEM FOR AMMONIA	31 M x 24 M	
7	COIL WATER TREATMENT SYSTEM FOR UREA	59 M x 17 M	
8	ELECTRICAL SUB-STATION FOR AMMONIA & UREA	96.5 M x 28 M	
9	ELECTRICAL SUB-STATION FOR AMMONIA & UREA PLANT	18 M x 48 M	
10	ELECTRICAL SUB-STATION FOR AMMONIA TANK	20 M x 15 M	
11	DIESEL GENERATOR BUILDING	50 M x 38 M	
12	GENERAL CONTROL BUILDING	50 M x 110 M	
13	AMMONIA STORAGE TANK	200 M x 110 M	
14	LABORATORY BUILDING	20.75 M x 21.6 M	

TABLE-3 DSSL (PDL/TFL) FACILITIES/UNITS

SL.NO.	BLOCK DESCRIPTION	SIZE IN METRE	REMARKS
1	DM WATER PLANT	227.5 M	
2	WATER TREATMENT PLANT	-	PACKAGE
3	ETP	-	PACKAGE
4	RAW WATER STORAGE	660 M x 30 M	
5	BAGGING PLANT	110 M x 26 M	
6	COIL COOLING TOWER	227.5 M	
7	LOADING UNLOADING PLATFORM	660 M x 30 M	
8	STEAM GENERATION PLANT	-	PACKAGE
9	ELECTRICAL DISTRIBUTION SYSTEM	240 M x 70 M	
10	DM AIR / PLANT AIR	60 M x 40 M	
11	FIRE WATER STORAGE	100 M x 50 M	
12	FIRE WATER PUMP HOUSE	65 M x 50 M	
13	EDG	40 M x 20 M	
14	DIESEL STORAGE	50 M x 50 M	
15	FIRE BRIGADE BUILDING & FIRE CONTROL STATION	25 M x 40 M	
16	EXISTING SILO	45 M x 300 M	
17	EXISTING SILO	192 M x 37.5 M	
18	PLANT MAINTENANCE OFFICE	60 M x 40 M	
19	TRUCK PARKING AREA	170 M x 100 M	
20	EXISTING SILO	100 M x 40 M	
21	ASH / SLAG POND (ASH POND)	300 M x 225 M	

TABLE-4 DSSL (PDL/TFL) SUBSTATION

SL.NO.	BLOCK DESCRIPTION	SIZE IN METRE	REMARKS
1	SUB-STATION (DM WATER PLANT)	-	EXISTING
2	SUB-STATION (WATER TREATMENT PLANT)	-	EXISTING
3	SUB-STATION (ETP)	-	EXISTING
4	SUB-STATION (BAGGING PLANT)	110 M x 30 M	
5	SUB-STATION (COIL HANDLING)	-	HOLD
6	SUB-STATION (STEAM GENERATION)	-	PACKAGE
7	SUB-STATION (RAW WATER)	-	PACKAGE
8	SUB-STATION (AMMONIA & UREA PLANT)	40 M x 20 M	
9	SUB-STATION (COOLING TOWER-HEC ROOM)	-	PACKAGE
10	SUB-STATION (COOLING TOWER-HEC ROOM)	-	PACKAGE
11	SUB-STATION (COOLING TOWER-HEC ROOM)	-	PACKAGE
12	SUB-STATION (COOLING TOWER-HEC ROOM)	-	PACKAGE
13	SUB-STATION (COOLING TOWER-HEC ROOM)	-	PACKAGE
14	SUB-STATION (COOLING TOWER-HEC ROOM)	-	PACKAGE
15	SUB-STATION (COOLING TOWER-HEC ROOM)	-	PACKAGE
16	SUB-STATION (COOLING TOWER-HEC ROOM)	-	PACKAGE
17	SUB-STATION (COOLING TOWER-HEC ROOM)	-	PACKAGE
18	SUB-STATION (COOLING TOWER-HEC ROOM)	-	PACKAGE
19	SUB-STATION (COOLING TOWER-HEC ROOM)	-	PACKAGE
20	SUB-STATION (COOLING TOWER-HEC ROOM)	-	PACKAGE
21	SUB-STATION (COOLING TOWER-HEC ROOM)	-	PACKAGE
22	SUB-STATION (COOLING TOWER-HEC ROOM)	-	PACKAGE
23	SUB-STATION (COOLING TOWER-HEC ROOM)	-	PACKAGE
24	SUB-STATION (COOLING TOWER-HEC ROOM)	-	PACKAGE
25	SUB-STATION (COOLING TOWER-HEC ROOM)	-	PACKAGE

CLIENT : M/s. TALCHER FERTILIZER LIMITED

PROJECT : INTEGRATED COAL BASED FERTILIZER AND CHEMICAL COMPLEX

TITLE : OVERALL PLOT PLAN

SCALE : 1 : 2200

DRG. No.: PC183-000-001

FILE : PC183-000-001_Rev 1

REV.	DATE	DESCRIPTION	PPD.	CKD.	APPD.
1	28.07.2022	ISSUED	ANIL	RKV/NSY	AMAR
0	15.02.2022	ISSUED FOR COMMENT	SAYED	RKV/NSY	AMAR
P	19.01.21	PRELIMINARY ISSUE	AM	DD/NS	AMAR

SA/RCF/TALCHER/2017/TOPO-DWG

FURNISHED BY CLIENT

DRG. NO. 501

DRG. NO. 635

TFU-M-GN-6341

NUMBERS

THIS DRAWING IS THE PROPERTY OF PROJECTS & DEVELOPMENT INDIA LIMITED (PDIL) AND NOT TO BE COPIED OR REPRODUCED OR SHOWN TO THIRD PARTIES WITHOUT THE WRITTEN PERMISSION OF PDIL.

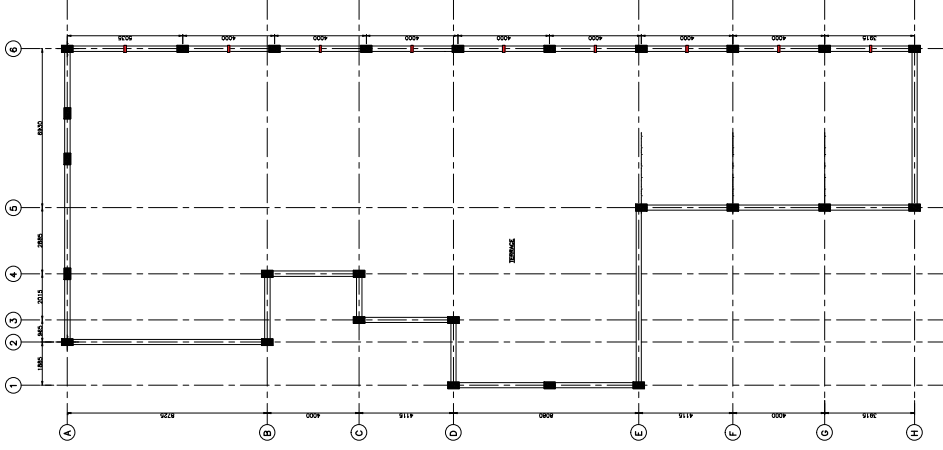
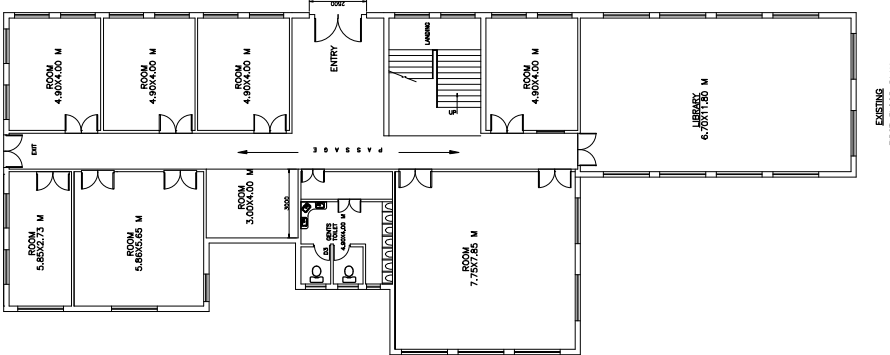
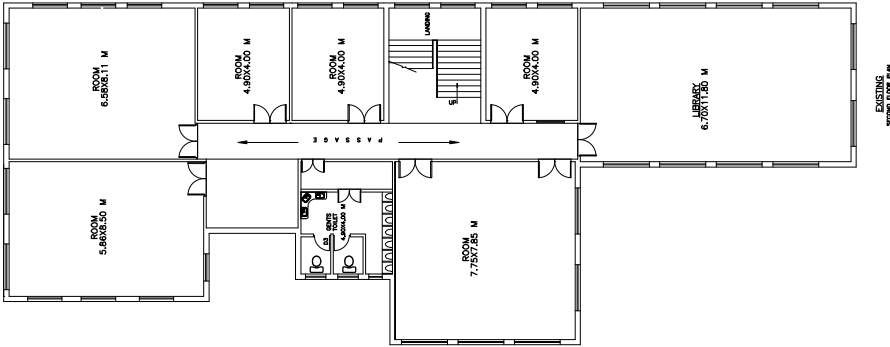
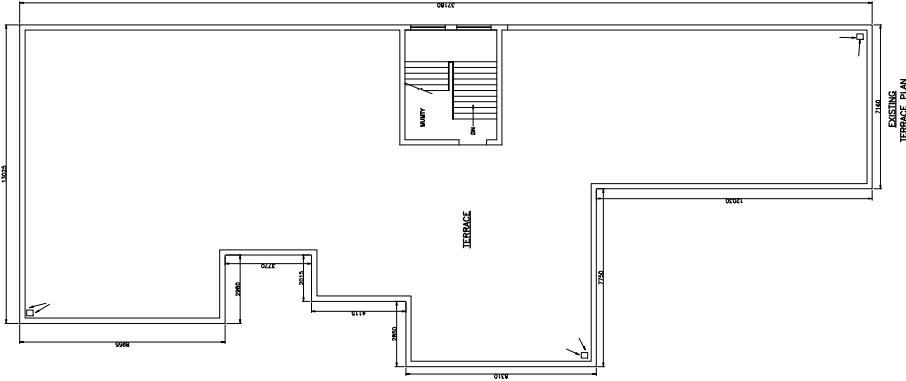

TRAINING CENTRE BUILDING

0	25.10.18	ISSUED FOR TENDER	PG	SS	UPT
REV.	DATE	DESCRIPTION	PPD.	CKD.	APPD.
		CLIENT :	REV.	0	
		M/s. TALCHER FERTILIZER LIMITED	SHEET	1 OF 1	
		LOCATION :	TALCHER, ANGUL DISTRICT, ODISHA(INDIA)	SCALE	1:200
		TITLE :	LAYOUT OF TRAINING CENTRE BUILDING	DRG. No.~	PC/150-0000-XXXX
				FILE	~
				PC/150-0000-XXXX	Rev.0
			PROJECTS & DEVELOPMENT INDIA LTD.		
			Noida		

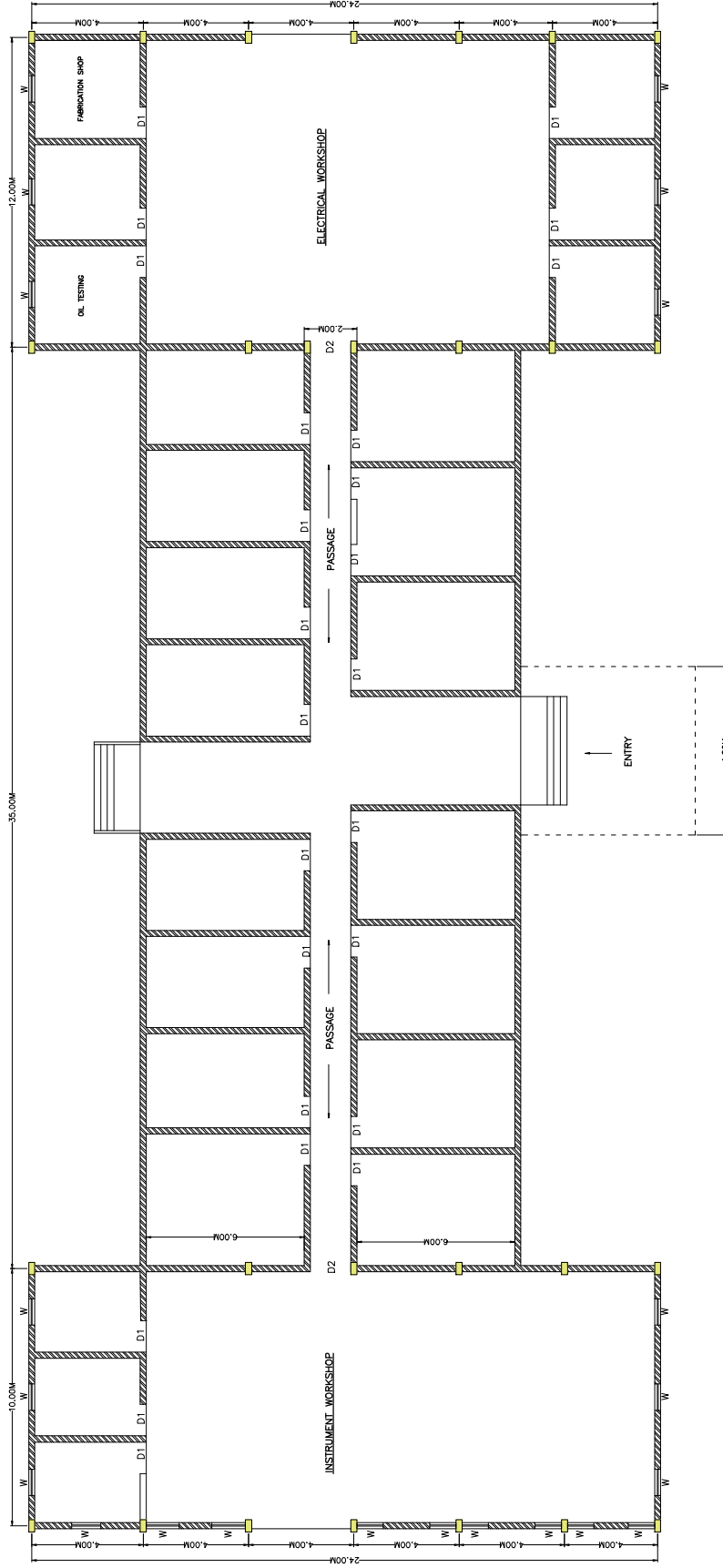

NOTE:-
 1. ALL DIMENSION ARE IN MM AND LEVELS ARE IN M. UNLESS NOTED OTHERWISE.
 2. THE DRAWING SHOULD NOT BE SCALED ONLY FIGURE DIMENSION ARE TO BE FOLLOWED.

ELECTRICAL & INSTRUMENTATION WORKSHOP

NO.	REV.	DATE	DESCRIPTION	PROJ. NO.	ISS. APPR.	DESIGNED FOR	SCALE	SHEET NO.	OF
0	22.01.19		ISSUED FOR TENDER						
CLIENT : M/A. TALCHER PARTULZER LIMITED LOCATION : TALCHER, ANGIUL, DISTRICT, ODISHA(INDIA) SCALE : 1/40 DRG. NO. : ELEC-INT-002 FILE NO. : ELEC-INT-002 TITLE : INSTRUMENTATION BUILDING & INSTRUMENTATION BUILDING									
PROJECTS & DEVELOPMENT INDIA LTD. NOIDA									

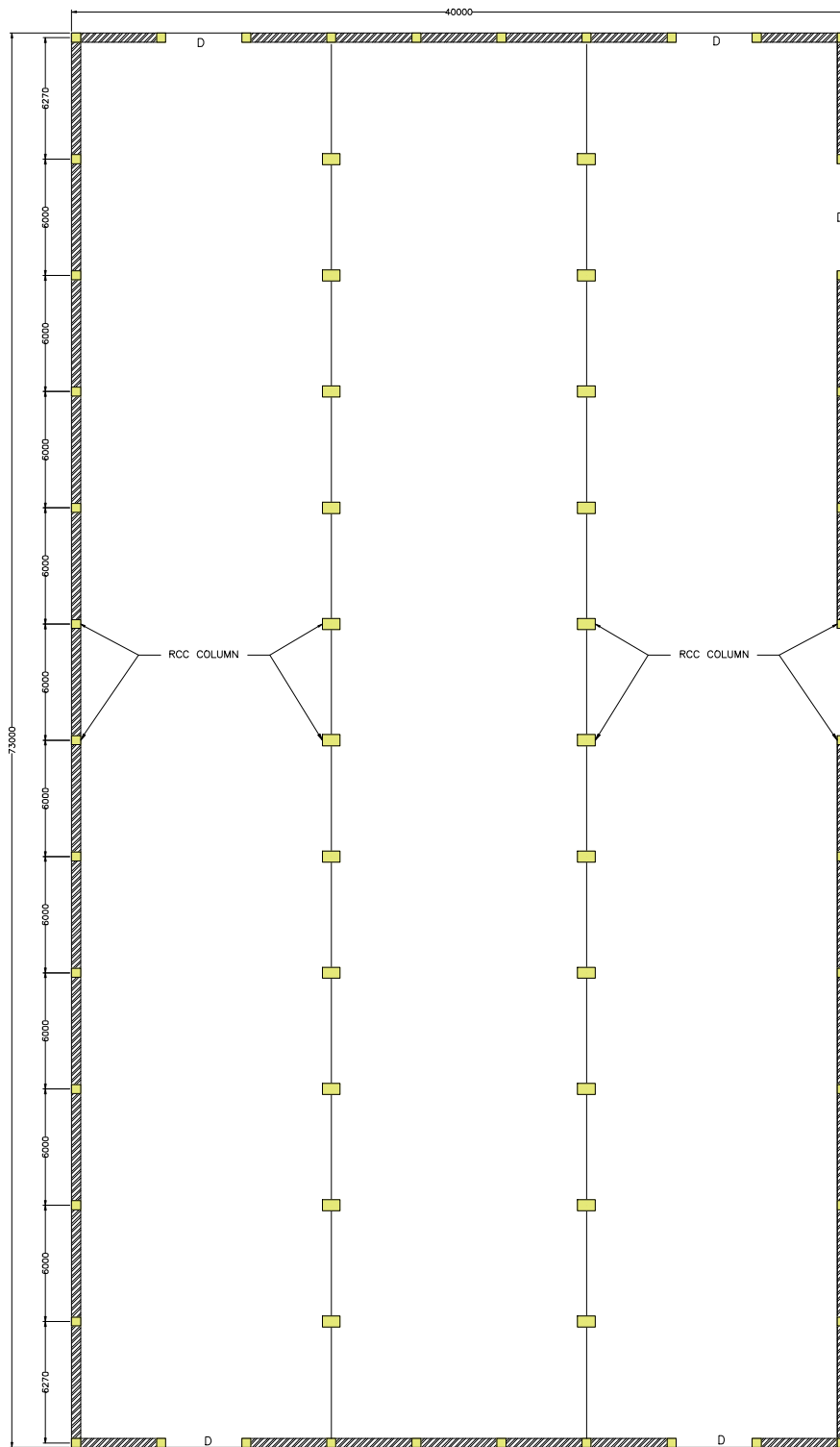

MECHANICAL WORKSHOP

NOTE:-

1. ALL DIMENSION ARE IN MM AND LEVELS ARE IN M. UNLESS NOTED OTHERWISE.
2. THE DRAWING SHOULD NOT BE SCALED, ONLY FIGURE DIMENSION ARE TO BE FOLLOWED.

0	22.01.19	ISSUED FOR TENDER	PG	SS	UPT
REV.	DATE	DESCRIPTION	PPD.	CKD.	APPD.
CLIENT :		M/A. TALCHER FERTILIZER LIMITED	REV.	Q	
LOCATION :		TALCHER, ANGUL DISTRICT, ODISHA(INDIA)	SHEET 1 OF 1		
TITLE :		MECHANICAL WORKSHOP	SCALE :	1:1	
			DRG. No.:	PCI90-PNCY-0003	
			FILE :	PCI90-PNCY-0003	
			PROJECTS & DEVELOPMENT INDIA LTD. NOIDA		

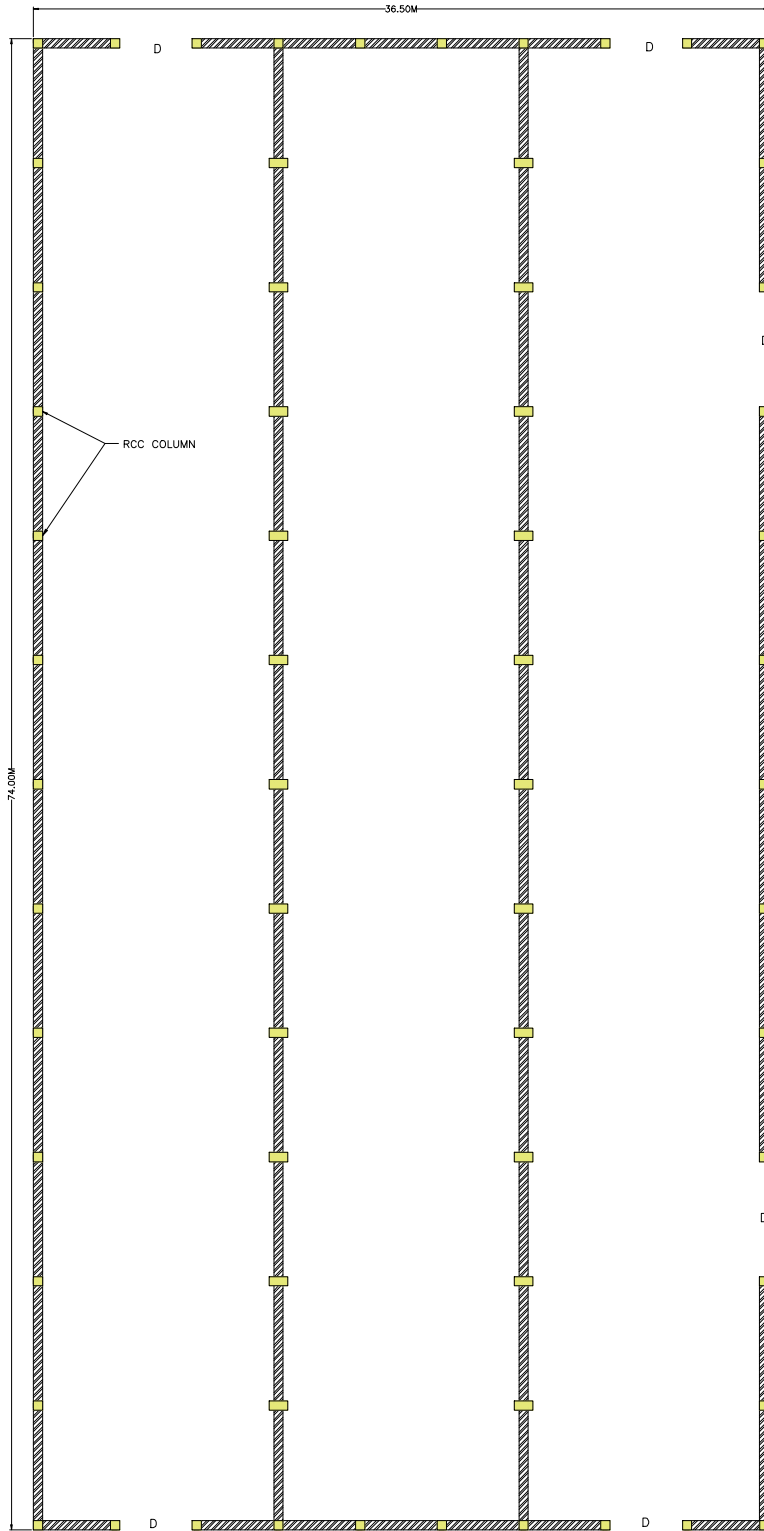

CENTRAL STORE

NOTE:-

1. ALL DIMENSION ARE IN MM AND LEVELS ARE IN M. UNLESS NOTED OTHERWISE.
2. THE DRAWING SHOULD NOT BE SCALED, ONLY FIGURE DIMENSION ARE TO BE FOLLOWED.

0	22.01.19	ISSUED FOR TENDER	PG	SS	UPT
REV.	DATE	DESCRIPTION	PPD.	CKD.	APPD.
CLIENT :		M/A. TALCHER FERTILIZER LIMITED	REV.	Q	
LOCATION :		TALCHER, ANGUL DISTRICT, ODISHA(INDIA)	SHEET 1 OF 1		
TITLE :		TENTATIVE CENTRAL STORE PLAN	SCALE :-		
			DRG. No.:-		
			PCIS0-PNCY-0004		
			FILE :-		
			PCIS0-PNCY-0004		
			PROJECTS & DEVELOPMENT INDIA LTD.		
			NOIDA		

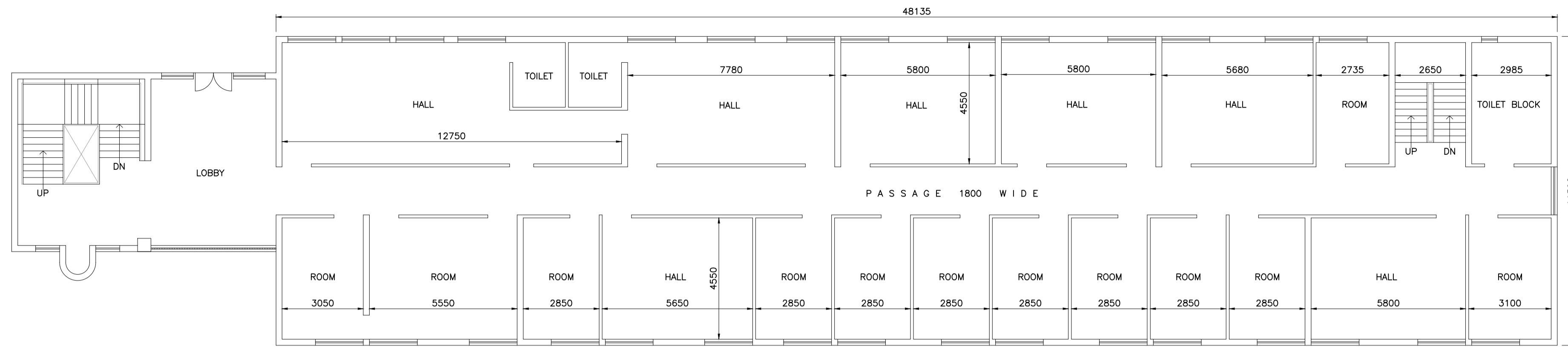

EXISTING SECOND FLOOR PLAN

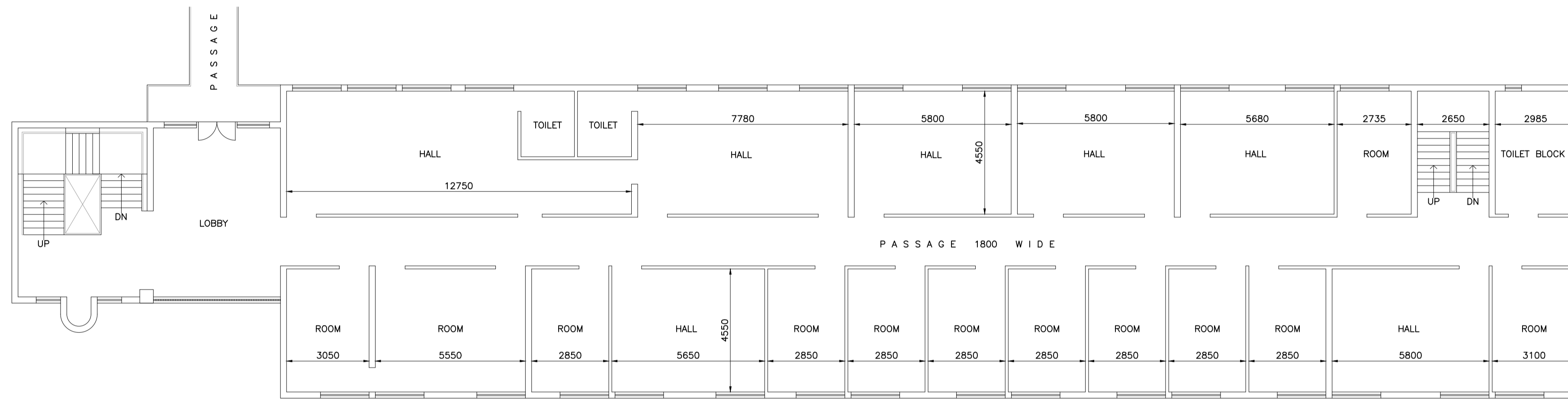

EXISTING FIRST FLOOR PLAN

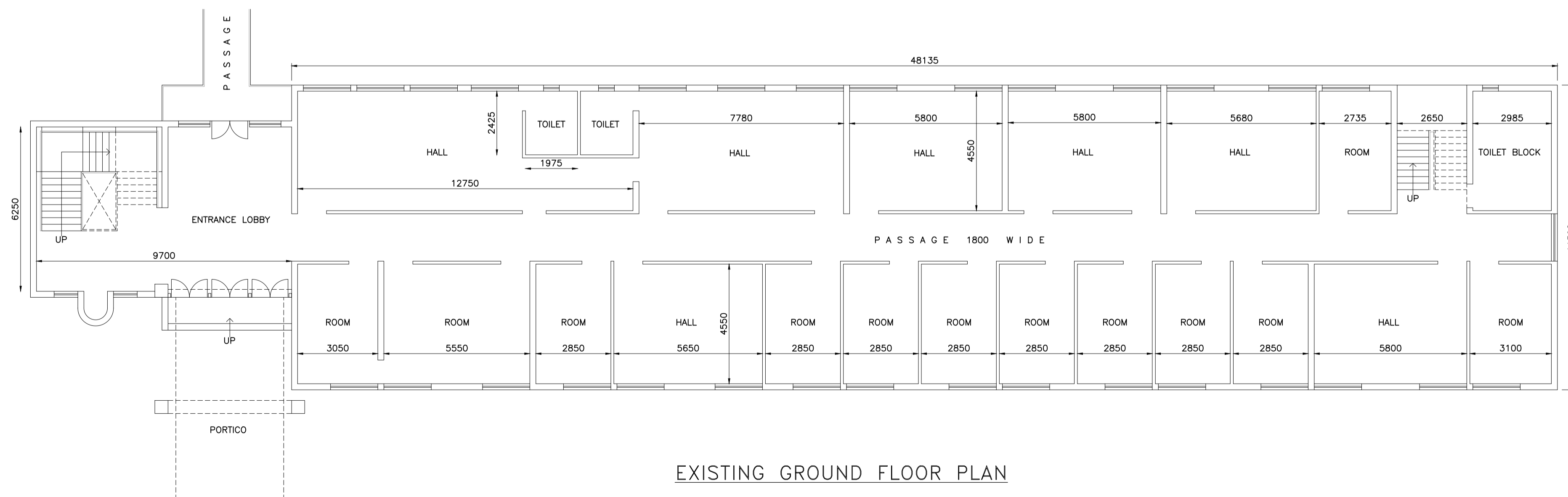

EXISTING GROUND FLOOR PLAN

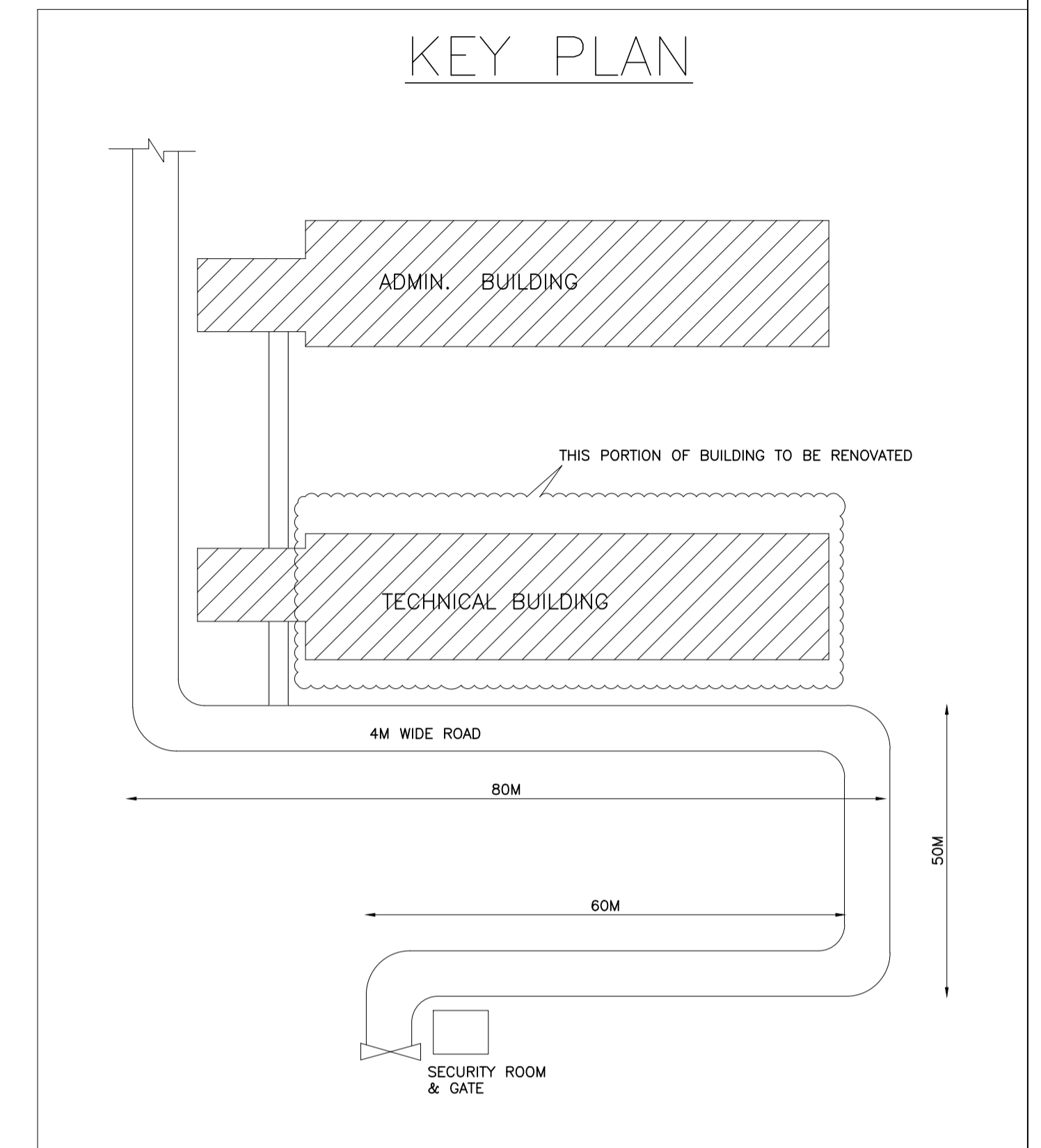

NOTE:-

1. ALL DIMENSION ARE IN MM AND LEVELS ARE IN M. UNLESS NOTED OTHERWISE.
2. THE DRAWING SHOULD NOT BE SCALED, ONLY FIGURE DIMENSION ARE TO BE FOLLOWED.

REV.	DATE	DESCRIPTION	PPD.	CKD.	APPD.
0	22-12-20	ISSUED FOR TENDER	SP	UPT	UPT
CLIENT :			REV. 0		
Talcher Fertilizers			M/s. TALCHER FERTILIZER LIMITED		
LOCATION :			SHEET 1 OF 1		
TALCHER, ANGUL DISTRICT, ODISHA(INDIA)			SCALE :- N.T.S		
TITLE :			DRG. No. :-		
EXISTING TECHNICAL & ADMIN. BUILDING PLAN			PC150-0000-XXXX		
			FILE :-		
			PC150-0000-XXXX		
PROJECTS & DEVELOPMENT INDIA LTD.			Noida		

THIS DRAWING IS THE PROPERTY OF PROJECTS & DEVELOPMENT INDIA LIMITED (PDI) AND NOT TO BE COPIED OR REPRODUCED OR SHOWN TO THIRD PARTIES WITHOUT THE WRITTEN PERMISSION OF PDI.

ANNEXE - C

(SHEET NO.-01)

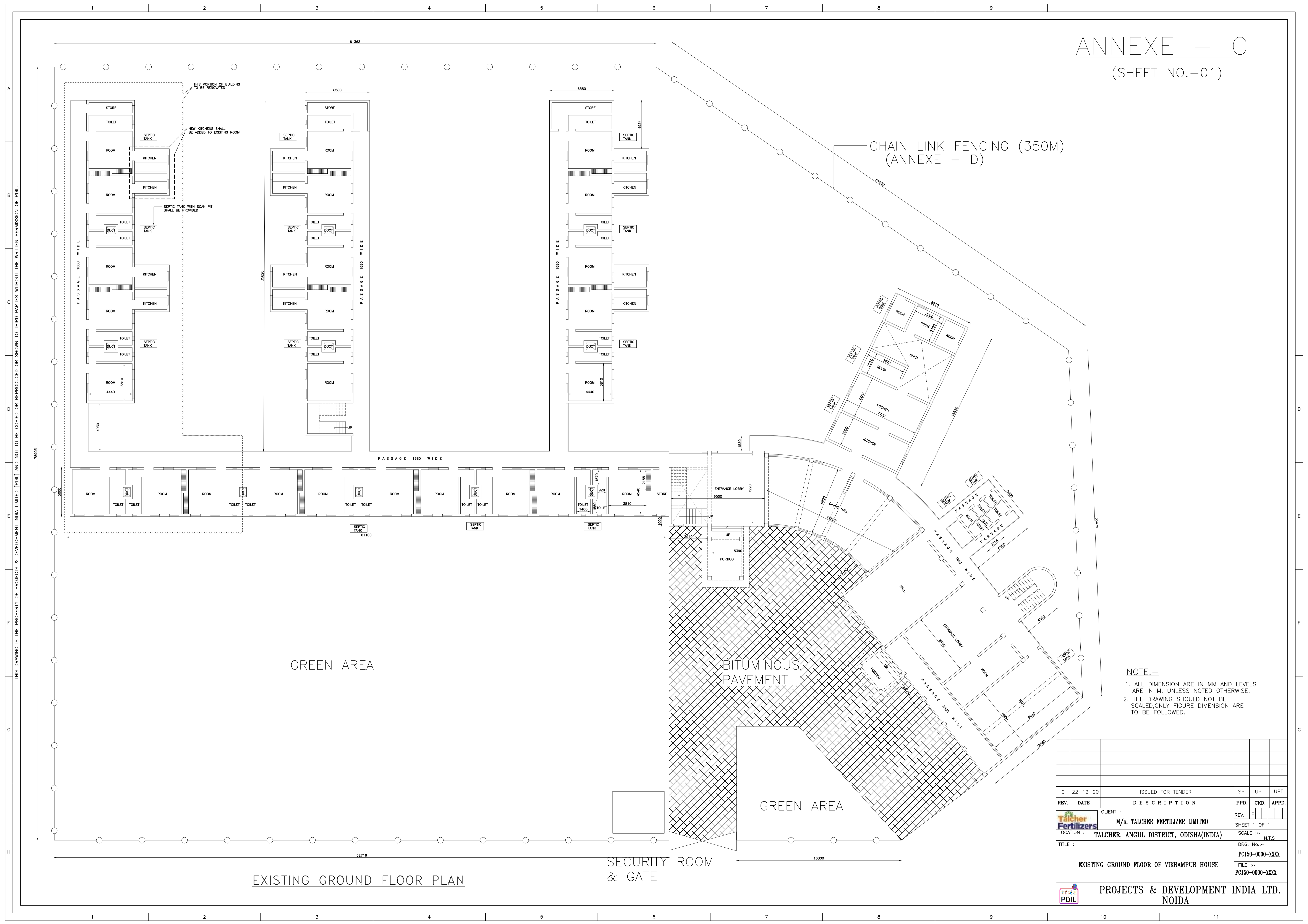

CHAIN LINK FENCING (350M)
(ANNEXE - D)

GREEN AREA

BITUMINOUS PAVEMENT

GREEN AREA

SECURITY ROOM & GATE

EXISTING GROUND FLOOR PLAN

- NOTE:-**
1. ALL DIMENSION ARE IN MM AND LEVELS ARE IN M. UNLESS NOTED OTHERWISE.
 2. THE DRAWING SHOULD NOT BE SCALED, ONLY FIGURE DIMENSION ARE TO BE FOLLOWED.

0	22-12-20	ISSUED FOR TENDER	SP	UPT	UPT
REV.	DATE	DESCRIPTION	PPD.	CKD.	APPD.
0					
CLIENT : M/s. TALCHER FERTILIZER LIMITED			SHEET 1 OF 1		
LOCATION : TALCHER, ANGUL DISTRICT, ODISHA(INDIA)			SCALE :- N.T.S		
TITLE : EXISTING GROUND FLOOR OF VIKRAMPUR HOUSE			DRG. No. :- PC150-0000-XXXX		
			FILE :- PC150-0000-XXXX		
PROJECTS & DEVELOPMENT INDIA LTD. NOIDA					

THIS DRAWING IS THE PROPERTY OF PROJECTS & DEVELOPMENT INDIA LIMITED (PDIL) AND NOT TO BE COPIED OR REPRODUCED OR SHOWN TO THIRD PARTIES WITHOUT THE WRITTEN PERMISSION OF PDIL.

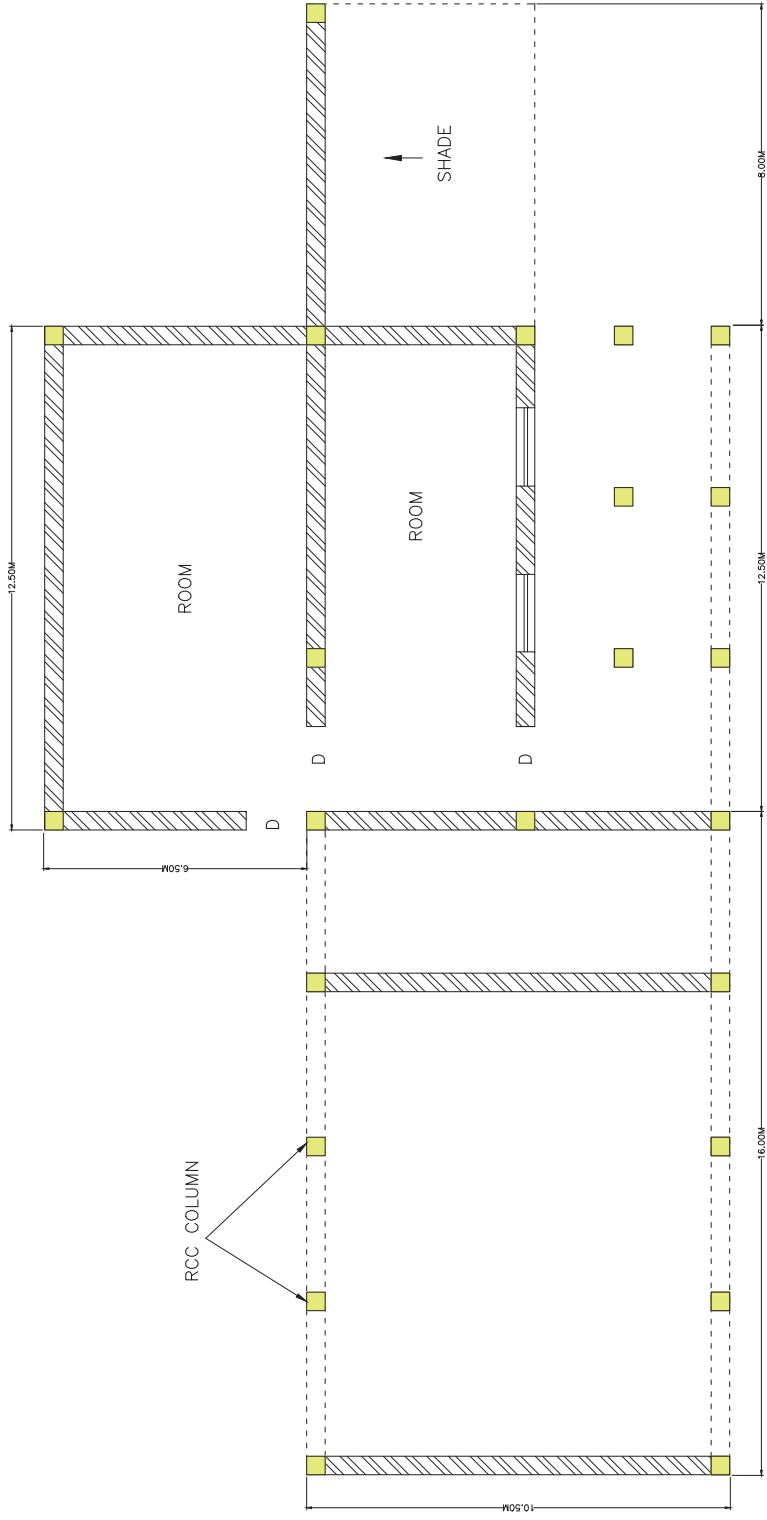

NOTE:—

1. ALL DIMENSION ARE IN MM AND LEVELS ARE IN M. UNLESS NOTED OTHERWISE.
2. THE DRAWING SHOULD NOT BE SCALED ONLY FIGURE DIMENSION ARE TO BE FOLLOWED.

FIRE STATION BUILDING

NO.	22.01.19	ISSUED FOR TENDER	PD	SS	UPD
REV.		DESCRIPTION	PPD	POD	APPD
DATE					
CLIENT	M/A. TALCHER FERTILIZER LIMITED				
LOCATION	TALCHER, ANGUL DISTRICT, ODISHA(INDIA)				
SCALE	SCALE :- N/A				
DRG. NO. :-	PCID-RW-005				
FILE NO. :-	PCID-RW-005				
TENTATIVE PLAN OF FIRE STATION BUILDING					
PROJECTS & DEVELOPMENT INDIA LTD.					
NOIDA					



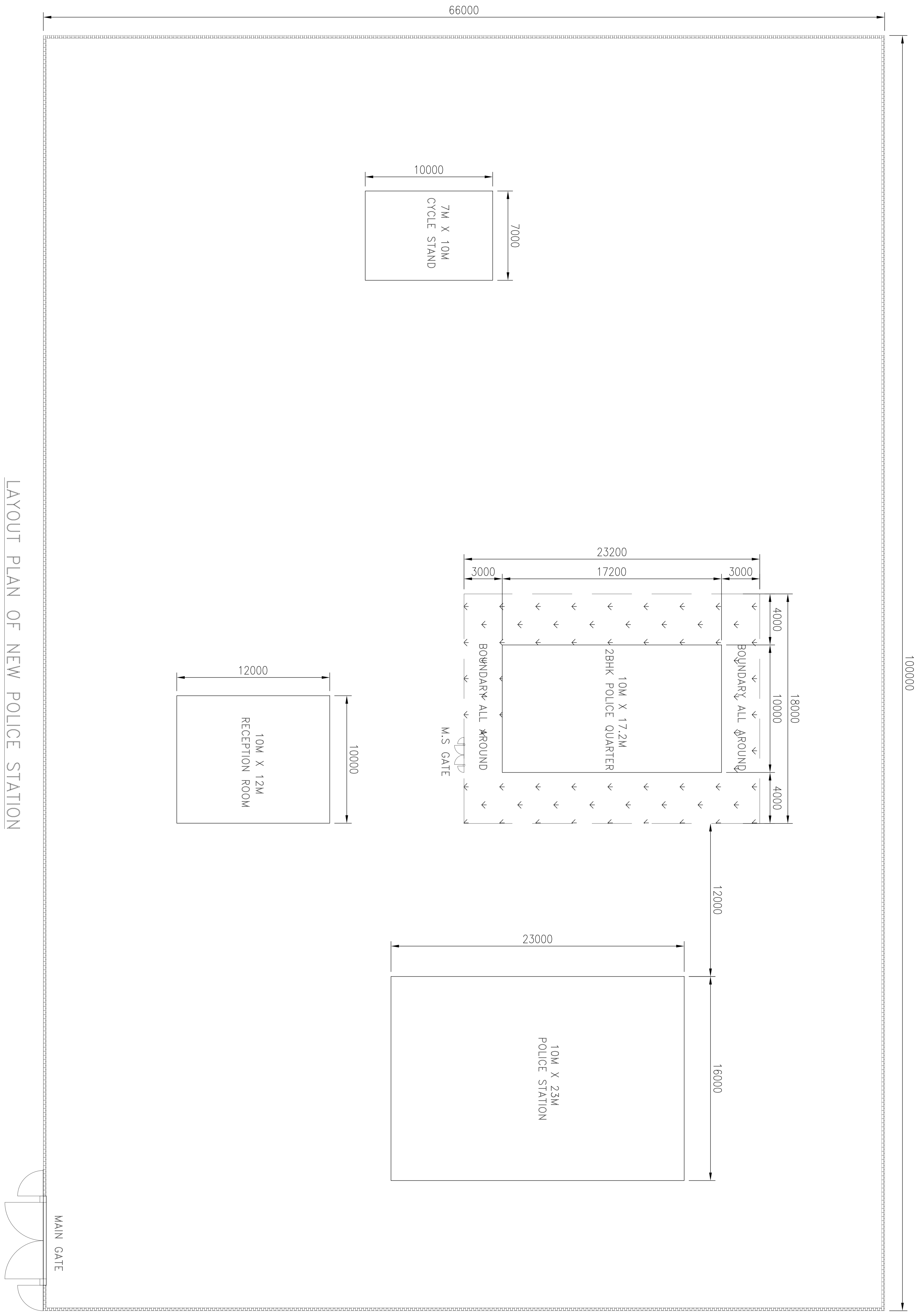

LAYOUT PLAN OF NEW POLICE STATION

REV	DATE	ISSUED FOR TENDER PURPOSE	HS	SS	UPR
P	18.12.20	D E S I G N	PPD	CRD	APPD
CLIENT : M/s. TALCHER FERTILIZER LIMITED					
LOCATION : TALCHER, ANGUL DISTRICT, ODISHA(INDIA)					
SCALE : ~					
SHEET 1 OF 2					
DRG. No. ~					
FILE ~					
PC150-0000-0207					

LAYOUT PLAN FOR NEW POLICE STATION

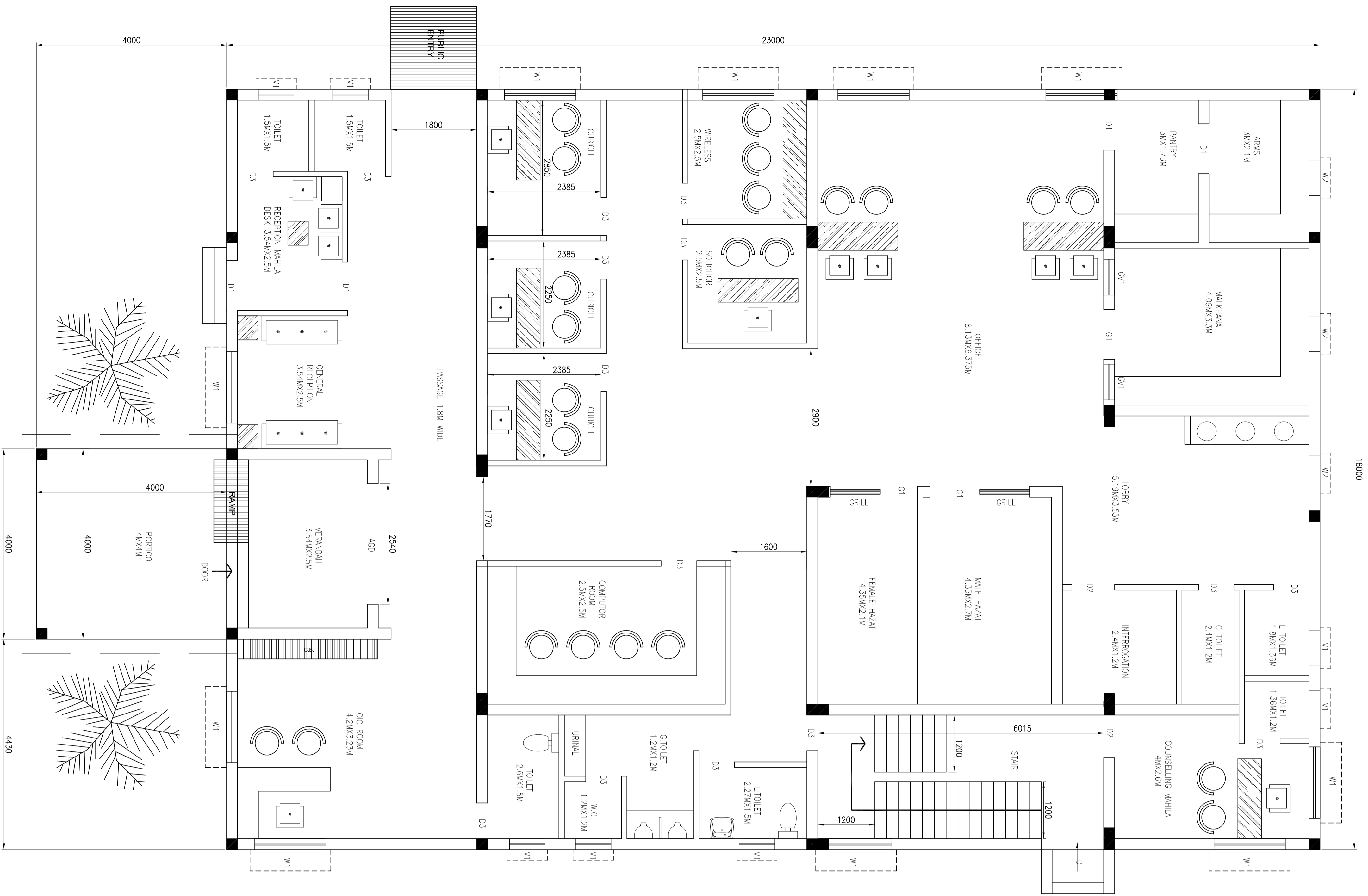

GROUND FLOOR PLAN

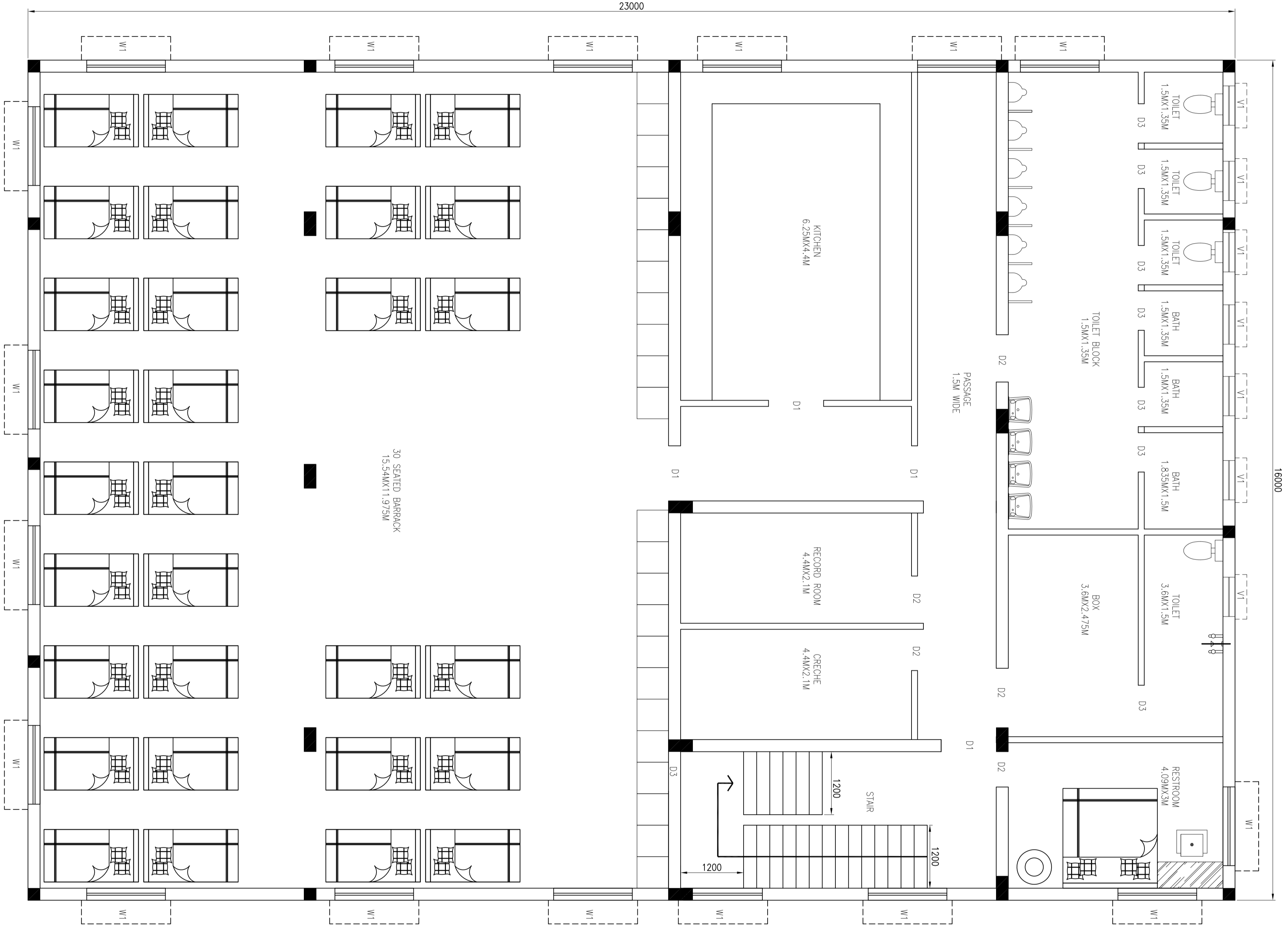

FIRST FLOOR PLAN

ROOF PLAN

SCHEDULE OF DOORS/WINDOWS/VENTILATION			
SYMBOL	DESCRIPTION	SIZE	SPECIFICATION
A00	DOOR	1050X2100	ALUMINIUM GLASS DOOR
D1	DOOR	1050X2100	PANELED DOOR
D2	DOOR	900X2100	PANELED DOOR
D3	DOOR	750X2100	PANELED DOOR
W1	WINDOW	1200X1200	PANELED WINDOW
V1	VENTILATION	800X600	AS PER VENDOR
G1	GRILL DOOR	1050X2100	M.S GRATED 20MM DIA

P	18.12.20	ISSUED FOR TENDER PURPOSE	HS	SS	UPR
REV	DATE	D E S C R I P T I O N	PPD.	CKD.	APPD.
CLIENT :		M/s. TALCHER FERTILIZER LIMITED	REV	P	
LOCATION :		TALCHER, ANGUL DISTRICT, ODISHA(INDIA)	SCALE :	2 OF 2	
TITLE :		LAYOUT PLAN FOR NEW POLICE STATION	DRG. No.~	NIS	
		PROJECTS & DEVELOPMENT INDIA LTD. NOIDA	FILE ~	PC150-0006-0207	
			DRG. No.~	PC150-0000-0207_R1	

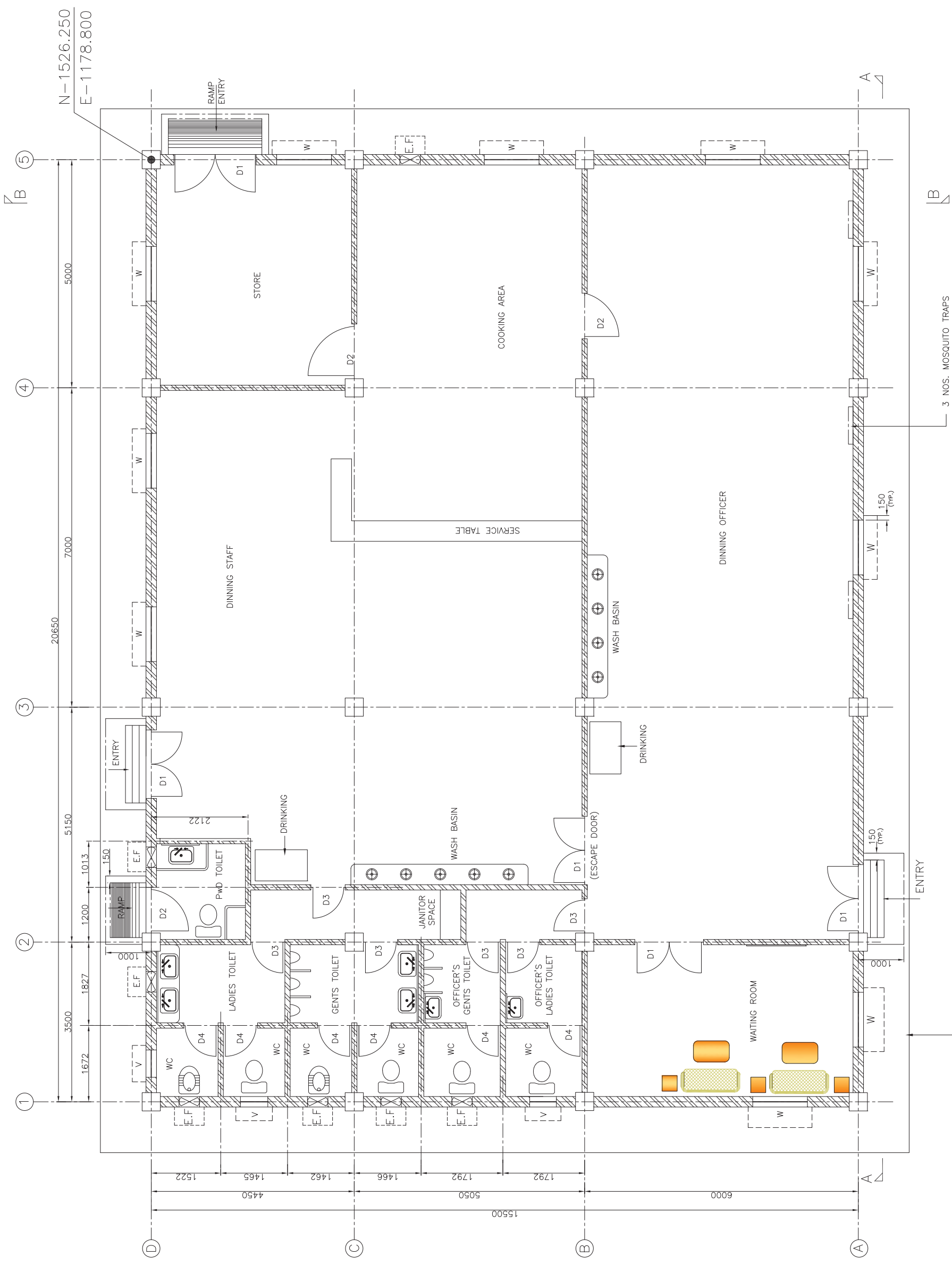
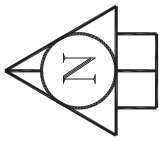

GROUND FLOOR PLAN AT EL. 100.150M LVL.
(SCALE 1:50)

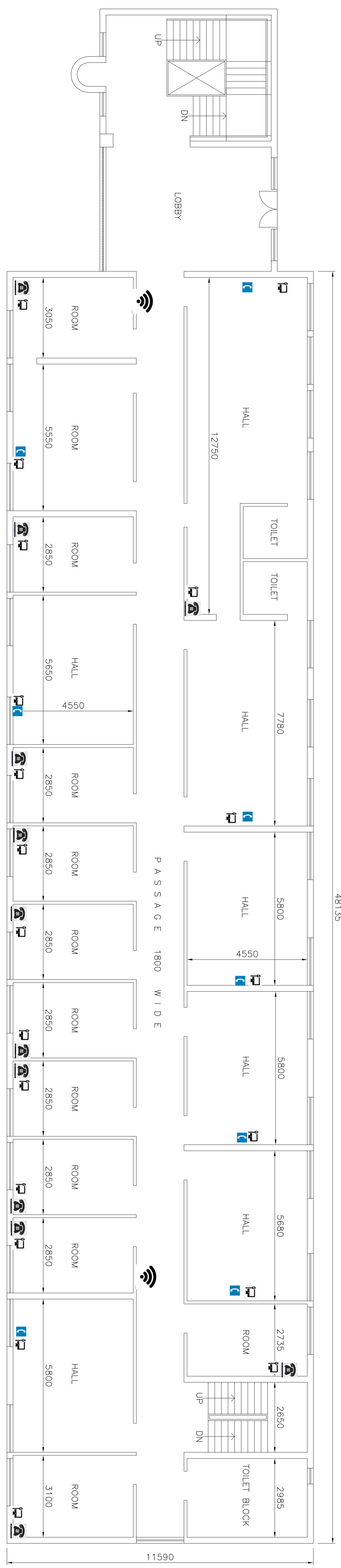

EXISTING SECOND FLOOR PLAN

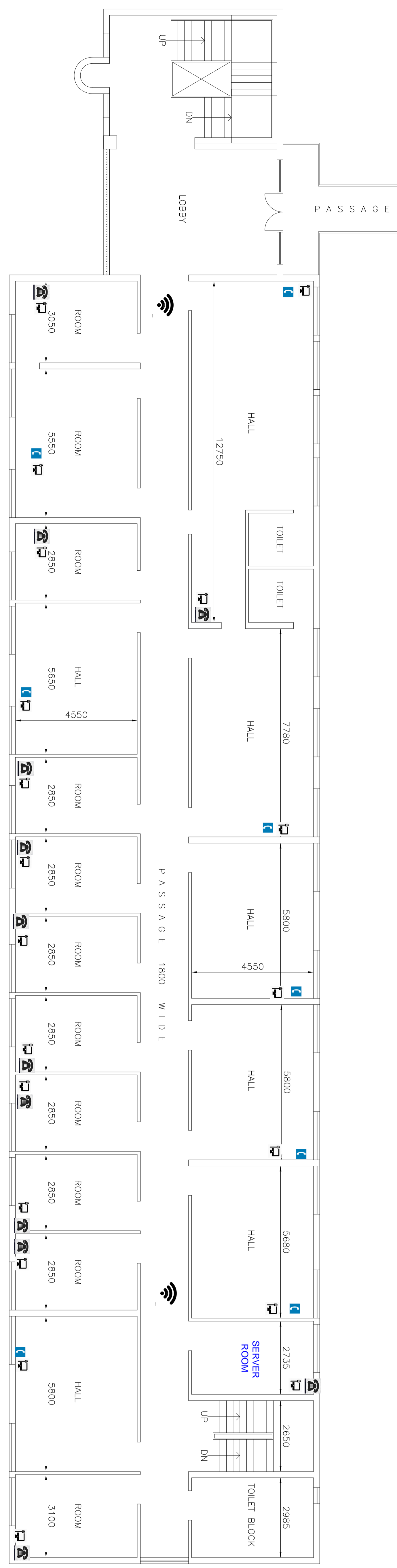

EXISTING FIRST FLOOR PLAN

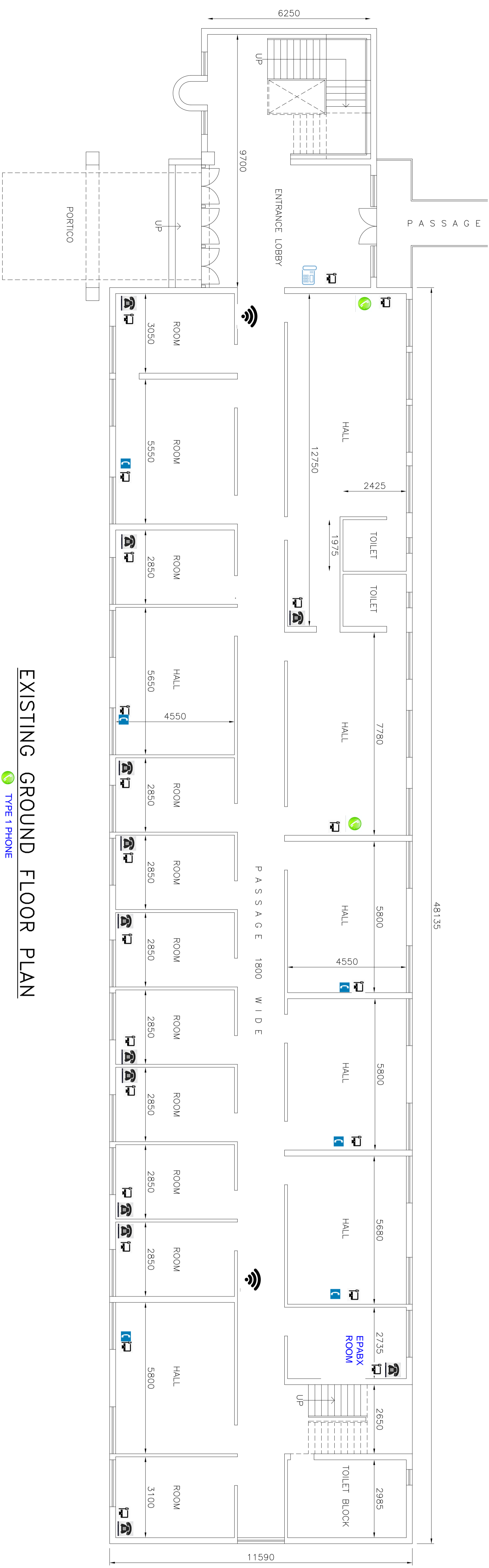

EXISTING GROUND FLOOR PLAN

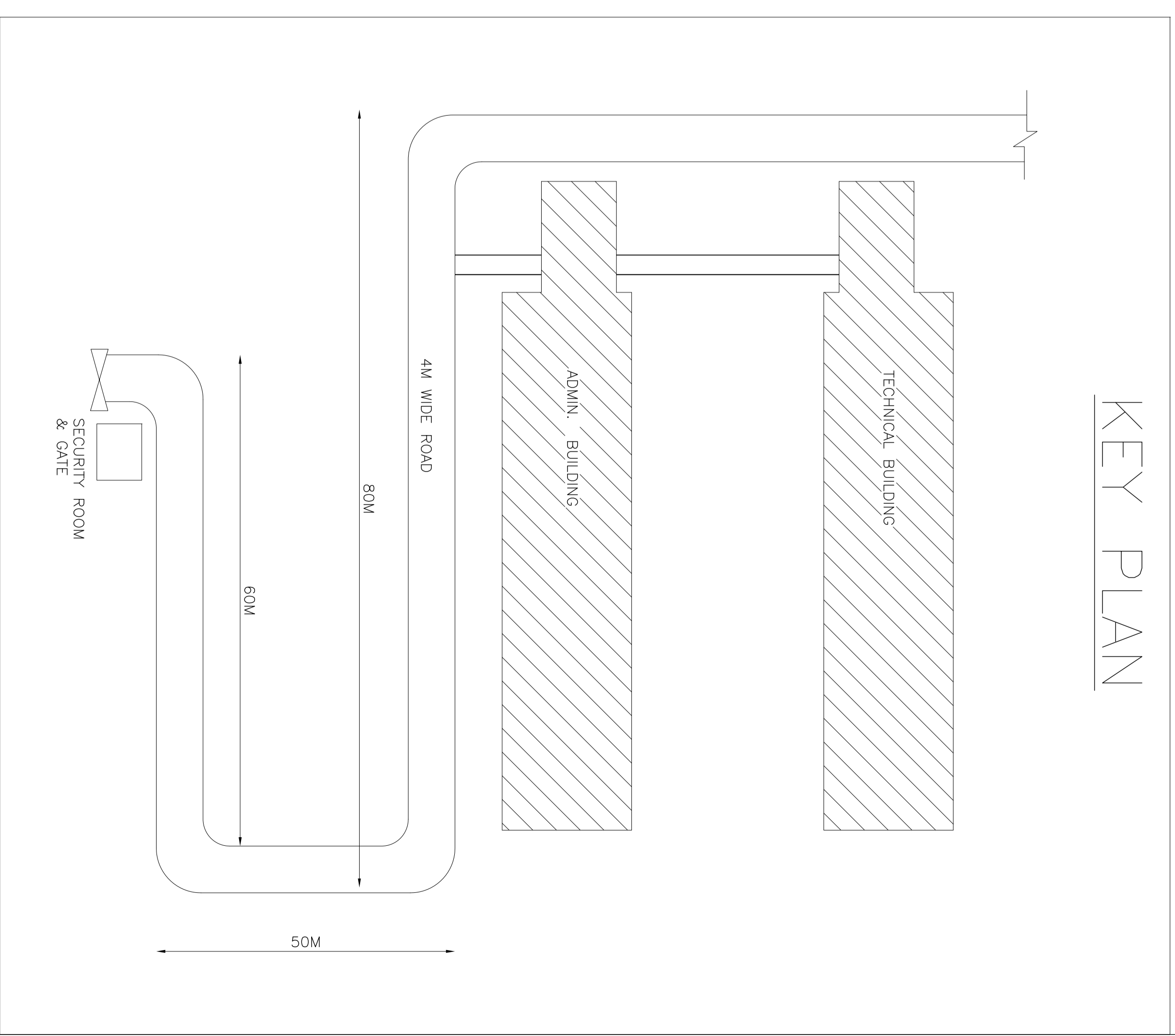

NOTE:-
 1. ALL DIMENSION ARE IN MM AND LEVELS ARE IN M. UNLESS NOTED OTHERWISE.
 2. THE DRAWING SHOULD NOT BE SCALED. ONLY FIGURE DIMENSION ARE TO BE FOLLOWED.

- TYPE 1 PHONE
- TYPE 2 PHONE
- TYPE 3 PHONE
- Wi-Fi router with Min TO user
- Programmable phone for ERPBX

0	18.08.18	ISSUED FOR TENDER	SP	UPT	UPT
REV	DATE	D E S C R I P T I O N	PPH	CMD	APPD
REV	0				
CLIENT :		M/s. TALCHER FERTILIZER LIMITED	SCALE :- N.T.S		
LOCATION :		TALCHER, ANGUL DISTRICT, ODISHA(INDIA)	DRG. No. :-		
TITLE :		EXISTING TECHNICAL & ADMIN. BUILDING PLAN	FILE :- PC150-0000-XXXX		
		PROJECTS & DEVELOPMENT INDIA LTD.	PC150-0000-XXXX		
		NOIDA			

ANNEXE - C

(SHEET NO.-01)

CHAIN LINK FENCING (350M)
(ANNEXE - D)

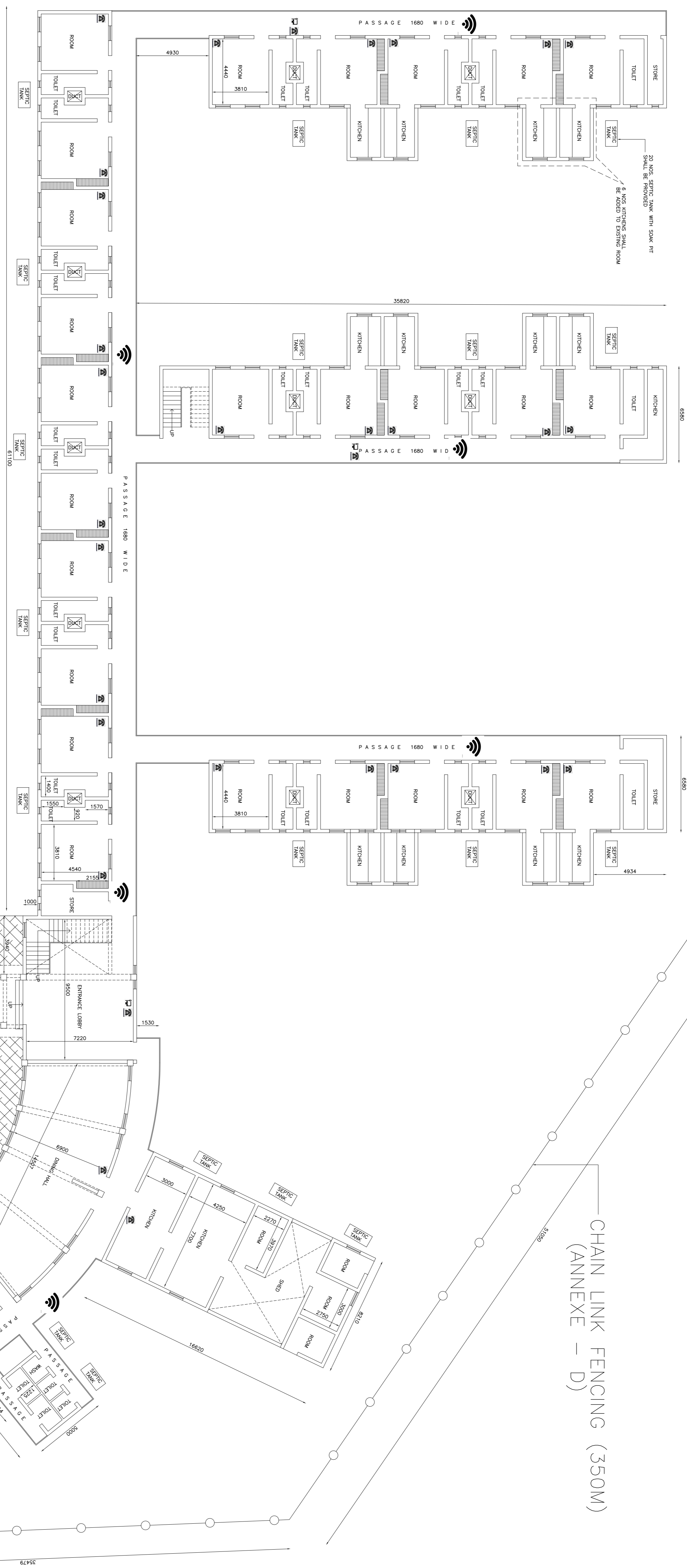

GREEN AREA

BITUMINOUS PAVEMENT

GREEN AREA

SECURITY ROOM & GATE

- NOTE:-**
1. ALL DIMENSION ARE IN MM AND LEVELS ARE IN M. UNLESS NOTED OTHERWISE.
 2. THE DRAWING SHOULD NOT BE SCALED, ONLY FIGURE DIMENSION ARE TO BE FOLLOWED.

ANALOG PHON 32
LAN CONNECTION 09

0	10.08.18	ISSUED FOR TENDER	SP	UPT	UPT
REV.	DATE	DESCRIPTION	PPD.	CKD.	APPD.
CLIENT : M/s. TALCHER FERTILIZER LIMITED			REV.	0	
LOCATION : TALCHER, ANGUL DISTRICT, ODISHA(INDIA)			SCALE : ~	SHEET 1 OF 1	
TITLE : EXISTING GROUND FLOOR OF VIKRAMPUR HOUSE			DWG No.~	PC150-000-XXX	
			FILE : ~	PC150-000-XXX	

EXISTING GROUND FLOOR PLAN

PROJECTS & DEVELOPMENT INDIA LTD.
NOIDA

 पी डी आई एल PDIL	PROJECTS & DEVELOPMENT INDIA LIMITED	PC183/E/8003-S-VI-4.0	0	
		Document No.	Rev	
		Sheet 1 of 2		

SECTION : VI - 4.0

DRAWINGS AND DOCUMENTS

**PLANT : ELECRTICAL & INSTRUMENTATION SUPPLY CUM
ERECTION WORKS**

**PROJECT : INTEGRATED COAL BASED FERTILISER
COMPLEX, AT TALCHER, ANGUL DISTRICT,
ODISHA**



**ELECTRICAL & INSTRUMENTATION
SUPPLY CUM ERECTION WORKS
TALCHER FERTILIZERS LIMITED
DRAWINGS AND DOCUMENTS**

PC183/E/8003-S-VI-4.0

0

Document No.

Rev

Sheet 2 of 2



S. No	Description	With Bid (Y/N)	For Review/ Approval	For Information	Final/ Approved / As-built
	ELECTRICAL				
1.	Specification Sheets and Technical Particulars of Electrical Equipment duly filled in	N	Y	-	Y
2.	Cable schedule (As-built).	N		-	Y
3.	Cable rack / trench / pipe layout (As-built)	N		-	Y
4.	Power Layout (As-built)	N		-	Y
5.	Schematic diagram for all control panel & switch boards.	N	Y	-	Y
6.	GA Drawing of Switchboard, LSDB, LCS, Switch-socket etc.	N	Y	-	Y
7.	Interconnection & Terminal connection diagram (As-built)	N	-		Y
8.	Earthing and lightning protection layout (As-built)	N		-	Y
9.	Lighting layout and Distribution diagram (As-built)	N		-	Y
10.	Drawings and documents asked for each equipment as per respective Technical Specifications	N	Y	-	Y
11.	Catalogues for all bought out items	N	-	Y	Y
12.	Bill of Materials covering all electrical equipment and installation materials (As-built)	N	-	Y	Y
13.	Installation operation and maintenance (Manual)	N	-	-	Y
14.	Spare Parts list	N	-	Y	Y
15.	Test Certificates	N	-	Y	Y
16.	Guarantee Certificates	N	-	Y	Y
17.	Quality Assurance Plan & Formats	N	Y	-	Y
18.	Erection Drawings & Details	N		Y	Y
19.	Construction & Commissioning specification and procedure for all equipment.	N	-	Y	Y
20.	Any other drawings & data as required for satisfactory installation, operation & maintenance.	N	Y	Y	Y



 पी डी आई एल PDIL	PROJECTS & DEVELOPMENT INDIA LIMITED	PC183/E/8003-S-VI-5.0		
		Document No.	Rev	
		Sheet 2 of 14		

SECTION : VI – 5.0

VENDOR LIST



**PLANT : ELECRTICAL & INSTRUMENTATION SUPPLY CUM
ERECTION WORKS**

**PROJECT : INTEGRATED COAL BASED FERTILISER
COMPLEX, AT TALCHER, ANGUL DISTRICT,
ODISHA**



	ELECTRICAL & INSTRUMENTATION SUPPLY CUM ERECTION WORKS TALCHER FERTILIZERS LIMITED VENDOR LIST	Document No.	Rev	
		Sheet 2 of 14		

4.0 ELECTRICAL:



Transformers – 11 kV & Below		
1.	GE T&D India Limited (Formerly known as Alstom T&D Ltd)	India
2.	ABB Power Products and System India Ltd	India
3.	BHEL (ELECTRICAL MACHINES DIVN.)	India
4.	CG Power and Industrial Solution Limited (Formerly known as Crompton Greaves Ltd)	India
5.	Siemens Ltd.	India
6.	Toshiba Transmission & Distribution System India Pvt Ltd	India
7.	Bharat Bijlee Ltd	India
8.	Kirloskar Electric Company Ltd.	India
9.	Voltamp Transformers Ltd.	India
Auxiliary Supply Transformers		
1.	GE T&D India Limited (Formerly known as Alstom T&D Ltd)	India
2.	ABB Limited	India
3.	BHEL (ELECTRICAL MACHINES DIVN.)	India
4.	CG Power and Industrial Solution Limited (Formerly known as Crompton Greaves Ltd)	India
5.	Siemens Ltd.	India
6.	Toshiba Transmission & Distribution System India Pvt Ltd	India
7.	Bharat Bijlee Ltd	India
8.	Kirloskar Electric Company Ltd.	India
9.	Voltamp Transformers Ltd.	India
10.	Esennar Transformers (P) Ltd.	India
11.	Gujarat Plug-In Devices Pvt. Ltd. (Upto 300 KVA)	India
12.	IMP Power Ltd.	India
13.	Indcoil Transformers Pvt. Ltd.	India
14.	Kalpa Electrical Pvt. Ltd.	India
15.	Mehru Electricals (Formerly Automatic Electric Limited)	India
16.	Shephard Transformers Ltd.	India
17.	Vardhman Electro-mech Pvt. Ltd.	India
415 V SWITCH BOARD(PCC/MCC/PMCC)		
1.	Alstom Limited (Areva T & D)	India
2.	GE Power Controls India Pvt. Ltd.	India
3.	Larsen & Toubro Ltd.(EI.Products Divn)	India

	ELECTRICAL & INSTRUMENTATION SUPPLY CUM ERECTION WORKS TALCHER FERTILIZERS LIMITED VENDOR LIST	Document No.	Rev	
		Sheet 3 of 14		



4.	Siemens Ltd.	India
5.	CG Power and Industrial Solution Limited (Formerly known as Crompton Greaves Ltd)	India
6.	Schneider	India
7.	Elecmec Corporation	India
8.	Intrelec	India
9.	Lotus Powergear Pvt Ltd	India
10.	Spaceage Switchgears Limited	India
11.	Venus Controls & Switchgear (P) Ltd.	India
Floor Mounting Type Distribution Boards		
1.	Associated Switchgears & Projects Ltd.	India
2.	Elecmec Corporation	India
3.	GE Power Controls India Pvt. Ltd.	India
4.	Intrelec	India
5.	Jakson Engineers Ltd	India
6.	Larsen & Toubro Ltd.(EI.Products Divn)	India
7.	Lotus Powergear Pvt Ltd	India
8.	Siemens Ltd.	India
9.	Spaceage Switchgears Limited	India
10.	Tricolite Electrical Industries Pvt. Ltd.	India
11.	United Electric Co. (Delhi) Pvt. Ltd	India
12.	Venus Controls & Switchgear (P) Ltd.	India
13.	Schneider	India
Wall Mounting Type Distribution Boards		
1.	Anand Power Limited	India
2.	Associated Switchgears & Projects Ltd.	India
3.	Cosmic Power Systems Pvt. Ltd.	India
4.	Elecmec Corporation	India
5.	GE Power Controls India Pvt. Ltd.	India
6.	Intrelec	India
7.	Larsen & Toubro Ltd.(EI.Products Divn)	India
8.	Lotus Powergear Pvt Ltd	India
9.	Siemens Ltd.	India
10.	Spaceage Switchgears Limited	India
11.	Tricolite Electrical Industries Pvt. Ltd.	India
12.	Trident Switchgears Pvt. Ltd. (Upto 3200 A)	India
13.	United Electric Co. (Delhi) Pvt. Ltd	India
14.	Venus Controls & Switchgear (P) Ltd.	India
15.	Schneider	India
Control & Relay Panel		

	ELECTRICAL & INSTRUMENTATION SUPPLY CUM ERECTION WORKS TALCHER FERTILIZERS LIMITED VENDOR LIST	Document No.	Rev	
		Sheet 4 of 14		



1.	Alstom Limited (Areva T&D)	India
2.	ABB.	India
3.	Elecmec Corporation	India
4.	Larsen & Toubro Ltd. (El. Products Divn)	India
5.	Siemens Ltd.	India
6.	Schneider	India
Protective Relays (other than BMR)		
1.	Alstom Limited (Areva T & D)	India
2.	ABB.	India
3.	Schneider – MICOM Model	India
4.	SEL – Schweitzer Engineering Laboratories	India
5.	Woodward	India
6.	Siemens Ltd.- SIPROTEC Model	India
Air Circuit Breakers (ACB)		
1.	GE Power Controls India Pvt. Ltd.	India
2.	Larsen & Toubro Ltd.(El.Products Divn)	India
3.	Siemens Ltd.	India
4.	ABB	India
5.	Schneider Electric	India
Moulded Case Circuit Breakers (MCCB)		
1.	Crompton Greaves Ltd.	India
2.	GE Power Controls India Pvt. Ltd.	India
3.	Larsen & Toubro Ltd.(El.Products Divn)	India
4.	Siemens Ltd.	India
5.	ABB	India
6.	Schneider Electric	India
Miniature Circuit Breakers (MCB) / RCBO		
1.	Indo Asian Fusegear Ltd	India
2.	Legrand India Ltd	India
3.	S & S Power Switchgear Ltd	India
4.	Standard Electricals Limited	India
5.	Siemens Ltd.	India
6.	ABB	India
7.	Schneider Electric	India
ELCB		
1.	GE Power Controls India Pvt. Ltd.	India

	ELECTRICAL & INSTRUMENTATION SUPPLY CUM ERECTION WORKS TALCHER FERTILIZERS LIMITED VENDOR LIST	Document No.	Rev	
		Sheet 5 of 14		

2.	Havells India Ltd.	India
3.	Indo Asian Fusegear Ltd	India
4.	Legrand India Ltd	India
5.	S & S Power Switchgear Ltd	India
6.	Siemens Ltd.	India
7.	Standard Electricals Limited	India
8.	ABB	India
9.	Schneider Electric	India
Low Voltage Industrial Switches/Isolators		
1.	ABB	India
2.	GE Power Controls India Pvt. Ltd.	India
3.	Havells India Ltd.	India
4.	Kaycee Industries Ltd	India
5.	Larsen & Toubro Ltd.(EI.Products Divn)	India
6.	Siemens Ltd.	India
7.	Schneider Electric	India
Current Transformers (415V)		
1.	Alstom Limited (Areva T & D)	
2.	Anant Powertech	India
3.	Indcoil Transformers Pvt. Ltd.	India
4.	Kappa Electricals	India
5.	Mehru Electricals (Formerly Automatic Electric Limited)	India
6.	Perfect Sales Corporation	India
7.	Siemens Ltd.	India
8.	Silkans	India
9.	Pragati	India
10.	Automatic Electric	India
11.	Rishabh	India
Potential Transformers (415V)		
1.	Alstom Limited (Areva T & D)	India
2.	Indcoil Transformers Pvt. Ltd.	India
3.	Kalpa Electrical Private Limited	India
4.	Kappa Electricals	India
5.	Larsen & Toubro Ltd.(EI. Products Divn)	India
6.	Mehru Electricals (Formerly Automatic Electric Limited)	India
7.	Perfect Sales Corporation	India
8.	Siemens Ltd.	India
Meters		

	ELECTRICAL & INSTRUMENTATION SUPPLY CUM ERECTION WORKS TALCHER FERTILIZERS LIMITED VENDOR LIST	Document No.	Rev	
		Sheet 6 of 14		

1.	Alstom Limited (Areva T & D)	India
2.	IMP Power Ltd.	India
3.	M.B. Control & Systems Pvt. Ltd. (Only For Multifunctional Meter)	India
4.	Meco Instruments	India
5.	Mehru Electricals (Formerly Automatic Electric Limited)	India
6.	Rishabh Instruments Pvt. Ltd.	India
7.	Seahorse Industries Ltd.	India
Multi Function Meter (MFM)		
1	Secure meter Limited	India
2	SEMS	India
3	Larsen & Toubro Ltd.	India
4	SATEC	India
5	Alstom Limited (Areva T & D)	India
6	Siemens Ltd.	India
7	Asea Brown Boveri Ltd.	India
8	Schneider Electric	India
Bus Duct (415 V)		
1.	Associated Switchgears & Projects Ltd.	India
2.	Best & Crompton Engg. Co.	India
3.	C & S Electric Ltd.	India
4.	Intrelec	India
5.	Lotus Powergear Pvt Ltd	India
6.	Spaceage Switchgears Limited	India
7.	United Electric Co. (Delhi) Pvt. Ltd.	India
8.	Venus Controls & Switchgear (P) Ltd.	India
9.	Globe Electrical Industries (MV bus duct)	India
10.	Powergear Ltd.	India
Induction Motors – LV (415 V) (Safe Area)		
1.	ABB	India
2.	Bharat Bijlee Ltd	India
3.	Crompton Greaves Ltd	India
4.	Kirloskar Electric Company Ltd	India
5.	Siemens Ltd	India
6.	Jeumont Industrie	France
7.	Siemens AG, Germany	Germany
8.	Fuji Electric Systems Co. Ltd.	Japan
9.	Mitsubishi Corporation	Japan
10.	Toshiba Corporation	Japan
11.	Asea Brown Boveri	Sweden
12.	General Electric Co.	USA
Industrial Type Sw. Socket & Plug		

	ELECTRICAL & INSTRUMENTATION SUPPLY CUM ERECTION WORKS TALCHER FERTILIZERS LIMITED VENDOR LIST	Document No.	Rev	
		Sheet 7 of 14		

1.	Baliga Lighting Equipments Limited	India
2.	Chloride Power Systems and Solutions Ltd. (formerly CALDYNE)	India
3.	Crompton Greaves Ltd	India
4.	Cyclo Electric Devices & Services Co.	India
5.	Ex-protecta	India
6.	FCG Flameproof Control Gears Pvt. Ltd. (Formerly CEAG Flame	India
7.	FCG Power Industries Ltd	India
8.	Flameproof Equipments Pvt. Ltd.	India
9.	Legrand India Ltd	India
10.	Legrand S.A.	France
11.	BBC-Brown Boveri & Cie AG	Germany
12.	R Stahl Schaltgerate Gmbh	Germany
13.	Weidmuller Ltd.	Germany
14.	CORTEM S.p.A.	Italy
Street/Flood Lighting Fixtures		
1.	Bajaj Electricals Limited	India
2.	Crompton Greaves Ltd	India
3.	Havells India Ltd.	India
4.	Philips India Ltd.	India
5.	Surya Roshni Ltd.	India
6.	Wipro Lighting	India
Hose Proof Industrial Lighting Fixtures		
1.	Bajaj Electricals Limited	India
2.	Crompton Greaves Ltd.	India
3.	Philips India Ltd.	India
4.	Surya Roshni Ltd.	India
5.	Wipro Lighting	India
Air Obstruction Lights (Neon Type)		
1.	Bajaj Electricals Limited	India
2.	Elecab Poysa	India
3.	Wipro Lighting	India
Lighting Poles		
1.	Bharti Exports	India
2.	Metalite Industries	India
3.	Premier Power Products (Calcutta) Pvt. Ltd.	India
4.	Sadhana Engineering Corporation	India
5.	Surya Roshni Ltd.	India



**ELECTRICAL & INSTRUMENTATION
SUPPLY CUM ERECTION WORKS
TALCHER FERTILIZERS LIMITED
VENDOR LIST**



Document No.

Rev



Sheet 8 of 14





Explosion Proof Lighting Fixtures		
1.	Baliga Lighting Equipments Limited	India
2.	Crompton Greaves Ltd	India
3.	Ex-Protecta	
4.	FCG Flameproof Control Gears Pvt. Ltd. (Formerly CEAG Flame)	India
5.	FCG Power Industries Ltd	India
6.	Flameproof Equipments Pvt. Ltd.	India
7.	Flexpro Electricals Pvt. Ltd.	India
HT Power Cables		
1.	Cable Corpn. of India Limited	India
2.	KEC International Ltd. (Formerly RPG Cables Limited)	India
3.	KEI Industries Limited (Upto 33 kV)	India
4.	Ravin Cables Limited	India
5.	Torrent Cables Ltd.	India
6.	Universal Cables Ltd.	India
7.	Uniflex	India
8.	Polycab	India
LT Power Cables		
1.	Cable Corpn. of India Limited	India
2.	Cords Cable Industries Ltd	India
3.	Delton Cables Ltd	India
4.	Finolex Cables Ltd	India
5.	KEC International Ltd. (Formerly RPG Cables Limited)	India
6.	KEI Industries Limited	India
7.	Plaza Cable Industries Limited	India
8.	Ravin Cables Limited	India
9.	Torrent Cables Ltd	India
10.	Universal Cables Ltd.	India
11.	Polycab	India
LT Control Cables (1.1 kV)		
1.	Cable Corpn. of India Limited	India
2.	Cords Cable Industries Ltd	India
3.	Delton Cables Ltd	India
4.	Finolex Cables Ltd	India
5.	KEC International Ltd. (Formerly RPG Cables Limited)	India
6.	KEI Industries Limited	India
7.	Plaza Cable Industries Limited	India
8.	Radiant Cables Pvt. Limited	
9.	Ravin Cables Limited	India

	ELECTRICAL & INSTRUMENTATION SUPPLY CUM ERECTION WORKS TALCHER FERTILIZERS LIMITED VENDOR LIST	Document No.	Rev	
		Sheet 9 of 14		



10.	Torrent Cables Ltd	India
11.	Universal Cables Ltd.	India
12.	Miracle cables	India
13.	Polycab	India
Cables For Earthing		
1.	Advance Cable Technologies (P) Ltd.	India
2.	Delton Cables Ltd	India
3.	Finolex Cables Ltd	India
4.	Gupta Electric & Machinery Stores (GEMSCAB)	India
5.	J K Cables Limited	India
6.	Netco Cable Industries (Pvt.) Ltd.	India
7.	Prestige Cable Industries	India
8.	Shyam Cables Industries	India
9.	Special Cables Pvt. Ltd.	India
10.	T C Communication Pvt Ltd	India
11.	Universal Cables Ltd.	India
Cable Jointing Kits		
1.	Raychem RPG Ltd.	India
Pre-Fabricated Al-Cable Trays		
1.	Globe Electrical Industries	India
2.	Hindustan Vidyut Products	India
3.	Indiana Engg Works Pvt Ltd	India
4.	Indmark Formtech Pvt. Ltd.	India
5.	Jamna Metal Company	India
6.	Kanade Anand Udyog Pvt. Ltd.	India
7.	Maheshwari Electrical Mfrs. (P) Ltd.	India
8.	Metalite Industries	India
9.	Parekh Engineering Company	India
10.	Premier Power Products (Calcutta) Pvt. Ltd.	India
11.	Rukmani Electricals & Components Pvt Ltd	India
12.	Sadhana Engineering Corporation	India
13.	Sree Atreya Enterprises	India
14.	Stealite Engg Co	India
Pre-Fabricated G.I. Cable Trays		
1.	Globe Electrical Industries	India
2.	Indiana Engg Works Pvt Ltd	India
3.	Jamna Metal Company	India
4.	Maheshwari Electrical Mfrs. (P) Ltd.	India
5.	Premier Power Products (Calcutta) Pvt. Ltd.	India

	ELECTRICAL & INSTRUMENTATION SUPPLY CUM ERECTION WORKS TALCHER FERTILIZERS LIMITED VENDOR LIST	Document No.	Rev	
		Sheet 10 of 14		

6.	Rukmani Electricals & Components Pvt Ltd	India
Hose Proof Local Control Station		
1.	Baliga Lighting Equipments Limited	India
2.	Bhartia Industries Ltd. (Divn. Bch)	India
3.	C & S Electric Ltd.	India
4.	Ex-Protecta	
5.	FCG Flameproof Control Gears Pvt. Ltd. (Formerly CEAG Flame)	India
6.	FCG Power Industries Ltd.	India
7.	Flameproof Equipments Pvt. Limited	India
8.	Hotline Switchgear & Controls	India
9.	Power Engg Co	India
Flameproof Items (Switch, Switch Socket, Plugs, Isolators, Junction Box, Local Control Station, Distribution Board)		
1.	Baliga Lighting Equipments Ltd.	India
2.	Ex-Protecta	India
3.	FCG Flameproof Control Gears Pvt. Ltd.(Formerly CEAG Flame)	India
4.	FCG Power Industries Ltd	India
5.	Flameproof Equipments Pvt. Ltd.	India
6.	Flexpro Electricals Pvt. Ltd.	India
7.	Legrand S.A.	France
8.	AEG Telefunken AG	Germany
9.	BBC-Brown Boveri & CIE AG	Germany
10.	R Stahl Schaltgerate GMBH	Germany
11.	Siemens AG, Germany	Germany
12.	Weidmuller Ltd.	Germany
13.	Cortem S.p.A.	Italy
14.	Fuji Electric Systems Co. Ltd.	Japan
15.	Togami Electric Mfg. Company	Japan
16.	Toshiba Corporation	Japan
17.	Asea Brown Boveri	Sweden
18.	Crouse-Hinds (Europe) Ltd.	U.K.
19.	GEC Industrial Control Ltd.	U.K.
20.	M&C Switchgear	U.K.
Hose proof Junction Boxes		
1.	Baliga Lighting Equipments Limited	India
2.	Bhartia Industries Ltd. (Divn. Bch)	India
3.	Ex-protecta	India
4.	FCG Flameproof Control Gears Pvt. Ltd. (Formerly CEAG Flame)	India

	ELECTRICAL & INSTRUMENTATION SUPPLY CUM ERECTION WORKS TALCHER FERTILIZERS LIMITED VENDOR LIST	Document No.	Rev	
		Sheet 11 of 14		

5.	Flameproof Equipments Pvt. Ltd.	India
6.	FCG Power Industries Ltd	India
Capacitors		
1.	BHEL (Electrical Machines Divn.)	India
2.	Crompton Greaves Ltd.	India
3.	Kapsales Electricals Ltd.	India
4.	Shreem Capacitors Pvt. Ltd.	India
5.	Universal Cables Ltd.	India
6.	ABB	India
Earthing & Lightning Protection Material – (Al) Wire/Strip		
1.	Anand Electric Trading Co.	India
2.	C & S Electric Ltd.	India
3.	Indmark Formtech Pvt. Ltd.	India
4.	Jayant Metal Mfg. Co.	India
5.	Premier Power Products (Calcutta) Pvt. Ltd.	India
6.	Jamna Metal Company	India
7.	Mahavir Industrial Corporation	India
8.	Metropolitan Industries	India
9.	Sai Galvanisers & Fabricators Pvt Ltd	India
Earthing & Lightning Protection Material – (GI) Wire/Strip		
1.	Anand Electric Trading Co.	India
2.	Controls & Switchgear Co. Ltd.	India
3.	Jayant Metal Mfg. Co.	India
4.	Indmark Formtech Pvt. Ltd.	India
5.	Premier Power Products (Calcutta) Pvt. Ltd.	India
6.	Jamna Metal Co.	India
7.	Mahavir Industrial Corporation	India
8.	Metropolitan Industries	India
9.	Sai Galvanisers & Fabricators Pvt Ltd	India
10.	Bharti Exports	India
11.	Metalite Industries	India
12.	Rukmani Electricals & Components Pvt Ltd	India
13.	Sadhana Engineering Corporation	India
14.	Stealite Engg Co	India
GI Pipes & Conduits		
1.	Bharti Exports	India
2.	Indian Tube Co. (Tata Div. of Tubes & Pipes)	India
3.	Jindal Pipes Ltd.	India
4.	Meghjyot Enterprises	India
5.	Rukmani Electricals & Components Pvt Ltd	India
6.	Steelcraft	India

	ELECTRICAL & INSTRUMENTATION SUPPLY CUM ERECTION WORKS TALCHER FERTILIZERS LIMITED VENDOR LIST	Document No.	Rev	
		Sheet 12 of 14		

Industrial Cable Gland		
1.	Baliga Lighting Equipments Limited	India
2.	Comet Brass Products	India
3.	Comet Industries	India
4.	Dowell's Electricals	India
5.	Electromac Industries	India
6.	FCG Flameproof Control Gears Pvt. Ltd. (Formerly CEAG Flame	India
7.	Gland-Mech. Industries	India
8.	Industrial products Equipment	India
9.	Power Engg Co	India
10.	Quality & Precision Incl. Equipment	India
11.	S J Metal Industries (Jainson)	India
Cable Lugs		
1.	Dowell's Electricals	India
2.	Forward Engg Industries	India
3.	KSE Electrical Pvt. Ltd.	India
4.	MG Electrica	Indai
5.	Power Engg Co	India
6.	S J Metal Industries (Jainson)	India
7.	Usha Martin Industries Ltd. (Isma Divn)	India
Flameproof Cable Gland		
1.	Baliga Lighting Equipments Limited	India
2.	Comet Brass Products	India
3.	Comet Industries	India
4.	Dowell's Electricals	India
5.	Electromac Industries	India
6.	Ex-Protecta	
7.	FCG Flameproof Control Gears Pvt. Ltd. (Formerly CEAG Flame)	India
8.	FCG Power Industries Ltd	India
9.	Flameproof Equipments Pvt. Ltd.	India
10.	Flexpro Electricals Pvt. Ltd.	India
11.	Industrial Products Equipment	India
12.	Kaysons Techno Equipments Pvt. Ltd.	India
13.	Power Engg Co	India
14.	Prompt Engineering Works	India
15.	Sudhir Switchgears Pvt. Ltd.	India
Explosion Proof Exhaust Fan		
1.	Alstom Limited (Areva T & D)	India
2.	Crompton Greaves Ltd	India
3.	FCG Flameproof Control Gears Pvt. Ltd. (Formerly CEAG Flame)	India
4.	Flameproof Equipments Pvt. Ltd.	India



**ELECTRICAL & INSTRUMENTATION
SUPPLY CUM ERECTION WORKS
TALCHER FERTILIZERS LIMITED
VENDOR LIST**

Document No.

Rev

Sheet 13 of 14



Fuse		
1.	Larsen & Toubro Ltd. (El. Products Divn.)	India
2.	Siemens Ltd.	India
3.	Alstom Power	India
4.	Havells India Ltd.	India

Contactors / Relay /		
1.	Larsen & Toubro Ltd. (El. Products Divn.)	India
2.	Siemens Ltd.	India

Timer		
1.	ABB	India
2.	Alstom Power	India
3.	Bhartia Cutler Hammer	India
4.	Siemens Ltd	India

Control Switches		
1.	Alstom Power	India
2.	Siemens Ltd.	India
3.	Kaycee	India
4.	Larsen & Toubro Ltd. (El. Products Divn.)	India

Push Buttons		
1.	Alstom Power	India
2.	Larsen & Toubro Ltd. (El. Products Divn.)	India
3.	Siemens Ltd.	India
4.	Tecnik	India
5.	Tulsi	India

Signal Lamps		
1.	Alstom Power	India
2.	Binoy	India
3.	Larsen & Toubro Ltd. (El. Products Divn.)	India
4.	Siemens Ltd.	India
5.	Tulsi	India

Terminal Blocks		
1.	Connectwell	India
2.	Elmex	India
3.	Larsen & Toubro Ltd. (El. Products Divn.)	India
4.	Siemens Ltd.	India



**ELECTRICAL & INSTRUMENTATION
SUPPLY CUM ERECTION WORKS
TALCHER FERTILIZERS LIMITED
VENDOR LIST**

Document No.

Rev

Sheet 14 of 14



Programmable Logic Controller		
1.	Rockwell Automation India Pvt. Ltd.	India
2.	Siemens Ltd.	India
3.	ABB	India
Optical Fiber Cable		
1.	Finolex	India
2.	DLink	India
3.	Molex	India
4.	Lucent	India
5.	Ericson	India
6.	Sterlite	India
7.	HFCL	India
8.	OPTEL	India
9.		
Transducer		
1.	Crompton	UK
2.	Elster (ABB)	India
HDPE Pipe		
1.	Astral	India
2.	Reliance Industries 'RELPIPE	India
3.	APOLLO	India
4.	Cliamx Synthesis	India

	PROJECTS & DEVELOPMENT INDIA LIMITED	PC0183/8003/SEC VI/5.0	0	
		Document No.	Rev	
		Sheet 1 of 19		

SECTION-VI-5.0

VENDOR LIST-INSTRUMENTATION

**PROJECT: INTEGRATED COAL BASED FERTILIZER COMPLEX
AT TALCHER, ANGUL, DISTRICT- ODISHA, INDIA**

0	07.03.2023	07.03.2023	Issued for Tender	SG	SG	RKR
P	14.09.2022	14.09.2022	Issued for Tender	SG	HS	SKT
REV	REV DATE	EFF DATE	PURPOSE	PREPD	REVWD	APPD



	VENDOR LIST	PC0183/8003/SEC VI/5.0	0	
		Document No.	Rev	
		Sheet 2 OF 18		

1.0 INSTRUMENTATION:

Sl.No	Vendor's Name	Country
Gas Analysers (IR, Thermal Conductivity, Paramagnetic)		
1.	ABB Ltd (BU – Analytical &Adv)	India
2.	Chemtrols Industries Limited (Maihak Make)	India
3.	Emerson Process Management (I) Pvt. Ltd	India
4.	Endress+ Hauser (India) pvt. Ltd.	India
5	Yokagawa	India
6	Ametek ,INC	U.S.A
7	Emerson Process Mgt Singapore Ltd.	Singapore
8	MaihakAktiengesellschaft	Germany
9	M.S.A International	U.S.A
10	Siemens AG	Germany
Sodium Analyser		
1.	ABB	
2.	HACH	
3.	THERMOFISHER	
4.	WALTRON	
5.	AWA	
Chlorine Analyser		
1.	ABB	INDIA
2.	HACH	FRANCE
3.	KROHNE	U.K
4.	E&H	
5	WALTRON	
6	THERMOFISHER	
Turbidity Analyser		
1.	HACH	
2.	YOKOGAWA	JAPAN
SDI Analyser		
1.	RODI	USA
pH, conductivity & ORP Analyser		
1.	ABB India Limited	India
2.	BELA INSTRUMENTS (For Knick, GmbH make), Mumbai(For ConductivityAnalyser)	India
3	Chemtrols Industries Limited	India
4	Emerson Process Management (I) Pvt. Ltd	India
5	Endress+ Hauser (India) pvt. Ltd. (Liquid Analyser)	India
6	Forbes polymetron Pvt. Ltd.	India
7	POTENCE CONTROLS (for GLI International make), Mumbai.(For ConductivityAnalyser)	India
8	Yokogawa India Ltd.	India
9	Emerson Process Mgt Singapore Ltd.	Singapore
10	Foxbro Far East PTE Ltd.	Singapore
11	Hach Company	U.S.A
12	Yokogawa Electric Corporation	Japan
13	Zellweger SA	France
Trace Analyser/ Ion Selective		
1.	ABB India Limited	India

	VENDOR LIST	PC0183/8003/SEC VI/5.0	0	
		Document No.	Rev	
		Sheet 3 OF 18		

2	Chemtrols Industries Limited	India
3	Forbes Polymetron Pvt. Ltd	India
4	Bran & Luebbe Ltd	U.K
5	Hach company	U.S.A
6	Zellweger SA	France
PC / SERVERS		
1.	DELL	INDIA
Fire alarm System		
1.	HONEYWELL	INDIA
2	SIEMENS	INDIA
SO_x/ NO_x Analyser		
1.	ABB India Ltd.	India
2.	Chemtrols Industries Limited	India
3.	Emerson Process Management (I) Pvt. Ltd	India
4.	Yokogawa India Ltd.	India
5.	Emerson Process Management Singapore Ltd	Singapore
6.	Horiba Ltd.	Japan
7.	Lear Siegler Meas. Controls Corp.	U.S.A
8.	M.S.A International	U.S.A
9.	Sick AG	Germany
10.	Siemens AG	Germany
11.	Thermo Environment Instruments Inc	U.S.A
12	Yokogawa Electric Corporation	Japan
Mass Spectrometer		
1.	ABB India Ltd.	India
2.	Orbital Science Corporation	U.S.A
3.	VG Gas Analysis Systems	U.K.
Gas Chromatograph		
1.	ABB India Limited	India
2.	Emerson Process Management (I) Pvt. Ltd.	India
3	Applied Automation Inc	Singapore
4	ABB Process Analytics	U.K
5.	Foxbaro Far East Pte Ltd	Singapore
6.	Siemens	Germany
7	Yokogawa India Ltd.	India
Flue Gas Analyser (ZrO₂ type)		
1.	ABB Ltd (BU – Analytical & Adv)	India
2.	Chemtrol (For MAIHAK Only)	India
3.	Emerson Process Management (I) Pvt. Ltd	India
4.	Endress+Hauser	India
5	Yokogawa India Ltd.	India
6	Ametek Inc	U.S.A
7.	GE Panametrics	Ireland
H₂S/ Total Sulphur Analysers		
1.	ABB India Ltd.	India
2.	Barton Instrument Systems Limited	U.K
System House Analysers		
1.	ABB Ltd (BU – Analytical & Adv)	India
2.	Adage Automation Pvt. Ltd.	India
3.	Analyser Instrument Co. Pvt. Ltd.	India
4.	Chemtrols Industries Limited	India

	VENDOR LIST	PC0183/8003/SEC VI/5.0	0	
		Document No.	Rev	
		Sheet 4 OF 18		

5.	Emerson Process Management (I) Pvt. Ltd	India
6.	Yokogawa India Ltd.	India
7.	Intech	Italy
Density Analysers		
1.	Chemtrols Industries Limited	India
2.	Emerson Process Management (I) Pvt. Ltd (coriolis type)	India
3.	Bopp & Reuther Messtechnik GmbH (coriolis type)	Germany
4.	Solartron Mobrey	U.K
Moisture Analysers		
1.	Chemtrols Industries Limited	India
2.	Ametek Inc	U.S.A
3.	GE Panametrics	Italy
Gas & Fire Detection System		
1.	Andrew Yule & Company Ltd. (Fire)	India
2.	Chemtrols Industries Limited	India
3.	Honeywell Automation India Limited (Gas)	India
4.	J B Boda And Brothers Pvt. Ltd. (Gas Make-International Sensor Technology)	India
5.	Pollution Protection System Mumbai Pvt Ltd (Gas)	India
6.	General Monitors (Gas)	U.K
7.	Teledyne Fluid Systems (Gas)	Thailand
Air Quality Monitoring System		
1	Chemtrol Industries Ltd.	India
Sample Handling System		
1.	Analyser Instrument Co.Pvt. Ltd.	India
Flow Element: Orifice/ Venturi/ Flow Nozzle		
1.	Baliga Lighting (only Orifice)	India
2.	Chemtrol Industries Ltd.	India
3.	Delta Engineering, Pune	India
4.	Eureka Industrial Equipments Pvt. Ltd.	India
5.	FORBES MARSHALL	India
6.	Flowtech Instruments (Orifice/Venturi)	India
7.	General Instruments Consortium	India
8.	Instrumentation Ltd.	India
9.	Micro Precision Products Private Ltd.	India
10.	Micro India Flow Elements Pvt. Ltd.	India
11.	Minco(India) Flow Instruments Pvt. Ltd.	India
12.	Unicontrols Instrument Pvt. Ltd.	India
13.	Bopp & Reuther Messtechnik GMBH	Germany
14.	Daniel Measurement & Control	USA
15.	ISA Controls Limited	U.K
16.	Technomatic SPA	Italy
Pitot Tube/ Annubar		
1.	ABB India Limited	India
2.	Control Engineers	India
3.	Emerson Process Management (I) Pvt. Ltd.	India
4.	Micro Precision Products Private Ltd.	India
5.	Unicontrols Instruments Pvt. Ltd.	India
6.	Daniel Measurement & Control	U.S.A
7.	ISA Controls Limited	U.K
8.	Technomatic Spa	Italy
Rotameters		

**VENDOR LIST**PC0183/8003/SEC
VI/5.0

0



Document No.

Rev

Sheet 5 OF 18

1.	ABB india Ltd.	India
2.	Chemtrols Industries Ltd.	India
3.	Delta Control	India
4.	Eureka Industrial Equipments Pvt. Ltd.	India
5.	Flowtech Instruments services	India
6.	Instrumentation Engineers Pvt. Ltd.	India
7.	Krohne Marshall Pvt. Ltd.	India
8.	Placka Instruments & Controls Pvt. Ltd. (Purge Rotameter Only)	India
9.	Rota Instrumentation	India
10.	Yokogawa	India
11.	Rota Yokogawa Gmbh & Co. Kg	Germany
12.	Tokyo Keiso Co.Ltd.	Japan
13.	Azbil Corporation	Japan
14.	Emerson Process Mgt	U.S.A
15.	Krohne	Germany
Mass Flow Meter (Coriolis Type)		
1.	ABB India Limited	India
2.	Chemtrol Industries Ltd	India
3.	Emerson Process Management (I) Pvt. Ltd.	India
5.	Endress + Hauser	India
6.	SIEMENS Ltd.	India
7.	Yokogawa	India
8.	Bopp & Reuther Messtechik GMBH	Germany
7.	Krohne	Germany
8.	Schlumberger resource management Ltd.	U.S.A
Turbine Flowmeter		
1.	ABB India Ltd.	India
2.	Chemtrol Industries Ltd	India
3.	Krohne	India
4.	Yokogawa	India
5.	Azbil Corporation	Japan
6.	Bopp & Reuther Messtechnik GmbH	Germany
7.	Barton Instrument System Ltd.	U.K.
8.	Emerson Process Mgt	U.K.
9.	Emerson Process Mgt.	U.S.A
10.	Instromet International N.V.	Holland
11.	Itochu Corporation	Japan
12.	Oval Asea Pacific Pte Ltd.	Singapore
13.	Rockwell International Corporation	U.S.A
Vortex meter		
1.	ABB India Ltd.	India
2.	Emerson Process Management (I) Pvt. Ltd.	India
3.	Krohne Marshall Pvt. Ltd.	India
4.	Siemens Ltd.	India
5.	Yokogawa Limited	India
6.	Bopp & Reuther Messtechnik GmbH	Germany
7.	Endress + Hauser	Germany
8.	Itochu Corporation	Japan
9.	Krohne	Germany
10.	Schlumberger resource management Ltd.	U.S.A
PD Meter		

	VENDOR LIST	PC0183/8003/SEC VI/5.0	0	
		Document No.	Rev	
		Sheet 6 OF 18		

1.	Chemtrols Industries Ltd.	India
2.	Rock Flow Meters (i) Pvt. Ltd.	India
3.	Bopp & Reuther MesstechnikGmbH	Germany
4.	Emerson Process Management	U.S.A
5.	Oval Asea Pacific Pte Ltd.	Singapore
6.	Schlumberger resource management Ltd.	U.S.A
Magnetic Flow meter		
1.	ABB India Ltd.	India
2.	Chemtrol Industries Ltd	India
3.	Emerson Process Management (I) Pvt. Ltd.	India
4.	Endress + Hauser (India) Pvt. Ltd.	India
5.	Krohne Marshall Pvt. Ltd.	India
6.	Siemens Ltd.	India
7.	SBEM Pvt. Ltd.	India
8.	Yokogawa	India
9.	Azbil Corporation	Japan
10.	Bopp & Reuther MesstechnikGmbH	Germany
11.	Krohne	Germany
Insertion Type Flow Meter		
1	Emerson Process Management (I) Pvt. Ltd.	India
2	Siemens Ltd.	India
Ultrasonic Flow Meter		
1	Chemtrol Industries Ltd	India
2.	Endress + Hauser (India) Pvt. Ltd.	India
3.	Emerson Process Management	India
4	Siemens Ltd.	India
5	Yokogawa	india
Orifice Meter		
1	Chemtrol Industries Ltd	India
Metering Skid		
1.	Chemtrol Industries Ltd.	India
Pressure Gauges		
1.	Ashcroft India(P) Ltd. (standard normal type)	India
2.	A.N. Instruments Pvt. Ltd.	India
3.	Baumer Technologies India Pvt . Ltd	India
4.	Forbes Marshall	India
5.	General Instruments Consortium,	India
6.	H.Guru Industries	India
7.	Peejee Engg. Works	India
8.	Precision Industries Ltd. (standard normal type)	India
9.	Premium Instrument & Controls Ltd.	India
10.	Manometer (India) Pvt. Ltd.	India
11.	Walchand Nagar Industries Ltd.	India
12.	Wika	India
13.	Budenberg Gauge Co. Ltd	U.K
14.	Dresser Europe S.A	Germany
15.	Nagano keiki Seisakusho	Japan
16.	Rueger Sa	Switzerland
17.	Spriano Spa	Italy
18.	WikaAlexanderWiegardGmbH& Co.	Germany
Local D/P Indicators		

	VENDOR LIST	PC0183/8003/SEC VI/5.0	0	
		Document No.	Rev	
		Sheet 7 OF 18		

1.	Precision Mass Products Pvt. Ltd	India
2.	Switzer Instrument Co.	India
3.	Wika	India
4.	Barton Instrument Systems Limited	U.K
5.	Delta Controls Ltd.	U.K
Pressure & D/P Transmitters		
1.	ABB India Ltd.	India
2.	Emerson Process Management (I) Pvt. Ltd.	India
3.	Endress + Hauser (India) Pvt.Ltd.	India
4.	Honeywell Automation India Limited	India
5.	Siemens Ltd.	India
6.	Yokogawa Limited	India
7.	Azbil Corporation	Japan
8.	Emerson Process Mgt Singapore Ltd	Singapore
9.	Honeywell Inc.	U.S.A
10.	Moore Products Company	U.S.A
11.	Siemens Ag, Germany	Germany
12.	Smar Singapore Pte. Ltd.	Singapore
13.	VEGA Grieshaber KG	Germany
14.	Yokogawa Electric Corporation	Japan
Pressure & D/P Switches Including Vol. Seal		
1.	Endress + Hauser(India) Pvt. Ltd.	India
2.	Indfos Industries Ltd. (Except Vol.Seal)	India
3.	Kaustubha Udyog (Except Vol.Seal)	India
4.	Precision Mass Products Pvt. Ltd	India
5.	Switzer Instrument Co. (Except Vol.Seal)	India
6.	Azbil Corporation	Japan
7.	Delta Controls Ltd.	U.K
8.	Nagano Keiki Seisakusho	Japan
9.	SOR Inc.	U.S.A
10.	United Electric Controls Co.	U.S.A
Transparent/ Reflex / Bicolor Mag.Level Gauges		
1.	ABB India Ltd.	India
2.	Bliss Anand Private Ltd.	India
3.	Chemtrols Samil(India) Pvt Ltd.	India
4.	Flowtech Instruments services	India
5.	LEVCON INSTRUMENTS PVT. LTD.	INDIA
6.	Nisan Scientific Process Equipments Pvt. Ltd	India
7.	Pune Techtrol Pvt. Ltd. (= < 300#)	India
8.	Technomatic (India) Pvt. Ltd.	India
9.	V-Automat Instruments Pvt. Ltd. (upto 300#)	India
10.	Clark-Reliance Corp.	U.S.A
11.	CesareBonetti	Italy
12.	Jerugson Gauge & Valve Co.	U.S.A
13.	Nihon Klingage Co. Ltd.	Japan
14.	Richard Klinger Ag	Austria
15.	Technomatic Spa	Italy
Level Switches (Float & Displacer Type)		
1.	ABB India Ltd.	India
2.	Bliss Anand Private Ltd.	India
3.	Chemtrols Samil(India) Pvt Ltd.	India

**VENDOR LIST**PC0183/8003/SEC
VI/5.0

0



Document No.

Rev

Sheet 8 OF 18

4.	Pune Techtrol Pvt. Ltd.	India
5.	SBEM Pvt. Ltd.	India
6.	Siemens Ltd.	India
7.	V.Automat & Instruments (P) Ltd.	India
8.	ISA Controls Limited	U.K.
9.	KDG. MOBREY Ltd.	U.K.
10.	Magnetrol International N.V	Belgium
11.	SOR Inc.	U.S.A
12.	Vega Grieshaber KG	Germany
Displacer Type Level Transmitters		
1.	Chemtrols Industries Limited (Eckardt Make Electronics)	India
2.	Dresser Valve India Pvt Ltd (Rating <= 600#)	India
3.	Dresser Masoneilan	France
4.	Foxboro EckardtGmbh	Germany
5.	Magnetrol International N.V. (Lvd) t	Belgium
6.	Parcol Spa (Pneumatic Transmission Only)	Italy
Tank Level Instruments		
1.	ABB India Limited	India
2.	Emerson Process Management (i) Pvt. Ltd.	India
3.	Pune Techtrol Pvt. Ltd.	India
4.	Siemens Ltd. (Radar level Transmitter, guided wave Radar)	India
5.	SBEM Pvt. Ltd.	India
6.	EnrafSingaporePte. Ltd.	Singapore
7.	Endress + Hauser Gmbh& Co., (Non-Contact & Servo)	Germany
8.	Krohne (Non-Contact Type)	Germany
9.	L& J Technologies	U.S.A
10.	Toyo Keiso Co. Ltd.	Japan
Ultrasonic Level Transmitter		
1.	Forbes Marshall	India
2.	Siemens Ltd.	India
3.	Vega Grieshaber KG	Germany
Tank Farm Management		
1.	Endress + Hauser (India) Pvt. Ltd. (Servo,Radar)	India
Guided wave Rdar / High Frequency Radar		
1.	Endress + Hauser (India) Pvt. Ltd	India
2.	Forbes Marshall	India
3.	Magnetrol	India
4.	Vega Grieshaber KG	Germany
5.	EIP Enviro level controls private limited	India
Temperature Elements (Thermocouple, Rtd)		
1.	Altop Industries Ltd.	India
2.	ABB India Ltd.	India
3.	Detriv Instrumentation & Electronics Ltd.	India
4.	Electrical & Electronics Ltd.	India
5.	Eleind Engineering Pvt. Ltd.	India
6.	Endress + Hauser (India) Pvt. Ltd.	India
7..	Exotherms Instruments	India
8.	General Instruments Consortium	India
9.	Goa Instruments Industries Ltd.	India
10.	Industrial Instrumentation	India
11.	Precision Mass Products Pvt. Ltd.	India

	VENDOR LIST	PC0183/8003/SEC VI/5.0	0	
		Document No.	Rev	
		Sheet 9 OF 18		

12.	Pyro Electric Instruments Goa Pvt. Ltd.	India
13.	Tempsens Instruments (I) Pvt. Ltd.	India
14.	Thermal Instruments India Pvt. Ltd.	India
15.	Unicontrols Instruments Pvt. Ltd.	India
16.	Azbil Corporation	Japan
17.	Okazaki Manufacturing Co.	Japan
18.	Sensycon	Germany
19.	Thermo Electric Co.Ltd.	Holland
20.	W.C.Heraeus GMBH	Germany
Bimetallic Thermometer		
1.	A N Instruments Pvt. Ltd.	India
2.	Ashcroft India(P) Ltd.	India
3.	Baumer Technologies India Pvt. Ltd.	India
4.	General Instruments Consortium	India
5.	Goa Instruments Industries Ltd	India
6.	H.Guru Industries	India
7.	Krohne Marshall Pvt. Ltd.	India
8.	Precision Mass Products Pvt. Ltd.	India
9.	Nagano Keiki Seisakusho	Japan
10.	Rueger SA	Switzerland
11.	Technomatic SPA	Italy
12.	Trend Instrument Inc.	U.S.A
Vibration Fork/ RF Capacitance type Level Switches		
1.	ABB India Ltd.	India
2.	Protocontrol Instruments (I) Pvt. Ltd. (non-critical)	India
3.	Endress + Hauser	Germany
4.	EIP Enviro level controls private limited	India
Dial Thermometer (Hg In Steel/Glass)		
1.	A N Instruments Pvt. Ltd.	India
2.	Ashcroft India(P) Ltd.	India
3.	Baumer Technologies India Pvt. Ltd.	India
4.	General Instruments Consortium,	India
5.	Goa Instruments Industries Ltd	India
6.	H.Guru Industries	India
7.	Precision Mass Products Pvt. Ltd	India
8.	Pejee Engg Works	India
9.	Walchand Nagar Industries Ltd.	India
Radiation Pyrometer		
1.	Tempsens Instruments Pvt. Ltd.	India
2.	C.C.R Technico	Italy
3.	Chino Corpn.	Japan
4.	Land Infrared	U.K.
5.	Siemens AG	Germany
6.	Wahal Instruments	U.S.A
Temperature Transmitters		
1.	ABB India Limited	India
2.	Emerson Process	India
3.	Endress+ Hauser (India) Pvt. Ltd.	India
4.	Siemens Ltd.	India
5.	Yokogawa	India
Gate/Plug Valves		

**VENDOR LIST**PC0183/8003/SEC
VI/5.0

0



Document No.

Rev

Sheet 10 OF 18

1.	Audco India Limited(L&T Valves Divn.)	India
2.	BHEL(Valves Division)	India
3.	Chemtrols Engineering Limited (Plug Valves)	India
4.	Flowserve India Control Pvt. Ltd.(Plug Valve upto 12"300# upto 6" 600#)	India
5.	Ksb Pumps Limited (Valves Divn)	India
6.	NU Tech Controls (MOV Gate :1/2" to 8" 2500#, 10" to 14",300#)	India
7.	Samsons Contols Pvt. Ltd. (Upto 34", 300#)	India
8.	Valve Tech Industries (Mov -8" upto 2500#)	India
9.	Velan Inc.	Canada
10.	Weir Bdk Vlaves	India
11.	Bel Valves	Japan
12.	CesareBonetti	Italy
13.	Fasani S.P.A	Italy
14.	MalbranqueS.A.	France
15.	Matsura H. P Machine works co. Ltd.	Japan
16.	Petrol Valves S.R.L	Italy
Globe / Angle Valves		
1.	AST S.P.A (Upto 8"900#)	India
2.	Chemtrol Industries Ltd.	India
3.	Circor Flow Technologies India Pvt. Ltd.	India
4.	Dresser Valve India Pvt. Ltd.(Rating =<600#,size 3/4" to 6")	India
	Emerson Process Management India Ltd	India
5.	Emet Controls Pvt. Ltd.(Globe Valve up to 4",300# angle valve upto 1-1/2",2500#)	India
6.	Flowserve india control pvt. Ltd. (globe valve upto 30" 600# upto 24" 900#, upto 16" 2500# upto 4" 4500#)	India
7.	Koso fluids controls pvt. Ltd. (globe valves: upto 8" 2500# 10 to 18" 300# angle valves upto 8" 300#)	India
8.	Instrumentation Ltd. (Palakkad)	India
9.	Mil Controls Limited	India
10.	NU Tech Controls	India
11.	Pneucon valves Pvt. Ltd. (upto 6" 300#) noncritical)	India
12.	Samson Control Pvt Ltd(upto 6" &=<600#)	India
13.	Tecnik valves pvt Ltd. (air & water service upto 4" 150#)	India
14.	Valve-Tech Inducstries (non-critical)	India
15.	Azbil Corporation (=< 2500#)	Japan
16.	Arca Regler GMBH	Germany
17.	Dresser Masoneilan	France
18.	Flowserve (=<2500#)	U.S.A
19.	Fisher Xomox (=< 2500#)	Singapore
20.	Parcol Spa	Italy
21.	Nippon Fisher Co. Ltd. (=<2500#)	Japan
22.	Severn Glocon (1 to 12" 600#)	U.K.
Ball Valves		
1.	Tyco Valves & Controls (I) Ltd (=< 150 #)	India
2.	Virgo Engineers Ltd. (=<600# With Maccair Actuators)	India
3.	Anand teknow aids engineering india limited (upto 6",600# (ON-OFF)	India
4.	Bray Controls India Pvt. Ltd.(upto 4",300#)	India
5.	Emerson	India
6.	EMET controls pvt. Ltd.(upto 8",150# for air service)	India
7.	Fisher Xomox Sanmar	India



VENDOR LIST

PC0183/8003/SEC
VI/5.0

0



Document No.



Rev

Sheet 11 OF 18



8	Flowserve India controls Pvt. Ltd. (upto 16" 600#)	India
9	Intervalve ponnawalla limited (uptp 10",150#)	India
10	Koso Fluid Controls pvt. Ltd. (upto 8 " ,2500# ,10" to 18" 900#)	India
11	NU Tech Controls (14",600# for non-critical purpose)	India
12	Pentair Valves and controls India Pvt. Ltd. (<=150#)	India
13	Pneucon valves pvt. Ltd. (upto 6",150# non-critical)	India
14	Samson Control Pvt Ltd(upto 24" &=<1500#)	India
15	Valve tech industries ltd. (18",150# non critical)	India
16	Weir Bdk Vlaves (upto 16",150#)	India
17	G.T.C. Italia S.R.L(=<300#)	Italy
18	Metso Automation (=<2500#)	Singapore
19	Orbit Valves PLC (=<2500#)	Singapore
20	Petrol Valves S.R.L	Italy
21	PERRIN Gmbh (size ½" to 12",& rating 150# to 2500#,size 14"to 18", rating 150# to 1500# ,size 20"to 24" rating 150# & 300#)	Germany
22	Pibiviesse S.P.A. (Rating Upto 2500 #)	Italy
23	Rotex manufacturers & Engineers Pvt. Ltd. (upto 6" 600#, 6" to 10" 150#)	India
24	Velan Inc. (ball valves on/off size: ¼" to 6" (rating upto 2500#) size 8"to 16" (rating upto 900#) size 18" to 30 " (rating upto 300#)	Canada
Butterfly Valves		
1	Advance valves pvt. Ltd.(size 2"to 24" upto 600#)	India
2	Bray controls india pvt. Ltd. (upto 300#)	India
3	Dresser Masonelian Valves	India
4	Emet controls pvt. Ltd. (upto 4",900#, 6",150# to 16",150# double eccentric)	India
5	Flowserve india control pvt. Ltd. (upto 30",300# upto 12" 600#)	India
6	Fisher	India
7	Intervalve ponnawaala ltd. (2" to 48",150#)	India
8	Instrumentation Ltd. (Palakkad) (=< 300#)	India
9	Koso fluid controls (pvt.) ltd. (=< 150#)	India
10	Nu tech controls (16",300# for non-critical services)	India
11.	Pneucon valves pvt. Ltd. (upto 8",150# non critical)	India
12.	Samson controls pvt. Ltd.	India
13	Tyco Valves & Controls (I) Ltd (=< 150 #)	India
14	Valve tech industries (non-critical services)	India
15	Virgo Engineers Ltd. (=<300#)	India
16	Weird BDK valves (upto 16",300#0)	India
17	Bray Controls(=<300#)	U.S.A
18	Keystone (Upto 2500#)	Singapore
19	Leeds valve ltd.	UK
20	Korea Unicom Valve Co. Ltd.	Korea
21	Parcol Spa (=< 2500# Urea Service Also)	Italy
22	Pentair Valves and controls India Pvt. Ltd. (<=150#)	
23	Metso Automation (Upto 2500#)	Singapore
24	Orton S.r.l. (upto 2500#)	
PRDS & SPRAY NOZZLE,VENT VALVES upto 2500#		
1.	ARCA (Forbes Marshal) (Mech. Spray nozzle type desuperheater only)	India
2.	Chemtrols Industries Ltd. (PRDS Combine & Split)	India
3.	Circor Flow Technolgies India Pvt. Ltd. (1" to 20",upto 150#, 1 to 10" upto 1500#, 1"to 8",upto 2500#)	India
4	Control components INC	India
5	FisherControls	India
6.	Samson Controls Pvt. Ltd. (upto 6",150#)	India

	VENDOR LIST	PC0183/8003/SEC VI/5.0	0	
		Document No.	Rev	
		Sheet 12 OF 18		



7.	CCI Valve Technology AB	Sweden
8	SPX Valves & Controls (COPEX-VULCAN LTD.)	U.S.A
Electric Actuator		
1.	Biffi Italia S.R.L	Italy
2.	Limitorque, U.S.A	U.S.A
3.	Rotork Control (Deutschland) GmbH	Germany/INDIA
4.	Auma,	U.S.A/INDIA
Air Filter cum Pressure Regulator		
1.	ABB India Limited	India
2.	Divya Control Elements Pvt. Ltd.	India
3.	Dresser	India
4.	Emerson Process Management	India
5.	Mil Controls Limited	India
6.	Placka Instruments & Controls Pvt. Ltd.	India
7.	Shavo Norgren(India) Pvt Ltd.	India
8.	Schrader Duncan Ltd. (1/4" to 2" port size)	India
Valve Actuator (Pneumatic/Rotary)		
1.	Bray Control India Pvt. Ltd.	India
2.	EL-O-Matic India Pvt. Ltd.	India
3	Rotex Manufacturers & Engineers Pvt Ltd	India
4	Schrader Ducaan Ltd.	India
Self actuated pressure control valve		
1	FisherControls	India
2	Nirmal Industrial controls private limited (size 1/2" to 6 " & rating : < =300#)	India
3	Nu tech Controls (upto 10",600#)	India
4	Pneucon Valves Pvt.Ltd. (upto 4",150#)	India
5	Samsons Controls Pvt. Ltd. (upto 2",150#)	India
Electropneumatic Positioner		
1.	FisherControls	India
2	Siemens Ltd.	India
Desuperheaters		
1.	Circor Flow Technologies India Pvt. Ltd (upto 24",300# upto 28",150#, multinozzle 3" to 4",upto 2500#)	India
2.	Chemtrols	India
3	CCI	India
4	EMET Controls Pvt. Ltd.(Desuperheating Control Valves 1-1/2", 600# * 3",2500#)	India
5	Fisher	India
6	Tyco	India
Pressure reducing Station		
1.	Circor Flow Technologies India Pvt. Ltd (1" to 20",upto 150# ,1 "to 10", upto1500#,1"to 8 " upto 2500#)	India
Pressure Regulator		
1.	Chemtrol Industries Ltd.	India
Safety Valves & Thermal Relief Valves Upto 2500#		
1.	AST S.P.A	India
2.	Bliss anand private limited (8" * 10" 300#, 6" * 8 " 600# ,4 * 6" 1500#)	India
3.	Fainger Leser Valves (P) Ltd. (Upto 600#, 1/2" To 6")	India
4.	Instrumentation Ltd. (Palakkad)	India
5.	Keystone	India
6	Pentair Sanmar Ltd.	India
7	Nu tech controls (upto 2",300# * 3",150#)	India

	VENDOR LIST	PC0183/8003/SEC VI/5.0	0	
		Document No.	Rev	
		Sheet 13 OF 18		



8	Valve Tech Industries	India
9	Weir Bdk Valves	India
10	BOPP & Reuther Messtechnik GMBH	Germany
11	Crossby valve & Engg. Company Ltd.	U.K
12	Dresser Industries Incorporated	U.S.A
13	Dresser Valve & Controls	Canada
14	Farris	U.K
15	Itochu Corporation	Japan
16	Parcol Spa (For Urea Service Also)	Italy
17	Sapag Gec Alsthom	France
18	Tai Milano S.P.A	Italy
19	Teledyne Fluid Systems	Thailand
Vaccum Breakers		
1.	Fainger Engineering	India
2.	Potego India Pvt. Ltd.	India
3.	Braunschweiger Flammenfilter	
4.	Itochu Corporation	Japan
5.	Parcol Spa	Italy
6.	Safety Systems UK Ltd.	U.K
7.	Tai Milano S.P.A	Italy
8.	Whessoe Varec Limited	U.K
Rupture Discs		
1.	Bs&B Safety Systems (India) Limited	India
2.	Fainger Engineering	India
3.	Tyco Sanmar	India
4.	Continental Controls Inc.	U.S.A
5.	Fike Europe	Belgium
6.	Sapag GEC Alsthom	France
7.	Teledyne Fluid Systems	Thailand
Pilot relief valves		
1.	AST S.P.A (inlet size upto 3", upto 1500#, outlet size upto 4", upto 300#,inlet size upto 4",upto 300# ,inlet size upto 6", upto 150#,outlet size upto 8", upto 150#)	India
2.	Bliss Anand Private Limited (Size 1" 2" 2500#)	India
Low pressure relief valve		
1.	Protego India Pvt. Ltd. (less than 1 BAR with flame arrestor)	India
Flame arrestor		
1.	Protego India Pvt. Ltd	India
Control Panel		
1.	Electronics corporation of india ltd.	India
2.	Ex protecta	India
3.	Hulasi metals pvt. Ltd.	India
4.	Industrial control appliances (p) ltd.	India
5.	Jaisun & hutchisun control ltd.	India
6.	Prima automation (india) pvt. Ltd.	India
7.	Pyrotech electronics pvt. Ltd.	India
8.	Tan swa technologies INC	India
9.	United electric co (delhi) pvt. Ltd,	India
10.	Yokogawa india limited	India
11.	Instromet international N.V.	Holland
Programable Logic Controller- Package		

	VENDOR LIST	PC0183/8003/SEC VI/5.0	0	
		Document No.	Rev	
		Sheet 14 OF 18		

1.	ABB India Limited	India
2.	Emerson Process Management (I) Pvt. Ltd.	India
3.	Ge Fanuc Systems Prvitate Limited	India
4.	Honeywell Automation India Limited	India
5.	Rockwell Automation India Ltd.	India
6.	Siemens Ltd.,	India
7.	Yokogawa	India
8.	GE fanuc automation north America INC (fault tolerant TMR)	U.S.A
9.	Hima paul Hildebrandt Gmbh +Co KG (fail safe)	Germany
10.	Marconi italiana (non fail safe)	Italy
11.	Omron corporation (Relay)	Japan
12.	RTP Control system	U.S.A /India
13.	Triconex (fault tolerant TMR)	Singapore
14.	Triconex (Schenider)	Singapore
Distributed Control System		
1.	ABB India Limited	India
2.	Emerson process management India Pvt. ltd.	India
3.	Foxboro	India/Intl.
4.	Honeywell Automation India Limited	India
5.	Siemens Ltd.	India
6.	Yokogawa Limited	India
7.	Bailey controls company	U.S.A
8.	Emerson process management Singapore ltd.	Singapore
9.	Honeywell Inc.	U.S.A
10.	Invensys	Holland
11.	Siemens AG	Germany
12.	Yokogawa Electric Corporation	Japan
ESD SHUT- DOWN SYSTEM		
1	HONEYWELL	
2	HIMA CONTROLS	
3	PAUL HILDEBRANDT (HIMA)	
4	RTP Control system	
5	Rockwell automation pvt. Ltd.	
6	SIEMENS AG	
7	TRICONEX / IMPROTEC	
8	YOKOGAWA	
Multiplexer / Remote I/O		
1.	Mtl Instrument Limited	India
2.	Pepperl + Fuch	India
3.	M.system Co. Ltd. (Remote I/O; Model No.R3)	Japan
4.	M.T.L., U.K.	U.K
5.	Pepperl + Fuchs Pte Ltd.	Singapore
6.	Stahl-Und Apparatebau Hans LefferGmbh	Germany
Receiver Instruments (Indicator,Controller,Recorder)		
1.	ABB India Limited	India
2.	Chino-Laxsons (India) Limited (Only Recorder)	India
3.	Eurotherm Del India Limited	India
4.	Honeywell Automation India Limited	India
5.	Masibus Automation & Instrumenation Pvt.Ltd. (Receiver Instruments except recorder)	India
6.	Moore Controls Ltd.	India

	VENDOR LIST	PC0183/8003/SEC VI/5.0	0	
		Document No.	Rev	
		Sheet 15 OF 18		

7.	Yokogawa Limited	India
8.	ChinoCorp.	Japan
9.	Heraeus Electro-Nite International N.V.	Japan
10.	Honeywell Inc.	U.S.A
11.	Siemens Ag, Germany	Germany
12.	Yokogawa Electric Corporation	Japan
Alarm Annunciator		
1.	Industrial Instruments & Controls	India
2.	Shree Electronics	India
3.	M.T.L., U.K.	U.K
4.	Rochester Instrument Systems Ltd.	U.K
5.	Riley Panalarm	U.S.A
6.	Ronan Engg. Co.	U.S.A
Temperature Scanner		
1.	Industrial Instrumentation	India
2.	Protocontrol Instruments (I) Pvt. Ltd.	India
Cctv / Access System		
1.	Honeywell	India
2.	Yokogawa Limited	India
Miscellaneous Items (Rtu / ScadaEtc)		
1	ABB India Limited	India
2.	Rockwell Automation India Pvt. Ltd.	India
3.	Siemens Ltd. (Simatic WINcc)	India
Telephone (EPBAX) System		
1	NEUMAN	India
2	BPL	India
3	Unify	India
Surge Protection Devices		
1.	Phoenix Contact (India) Pvt. Ltd.	India
Wiring Ducts		
1.	Trinity touch Pvt.Ltd.	India
DIN Rail		
1.	Trinity touch Pvt.Ltd.	India
Interface Module		
1.	Trinity touch Pvt.Ltd.	India
Cable connector		
1.	Phoenix contact (India) Pvt. Ltd.	India
Advance Process Control System		
1.	Yokogawa India Limited	India
Speed Indicator		
1.	Bentley NevedaLlc	U.S.A
2.	Jacquet	Switzerland
3.	Pepperl + Fuch	Germany
4.	Pepperl + Fuchs Pte Ltd.	Singapore
5.	Shinkawa Electric Co.	Japan
Burner Management System		
1.	Siemens (TMR/QMR)	
2.	Triconex (TMR/QMR)	
3.	Honeywell (TMR/QMR)	
4.	Yokogawa (TMR/QMR)	
5.	Rockwell Automation Pvt. Ltd. (TMR/QMR)	

	VENDOR LIST	PC0183/8003/SEC VI/5.0	0	
		Document No.	Rev	
		Sheet 16 OF 18		

Instrument Power & Control Cables		
1.	Associated Cables Ltd.	India
2.	Associated Flexibles & Wires Pvt. Ltd.	India
3.	Cords Cable Industries Ltd.	India
4.	Delton Cables Ltd	India
5.	Centurion Power Cables Limited	India
6.	J K Cables Limited	India
7.	Kei Industries Limited	India
8.	Suyog electricals Ltd.	India
9.	Paramount Cable Corporation	India
10.	T C Communications Pvt Ltd	India
11.	Thermo Cables Limited	India
12.	Toshniwal Cables	India
13.	Udey Pyro Cables Pvt Ltd	India
Extension & Compensating Cables		
1.	Associated Cables Ltd.	India
2.	Associated Flexibles & Wires Pvt. Ltd.	India
3.	Cords Cable Industries Ltd.	India
4.	Delton Cables Ltd	India
5.	General Instruments Consortium,	India
6.	J K Cables Limited	India
7.	Kei Industries Limited	India
8.	Paramount Cable Corporation	India
9.	Thermopads Pvt. Ltd.	India
10.	Toshniwal Cables	India
Cable Trays & Accessories (Al./GI/FRP)		
1.	D-Y Engineers	India
2.	Globe Electrical Industries	India
3.	Sumip Composite	India
4.	Indiana Engg Works Pvt Ltd	India
5.	Metalite Industries	India
6.	Parekh Engineering Company	India
7.	Sadhana Engineering Corporation	India
8.	Steelite Engineering Limited	India
Multi Transit Inlet System		
1.	Hawke International	U.K
2.	MctBrattbergAktiebolag	Sweden
3.	RoxtecAb	Sweden
Junction Box & Cable Gland		
1.	Baliga Lighting Equipments Limited	India
2.	Ceag Flameproof Control Gears Pvt.Ltd.	India
3.	Ex-protecta	India
4.	Flameproof Equipments Pvt. Ltd.	India
5.	Flexpro Electicals Pvt. Ltd.	India
6.	TAN SWA technologies Inc (Junction Box)	India
7.	Trinity Touch Pvt. Ltd. (Only cable Glands upto size 25M)	India
8.	Stahl-Und Apparatebau Hans Leffer GmbH	Germany
CS Seamless Pipes –As per Piping list		
1	Indian tube Co.(Tata Div of tubes & pipes)	India
2	ISMT limited	India
3	Maharashtra seamless limited	India

	VENDOR LIST	PC0183/8003/SEC VI/5.0	0	
		Document No.	Rev	
		Sheet 17 OF 18		

4	Dalmine SPA	Italy
5	ETS Trouvay & Cauvin	France
6	Horst kurvers Gmbh	Geramny
7	Hyundai Corporation	Korea
8	IBF seamless pipes SPA	Italy
9	Mannesmann Hnadel AG	Geramny
10	Marubeni Itochu Steel	Japan
11	Nippon steel corporation	Japan
12	Nissho IWAI Corporation	Japan
13	Okura & Co. Ltd.	Japan
14	Sojitz Corporation	Japan
15	Sumitomo metal industries Ltd.	Japan
16	Phoceenne	France
17	Vomal International Limited	UK
SS Seamless Pipes-As per piping list		
1	Choksi tube company limited	India
2	Maxim tubes company pvt. Ltd.	India
3	Nuclear fuel complex	India
4	Ratnamani metals & tubes limited	India
5	Remi edelstahl tubular ltd.	India
6	Dalmine SPA	Italy
7	Phoceenne	France
8	TPS technitube Rohrenwerke	Germany
9	T.T.I tubececx tubos inoxidables S.A. (1/2" NB SS pipe)	Spain
SS Tubes		
1.	Choksi Tube Company Ltd.	India
2.	Matim Tubes Company Pvt. Ltd.	India
3.	Nuclear Fuel Complex	India
4.	Ratnamani Metals & Tubes Limited	India
5.	Sandvik	India
6	Itochu Corporation (Rep.KubotaCorp.)	Japan
7.	Nishitani& Co. Ltd.	Japan
8	Sumitomo Metal Industries Ltd.	Japan
Pipe Fittings		
1.	Eby industries	India
2.	Excel hydropneumatics pvt. Ltd.	India
3.	Micro precision products pvt. Ltd.	India
4	Precision engineering industries	India
5	Tecnomatic (india) pvt. Ltd.	India
6	Wesmec engineering pvt. Ltd.	India
7	Celleir	France
8	Cesare bonetti SPA	Italy
9	Dewrance & Co. Ltd.	U.K.
10	Hopkinsons Ltd.	U.K.
11	Siemens AG PGI	germany
12	Sumitomo metal industries ltd.	Japan
13	Thysen krupp stahlunion Gmbh	germany
14	Tecnomatic SPA	Italy
Instrument Miniature Valves		
1.	Audco India Limited(L&T Valves Divn.)	India
2.	Aura Inc	India

	VENDOR LIST	PC0183/8003/SEC VI/5.0	0	
		Document No.	Rev	
		Sheet 18 OF 18		

3.	Bhel (valves division)	India
4.	Chemtrol Industries Ltd	India
5.	Chemtrols Samil(India) Pvt Ltd	India
6.	Comfit & Valves Pvt. Ltd.	India
7.	Excel Hydro-Pneumatics Pvt Ltd,	India
8.	Excelsior Engg Works	India
9.	Hyd- Air Engineering works Lonavla	India
10.	Ksb Pumps Limited (Valves Divn)	India
11	Panam Engineers	India
12	Tecnomatic (India) Pvt. Ltd.	India
13	Anderson Greenwood & Co.	U.S.A
14	BFE boneey forge valve License	Italy
15	Celleir S.A.	France
16	Crane Company International Sales	U.S.A
17	Dewrance & Co. Ltd.	U.K.
18	Euromisure Cremona	Italy
19	Hopkinsons Ltd.	U.K.
20	Kosei Sanyog Ltd.	Japan
21	Swagelok company/creximco	U.S.A
22	Sumitomo metal industries ltd.	Japan
23	Technomatic SPA	Italy
24	Velan engineering Co. Limited	U.K.
25	Wesmec engineering pvt. Ltd	India
Purge rotameter		
1	Eureka industrial equipments Pvt. Ltd.	India
2	Instrumentation engineers pvt. Ltd.	India
3	Placka instruments & engineers pvt. ltd	India
AIR HEADER/ADPOT		
1	Wesmec engineering pvt. Ltd.	India
Condensate pot		
1	HYDROPNEUMATICS	India
2	MICRO-PRECISION PRODUCTS	India
3	TECHNOMATIC (I) P. LTD.	India
4	Wesmec engineering pvt. Ltd.	India
Valve manifolds		
1	Comfit & Valves Pvt. Ltd.	India
2	EXCEL HYDROPNEUMATICS PVT. LTD.	India
3	HYDER	India
4	INSTRUMENTATION LTD.	India
5	MICRO PRECISION	India
6	NORDIVAL (SWAGELOC)	
7	PARKER	India
8	TECHNOMATIC	India
9	Wesmec engineering pvt. Ltd.	India
Calibration equipment & services		
1	Tempsens instruments (i) pvt. Ltd.	India
2	Fluke	Singapore
3	Omega Engineering	US
Enclosures		
1	Trinity touch pvt. Ltd. (weatherproof size 80 * 80 mm)	India

SCHEDULE OF RATES

SECTION VII

ATTENTION

**THIS IS AN ELECTRONIC TENDER BIDDER TO QUOTE AS PER
PROVIDED BOQ (.XLS) IN CPP PORTAL ONLY**

Validate

Print

Help

Item Rate BoQ

Tender Inviting Authority: Projects & Development India Limited, Noida

Name of Work: TENDER FOR SUPPLY CUM ERECTION OF ELECTRICAL & INSTRUMENTATION WORKS ON ITEM RATE BASIS AT TALCHER FERTILIZERS LTD., ANGUL, ODISHA

Contract No: PNPM/PC-183/E/8003/NCB

NOTE : Quantities mentioned in the Schedule of Rates are indicative and not exhaustive in nature. Payment shall be made as per actual quantity used/certified at site by Owner's Engineer-in-charge. Quantities indicated in Schedule of Rates are approximate and subject to variation on either side. The quantity of individual item may be deleted. Contractor shall not be entitled for any compensation on this account and the quoted rates shall hold good for such quantity variations etc. Payments on bills shall, however, be made on actual measurements of quantities of work done as per approved drawings. Goods & Services Tax (GST) is applicable @ 18% on the quoted rates (being Works Contract).

Name of the Bidder/ Bidding Firm / Company :	
--	--

SCHEDULE OF RATE (Rev. 0) (This BOQ template must not be modified/replaced by the bidder and the same should be uploaded after filling the relevant columns, else the bidder is liable to be rejected for this tender. Bidders are allowed to enter the Bidder Name and Values only)

NUMBER #	TEXT #	NUMBER #	TEXT #	NUMBER #	NUMBER #	NUMBER #	TEXT #
Sl. No.	Item Description	Quantity	Units	BASIC RATE In Figures To be entered by the Bidder in Rs. P	TOTAL AMOUNT Incl. All taxes & duties (Excl. GST) in Rs. P	TOTAL AMOUNT Incl. All taxes , duties and GST in Rs. P	TOTAL AMOUNT Incl. All taxes, duties and GST In Words
1.00	2	4	5	13	53	54	55
1.00	TOTAL AMOUNT FOR SUPPLY OF ELECTRICAL ITEMS (SUPPLY: PART-A)						
1.10	TRANSFORMERS						
1.11	Supply of Transformers with all accessories, as specified in data sheets, Technical Specification - Electrical, Technical Specification Doc. No. PC183-TS-0802, etc. attached with the NIT.				0.00	0.00	INR Zero Only
1.12	2000 MVA, 11/0.433 kV, ONAN, Dyn11, 3 phase, 50 Hz, Oil immersed type transformer with externally operated off circuit tap changer with tapping range of $\pm 5\%$ in steps of 2.5% and Z=7.25% (zero negative tolerance) with all applicable fittings and accessories.	2	Nos.		0.00	0.00	INR Zero Only
1.13	1600 MVA, 11/0.433 kV, ONAN, Dyn11, 3 phase, 50 Hz, Oil immersed type transformer with externally operated off circuit tap changer with tapping range of $\pm 5\%$ in steps of 2.5% and Z=6% (zero negative tolerance) with all applicable fittings and accessories.	2	Nos.		0.00	0.00	INR Zero Only
1.14	1250 MVA, 11/0.433 kV, ONAN, Dyn11, 3 phase, 50 Hz, Oil immersed type transformer with externally operated off circuit tap changer with tapping range of $\pm 5\%$ in steps of 2.5% and Z=6% (zero negative tolerance) with all applicable fittings and accessories.	2	Nos.		0.00	0.00	INR Zero Only
2.00	deleted				0.00	0.00	Zero Only
3.00	HT CAPACITOR BANK				0.00	0.00	INR Zero Only
3.11	Supply of Capacitor Bank alongwith VCB, RVT, series reactor, Control Panel, APFC Relay, HT vacuum contactor, HT Fuse, Relays etc. complete in all respect as per Technical specification - Electrical, Technical Specification - Capacitor (Doc. No. PC183-TS-0822) etc.				0.00	0.00	INR Zero Only
3.12	300 KVAR Capacitor bank (2 Steps of 100KVAR,200KVAR each), 3.3 KV Voltage Level	2	Nos.		0.00	0.00	INR Zero Only

Validate

Print

Help

Item Rate BoQ

Tender Inviting Authority: Projects & Development India Limited, Noida

Name of Work: TENDER FOR SUPPLY CUM ERECTION OF ELECTRICAL & INSTRUMENTATION WORKS ON ITEM RATE BASIS AT TALCHER FERTILIZERS LTD., ANGUL, ODISHA

Contract No: PNPM/PC-183/E/8003/NCB

NOTE : Quantities mentioned in the Schedule of Rates are indicative and not exhaustive in nature. Payment shall be made as per actual quantity used/certified at site by Owner's Engineer-in-charge. Quantities indicated in Schedule of Rates are approximate and subject to variation on either side. The quantity of individual item may be deleted. Contractor shall not be entitled for any compensation on this account and the quoted rates shall hold good for such quantity variations etc. Payments on bills shall, however, be made on actual measurements of quantities of work done as per approved drawings. Goods & Services Tax (GST) is applicable @ 18% on the quoted rates (being Works Contract).

Name of the Bidder/ Bidding Firm / Company :	
--	--

SCHEDULE OF RATE (Rev. 0) (This BOQ template must not be modified/replaced by the bidder and the same should be uploaded after filling the relevant columns, else the bidder is liable to be rejected for this tender. Bidders are allowed to enter the Bidder Name and Values only)

NUMBER #	TEXT #	NUMBER #	TEXT #	NUMBER #	NUMBER #	NUMBER #	TEXT #
Sl. No.	Item Description	Quantity	Units	BASIC RATE In Figures To be entered by the Bidder in Rs. P	TOTAL AMOUNT Incl. All taxes & duties (Excl. GST) in Rs. P	TOTAL AMOUNT Incl. All taxes , duties and GST in Rs. P	TOTAL AMOUNT Incl. All taxes, duties and GST In Words
4.00	CABLES (HT & LT)				0.00	0.00	INR Zero Only
4.10	Supply of 11KV (UE) grade XLPE insulated, PVC inner sheathed, armoured, FRLS PVC (ST2) type outer sheath as per Technical specification - Electrical, Technical Specification - Cables (Doc. No. PC183-TS-0815) etc				0.00	0.00	INR Zero Only
4.11	3Cx240 (Al)	2900	Mtrs.		0.00	0.00	INR Zero Only
4.12	3Cx400 (Al)	100	Mtrs.		0.00	0.00	INR Zero Only
4.20	Supply of 3.3KV (UE) grade XLPE insulated, PVC inner sheathed, armoured, FRLS PVC (ST2) type outer sheath as per Technical specification - Electrical, Technical Specification - Cables (Doc. No. PC183-TS-0815) etc.				0.00	0.00	INR Zero Only
4.21	3Cx240 (Al)	200	Mtrs.		0.00	0.00	INR Zero Only
4.22	Supply of 1.1KV grade, XLPE insulated, PVC inner sheath, armoured, FRLS PVC (ST2) type outer sheath as per Technical specification - Electrical, Technical Specification - Cables (Doc. No. PC183-TS-0815) etc.				0.00	0.00	INR Zero Only
4.23	3.5C x 630 mm ² (Al)	1200	Mtrs.		0.00	0.00	INR Zero Only
4.24	3.5C x 400 mm ² (Al)	200	Mtrs.		0.00	0.00	INR Zero Only
4.25	3.5C x 300 mm ² (Al)	150	Mtrs.		0.00	0.00	INR Zero Only
4.26	3.5C x 240 mm ² (Al)	1300	Mtrs.		0.00	0.00	INR Zero Only
4.27	3.5C x 150 mm ² (Al)	2600	Mtrs.		0.00	0.00	INR Zero Only
4.28	3.5C x 120 mm ² (Al)	1600	Mtrs.		0.00	0.00	INR Zero Only
4.29	3.5C x 70 mm ² (Al)	200	Mtrs.		0.00	0.00	INR Zero Only
4.30	3.5C x 50 mm ² (Al)	400	Mtrs.		0.00	0.00	INR Zero Only

Validate

Print

Help

Item Rate BoQ

Tender Inviting Authority: Projects & Development India Limited, Noida

Name of Work: TENDER FOR SUPPLY CUM ERECTION OF ELECTRICAL & INSTRUMENTATION WORKS ON ITEM RATE BASIS AT TALCHER FERTILIZERS LTD., ANGUL, ODISHA

Contract No: PNPM/PC-183/E/8003/NCB

NOTE : Quantities mentioned in the Schedule of Rates are indicative and not exhaustive in nature. Payment shall be made as per actual quantity used/certified at site by Owner's Engineer-in-charge. Quantities indicated in Schedule of Rates are approximate and subject to variation on either side. The quantity of individual item may be deleted. Contractor shall not be entitled for any compensation on this account and the quoted rates shall hold good for such quantity variations etc. Payments on bills shall, however, be made on actual measurements of quantities of work done as per approved drawings. Goods & Services Tax (GST) is applicable @ 18% on the quoted rates (being Works Contract)

Name of the Bidder/ Bidding Firm / Company :	
--	--

SCHEDULE OF RATE (Rev. 0) (This BOQ template must not be modified/replaced by the bidder and the same should be uploaded after filling the relevant columns, else the bidder is liable to be rejected for this tender. Bidders are allowed to enter the Bidder Name and Values only)

NUMBER #	TEXT #	NUMBER #	TEXT #	NUMBER #	NUMBER #	NUMBER #	TEXT #
Sl. No.	Item Description	Quantity	Units	BASIC RATE In Figures To be entered by the Bidder in Rs. P	TOTAL AMOUNT Incl. All taxes & duties (Excl. GST) in Rs. P	TOTAL AMOUNT Incl. All taxes , duties and GST in Rs. P	TOTAL AMOUNT Incl. All taxes, duties and GST In Words
4.33	4C x 35 mm ² (Al)	400	Mtrs.		0.00	0.00	INR Zero Only
4.34	4C x 25 mm ² (Al)	400	Mtrs.		0.00	0.00	INR Zero Only
4.35	4C x 16 mm ² (Al)	4200	Mtrs.		0.00	0.00	INR Zero Only
4.36	3C x 120 mm ² (Al)	300	Mtrs.		0.00	0.00	INR Zero Only
4.37	3C x 70 mm ² (Al)	100	Mtrs.		0.00	0.00	INR Zero Only
4.38	3C x 50 mm ² (Al)	50	Mtrs.		0.00	0.00	INR Zero Only
4.39	3C x 35 mm ² (Al)	200	Mtrs.		0.00	0.00	INR Zero Only
4.40	3C x 25 mm ² (Al)	1000	Mtrs.		0.00	0.00	INR Zero Only
4.41	3C x 10 mm ² (Cu)	100	Mtrs.		0.00	0.00	INR Zero Only
4.42	3C x 6 mm ² (Cu)	600	Mtrs.		0.00	0.00	INR Zero Only
4.43	3C x 4 mm ² (Cu)	600	Mtrs.		0.00	0.00	INR Zero Only
4.44	3C x 2.5 mm ² (Cu)	3000	Mtrs.		0.00	0.00	INR Zero Only
4.45	5C x 2.5 mm ² (Cu)	200	Mtrs.		0.00	0.00	INR Zero Only
4.46	7C x 2.5 mm ² (Cu)	200	Mtrs.		0.00	0.00	INR Zero Only
4.47	12C x 2.5 mm ² (Cu)	1200	Mtrs.		0.00	0.00	INR Zero Only
4.48	19C x 2.5 mm ² (Cu)	600	Mtrs.		0.00	0.00	INR Zero Only
4.49	1Cx185 mm ² (Al) Unarmoured	400	Mtrs.		0.00	0.00	INR Zero Only
4.50	1Cx16 mm ² (Al) Unarmoured	500	Mtrs.		0.00	0.00	INR Zero Only
4.51	Supply of 6 Fiber multi mode FO Cable suitable for relay to relay distance of approx 2 km for line differential protection with all accessories for termination , this also include splicing, jointing as per	600	Mtrs.		0.00	0.00	INR Zero Only

Validate

Print

Help

Item Rate BoQ

Tender Inviting Authority: Projects & Development India Limited, Noida

Name of Work: TENDER FOR SUPPLY CUM ERECTION OF ELECTRICAL & INSTRUMENTATION WORKS ON ITEM RATE BASIS AT TALCHER FERTILIZERS LTD., ANGUL, ODISHA

Contract No: PNPM/PC-183/E/8003/NCB

NOTE : Quantities mentioned in the Schedule of Rates are indicative and not exhaustive in nature. Payment shall be made as per actual quantity used/certified at site by Owner's Engineer-in-charge. Quantities indicated in Schedule of Rates are approximate and subject to variation on either side. The quantity of individual item may be deleted. Contractor shall not be entitled for any compensation on this account and the quoted rates shall hold good for such quantity variations etc. Payments on bills shall, however, be made on actual measurements of quantities of work done as per approved drawings. Goods & Services Tax (GST) is applicable @ 18% on the quoted rates (being Works Contract)

Name of the Bidder/ Bidding Firm / Company :	
--	--

SCHEDULE OF RATE (Rev. 0) (This BOQ template must not be modified/replaced by the bidder and the same should be uploaded after filling the relevant columns, else the bidder is liable to be rejected for this tender. Bidders are allowed to enter the Bidder Name and Values only)

NUMBER #	TEXT #	NUMBER #	TEXT #	NUMBER #	NUMBER #	NUMBER #	TEXT #
Sl. No.	Item Description	Quantity	Units	BASIC RATE In Figures To be entered by the Bidder in Rs. P	TOTAL AMOUNT Incl. All taxes & duties (Excl. GST) in Rs. P	TOTAL AMOUNT Incl. All taxes , duties and GST in Rs. P	TOTAL AMOUNT Incl. All taxes, duties and GST In Words
4.53	Supply of prefabricated ladder type GI cable trays and their accessories i.e. supply of all hardware required i.e. J-hooks, GI Nut, Bolt, Washers, coupling plate etc. of following sizes as per Technical specification - Electrical, Technical Specification - Cables (Doc. No. PC183-TS-0816) etc.				0.00	0.00	INR Zero Only
4.54	Straight Run Cable Trays				0.00	0.00	INR Zero Only
4.55	600 mm wide	1900	Mtrs.		0.00	0.00	INR Zero Only
4.56	450 mm wide	300	Mtrs.		0.00	0.00	INR Zero Only
4.57	300 mm wide	700	Mtrs.		0.00	0.00	INR Zero Only
4.58	150 mm wide	200	Mtrs.		0.00	0.00	INR Zero Only
4.59	Horizontal Bends				0.00	0.00	INR Zero Only
4.60	600 mm wide, 700 mm radius	20	Nos.		0.00	0.00	INR Zero Only
4.61	450 mm wide, 700 mm radius	15	Nos.		0.00	0.00	INR Zero Only
4.62	300 mm wide, 700 mm radius	60	Nos.		0.00	0.00	INR Zero Only
4.63	150 mm wide	20	Nos.		0.00	0.00	INR Zero Only
4.64	Vertical Inside Bends				0.00	0.00	INR Zero Only
4.65	600mm wide, 1000mm radius	10	Nos.		0.00	0.00	INR Zero Only
4.66	450 mm wide, 1000mm radius	10	Nos.		0.00	0.00	INR Zero Only
4.67	300 mm wide, 1000mm radius	30	Nos.		0.00	0.00	INR Zero Only
4.68	150 mm wide	20	Nos.		0.00	0.00	INR Zero Only
4.69	Vertical Outside Bends				0.00	0.00	INR Zero Only
4.70	600 mm wide, 1000 mm radius	10	Nos.		0.00	0.00	INR Zero Only

Validate

Print

Help

Item Rate BoQ

Tender Inviting Authority: Projects & Development India Limited, Noida

Name of Work: TENDER FOR SUPPLY CUM ERECTION OF ELECTRICAL & INSTRUMENTATION WORKS ON ITEM RATE BASIS AT TALCHER FERTILIZERS LTD., ANGUL, ODISHA

Contract No: PNPM/PC-183/E/8003/NCB

NOTE : Quantities mentioned in the Schedule of Rates are indicative and not exhaustive in nature. Payment shall be made as per actual quantity used/certified at site by Owner's Engineer-in-charge. Quantities indicated in Schedule of Rates are approximate and subject to variation on either side. The quantity of individual item may be deleted. Contractor shall not be entitled for any compensation on this account and the quoted rates shall hold good for such quantity variations etc. Payments on bills shall, however, be made on actual measurements of quantities of work done as per approved drawings. Goods & Services Tax (GST) is applicable @ 18% on the quoted rates (being Works Contract).

Name of the Bidder/ Bidding Firm / Company :	
--	--

SCHEDULE OF RATE (Rev. 0) (This BOQ template must not be modified/replaced by the bidder and the same should be uploaded after filling the relevant columns, else the bidder is liable to be rejected for this tender. Bidders are allowed to enter the Bidder Name and Values only)

NUMBER #	TEXT #	NUMBER #	TEXT #	NUMBER #	NUMBER #	NUMBER #	TEXT #
Sl. No.	Item Description	Quantity	Units	BASIC RATE In Figures To be entered by the Bidder in Rs. P	TOTAL AMOUNT Incl. All taxes & duties (Excl. GST) in Rs. P	TOTAL AMOUNT Incl. All taxes , duties and GST in Rs. P	TOTAL AMOUNT Incl. All taxes, duties and GST In Words
4.73	150 mm wide	20	Nos.		0.00	0.00	INR Zero Only
4.74	Reducer				0.00	0.00	INR Zero Only
4.75	600 mm / 450 mm wide	10	Nos.		0.00	0.00	INR Zero Only
4.76	450/300mm wide	10	Nos.		0.00	0.00	INR Zero Only
4.77	300/150mm wide	10	Nos.		0.00	0.00	INR Zero Only
4.78	Regular Tees				0.00	0.00	INR Zero Only
4.79	600 mm wide , 700 mm radius	5	Nos.		0.00	0.00	INR Zero Only
4.80	450 mm wide, 700 mm radius	8	Nos.		0.00	0.00	INR Zero Only
4.81	Cross				0.00	0.00	INR Zero Only
4.82	600 mm wide , 700 mm radius	10	Nos.		0.00	0.00	INR Zero Only
4.83	450 mm wide, 700 mm radius	5	Nos.		0.00	0.00	INR Zero Only
4.84	EARTHING AND LIGHTNING PROTECTION				0.00	0.00	INR Zero Only
4.85	Supply of GI earth strip / Wire conductors of following sizes as per PDS attached with TS (with min. coating 610 gm / sq. m) of following sizes: -				0.00	0.00	INR Zero Only
4.86	75 mm x 10 mm	1000	Mtrs.		0.00	0.00	INR Zero Only
4.87	50 mm x 6 mm	800	Mtrs.		0.00	0.00	INR Zero Only
4.88	35mm x 6mm	100	Mtrs.		0.00	0.00	INR Zero Only
4.89	GI wire Rope (8 SWG)	30	Kg		0.00	0.00	INR Zero Only
4.90	Spares for Two Years Operation (Mandatory)				0.00	0.00	INR Zero Only
4.91	Supply of spares of following equipments				0.00	0.00	INR Zero Only
4.92	Capacitor Bank				0.00	0.00	INR Zero Only

Validate

Print

Help

Item Rate BoQ

Tender Inviting Authority: Projects & Development India Limited, Noida

Name of Work: TENDER FOR SUPPLY CUM ERECTION OF ELECTRICAL & INSTRUMENTATION WORKS ON ITEM RATE BASIS AT TALCHER FERTILIZERS LTD., ANGUL, ODISHA

Contract No: PNPM/PC-183/E/8003/NCB

NOTE : Quantities mentioned in the Schedule of Rates are indicative and not exhaustive in nature. Payment shall be made as per actual quantity used/certified at site by Owner's Engineer-in-charge. Quantities indicated in Schedule of Rates are approximate and subject to variation on either side. The quantity of individual item may be deleted. Contractor shall not be entitled for any compensation on this account and the quoted rates shall hold good for such quantity variations etc. Payments on bills shall, however, be made on actual measurements of quantities of work done as per approved drawings. Goods & Services Tax (GST) is applicable @ 18% on the quoted rates (being Works Contract)

Name of the Bidder/ Bidding Firm / Company :	
--	--

SCHEDULE OF RATE (Rev. 0) (This BOQ template must not be modified/replaced by the bidder and the same should be uploaded after filling the relevant columns, else the bidder is liable to be rejected for this tender. Bidders are allowed to enter the Bidder Name and Values only)

NUMBER #	TEXT #	NUMBER #	TEXT #	NUMBER #	NUMBER #	NUMBER #	TEXT #
Sl. No.	Item Description	Quantity	Units	BASIC RATE In Figures To be entered by the Bidder in Rs. P	TOTAL AMOUNT Incl. All taxes & duties (Excl. GST) in Rs. P	TOTAL AMOUNT Incl. All taxes , duties and GST in Rs. P	TOTAL AMOUNT Incl. All taxes, duties and GST In Words
4.95	PA system				0.00	0.00	INR Zero Only
4.96	Electronic card for central exchange	1	Nos.		0.00	0.00	INR Zero Only
4.97	Electronic Amplifier card for FCS	1	Nos.		0.00	0.00	INR Zero Only
4.98	WP speaker of each type`	5	Nos.		0.00	0.00	INR Zero Only
4.99	FLP speaker	1	Nos.		0.00	0.00	INR Zero Only
5.00	Transformer (2000 KVA, 11/0.433 kV Transformer)				0.00	0.00	INR Zero Only
5.01	Bushings complete with accessories for all 3 phase & neutral for all voltage grades.	1	Set		0.00	0.00	INR Zero Only
5.02	Complete set of gaskets	1	No.		0.00	0.00	INR Zero Only
5.03	Equaliser pipe and Explosion vent diaphragm	1	Set		0.00	0.00	INR Zero Only
5.04	PRV with alarm and trip	1	Set		0.00	0.00	INR Zero Only
5.05	Oil Level Gauge	1	No.		0.00	0.00	INR Zero Only
5.06	Complete charge of Silica gel with breather	1	Set		0.00	0.00	INR Zero Only
5.07	Gland packing / O-rings for every valve	1	Set		0.00	0.00	INR Zero Only
5.08	Buchholz Relay	1	No.		0.00	0.00	INR Zero Only
5.09	Analogue type OTI	1	No.		0.00	0.00	INR Zero Only
5.10	Analogue type WTI	1	No.		0.00	0.00	INR Zero Only
5.11	Radiator(one set of each type)	1	Set		0.00	0.00	INR Zero Only
5.12	Complte set of valve(1 no. of each type)	1	Set		0.00	0.00	INR Zero Only
5.13	Support insulator(HV Side)	1	Nos.		0.00	0.00	INR Zero Only
5.14	Support insulator(LV Side)	1	Nos.		0.00	0.00	INR Zero Only
5.15	Conservator gauqe Glass/Sealing	1	No.		0.00	0.00	INR Zero Only

Validate

Print

Help

Item Rate BoQ

Tender Inviting Authority: Projects & Development India Limited, Noida

Name of Work: TENDER FOR SUPPLY CUM ERECTION OF ELECTRICAL & INSTRUMENTATION WORKS ON ITEM RATE BASIS AT TALCHER FERTILIZERS LTD., ANGUL, ODISHA

Contract No: PNPM/PC-183/E/8003/NCB

NOTE : Quantities mentioned in the Schedule of Rates are indicative and not exhaustive in nature. Payment shall be made as per actual quantity used/certified at site by Owner's Engineer-in-charge. Quantities indicated in Schedule of Rates are approximate and subject to variation on either side. The quantity of individual item may be deleted. Contractor shall not be entitled for any compensation on this account and the quoted rates shall hold good for such quantity variations etc. Payments on bills shall, however, be made on actual measurements of quantities of work done as per approved drawings. Goods & Services Tax (GST) is applicable @ 18% on the quoted rates (being Works Contract).

Name of the Bidder/ Bidding Firm / Company :	
--	--

SCHEDULE OF RATE (Rev. 0) (This BOQ template must not be modified/replaced by the bidder and the same should be uploaded after filling the relevant columns, else the bidder is liable to be rejected for this tender. Bidders are allowed to enter the Bidder Name and Values only)

NUMBER #	TEXT #	NUMBER #	TEXT #	NUMBER #	NUMBER #	NUMBER #	TEXT #
Sl. No.	Item Description	Quantity	Units	BASIC RATE In Figures To be entered by the Bidder in Rs. P	TOTAL AMOUNT Incl. All taxes & duties (Excl. GST) in Rs. P	TOTAL AMOUNT Incl. All taxes , duties and GST in Rs. P	TOTAL AMOUNT Incl. All taxes, duties and GST In Words
5.18	CT for REF	1	No.		0.00	0.00	INR Zero Only
5.19	CT for SBEF	1	No.		0.00	0.00	INR Zero Only
5.20	Transformer (1600 KVA, 11/0.433 kV Transformer)				0.00	0.00	INR Zero Only
5.21	Bushings complete with accessories for all 3 phase & neutral for all voltage grades.	1	Set		0.00	0.00	INR Zero Only
5.22	Complete set of gaskets	1	No.		0.00	0.00	INR Zero Only
5.23	Equaliser pipe and Explosion vent diaphragm	1	Set		0.00	0.00	INR Zero Only
5.24	PRV with alarm and trip	1	Set		0.00	0.00	INR Zero Only
5.25	Oil Level Gauge	1	No.		0.00	0.00	INR Zero Only
5.26	Complete charge of Silica gel with breather	1	Set		0.00	0.00	INR Zero Only
5.27	Gland packing / O-rings for every valve	1	Set		0.00	0.00	INR Zero Only
5.28	Buchholz Relay	1	No.		0.00	0.00	INR Zero Only
5.29	Analogue type OTI	1	No.		0.00	0.00	INR Zero Only
5.30	Analogue type WTI	1	No.		0.00	0.00	INR Zero Only
5.31	Radiator(one set of each type)	1	Set		0.00	0.00	INR Zero Only
5.32	Complete set of valve(1 no. of each type)	1	Set		0.00	0.00	INR Zero Only
5.33	Support insulator(HV Side)	1	Nos.		0.00	0.00	INR Zero Only
5.34	Support insulator(LV Side)	1	Nos.		0.00	0.00	INR Zero Only
5.35	Conservator gauge Glass/Sealing	1	No.		0.00	0.00	INR Zero Only
5.36	Thermister with space heater for M.B	1	No.		0.00	0.00	INR Zero Only
5.37	3 Pin switch & socket	1	No.		0.00	0.00	INR Zero Only
5.38	CT for REF	1	No.		0.00	0.00	INR Zero Only

Validate

Print

Help

Item Rate BoQ

Tender Inviting Authority: Projects & Development India Limited, Noida

Name of Work: TENDER FOR SUPPLY CUM ERECTION OF ELECTRICAL & INSTRUMENTATION WORKS ON ITEM RATE BASIS AT TALCHER FERTILIZERS LTD., ANGUL, ODISHA

Contract No: PNPM/PC-183/E/8003/NCB

NOTE : Quantities mentioned in the Schedule of Rates are indicative and not exhaustive in nature. Payment shall be made as per actual quantity used/certified at site by Owner's Engineer-in-charge. Quantities indicated in Schedule of Rates are approximate and subject to variation on either side. The quantity of individual item may be deleted. Contractor shall not be entitled for any compensation on this account and the quoted rates shall hold good for such quantity variations etc. Payments on bills shall, however, be made on actual measurements of quantities of work done as per approved drawings. Goods & Services Tax (GST) is applicable @ 18% on the quoted rates (being Works Contract)

Name of the Bidder/ Bidding Firm / Company :	
--	--

SCHEDULE OF RATE (Rev. 0) (This BOQ template must not be modified/replaced by the bidder and the same should be uploaded after filling the relevant columns, else the bidder is liable to be rejected for this tender. Bidders are allowed to enter the Bidder Name and Values only)

NUMBER #	TEXT #	NUMBER #	TEXT #	NUMBER #	NUMBER #	NUMBER #	TEXT #
Sl. No.	Item Description	Quantity	Units	BASIC RATE In Figures To be entered by the Bidder in Rs. P	TOTAL AMOUNT Incl. All taxes & duties (Excl. GST) in Rs. P	TOTAL AMOUNT Incl. All taxes , duties and GST in Rs. P	TOTAL AMOUNT Incl. All taxes, duties and GST In Words
5.41	Bushings complete with accessories for all 3 phase & neutral for all voltage grades.	1	Set		0.00	0.00	INR Zero Only
5.42	Complete set of gaskets	1	No.		0.00	0.00	INR Zero Only
5.43	Equaliser pipe and Explosion vent diaphragm	1	Set		0.00	0.00	INR Zero Only
5.44	PRV with alarm and trip	1	Set		0.00	0.00	INR Zero Only
5.45	Oil Level Gauge	1	No.		0.00	0.00	INR Zero Only
5.46	Complete charge of Silica gel with breather	1	Set		0.00	0.00	INR Zero Only
5.47	Gland packing / O-rings for every valve	1	Set		0.00	0.00	INR Zero Only
5.48	Buchholz Relay	1	No.		0.00	0.00	INR Zero Only
5.49	Analogue type OTI	1	No.		0.00	0.00	INR Zero Only
5.50	Analogue type WTI	1	No.		0.00	0.00	INR Zero Only
5.51	Radiator(one set of each type)	1	Set		0.00	0.00	INR Zero Only
5.52	Complete set of valve(1 no. of each type)	1	Set		0.00	0.00	INR Zero Only
5.53	Support insulator(HV Side)	1	Nos.		0.00	0.00	INR Zero Only
5.54	Support insulator(LV Side)	1	Nos.		0.00	0.00	INR Zero Only
5.55	Conservator gauge Glass/Sealing	1	No.		0.00	0.00	INR Zero Only
5.56	Thermister with space heater for M.B	1	No.		0.00	0.00	INR Zero Only
5.57	3 Pin switch & socket	1	No.		0.00	0.00	INR Zero Only
5.58	CT for REF	1	No.		0.00	0.00	INR Zero Only
5.59	CT for SBEF	1	No.		0.00	0.00	INR Zero Only
5.60	415V LV SWITCHBOARD -				0.00	0.00	INR Zero Only
5.61	2500A, 50KA for 1 sec ACB / 800 A , 50KA for 1 sec ACB				0.00	0.00	INR Zero Only

Validate

Print

Help

Item Rate BoQ

Tender Inviting Authority: Projects & Development India Limited, Noida

Name of Work: TENDER FOR SUPPLY CUM ERECTION OF ELECTRICAL & INSTRUMENTATION WORKS ON ITEM RATE BASIS AT TALCHER FERTILIZERS LTD., ANGUL, ODISHA

Contract No: PNPM/PC-183/E/8003/NCB

NOTE : Quantities mentioned in the Schedule of Rates are indicative and not exhaustive in nature. Payment shall be made as per actual quantity used/certified at site by Owner's Engineer-in-charge. Quantities indicated in Schedule of Rates are approximate and subject to variation on either side. The quantity of individual item may be deleted. Contractor shall not be entitled for any compensation on this account and the quoted rates shall hold good for such quantity variations etc. Payments on bills shall, however, be made on actual measurements of quantities of work done as per approved drawings. Goods & Services Tax (GST) is applicable @ 18% on the quoted rates (being Works Contract).

Name of the Bidder/ Bidding Firm / Company :	
--	--

SCHEDULE OF RATE (Rev. 0) (This BOQ template must not be modified/replaced by the bidder and the same should be uploaded after filling the relevant columns, else the bidder is liable to be rejected for this tender. Bidders are allowed to enter the Bidder Name and Values only)

NUMBER #	TEXT #	NUMBER #	TEXT #	NUMBER #	NUMBER #	NUMBER #	TEXT #
Sl. No.	Item Description	Quantity	Units	BASIC RATE In Figures To be entered by the Bidder in Rs. P	TOTAL AMOUNT Incl. All taxes & duties (Excl. GST) in Rs. P	TOTAL AMOUNT Incl. All taxes , duties and GST in Rs. P	TOTAL AMOUNT Incl. All taxes, duties and GST In Words
5.64	Closing coil	2	Set		0.00	0.00	INR Zero Only
5.65	Secondary isolating contact blocks.	2	Set		0.00	0.00	INR Zero Only
5.66	CONTROL SWITCHES				0.00	0.00	INR Zero Only
5.67	Trip-Neutral-Close Control Switch	1	No.		0.00	0.00	INR Zero Only
5.68	Ammeter Selector Switch	1	No.		0.00	0.00	INR Zero Only
5.69	Voltmeter Selector Switch	1	No.		0.00	0.00	INR Zero Only
5.70	Push Button Element	1	Set		0.00	0.00	INR Zero Only
5.71	Push Button Actuator of each type	1	Set		0.00	0.00	INR Zero Only
5.72	Control Fuse				0.00	0.00	INR Zero Only
5.73	Fuse Link	1	No.		0.00	0.00	INR Zero Only
5.74	Fuse Fitting	1	No.		0.00	0.00	INR Zero Only
5.75	Microprocessor based numerical relay used in incomer ACB feeder	1	No.		0.00	0.00	INR Zero Only
5.76	Microprocessor based numerical relay used in Motor / Outgoing ACB feeder	1	No.		0.00	0.00	INR Zero Only
5.77	MCB of each type & rating)	1	Set		0.00	0.00	INR Zero Only
5.78	CONTACTOR (of each type & rating)	1	Set		0.00	0.00	INR Zero Only
5.79	Overload RELAYS (of each type & rating)	1	Set		0.00	0.00	INR Zero Only
5.80	CT for breaker feeders (Each Rating)	1	Set (3 nos.)		0.00	0.00	INR Zero Only
5.81	CT for other outgoing feeders (Each Rating	1	Set (3 nos.)		0.00	0.00	INR Zero Only
5.82	MCCB / ELCB MCB				0.00	0.00	INR Zero Only

Validate

Print

Help

Item Rate BoQ

Tender Inviting Authority: Projects & Development India Limited, Noida

Name of Work: TENDER FOR SUPPLY CUM ERECTION OF ELECTRICAL & INSTRUMENTATION WORKS ON ITEM RATE BASIS AT TALCHER FERTILIZERS LTD., ANGUL, ODISHA

Contract No: PNPM/PC-183/E/8003/NCB

NOTE : Quantities mentioned in the Schedule of Rates are indicative and not exhaustive in nature. Payment shall be made as per actual quantity used/certified at site by Owner's Engineer-in-charge. Quantities indicated in Schedule of Rates are approximate and subject to variation on either side. The quantity of individual item may be deleted. Contractor shall not be entitled for any compensation on this account and the quoted rates shall hold good for such quantity variations etc. Payments on bills shall, however, be made on actual measurements of quantities of work done as per approved drawings. Goods & Services Tax (GST) is applicable @ 18% on the quoted rates (being Works Contract)

Name of the Bidder/ Bidding Firm / Company :	
--	--

SCHEDULE OF RATE (Rev. 0) (This BOQ template must not be modified/replaced by the bidder and the same should be uploaded after filling the relevant columns, else the bidder is liable to be rejected for this tender. Bidders are allowed to enter the Bidder Name and Values only)

NUMBER #	TEXT #	NUMBER #	TEXT #	NUMBER #	NUMBER #	NUMBER #	TEXT #
Sl. No.	Item Description	Quantity	Units	BASIC RATE In Figures To be entered by the Bidder in Rs. P	TOTAL AMOUNT Incl. All taxes & duties (Excl. GST) in Rs. P	TOTAL AMOUNT Incl. All taxes , duties and GST in Rs. P	TOTAL AMOUNT Incl. All taxes, duties and GST In Words
5.85	4P/TPN MCCB 160 A	2	Nos.		0.00	0.00	INR Zero Only
5.86	4P/TPN MCCB 125 A	2	Nos.		0.00	0.00	INR Zero Only
5.87	4 P/TPN MCCB 63 A	4	Nos.		0.00	0.00	INR Zero Only
5.88	DP RCBO 63 A	6	Nos.		0.00	0.00	INR Zero Only
5.89	DP MCB, 16 A	6	Nos.		0.00	0.00	INR Zero Only
5.90	DP MCB, 32 A	4	Nos.		0.00	0.00	INR Zero Only
5.91	LIGHTING FIXTURE				0.00	0.00	INR Zero Only
5.92	Reflector of each type	5	Set		0.00	0.00	INR Zero Only
5.93	Heat resistant toughened glass cover of each type	5	Set		0.00	0.00	INR Zero Only
5.94	Cable glands of each type	5	Set		0.00	0.00	INR Zero Only
5.95	Allen keys of different sizes as applicable.	3	Nos.		0.00	0.00	INR Zero Only
5.96	45W LED street light fixture	2	Nos.		0.00	0.00	INR Zero Only
5.97	60W LED street light fixture	10	Nos.		0.00	0.00	INR Zero Only
5.98	90 W LED street light fixture	10	Nos.		0.00	0.00	INR Zero Only
5.99	INTERLOCKING SWITCH SOCKET & PLUG				0.00	0.00	INR Zero Only
6.00	Switch of each rating	2	Set		0.00	0.00	INR Zero Only
6.01	Fuse base of each rating	2	Set		0.00	0.00	INR Zero Only
6.02	Fuse of each rating	2	Set		0.00	0.00	INR Zero Only
6.03	Plug Top	2	Nos.		0.00	0.00	INR Zero Only
6.04	11 V ICOG Breaker Panel :BREAKER 11 kV - Trip bar spring and any other spring used in the circuit breaker mechanism	1	Set		0.00	0.00	INR Zero Only

Validate

Print

Help

Item Rate BoQ

Tender Inviting Authority: Projects & Development India Limited, Noida

Name of Work: TENDER FOR SUPPLY CUM ERECTION OF ELECTRICAL & INSTRUMENTATION WORKS ON ITEM RATE BASIS AT TALCHER FERTILIZERS LTD., ANGUL, ODISHA

Contract No: PNPM/PC-183/E/8003/NCB

NOTE : Quantities mentioned in the Schedule of Rates are indicative and not exhaustive in nature. Payment shall be made as per actual quantity used/certified at site by Owner's Engineer-in-charge. Quantities indicated in Schedule of Rates are approximate and subject to variation on either side. The quantity of individual item may be deleted. Contractor shall not be entitled for any compensation on this account and the quoted rates shall hold good for such quantity variations etc. Payments on bills shall, however, be made on actual measurements of quantities of work done as per approved drawings. Goods & Services Tax (GST) is applicable @ 18% on the quoted rates (being Works Contract).

Name of the Bidder/ Bidding Firm / Company :							
SCHEDULE OF RATE (Rev. 0) (This BOQ template must not be modified/replaced by the bidder and the same should be uploaded after filling the relevant columns, else the bidder is liable to be rejected for this tender. Bidders are allowed to enter the Bidder Name and Values only)							
NUMBER #	TEXT #	NUMBER #	TEXT #	NUMBER #	NUMBER #	NUMBER #	TEXT #
Sl. No.	Item Description	Quantity	Units	BASIC RATE In Figures To be entered by the Bidder in Rs. P	TOTAL AMOUNT Incl. All taxes & duties (Excl. GST) in Rs. P	TOTAL AMOUNT Incl. All taxes , duties and GST in Rs. P	TOTAL AMOUNT Incl. All taxes, duties and GST In Words
6.07	11 V ICOG Breaker Panel :BREAKER 11 kV - Secondary Isolating contact blocks	1	Set		0.00	0.00	INR Zero Only
6.08	11 V ICOG Breaker Panel :BREAKER 11 kV - Micro Switch for Spring Charging	1	Set		0.00	0.00	INR Zero Only
6.09	11 V ICOG Breaker Panel :BREAKER 11 kV - Micro Switch for Service/Test position	1	Set		0.00	0.00	INR Zero Only
6.10	11 V ICOG Breaker Panel :BREAKER 11 kV - Rack in/Rack out handle	1	No.		0.00	0.00	INR Zero Only
6.11	11 V ICOG Breaker Panel :BREAKER 11 kV - Spring Charging handle	1	No.		0.00	0.00	INR Zero Only
6.12	11 V ICOG Breaker Panel :BREAKER 11 kV - Door panel key	1	Set		0.00	0.00	INR Zero Only
6.13	11 V ICOG Breaker Panel : CONTROL SWITCHES- Trip-Neutral-Close Control Switch	1	No.		0.00	0.00	INR Zero Only
6.14	11 V ICOG Breaker Panel : CONTROL SWITCHES- Local-Remote or Auto-Manual Selector Switch	1	No.		0.00	0.00	INR Zero Only
6.15	11 V ICOG Breaker Panel : CONTROL SWITCHES- Ammeter Selector Switch	1	No.		0.00	0.00	INR Zero Only
6.16	11 V ICOG Breaker Panel : CONTROL SWITCHES- Voltmeter Selector Switch	1	No.		0.00	0.00	INR Zero Only
6.17	11 V ICOG Breaker Panel : Push Buttons-Push Button Element of each type	1	Set		0.00	0.00	INR Zero Only
6.18	11 V ICOG Breaker Panel : Push Buttons- Push Button Actuator of each type	1	Set		0.00	0.00	INR Zero Only
6.19	Indication Lamps (1 no. of each type)	1	Set		0.00	0.00	INR Zero Only
6.20	Thermostat	1	No.		0.00	0.00	INR Zero Only
6.21	MINIATURE CIRCUIT BREAKER (OF EACH RATING)	1	Set		0.00	0.00	INR Zero Only
6.22	METERS: Ammeter	1	Set		0.00	0.00	INR Zero Only
6.23	METERS: Voltmeter	1	No.		0.00	0.00	INR Zero Only
7.00	PART-B : ERECTION, TESTING & COMMISSIONING OF ELECTRICAL ITEMS				0.00	0.00	INR Zero Only
7.11	415V Switchboard				0.00	0.00	INR Zero Only

Validate

Print

Help

Item Rate BoQ

Tender Inviting Authority: Projects & Development India Limited, Noida

Name of Work: TENDER FOR SUPPLY CUM ERECTION OF ELECTRICAL & INSTRUMENTATION WORKS ON ITEM RATE BASIS AT TALCHER FERTILIZERS LTD., ANGUL, ODISHA

Contract No: PNP/PC-183/E/8003/NCB

NOTE : Quantities mentioned in the Schedule of Rates are indicative and not exhaustive in nature. Payment shall be made as per actual quantity used/certified at site by Owner's Engineer-in-charge. Quantities indicated in Schedule of Rates are approximate and subject to variation on either side. The quantity of individual item may be deleted. Contractor shall not be entitled for any compensation on this account and the quoted rates shall hold good for such quantity variations etc. Payments on bills shall, however, be made on actual measurements of quantities of work done as per approved drawings. Goods & Services Tax (GST) is applicable @ 18% on the quoted rates (being Works Contract)

Name of the Bidder/ Bidding Firm / Company :							
SCHEDULE OF RATE (Rev. 0) (This BOQ template must not be modified/replaced by the bidder and the same should be uploaded after filling the relevant columns, else the bidder is liable to be rejected for this tender. Bidders are allowed to enter the Bidder Name and Values only)							
NUMBER #	TEXT #	NUMBER #	TEXT #	NUMBER #	NUMBER #	NUMBER #	TEXT #
Sl. No.	Item Description	Quantity	Units	BASIC RATE In Figures To be entered by the Bidder in Rs. P	TOTAL AMOUNT Incl. All taxes & duties (Excl. GST) in Rs. P	TOTAL AMOUNT Incl. All taxes , duties and GST in Rs. P	TOTAL AMOUNT Incl. All taxes, duties and GST In Words
7.12	Handling, installation including transportation from store to site of installation, erection, testing and commissioning of 415V power-control-centres and bus duct, motor control centres, soft starters, APFC panel etc. assembling as required, unpacking, inspection, fabrication and erection of foundation channel, installation on the foundation channels, welding, aligning, leveling, grouting, assembling, fitting of all accessories / instruments / relays, relay coordination, CT, PT, Numerical Relay, interconnection of shipping sections and inter panel wiring as necessary, inter bus bar jointing, bus bar connection, installation, erection, testing and commissioning of bus duct, as per drawing, specifications and directions of the Site Engineer/ Engineer-in-Charge including cost of all materials, tools labour etc. complete in all respect including supply of WP double compression rolled aluminium cable glands & lugs (Al/Cu/Bimetallic), termination of all power, control cables, installation of thermistor controller, internal wiring, earthing of LT panels & bus duct, making holes for cable entries as required, shrouding, plugging/sealing of all unused cable entries and other holes for making the same dust and vermin proof etc. complete as per drawings, specification and directions of Site Engineer /Engineer-in-Charge				0.00	0.00	INR Zero Only
7.13	415V, 3 Ph & N, 3200 A, 50kA for 1 sec., Draw out type, Double front, indoor type Low Voltage switchboard (Power & Motor Control Centre, PMCC) approximately 14 Bay	1	No.		0.00	0.00	INR Zero Only
7.14	415V, 3 Ph & N, 2500 A, 50kA for 1 sec., Draw out type, Double front, indoor type Low Voltage switchboard (Power & Motor Control Centre, PMCC) approximately 12 Bay	1	No.		0.00	0.00	INR Zero Only
7.15	415V, 3 Ph & N, 2500 A, 50kA for 1 sec., Draw out type, Double front, indoor type Low Voltage switchboard (Emergency Power & Motor Control Centre, EPMCC) approximately 10 Bay	1	No.		0.00	0.00	INR Zero Only
7.16	TRANSFORMER				0.00	0.00	INR Zero Only

Validate

Print

Help

Item Rate BoQ

Tender Inviting Authority: Projects & Development India Limited, Noida

Name of Work: TENDER FOR SUPPLY CUM ERECTION OF ELECTRICAL & INSTRUMENTATION WORKS ON ITEM RATE BASIS AT TALCHER FERTILIZERS LTD., ANGUL, ODISHA

Contract No: PNPM/PC-183/E/8003/NCB

NOTE : Quantities mentioned in the Schedule of Rates are indicative and not exhaustive in nature. Payment shall be made as per actual quantity used/certified at site by Owner's Engineer-in-charge. Quantities indicated in Schedule of Rates are approximate and subject to variation on either side. The quantity of individual item may be deleted. Contractor shall not be entitled for any compensation on this account and the quoted rates shall hold good for such quantity variations etc. Payments on bills shall, however, be made on actual measurements of quantities of work done as per approved drawings. Goods & Services Tax (GST) is applicable @ 18% on the quoted rates (being Works Contract)

Name of the Bidder/ Bidding Firm / Company :							
SCHEDULE OF RATE (Rev. 0) (This BOQ template must not be modified/replaced by the bidder and the same should be uploaded after filling the relevant columns, else the bidder is liable to be rejected for this tender. Bidders are allowed to enter the Bidder Name and Values only)							
NUMBER #	TEXT #	NUMBER #	TEXT #	NUMBER #	NUMBER #	NUMBER #	TEXT #
Sl. No.	Item Description	Quantity	Units	BASIC RATE In Figures To be entered by the Bidder in Rs. P	TOTAL AMOUNT Incl. All taxes & duties (Excl. GST) in Rs. P	TOTAL AMOUNT Incl. All taxes , duties and GST in Rs. P	TOTAL AMOUNT Incl. All taxes, duties and GST In Words
7.17	Handling, storage at site, transportation from store to site of installation, erection, installation, testing and commissioning of (outdoor type - ONAN cooled) transformer, erection of transformer over the rail and foundation channels, including transporting, unpacking, rigging, aligning, levelling, grouting, assembling, fitting and fixing all accessories/instruments/relays etc. supplied separately if any, etc., supply of WP double compression rolled aluminium cable glands & suitable lugs (Al/Cu/Bimetalic), making all the interconnections & termination of all power (HT/LT) cables, control cables / busbar etc. as per drawings, including earthing/grounding of transformer neutral as per drawing, equipments needed to completely install and commission the transformer Job complete in all respect including cost of all labour, tools and materials and all services rendered complete, installation of thermistor controller, internal wiring, earthing of LT panel etc. complete as per drawings and directions of the Site Engineer / engineer-in-Charge. Note: Commissioning assistance shall be provided by the supplier of the Transformer as and when required at site.				0.00	0.00	INR Zero Only
7.18	2000 KVA, 11/0.433 kV Transformer (ONAN), 50 Hz, Dyn11 with off load tap changer	2	Nos.		0.00	0.00	INR Zero Only
7.19	1600 KVA, 11/0.433 kV Transformer (ONAN), 50 Hz, Dyn11 with off load tap changer	2	Nos.		0.00	0.00	INR Zero Only
7.20	1250 KVA, 11/0.433 kV Transformer (ONAN), 50 Hz, Dyn11 with off load tap changer	2	Nos.		0.00	0.00	INR Zero Only
7.21	TRANSFORMER OIL :				0.00	0.00	INR Zero Only

Item Rate BoQ

Tender Inviting Authority: Projects & Development India Limited, Noida

Name of Work: TENDER FOR SUPPLY CUM ERECTION OF ELECTRICAL & INSTRUMENTATION WORKS ON ITEM RATE BASIS AT TALCHER FERTILIZERS LTD., ANGUL, ODISHA

Contract No: PNPM/PC-183/E/8003/NCB

NOTE : Quantities mentioned in the Schedule of Rates are indicative and not exhaustive in nature. Payment shall be made as per actual quantity used/certified at site by Owner's Engineer-in-charge. Quantities indicated in Schedule of Rates are approximate and subject to variation on either side. The quantity of individual item may be deleted. Contractor shall not be entitled for any compensation on this account and the quoted rates shall hold good for such quantity variations etc. Payments on bills shall, however, be made on actual measurements of quantities of work done as per approved drawings. Goods & Services Tax (GST) is applicable @ 18% on the quoted rates (being Works Contract)

Name of the Bidder/ Bidding Firm / Company :	
--	--

SCHEDULE OF RATE (Rev. 0) (This BOQ template must not be modified/replaced by the bidder and the same should be uploaded after filling the relevant columns, else the bidder is liable to be rejected for this tender. Bidders are allowed to enter the Bidder Name and Values only)

NUMBER #	TEXT #	NUMBER #	TEXT #	NUMBER #	NUMBER #	NUMBER #	TEXT #
Sl. No.	Item Description	Quantity	Units	BASIC RATE In Figures To be entered by the Bidder in Rs. P	TOTAL AMOUNT Incl. All taxes & duties (Excl. GST) in Rs. P	TOTAL AMOUNT Incl. All taxes , duties and GST in Rs. P	TOTAL AMOUNT Incl. All taxes, duties and GST In Words
7.22	Centrifuging,filtering and dehydrating of the transformer oil of transformer to improve insulation level to the value recommended as per the relevant ISS and the manufacturer's recommendations and as per specifications,and directions of the Site Engineer/Engineer-in-Charge including supply of labour, tools and materials and all services rendered complete.				0.00	0.00	INR Zero Only
7.23	4580 Ltrs. approx Oil.	100000	Ltrs		0.00	0.00	INR Zero Only
7.24	HT CAPACITOR BANK				0.00	0.00	INR Zero Only
7.25	Erection, Installation including within site transportation, testing and commissioning of HT capacitor bank along with all installation of all accessories including termination of all control cables, installation on foundation channels, drilling, cutting, welding, aligning, levelling, grouting, assembling and fitting all accessories / instruments / relays connection of 230 V Supply / battery bank 220 V DC supply, earthing of HT capacitor bank, making all the interconnections/ outgoing/incoming LT power & control cable connections including making holes for cable entries as required with materials i.e. WP double compression Cable glands, end lugs, labour, tools and tackles, consumables etc , as per drawings, specification and directions of Site Engineer / Engineer-in-Charge. Note: Commissioning assistance shall be provided by the supplier of the HT capacitor bank as and when required at site.				0.00	0.00	INR Zero Only
7.26	300 KVAR Capacitor bank (2 Steps of 100KVAR,200KVAR each), 3.3 KV Voltage Level	2	Nos.		0.00	0.00	INR Zero Only

Item Rate BoQ

Tender Inviting Authority: Projects & Development India Limited, Noida

Name of Work: TENDER FOR SUPPLY CUM ERECTION OF ELECTRICAL & INSTRUMENTATION WORKS ON ITEM RATE BASIS AT TALCHER FERTILIZERS LTD., ANGUL, ODISHA

Contract No: PNP/PC-183/E/8003/NCB

NOTE : Quantities mentioned in the Schedule of Rates are indicative and not exhaustive in nature. Payment shall be made as per actual quantity used/certified at site by Owner's Engineer-in-charge. Quantities indicated in Schedule of Rates are approximate and subject to variation on either side. The quantity of individual item may be deleted. Contractor shall not be entitled for any compensation on this account and the quoted rates shall hold good for such quantity variations etc. Payments on bills shall, however, be made on actual measurements of quantities of work done as per approved drawings. Goods & Services Tax (GST) is applicable @ 18% on the quoted rates (being Works Contract)

Name of the Bidder/ Bidding Firm / Company :	
--	--

SCHEDULE OF RATE (Rev. 0) (This BOQ template must not be modified/replaced by the bidder and the same should be uploaded after filling the relevant columns, else the bidder is liable to be rejected for this tender. Bidders are allowed to enter the Bidder Name and Values only)

NUMBER #	TEXT #	NUMBER #	TEXT #	NUMBER #	NUMBER #	NUMBER #	TEXT #
Sl. No.	Item Description	Quantity	Units	BASIC RATE In Figures To be entered by the Bidder in Rs. P	TOTAL AMOUNT Incl. All taxes & duties (Excl. GST) in Rs. P	TOTAL AMOUNT Incl. All taxes , duties and GST in Rs. P	TOTAL AMOUNT Incl. All taxes, duties and GST In Words
7.28	ELECTRIC HEATER WITH THYRISTOR CONTROL PANEL:				0.00	0.00	INR Zero Only
7.29	Handling, installation including transportation from owner's store to site of installation, erection, testing and commissioning of 690V/415 V, owner supplied electric heater alongwith thyristor control panels, J.B., LCS, etc. assembling as required, installation on the already made foundation channel, aligning, levelling, grouting, assembling, making all the inter connections / outgoing / incoming power & control cable / connection including making holes for cable entries as required as per drawing, specifications and directions of the Site Engineer/Engineer-in-Charge including cost of all materials, tools labour etc. complete in all respect including termination of all power, control cables, installation of thermistor controller, internal wiring, earthing of control panels, supply of FLP cable glands and suitable cable lugs (Al/Cu/Bimetalic) etc. complete as drawings, specification and directions of Site Engineer / Engineer-in-Charge etc.	1	Nos.		0.00	0.00	INR Zero Only
7.30	TESTING & COMMISSIONING of MOTORS				0.00	0.00	INR Zero Only
7.31	HT MOTOR (11KV/3.3KV):				0.00	0.00	INR Zero Only
7.32	Testing & commissioning of owner supplied, 3-Phase Squirrel Cage, HT induction Motors. The job includes dehydration of motors, execution of terminal connections with HT power, LT power and control cables, earthing of Motor / Local speed controller, armour of all the cables etc., with materials i.e. FLP double compression rolled aluminium cable glands, Suitable end lugs(Aluminum/copper/Bi metalic), labour, tools and tackles, consumables etc. including dehydration of the following motors to improve the insulation resistance value of the winding to the required level as per direction of the site in-charge, as per drawings, specification and directions of Site Engineer / Engineer-in-Charge.				0.00	0.00	INR Zero Only

Validate

Print

Help

Item Rate BoQ

Tender Inviting Authority: Projects & Development India Limited, Noida

Name of Work: TENDER FOR SUPPLY CUM ERECTION OF ELECTRICAL & INSTRUMENTATION WORKS ON ITEM RATE BASIS AT TALCHER FERTILIZERS LTD., ANGUL, ODISHA

Contract No: PNPM/PC-183/E/8003/NCB

NOTE : Quantities mentioned in the Schedule of Rates are indicative and not exhaustive in nature. Payment shall be made as per actual quantity used/certified at site by Owner's Engineer-in-charge. Quantities indicated in Schedule of Rates are approximate and subject to variation on either side. The quantity of individual item may be deleted. Contractor shall not be entitled for any compensation on this account and the quoted rates shall hold good for such quantity variations etc. Payments on bills shall, however, be made on actual measurements of quantities of work done as per approved drawings. Goods & Services Tax (GST) is applicable @ 18% on the quoted rates (being Works Contract).

Name of the Bidder/ Bidding Firm / Company :							
SCHEDULE OF RATE (Rev. 0) (This BOQ template must not be modified/replaced by the bidder and the same should be uploaded after filling the relevant columns, else the bidder is liable to be rejected for this tender. Bidders are allowed to enter the Bidder Name and Values only)							
NUMBER #	TEXT #	NUMBER #	TEXT #	NUMBER #	NUMBER #	NUMBER #	TEXT #
Sl. No.	Item Description	Quantity	Units	BASIC RATE In Figures To be entered by the Bidder in Rs. P	TOTAL AMOUNT Incl. All taxes & duties (Excl. GST) in Rs. P	TOTAL AMOUNT Incl. All taxes , duties and GST in Rs. P	TOTAL AMOUNT Incl. All taxes, duties and GST In Words
7.34	HT Motor rating above 500 KW and below 1500 KW	4	Nos.		0.00	0.00	INR Zero Only
7.35	HT Motor rating 1500 KW and above	1	Nos.		0.00	0.00	INR Zero Only
7.36	Testing and commissioning of 3-Phase, 415V, Squirrel Cage, Hoseproof/Flameproof Induction Motors of following ratings excluding cable glanding, cable termination, dehydration of windings but including checking & replenishment/ replacement of bearing grease/ lubricant; checking of IR values between each winding & motor frame & checking of continuity of rotation, if required, by changing supply connections; trial runs on NO LOAD & ON LOAD; supply of approved grease/ lubricant & necessary hardware; all work, labour & materials complete as per specifications, documents, codes & standards & directions of engineer-in-charge. (Contractor to keep proper record of tests on motors for NO LOAD & ON LOAD runs)				0.00	0.00	INR Zero Only
7.37	Rating upto 5.5 KW	15	Nos.		0.00	0.00	INR Zero Only
7.38	Rating above 5.5 KW but upto 11 KW	6	Nos.		0.00	0.00	INR Zero Only
7.39	Rating above 11 KW but upto 22 KW	7	Nos.		0.00	0.00	INR Zero Only
7.40	Rating above 22 KW but upto 45 KW	4	Nos.		0.00	0.00	INR Zero Only
7.41	Rating above 45 KW but upto 75 KW	2	Nos.		0.00	0.00	INR Zero Only
7.42	Rating above 75 KW but upto 150 KW	2	Nos.		0.00	0.00	INR Zero Only
7.43	CABLES (HT & LT)				0.00	0.00	INR Zero Only

Validate

Print

Help

Item Rate BoQ

Tender Inviting Authority: Projects & Development India Limited, Noida

Name of Work: TENDER FOR SUPPLY CUM ERECTION OF ELECTRICAL & INSTRUMENTATION WORKS ON ITEM RATE BASIS AT TALCHER FERTILIZERS LTD., ANGUL, ODISHA

Contract No: PNPM/PC-183/E/8003/NCB

NOTE : Quantities mentioned in the Schedule of Rates are indicative and not exhaustive in nature. Payment shall be made as per actual quantity used/certified at site by Owner's Engineer-in-charge. Quantities indicated in Schedule of Rates are approximate and subject to variation on either side. The quantity of individual item may be deleted. Contractor shall not be entitled for any compensation on this account and the quoted rates shall hold good for such quantity variations etc. Payments on bills shall, however, be made on actual measurements of quantities of work done as per approved drawings. Goods & Services Tax (GST) is applicable @ 18% on the quoted rates (being Works Contract).

Name of the Bidder/ Bidding Firm / Company :							
SCHEDULE OF RATE (Rev. 0) (This BOQ template must not be modified/replaced by the bidder and the same should be uploaded after filling the relevant columns, else the bidder is liable to be rejected for this tender. Bidders are allowed to enter the Bidder Name and Values only)							
NUMBER #	TEXT #	NUMBER #	TEXT #	NUMBER #	NUMBER #	NUMBER #	TEXT #
Sl. No.	Item Description	Quantity	Units	BASIC RATE In Figures To be entered by the Bidder in Rs. P	TOTAL AMOUNT Incl. All taxes & duties (Excl. GST) in Rs. P	TOTAL AMOUNT Incl. All taxes , duties and GST in Rs. P	TOTAL AMOUNT Incl. All taxes, duties and GST In Words
7.44	Handling, Laying (horizontal & vertical), testing and commissioning of 11KV(UE)/ 1.1 KV Grade, XLPE Insulated, PVC inner sheathed, armoured, FRLS PVC outer sheathed cables including its termination in new & readymade trenches, on pre-fabricated/ site-fabricated cable trays/ racks, on already installed risers, support, hangers,saddles / directly burried up to 700mm depth etc. pulling through pipes on walls/columns, steel structures including transportation of cable drums from storage yard to site, unrolling the drum, including supply & fixing of cable tags, Al clamps with all labour, consumable materials and necessary hardware to make installation complete in all respect as per direction of Site Engineer / Engineer-in-charge.				0.00	0.00	INR Zero Only
7.45	HT (11KV/3.3 KV) Power cables				0.00	0.00	INR Zero Only
7.46	Power cables HT (11kv/3.3KV) upto 400 sq. mm	3200	Mtrs.		0.00	0.00	INR Zero Only
7.47	LT (PVC / XLPE / Armoured / Unarmoured / Power / Control / Signalling) Cables				0.00	0.00	INR Zero Only
7.48	LT cables: OD upto 20 mm	5200	Mtrs.		0.00	0.00	INR Zero Only
7.49	LT Power cables: OD above 20 mm and upto 30 mm	10250	Mtrs.		0.00	0.00	INR Zero Only
7.50	LT cables: OD above 30 mm and upto 40 mm	600	Mtrs.		0.00	0.00	INR Zero Only
7.51	LT cables: OD above 40 mm and upto 60 mm	5650	Mtrs.		0.00	0.00	INR Zero Only
7.52	LT cables: OD above 60 mm	1400	Mtrs.		0.00	0.00	INR Zero Only
7.53	Handling,laying of 6 Fiber multi mode FO Cable suitable for relay to relay distance of approx 2 km for line differential protection with all accessories for termination , this also include splicing, jointing as per requiremnt	600	Mtrs.		0.00	0.00	INR Zero Only
7.54	EARTH STRIP / WIRE / ROPE / CABLE				0.00	0.00	INR Zero Only

Item Rate BoQ

Tender Inviting Authority: Projects & Development India Limited, Noida

Name of Work: TENDER FOR SUPPLY CUM ERECTION OF ELECTRICAL & INSTRUMENTATION WORKS ON ITEM RATE BASIS AT TALCHER FERTILIZERS LTD., ANGUL, ODISHA

Contract No: PNPM/PC-183/E/8003/NCB

NOTE : Quantities mentioned in the Schedule of Rates are indicative and not exhaustive in nature. Payment shall be made as per actual quantity used/certified at site by Owner's Engineer-in-charge. Quantities indicated in Schedule of Rates are approximate and subject to variation on either side. The quantity of individual item may be deleted. Contractor shall not be entitled for any compensation on this account and the quoted rates shall hold good for such quantity variations etc. Payments on bills shall, however, be made on actual measurements of quantities of work done as per approved drawings. Goods & Services Tax (GST) is applicable @ 18% on the quoted rates (being Works Contract)

Name of the Bidder/ Bidding Firm / Company :	
--	--

SCHEDULE OF RATE (Rev. 0) (This BOQ template must not be modified/replaced by the bidder and the same should be uploaded after filling the relevant columns, else the bidder is liable to be rejected for this tender. Bidders are allowed to enter the Bidder Name and Values only)

NUMBER #	TEXT #	NUMBER #	TEXT #	NUMBER #	NUMBER #	NUMBER #	TEXT #
Sl. No.	Item Description	Quantity	Units	BASIC RATE In Figures To be entered by the Bidder in Rs. P	TOTAL AMOUNT Incl. All taxes & duties (Excl. GST) in Rs. P	TOTAL AMOUNT Incl. All taxes , duties and GST in Rs. P	TOTAL AMOUNT Incl. All taxes, duties and GST In Words
7.55	Earthing strip/wire/rope/cable for completely making the earthing grid system by laying the GI strip / GI Wire enclosed in ready made concrete trenches or in floor slits, on brick / concrete wall under concrete floors, or paved areas, across pipe joints and valves, directly buried under ground at depth of 600 mm, including handling, transportation to erection site, bending, straightening, cutting to size, welding together of earth strips in overlapping manner, chipping in concrete floors / paved areas for laying the earth strips under floors / paved areas and making good by cement plastering concrete after laying of the strips; clamping and supporting of earth strips laid above ground, connecting the strips / wire at both ends to equipment or to earth bus / earth plates or to GI brackets fixed inside earthen chamber, by bolting etc., Hessian tapes, all necessary GI hardware, GI clamps, civil masonry materials, etc. all work, labour as per specifications, codes and standards and directions of Site engineer/Engineer-in-charge, including the cost of all labour, tools, materials, etc. complete in all respect. Note: The conductors shall be laid at a minimum depth of 600 mm from ground level.The excavation for the GI earth conductors / strips shall not be separately measured and the rates quoted to include the same				0.00	0.00	INR Zero Only
7.56	75 mm x 10 mm	1000	Mtrs.		0.00	0.00	INR Zero Only
7.57	50 mm x 6 mm	800	Mtrs.		0.00	0.00	INR Zero Only
7.58	GI wire Rope (8 SWG)	30	Kg		0.00	0.00	INR Zero Only
7.59	Handling,Installation, Testing and Commissioning of 35x6 GI strip on parapet of surface of wall for lightning conductor as required for vertical run including test link etc & horizontal run along wall,column,parapet etc complete with PVC fasteners,screws,Saddles, and welding/revetting and painting of joints etc as required.	100	Mtr		0.00	0.00	INR Zero Only
7.60	CABLE TRAYS:				0.00	0.00	INR Zero Only

Item Rate BoQ

Tender Inviting Authority: Projects & Development India Limited, Noida

Name of Work: TENDER FOR SUPPLY CUM ERECTION OF ELECTRICAL & INSTRUMENTATION WORKS ON ITEM RATE BASIS AT TALCHER FERTILIZERS LTD., ANGUL, ODISHA

Contract No: PNPM/PC-183/E/8003/NCB

NOTE : Quantities mentioned in the Schedule of Rates are indicative and not exhaustive in nature. Payment shall be made as per actual quantity used/certified at site by Owner's Engineer-in-charge. Quantities indicated in Schedule of Rates are approximate and subject to variation on either side. The quantity of individual item may be deleted. Contractor shall not be entitled for any compensation on this account and the quoted rates shall hold good for such quantity variations etc. Payments on bills shall, however, be made on actual measurements of quantities of work done as per approved drawings. Goods & Services Tax (GST) is applicable @ 18% on the quoted rates (being Works Contract).

Name of the Bidder/ Bidding Firm / Company :	
--	--

SCHEDULE OF RATE (Rev. 0) (This BOQ template must not be modified/replaced by the bidder and the same should be uploaded after filling the relevant columns, else the bidder is liable to be rejected for this tender. Bidders are allowed to enter the Bidder Name and Values only)

NUMBER #	TEXT #	NUMBER #	TEXT #	NUMBER #	NUMBER #	NUMBER #	TEXT #
Sl. No.	Item Description	Quantity	Units	BASIC RATE In Figures To be entered by the Bidder in Rs. P	TOTAL AMOUNT Incl. All taxes & duties (Excl. GST) in Rs. P	TOTAL AMOUNT Incl. All taxes , duties and GST in Rs. P	TOTAL AMOUNT Incl. All taxes, duties and GST In Words
7.61	Handling, installation & fixing of prefabricated ladder GI cable trays and their accessories i.e. supply of all hardware required i.e. J-hooks, GI Nut, Bolt, Washers, coupling plate etc. of width 150 mm, 300 mm, 450 mm & 600 mm as per site requirement for laying of cables with standard rung spacings. Load for support span of 2.5 meter as 30, 60, 75 & 90 (in Kg/Mtr.) respectively with concentric static load as 70 Kg at the centre, with materials, labour, tools and tackles, consumables etc. as per drawings, specification and directions of Site Engineer / Engineer-in-Charge. The rates shall be valid for all mounting heights.				0.00	0.00	INR Zero Only
7.62	Straight Run Cable Trays				0.00	0.00	INR Zero Only
7.63	600 mm wide	1900	Mtrs.		0.00	0.00	INR Zero Only
7.64	450 mm wide	300	Mtrs.		0.00	0.00	INR Zero Only
7.65	300 mm wide	700	Mtrs.		0.00	0.00	INR Zero Only
7.66	150 mm wide	200	Mtrs.		0.00	0.00	INR Zero Only
7.67	Horizontal Bends				0.00	0.00	INR Zero Only
7.68	600 mm wide, 700 mm radius	20	Nos.		0.00	0.00	INR Zero Only
7.69	450 mm wide, 700 mm radius	15	Nos.		0.00	0.00	INR Zero Only
7.70	300 mm wide, 700 mm radius	60	Nos.		0.00	0.00	INR Zero Only
7.71	150 mm wide	20	Nos.		0.00	0.00	INR Zero Only
7.72	Vertical Inside Bends				0.00	0.00	INR Zero Only
7.73	600mm wide, 1000mm radius	10	Nos.		0.00	0.00	INR Zero Only
7.74	450 mm wide, 1000mm radius	10	Nos.		0.00	0.00	INR Zero Only
7.75	300 mm wide, 1000mm radius	30	Nos.		0.00	0.00	INR Zero Only

Validate

Print

Help

Item Rate BoQ

Tender Inviting Authority: Projects & Development India Limited, Noida

Name of Work: TENDER FOR SUPPLY CUM ERECTION OF ELECTRICAL & INSTRUMENTATION WORKS ON ITEM RATE BASIS AT TALCHER FERTILIZERS LTD., ANGUL, ODISHA

Contract No: PNP/PC-183/E/8003/NCB

NOTE : Quantities mentioned in the Schedule of Rates are indicative and not exhaustive in nature. Payment shall be made as per actual quantity used/certified at site by Owner's Engineer-in-charge. Quantities indicated in Schedule of Rates are approximate and subject to variation on either side. The quantity of individual item may be deleted. Contractor shall not be entitled for any compensation on this account and the quoted rates shall hold good for such quantity variations etc. Payments on bills shall, however, be made on actual measurements of quantities of work done as per approved drawings. Goods & Services Tax (GST) is applicable @ 18% on the quoted rates (being Works Contract).

Name of the Bidder/ Bidding Firm / Company :	
--	--

SCHEDULE OF RATE (Rev. 0) (This BOQ template must not be modified/replaced by the bidder and the same should be uploaded after filling the relevant columns, else the bidder is liable to be rejected for this tender. Bidders are allowed to enter the Bidder Name and Values only)

NUMBER #	TEXT #	NUMBER #	TEXT #	NUMBER #	NUMBER #	NUMBER #	TEXT #
Sl. No.	Item Description	Quantity	Units	BASIC RATE In Figures To be entered by the Bidder in Rs. P	TOTAL AMOUNT Incl. All taxes & duties (Excl. GST) in Rs. P	TOTAL AMOUNT Incl. All taxes , duties and GST in Rs. P	TOTAL AMOUNT Incl. All taxes, duties and GST In Words
7.78	600 mm wide, 1000 mm radius	10	Nos.		0.00	0.00	INR Zero Only
7.79	450 mm wide, 1000 mm radius	10	Nos.		0.00	0.00	INR Zero Only
7.80	300 mm wide, 1000 mm radius	35	Nos.		0.00	0.00	INR Zero Only
7.81	150 mm wide	20	Nos.		0.00	0.00	INR Zero Only
7.82	Reducer				0.00	0.00	INR Zero Only
7.83	600 mm / 450 mm wide	10	Mtrs.		0.00	0.00	INR Zero Only
7.84	450/300mm wide	10	Nos.		0.00	0.00	INR Zero Only
7.85	300/150mm wide	10	No.		0.00	0.00	INR Zero Only
7.86	Regular Tees				0.00	0.00	INR Zero Only
7.87	600 mm wide , 700 mm radius	5	Mtrs.		0.00	0.00	INR Zero Only
7.88	450 mm wide, 700 mm radius	8	Mtrs.		0.00	0.00	INR Zero Only
7.89	Cross				0.00	0.00	INR Zero Only
7.90	600 mm wide , 700 mm radius	10	Mtrs.		0.00	0.00	INR Zero Only
7.91	450 mm wide, 700 mm radius	5	Mtrs.		0.00	0.00	INR Zero Only
8.00	PART-C : SUPPLY, ERECTION, TESTING & COMMISSIONING OF ELECTRICAL COMPOSITE ITEMS				0.00	0.00	INR Zero Only
8.11	DISTRIBUTION BOARDS:				0.00	0.00	INR Zero Only

Item Rate BoQ

Tender Inviting Authority: Projects & Development India Limited, Noida

Name of Work: TENDER FOR SUPPLY CUM ERECTION OF ELECTRICAL & INSTRUMENTATION WORKS ON ITEM RATE BASIS AT TALCHER FERTILIZERS LTD., ANGUL, ODISHA

Contract No: PNP/PC-183/E/8003/NCB

NOTE : Quantities mentioned in the Schedule of Rates are indicative and not exhaustive in nature. Payment shall be made as per actual quantity used/certified at site by Owner's Engineer-in-charge. Quantities indicated in Schedule of Rates are approximate and subject to variation on either side. The quantity of individual item may be deleted. Contractor shall not be entitled for any compensation on this account and the quoted rates shall hold good for such quantity variations etc. Payments on bills shall, however, be made on actual measurements of quantities of work done as per approved drawings. Goods & Services Tax (GST) is applicable @ 18% on the quoted rates (being Works Contract).

Name of the Bidder/ Bidding Firm / Company :	
---	--

SCHEDULE OF RATE (Rev. 0) (This BOQ template must not be modified/replaced by the bidder and the same should be uploaded after filling the relevant columns, else the bidder is liable to be rejected for this tender. Bidders are allowed to enter the Bidder Name and Values only)

NUMBER #	TEXT #	NUMBER #	TEXT #	NUMBER #	NUMBER #	NUMBER #	TEXT #
Sl. No.	Item Description	Quantity	Units	BASIC RATE In Figures To be entered by the Bidder in Rs. P	TOTAL AMOUNT Incl. All taxes & duties (Excl. GST) in Rs. P	TOTAL AMOUNT Incl. All taxes , duties and GST in Rs. P	TOTAL AMOUNT Incl. All taxes, duties and GST In Words
8.12	Supply, unloading, Handling, Storage, transportation within site, Erection, Installation, testing and commissioning etc. of following floor / wall mounted Distribution Boards/Sub distribution board having minimum IP-54 protection, Aluminium Bus Bar with Color Coded Heat Shrinkable Sleeves, storage, handling, site transportation from store to site of installation, including supply and fabrication of epoxy painted MS frame, operational and functional checking, drilling of gland plates with requisite holes, supply & fixing of suitable double compression nickel plated brass/rolled Al cable glands & suitable lugs, termination of all power and control cables, shrouding,plugging of all unused cable entries and other holes found in the boards to make the same dust and vermin proof with all labour and consumable materials to make installation complete of following Distribution Boards as specified in Technical Specification - Electrical,Technical Specification PC183-TS-0805 PC183-TS-0808 and attached SLD, data sheets, drawings, specifications and directions of engineer-in-charge :				0.00	0.00	INR Zero Only
8.13	415 V, 3 Ph & N, IP54 floor mounted sheet steel enclosed Main Lighting Distribution Board (MLDB) consisting of 2 nos. incoming 250 A MCCB incomer with 200/1 CT, 250A contactor, MFM, voltmeter, VSS & RYB indications & 5 nos. 63 A TPN RCCB outgoing feeders on indoor bus and 4 nos. 125A TPN RCCB & 3 nos. 63A TPN RCCB outgoing feeders on outdoor bus with Photocell controlled (125A contactor with MCCB) as indicated in attached SLD enclosed with Technical specification	2	Nos.		0.00	0.00	INR Zero Only

Validate

Print

Help

Item Rate BoQ

Tender Inviting Authority: Projects & Development India Limited, Noida

Name of Work: TENDER FOR SUPPLY CUM ERECTION OF ELECTRICAL & INSTRUMENTATION WORKS ON ITEM RATE BASIS AT TALCHER FERTILIZERS LTD., ANGUL, ODISHA

Contract No: PNPM/PC-183/E/8003/NCB

NOTE : Quantities mentioned in the Schedule of Rates are indicative and not exhaustive in nature. Payment shall be made as per actual quantity used/certified at site by Owner's Engineer-in-charge. Quantities indicated in Schedule of Rates are approximate and subject to variation on either side. The quantity of individual item may be deleted. Contractor shall not be entitled for any compensation on this account and the quoted rates shall hold good for such quantity variations etc. Payments on bills shall, however, be made on actual measurements of quantities of work done as per approved drawings. Goods & Services Tax (GST) is applicable @ 18% on the quoted rates (being Works Contract).

Name of the Bidder/ Bidding Firm / Company :							
SCHEDULE OF RATE (Rev. 0) (This BOQ template must not be modified/replaced by the bidder and the same should be uploaded after filling the relevant columns, else the bidder is liable to be rejected for this tender. Bidders are allowed to enter the Bidder Name and Values only)							
NUMBER #	TEXT #	NUMBER #	TEXT #	NUMBER #	NUMBER #	NUMBER #	TEXT #
Sl. No.	Item Description	Quantity	Units	BASIC RATE In Figures To be entered by the Bidder in Rs. P	TOTAL AMOUNT Incl. All taxes & duties (Excl. GST) in Rs. P	TOTAL AMOUNT Incl. All taxes , duties and GST in Rs. P	TOTAL AMOUNT Incl. All taxes, duties and GST In Words
8.14	415 V, 3 Ph & N, IP54 floor mounted sheet steel enclosed Main Lighting Distribution Board (MLDB) consisting of 2 nos. incoming 630 A MCCB incomer with 600/1 CT, 550A contactor, MFM, voltmeter, VSS & RYB indications & 3 nos. 63 A TPN RCCB /125 A TPN MCCB outgoing feeders on indoor bus and 6 nos. 250A TPN MCCBs & 3 nos. 63 A TPN RCCB /125 A TPN MCCB outgoing feeders on outdoor bus with Photocell controlled (500A contactor with 630 A MCCB) as indicated in attached SLD for MLDB enclosed with Technical specification	1	Nos.		0.00	0.00	INR Zero Only
8.15	415 V, 3 Ph & N, IP54, floor mounted sheet steel enclosed Power Distribution board (PCC) consisting of 2 nos. incoming 2500A ACB Incomer & nos. of outgoing feeders as indicated in attached SLD enclosed with Technical specification.	1	No.		0.00	0.00	INR Zero Only
8.16	415 V, 3 Ph & N, IP54, floor mounted sheet steel enclosed Power Distribution board (PDB-1 (N1) Workshop) of 1 nos. incoming 800A ACB Incomer & nos. of outgoing feeders as indicated in attached SLD enclosed with Technical specification.	1	No.		0.00	0.00	INR Zero Only
8.17	415 V, 3 Ph & N, IP54, floor mounted sheet steel enclosed Power Distribution board (PDB-2 for Small Loads) of 1 nos. incoming 250A MCCB Incomer & nos. of outgoing feeders as indicated in attached SLD enclosed with Technical specification.	1	No.		0.00	0.00	INR Zero Only
8.18	415 V, 3 Ph & N, IP54, floor mounted sheet steel enclosed Power Distribution board (PDB-4 for Small Loads) of 1 nos. incoming 250A MCCB Incomer & nos. of outgoing feeders as indicated in attached SLD enclosed with Technical specification.	1	No.		0.00	0.00	INR Zero Only

Validate

Print

Help

Item Rate BoQ

Tender Inviting Authority: Projects & Development India Limited, Noida

Name of Work: TENDER FOR SUPPLY CUM ERECTION OF ELECTRICAL & INSTRUMENTATION WORKS ON ITEM RATE BASIS AT TALCHER FERTILIZERS LTD., ANGUL, ODISHA

Contract No: PNP/PC-183/E/8003/NCB

NOTE : Quantities mentioned in the Schedule of Rates are indicative and not exhaustive in nature. Payment shall be made as per actual quantity used/certified at site by Owner's Engineer-in-charge. Quantities indicated in Schedule of Rates are approximate and subject to variation on either side. The quantity of individual item may be deleted. Contractor shall not be entitled for any compensation on this account and the quoted rates shall hold good for such quantity variations etc. Payments on bills shall, however, be made on actual measurements of quantities of work done as per approved drawings. Goods & Services Tax (GST) is applicable @ 18% on the quoted rates (being Works Contract)

Name of the Bidder/ Bidding Firm / Company :							
SCHEDULE OF RATE (Rev. 0) (This BOQ template must not be modified/replaced by the bidder and the same should be uploaded after filling the relevant columns, else the bidder is liable to be rejected for this tender. Bidders are allowed to enter the Bidder Name and Values only)							
NUMBER #	TEXT #	NUMBER #	TEXT #	NUMBER #	NUMBER #	NUMBER #	TEXT #
Sl. No.	Item Description	Quantity	Units	BASIC RATE In Figures To be entered by the Bidder in Rs. P	TOTAL AMOUNT Incl. All taxes & duties (Excl. GST) in Rs. P	TOTAL AMOUNT Incl. All taxes , duties and GST in Rs. P	TOTAL AMOUNT Incl. All taxes, duties and GST In Words
8.19	415 V, 3 Ph & N, IP54,floor mounted sheet steel enclosed Power Distribution board (PDB-1 for Small Loads) of 1 nos. incoming 250A MCCB Incomer & nos. of outgoing feeders as indicated in attached SLD enclosed with Technical specification.	1	No.		0.00	0.00	INR Zero Only
8.20	415 V, 3 Ph & N, IP54,floor mounted sheet steel enclosed Power Distribution board (PDB-3 for Small Loads) of 1 nos. incoming 250A MCCB Incomer & nos. of outgoing feeders as indicated in attached SLD enclosed with Technical specification.	1	No.		0.00	0.00	INR Zero Only
8.21	415 V, 3 Ph & N, IP54,floor mounted sheet steel enclosed Power Distribution board (PDB-3 for Small Loads) of 1 nos. incoming 250A MCCB Incomer & nos. of outgoing feeders as indicated in attached SLD enclosed with Technical specification.	1	No.		0.00	0.00	INR Zero Only
8.22	415 V, 3 Ph & N, IP54,floor mounted sheet steel enclosed Power Distribution board (PDB-2(E) Workshop) of 1 nos. incoming 250A MCCB Incomer & nos. of outgoing feeders as indicated in attached SLD enclosed with Technical specification.	1	No.		0.00	0.00	INR Zero Only
8.23	WALL / STRUCTURE MOUNTED SUB DISTRIBUTION BOARDS / FEEDAR PILLAR BOXES				0.00	0.00	INR Zero Only

Validate

Print

Help

Item Rate BoQ

Tender Inviting Authority: Projects & Development India Limited, Noida

Name of Work: TENDER FOR SUPPLY CUM ERECTION OF ELECTRICAL & INSTRUMENTATION WORKS ON ITEM RATE BASIS AT TALCHER FERTILIZERS LTD., ANGUL, ODISHA

Contract No: PNP/PC-183/E/8003/NCB

NOTE : Quantities mentioned in the Schedule of Rates are indicative and not exhaustive in nature. Payment shall be made as per actual quantity used/certified at site by Owner's Engineer-in-charge. Quantities indicated in Schedule of Rates are approximate and subject to variation on either side. The quantity of individual item may be deleted. Contractor shall not be entitled for any compensation on this account and the quoted rates shall hold good for such quantity variations etc. Payments on bills shall, however, be made on actual measurements of quantities of work done as per approved drawings. Goods & Services Tax (GST) is applicable @ 18% on the quoted rates (being Works Contract).

Name of the Bidder/ Bidding Firm / Company :							
SCHEDULE OF RATE (Rev. 0) (This BOQ template must not be modified/replaced by the bidder and the same should be uploaded after filling the relevant columns, else the bidder is liable to be rejected for this tender. Bidders are allowed to enter the Bidder Name and Values only)							
NUMBER #	TEXT #	NUMBER #	TEXT #	NUMBER #	NUMBER #	NUMBER #	TEXT #
Sl. No.	Item Description	Quantity	Units	BASIC RATE In Figures To be entered by the Bidder in Rs. P	TOTAL AMOUNT Incl. All taxes & duties (Excl. GST) in Rs. P	TOTAL AMOUNT Incl. All taxes , duties and GST in Rs. P	TOTAL AMOUNT Incl. All taxes, duties and GST In Words
8.24	Supply,unloading,Handling, Storage,transporation within site, Installation, testing and commissioning of following floor / wall mounted Distribution Boards, including supply and fabrication of epoxy painted MS frame, operational and functional checking, drilling of gland plates with requisite holes, fixing of cable glands, plugging of all unused cable entries and other holes found in the boards to make the same dust and vermin proof with all labour and consumable materials to make installation complete of following wall / structure mounted Distribution Boards as specified in Technical Specification - Electrical, Technical Specification PC183-TS-0809., Single Line Diagrams, Specification Sheets, Specifications and directions of Engineer-in-Charge. All distribution boards incomers shall have phase indication light with MCB.				0.00	0.00	INR Zero Only
8.25	415 V, 12-way, wall / structure mounted Sheet Steel enclosed Industrial Type Hose Proof and weatherproof (IP-55) Lighting Sub Distribution Boards having 1 No. Incoming (100 A 4PMCCB) and 3 nos. feeder circuit of 63A DP RCBO having 12 Nos. outgoing of 32 A DP MCB as indicated in attached SLD along with technical specifications, standards etc. (i.e.4 nos. 32 A DP MCB per circuit).	1	Nos.		0.00	0.00	INR Zero Only
8.26	415 V, 12-way, wall / structure mounted Sheet Steel enclosed Industrial Type Hose Proof and weatherproof (IP-55) Lighting Sub Distribution Boards having 1 No. Incoming (125 A 4PMCCB) and 3 nos. feeder circuit of 63A DP RCBO having 12 Nos. outgoing of 32 A DP MCB as indicated in attached SLD along with technical specifications, standards etc. (i.e.4 nos. 32 A DP MCB per circuit).	1	Nos.		0.00	0.00	INR Zero Only
8.27	415 V, 12-way, wall / structure mounted Sheet Steel enclosed Industrial Type Hose Proof and weatherproof (IP-55) Lighting Sub Distribution Boards having 1 No. Incoming (63 A 4PMCCB) and 3 nos. feeder circuit of 63A DP RCBO having 12 Nos. outgoing of 16 A DP MCB as indicated in	7	Nos.		0.00	0.00	INR Zero Only

[Validate](#)[Print](#)[Help](#)**Item Rate BoQ**

Tender Inviting Authority: Projects & Development India Limited, Noida

Name of Work: TENDER FOR SUPPLY CUM ERECTION OF ELECTRICAL & INSTRUMENTATION WORKS ON ITEM RATE BASIS AT TALCHER FERTILIZERS LTD., ANGUL, ODISHA

Contract No: PNPM/PC-183/E/8003/NCB

NOTE : Quantities mentioned in the Schedule of Rates are indicative and not exhaustive in nature. Payment shall be made as per actual quantity used/certified at site by Owner's Engineer-in-charge. Quantities indicated in Schedule of Rates are approximate and subject to variation on either side. The quantity of individual item may be deleted. Contractor shall not be entitled for any compensation on this account and the quoted rates shall hold good for such quantity variations etc. Payments on bills shall, however, be made on actual measurements of quantities of work done as per approved drawings. Goods & Services Tax (GST) is applicable @ 18% on the quoted rates (being Works Contract).

Name of the Bidder/ Bidding Firm / Company :							
SCHEDULE OF RATE (Rev. 0) (This BOQ template must not be modified/replaced by the bidder and the same should be uploaded after filling the relevant columns, else the bidder is liable to be rejected for this tender. Bidders are allowed to enter the Bidder Name and Values only)							
NUMBER #	TEXT #	NUMBER #	TEXT #	NUMBER #	NUMBER #	NUMBER #	TEXT #
Sl. No.	Item Description	Quantity	Units	BASIC RATE In Figures To be entered by the Bidder in Rs. P	TOTAL AMOUNT Incl. All taxes & duties (Excl. GST) in Rs. P	TOTAL AMOUNT Incl. All taxes , duties and GST in Rs. P	TOTAL AMOUNT Incl. All taxes, duties and GST In Words
8.28	415 V, 9-way, wall / structure mounted Sheet Steel enclosed Industrial Type Hose Proof and weatherproof (IP-55) Lighting Sub Distribution Boards having 1 No. Incoming (63 A 4PMCCB) and 3 nos. feeder circuit of 63A DP RCBO having 9 Nos. outgoing of 16 A DP MCB as indicated in attached SLD along with technical specifications, standards etc.(i.e.3 nos. 16 A DP MCB per circuit).	7	Nos.		0.00	0.00	INR Zero Only
8.29	415V Hose proof and weatherproof industrial type sheet steel enclosed, 18 way Lighting Distribution Board (LSDB) with IP-55 degree of protection having 1 no.(63 A 4PMCCB) and 3 nos. feeder circuit of 63A DP RCBO having 18 nos.16A DP MCBs outgoing as indicated in attached SLD along with technical specifications, standards etc.	6	Nos.		0.00	0.00	INR Zero Only
8.30	415 V, 3 Ph & N, IP55, wall/structure mounted sheet steel enclosed Feeder pillar box consisting of 1 nos. incoming 125A TPN MCCB incomer with RYB indications and 4 nos. 63A TPN MCCB outgoing feeders as indicated in attached SLD for feeder pillar box enclosed with Technical specification EM251-TS-0803.	1	Nos.		0.00	0.00	INR Zero Only
8.31	110 V, wall / structure mounted Sheet Steel enclosed Industrial Type Hose Proof and weatherproof (IP-55) DC Distribution Boards having 1 No. Incoming (32 A DP MCB and ELCB) and 12 Nos. outgoing feeders of 6 A DP DC MCB.	1	Nos.		0.00	0.00	INR Zero Only
8.32	415V Hose proof and weatherproof industrial type sheet steel enclosed, 18 way Lighting Distribution Board (LSDB) with IP-55 degree of protection having 1 no.(125 A 4PMCCB) and 3 nos. feeder circuit of 63A DP RCBO having 12 nos.16A DP MCBs and 6 Nos. 32 A MCBs outgoing as indicated in attached SLD along with technical specifications, standards etc.	1	Nos.		0.00	0.00	INR Zero Only

Validate

Print

Help

Item Rate BoQ

Tender Inviting Authority: Projects & Development India Limited, Noida

Name of Work: TENDER FOR SUPPLY CUM ERECTION OF ELECTRICAL & INSTRUMENTATION WORKS ON ITEM RATE BASIS AT TALCHER FERTILIZERS LTD., ANGUL, ODISHA

Contract No: PNPM/PC-183/E/8003/NCB

NOTE : Quantities mentioned in the Schedule of Rates are indicative and not exhaustive in nature. Payment shall be made as per actual quantity used/certified at site by Owner's Engineer-in-charge. Quantities indicated in Schedule of Rates are approximate and subject to variation on either side. The quantity of individual item may be deleted. Contractor shall not be entitled for any compensation on this account and the quoted rates shall hold good for such quantity variations etc. Payments on bills shall, however, be made on actual measurements of quantities of work done as per approved drawings. Goods & Services Tax (GST) is applicable @ 18% on the quoted rates (being Works Contract)

Name of the Bidder/ Bidding Firm / Company :							
SCHEDULE OF RATE (Rev. 0) (This BOQ template must not be modified/replaced by the bidder and the same should be uploaded after filling the relevant columns, else the bidder is liable to be rejected for this tender. Bidders are allowed to enter the Bidder Name and Values only)							
NUMBER #	TEXT #	NUMBER #	TEXT #	NUMBER #	NUMBER #	NUMBER #	TEXT #
Sl. No.	Item Description	Quantity	Units	BASIC RATE In Figures To be entered by the Bidder in Rs. P	TOTAL AMOUNT Incl. All taxes & duties (Excl. GST) in Rs. P	TOTAL AMOUNT Incl. All taxes , duties and GST in Rs. P	TOTAL AMOUNT Incl. All taxes, duties and GST In Words
8.33	415V Hose proof and weatherproof industrial type sheet steel enclosed, 12 way Distribution Board (DB-D1) with IP-55 degree of protection having 1 no.(100 A 4PMCCB) and 8 nos.32A TPN MCBs & 12 Nos. 32 A SP MCBs outgoing as indicated in attached SLD along with technical specifications, standards etc.	1	Nos.		0.00	0.00	INR Zero Only
8.34	415V Hose proof and weatherproof industrial type sheet steel enclosed, 12 way Distribution Board (DB-D2) with IP-55 degree of protection having 1 no.(100 A 4PMCCB) and 12 nos.32A TPN MCBs outgoing as indicated in attached SLD along with technical specifications, standards etc.	1	Nos.		0.00	0.00	INR Zero Only
8.35	415V Hose proof and weatherproof industrial type sheet steel enclosed, 8 way Distribution Board (DB-D3) with IP-55 degree of protection having 1 no.(100 A 4PMCCB) and 4 nos.32A TPN MCBs & 12 Nos. 32 A SP MCBs outgoing as indicated in attached SLD along with technical specifications, standards etc.	1	Nos.		0.00	0.00	INR Zero Only
8.36	415V Hose proof and weatherproof industrial type sheet steel enclosed, 12 way Distribution Board (DB-D4) with IP-55 degree of protection having 1 no.(100 A 4PMCCB) and 9 nos.32A TPN MCBs & 9 Nos. 32 A SP MCBs outgoing as indicated in attached SLD along with technical specifications, standards etc.	1	Nos.		0.00	0.00	INR Zero Only
8.37	415V Hose proof and weatherproof industrial type sheet steel enclosed, 8 way Distribution Board (DB-D5) with IP-55 degree of protection having 1 no.(63 A 4PMCCB) and 2 nos.32A TPN MCBs & 18 Nos. 20/32 A SP MCBs outgoing as indicated in attached SLD along with technical specifications, standards etc.	1	Nos.		0.00	0.00	INR Zero Only
8.38	EMERGENCY PUSH BUTTON STATION FOR TRANSFORMER (Weatherproof)				0.00	0.00	INR Zero Only

Validate

Print

Help

Item Rate BoQ

Tender Inviting Authority: Projects & Development India Limited, Noida

Name of Work: TENDER FOR SUPPLY CUM ERECTION OF ELECTRICAL & INSTRUMENTATION WORKS ON ITEM RATE BASIS AT TALCHER FERTILIZERS LTD., ANGUL, ODISHA

Contract No: PNPM/PC-183/E/8003/NCB

NOTE : Quantities mentioned in the Schedule of Rates are indicative and not exhaustive in nature. Payment shall be made as per actual quantity used/certified at site by Owner's Engineer-in-charge. Quantities indicated in Schedule of Rates are approximate and subject to variation on either side. The quantity of individual item may be deleted. Contractor shall not be entitled for any compensation on this account and the quoted rates shall hold good for such quantity variations etc. Payments on bills shall, however, be made on actual measurements of quantities of work done as per approved drawings. Goods & Services Tax (GST) is applicable @ 18% on the quoted rates (being Works Contract).

Name of the Bidder/ Bidding Firm / Company :							
SCHEDULE OF RATE (Rev. 0) (This BOQ template must not be modified/replaced by the bidder and the same should be uploaded after filling the relevant columns, else the bidder is liable to be rejected for this tender. Bidders are allowed to enter the Bidder Name and Values only)							
NUMBER #	TEXT #	NUMBER #	TEXT #	NUMBER #	NUMBER #	NUMBER #	TEXT #
Sl. No.	Item Description	Quantity	Units	BASIC RATE In Figures To be entered by the Bidder in Rs. P	TOTAL AMOUNT Incl. All taxes & duties (Excl. GST) in Rs. P	TOTAL AMOUNT Incl. All taxes , duties and GST in Rs. P	TOTAL AMOUNT Incl. All taxes, duties and GST In Words
8.39	Supply ,erection,testing and commissioning of Weather Proof push button(OFF) control station of approved make for emergency transformer tripping at field including connection and termination of copper control cable, fabricating, earthing the supporting structure,termination of cables painting the same, including supply & installation of cable glands & plugs for sealing all spare entries including the cost of all labour,tools, materials etc. complete in every respect as per the specification and directions of the Site Engineer / Engineer-in-charge.	6	Nos.		0.00	0.00	INR Zero Only
9.00	LIGHTING				0.00	0.00	INR Zero Only
9.11	Supply, unloading, storage, handling, transportation within site from store to site of installation, installation, connection, earthing and testing of the following LED fittings, including supply and installation of drop pipes, hooks, JB/TB for looping of fixtures, fittings, fixtures, nuts, bolts, supports, on walls and all other required materials gland, lugs as required etc. as specified in Technical Specification and all hardware for fixing the lighting fittings with ceiling/wall pole including cable glanding, crimping of lugs on cable conductor & connecting cables at fixtures in looping and from lighting DB, earthing, junction boxes, etc., drawings and directions of the Site Engineer including cost of all labour, tools, materials as well as transportation from store to site of erection with all labour and material to make installation complete in all respect. Make of the fittings shall be as per approved make as mentioned in Technical specification.				0.00	0.00	INR Zero Only
9.12	LED Tube light fitting industrial type of approved make suspension mounting suitable for 240V AC as per Technical specification complete with 2x18 W LED fixture with all accessories such as LED lamp/chip, electronic driver, Reflector, Terminal block etc.The fittings shall be provided with suspension accessory / wall mounting bracket depending upon directions by EIC / Site Engineer	10	Nos.		0.00	0.00	INR Zero Only

Validate

Print

Help

Item Rate BoQ

Tender Inviting Authority: Projects & Development India Limited, Noida

Name of Work: TENDER FOR SUPPLY CUM ERECTION OF ELECTRICAL & INSTRUMENTATION WORKS ON ITEM RATE BASIS AT TALCHER FERTILIZERS LTD., ANGUL, ODISHA

Contract No: PNPM/PC-183/E/8003/NCB

NOTE : Quantities mentioned in the Schedule of Rates are indicative and not exhaustive in nature. Payment shall be made as per actual quantity used/certified at site by Owner's Engineer-in-charge. Quantities indicated in Schedule of Rates are approximate and subject to variation on either side. The quantity of individual item may be deleted. Contractor shall not be entitled for any compensation on this account and the quoted rates shall hold good for such quantity variations etc. Payments on bills shall, however, be made on actual measurements of quantities of work done as per approved drawings. Goods & Services Tax (GST) is applicable @ 18% on the quoted rates (being Works Contract).

Name of the Bidder/ Bidding Firm / Company :							
SCHEDULE OF RATE (Rev. 0) (This BOQ template must not be modified/replaced by the bidder and the same should be uploaded after filling the relevant columns, else the bidder is liable to be rejected for this tender. Bidders are allowed to enter the Bidder Name and Values only)							
NUMBER #	TEXT #	NUMBER #	TEXT #	NUMBER #	NUMBER #	NUMBER #	TEXT #
Sl. No.	Item Description	Quantity	Units	BASIC RATE In Figures To be entered by the Bidder in Rs. P	TOTAL AMOUNT Incl. All taxes & duties (Excl. GST) in Rs. P	TOTAL AMOUNT Incl. All taxes , duties and GST in Rs. P	TOTAL AMOUNT Incl. All taxes, duties and GST In Words
9.13	LED Tube light fitting industrial type of approved make suspension mounting/wall mounting suitable for 240V AC as per Technical specification complete with 1x20 W LED fixture with all accessories such as LED lamp/chip, electronic driver, Reflector Terminal block etc etc.. The fittings shall be provided with suspension accessory / wall mounting bracket depending upon directions by EIC / Site Engineer. The minimum degree of protection shall be IP 20.	10	Nos.		0.00	0.00	INR Zero Only
9.14	55 W LED Highbay Light Fixture of approved make suitable for 240V AC as per Technical specification complete with all accessories such as LED lamp/chip, electronic driver, Reflector Terminal block etc etc.. The fittings shall be provided with mounting arrangement as per Site Enginner/ Enginner-in-charge.	110	Nos.		0.00	0.00	INR Zero Only
9.15	180 W LED Highbay Light Fixture of approved make suitable for 240V AC as per Technical specification complete with all accessories such as LED lamp/chip, electronic driver, Reflector Terminal block etc etc.. The fittings shall be provided with mounting arrangement as per Site Enginner/ Enginner-in-charge.	50	Nos.		0.00	0.00	INR Zero Only
9.16	40 W LED Batton 4 Ft of approved make suitable for 240V AC as per Technical specification complete with all accessories such as LED lamp/chip, electronic driver, Reflector Terminal block etc etc.. The fittings shall be provided with mounting arrangement as per Site Enginner/ Enginner-in-charge.	200	Nos.		0.00	0.00	INR Zero Only
9.17	15 W LED Surface Light of approved make suitable for 240V AC as per Technical specification complete with all accessories such as LED lamp/chip, electronic driver, Reflector Terminal block etc etc.. The fittings shall be provided with mounting arrangement as per Site Enginner/ Enginner-in-charge.	40	Nos.		0.00	0.00	INR Zero Only

[Validate](#)[Print](#)[Help](#)

Item Rate BoQ

Tender Inviting Authority: Projects & Development India Limited, Noida

Name of Work: TENDER FOR SUPPLY CUM ERECTION OF ELECTRICAL & INSTRUMENTATION WORKS ON ITEM RATE BASIS AT TALCHER FERTILIZERS LTD., ANGUL, ODISHA

Contract No: PNP/PC-183/E/8003/NCB

NOTE : Quantities mentioned in the Schedule of Rates are indicative and not exhaustive in nature. Payment shall be made as per actual quantity used/certified at site by Owner's Engineer-in-charge. Quantities indicated in Schedule of Rates are approximate and subject to variation on either side. The quantity of individual item may be deleted. Contractor shall not be entitled for any compensation on this account and the quoted rates shall hold good for such quantity variations etc. Payments on bills shall, however, be made on actual measurements of quantities of work done as per approved drawings. Goods & Services Tax (GST) is applicable @ 18% on the quoted rates (being Works Contract).

Name of the Bidder/ Bidding Firm / Company :	
---	--

SCHEDULE OF RATE (Rev. 0) (This BOQ template must not be modified/replaced by the bidder and the same should be uploaded after filling the relevant columns, else the bidder is liable to be rejected for this tender. Bidders are allowed to enter the Bidder Name and Values only)

NUMBER #	TEXT #	NUMBER #	TEXT #	NUMBER #	NUMBER #	NUMBER #	TEXT #
Sl. No.	Item Description	Quantity	Units	BASIC RATE In Figures To be entered by the Bidder in Rs. P	TOTAL AMOUNT Incl. All taxes & duties (Excl. GST) in Rs. P	TOTAL AMOUNT Incl. All taxes , duties and GST in Rs. P	TOTAL AMOUNT Incl. All taxes, duties and GST In Words
9.18	10 W LED Baton Mirror Light 2 Ft of approved make suitable for 240V AC as per Technical specification complete with all accessories such as LED lamp/chip, electronic driver, Reflector Terminal block etc etc.. The fittings shall be provided with mounting arrangement as per Site Enginner/ Enginner-in-charge.	20	Nos.		0.00	0.00	INR Zero Only
9.19	34 W 2 x 2 Luminaire of approved make suitable for 240V AC as per Technical specification complete with all accessories such as LED lamp/chip, electronic driver, Reflector Terminal block etc etc.. The fittings shall be provided with mounting arrangement as per Site Enginner/ Enginner-in-charge.	100	Nos.		0.00	0.00	INR Zero Only
9.20	Flame proof Light Fixture 40 W of approved make suitable for 240V AC as per Technical specification complete with all accessories such as LED lamp/chip, electronic driver, Reflector Terminal block etc etc.. The fittings shall be provided with mounting arrangement as per Site Enginner/ Enginner-in-charge.	6	Nos.		0.00	0.00	INR Zero Only
9.21	120 W Filod Light Fixture of approved make suitable for 240V AC as per Technical specification complete with all accessories such as LED lamp/chip, electronic driver, Reflector Terminal block etc etc.. The fittings shall be provided with mounting arrangement as per Site Enginner/ Enginner-in-charge.	40	Nos.		0.00	0.00	INR Zero Only

Item Rate BoQ

Tender Inviting Authority: Projects & Development India Limited, Noida

Name of Work: TENDER FOR SUPPLY CUM ERECTION OF ELECTRICAL & INSTRUMENTATION WORKS ON ITEM RATE BASIS AT TALCHER FERTILIZERS LTD., ANGUL, ODISHA

Contract No: PNP/PC-183/E/8003/NCB

NOTE : Quantities mentioned in the Schedule of Rates are indicative and not exhaustive in nature. Payment shall be made as per actual quantity used/certified at site by Owner's Engineer-in-charge. Quantities indicated in Schedule of Rates are approximate and subject to variation on either side. The quantity of individual item may be deleted. Contractor shall not be entitled for any compensation on this account and the quoted rates shall hold good for such quantity variations etc. Payments on bills shall, however, be made on actual measurements of quantities of work done as per approved drawings. Goods & Services Tax (GST) is applicable @ 18% on the quoted rates (being Works Contract)

Name of the Bidder/ Bidding Firm / Company :	
---	--

SCHEDULE OF RATE (Rev. 0) (This BOQ template must not be modified/replaced by the bidder and the same should be uploaded after filling the relevant columns, else the bidder is liable to be rejected for this tender. Bidders are allowed to enter the Bidder Name and Values only)

NUMBER #	TEXT #	NUMBER #	TEXT #	NUMBER #	NUMBER #	NUMBER #	TEXT #
Sl. No.	Item Description	Quantity	Units	BASIC RATE In Figures To be entered by the Bidder in Rs. P	TOTAL AMOUNT Incl. All taxes & duties (Excl. GST) in Rs. P	TOTAL AMOUNT Incl. All taxes , duties and GST in Rs. P	TOTAL AMOUNT Incl. All taxes, duties and GST In Words
9.22	Supply,unloading, storage, handling, transporation within site from store to site of installation, installation, connection, testing and commissioning of pre-wired 240V AC,1-Ph, WP outdoor,LED Lighting fixtures including LED lamp with driver and JB for looping of cables of following type which shall be suitable for use in safe area having IP-65 degree of protection complete with all accessories, double compression Ni-plated brass cable glangs & plugs, blanking plugs etc. as specified in Technical specification and all hardware for fixing the lighting fittings with structure/ lighting pole including cable glanding, crimping of lugs on cable conductor & connecting cables at fixtures, earthing, junction boxes, etc. including supply of all connecting materials like clamps, supports, conduits, down rods etc. as required as well as transportation from store to site of erection with all labour and material to make installation complete in all respect as per approved drawings, specifications and directions of Site Enginner / Engineer-in-charge. The rates shall be valid for all mounting heights.				0.00	0.00	INR Zero Only
9.23	90 W LED Flood light, WP type lighting fixturesof approve make as per technical specification as per technical specification with led lamp/chip, driver etc. complete with increased safety cable glands, plug suitable for 3 X 2.5mm ² XLPE-A-PVC cable and stopping plug.	5	Nos.		0.00	0.00	INR Zero Only
9.24	60 W LED Flood light, WP type lighting fixturesof approve make as per technical specification as per technical specification with led lamp/chip, driver etc. complete with increased safety cable glands, plug suitable for 3 X 2.5mm ² XLPE-A-PVC cable and stopping plug.	5	Nos.		0.00	0.00	INR Zero Only
9.25	45 W LED Flood light, WP type lighting fixturesof approve make as per technical specification with	5	Nos.		0.00	0.00	INR Zero Only

[Validate](#)[Print](#)[Help](#)

Item Rate BoQ

Tender Inviting Authority: Projects & Development India Limited, Noida

Name of Work: TENDER FOR SUPPLY CUM ERECTION OF ELECTRICAL & INSTRUMENTATION WORKS ON ITEM RATE BASIS AT TALCHER FERTILIZERS LTD., ANGUL, ODISHA

Contract No: PNPM/PC-183/E/8003/NCB

NOTE : Quantities mentioned in the Schedule of Rates are indicative and not exhaustive in nature. Payment shall be made as per actual quantity used/certified at site by Owner's Engineer-in-charge. Quantities indicated in Schedule of Rates are approximate and subject to variation on either side. The quantity of individual item may be deleted. Contractor shall not be entitled for any compensation on this account and the quoted rates shall hold good for such quantity variations etc. Payments on bills shall, however, be made on actual measurements of quantities of work done as per approved drawings. Goods & Services Tax (GST) is applicable @ 18% on the quoted rates (being Works Contract)

Name of the Bidder/ Bidding Firm / Company :	
---	--

SCHEDULE OF RATE (Rev. 0) (This BOQ template must not be modified/replaced by the bidder and the same should be uploaded after filling the relevant columns, else the bidder is liable to be rejected for this tender. Bidders are allowed to enter the Bidder Name and Values only)

NUMBER #	TEXT #	NUMBER #	TEXT #	NUMBER #	NUMBER #	NUMBER #	TEXT #
Sl. No.	Item Description	Quantity	Units	BASIC RATE In Figures To be entered by the Bidder in Rs. P	TOTAL AMOUNT Incl. All taxes & duties (Excl. GST) in Rs. P	TOTAL AMOUNT Incl. All taxes , duties and GST in Rs. P	TOTAL AMOUNT Incl. All taxes, duties and GST In Words
9.26	Bulkhead type LED light fitting type of approved make wall mounting suitable for 110V DC as per Technical specification complete with 1 x 9 W LED fixture with all accessories such as LED lamp/chip, electronic driver , terminal block, Reflector etc.. The fittings shall be provided with suspension accessory / wall mounting bracket depending upon directions by EIC / Site Engineer. The minimum degree of protection shall IP 65.	2	Nos.		0.00	0.00	INR Zero Only
9.27	Wiring				0.00	0.00	INR Zero Only

Item Rate BoQ

Tender Inviting Authority: Projects & Development India Limited, Noida

Name of Work: TENDER FOR SUPPLY CUM ERECTION OF ELECTRICAL & INSTRUMENTATION WORKS ON ITEM RATE BASIS AT TALCHER FERTILIZERS LTD., ANGUL, ODISHA

Contract No: PNPM/PC-183/E/8003/NCB

NOTE : Quantities mentioned in the Schedule of Rates are indicative and not exhaustive in nature. Payment shall be made as per actual quantity used/certified at site by Owner's Engineer-in-charge. Quantities indicated in Schedule of Rates are approximate and subject to variation on either side. The quantity of individual item may be deleted. Contractor shall not be entitled for any compensation on this account and the quoted rates shall hold good for such quantity variations etc. Payments on bills shall, however, be made on actual measurements of quantities of work done as per approved drawings. Goods & Services Tax (GST) is applicable @ 18% on the quoted rates (being Works Contract)

Name of the Bidder/ Bidding Firm / Company :	
--	--

SCHEDULE OF RATE (Rev. 0) (This BOQ template must not be modified/replaced by the bidder and the same should be uploaded after filling the relevant columns, else the bidder is liable to be rejected for this tender. Bidders are allowed to enter the Bidder Name and Values only)

NUMBER #	TEXT #	NUMBER #	TEXT #	NUMBER #	NUMBER #	NUMBER #	TEXT #
Sl. No.	Item Description	Quantity	Units	BASIC RATE In Figures To be entered by the Bidder in Rs. P	TOTAL AMOUNT Incl. All taxes & duties (Excl. GST) in Rs. P	TOTAL AMOUNT Incl. All taxes , duties and GST in Rs. P	TOTAL AMOUNT Incl. All taxes, duties and GST In Words
9.28	<p>Point Wiring : One Light / Fan / Exhaust Fan Point shall controlled by one switch . Supply and Providing Point Wiring system for primary light point/ceiling fan point/exhaust fan point/ call bell point/light plug point controlled by 1-6 Ampere modular type switch inclusive of the cost for providing circuit wiring from Distribution board to switch boards with 2x2.5 sq.mm., 1.1 KV grade PVC multi stranded fire resistant insulated copper conductor wire for light in required size of rigid PVC conduit with conduit accessories and 14swg bare copper earth wire continuity conductor including providing/fixing of PVC conduit of required size. Item shall also include wiring from switch board to point/fitting with 2x1.5 sq.mm copper conductor PVC insulated wire of 1100V grade with 14 SWG copper wire as earth continuity conductor for light in appropriate size of PVC conduit including providing & fixing PVC conduit with accessories such as bends,JB,sockets etc.required size of MS zinc passivated modular box with white inner plate and glossy white outer module plate for housing modular switch, sockets, fan regulators (Electronic heavy duty step up type) bell push on modular plate etc.The rates shall include cutting and refilling of chases/ Wall etc. including internal connections as required. All switch sockets shall be modular type fixed on modular plate. Make of modular plate, board, switch, socket etc shall be as per approved Make .(Actual nos. shall be decided at site).</p>	60	Nos.	0.00	0.00	0.00	INR Zero Only

[Validate](#)[Print](#)[Help](#)**Item Rate BoQ**

Tender Inviting Authority: Projects & Development India Limited, Noida

Name of Work: TENDER FOR SUPPLY CUM ERECTION OF ELECTRICAL & INSTRUMENTATION WORKS ON ITEM RATE BASIS AT TALCHER FERTILIZERS LTD., ANGUL, ODISHA

Contract No: PNPM/PC-183/E/8003/NCB

NOTE : Quantities mentioned in the Schedule of Rates are indicative and not exhaustive in nature. Payment shall be made as per actual quantity used/certified at site by Owner's Engineer-in-charge. Quantities indicated in Schedule of Rates are approximate and subject to variation on either side. The quantity of individual item may be deleted. Contractor shall not be entitled for any compensation on this account and the quoted rates shall hold good for such quantity variations etc. Payments on bills shall, however, be made on actual measurements of quantities of work done as per approved drawings. Goods & Services Tax (GST) is applicable @ 18% on the quoted rates (being Works Contract).

Name of the Bidder/ Bidding Firm / Company :	
--	--

SCHEDULE OF RATE (Rev. 0) (This BOQ template must not be modified/replaced by the bidder and the same should be uploaded after filling the relevant columns, else the bidder is liable to be rejected for this tender. Bidders are allowed to enter the Bidder Name and Values only)

NUMBER #	TEXT #	NUMBER #	TEXT #	NUMBER #	NUMBER #	NUMBER #	TEXT #
Sl. No.	Item Description	Quantity	Units	BASIC RATE In Figures To be entered by the Bidder in Rs. P	TOTAL AMOUNT Incl. All taxes & duties (Excl. GST) in Rs. P	TOTAL AMOUNT Incl. All taxes , duties and GST in Rs. P	TOTAL AMOUNT Incl. All taxes, duties and GST In Words
9.29	Point Wiring : TWO Light / Fan / Exhaust Fan Point shall controlled by one switch. Supply and Providing Point Wiring system for primary light point/ceiling fan point/exhaust fan point/ call bell point/light plug point controlled by 1-6 Ampere modular type switch inclusive of the cost for providing circuit wiring from Distribution board to switch boards with 2x2.5 sq.mm.,1.1 KV grade PVC multi stranded fire resistant insulated copper conductor wire for light in required size of rigid PVC conduit with conduit accessories and 14swg bare copper earth wire continuity conductor including providing/fixing of PVC conduit of required size. Item shall also include wiring from switch board to point/fitting with 2x1.5 sq.mm copper conductor PVC insulated wire of 1100V grade with 14 SWG copper wire as earth continuity conductor for light in appropriate size of PVC conduit including providing & fixing PVC conduit with accessories such as bends,JB,sockets etc.required size of MS zinc passivated modular box with white inner plate and glossy white outer module plate for housing modular switch,sockets,fan regulators (Electronic heavy duty step up type) bell push on modular plate etc.The rates shall include cutting and refilling of chases/wall etc. including internal connections as required. All switch sockets shall be modular type fixed on modular plate. Make of modular plate,board switch, socket etc shall be as per approved Make. (Actual nos. shall be decided at site).	20	Nos.		0.00	0.00	INR Zero Only

[Validate](#)[Print](#)[Help](#)

Item Rate BoQ

Tender Inviting Authority: Projects & Development India Limited, Noida

Name of Work: TENDER FOR SUPPLY CUM ERECTION OF ELECTRICAL & INSTRUMENTATION WORKS ON ITEM RATE BASIS AT TALCHER FERTILIZERS LTD., ANGUL, ODISHA

Contract No: PNPM/PC-183/E/8003/NCB

NOTE : Quantities mentioned in the Schedule of Rates are indicative and not exhaustive in nature. Payment shall be made as per actual quantity used/certified at site by Owner's Engineer-in-charge. Quantities indicated in Schedule of Rates are approximate and subject to variation on either side. The quantity of individual item may be deleted. Contractor shall not be entitled for any compensation on this account and the quoted rates shall hold good for such quantity variations etc. Payments on bills shall, however, be made on actual measurements of quantities of work done as per approved drawings. Goods & Services Tax (GST) is applicable @ 18% on the quoted rates (being Works Contract).

Name of the Bidder/ Bidding Firm / Company :							
SCHEDULE OF RATE (Rev. 0) (This BOQ template must not be modified/replaced by the bidder and the same should be uploaded after filling the relevant columns, else the bidder is liable to be rejected for this tender. Bidders are allowed to enter the Bidder Name and Values only)							
NUMBER #	TEXT #	NUMBER #	TEXT #	NUMBER #	NUMBER #	NUMBER #	TEXT #
Sl. No.	Item Description	Quantity	Units	BASIC RATE In Figures To be entered by the Bidder in Rs. P	TOTAL AMOUNT Incl. All taxes & duties (Excl. GST) in Rs. P	TOTAL AMOUNT Incl. All taxes , duties and GST in Rs. P	TOTAL AMOUNT Incl. All taxes, duties and GST In Words
9.30	<p>Point Wiring : THREE Light / Fan /Exhaust Fan Point shall controlled by one switch. Supply and Providing Point Wiring system for primary light point/ceiling fan point/exhaust fan point/ call bell point/light plug point controlled by 1-6 Ampere modular type switch inclusive of the cost for providing circuit wiring from Distribution board to switch boards with 2x2.5 sq.mm.,1.1 KV grade PVC multi stranded fire resistant insulated copper conductor wire for light in required size of rigid PVC conduit with conduit accessories and 14swg bare copper earth wire continuity conductor including providing/fixing of PVC conduit of required size. Item shall also include wiring from switch board to point/fitting with 2x1.5 sq.mm copper conductor PVC insulated wire of 1100V grade with 14 SWG copper wire as earth continuity conductor for light in appropriate size of PVC conduit including providing & fixing PVC conduit with accessories such as bends,JB,sockets etc.required size of MS zinc passivated modular box with white inner plate and glossy white outer module plate for housing modular switch,sockets,fan regulators (Electronic heavy duty step up type) bell push on modular plate etc.The rates shall include cutting and refilling of chases/wall etc. including internal connections as required. All switch sockets shall be modular type fixed on modular plate. Make of modular plate,board switch, socket etc shall be as per approved Make. (Actual nos. shall be decided at site).</p>	5	Nos.		0.00	0.00	INR Zero Only

Validate

Print

Help

Item Rate BoQ

Tender Inviting Authority: Projects & Development India Limited, Noida

Name of Work: TENDER FOR SUPPLY CUM ERECTION OF ELECTRICAL & INSTRUMENTATION WORKS ON ITEM RATE BASIS AT TALCHER FERTILIZERS LTD., ANGUL, ODISHA

Contract No: PNP/PC-183/E/8003/NCB

NOTE : Quantities mentioned in the Schedule of Rates are indicative and not exhaustive in nature. Payment shall be made as per actual quantity used/certified at site by Owner's Engineer-in-charge. Quantities indicated in Schedule of Rates are approximate and subject to variation on either side. The quantity of individual item may be deleted. Contractor shall not be entitled for any compensation on this account and the quoted rates shall hold good for such quantity variations etc. Payments on bills shall, however, be made on actual measurements of quantities of work done as per approved drawings. Goods & Services Tax (GST) is applicable @ 18% on the quoted rates (being Works Contract).

Name of the Bidder/ Bidding Firm / Company :							
SCHEDULE OF RATE (Rev. 0) (This BOQ template must not be modified/replaced by the bidder and the same should be uploaded after filling the relevant columns, else the bidder is liable to be rejected for this tender. Bidders are allowed to enter the Bidder Name and Values only)							
NUMBER #	TEXT #	NUMBER #	TEXT #	NUMBER #	NUMBER #	NUMBER #	TEXT #
Sl. No.	Item Description	Quantity	Units	BASIC RATE In Figures To be entered by the Bidder in Rs. P	TOTAL AMOUNT Incl. All taxes & duties (Excl. GST) in Rs. P	TOTAL AMOUNT Incl. All taxes , duties and GST in Rs. P	TOTAL AMOUNT Incl. All taxes, duties and GST In Words
9.31	Point Wiring : TWIN controlled Light Point. Supply and Providing Point Wiring system for twin controlled lighting point controlled by 1-6 Ampere modular type switch inclusive of the cost for providing circuit wiring from Distribution board to switch boards with 2x2.5 sq.mm., 1.1 KV grade PVC multi stranded fire resistant insulated copper conductor wire for light in required size of rigid PVC conduit with conduit accessories and 14swg bare copper earth wire continuity conductor including providing/fixing of PVC conduit of required size. Item shall also include wiring from switch board to point/fitting with 2x1.5 sq.mm copper conductor PVC insulated wire of 1100V grade with 14 SWG copper wire as earth continuity conductor for light in appropriate size of PVC conduit including providing & fixing PVC conduit with accessories such as bends, JB, sockets etc. required size of MS zinc passivated modular box with white inner plate and glossy white outer module plate for housing modular switch, sockets, fan regulators (Electronic heavy duty step up type) bell push on modular plate etc. The rates shall include cutting and refilling of chases/wall etc. including internal connections as required. All switch sockets shall be modular type fixed on modular plate. Make of modular plate, board switch, socket etc shall be as per approved Make. (Actual nos. shall be decided at site).	5	Nos.		0.00	0.00	INR Zero Only
9.32	Point Wiring : Plug Point Supply and Providing Point Wiring system for 6A Plug points with single core multi stranded PVC insulated unsheathed copper conductor fire retardant wires of 1100V grade in recessed PVC conduit including providing and fixing PVC conduits of required size complete with accessories such as bends, JB, Pull Boxes etc with plate, switches, sockets, screws and covers, Zinc Passivated MS modular boxes (16 gauge sheet construction) of suitable sizes, embedded in wall, concealed and flush with walls including cutting and refilling the chases/ Wall etc and inclusive of 14 SWG bare copper earth conductor for socket outlets as per specifications & direction of Engineer in charge. All Modular type switch & socket shall be of approved make. 6 Amp 6 pin socket outlet with 6A switch mounted side by side with 2x2.5 sq.mm PVC copper wire with 14 SWG bare copper earth wire (Actual nos. shall be decided at site).	20	Nos.		0.00	0.00	INR Zero Only

Item Rate BoQ

Tender Inviting Authority: Projects & Development India Limited, Noida

Name of Work: TENDER FOR SUPPLY CUM ERECTION OF ELECTRICAL & INSTRUMENTATION WORKS ON ITEM RATE BASIS AT TALCHER FERTILIZERS LTD., ANGUL, ODISHA

Contract No: PNP/PC-183/E/8003/NCB

NOTE : Quantities mentioned in the Schedule of Rates are indicative and not exhaustive in nature. Payment shall be made as per actual quantity used/certified at site by Owner's Engineer-in-charge. Quantities indicated in Schedule of Rates are approximate and subject to variation on either side. The quantity of individual item may be deleted. Contractor shall not be entitled for any compensation on this account and the quoted rates shall hold good for such quantity variations etc. Payments on bills shall, however, be made on actual measurements of quantities of work done as per approved drawings. Goods & Services Tax (GST) is applicable @ 18% on the quoted rates (being Works Contract)

Name of the Bidder/ Bidding Firm / Company :	
--	--

SCHEDULE OF RATE (Rev. 0) (This BOQ template must not be modified/replaced by the bidder and the same should be uploaded after filling the relevant columns, else the bidder is liable to be rejected for this tender. Bidders are allowed to enter the Bidder Name and Values only)

NUMBER #	TEXT #	NUMBER #	TEXT #	NUMBER #	NUMBER #	NUMBER #	TEXT #
Sl. No.	Item Description	Quantity	Units	BASIC RATE In Figures To be entered by the Bidder in Rs. P	TOTAL AMOUNT Incl. All taxes & duties (Excl. GST) in Rs. P	TOTAL AMOUNT Incl. All taxes , duties and GST in Rs. P	TOTAL AMOUNT Incl. All taxes, duties and GST In Words
9.33	Point Wiring : Secondary Plug Point from Primary Plug Point Supply and Providing Point Wiring system for 6A Plug points with single core multi stranded PVC insulated unsheathed copper conductor fire retardant wires of 1100V grade in recessed PVC conduit including providing and fixing PVC conduits of required size complete with accessories such as bends,JB, Pull Boxes etc with plate, switches,sockets,screws and covers, Zinc Passivated MS modular boxes (16 gauge sheet construction) of suitable sizes, embedded in wall, concealed and flush with walls including cutting and refilling the chases/Wall etc and inclusive of 14 SWG bare copper earth conductor for socket outlets as per specifications & direction of Engineer in charge. All Modular type switch & socket shall be of approved make.6 Amp 6 pin socket outlet with 6A switch mounted side by side with 2x2.5 sq.mm PVC copper wire with 14 SWG bare copper earth wire.(Actual nos. shall be decided at site).	40	Nos.		0.00	0.00	INR Zero Only
9.34	Point Wiring : Power Plug Point Supply and Providing Point Wiring system for 16A /6A power plug point with following sizes PVC insulated unsheathed single core multi stranded copper conductor, fire retardant wires of 1100V grade in recessed PVC conduits of required size complete with accessories such as bends,JB,Pull boxes etc with plate switches,sockets,screws and covers, Zinc Passivated MS modular boxes (16 gauge sheet construction) of suitable size, embedded in wall concealed and flush with walls including cutting and refilling the chases/Wall etc, and inclusive of 14SWG bare copper earth conductor for socket outlets as per specifications & direction of Engineer in charge. All modular type switch & socket shall be of approved make.16A, 6 Pin socket outlet with 16A switch mounted side by side with 2x4 sq.mm PVC copper wire with 14 SWG bare copper earth wire as an independent circuit from DB. (Actual nos. shall be decided at site).	15	Nos.		0.00	0.00	INR Zero Only

Item Rate BoQ

Tender Inviting Authority: Projects & Development India Limited, Noida

Name of Work: TENDER FOR SUPPLY CUM ERECTION OF ELECTRICAL & INSTRUMENTATION WORKS ON ITEM RATE BASIS AT TALCHER FERTILIZERS LTD., ANGUL, ODISHA

Contract No: PNPM/PC-183/E/8003/NCB

NOTE : Quantities mentioned in the Schedule of Rates are indicative and not exhaustive in nature. Payment shall be made as per actual quantity used/certified at site by Owner's Engineer-in-charge. Quantities indicated in Schedule of Rates are approximate and subject to variation on either side. The quantity of individual item may be deleted. Contractor shall not be entitled for any compensation on this account and the quoted rates shall hold good for such quantity variations etc. Payments on bills shall, however, be made on actual measurements of quantities of work done as per approved drawings. Goods & Services Tax (GST) is applicable @ 18% on the quoted rates (being Works Contract)

Name of the Bidder/ Bidding Firm / Company :

SCHEDULE OF RATE (Rev. 0) (This BOQ template must not be modified/replaced by the bidder and the same should be uploaded after filling the relevant columns, else the bidder is liable to be rejected for this tender. Bidders are allowed to enter the Bidder Name and Values only)

NUMBER #	TEXT #	NUMBER #	TEXT #	NUMBER #	NUMBER #	NUMBER #	TEXT #
Sl. No.	Item Description	Quantity	Units	BASIC RATE In Figures To be entered by the Bidder in Rs. P	TOTAL AMOUNT Incl. All taxes & duties (Excl. GST) in Rs. P	TOTAL AMOUNT Incl. All taxes , duties and GST in Rs. P	TOTAL AMOUNT Incl. All taxes, duties and GST In Words
9.35	Point Wiring : Secondary Power Plug Point from Primary Power Plug Point Supply and Providing Point Wiring system for 16A /6A power plug point with following sizes PVC insulated unsheathed single core multi stranded copper conductor, fire retardant wires of 1100V grade in recessed PVC conduits of required size complete with accessories such as bends, JB, Pull boxes etc with plate switches, sockets, screws and covers, Zinc Passivated MS modular boxes (16 gauge sheet construction) of suitable size, embedded in wall concealed and flush with walls including cutting and refilling the chases/Wall etc, and inclusive of 14SWG bare copper earth conductor for socket outlets as per specifications & direction of Engineer in charge. All modular type switch & socket shall be of approved make.16A, 6 Pin socket outlet with 16A switch mounted side by side with 2x4 sq.mm PVC copper wire with 14 SWG bare copper earth wire as an independent circuit from DB. Two nos.power plug point shall be looped from one primary plug point.	30	Nos.		0.00	0.00	INR Zero Only
9.36	Point Wiring : A.C. Point Supply and Providing Point Wiring system for 32A Industrial socket point (A.C. Point) with 2x4 sq.mm PVC insulated copper conductor FRLS cable in recessed PVC conduit along with 1x4 sq.mm. PVC insulated FRLS cable for earthing I/C, Providing & fixing 25A plug & socket unit complete with 32A DP MCB and 32A plug top including GI Box to be mounted on modular plate complete with connections, testing & commissioning etc (separate circuit for each point) : 32A DP MCB with Sockets for 1.5T AC	10	Nos.		0.00	0.00	INR Zero Only
9.37	Supply, hanging, fixing, connecting 3-blade ceiling fan including provision of cable/wire from ceiling rose or connector to fan including supply and fixing hexagonal fan hook with 12 mm dia. MS rod bend to shape as reqd.				0.00	0.00	INR Zero Only

Validate

Print

Help

Item Rate BoQ

Tender Inviting Authority: Projects & Development India Limited, Noida

Name of Work: TENDER FOR SUPPLY CUM ERECTION OF ELECTRICAL & INSTRUMENTATION WORKS ON ITEM RATE BASIS AT TALCHER FERTILIZERS LTD., ANGUL, ODISHA

Contract No: PNPM/PC-183/E/8003/NCB

NOTE : Quantities mentioned in the Schedule of Rates are indicative and not exhaustive in nature. Payment shall be made as per actual quantity used/certified at site by Owner's Engineer-in-charge. Quantities indicated in Schedule of Rates are approximate and subject to variation on either side. The quantity of individual item may be deleted. Contractor shall not be entitled for any compensation on this account and the quoted rates shall hold good for such quantity variations etc. Payments on bills shall, however, be made on actual measurements of quantities of work done as per approved drawings. Goods & Services Tax (GST) is applicable @ 18% on the quoted rates (being Works Contract).

Name of the Bidder/ Bidding Firm / Company :							
SCHEDULE OF RATE (Rev. 0) (This BOQ template must not be modified/replaced by the bidder and the same should be uploaded after filling the relevant columns, else the bidder is liable to be rejected for this tender. Bidders are allowed to enter the Bidder Name and Values only)							
NUMBER #	TEXT #	NUMBER #	TEXT #	NUMBER #	NUMBER #	NUMBER #	TEXT #
Sl. No.	Item Description	Quantity	Units	BASIC RATE In Figures To be entered by the Bidder in Rs. P	TOTAL AMOUNT Incl. All taxes & duties (Excl. GST) in Rs. P	TOTAL AMOUNT Incl. All taxes , duties and GST in Rs. P	TOTAL AMOUNT Incl. All taxes, duties and GST In Words
9.40	600 mm sweep	2	Nos.		0.00	0.00	INR Zero Only
9.41	Supply, Installation, Testing & Commissioning of following single phase wall fan and exhaust fan with guards / louvres, along with necessary brackets, all required civil works, making good the walls after fixing the fans etc.				0.00	0.00	INR Zero Only
9.42	380 mm sweep heavy duty exhaust fan	24	Nos		0.00	0.00	INR Zero Only
9.43	Corrosion proof, flameproof 300mm sweep heavy duty exhaust fan for battery room	2	Nos		0.00	0.00	INR Zero Only
9.44	WP SWITCH CUM SOCKET :				0.00	0.00	INR Zero Only
9.45	Supply, erection, installation, testing and commissioning of flameproof/weatherproof switch cum socket/welding receptacle having IP65 protection of approved makes to be installed on walls, columns, structures, including handling, storage, transportation from store to site of installation, supply & installation of double compression cable glands, suitable lugs & WP/flame proof plugs for sealing all spare entries etc., including connection and termination of all power cables, earthing wire and conduits, etc. complete as per drawings, specifications and direction of the Site Engineer, including the cost of all labour, tools, consumable materials etc. complete in all respect				0.00	0.00	INR Zero Only
9.46	415 V, 125 A switch cum socket with plug (Weatherproof)	35	Nos.		0.00	0.00	INR Zero Only
9.47	415V, 63A, Switch & Socket with Plug (No. of Pins 3P +N+ E), (Weather proof)	10	Nos.		0.00	0.00	INR Zero Only
9.48	415 V, 32 A switch cum socket with plug (Weatherproof)	90	Nos.		0.00	0.00	INR Zero Only
9.49	250 V, 16 A switch cum socket with plug (Weatherproof)	45	Nos.		0.00	0.00	INR Zero Only
9.50	EARTHING AND LIGHTNING PROTECTION				0.00	0.00	INR Zero Only

Item Rate BoQ

Tender Inviting Authority: Projects & Development India Limited, Noida

Name of Work: TENDER FOR SUPPLY CUM ERECTION OF ELECTRICAL & INSTRUMENTATION WORKS ON ITEM RATE BASIS AT TALCHER FERTILIZERS LTD., ANGUL, ODISHA

Contract No: PNP/PC-183/E/8003/NCB

NOTE : Quantities mentioned in the Schedule of Rates are indicative and not exhaustive in nature. Payment shall be made as per actual quantity used/certified at site by Owner's Engineer-in-charge. Quantities indicated in Schedule of Rates are approximate and subject to variation on either side. The quantity of individual item may be deleted. Contractor shall not be entitled for any compensation on this account and the quoted rates shall hold good for such quantity variations etc. Payments on bills shall, however, be made on actual measurements of quantities of work done as per approved drawings. Goods & Services Tax (GST) is applicable @ 18% on the quoted rates (being Works Contract)

Name of the Bidder/ Bidding Firm / Company :	
--	--

SCHEDULE OF RATE (Rev. 0) (This BOQ template must not be modified/replaced by the bidder and the same should be uploaded after filling the relevant columns, else the bidder is liable to be rejected for this tender. Bidders are allowed to enter the Bidder Name and Values only)

NUMBER #	TEXT #	NUMBER #	TEXT #	NUMBER #	NUMBER #	NUMBER #	TEXT #
Sl. No.	Item Description	Quantity	Units	BASIC RATE In Figures To be entered by the Bidder in Rs. P	TOTAL AMOUNT Incl. All taxes & duties (Excl. GST) in Rs. P	TOTAL AMOUNT Incl. All taxes , duties and GST in Rs. P	TOTAL AMOUNT Incl. All taxes, duties and GST In Words
9.51	Supply, Installation, Testing & Commissioning of 100 NB, 3.8 M long G.I. pipe Earth Electrode in Earth pit as per PDS attached with TS Including handling, transportation to Erection site, Excavation of Earth pit in all types of soil, back filling of pit with common salt, charcoal / coke and loose Earth after installation of Electrode there in, removal of surplus Earth away from Erection site, consolidation of loose Earth on back filled pit, making of bricks work, Inspection chamber on back filled pit and cover of RCC, there of complete with lifting hook, fixing & connecting inside the chamber of G.I. Earth bracket and other accessories of the Earth Electrode, painting of Earth pit No. and Earthing symbol on the cover, supply of salt, charcoal / coke, bricks, sand, cement, stone chips, reinforcement rods, lifting hook, necessary stainless steel hardware, paints etc. (Excluding supply of G.I. Earth Electrode & its accessories), all works, labour & materials complete as per Drawings, specifications, code & standards and direction of consultant / owner.	38	Nos.		0.00	0.00	INR Zero Only
9.52	Supply, Installation & Commissioning of GI Earth Bus bars (size: 390x50x12mm thick) as per PDS attached with TS Including handling, transportation, drilling of necessary holes/enlargement existing holes as required; all associated work for fixing the Bus bars in position e.g. cutting, leveling, aligning, chipping, grouting, welding bolting etc.; making good of broken/chipped portion on walls /columns by cement plastering. Supply of all necessary hardware (GI), paints, civil masonry materials etc. all work,labour complete as per drawings, specifications, codes and standards and directions of consultant /owner.Hot dip galvanized GI earth bus bar of size 390 x 50 x 12 thick (with min. coating 610gm/sq.m of zinc) with fixing materials as per specifications and direction of Site Engineer / Engineer-in charge	20	Nos		0.00	0.00	INR Zero Only
	Supplying and laving of the stainless steel SS-304 air terminations. base plate & clamping of down						

Item Rate BoQ

Tender Inviting Authority: Projects & Development India Limited, Noida

Name of Work: TENDER FOR SUPPLY CUM ERECTION OF ELECTRICAL & INSTRUMENTATION WORKS ON ITEM RATE BASIS AT TALCHER FERTILIZERS LTD., ANGUL, ODISHA

Contract No: PNPM/PC-183/E/8003/NCB

NOTE : Quantities mentioned in the Schedule of Rates are indicative and not exhaustive in nature. Payment shall be made as per actual quantity used/certified at site by Owner's Engineer-in-charge. Quantities indicated in Schedule of Rates are approximate and subject to variation on either side. The quantity of individual item may be deleted. Contractor shall not be entitled for any compensation on this account and the quoted rates shall hold good for such quantity variations etc. Payments on bills shall, however, be made on actual measurements of quantities of work done as per approved drawings. Goods & Services Tax (GST) is applicable @ 18% on the quoted rates (being Works Contract).

Name of the Bidder/ Bidding Firm / Company :	
---	--

SCHEDULE OF RATE (Rev. 0) (This BOQ template must not be modified/replaced by the bidder and the same should be uploaded after filling the relevant columns, else the bidder is liable to be rejected for this tender. Bidders are allowed to enter the Bidder Name and Values only)

NUMBER #	TEXT #	NUMBER #	TEXT #	NUMBER #	NUMBER #	NUMBER #	TEXT #
Sl. No.	Item Description	Quantity	Units	BASIC RATE In Figures To be entered by the Bidder in Rs. P	TOTAL AMOUNT Incl. All taxes & duties (Excl. GST) in Rs. P	TOTAL AMOUNT Incl. All taxes , duties and GST in Rs. P	TOTAL AMOUNT Incl. All taxes, duties and GST In Words
9.54	HT CABLE JOINT (11 KV)				0.00	0.00	INR Zero Only
9.55	Supply, Making straight-through joint on 11 KV Aluminium XLPE insulated armoured screened cable, including the supply of required materials such as cable jointing kit (of heat shrinkable sleeve type of Raychem, materials, labour, tools and tackles, consumables etc., as per drawings, specification and directions of Site Engineer / Engineer-in-Charge. For cables of size upto 3 core x 400 sq. mm Note: Lugs supplied with HT cable joint shall be Al/Cu/Bimetallic (as per cable/bus bar type).				0.00	0.00	INR Zero Only
9.56	11KV (UE) grade XLPE insulated, 3Cx240 (Al)	2	Nos.		0.00	0.00	INR Zero Only
9.57	HT Cable Termination (11 /3.3KV):				0.00	0.00	INR Zero Only
9.58	Supply, termination and connection of following 11KV(UE) Multicore/single core, XLPE cable termination kit (indoor type), heat shrinkable sleeve type of Raychem make with all accessories, including cutting (tools and accessories for termination should meet the selected standards), stripping of cable insulation providing copper cable end lugs and cable glands as required, restoration of insulation, supplying and providing the cable supporting clamps, straps, cable tags connection to the terminals of HT panel, VFDs, Isolators, transformer, DG etc., earthing of armouring, materials, labour, tools and tackles, consumables etc., as per drawings, specification and directions of Site Engineer / Engineer-in-Charge. Note: Lugs supplied with HT cable termination shall be Al/Cu/Bimetallic (as per cable/bus bar type).				0.00	0.00	INR Zero Only
9.59	11KV (UE) grade XLPE insulated, 3Cx240 (Al)	12	Nos.		0.00	0.00	INR Zero Only

Item Rate BoQ

Tender Inviting Authority: Projects & Development India Limited, Noida

Name of Work: TENDER FOR SUPPLY CUM ERECTION OF ELECTRICAL & INSTRUMENTATION WORKS ON ITEM RATE BASIS AT TALCHER FERTILIZERS LTD., ANGUL, ODISHA

Contract No: PNPM/PC-183/E/8003/NCB

NOTE : Quantities mentioned in the Schedule of Rates are indicative and not exhaustive in nature. Payment shall be made as per actual quantity used/certified at site by Owner's Engineer-in-charge. Quantities indicated in Schedule of Rates are approximate and subject to variation on either side. The quantity of individual item may be deleted. Contractor shall not be entitled for any compensation on this account and the quoted rates shall hold good for such quantity variations etc. Payments on bills shall, however, be made on actual measurements of quantities of work done as per approved drawings. Goods & Services Tax (GST) is applicable @ 18% on the quoted rates (being Works Contract).

Name of the Bidder/ Bidding Firm / Company :							
SCHEDULE OF RATE (Rev. 0) (This BOQ template must not be modified/replaced by the bidder and the same should be uploaded after filling the relevant columns, else the bidder is liable to be rejected for this tender. Bidders are allowed to enter the Bidder Name and Values only)							
NUMBER #	TEXT #	NUMBER #	TEXT #	NUMBER #	NUMBER #	NUMBER #	TEXT #
Sl. No.	Item Description	Quantity	Units	BASIC RATE In Figures To be entered by the Bidder in Rs. P	TOTAL AMOUNT Incl. All taxes & duties (Excl. GST) in Rs. P	TOTAL AMOUNT Incl. All taxes , duties and GST in Rs. P	TOTAL AMOUNT Incl. All taxes, duties and GST In Words
9.62	GI PIPE				0.00	0.00	INR Zero Only
9.63	Supply, erection & installation of cable conduits made up of GI pipes of medium class 'B' subject to owner's approval in trenches (already made), on walls, concrete structure etc., including supply and installation of all the necessary pipe fittings such as bends, sockets, elbows, tees etc., bending, threading, binding, clamping, providing, spacers, plugs, packings, bushings etc., as required Job complete in all respects including the cost of all labour, tools, material etc. and as per specifications and directions of site engineer / Engineer-in-Charge.				0.00	0.00	INR Zero Only
9.64	100 mm	100	Mtrs.		0.00	0.00	INR Zero Only
9.65	50 mm	150	Mtrs.		0.00	0.00	INR Zero Only
9.66	HDPE PIPE				0.00	0.00	INR Zero Only
9.67	Supply, laying of HDPE 32mm dia 3mm thick as per IS 7238 grade 80, Pipe in trenches / walls / concrete structure / panels etc. as per specifications and drawings & blowing / laying of Optical Fibre Cable in HDPE pipe, carrying out end to end testing of laid Optical fibre cables by taking OTDR traces and submitting the OTDR trace printouts to Site Engineer / Engineer-in-charge. The job includes the supply and installation of required materials such as fixing clamps, screws, tags etc. as required to complete the job in all respects as per drawings and directions of Site Engineer / Engineer-in-charge including cost of all labour, tools & tackles, test instruments, materials etc. The job includes handing over the tested cables to the Telecom / Control System Works Contractor in commissioning of Local Area Network.	600	Mtrs.		0.00	0.00	INR Zero Only

Validate

Print

Help

Item Rate BoQ

Tender Inviting Authority: Projects & Development India Limited, Noida

Name of Work: TENDER FOR SUPPLY CUM ERECTION OF ELECTRICAL & INSTRUMENTATION WORKS ON ITEM RATE BASIS AT TALCHER FERTILIZERS LTD., ANGUL, ODISHA

Contract No: PNP/PC-183/E/8003/NCB

NOTE : Quantities mentioned in the Schedule of Rates are indicative and not exhaustive in nature. Payment shall be made as per actual quantity used/certified at site by Owner's Engineer-in-charge. Quantities indicated in Schedule of Rates are approximate and subject to variation on either side. The quantity of individual item may be deleted. Contractor shall not be entitled for any compensation on this account and the quoted rates shall hold good for such quantity variations etc. Payments on bills shall, however, be made on actual measurements of quantities of work done as per approved drawings. Goods & Services Tax (GST) is applicable @ 18% on the quoted rates (being Works Contract).

Name of the Bidder/ Bidding Firm / Company :							
SCHEDULE OF RATE (Rev. 0) (This BOQ template must not be modified/replaced by the bidder and the same should be uploaded after filling the relevant columns, else the bidder is liable to be rejected for this tender. Bidders are allowed to enter the Bidder Name and Values only)							
NUMBER #	TEXT #	NUMBER #	TEXT #	NUMBER #	NUMBER #	NUMBER #	TEXT #
Sl. No.	Item Description	Quantity	Units	BASIC RATE In Figures To be entered by the Bidder in Rs. P	TOTAL AMOUNT Incl. All taxes & duties (Excl. GST) in Rs. P	TOTAL AMOUNT Incl. All taxes , duties and GST in Rs. P	TOTAL AMOUNT Incl. All taxes, duties and GST In Words
9.68	Supply, fabrication, erection, installation of steel structural works of any type and shape such as cable raks, cable trays, push button control posts etc., as required job complete in all respects including the cost of all labour, tools, material etc., complete and as per specifications and directions of site engineer/Engineer-in-Charge.	15000	Kg		0.00	0.00	INR Zero Only
9.69	Supply, Fabrication & installation of 2 mm thick Al sheet for rain protective hood for outdoor equipment e.g. motors, switch sockets, junction boxes etc.	10	M ²		0.00	0.00	INR Zero Only
9.70	Supply, Fabrication and Installation of 8mm thick chequered plate in flooring, steps, covers over cable trenches in switch board room, painting with one coats of bitumen paint in the 50% thinner with two coats of black bitumen paints including supply of all consumables and paints.	500	Kg		0.00	0.00	INR Zero Only
9.71	WP JUNCTION BOX				0.00	0.00	INR Zero Only
9.72	Supply, erection, installation, testing and commissioning of flameproof & weather proof 240 V, 25A, junction box for providing cable termination, including connection and termination of earthing wire and conduits etc., including supply & installation of double compression cable glands & flame proof plugs for sealing all spare entries complete as per drawings, specifications and direction of the Site Engineer, including the cost of all labour, tools, consumable materials etc., complete in all respect.				0.00	0.00	INR Zero Only
9.73	240V, 16A, 4 way junction box with 4 cable entries (4 x 3/4") at bottom & 20 nos. terminals.	50	Nos.		0.00	0.00	INR Zero Only
9.74	Supplying and spreading of approved quality fine dry river sand in cable trenches including the cost of all material, transport, load and lift charges, labour, tools and tackles, consumables etc., as per drawings, specification and directions of Site Engineer / Engineer-in-Charge.	130	M3		0.00	0.00	INR Zero Only

[Validate](#)[Print](#)[Help](#)

Item Rate BoQ

Tender Inviting Authority: Projects & Development India Limited, Noida

Name of Work: TENDER FOR SUPPLY CUM ERECTION OF ELECTRICAL & INSTRUMENTATION WORKS ON ITEM RATE BASIS AT TALCHER FERTILIZERS LTD., ANGUL, ODISHA

Contract No: PNP/PC-183/E/8003/NCB

NOTE : Quantities mentioned in the Schedule of Rates are indicative and not exhaustive in nature. Payment shall be made as per actual quantity used/certified at site by Owner's Engineer-in-charge. Quantities indicated in Schedule of Rates are approximate and subject to variation on either side. The quantity of individual item may be deleted. Contractor shall not be entitled for any compensation on this account and the quoted rates shall hold good for such quantity variations etc. Payments on bills shall, however, be made on actual measurements of quantities of work done as per approved drawings. **Goods & Services Tax (GST) is applicable @ 18% on the quoted rates (being Works Contract)**

Name of the Bidder/ Bidding Firm / Company :	
--	--

SCHEDULE OF RATE (Rev. 0) (This BOQ template must not be modified/replaced by the bidder and the same should be uploaded after filling the relevant columns, else the bidder is liable to be rejected for this tender. Bidders are allowed to enter the Bidder Name and Values only)

NUMBER #	TEXT #	NUMBER #	TEXT #	NUMBER #	NUMBER #	NUMBER #	TEXT #
Sl. No.	Item Description	Quantity	Units	BASIC RATE In Figures To be entered by the Bidder in Rs. P	TOTAL AMOUNT Incl. All taxes & duties (Excl. GST) in Rs. P	TOTAL AMOUNT Incl. All taxes , duties and GST in Rs. P	TOTAL AMOUNT Incl. All taxes, duties and GST In Words
9.75	Supply laying, spreading of Class B 9"x 4.25" x 3" bricks for cable trenches soiling with sand filling in the interstices, in cable trenches for protection including the cost of all brick and sand, labour, load and lift charges, tools and tackles etc., as per drawings, specification and directions of Site Engineer / Engineer-in-Charge.	17000	Nos		0.00	0.00	INR Zero Only
9.76	Supply, erection & installation of MS cable markers, including excavation, installation of the markers, cement concrete grouting, backfilling, materials, labour, tools and tackles, consumables etc., as per drawings, specification and directions of Site Engineer / Engineer-in-Charge.	20	Nos.		0.00	0.00	INR Zero Only
9.77	EXCAVATION AND BACK FILLING				0.00	0.00	INR Zero Only
9.78	Excavation of 1700 mtr. length x 400/600 mm wide x 1200 mm deep a for laying of cables including disposal of excavated earth, lead up to 100 mtrs. and lift up to 1.5 mtrs., disposed earth to be levelled and neatly dressed	420	M ³		0.00	0.00	INR Zero Only
9.79	Back filling with excavated earth in trench including consolidating each deposited layer by ramming, dressing etc.	280	M ³		0.00	0.00	INR Zero Only
9.80	TERMINATION OF CABLES (LT)				0.00	0.00	INR Zero Only

Validate

Print

Help

Item Rate BoQ

Tender Inviting Authority: Projects & Development India Limited, Noida

Name of Work: TENDER FOR SUPPLY CUM ERECTION OF ELECTRICAL & INSTRUMENTATION WORKS ON ITEM RATE BASIS AT TALCHER FERTILIZERS LTD., ANGUL, ODISHA

Contract No: PNPM/PC-183/E/8003/NCB

NOTE : Quantities mentioned in the Schedule of Rates are indicative and not exhaustive in nature. Payment shall be made as per actual quantity used/certified at site by Owner's Engineer-in-charge. Quantities indicated in Schedule of Rates are approximate and subject to variation on either side. The quantity of individual item may be deleted. Contractor shall not be entitled for any compensation on this account and the quoted rates shall hold good for such quantity variations etc. Payments on bills shall, however, be made on actual measurements of quantities of work done as per approved drawings. Goods & Services Tax (GST) is applicable @ 18% on the quoted rates (being Works Contract).

Name of the Bidder/ Bidding Firm / Company :	
--	--

SCHEDULE OF RATE (Rev. 0) (This BOQ template must not be modified/replaced by the bidder and the same should be uploaded after filling the relevant columns, else the bidder is liable to be rejected for this tender. Bidders are allowed to enter the Bidder Name and Values only)

NUMBER #	TEXT #	NUMBER #	TEXT #	NUMBER #	NUMBER #	NUMBER #	TEXT #
Sl. No.	Item Description	Quantity	Units	BASIC RATE In Figures To be entered by the Bidder in Rs. P	TOTAL AMOUNT Incl. All taxes & duties (Excl. GST) in Rs. P	TOTAL AMOUNT Incl. All taxes , duties and GST in Rs. P	TOTAL AMOUNT Incl. All taxes, duties and GST In Words
9.81	End termination and subsequent testing of XLPE insulated single core/ multi core armoured cables of 1.1KV grade, Al/ Cu cable, including supply of double compression rolled aluminium cable glands, suitable lugs (Al/Cu/Bimetallic) and lugs of all phases & neutral , all labour and consumable materials to make installation complete in all respect. Modification in existing switch board for accommodating the proposed cables. The rate shall include drilling, taping of cable insulation, crimping of lugs to the conductor, connection of the lugs to equipment terminal, supply and fixing of supports & clamps for cables, G.I. nuts, screws, bolts, washers and other necessary hardware, PVC tape of required grade for taping, making cable entries dust and vermin proof, earthing etc. as per instruction of manufacturer, approved drawings, specifications and directions of engineer-in-charge.				0.00	0.00	INR Zero Only
9.82	3.5C x 630 mm ² (Al)	22	Nos.		0.00	0.00	INR Zero Only
9.83	3.5C x 400 mm ² (Al)	4	Nos.		0.00	0.00	INR Zero Only
9.84	3.5C x 300 mm ² (Al)	4	Nos.		0.00	0.00	INR Zero Only
9.85	3.5C x 240 mm ² (Al)	6	Nos.		0.00	0.00	INR Zero Only
9.86	3.5C x 150 mm ² (Al)	16	Nos.		0.00	0.00	INR Zero Only
9.87	3.5C x 120 mm ² (Al)	4	Nos.		0.00	0.00	INR Zero Only
9.88	3.5C x 70 mm ² (Al)	4	Nos.		0.00	0.00	INR Zero Only
9.89	3.5C x 50 mm ² (Al)	6	Nos.		0.00	0.00	INR Zero Only
9.90	3.5C x 35 mm ² (Al)	16	Nos.		0.00	0.00	INR Zero Only
9.91	3.5C x 25 mm ² (Al)	4	Nos.		0.00	0.00	INR Zero Only

Item Rate BoQ

Tender Inviting Authority: Projects & Development India Limited, Noida

Name of Work: TENDER FOR SUPPLY CUM ERECTION OF ELECTRICAL & INSTRUMENTATION WORKS ON ITEM RATE BASIS AT TALCHER FERTILIZERS LTD., ANGUL, ODISHA

Contract No: PNPM/PC-183/E/8003/NCB

NOTE : Quantities mentioned in the Schedule of Rates are indicative and not exhaustive in nature. Payment shall be made as per actual quantity used/certified at site by Owner's Engineer-in-charge. Quantities indicated in Schedule of Rates are approximate and subject to variation on either side. The quantity of individual item may be deleted. Contractor shall not be entitled for any compensation on this account and the quoted rates shall hold good for such quantity variations etc. Payments on bills shall, however, be made on actual measurements of quantities of work done as per approved drawings. Goods & Services Tax (GST) is applicable @ 18% on the quoted rates (being Works Contract)

Name of the Bidder/ Bidding Firm / Company :	
--	--

SCHEDULE OF RATE (Rev. 0) (This BOQ template must not be modified/replaced by the bidder and the same should be uploaded after filling the relevant columns, else the bidder is liable to be rejected for this tender. Bidders are allowed to enter the Bidder Name and Values only)

NUMBER #	TEXT #	NUMBER #	TEXT #	NUMBER #	NUMBER #	NUMBER #	TEXT #
Sl. No.	Item Description	Quantity	Units	BASIC RATE In Figures To be entered by the Bidder in Rs. P	TOTAL AMOUNT Incl. All taxes & duties (Excl. GST) in Rs. P	TOTAL AMOUNT Incl. All taxes , duties and GST in Rs. P	TOTAL AMOUNT Incl. All taxes, duties and GST In Words
9.94	4C x 16 mm ² (Al)	80	Nos.		0.00	0.00	INR Zero Only
9.95	3C x 120 mm ² (Al)	2	Nos.		0.00	0.00	INR Zero Only
9.96	3C x 70 mm ² (Al)	2	Nos.		0.00	0.00	INR Zero Only
9.97	3C x 50 mm ² (Al)	2	Nos.		0.00	0.00	INR Zero Only
9.98	3C x 35 mm ² (Al)	4	Nos.		0.00	0.00	INR Zero Only
9.99	3C x 25 mm ² (Al)	8	Nos.		0.00	0.00	INR Zero Only
10.00	3C x 10 mm ² (Cu)	2	Nos.		0.00	0.00	INR Zero Only
10.01	3C x 6 mm ² (Cu)	4	Nos.		0.00	0.00	INR Zero Only
10.02	3C x 4 mm ² (Cu)	4	Nos.		0.00	0.00	INR Zero Only
10.03	3C x 2.5 mm ² (Cu)	100	Nos.		0.00	0.00	INR Zero Only
10.04	5C x 2.5 mm ² (Cu)	2	Nos.		0.00	0.00	INR Zero Only
10.05	7C x 2.5 mm ² (Cu)	2	Nos.		0.00	0.00	INR Zero Only
10.06	12C x 2.5 mm ² (Cu)	6	Nos.		0.00	0.00	INR Zero Only
10.07	19C x 2.5 mm ² (Cu)	6	Nos.		0.00	0.00	INR Zero Only
10.08	1Cx185 mm ² (Al) Unarmoured	8	Nos.		0.00	0.00	INR Zero Only
10.09	1Cx16 mm ² (Al) Unarmoured	12	Nos.		0.00	0.00	INR Zero Only
10.10	6 fiber, multi mode optical fiber cable along with all accessories like reciever, converter, transmiitor, patch card etc	4	Nos.		0.00	0.00	INR Zero Only
10.11	Supply, Installation , testing and commissioning of 240V, 1-Ph, Wall Mounting Fans / Ceiling Fans (with Electronic Regulator) / Man Cooler Fans etc on wall / Ceiling / Steel Structure including supply,				0.00	0.00	INR Zero Only

Item Rate BoQ

Tender Inviting Authority: Projects & Development India Limited, Noida

Name of Work: TENDER FOR SUPPLY CUM ERECTION OF ELECTRICAL & INSTRUMENTATION WORKS ON ITEM RATE BASIS AT TALCHER FERTILIZERS LTD., ANGUL, ODISHA

Contract No: PNPM/PC-183/E/8003/NCB

NOTE : Quantities mentioned in the Schedule of Rates are indicative and not exhaustive in nature. Payment shall be made as per actual quantity used/certified at site by Owner's Engineer-in-charge. Quantities indicated in Schedule of Rates are approximate and subject to variation on either side. The quantity of individual item may be deleted. Contractor shall not be entitled for any compensation on this account and the quoted rates shall hold good for such quantity variations etc. Payments on bills shall, however, be made on actual measurements of quantities of work done as per approved drawings. Goods & Services Tax (GST) is applicable @ 18% on the quoted rates (being Works Contract)

Name of the Bidder/ Bidding Firm / Company :	
--	--

SCHEDULE OF RATE (Rev. 0) (This BOQ template must not be modified/replaced by the bidder and the same should be uploaded after filling the relevant columns, else the bidder is liable to be rejected for this tender. Bidders are allowed to enter the Bidder Name and Values only)

NUMBER #	TEXT #	NUMBER #	TEXT #	NUMBER #	NUMBER #	NUMBER #	TEXT #
Sl. No.	Item Description	Quantity	Units	BASIC RATE In Figures To be entered by the Bidder in Rs. P	TOTAL AMOUNT Incl. All taxes & duties (Excl. GST) in Rs. P	TOTAL AMOUNT Incl. All taxes , duties and GST in Rs. P	TOTAL AMOUNT Incl. All taxes, duties and GST In Words
10.12	400 mm sweep heavy duty wall fan with string controlled regulator & rotation.	4	Nos.		0.00	0.00	INR Zero Only
10.13	PUBLIC ADDRESS SYSTEM				0.00	0.00	INR Zero Only
10.14	Design, engineering, manufacture, procurement of materials and bought out components, assembly at shop, inspection, testing at manufacturer's works, packing, delivery at site, Unloading, Handling, Storage, transportation within site, Assembly and Erection, testing, Commissioning & guarantee test for final acceptance of Public Address System of the following, including supply of commissioning spares, special tools and tackles, all required installation material, & Testing and commissioning at site, documentation as per the enclosed Technical specification and other codes and standards attached or referred. Note: Installation & Commissioning shall be executed by PA system OEM.				0.00	0.00	INR Zero Only
10.15	WP (IP-65) Wall mounted/structure mounted FCS with 2 dual positions key with keypad and built-in 25W booster amplifier.	35	Nos.		0.00	0.00	INR Zero Only
10.16	FLP & WP (IP-65) FCS with 2 dual positions key with keypad and built-in 25W booster amplifier for Gas Gr. IIC	1	Nos.		0.00	0.00	INR Zero Only
10.17	WP (IP-65) 25W/12.5 paging loud speaker for FCS.	35	Nos.		0.00	0.00	INR Zero Only
10.18	WP (IP-65) 15W paging loud speaker for FCS box type for installation in Substation/Building	2	Nos.		0.00	0.00	INR Zero Only
10.19	FLP, WP (IP-65) 25W paging loud speaker for FCS suitable for Gas Gr. IIC .	1	Nos.		0.00	0.00	INR Zero Only
10.20	FRP Acoustic Hood for Sound Protection.	15	Nos.		0.00	0.00	INR Zero Only
10.21	FRP Glass Moulded Full Canopy for rain protection.	20	Nos.		0.00	0.00	INR Zero Only

Validate

Print

Help

Item Rate BoQ

Tender Inviting Authority: Projects & Development India Limited, Noida

Name of Work: TENDER FOR SUPPLY CUM ERECTION OF ELECTRICAL & INSTRUMENTATION WORKS ON ITEM RATE BASIS AT TALCHER FERTILIZERS LTD., ANGUL, ODISHA

Contract No: PNPM/PC-183/E/8003/NCB

NOTE : Quantities mentioned in the Schedule of Rates are indicative and not exhaustive in nature. Payment shall be made as per actual quantity used/certified at site by Owner's Engineer-in-charge. Quantities indicated in Schedule of Rates are approximate and subject to variation on either side. The quantity of individual item may be deleted. Contractor shall not be entitled for any compensation on this account and the quoted rates shall hold good for such quantity variations etc. Payments on bills shall, however, be made on actual measurements of quantities of work done as per approved drawings. Goods & Services Tax (GST) is applicable @ 18% on the quoted rates (being Works Contract).

Name of the Bidder/ Bidding Firm / Company :							
SCHEDULE OF RATE (Rev. 0) (This BOQ template must not be modified/replaced by the bidder and the same should be uploaded after filling the relevant columns, else the bidder is liable to be rejected for this tender. Bidders are allowed to enter the Bidder Name and Values only)							
NUMBER #	TEXT #	NUMBER #	TEXT #	NUMBER #	NUMBER #	NUMBER #	TEXT #
Sl. No.	Item Description	Quantity	Units	BASIC RATE In Figures To be entered by the Bidder in Rs. P	TOTAL AMOUNT Incl. All taxes & duties (Excl. GST) in Rs. P	TOTAL AMOUNT Incl. All taxes , duties and GST in Rs. P	TOTAL AMOUNT Incl. All taxes, duties and GST In Words
10.24	50 Pair X 0.8 mm Armored Cable with FRLS outer sheath overall un-screened cable from owner's exchange to PA Junction box	2500	Mtrs.		0.00	0.00	INR Zero Only
10.25	5 Pair X 0.8 mm Armored Cable with FRLS outer sheath overall un-screened cable for both Loudspeaker and Field call stations	3000	Mtrs.		0.00	0.00	INR Zero Only
10.26	Erection, testing and commssioing of complete PA system including MCS ,FCS, Hooters, canopy, accoustic hood,paging speaker,laying and termination of all power and signal cables including supply of consumeable, glands, lugs etc and interface and seamless integration with other PA system of plant.	1	Lot		0.00	0.00	INR Zero Only
10.27	WBM ROAD / CONCRETE BREAKING : WBM Road/concrete breaking for cable trenches including required shoring strutting etc., and repairing of the road/dyke to original condition and disposing off excess materials (within the work site) job complete in all respects including the cost of labour, tools, materials, load, lift hire charges of equipments, if any, complete as per drawings, specification and directions of Site Engineer / Engineer-in-Charge.	10	M3		0.00	0.00	INR Zero Only
10.28	415 V MV BUS DUCT				0.00	0.00	INR Zero Only
10.29	Supply of 415 V Bus Duct as perspecified in data sheets, Technical Specification - Electrical, Technical Specification Doc. No. PC183-TS-0807, etc. attached with the NIT.				0.00	0.00	INR Zero Only

Item Rate BoQ

Tender Inviting Authority: Projects & Development India Limited, Noida

Name of Work: TENDER FOR SUPPLY CUM ERECTION OF ELECTRICAL & INSTRUMENTATION WORKS ON ITEM RATE BASIS AT TALCHER FERTILIZERS LTD., ANGUL, ODISHA

Contract No: PNPM/PC-183/E/8003/NCB

NOTE : Quantities mentioned in the Schedule of Rates are indicative and not exhaustive in nature. Payment shall be made as per actual quantity used/certified at site by Owner's Engineer-in-charge. Quantities indicated in Schedule of Rates are approximate and subject to variation on either side. The quantity of individual item may be deleted. Contractor shall not be entitled for any compensation on this account and the quoted rates shall hold good for such quantity variations etc. Payments on bills shall, however, be made on actual measurements of quantities of work done as per approved drawings. Goods & Services Tax (GST) is applicable @ 18% on the quoted rates (being Works Contract)

Name of the Bidder/ Bidding Firm / Company :	
--	--

SCHEDULE OF RATE (Rev. 0) (This BOQ template must not be modified/replaced by the bidder and the same should be uploaded after filling the relevant columns, else the bidder is liable to be rejected for this tender. Bidders are allowed to enter the Bidder Name and Values only)

NUMBER #	TEXT #	NUMBER #	TEXT #	NUMBER #	NUMBER #	NUMBER #	TEXT #
Sl. No.	Item Description	Quantity	Units	BASIC RATE In Figures To be entered by the Bidder in Rs. P	TOTAL AMOUNT Incl. All taxes & duties (Excl. GST) in Rs. P	TOTAL AMOUNT Incl. All taxes , duties and GST in Rs. P	TOTAL AMOUNT Incl. All taxes, duties and GST In Words
10.30	3200 A, 415 V, 50 Hz, 50kA for 1 second, Non-Segregated High Conductivity Copper TPN Bus Duct of 12.5 Mtr. length (From Transformer Flange Centre Line to Panel Flange Centre Line) including 2 nos. horizontal bends and 3 nos. vertical bends between 11 kV / 0.433 kV, 2 MVA Transformers and PMCC-1 with associated equipments and all other accessories as per enclosed Main Substation Equipment Layout , Technical Specification - Electrical, Technical Specification Doc. No. PC183-TS-0807, etc. attached with the NIT.	2	Sets		0.00	0.00	INR Zero Only
10.31	Supply,Installation, testing and commissioning of 240V room lighting boards along with required wiring (concealed in PVC conduit / on wall) having following features:-				0.00	0.00	INR Zero Only
10.32	1 no. Switch & Socket for 6 / 16 Amp 2 nos. 6 Amp switches with regulators for ceiling Fan 2 nos. 6 Amp switches for lighting	50	Nos.		0.00	0.00	INR Zero Only
10.33	1 no. Switch & Socket for 6 / 16 Amp 5 nos. 6 Amp switches for lighting	15	Nos.		0.00	0.00	INR Zero Only
10.34	1 no. Switch & Socket for 6 / 16 Amp	70	Nos.		0.00	0.00	INR Zero Only
11.00	MISCELLANEOUS ITEMS				0.00	0.00	INR Zero Only
11.11	Supply and Fixing of Caution boards / dangers boards written in ENGLISH & HINDI of the following voltages.				0.00	0.00	INR Zero Only

Validate

Print

Help

Item Rate BoQ

Tender Inviting Authority: Projects & Development India Limited, Noida

Name of Work: TENDER FOR SUPPLY CUM ERECTION OF ELECTRICAL & INSTRUMENTATION WORKS ON ITEM RATE BASIS AT TALCHER FERTILIZERS LTD., ANGUL, ODISHA

Contract No: PNPM/PC-183/E/8003/NCB

NOTE : Quantities mentioned in the Schedule of Rates are indicative and not exhaustive in nature. Payment shall be made as per actual quantity used/certified at site by Owner's Engineer-in-charge. Quantities indicated in Schedule of Rates are approximate and subject to variation on either side. The quantity of individual item may be deleted. Contractor shall not be entitled for any compensation on this account and the quoted rates shall hold good for such quantity variations etc. Payments on bills shall, however, be made on actual measurements of quantities of work done as per approved drawings. Goods & Services Tax (GST) is applicable @ 18% on the quoted rates (being Works Contract)

Name of the Bidder/ Bidding Firm / Company :							
SCHEDULE OF RATE (Rev. 0) (This BOQ template must not be modified/replaced by the bidder and the same should be uploaded after filling the relevant columns, else the bidder is liable to be rejected for this tender. Bidders are allowed to enter the Bidder Name and Values only)							
NUMBER #	TEXT #	NUMBER #	TEXT #	NUMBER #	NUMBER #	NUMBER #	TEXT #
Sl. No.	Item Description	Quantity	Units	BASIC RATE In Figures To be entered by the Bidder in Rs. P	TOTAL AMOUNT Incl. All taxes & duties (Excl. GST) in Rs. P	TOTAL AMOUNT Incl. All taxes , duties and GST in Rs. P	TOTAL AMOUNT Incl. All taxes, duties and GST In Words
11.14	Supply and Fixing of shock treatment chart written in English and Local language duly framed and approved by engineer-in-charge.	1	Nos		0.00	0.00	INR Zero Only
11.15	Supply and Fixing of Do & Don't chart as per Indian Electricity Rules in Aluminum frame with glass	1	Nos.		0.00	0.00	INR Zero Only
11.16	Supply and Fixing of S/S Single Line Diagram in Aluminum frame with glass.	1	Nos.		0.00	0.00	INR Zero Only
11.17	Supply and Fixing of CPR (CARDIO PULMONARY RESUSCITATION) Charts.	1	Nos.		0.00	0.00	INR Zero Only
11.18	Supply and Fixing of High Voltage danger signage (Skull & bones).	2	Nos.		0.00	0.00	INR Zero Only
11.19	Supply and Fixing of Exit Route / Emergency Exit Route Signage.	2	Nos.		0.00	0.00	INR Zero Only
11.20	Supply and Fixing of First aid boxes.	1	Nos.		0.00	0.00	INR Zero Only
11.21	Supplying the following Equipment as per directions of Site Engineer / Engineer-in-Charge				0.00	0.00	INR Zero Only
11.22	RUBBER HAND GLOVES : Rubber hand gloves suitable for 11/3.3 KV operation with ISI mark.	2	SET		0.00	0.00	INR Zero Only
11.23	Supply of 11 KV Discharge Rod	1	SET		0.00	0.00	INR Zero Only
11.24	INSULATING MATS:				0.00	0.00	INR Zero Only
11.25	Supply & installation of 2000 mm X 1000 mm and of thickness as mentioned below, approved quality insulating Elastomer mats as per specifications.				0.00	0.00	INR Zero Only
11.26	Insulating Elastomer mats conforming to IS 15652:2006 of thickness 2 mm (Class A)	25	EA		0.00	0.00	INR Zero Only
11.27	Insulating Elastomer mats conforming to IS 15652:2006 of thickness 2.5 mm (Class B)	8	EA		0.00	0.00	INR Zero Only
11.28	Supply and fixing of fully charged portable CO2 fire extinguishers as per specifications (4.5 kg capacity as per IS: 2878 latest)	3	Nos.		0.00	0.00	INR Zero Only
11.29	DRY TYPE LIGHTING TRANSFORMER				0.00	0.00	INR Zero Only

Validate

Print

Help

Item Rate BoQ

Tender Inviting Authority: Projects & Development India Limited, Noida

Name of Work: TENDER FOR SUPPLY CUM ERECTION OF ELECTRICAL & INSTRUMENTATION WORKS ON ITEM RATE BASIS AT TALCHER FERTILIZERS LTD., ANGUL, ODISHA

Contract No: PNPM/PC-183/E/8003/NCB

NOTE : Quantities mentioned in the Schedule of Rates are indicative and not exhaustive in nature. Payment shall be made as per actual quantity used/certified at site by Owner's Engineer-in-charge. Quantities indicated in Schedule of Rates are approximate and subject to variation on either side. The quantity of individual item may be deleted. Contractor shall not be entitled for any compensation on this account and the quoted rates shall hold good for such quantity variations etc. Payments on bills shall, however, be made on actual measurements of quantities of work done as per approved drawings. Goods & Services Tax (GST) is applicable @ 18% on the quoted rates (being Works Contract)

Name of the Bidder/ Bidding Firm / Company :							
SCHEDULE OF RATE (Rev. 0) (This BOQ template must not be modified/replaced by the bidder and the same should be uploaded after filling the relevant columns, else the bidder is liable to be rejected for this tender. Bidders are allowed to enter the Bidder Name and Values only)							
NUMBER #	TEXT #	NUMBER #	TEXT #	NUMBER #	NUMBER #	NUMBER #	TEXT #
Sl. No.	Item Description	Quantity	Units	BASIC RATE In Figures To be entered by the Bidder in Rs. P	TOTAL AMOUNT Incl. All taxes & duties (Excl. GST) in Rs. P	TOTAL AMOUNT Incl. All taxes , duties and GST in Rs. P	TOTAL AMOUNT Incl. All taxes, duties and GST In Words
11.30	Supply, storage at site, Transportation from store to site of installation, Handling, Installation, Testing and Commissioning of Dry Type Lighting Transformers including power and control cable termination, fabrication of base foundation, placing in fabrication of base foundation channel, position on MS base channel/flat, assembly of all accessories, supply & fixing of required no. & size of double compression nickelplated brass/rolled Al cable glands & suitable lugs (Aluminium/copper/Bi metallic), connection and termination of all power and control cables all labour and material complete as per drawings/specification and direction of the lighting transformer manufacturer with all accessories, as specified in Technical Specification PC183-TS-0829				0.00	0.00	INR Zero Only
11.31	300 KVA, 415/433 V	2	Nos.		0.00	0.00	INR Zero Only
11.32	60 KVA, 415/433 V	2	Nos.		0.00	0.00	INR Zero Only
11.33	11 kV PANEL : Supply, Handling, Installation, Testing and Commissioning of Incoming cum Outgoing 11kV 3Ph 50Hz 31.5kA 1250 A VCB Panel complete with metering and protection system free standing floor mounting cubical type as per SLD & Specification Sheet and Technical specification - Electrical System (Doc No. PC183-TS-0805) and SLD No. PC183-7411-0985E including transportation from owner's stores, dressing of foundation, placing in position on MS base channel/flat, assembly of all accessories supplied loose, all labour and material complete as per drawings/specification and direction of the manufacturer.	2	Nos.		0.00	0.00	INR Zero Only
12.00	SECTION A : INSTRUMENT WORKS (SUPPLY)				0.00	0.00	INR Zero Only
12.11	CCTV for OSBL facilities and Surveillance Purpose of TFL Fertilizer complex : Design , Engineering & Supply				0.00	0.00	INR Zero Only

Item Rate BoQ

Tender Inviting Authority: Projects & Development India Limited, Noida

Name of Work: TENDER FOR SUPPLY CUM ERECTION OF ELECTRICAL & INSTRUMENTATION WORKS ON ITEM RATE BASIS AT TALCHER FERTILIZERS LTD., ANGUL, ODISHA

Contract No: PNPM/PC-183/E/8003/NCB

NOTE : Quantities mentioned in the Schedule of Rates are indicative and not exhaustive in nature. Payment shall be made as per actual quantity used/certified at site by Owner's Engineer-in-charge. Quantities indicated in Schedule of Rates are approximate and subject to variation on either side. The quantity of individual item may be deleted. Contractor shall not be entitled for any compensation on this account and the quoted rates shall hold good for such quantity variations etc. Payments on bills shall, however, be made on actual measurements of quantities of work done as per approved drawings. Goods & Services Tax (GST) is applicable @ 18% on the quoted rates (being Works Contract)

Name of the Bidder/ Bidding Firm / Company :

SCHEDULE OF RATE (Rev. 0) (This BOQ template must not be modified/replaced by the bidder and the same should be uploaded after filling the relevant columns, else the bidder is liable to be rejected for this tender. Bidders are allowed to enter the Bidder Name and Values only)

NUMBER #	TEXT #	NUMBER #	TEXT #	NUMBER #	NUMBER #	NUMBER #	TEXT #
Sl. No.	Item Description	Quantity	Units	BASIC RATE In Figures To be entered by the Bidder in Rs. P	TOTAL AMOUNT Incl. All taxes & duties (Excl. GST) in Rs. P	TOTAL AMOUNT Incl. All taxes , duties and GST in Rs. P	TOTAL AMOUNT Incl. All taxes, duties and GST In Words
12.12	CCTV Complete system for whole fertiliser complex as per attached specification - Bidder shall engineering , supply, install, test and commissioning the ONVIF-IP based Closed circuit television (CCTV) Surveillance System, Complete CCTV System with all accessories like Cameras, power supply , JB , LIU, media convertor, OFC convertor, 22" LED workstation , server, VMS ,NAS for 365 days storage , one LED 72" ceiling mounted with 100 windows , software , license , surveillance software , analytical software , all cables, all mounting accessories , poles , civil works etc. (A) at the TFL fertilizer complex . The purpose of the CCTV System is to monitor the facility operations & security surveillance from control room / Security room & Admin building to keep eye on facility covering Main gate entry /exit ,material gate exit / entry and other area of importance to the daily running of the complex by installing cameras to monitor resulting to enhancement in the Operational & Safety needs. It is intended to install CCTV system to track the Material movement, Recognition of persons and objects including vehicles through high quality images in and outside the plant by Security. The recording of the scene can be used in investigation, recreating the scene and establishing the truth.	1	LOT		0.00	0.00	INR Zero Only
12.13	Fixed Perimeter 1080p HD IP outdoor Cameras IP66 housing with Day/night fixed camera with advanced video analytics, Min 75 Mtrs IR range , Camera with 1/3" or better CMOS , 1920 (H) X 1080 (V); 2 MP or better , Inbuilt Min 128 GB or higher GB SD Card Storage for local recording etc. as per attached specification	60	NOS		0.00	0.00	INR Zero Only
12.14	1080p HD IP Indoor / outdoor PTZ Cameras with 1/3" or better progressive scan Exmor CMOS , 1920 (H) X 1080 (V); 2 MP or better, 30 X optical Zoom (4.3 mm -129 mm) , 4X Digital Zoom,	9	NOS		0.00	0.00	INR Zero Only
12.15	Supply of Intelligent video operation, control, management, recording, processing software & Advanced Analytical Software for Perimeter Surveillance as per specifications and instructions of Engineer-in-charge	1	LOT		0.00	0.00	INR Zero Only

Item Rate BoQ

Tender Inviting Authority: Projects & Development India Limited, Noida

Name of Work: TENDER FOR SUPPLY CUM ERECTION OF ELECTRICAL & INSTRUMENTATION WORKS ON ITEM RATE BASIS AT TALCHER FERTILIZERS LTD., ANGUL, ODISHA

Contract No: PNPM/PC-183/E/8003/NCB

NOTE : Quantities mentioned in the Schedule of Rates are indicative and not exhaustive in nature. Payment shall be made as per actual quantity used/certified at site by Owner's Engineer-in-charge. Quantities indicated in Schedule of Rates are approximate and subject to variation on either side. The quantity of individual item may be deleted. Contractor shall not be entitled for any compensation on this account and the quoted rates shall hold good for such quantity variations etc. Payments on bills shall, however, be made on actual measurements of quantities of work done as per approved drawings. Goods & Services Tax (GST) is applicable @ 18% on the quoted rates (being Works Contract).

Name of the Bidder/ Bidding Firm / Company :	
--	--

SCHEDULE OF RATE (Rev. 0) (This BOQ template must not be modified/replaced by the bidder and the same should be uploaded after filling the relevant columns, else the bidder is liable to be rejected for this tender. Bidders are allowed to enter the Bidder Name and Values only)

NUMBER #	TEXT #	NUMBER #	TEXT #	NUMBER #	NUMBER #	NUMBER #	TEXT #
Sl. No.	Item Description	Quantity	Units	BASIC RATE In Figures To be entered by the Bidder in Rs. P	TOTAL AMOUNT Incl. All taxes & duties (Excl. GST) in Rs. P	TOTAL AMOUNT Incl. All taxes , duties and GST in Rs. P	TOTAL AMOUNT Incl. All taxes, duties and GST In Words
12.16	Supply of all erection and installation material like Industrial grade layer ethernet Switch . OFC accessories like 12/24 port LIU, splice trays, loaded adaptor and blank plates, UTP and optical patch cords, pigtailed, FRP junction box, FRP cable trays, FRP canopy ,steel structure for installation , Octagonal pole (10/8/6 meter) power supply , media convertor, armoured power cables , communication cable ,12 core single mode steel armoured optical fibre cable etc. in all respect as per specifications and instructions of Engineer in charge. Its bidder responsibility to consider BOQ as per best engineering practice and complete in all respect to full fill tender specification mentioned elsewhere .	1	LOT		0.00	0.00	INR Zero Only
12.17	Complete EPBAX system, telephone network with telephone set , LAN Network and LAN system of Buildings of Fertiliser complex : Design ,Engineering, Supply & Interface with other exchanges including main exchange				0.00	0.00	INR Zero Only
13.00	EPBAX exchange with 200 extensions lines and all the equipment shall conform with all relevant and the latest edition of Indian, International, OISD and CCITT/ ITU standards using field proven microprocessor based design techniques for all processing and control functions. The exchange shall be based on a robust, reliable, virus protected, IP based platform for connecting IP phones, Digital phones as well as Analog extensions as specified in technical specification	1	LOT		0.00	0.00	INR Zero Only
13.11	IP Phone with built in camera & TFT LCD display for video conferencing as well as capable to connect an external IP camera	12	NOS		0.00	0.00	INR Zero Only
13.12	Standard IP Phone with TFT LCD display with optional expansion module	67	NOS		0.00	0.00	INR Zero Only
13.13	IP Based Basic desktop phones	128	NOS		0.00	0.00	INR Zero Only
13.14	Telephone Cables 20 pair	5000	MTR		0.00	0.00	INR Zero Only
13.15	Telephone Cables 5 pair	2500	MTR		0.00	0.00	INR Zero Only
13.16	LAN cable	3000	MTR		0.00	0.00	INR Zero Only

Item Rate BoQ

Tender Inviting Authority: Projects & Development India Limited, Noida

Name of Work: TENDER FOR SUPPLY CUM ERECTION OF ELECTRICAL & INSTRUMENTATION WORKS ON ITEM RATE BASIS AT TALCHER FERTILIZERS LTD., ANGUL, ODISHA

Contract No: PNPM/PC-183/E/8003/NCB

NOTE : Quantities mentioned in the Schedule of Rates are indicative and not exhaustive in nature. Payment shall be made as per actual quantity used/certified at site by Owner's Engineer-in-charge. Quantities indicated in Schedule of Rates are approximate and subject to variation on either side. The quantity of individual item may be deleted. Contractor shall not be entitled for any compensation on this account and the quoted rates shall hold good for such quantity variations etc. Payments on bills shall, however, be made on actual measurements of quantities of work done as per approved drawings. Goods & Services Tax (GST) is applicable @ 18% on the quoted rates (being Works Contract).

Name of the Bidder/ Bidding Firm / Company :	
--	--

SCHEDULE OF RATE (Rev. 0) (This BOQ template must not be modified/replaced by the bidder and the same should be uploaded after filling the relevant columns, else the bidder is liable to be rejected for this tender. Bidders are allowed to enter the Bidder Name and Values only)

NUMBER #	TEXT #	NUMBER #	TEXT #	NUMBER #	NUMBER #	NUMBER #	TEXT #
Sl. No.	Item Description	Quantity	Units	BASIC RATE In Figures To be entered by the Bidder in Rs. P	TOTAL AMOUNT Incl. All taxes & duties (Excl. GST) in Rs. P	TOTAL AMOUNT Incl. All taxes , duties and GST in Rs. P	TOTAL AMOUNT Incl. All taxes, duties and GST In Words
14.00	SUPPLY of impulse piping inclusive of pipe fittings, flanges , gasket , nut & bolts, Tube & tube fittings, Instrument valves, condensate pot,Syphon , Gauge valve , Gauge saver , Snubber etc. as per attached Hook-Ups drawing.				0.00	0.00	INR Zero Only
14.11	2480-MALE CONNECTOR , 3/4"NPTM x 1/2" OD, A182 F316	60	Nos		0.00	0.00	INR Zero Only
14.12	2464-MALE CONNECTOR , 1/2" NPTM x 1/2" OD, A182 F316	60	Nos		0.00	0.00	INR Zero Only
14.13	2467-MALE CONNECTOR , 1/2"NPTM X 1/4" OD, A182 F316	60	Nos		0.00	0.00	INR Zero Only
14.14	2466-MALE CONNECTOR , 1/4" NPTM X 1/4" OD, A182 F316	60	Nos		0.00	0.00	INR Zero Only
14.15	2473-FEMALE CONNECTOR , 1/2" NPTF X 1/2" OD, A182 F316	60	Nos		0.00	0.00	INR Zero Only
14.16	2563-LOCK NUT WITH PLUG , 1/2" OD,6000#, A182 F316	60	Nos		0.00	0.00	INR Zero Only
14.17	2506-STRAIGHT CONNECTOR , 1/2"OD x 1/2"OD, A182 F316	60	Nos		0.00	0.00	INR Zero Only
14.18	2501-STRAIGHT CONNECTOR, 1/4" OD X 1/4" OD, A182 F316	60	Nos		0.00	0.00	INR Zero Only
14.19	2460-SEAMLESS TUBE , 1/2" x 0.065" THK, A182 F316	240	Nos		0.00	0.00	INR Zero Only
14.20	2457-SEAMLESS TUBE , 1/2" OD X 1MM THK, A269 TP316	240	Nos		0.00	0.00	INR Zero Only
14.21	2446-SEAMLESS TUBE , 1/4" OD X 1MM THK, A269 TP316	240	Nos		0.00	0.00	INR Zero Only
14.22	2266-GLOBE VALVE , 1/2" NPTFx1/2" NPTF, 6000#, A182 F316	60	Nos		0.00	0.00	INR Zero Only
14.23	2515-UNION TEE , 1/2" x 1/2" x 1/2" OD, A182 F316	60	Nos		0.00	0.00	INR Zero Only
15.00	SUPPLY MATERIAL FOR STRUCTRAL WORK & FEBRICATION FOR INSTRUMENT ITEMS LIKE TRAY SUPPORT, MOUNTING FRAMES FOR INSTRUMENTS, BASE FRAMES,CANOPY FOR JB , CANOPY FOR INSTRUMENT, ANY OTHER REQUIRED FOR SUPPORTING INSTRUMENT ITEMS ALONGWITH CANOPY				0.00	0.00	INR Zero Only
15.11	50 x 50 x 6THK ANGLE MS	7000	kg		0.00	0.00	INR Zero Only
15.12	100 x 50 x 6THK CHANNEL MS	22000	kg		0.00	0.00	INR Zero Only

Item Rate BoQ

Tender Inviting Authority: Projects & Development India Limited, Noida

Name of Work: TENDER FOR SUPPLY CUM ERECTION OF ELECTRICAL & INSTRUMENTATION WORKS ON ITEM RATE BASIS AT TALCHER FERTILIZERS LTD., ANGUL, ODISHA

Contract No: PNP/PC-183/E/8003/NCB

NOTE : Quantities mentioned in the Schedule of Rates are indicative and not exhaustive in nature. Payment shall be made as per actual quantity used/certified at site by Owner's Engineer-in-charge. Quantities indicated in Schedule of Rates are approximate and subject to variation on either side. The quantity of individual item may be deleted. Contractor shall not be entitled for any compensation on this account and the quoted rates shall hold good for such quantity variations etc. Payments on bills shall, however, be made on actual measurements of quantities of work done as per approved drawings. Goods & Services Tax (GST) is applicable @ 18% on the quoted rates (being Works Contract)

Name of the Bidder/ Bidding Firm / Company :	
--	--

SCHEDULE OF RATE (Rev. 0) (This BOQ template must not be modified/replaced by the bidder and the same should be uploaded after filling the relevant columns, else the bidder is liable to be rejected for this tender. Bidders are allowed to enter the Bidder Name and Values only)

NUMBER #	TEXT #	NUMBER #	TEXT #	NUMBER #	NUMBER #	NUMBER #	TEXT #
Sl. No.	Item Description	Quantity	Units	BASIC RATE In Figures To be entered by the Bidder in Rs. P	TOTAL AMOUNT Incl. All taxes & duties (Excl. GST) in Rs. P	TOTAL AMOUNT Incl. All taxes , duties and GST in Rs. P	TOTAL AMOUNT Incl. All taxes, duties and GST In Words
15.15	RIBS (PLATE) 250 X 250 X 6 THK MS PLATE	1700	kg		0.00	0.00	INR Zero Only
15.16	BASE PLATE 250 X 250 X 6 THK MS PLATE	1700	kg		0.00	0.00	INR Zero Only
15.17	2" MS PIPE FOR STAND PIPE, MEDIUM, AS PER IS:1239	360	Mtr		0.00	0.00	INR Zero Only
16.00	SUPPLY OF FRP JUNCTION BOX , CABLE GLANDS , PLUG AS PER TECHNICAL SPECIFICATION AND AS MENTIONED IN TENDER ELSEWHERE				0.00	0.00	INR Zero Only
16.11	Junction Box, Please refer attached spec sheet for details	12	Nos		0.00	0.00	INR Zero Only
16.12	Cable Glands, M20 SS316 Cable Gland Double Compression Exd suitable for Cable OD "14.5+/- 2mm" with locknut & PVC Hoods(All JB's shall be plugged with SS Plug)	169	Nos		0.00	0.00	INR Zero Only
16.13	Cable Glands, M32 SS316 Cable Gland Double Compression Exd suitable for Cable OD "28.8+/- 2mm" with locknut & PVC Hoods (Both end JB & Control Room) (All JB's shall be plugged with SS Plug)	120	Nos		0.00	0.00	INR Zero Only
16.14	Cable Glands, M32 SS316 Cable Gland Double Compression Exd suitable for Cable OD "28.8+/- 2mm" with locknut & PVC Hoods (LCP & Control Room) (All JB's shall be plugged with SS Plug (By Default)	34	Nos		0.00	0.00	INR Zero Only
16.15	Cable Glands, M32 SS316 Cable Gland Double Compression Exd suitable for Cable OD "28.8+/- 2mm" with locknut & PVC Hoods (MCC & Control Room) ((All JB's shall be plugged with SS Plug (By Default)	72	Nos		0.00	0.00	INR Zero Only
17.00	SUPPLY of FRP PERFORATED CABLE TRAY with cover and SS installation accessories including joining, cutting, bendind, supporting etc. (Pls refer annex for details)				0.00	0.00	INR Zero Only
17.11	FRP CableTray (Perforated) with flat Cover , 2500 x 600 x 150 mm,4mm thk	4080	Mtr		0.00	0.00	INR Zero Only
17.12	FRP CableTray (Perforated) with Cover, 2500 x 300 x 55 mm,4mm thk	600	Mtr		0.00	0.00	INR Zero Only

Validate

Print

Help

Item Rate BoQ

Tender Inviting Authority: Projects & Development India Limited, Noida

Name of Work: TENDER FOR SUPPLY CUM ERECTION OF ELECTRICAL & INSTRUMENTATION WORKS ON ITEM RATE BASIS AT TALCHER FERTILIZERS LTD., ANGUL, ODISHA

Contract No: PNPM/PC-183/E/8003/NCB

NOTE : Quantities mentioned in the Schedule of Rates are indicative and not exhaustive in nature. Payment shall be made as per actual quantity used/certified at site by Owner's Engineer-in-charge. Quantities indicated in Schedule of Rates are approximate and subject to variation on either side. The quantity of individual item may be deleted. Contractor shall not be entitled for any compensation on this account and the quoted rates shall hold good for such quantity variations etc. Payments on bills shall, however, be made on actual measurements of quantities of work done as per approved drawings. Goods & Services Tax (GST) is applicable @ 18% on the quoted rates (being Works Contract).

Name of the Bidder/ Bidding Firm / Company :	
--	--

SCHEDULE OF RATE (Rev. 0) (This BOQ template must not be modified/replaced by the bidder and the same should be uploaded after filling the relevant columns, else the bidder is liable to be rejected for this tender. Bidders are allowed to enter the Bidder Name and Values only)

NUMBER #	TEXT #	NUMBER #	TEXT #	NUMBER #	NUMBER #	NUMBER #	TEXT #
Sl. No.	Item Description	Quantity	Units	BASIC RATE In Figures To be entered by the Bidder in Rs. P	TOTAL AMOUNT Incl. All taxes & duties (Excl. GST) in Rs. P	TOTAL AMOUNT Incl. All taxes , duties and GST in Rs. P	TOTAL AMOUNT Incl. All taxes, duties and GST In Words
17.14	FRP CableTray (Perforated), 2500 x 100 x 55 mm.4mm thk	600	Mtr		0.00	0.00	INR Zero Only
17.15	FRP CableTray (Perforated), 2500 x 50 x 55 mm.4mm thk	1200	Mtr		0.00	0.00	INR Zero Only
17.16	FRPInside 90 Deg Vertical Bend with Cover (for 600mm ladder), 600 mm (Bending Radius 600mm)	28.8	Nos		0.00	0.00	INR Zero Only
17.17	FRP Outside 90 Deg Vertical Bend with Cover (for 600mm), 600 mm(Bending Radius 600mm)	28.8	Nos		0.00	0.00	INR Zero Only
17.18	FRPHorizontal 90 Deg Bend with cover (for 600mm), 600 mm(Bending Radius 600mm)	12	Nos		0.00	0.00	INR Zero Only
17.19	FRP Horizontal TEE ladder fitting with Cover (for 600mm), 600 mm(Bending Radius 600mm)	12	Nos		0.00	0.00	INR Zero Only
17.20	FRP Horizontal Cross fitting with Cover (for 600mm), 600 mm(Bending Radius 600mm)	1.2	Nos		0.00	0.00	INR Zero Only
17.21	Reducer 600 to 300,	1.2	Nos		0.00	0.00	INR Zero Only
17.22	All SS mounting & installation material and other items to complete above cable tray laying ,	1	Lot		0.00	0.00	INR Zero Only
17.23	Canopy & Accessories (Complete Canopy to cover instrument items properly), Pls refer Attached Spec Sheet	120	Nos		0.00	0.00	INR Zero Only
18.00	Supply of Instrumentation cable, Signal & Control, Power cable,OFC and T/c extension Cables data sheets/technical specification cover requirement for design, engineering, manufacturing, assembly, and supply, documentation, testing at manufacture's works, packing and shipping of the Signal & Control, Power cable and T/c extension Cables				0.00	0.00	INR Zero Only
18.11	12P x 1.5 SQMM	41280	Mtr		0.00	0.00	INR Zero Only
18.12	01P x 1.5 SQMM	1000	Mtr		0.00	0.00	INR Zero Only
18.13	06P x 1.5 SQMM	1000	Mtr		0.00	0.00	INR Zero Only
18.14	08T x 1.5 SQMM	1000	Mtr		0.00	0.00	INR Zero Only
18.15	01T x 1.5 SQMM	1000	Mtr		0.00	0.00	INR Zero Only
18.16	01P X 16 AWG	1000	Mtr		0.00	0.00	INR Zero Only
18.17	03C X 2.5 SQMM	1000	Mtr		0.00	0.00	INR Zero Only

Item Rate BoQ

Tender Inviting Authority: Projects & Development India Limited, Noida

Name of Work: TENDER FOR SUPPLY CUM ERECTION OF ELECTRICAL & INSTRUMENTATION WORKS ON ITEM RATE BASIS AT TALCHER FERTILIZERS LTD., ANGUL, ODISHA

Contract No: PNPM/PC-183/E/8003/NCB

NOTE : Quantities mentioned in the Schedule of Rates are indicative and not exhaustive in nature. Payment shall be made as per actual quantity used/certified at site by Owner's Engineer-in-charge. Quantities indicated in Schedule of Rates are approximate and subject to variation on either side. The quantity of individual item may be deleted. Contractor shall not be entitled for any compensation on this account and the quoted rates shall hold good for such quantity variations etc. Payments on bills shall, however, be made on actual measurements of quantities of work done as per approved drawings. Goods & Services Tax (GST) is applicable @ 18% on the quoted rates (being Works Contract)

Name of the Bidder/ Bidding Firm / Company :

SCHEDULE OF RATE (Rev. 0) (This BOQ template must not be modified/replaced by the bidder and the same should be uploaded after filling the relevant columns, else the bidder is liable to be rejected for this tender. Bidders are allowed to enter the Bidder Name and Values only)

NUMBER #	TEXT #	NUMBER #	TEXT #	NUMBER #	NUMBER #	NUMBER #	TEXT #
Sl. No.	Item Description	Quantity	Units	BASIC RATE In Figures To be entered by the Bidder in Rs. P	TOTAL AMOUNT Incl. All taxes & duties (Excl. GST) in Rs. P	TOTAL AMOUNT Incl. All taxes , duties and GST in Rs. P	TOTAL AMOUNT Incl. All taxes, duties and GST In Words
18.20	1C x 10 SQMM, Tinned Cu conductors min 10 sq.mm, Green outer sheath	240	Mtr		0.00	0.00	INR Zero Only
18.21	SUPPLY of AIR DISTRIBUTION POT SS304				0.00	0.00	INR Zero Only
18.22	ADP - 10 TAKE OFFS	6	Nos.		0.00	0.00	INR Zero Only
19.00	SUPPLY of GPS MASTER CLOCK WITH ANNTENA AND ALL OTHER ASSESSORIES FOR COMPLETE UNIT				0.00	0.00	INR Zero Only
19.11	GPS Master(redundant Configuration), SERTEL make(antenna with asociated Electronics) & NTP client softwre with complete system , AS PER ANNEX	1	Nos		0.00	0.00	INR Zero Only
19.12	Interfacing Cable	100	Mtr		0.00	0.00	INR Zero Only
19.13	Supply of instruments with all mounting accessories and license /software including Third Party Inspection				0.00	0.00	INR Zero Only
19.14	Supply of Pressure Gauge (PG) as per the technical specifications attached in the Tender. . 0 - 10 kg/cm2	4	Nos		0.00	0.00	INR Zero Only
19.15	Supply of Pressure Gauge (PG) as per the technical specifications attached in the Tender. . 0 - 20 kg/cm2	4	Nos		0.00	0.00	INR Zero Only
19.16	Pressure Transmitters with 2 way manifolds and Cable glands ; Smart type; accuracy 0.05% or better Installation: 2" Pipe Mounted including spares as Per Detailed Spec., 0-1 KG/CM2	6	Nos		0.00	0.00	INR Zero Only
19.17	Pressure Transmitters with 2 way manifolds and Cable glands , Smart type; accuracy 0.05% or better Installation: 2" Pipe Mounted including spares as Per Detailed Spec., 0-10 KG/CM2	6	Nos		0.00	0.00	INR Zero Only
19.18	Pressure Transmitters with 2 way manifolds and Cable glands, Smart type; accuracy 0.05% or better Installation: 2" Pipe Mounted including spares as Per Detailed Spec., 0-50 KG/CM2	7	Nos		0.00	0.00	INR Zero Only
19.19	Pressure Transmitters with 2 way manifolds and Cable glands , Smart type; accuracy 0.05% or better Installation: 2" Pipe Mounted including spares as Per Detailed Spec., 0-250 KG/CM2	6	Nos		0.00	0.00	INR Zero Only
	Differential Pressure Transmitter with 3 way manifold valves and Cable Glands Smart type; accuracy 0.050%						

Validate

Print

Help

Item Rate BoQ

Tender Inviting Authority: Projects & Development India Limited, Noida

Name of Work: TENDER FOR SUPPLY CUM ERECTION OF ELECTRICAL & INSTRUMENTATION WORKS ON ITEM RATE BASIS AT TALCHER FERTILIZERS LTD., ANGUL, ODISHA

Contract No: PNPM/PC-183/E/8003/NCB

NOTE : Quantities mentioned in the Schedule of Rates are indicative and not exhaustive in nature. Payment shall be made as per actual quantity used/certified at site by Owner's Engineer-in-charge. Quantities indicated in Schedule of Rates are approximate and subject to variation on either side. The quantity of individual item may be deleted. Contractor shall not be entitled for any compensation on this account and the quoted rates shall hold good for such quantity variations etc. Payments on bills shall, however, be made on actual measurements of quantities of work done as per approved drawings. Goods & Services Tax (GST) is applicable @ 18% on the quoted rates (being Works Contract).

Name of the Bidder/ Bidding Firm / Company :							
SCHEDULE OF RATE (Rev. 0) (This BOQ template must not be modified/replaced by the bidder and the same should be uploaded after filling the relevant columns, else the bidder is liable to be rejected for this tender. Bidders are allowed to enter the Bidder Name and Values only)							
NUMBER #	TEXT #	NUMBER #	TEXT #	NUMBER #	NUMBER #	NUMBER #	TEXT #
Sl. No.	Item Description	Quantity	Units	BASIC RATE In Figures To be entered by the Bidder in Rs. P	TOTAL AMOUNT Incl. All taxes & duties (Excl. GST) in Rs. P	TOTAL AMOUNT Incl. All taxes , duties and GST in Rs. P	TOTAL AMOUNT Incl. All taxes, duties and GST In Words
19.21	Differential Pressure Transmitter with 3 way manifold valves and Cable Glands,Smart type; accuracy 0.050% or better including spares as Per Detailed Spec., 0-2500MMH2O	5	Nos		0.00	0.00	INR Zero Only
19.22	Differential Pressure Transmitter with 3 way manifold valves and Cable Glands,Smart type; accuracy 0.050% or better including spares as Per Detailed Spec., 0-1200 MMH2O	6	Nos		0.00	0.00	INR Zero Only
19.23	Differential Pressure Transmitter with 3 way manifold valves and Cable Glands,Smart type; accuracy 0.050% or better including spares as Per Detailed Spec., 0-2000 MMH2O	6	Nos		0.00	0.00	INR Zero Only
19.24	FE-101,Flow Orifice , tappings 1set +1 set spare , flange Size ,rating & matl. 8" 300#RF, A105, plate material SS 316 ,2 Nos Gasket as Spare as per detailed Spec., 0-300 m3/hr	2	Nos		0.00	0.00	INR Zero Only
19.25	FE-102,Flow Orifice , tappings 1set +1 set spare , flange Size ,rating & matl. 8" 300#RF, A105, plate material SS 316 ,2 Nos Gasket as Spare as per detailed Spec., 0-300 m3/hr	2	Nos		0.00	0.00	INR Zero Only
19.26	FE-001,Flow Orifice , tappings 1set +1 set spare , flange Size ,rating & matl. 3" 300#RF, A105, plate material SS 316 ,2 Nos Gasket as Spare as per detailed Spec., 0-300 m3/hr	2	Nos		0.00	0.00	INR Zero Only
19.27	PCV-01 Spring loaded Self actuating pressure regulating globe valve for 3" ,150# RF line with its seat ,plug material SS316+Stellited,along with gasket ,spring set and packing seat as pares.	3	Nos		0.00	0.00	INR Zero Only
20.00	SECTION B 1 - INSTRUMENT WORKS (ERECTION/INSTALLATION OF INSTRUMENTS AS PER ATTACHED HOOK-UP DRAWING,INSTALLATION DRAWING. CABLE LAYING AND CABLE TRAY LAYING, INSTALLATION OF JUNCTION BOX , LOCAL CONTROL PANEL, SIGNAL TERMINATION GLANDING FOR ELECTROHYDRAULIC CONTROL VALVES ETC. , LOOP CHECKING , TESTING OF TRANSMITTERS /INSTRUMENTS ETC AS BELOW				0.00	0.00	INR Zero Only

Item Rate BoQ

Tender Inviting Authority: Projects & Development India Limited, Noida

Name of Work: TENDER FOR SUPPLY CUM ERECTION OF ELECTRICAL & INSTRUMENTATION WORKS ON ITEM RATE BASIS AT TALCHER FERTILIZERS LTD., ANGUL, ODISHA

Contract No: PNPM/PC-183/E/8003/NCB

NOTE : Quantities mentioned in the Schedule of Rates are indicative and not exhaustive in nature. Payment shall be made as per actual quantity used/certified at site by Owner's Engineer-in-charge. Quantities indicated in Schedule of Rates are approximate and subject to variation on either side. The quantity of individual item may be deleted. Contractor shall not be entitled for any compensation on this account and the quoted rates shall hold good for such quantity variations etc. Payments on bills shall, however, be made on actual measurements of quantities of work done as per approved drawings. Goods & Services Tax (GST) is applicable @ 18% on the quoted rates (being Works Contract)

Name of the Bidder/ Bidding Firm / Company :	
--	--

SCHEDULE OF RATE (Rev. 0) (This BOQ template must not be modified/replaced by the bidder and the same should be uploaded after filling the relevant columns, else the bidder is liable to be rejected for this tender. Bidders are allowed to enter the Bidder Name and Values only)

NUMBER #	TEXT #	NUMBER #	TEXT #	NUMBER #	NUMBER #	NUMBER #	TEXT #
Sl. No.	Item Description	Quantity	Units	BASIC RATE In Figures To be entered by the Bidder in Rs. P	TOTAL AMOUNT Incl. All taxes & duties (Excl. GST) in Rs. P	TOTAL AMOUNT Incl. All taxes , duties and GST in Rs. P	TOTAL AMOUNT Incl. All taxes, duties and GST In Words
20.11	<p>BRIEF SCOPE OF INST WORK AND SERVICES BUT NOT TO LIMITED</p> <p>1) The BIDDER shall be responsible for the calibration & testing, installation, glanding , termination, commissioning of the complete instrumentation and controls as defined in this Tender.</p> <p>In general, the scope of work and services of the BIDDER shall include the but not limited to;</p> <p>a). Taking delivery from the warehouse or from the places of storage OR BIDDER's allotted yard , transportation, handling, storage, unpacking, assorting physical checking and testing of instruments, panels / cabinets, instrument accessories cables, junction boxes, cable glands, cable trays ducts and erection materials etc.</p> <p>b).Scope includes raising of store requisitions to OWNER/PDIL(if required) on prescribed formats for issue of free-issue-materials (FIMs)if any and maintaining record of the material issued at its site office. All works including Field fabrication / erection shall be done strictly in accordance with OWNER/PDIL specifications and standards.</p> <p>c).Scope includes return of Leftover free issue material to OWNER/PDIL with suitable return notes.</p> <p>d).BIDDER shall supply all required tools, tacksels, equipment, skilled & unskilled manpower, managerial staff, consumables & whatever else may be necessary for competing the job within the project schedule.</p> <p>e) If it is necessary to maintain the project schedule, BIDDER shall extend the working hours, working days & whatever else may be necessary for maintaining the project schedule without any cost & time implication to purchaser/end user.</p> <p>f). BIDDER will be responsible for the protection & maintenance (both at BIDDER's stores and/or in the field) of instruments & accessories issued to him. Supply of the materials necessary for the said protection and/or maintenance is in BIDDER's scope.</p> <p>g).BIDDER shall inform site incharge for any material damaged and/or missing during erection. if it is proved that said material is damaged and/or missing by the BIDDER, the cost of the same shall charged to him.</p> <p>h) Transportation of unserviceable Instrument Scrap as defined in this tender.</p>				0.00	0.00	INR Zero Only

[Validate](#)[Print](#)[Help](#)**Item Rate BoQ**

Tender Inviting Authority: Projects & Development India Limited, Noida

Name of Work: TENDER FOR SUPPLY CUM ERECTION OF ELECTRICAL & INSTRUMENTATION WORKS ON ITEM RATE BASIS AT TALCHER FERTILIZERS LTD., ANGUL, ODISHA

Contract No: PNP/PC-183/E/8003/NCB

NOTE : Quantities mentioned in the Schedule of Rates are indicative and not exhaustive in nature. Payment shall be made as per actual quantity used/certified at site by Owner's Engineer-in-charge. Quantities indicated in Schedule of Rates are approximate and subject to variation on either side. The quantity of individual item may be deleted. Contractor shall not be entitled for any compensation on this account and the quoted rates shall hold good for such quantity variations etc. Payments on bills shall, however, be made on actual measurements of quantities of work done as per approved drawings. Goods & Services Tax (GST) is applicable @ 18% on the quoted rates (being Works Contract).

Name of the Bidder/ Bidding Firm / Company :	
---	--

SCHEDULE OF RATE (Rev. 0) (This BOQ template must not be modified/replaced by the bidder and the same should be uploaded after filling the relevant columns, else the bidder is liable to be rejected for this tender. Bidders are allowed to enter the Bidder Name and Values only)

NUMBER #	TEXT #	NUMBER #	TEXT #	NUMBER #	NUMBER #	NUMBER #	TEXT #
Sl. No.	Item Description	Quantity	Units	BASIC RATE In Figures To be entered by the Bidder in Rs. P	TOTAL AMOUNT Incl. All taxes & duties (Excl. GST) in Rs. P	TOTAL AMOUNT Incl. All taxes , duties and GST in Rs. P	TOTAL AMOUNT Incl. All taxes, duties and GST In Words
20.12	2) LETTER WRITING : LETTER WRITING FOR ALPHA-NUMERIC TAGGING (WITH SYNTHETIC ENAMEL). :- Letter writing of different sizes on Instrument Panels/misc. Instruments/ Equipments with synthetic enamel paints (Asian/ Jonson & Nicolson/ Berger /Nerolac Make) suitable for a temp. of 100 degree Celsius for writing of letters, figures etc. Job includes cleaning of surface on panels/instruments/misc. instruments etc. All complete with labour and materials as per drawings, specifications, Name plate schedule and directions of Engineer-in-Charge. (Supply of paints is in BIDDER scope). 3) PAINTING :- SPRAY PAINTING (PAINT IS IN BIDDER'S SCOPE) :- Cleaning of surface, rust, removing of foreign matter, rubbing down thoroughly with emery paper, wire brush, washing with degreasing solvent (white spirit) to remove grease etc. and preparation of surface for application of enamel paint by spray painting on instrumentation panels/instruments or any other metallic surface with one coat of ready mixed primer and two coats of approved quality/ apcolite Asian synthetic enamel paint including supply of paint suitable for a temp. of 100 degree C. All complete with labour and materials as per drawings, specifications and directions of Engineer-in-Charge. 4) bidder has to make necessary arrangements for cable entry to control room all the civil, welding works , consumables, tools & tackles , manpower etc shall be in bidders scope.no separate rate shall be allowed.				0.00	0.00	INR Zero Only
21.00	Erection/installation of electronic transmitter including unpacking, pre checking, calibration, termination, loop checking & commissioning. : [Erection material shall be supplied by BIDDER]. As installation drawing.				0.00	0.00	INR Zero Only

Validate

Print

Help

Item Rate BoQ

Tender Inviting Authority: Projects & Development India Limited, Noida

Name of Work: TENDER FOR SUPPLY CUM ERECTION OF ELECTRICAL & INSTRUMENTATION WORKS ON ITEM RATE BASIS AT TALCHER FERTILIZERS LTD., ANGUL, ODISHA

Contract No: PNPM/PC-183/E/8003/NCB

NOTE : Quantities mentioned in the Schedule of Rates are indicative and not exhaustive in nature. Payment shall be made as per actual quantity used/certified at site by Owner's Engineer-in-charge. Quantities indicated in Schedule of Rates are approximate and subject to variation on either side. The quantity of individual item may be deleted. Contractor shall not be entitled for any compensation on this account and the quoted rates shall hold good for such quantity variations etc. Payments on bills shall, however, be made on actual measurements of quantities of work done as per approved drawings. Goods & Services Tax (GST) is applicable @ 18% on the quoted rates (being Works Contract).

Name of the Bidder/ Bidding Firm / Company :	
--	--

SCHEDULE OF RATE (Rev. 0) (This BOQ template must not be modified/replaced by the bidder and the same should be uploaded after filling the relevant columns, else the bidder is liable to be rejected for this tender. Bidders are allowed to enter the Bidder Name and Values only)

NUMBER #	TEXT #	NUMBER #	TEXT #	NUMBER #	NUMBER #	NUMBER #	TEXT #
Sl. No.	Item Description	Quantity	Units	BASIC RATE In Figures To be entered by the Bidder in Rs. P	TOTAL AMOUNT Incl. All taxes & duties (Excl. GST) in Rs. P	TOTAL AMOUNT Incl. All taxes , duties and GST in Rs. P	TOTAL AMOUNT Incl. All taxes, duties and GST In Words
21.11	The job includes the following: Shifting of new instrument with its accessories from store to work site. Installation of pressure transmitters(Drilling of blind flanges of Vessels if required Shall also be in the scope of BIDDER) with its accessories. Glanding, ferruling and termination of the signal cable of the instruments wherever required, including aluminium tagging, supply of ferrule, lugs and aluminium tag is in BIDDER's scope of supply				0.00	0.00	INR Zero Only
21.12	Fabrication, installation and grouting of small supports for instrument . Laying and erection of perforated tray / angle iron for neatly laying of impulse line of the instrument.				0.00	0.00	INR Zero Only
21.13	All above jobs are inclusive of supply of all sorts of erection materials (including clamps, nuts bolts etc.) grouting material (cement, concrete, sand etc.) and consumables excepting the supply of Pipes, Pipe Fittings, Perforated Tray, Structural Material and Instruments. Hydraulic testing of manifold.				0.00	0.00	INR Zero Only
21.14	Painting of all erected structural items (excluding impulse line) inclusive supply of paint (Paint make shall be Asian/Berger/Nerolac).				0.00	0.00	INR Zero Only
21.15	Necessary skilled & unskilled manpower, supervision, tools & tackles, transporting vehicle, supply of all sorts of consumables shall be in BIDDER's scope. The job shall be carried out as per specification and direction of Engineer-in-charge.				0.00	0.00	INR Zero Only
21.16	Pressure Gauge erection / installation (Including drilling of blind flange where ever required, impulse piping including staem tracing, glanding, and termination, erection of Statcton & Supports Canopy etc)	10	Nos.		0.00	0.00	INR Zero Only
21.17	PressureGauger -Hydrotest, PMI, DP tests	10	Nos.		0.00	0.00	INR Zero Only
21.18	Pressure Gauge functional check, loop checking	10	Nos.		0.00	0.00	INR Zero Only
21.19	Pressure Gauge calibration	10	Nos.		0.00	0.00	INR Zero Only
21.20	Pressure transmitter erection / installation (Including drilling of blind flange where ever required, impulse piping including staem tracing, glanding, and termination, erection of Statcton & Supports Canopy etc)	35	Nos.		0.00	0.00	INR Zero Only

Validate

Print

Help

Item Rate BoQ

Tender Inviting Authority: Projects & Development India Limited, Noida

Name of Work: TENDER FOR SUPPLY CUM ERECTION OF ELECTRICAL & INSTRUMENTATION WORKS ON ITEM RATE BASIS AT TALCHER FERTILIZERS LTD., ANGUL, ODISHA

Contract No: PNPM/PC-183/E/8003/NCB

NOTE : Quantities mentioned in the Schedule of Rates are indicative and not exhaustive in nature. Payment shall be made as per actual quantity used/certified at site by Owner's Engineer-in-charge. Quantities indicated in Schedule of Rates are approximate and subject to variation on either side. The quantity of individual item may be deleted. Contractor shall not be entitled for any compensation on this account and the quoted rates shall hold good for such quantity variations etc. Payments on bills shall, however, be made on actual measurements of quantities of work done as per approved drawings. Goods & Services Tax (GST) is applicable @ 18% on the quoted rates (being Works Contract).

Name of the Bidder/ Bidding Firm / Company :	
--	--

SCHEDULE OF RATE (Rev. 0) (This BOQ template must not be modified/replaced by the bidder and the same should be uploaded after filling the relevant columns, else the bidder is liable to be rejected for this tender. Bidders are allowed to enter the Bidder Name and Values only)

NUMBER #	TEXT #	NUMBER #	TEXT #	NUMBER #	NUMBER #	NUMBER #	TEXT #
Sl. No.	Item Description	Quantity	Units	BASIC RATE In Figures To be entered by the Bidder in Rs. P	TOTAL AMOUNT Incl. All taxes & duties (Excl. GST) in Rs. P	TOTAL AMOUNT Incl. All taxes , duties and GST in Rs. P	TOTAL AMOUNT Incl. All taxes, duties and GST In Words
21.22	Pressure transmitter functional check, loop checking	35	Nos.		0.00	0.00	INR Zero Only
21.23	Pressure transmitter calibration	35	Nos.		0.00	0.00	INR Zero Only
21.24	Differential pressure transmitter (FT, PDT) Erection / installation (Including impulse piping including staem tracing, glanding, and termination, erection of Statction & Supports Canopy etc)	15	Nos.		0.00	0.00	INR Zero Only
21.25	Differential Pressure transmitter (FT, PDT) -Hydrotest, PMI, DP tests	15	Nos.		0.00	0.00	INR Zero Only
21.26	Differential pressure transmitter (FT, PDT) -Functional check, loop checking	15	Nos.		0.00	0.00	INR Zero Only
21.27	Differential pressure transmitter (FT, PDT) - Calibration	15	Nos.		0.00	0.00	INR Zero Only
21.28	Differential pressure transmitter (LT) erection / installation (Including impulse piping including staem tracing, glanding, and termination, erection of Statction & Supports Canopy etc)	10	Nos.		0.00	0.00	INR Zero Only
21.29	Differential Pressure transmitter (LT)-Hydrotest, PMI, DP tests	10	Nos.		0.00	0.00	INR Zero Only
21.30	Differential pressure transmitter (LT) functional check, loop checking	10	Nos.		0.00	0.00	INR Zero Only
21.31	Differential pressure transmitter (LT) calibration	10	Nos.		0.00	0.00	INR Zero Only
21.32	Temperature transmitter Erection / installation((Including glanding, and termination, erection of Statction & supports Canopy etc)	10	Nos.		0.00	0.00	INR Zero Only
21.33	Temperature transmitter Functional check, loop checking	10	Nos.		0.00	0.00	INR Zero Only
21.34	Temperature transmitter Calibration	10	Nos.		0.00	0.00	INR Zero Only
21.35	Installation of level transmitter of all types (LT) (except DP type)- Erection / installation (glanding, and termination, erection of Statction & Supports Canopy etc if any)	5	Nos.		0.00	0.00	INR Zero Only
21.36	Installation of level transmitter of all types (LT) (except DP type)- Functional check, loop checking	5	Nos.		0.00	0.00	INR Zero Only
21.37	Installation of level transmitter of all types (LT) (except DP type)- Calibration	5	Nos.		0.00	0.00	INR Zero Only
21.38	Level Switch (LS)- Erection / installation (glanding, and termination, erection of Statction & Supports Canopy etc if any)	5	Nos.		0.00	0.00	INR Zero Only
21.39	Level Switch (LS)- Functional check, loop checking	5	Nos.		0.00	0.00	INR Zero Only

Validate

Print

Help

Item Rate BoQ

Tender Inviting Authority: Projects & Development India Limited, Noida

Name of Work: TENDER FOR SUPPLY CUM ERECTION OF ELECTRICAL & INSTRUMENTATION WORKS ON ITEM RATE BASIS AT TALCHER FERTILIZERS LTD., ANGUL, ODISHA

Contract No: PNP/PC-183/E/8003/NCB

NOTE : Quantities mentioned in the Schedule of Rates are indicative and not exhaustive in nature. Payment shall be made as per actual quantity used/certified at site by Owner's Engineer-in-charge. Quantities indicated in Schedule of Rates are approximate and subject to variation on either side. The quantity of individual item may be deleted. Contractor shall not be entitled for any compensation on this account and the quoted rates shall hold good for such quantity variations etc. Payments on bills shall, however, be made on actual measurements of quantities of work done as per approved drawings. Goods & Services Tax (GST) is applicable @ 18% on the quoted rates (being Works Contract).

Name of the Bidder/ Bidding Firm / Company :							
SCHEDULE OF RATE (Rev. 0) (This BOQ template must not be modified/replaced by the bidder and the same should be uploaded after filling the relevant columns, else the bidder is liable to be rejected for this tender. Bidders are allowed to enter the Bidder Name and Values only)							
NUMBER #	TEXT #	NUMBER #	TEXT #	NUMBER #	NUMBER #	NUMBER #	TEXT #
Sl. No.	Item Description	Quantity	Units	BASIC RATE In Figures To be entered by the Bidder in Rs. P	TOTAL AMOUNT Incl. All taxes & duties (Excl. GST) in Rs. P	TOTAL AMOUNT Incl. All taxes , duties and GST in Rs. P	TOTAL AMOUNT Incl. All taxes, duties and GST In Words
21.41	Rotameter/all other types of flow meters except Mag flow meter -Erection / installation (glanding, and termination, erection of Statction & Supports Canopy etc if any)	5	Nos.		0.00	0.00	INR Zero Only
21.42	Rotameter/all other types of flow meters except Mag flow meter - Functional check, loop checking	5	Nos.		0.00	0.00	INR Zero Only
21.43	Rotameter/all other types of flow meters except Mag flow meter - Calibration	5	Nos.		0.00	0.00	INR Zero Only
21.44	Glanding/Termination/ferruling of instrument /switches etc already erected by package vendor (this covers skid mounted instruments/instruments already erected by vendor and provided at site)	10	Nos.		0.00	0.00	INR Zero Only
21.45	Loop Checking of Package items which are not erected by bidder(this covers skid mounted instruments/instruments already erected by vendor and provided at site)	10	Nos.		0.00	0.00	INR Zero Only
21.46	Erection / installation of pressure gauge on pipe line/ vessel/stand/ frame including small welding as per hookup diagram (preparation of gauge board if required). [as per attached hook-ups & installation drawing.]				0.00	0.00	INR Zero Only
21.47	The job includes the following: Shifting of new instrument with its accessories from store to work site ,Installation of pressure gauge / vacuum gauge / draught gauge with its accessories like snubber /gauge saver/ syphon etc.Fabrication and installation of manifold, syphon . Fabrication and installation of stanctions, canopy for instrument etc wherever necessary.				0.00	0.00	INR Zero Only
21.48	All above jobs are inclusive of supply of all sorts of erection materials (including clamps, nut bolt etc.) and consumables excepting the supply of Pipes, Pipe Fittings, Structural Material, and Instruments. providing Holes in Blind flange for veseel related tags, Hydraulic testing of manifold. impusle pipie, DP test,PMI test Painting of all erected structural items (excluding impulse line) inclusive supply of paint (Paint make shall be Asian/Berger/Nerolac). The installation shall be as per typical installation diagram.				0.00	0.00	INR Zero Only
21.49	Necessary skilled & unskilled manpower, supervision, tools & tackles, transporting vehicle, supply of all sorts of consumables shall be in BIDDER's scope. The job shall be carried out as per specification and direction of				0.00	0.00	INR Zero Only

Validate

Print

Help

Item Rate BoQ

Tender Inviting Authority: Projects & Development India Limited, Noida

Name of Work: TENDER FOR SUPPLY CUM ERECTION OF ELECTRICAL & INSTRUMENTATION WORKS ON ITEM RATE BASIS AT TALCHER FERTILIZERS LTD., ANGUL, ODISHA

Contract No: PNPM/PC-183/E/8003/NCB

NOTE : Quantities mentioned in the Schedule of Rates are indicative and not exhaustive in nature. Payment shall be made as per actual quantity used/certified at site by Owner's Engineer-in-charge. Quantities indicated in Schedule of Rates are approximate and subject to variation on either side. The quantity of individual item may be deleted. Contractor shall not be entitled for any compensation on this account and the quoted rates shall hold good for such quantity variations etc. Payments on bills shall, however, be made on actual measurements of quantities of work done as per approved drawings. Goods & Services Tax (GST) is applicable @ 18% on the quoted rates (being Works Contract)

Name of the Bidder/ Bidding Firm / Company :							
SCHEDULE OF RATE (Rev. 0) (This BOQ template must not be modified/replaced by the bidder and the same should be uploaded after filling the relevant columns, else the bidder is liable to be rejected for this tender. Bidders are allowed to enter the Bidder Name and Values only)							
NUMBER #	TEXT #	NUMBER #	TEXT #	NUMBER #	NUMBER #	NUMBER #	TEXT #
Sl. No.	Item Description	Quantity	Units	BASIC RATE In Figures To be entered by the Bidder in Rs. P	TOTAL AMOUNT Incl. All taxes & duties (Excl. GST) in Rs. P	TOTAL AMOUNT Incl. All taxes , duties and GST in Rs. P	TOTAL AMOUNT Incl. All taxes, duties and GST In Words
21.50	All types Pressure gauge erection / installation (includes impulse piping and necessary support fabrication & installation)	15	NOS.		0.00	0.00	INR Zero Only
21.51	All types Pressure gauge calibration	15	NOS.		0.00	0.00	INR Zero Only
21.52	The job includes the following: Receiving & shifting of Temperature instrument with Thermowell with its accessories from store/any other place inside OWNER campus & transport to work site.Fixing of thermowell with all accessories at any height. this includes impulse tubing, Glanding, ferruling,termination Installation of Analyzers at any height after taking proper clearance.				0.00	0.00	INR Zero Only
21.53	All above jobs are inclusive of supply of all erection materials, grouting material (cement, concrete, sand etc.) and consumables.				0.00	0.00	INR Zero Only
21.54	Necessary skilled & unskilled manpower, supervision, & tackles, transporting vehicle, consumables including Teflon tape etc. will be in BIDDER's scope.				0.00	0.00	INR Zero Only
21.55	OWNER/PDIL/Others will be providing Analyzer system , The job shall be carried out as per specification and direction of Engineer-in-charge.				0.00	0.00	INR Zero Only
21.56	Dial type thermometers with thermowell erection / installation	15	NOS.		0.00	0.00	INR Zero Only
21.57	Dial type thermometers with thermowell calibration	15	NOS.		0.00	0.00	INR Zero Only
21.58	Temperature elements (Thermocouple / RTD) with thermowell erection / installation, Glanding ferruling & termination	30	NOS.		0.00	0.00	INR Zero Only
21.59	Temperature elements (thermocouple / RTD) with thermowell functional check, loop checking	30	NOS.		0.00	0.00	INR Zero Only
21.60	Temperature elements (thermocouple / RTD) with thermowell -calibration	30	NOS.		0.00	0.00	INR Zero Only
21.61	Erection / installation / fixing of online PH & Conductivity/dew point/silica/ O2/CO Analyzers.				0.00	0.00	INR Zero Only

Item Rate BoQ

Tender Inviting Authority: Projects & Development India Limited, Noida

Name of Work: TENDER FOR SUPPLY CUM ERECTION OF ELECTRICAL & INSTRUMENTATION WORKS ON ITEM RATE BASIS AT TALCHER FERTILIZERS LTD., ANGUL, ODISHA

Contract No: PNPM/PC-183/E/8003/NCB

NOTE : Quantities mentioned in the Schedule of Rates are indicative and not exhaustive in nature. Payment shall be made as per actual quantity used/certified at site by Owner's Engineer-in-charge. Quantities indicated in Schedule of Rates are approximate and subject to variation on either side. The quantity of individual item may be deleted. Contractor shall not be entitled for any compensation on this account and the quoted rates shall hold good for such quantity variations etc. Payments on bills shall, however, be made on actual measurements of quantities of work done as per approved drawings. Goods & Services Tax (GST) is applicable @ 18% on the quoted rates (being Works Contract).

Name of the Bidder/ Bidding Firm / Company :	
--	--

SCHEDULE OF RATE (Rev. 0) (This BOQ template must not be modified/replaced by the bidder and the same should be uploaded after filling the relevant columns, else the bidder is liable to be rejected for this tender. Bidders are allowed to enter the Bidder Name and Values only)

NUMBER #	TEXT #	NUMBER #	TEXT #	NUMBER #	NUMBER #	NUMBER #	TEXT #
Sl. No.	Item Description	Quantity	Units	BASIC RATE In Figures To be entered by the Bidder in Rs. P	TOTAL AMOUNT Incl. All taxes & duties (Excl. GST) in Rs. P	TOTAL AMOUNT Incl. All taxes , duties and GST in Rs. P	TOTAL AMOUNT Incl. All taxes, duties and GST In Words
21.62	The job includes the following: Receiving & shifting of PH & Conductivity Analyzer its accessories from store/any other place inside OWNER campus & transport to work site.Fixing of PH & Conductivity and other Analyzers with all accessories on at any heigh after taking proper clearance.				0.00	0.00	INR Zero Only
21.63	All above jobs are inclusive of supply of all erection materials, grouting material (cement, concrete, sand etc.) and consumables.				0.00	0.00	INR Zero Only
21.64	Necessary skilled & unskilled manpower, supervision, & tackles, transporting vehicle, consumables including Teflon tape etc. will be in BIDDER's scope.				0.00	0.00	INR Zero Only
21.65	OWNER/PDIL/Others will provide gasket sheet, however all gasket cutting for completing the job will be in BIDDER's scope. The job shall be carried out as per specification and direction of Engineer-in-charge.				0.00	0.00	INR Zero Only
21.66	PH/Conductivity Analyzer Installation/erection (includes Tubing, Glanding ,Ferruling &Termination)	1	NOS.		0.00	0.00	INR Zero Only
21.67	Calibration of PH / Conductivity Analyzer System	1	NOS.		0.00	0.00	INR Zero Only
21.68	PH/Conductivity Analyzer functional check, loop checking etc	1	NOS.		0.00	0.00	INR Zero Only
21.69	Dew Point Analyzer Installation/erection (includes Tubing, Glanding ,Ferruling &Termination)	1	NOS.		0.00	0.00	INR Zero Only
21.70	Calibration of Dew Point Analyzer System	1	NOS.		0.00	0.00	INR Zero Only
21.71	Dew Point Analyzer functional check, loop checking etc	1	NOS.		0.00	0.00	INR Zero Only
21.72	O2 Analyzer Installation/erection (includes Tubing, Glanding ,Ferruling &Termination)	1	NOS.		0.00	0.00	INR Zero Only
21.73	O2 Analyzer System	1	NOS.		0.00	0.00	INR Zero Only
21.74	O2 Analyzer functional check, loop checking etc	1	NOS.		0.00	0.00	INR Zero Only
21.75	CO Analyzer Installation/erection (includes Tubing, Glanding ,Ferruling &Termination)	1	NOS.		0.00	0.00	INR Zero Only
21.76	CO Analyzer System	1	NOS.		0.00	0.00	INR Zero Only

Validate

Print

Help

Item Rate BoQ

Tender Inviting Authority: Projects & Development India Limited, Noida

Name of Work: TENDER FOR SUPPLY CUM ERECTION OF ELECTRICAL & INSTRUMENTATION WORKS ON ITEM RATE BASIS AT TALCHER FERTILIZERS LTD., ANGUL, ODISHA

Contract No: PNPM/PC-183/E/8003/NCB

NOTE : Quantities mentioned in the Schedule of Rates are indicative and not exhaustive in nature. Payment shall be made as per actual quantity used/certified at site by Owner's Engineer-in-charge. Quantities indicated in Schedule of Rates are approximate and subject to variation on either side. The quantity of individual item may be deleted. Contractor shall not be entitled for any compensation on this account and the quoted rates shall hold good for such quantity variations etc. Payments on bills shall, however, be made on actual measurements of quantities of work done as per approved drawings. Goods & Services Tax (GST) is applicable @ 18% on the quoted rates (being Works Contract)

Name of the Bidder/ Bidding Firm / Company :							
SCHEDULE OF RATE (Rev. 0) (This BOQ template must not be modified/replaced by the bidder and the same should be uploaded after filling the relevant columns, else the bidder is liable to be rejected for this tender. Bidders are allowed to enter the Bidder Name and Values only)							
NUMBER #	TEXT #	NUMBER #	TEXT #	NUMBER #	NUMBER #	NUMBER #	TEXT #
Sl. No.	Item Description	Quantity	Units	BASIC RATE In Figures To be entered by the Bidder in Rs. P	TOTAL AMOUNT Incl. All taxes & duties (Excl. GST) in Rs. P	TOTAL AMOUNT Incl. All taxes , duties and GST in Rs. P	TOTAL AMOUNT Incl. All taxes, duties and GST In Words
22.00	Erection of Control Valves /on-off/MOV valves shall be part of Mechanical Erection Tender and laying , glanding , Termination of cables etc shall be bidders scope;bidder to note that necessary tubing from ADP to control valve shall be in bidders scope, there shall not be any separate rate for tube works				0.00	0.00	INR Zero Only
22.11	Glanding, ferruling and termination of the cable wherever required, including supply of ferrule and lugs is in BIDDER's scope of supply. Supplied lugs shall be Dowel make only (Applicable for any electrical device like limit switch, SOV, continuous position feedback etc. mounted on the control valve/MOV.) Fabrication, installation and grouting of support, if required. Grouting material (cement, concrete, sand etc.) shall be in BIDDER's scope. Erection supervision of Electrohydraulic control valves/on-off valves/MOV is also in BIDDER's scope. (the job also includes but not limited to tubing from ADP to control valves including necessary structural support)				0.00	0.00	INR Zero Only
22.12	Hot bolting of the flanges after charging of line, if required. Leakage testing, stroke checking and calibration of the control valve/MOV will be in BIDDER's scope. Painting of all erected structural items with one coat of ready mixed primer and two coats of approved quality synthetic enamel paint inclusive supply of paint and primer. (Paint and Primer make shall be Asian/Bermer/Nerolac)				0.00	0.00	INR Zero Only
22.13	The installation shall be as per typical installation diagram as enclosed. Necessary skilled & unskilled manpower, supervision, tools & tackles, transporting vehicle, consumables including Teflon tape etc. required for the job will be in BIDDER's scope. The job shall be carried out as per specification, direction of Engineer-in-charge				0.00	0.00	INR Zero Only
22.14	Size of control valve: up to 2" Erection supervision Glanding ,ferruling termination of Signal cables (includes continuous position f/band sov)	5	NOS.		0.00	0.00	INR Zero Only
22.15	Size of control valve : up to 2" functional check, loop checking (includes continuous position f/band sov)	5	NOS.		0.00	0.00	INR Zero Only

Validate

Print

Help

Item Rate BoQ

Tender Inviting Authority: Projects & Development India Limited, Noida

Name of Work: TENDER FOR SUPPLY CUM ERECTION OF ELECTRICAL & INSTRUMENTATION WORKS ON ITEM RATE BASIS AT TALCHER FERTILIZERS LTD., ANGUL, ODISHA

Contract No: PNPM/PC-183/E/8003/NCB

NOTE : Quantities mentioned in the Schedule of Rates are indicative and not exhaustive in nature. Payment shall be made as per actual quantity used/certified at site by Owner's Engineer-in-charge. Quantities indicated in Schedule of Rates are approximate and subject to variation on either side. The quantity of individual item may be deleted. Contractor shall not be entitled for any compensation on this account and the quoted rates shall hold good for such quantity variations etc. Payments on bills shall, however, be made on actual measurements of quantities of work done as per approved drawings. Goods & Services Tax (GST) is applicable @ 18% on the quoted rates (being Works Contract).

Name of the Bidder/ Bidding Firm / Company :	
--	--

SCHEDULE OF RATE (Rev. 0) (This BOQ template must not be modified/replaced by the bidder and the same should be uploaded after filling the relevant columns, else the bidder is liable to be rejected for this tender. Bidders are allowed to enter the Bidder Name and Values only)

NUMBER #	TEXT #	NUMBER #	TEXT #	NUMBER #	NUMBER #	NUMBER #	TEXT #
Sl. No.	Item Description	Quantity	Units	BASIC RATE In Figures To be entered by the Bidder in Rs. P	TOTAL AMOUNT Incl. All taxes & duties (Excl. GST) in Rs. P	TOTAL AMOUNT Incl. All taxes , duties and GST in Rs. P	TOTAL AMOUNT Incl. All taxes, duties and GST In Words
22.17	Size of Control Valve : Above 2" and up to 4" Errection supervision Glanding ,ferruling termination of Signal cables (includes continuous position f/band sov)	5	NOS.		0.00	0.00	INR Zero Only
22.18	Size of Control Valve : Above 2" and up to 4" functional check, loop checking (includes continuous position f/band sov)	5	NOS.		0.00	0.00	INR Zero Only
22.19	Size of Control Valve : Above 2" and up to 4" Calibration (includes continuous position f/band sov)	5	NOS.		0.00	0.00	INR Zero Only
22.20	Size of Control Valve : Above 4" and up to 6" Errection supervision Glanding ,ferruling termination of Signal cables (includes continuous position f/band sov)	5	NOS.		0.00	0.00	INR Zero Only
22.21	Size of Control Valve : Above 4" and up to 6" functional check, loop checking (includes continuous position f/band sov)	5	NOS.		0.00	0.00	INR Zero Only
22.22	Size of Control Valve : Above 4" and up to 6" Calibration (includes continuous position f/band sov)	5	NOS.		0.00	0.00	INR Zero Only
22.23	Size of Control Valve : Above 6" and up to 12" Errection supervision Glanding ,ferruling termination of Signal cables (includes continuous position f/band sov)	5	NOS.		0.00	0.00	INR Zero Only
22.24	Size of Control Valve : Above 6" and up to 12" functional check, loop checking (includes continuous position f/band sov)	5	NOS.		0.00	0.00	INR Zero Only
22.25	Size of Control Valve : Above 6" and up to 12" Calibration (includes continuous position f/band sov)	5	NOS.		0.00	0.00	INR Zero Only
22.26	Size of MOV :above 8" and upto 10: Errection supervision Glanding ,ferruling termination of Signal cables (includes continuous position f/band sov)	5	NOS.		0.00	0.00	INR Zero Only
22.27	Size of MOV :above 8" and upto 10: functional check, loop checking (includes continuous position f/band sov)	5	NOS.		0.00	0.00	INR Zero Only
22.28	Size of MOV :above 8" and upto 10: Calibration (includes continuous position f/band sov)	5	NOS.		0.00	0.00	INR Zero Only
22.29	Size of MOV :above 10: Errection supervision Glanding ,ferruling termination of Signal cables (includes continuous position f/band sov)	5	NOS.		0.00	0.00	INR Zero Only
22.30	Size of MOV :above 10: functional check, loop checking (includes continuous position f/band sov)	5	NOS.		0.00	0.00	INR Zero Only
22.31	Size of MOV :above 10: Calibration (includes continuous position f/band sov)	5	NOS.		0.00	0.00	INR Zero Only

Validate

Print

Help

Item Rate BoQ

Tender Inviting Authority: Projects & Development India Limited, Noida

Name of Work: TENDER FOR SUPPLY CUM ERECTION OF ELECTRICAL & INSTRUMENTATION WORKS ON ITEM RATE BASIS AT TALCHER FERTILIZERS LTD., ANGUL, ODISHA

Contract No: PNPM/PC-183/E/8003/NCB

NOTE : Quantities mentioned in the Schedule of Rates are indicative and not exhaustive in nature. Payment shall be made as per actual quantity used/certified at site by Owner's Engineer-in-charge. Quantities indicated in Schedule of Rates are approximate and subject to variation on either side. The quantity of individual item may be deleted. Contractor shall not be entitled for any compensation on this account and the quoted rates shall hold good for such quantity variations etc. Payments on bills shall, however, be made on actual measurements of quantities of work done as per approved drawings. Goods & Services Tax (GST) is applicable @ 18% on the quoted rates (being Works Contract).

Name of the Bidder/ Bidding Firm / Company :							
SCHEDULE OF RATE (Rev. 0) (This BOQ template must not be modified/replaced by the bidder and the same should be uploaded after filling the relevant columns, else the bidder is liable to be rejected for this tender. Bidders are allowed to enter the Bidder Name and Values only)							
NUMBER #	TEXT #	NUMBER #	TEXT #	NUMBER #	NUMBER #	NUMBER #	TEXT #
Sl. No.	Item Description	Quantity	Units	BASIC RATE In Figures To be entered by the Bidder in Rs. P	TOTAL AMOUNT Incl. All taxes & duties (Excl. GST) in Rs. P	TOTAL AMOUNT Incl. All taxes , duties and GST in Rs. P	TOTAL AMOUNT Incl. All taxes, duties and GST In Words
22.34	Orifice assembly with Flanged Connection up to 3"	5	NOS.		0.00	0.00	INR Zero Only
22.35	Orifice assembly with Flanged Connection above 3" to 12"	5	NOS.		0.00	0.00	INR Zero Only
22.36	The job includes the following: Receiving & shifting of LG & its accessories from store/any other place inside OWNER/PDIL campus & transport to work site.Fixing of LG with all accessories on vessel/standpipe at any height. taking proper clearance				0.00	0.00	INR Zero Only
22.37	Fabrication, installation and grouting of small supports for instrument if necessary, All above jobs are inclusive of supply of all sorts of erection materials (including clamps, nut bolt etc.) and consumables excepting the supply of Pipes, Pipe Fittings, Structural Material, and Instruments. providing Holes in Blind flange for veseel related tags, Hydraulic testing of manifold, impusle pipie, DP test,PMI test Painting of all erected structural items (excluding impulse line) inclusive supply of paint (Paint make shall be Asian/Berger/Nerolac). The installation shall be as per typical installation diagram				0.00	0.00	INR Zero Only
22.38	Necessary skilled & unskilled manpower, supervision, & tackles, transporting vehicle, consumables including Teflon tape etc. will be in BIDDER's scope.				0.00	0.00	INR Zero Only
22.39	calibration/Erection of level Gauges(ALL TYPES) on vessel/Stand pipe	10	NOS.		0.00	0.00	INR Zero Only
23.00	Erection and Installation of Inline flowmeter (all types) on pipe as per attached hook-ups & installation drawing.				0.00	0.00	INR Zero Only
23.11	The job includes the following: Erection and installation, Glanding, ferruling and termination of the cable wherever required, including supply of ferrule and lugs is in BIDDER's scope of supply Supplied lugs shall be Dowel make only Fabrication, installation and grouting of support, if required. Grouting material (cement, concrete, sand etc if required.) shall be in BIDDER's scope.				0.00	0.00	INR Zero Only

Item Rate BoQ

Tender Inviting Authority: Projects & Development India Limited, Noida

Name of Work: TENDER FOR SUPPLY CUM ERECTION OF ELECTRICAL & INSTRUMENTATION WORKS ON ITEM RATE BASIS AT TALCHER FERTILIZERS LTD., ANGUL, ODISHA

Contract No: PNPM/PC-183/E/8003/NCB

NOTE : Quantities mentioned in the Schedule of Rates are indicative and not exhaustive in nature. Payment shall be made as per actual quantity used/certified at site by Owner's Engineer-in-charge. Quantities indicated in Schedule of Rates are approximate and subject to variation on either side. The quantity of individual item may be deleted. Contractor shall not be entitled for any compensation on this account and the quoted rates shall hold good for such quantity variations etc. Payments on bills shall, however, be made on actual measurements of quantities of work done as per approved drawings. Goods & Services Tax (GST) is applicable @ 18% on the quoted rates (being Works Contract)

Name of the Bidder/ Bidding Firm / Company :	
--	--

SCHEDULE OF RATE (Rev. 0) (This BOQ template must not be modified/replaced by the bidder and the same should be uploaded after filling the relevant columns, else the bidder is liable to be rejected for this tender. Bidders are allowed to enter the Bidder Name and Values only)

NUMBER #	TEXT #	NUMBER #	TEXT #	NUMBER #	NUMBER #	NUMBER #	TEXT #
Sl. No.	Item Description	Quantity	Units	BASIC RATE In Figures To be entered by the Bidder in Rs. P	TOTAL AMOUNT Incl. All taxes & duties (Excl. GST) in Rs. P	TOTAL AMOUNT Incl. All taxes , duties and GST in Rs. P	TOTAL AMOUNT Incl. All taxes, duties and GST In Words
23.12	Fabrication, installation and grouting of small supports for instrument if necessary, All above jobs are inclusive of supply of all sorts of erection materials (including clamps, nut bolt etc.) and consumables excepting the supply of Pipes, Pipe Fittings, Structural Material, and Instruments. providing Holes in Blind flange for veseel related tags, Hydraulic testing of manifold. impusle pipie, DP test,PMI test Painting of all erected structural items (excluding impulse line) inclusive supply of paint (Paint make shall be Asian/Berger/Neopac). The installation shall be as per typical installation diagram				0.00	0.00	INR Zero Only
23.13	Necessary skilled & unskilled manpower, supervision, & tackles, transporting vehicle, consumables including Teflon tape etc. will be in BIDDER's scope.				0.00	0.00	INR Zero Only
23.14	Inline Flow Meter all types (FT)- Erection / installation (glanding, and termination, erection of Statcton & Supports Canopy etc if any)	3	NOS.		0.00	0.00	INR Zero Only
23.15	Inline Flow Meter all types (FT)- Functional check, loop checking	3	NOS.		0.00	0.00	INR Zero Only
23.16	Inline Flow Meter all types (FT)- Calibration	3	NOS.		0.00	0.00	INR Zero Only
23.17	Calibration,Erection supervision of TSV/Safety/Vaccum Relief Valves/Self Actuating Valve				0.00	0.00	INR Zero Only
24.00	Erection of TSV/Safety relief valves/Vaccum rief valves/Self Actuating Valve shall be part of Mechanical Erection Tender				0.00	0.00	INR Zero Only
24.11	The job includes the following: Shifting of new instrument with its accessories from store to work site Calibration of Pressure safety/Pressure regulating Valve as per the instructions of Engineer incharge , bidder to note that necessary washing connection tubing & steam tracing tubing shall be included in this quote. there is no separte price for tubing works				0.00	0.00	INR Zero Only
24.12	Necessary skilled & unskilled manpower, supervision, & tackles,PSV/PCV calibration bench, transporting vehicle, consumables including Teflon tape etc. will be in BIDDER's scope.				0.00	0.00	INR Zero Only
24.13	PSV/TSV/VRV/PCV- Calibration	20	NOS.		0.00	0.00	INR Zero Only

Item Rate BoQ

Tender Inviting Authority: Projects & Development India Limited, Noida

Name of Work: TENDER FOR SUPPLY CUM ERECTION OF ELECTRICAL & INSTRUMENTATION WORKS ON ITEM RATE BASIS AT TALCHER FERTILIZERS LTD., ANGUL, ODISHA

Contract No: PNPM/PC-183/E/8003/NCB

NOTE : Quantities mentioned in the Schedule of Rates are indicative and not exhaustive in nature. Payment shall be made as per actual quantity used/certified at site by Owner's Engineer-in-charge. Quantities indicated in Schedule of Rates are approximate and subject to variation on either side. The quantity of individual item may be deleted. Contractor shall not be entitled for any compensation on this account and the quoted rates shall hold good for such quantity variations etc. Payments on bills shall, however, be made on actual measurements of quantities of work done as per approved drawings. Goods & Services Tax (GST) is applicable @ 18% on the quoted rates (being Works Contract)

Name of the Bidder/ Bidding Firm / Company :	
--	--

SCHEDULE OF RATE (Rev. 0) (This BOQ template must not be modified/replaced by the bidder and the same should be uploaded after filling the relevant columns, else the bidder is liable to be rejected for this tender. Bidders are allowed to enter the Bidder Name and Values only)

NUMBER #	TEXT #	NUMBER #	TEXT #	NUMBER #	NUMBER #	NUMBER #	TEXT #
Sl. No.	Item Description	Quantity	Units	BASIC RATE In Figures To be entered by the Bidder in Rs. P	TOTAL AMOUNT Incl. All taxes & duties (Excl. GST) in Rs. P	TOTAL AMOUNT Incl. All taxes , duties and GST in Rs. P	TOTAL AMOUNT Incl. All taxes, duties and GST In Words
25.00	SECTION B-2 - INSTRUMENT WORKS (ERECTION OF CABLE DUCT , CABLE LAYING AND CABLE TRAY LAYING,CABLE DUCT LAYING, INSTALLATION OF JUNCTION BOX , LOCAL CONTROL PANEL , AIR DISTRIBUTION POT ETC. AS PER INSTALLATION DRAWING)				0.00	0.00	INR Zero Only
25.11	Cable laying in Cable tray of Instrumentation cable inclusive of unpacking, Transportation from store, primary checking, testing, etc.				0.00	0.00	INR Zero Only
25.12	Horizontal and vertical laying of different instrument cables (Signal / Power / Control / Alarm / Thermocouple / RTD /OFC/CO-AXIALetc.) of different sizes and types (armoured/unarmoured) in Cable tray, including routing through MCT blocks, fixing of galvanized clamps and screws for fixing cables on to the supports in theTray/ structure etc., providing aluminium cable tags at both the ends of the cable, line testing and transportation from stores to site, unpacking, straightening, dressing of cable & returning the empty drums with unused cable, if any to stores complete with labour and materials as per the drawings, specifications and directions of the engineer-in-charge, Bidder to note that this work shall include price for Glanding at both sides ie; JB side and Panel side, there will not be any seperate Price (Sand removal and filling for cable laying shall be in bidders scope , there wont be any seperate price for the same bidder to quote accordingly)				0.00	0.00	INR Zero Only
25.13	SOR (cable Laying)				0.00	0.00	INR Zero Only
25.14	Cable Size: Overall diameter upto 20 mm	7800	Mtr		0.00	0.00	INR Zero Only
25.15	Cable Size: Overall diameter > 20 mm upto 40 mm	42000	Mtr		0.00	0.00	INR Zero Only
25.16	CABLE GLANDING & TERMINATION WITH DOUBLE COMPRESSION SS316 GLANDS				0.00	0.00	INR Zero Only
25.17	Glanding & termination of signal/ control/triad/T/C and power cables with double compression type SS316 cable glands, restoration of insulation, clamping of the cable including supply of clamps. Tagging with aluminium tags, earthing of armour, connection to the equipment terminals etc. excluding supply of double compression brass / SS316 cable glands. All complete with labour and materials as per drawings				0.00	0.00	INR Zero Only

Item Rate BoQ

Tender Inviting Authority: Projects & Development India Limited, Noida

Name of Work: TENDER FOR SUPPLY CUM ERECTION OF ELECTRICAL & INSTRUMENTATION WORKS ON ITEM RATE BASIS AT TALCHER FERTILIZERS LTD., ANGUL, ODISHA

Contract No: PNPM/PC-183/E/8003/NCB

NOTE : Quantities mentioned in the Schedule of Rates are indicative and not exhaustive in nature. Payment shall be made as per actual quantity used/certified at site by Owner's Engineer-in-charge. Quantities indicated in Schedule of Rates are approximate and subject to variation on either side. The quantity of individual item may be deleted. Contractor shall not be entitled for any compensation on this account and the quoted rates shall hold good for such quantity variations etc. Payments on bills shall, however, be made on actual measurements of quantities of work done as per approved drawings. Goods & Services Tax (GST) is applicable @ 18% on the quoted rates (being Works Contract).

Name of the Bidder/ Bidding Firm / Company :	
---	--

SCHEDULE OF RATE (Rev. 0) (This BOQ template must not be modified/replaced by the bidder and the same should be uploaded after filling the relevant columns, else the bidder is liable to be rejected for this tender. Bidders are allowed to enter the Bidder Name and Values only)

NUMBER #	TEXT #	NUMBER #	TEXT #	NUMBER #	NUMBER #	NUMBER #	TEXT #
Sl. No.	Item Description	Quantity	Units	BASIC RATE In Figures To be entered by the Bidder in Rs. P	TOTAL AMOUNT Incl. All taxes & duties (Excl. GST) in Rs. P	TOTAL AMOUNT Incl. All taxes , duties and GST in Rs. P	TOTAL AMOUNT Incl. All taxes, duties and GST In Words
25.19	Cable gland size 1" & 1.5"	154	NOS		0.00	0.00	INR Zero Only
25.20	Supply & laying of perforated FRP cable tray including joining, cutting, bending, supporting etc. Laying of MS/ GI / FRP Perforated cable trays / Cable duct (supply of tray, cable duct & structural steel in BIDDER's scope) - refer layout.				0.00	0.00	INR Zero Only
25.21	The job includes the following: Shifting of tray /duct material from store to work site, fabrication and laying of perforated trays as per specifications & direction of Engineer in charge Supply of Perforated Trays & structural steel shall be in BIDDER's scope.				0.00	0.00	INR Zero Only
25.22	All other material including grouting material (cement, concrete, sand etc.), clamps, bolts, nuts etc. required to complete the job shall be in BIDDER's scope.Fabrication, installation and grouting of support wherever required, cutting and modification of existing support if required inclusive of supply of erection consumable materials.				0.00	0.00	INR Zero Only
25.23	Painting of all erected structural items with one coat of ready mixed primer and two coats of approved quality synthetic enamel paint inclusive of supply of paint and primer. (Paint and Primer make shall be Asian/Berger/Nerolac).Necessary skill & unskill manpower, supervision, tools & tackles, transporting vehicle, consumables will be in BIDDER's scope. The job shall be carried out as per specification and direction of Engineer-in-charge.(Sand removal and filling for cable laying shall be in bidders scope , there wont be any separate price for the same bidder to quote accordingly)				0.00	0.00	INR Zero Only
25.24	CableTray (Perforated) 2500 x 600 x 100 (including bends/cross/tees and all other fittings and accessories)	4080	MTR		0.00	0.00	INR Zero Only
25.25	Cable Tray (Perforated) 2500 x 300 x 55 (including bends/cross/tees and all other fittings and accessories)	600	MTR		0.00	0.00	INR Zero Only
25.26	Cable Trays (Perforated) 2500 x 200 x 55 (including bends/cross/tees and all other fittings and accessories)	2400	MTR		0.00	0.00	INR Zero Only

Validate

Print

Help

Item Rate BoQ

Tender Inviting Authority: Projects & Development India Limited, Noida

Name of Work: TENDER FOR SUPPLY CUM ERECTION OF ELECTRICAL & INSTRUMENTATION WORKS ON ITEM RATE BASIS AT TALCHER FERTILIZERS LTD., ANGUL, ODISHA

Contract No: PNPM/PC-183/E/8003/NCB

NOTE : Quantities mentioned in the Schedule of Rates are indicative and not exhaustive in nature. Payment shall be made as per actual quantity used/certified at site by Owner's Engineer-in-charge. Quantities indicated in Schedule of Rates are approximate and subject to variation on either side. The quantity of individual item may be deleted. Contractor shall not be entitled for any compensation on this account and the quoted rates shall hold good for such quantity variations etc. Payments on bills shall, however, be made on actual measurements of quantities of work done as per approved drawings. Goods & Services Tax (GST) is applicable @ 18% on the quoted rates (being Works Contract)

Name of the Bidder/ Bidding Firm / Company :	
--	--

SCHEDULE OF RATE (Rev. 0) (This BOQ template must not be modified/replaced by the bidder and the same should be uploaded after filling the relevant columns, else the bidder is liable to be rejected for this tender. Bidders are allowed to enter the Bidder Name and Values only)

NUMBER #	TEXT #	NUMBER #	TEXT #	NUMBER #	NUMBER #	NUMBER #	TEXT #
Sl. No.	Item Description	Quantity	Units	BASIC RATE In Figures To be entered by the Bidder in Rs. P	TOTAL AMOUNT Incl. All taxes & duties (Excl. GST) in Rs. P	TOTAL AMOUNT Incl. All taxes , duties and GST in Rs. P	TOTAL AMOUNT Incl. All taxes, duties and GST In Words
25.28	Cable Trays (Perforated) 2500 x 50 x 55 (including bends/cross/tees and all other fittings and accessories)	1200	MTR		0.00	0.00	INR Zero Only
25.29	Installation of junction box with canopy / local control panel/emergency push button etc including structural welding, clamping etc. (supply of junction box & local control panel with push buttons in OWNER/PDIL's scope)				0.00	0.00	INR Zero Only
25.30	The job includes the following: Shifting of new Junction Box/LCP with pushbuttons (for reset,start stop at grade level) with its accessories from store to work site. Fabrication and installation of supports and installation of junction box.Screwing, plugging of unused entries of Junction Box. Fabrication, installation with canopy and grouting of support. Grouting material (cement, concrete, sand etc.) shall be in BIDDER's scope. Cutting and modification of existing support if required				0.00	0.00	INR Zero Only
25.31	Glanding of multicore & branch cables, aluminium tagging of the glands, supply of aluminium tag is in BIDDER's scope of supply but cable gland shall be supplied free of cost by owner.				0.00	0.00	INR Zero Only
25.32	Painting of all erected structural items with one coat of ready mixed primer and two coats of approved quality synthetic enamel paint inclusive supply of paint and primer. (Paint and Primer make shall be Asian/Berger/Nerolac).				0.00	0.00	INR Zero Only
25.33	Necessary skilled & unskilled manpower, supervision, tools & tackles, transporting vehicle, consumables will be in BIDDER's scope.The job shall be carried out as per specification and direction of Engineer-in-charge.				0.00	0.00	INR Zero Only
25.34	Bidder to note that Suitable earthing using 10MMSQ eathing cable as per drawings or direction form engineer incharge from panel to Earth Busbar shall be provided. there wont be any special rate for the same.				0.00	0.00	INR Zero Only
25.35	Explosion proof junction box suitable for 12 pair cable.	30	NOS		0.00	0.00	INR Zero Only
25.36	Installation of Pushbuttons	10	NOS		0.00	0.00	INR Zero Only

Validate

Print

Help

Item Rate BoQ

Tender Inviting Authority: Projects & Development India Limited, Noida

Name of Work: TENDER FOR SUPPLY CUM ERECTION OF ELECTRICAL & INSTRUMENTATION WORKS ON ITEM RATE BASIS AT TALCHER FERTILIZERS LTD., ANGUL, ODISHA

Contract No: PNPM/PC-183/E/8003/NCB

NOTE : Quantities mentioned in the Schedule of Rates are indicative and not exhaustive in nature. Payment shall be made as per actual quantity used/certified at site by Owner's Engineer-in-charge. Quantities indicated in Schedule of Rates are approximate and subject to variation on either side. The quantity of individual item may be deleted. Contractor shall not be entitled for any compensation on this account and the quoted rates shall hold good for such quantity variations etc. Payments on bills shall, however, be made on actual measurements of quantities of work done as per approved drawings. Goods & Services Tax (GST) is applicable @ 18% on the quoted rates (being Works Contract).

Name of the Bidder/ Bidding Firm / Company :	
--	--

SCHEDULE OF RATE (Rev. 0) (This BOQ template must not be modified/replaced by the bidder and the same should be uploaded after filling the relevant columns, else the bidder is liable to be rejected for this tender. Bidders are allowed to enter the Bidder Name and Values only)

NUMBER #	TEXT #	NUMBER #	TEXT #	NUMBER #	NUMBER #	NUMBER #	TEXT #
Sl. No.	Item Description	Quantity	Units	BASIC RATE In Figures To be entered by the Bidder in Rs. P	TOTAL AMOUNT Incl. All taxes & duties (Excl. GST) in Rs. P	TOTAL AMOUNT Incl. All taxes , duties and GST in Rs. P	TOTAL AMOUNT Incl. All taxes, duties and GST In Words
25.37	Structural work & fabrication for instrument items like tray support, mounting frames for instruments, base frames, canopy for jib & transmitters, any other required for supporting instrument items. (Structural & pipe material is in BIDDER's scope)				0.00	0.00	INR Zero Only
25.38	The job includes the following: Fabrication of yoke supports as per drawing for instruments of flow, pressure, level, temperature etc.as per installation drawing .Installation of the same on supports / wall / ground by welding / clamping / grouting as per requirement. Any other material if required shall be in BIDDER's scope.				0.00	0.00	INR Zero Only
25.39	Grouting material (cement, concrete, sand etc.) / welding material / clamping material shall be in BIDDER's scope.Cutting and modification of existing support if required.				0.00	0.00	INR Zero Only
25.40	Painting of all erected structural items with one coat of ready mixed primer and two coats of approved quality synthetic enamel paint inclusive supply of paint and primer. (Paint and Primer make shall be Asian/Berger/Nerolac).Necessary skilled & unskilled manpower, supervision, tools & tackles, transporting vehicle, consumables will be in BIDDER's scope.The job shall be carried out as per specification and direction of Engineer-in-charge.bidder to note that there is no separate rate is allowed for stanchion supports				0.00	0.00	INR Zero Only
25.41	50 x 50 x 6THK ANGLE MS	7000	kg		0.00	0.00	INR Zero Only
25.42	100 x 50 x 6THK CHANNEL MS	22000	kg		0.00	0.00	INR Zero Only
25.43	FOUNDATION BOLTS, NUTS & WASHER 10MM X 150L MS	1200	Nos		0.00	0.00	INR Zero Only
25.44	COVER PLATE 4 MMTHK MS	120	kg		0.00	0.00	INR Zero Only
25.45	RIBS (PLATE) 250 X 250 X 6 THK MS PLATE	1700	kg		0.00	0.00	INR Zero Only
25.46	BASE PLATE 250 X 250 X 6 THK MS PLATE	1700	kg		0.00	0.00	INR Zero Only
25.47	2" MS PIPE FOR STAND PIPE, MEDIUM, AS PER IS:1239	360	Mtr		0.00	0.00	INR Zero Only
25.48	Erection/installation of Air Distribution Port as per AP layout (will be provided later) any structural supports .skilled manpower and consumables, tools & tackles for completeion of Job shall be in bidders scope				0.00	0.00	INR Zero Only

Validate

Print

Help

Item Rate BoQ

Tender Inviting Authority: Projects & Development India Limited, Noida

Name of Work: TENDER FOR SUPPLY CUM ERECTION OF ELECTRICAL & INSTRUMENTATION WORKS ON ITEM RATE BASIS AT TALCHER FERTILIZERS LTD., ANGUL, ODISHA

Contract No: PNPM/PC-183/E/8003/NCB

NOTE : Quantities mentioned in the Schedule of Rates are indicative and not exhaustive in nature. Payment shall be made as per actual quantity used/certified at site by Owner's Engineer-in-charge. Quantities indicated in Schedule of Rates are approximate and subject to variation on either side. The quantity of individual item may be deleted. Contractor shall not be entitled for any compensation on this account and the quoted rates shall hold good for such quantity variations etc. Payments on bills shall, however, be made on actual measurements of quantities of work done as per approved drawings. Goods & Services Tax (GST) is applicable @ 18% on the quoted rates (being Works Contract)

Name of the Bidder/ Bidding Firm / Company :							
SCHEDULE OF RATE (Rev. 0) (This BOQ template must not be modified/replaced by the bidder and the same should be uploaded after filling the relevant columns, else the bidder is liable to be rejected for this tender. Bidders are allowed to enter the Bidder Name and Values only)							
NUMBER #	TEXT #	NUMBER #	TEXT #	NUMBER #	NUMBER #	NUMBER #	TEXT #
Sl. No.	Item Description	Quantity	Units	BASIC RATE In Figures To be entered by the Bidder in Rs. P	TOTAL AMOUNT Incl. All taxes & duties (Excl. GST) in Rs. P	TOTAL AMOUNT Incl. All taxes , duties and GST in Rs. P	TOTAL AMOUNT Incl. All taxes, duties and GST In Words
25.49	The job includes the following: Ferruling, Glanding, termination, Fabrication of supports, Installation of the same on supports / wall / ground by welding / clamping / grouting as per requirement. Any other material if required shall be in BIDDER's scope. Grouting material (cement, concrete, sand etc.) / welding material / clamping material shall be in BIDDER's scope. Cutting and modification of existing support if required. Painting of all erected structural items with one coat of ready mixed primer and two coats of approved quality synthetic enamel paint inclusive supply of paint and primer. (Paint and Primer make shall be Asian/Berger/Nerolac). Necessary skilled & unskilled manpower, supervision, tools & tackles, transporting vehicle, consumables will be in BIDDER's scope. The job shall be carried out as per specification and direction of Engineer-in-charge. Bidder to note that Suitable earthing using 10MMSQ earthing cable as per drawings or direction from engineer incharge from panel to Earth Busbar shall be provided. there wont be any special rate for the same.				0.00	0.00	INR Zero Only
25.50	AIR DISTRIBUTION PORT (AS PER ATTACHED DWNG)	5	Nos		0.00	0.00	INR Zero Only
26.00	Erection/installation of local control panel/ DCS/PLC panels				0.00	0.00	INR Zero Only

Validate

Print

Help

Item Rate BoQ

Tender Inviting Authority: Projects & Development India Limited, Noida

Name of Work: TENDER FOR SUPPLY CUM ERECTION OF ELECTRICAL & INSTRUMENTATION WORKS ON ITEM RATE BASIS AT TALCHER FERTILIZERS LTD., ANGUL, ODISHA

Contract No: PNP/PC-183/E/8003/NCB

NOTE : Quantities mentioned in the Schedule of Rates are indicative and not exhaustive in nature. Payment shall be made as per actual quantity used/certified at site by Owner's Engineer-in-charge. Quantities indicated in Schedule of Rates are approximate and subject to variation on either side. The quantity of individual item may be deleted. Contractor shall not be entitled for any compensation on this account and the quoted rates shall hold good for such quantity variations etc. Payments on bills shall, however, be made on actual measurements of quantities of work done as per approved drawings. Goods & Services Tax (GST) is applicable @ 18% on the quoted rates (being Works Contract)

Name of the Bidder/ Bidding Firm / Company :							
SCHEDULE OF RATE (Rev. 0) (This BOQ template must not be modified/replaced by the bidder and the same should be uploaded after filling the relevant columns, else the bidder is liable to be rejected for this tender. Bidders are allowed to enter the Bidder Name and Values only)							
NUMBER #	TEXT #	NUMBER #	TEXT #	NUMBER #	NUMBER #	NUMBER #	TEXT #
Sl. No.	Item Description	Quantity	Units	BASIC RATE In Figures To be entered by the Bidder in Rs. P	TOTAL AMOUNT Incl. All taxes & duties (Excl. GST) in Rs. P	TOTAL AMOUNT Incl. All taxes , duties and GST in Rs. P	TOTAL AMOUNT Incl. All taxes, duties and GST In Words
26.11	The job includes the following: Glanding , termination,Fabrication of supports,Installation of the same on supports / wall / ground by welding / clamping / grouting as per requirement. Any other material if required shall be in BIDDER's scope. Grouting material (cement, concrete, sand etc.) / welding material / clamping material shall be in BIDDER's scope.Cutting and modification of existing support if required.Painting of all erected structural items with one coat of ready mixed primer and two coats of approved quality synthetic enamel paint inclusive supply of paint and primer., (Paint and Primer make shall be Asian/Berger/Nerolac).Necessary skilled & unskilled manpower, supervision, tools & tackles, transporting vehicle, consumables will be in BIDDER's scope.The job shall be carried out as per specification and direction of Engineer-in-charge.(Sand removal and filling for cable laying shall be in bidders scope , there wont be any separate price for the same bidder to quote accordingly) Bidder to note that Suitable earthing using 10MMSQ eathing cable as per drawings or direction from engineer incahrge from panel to Earth Busbar shall be provided. there wont be any special rate for the same.				0.00	0.00	INR Zero Only
26.12	CONTROL/MARSHALLING/LOCAL PANELS	10	Nos		0.00	0.00	INR Zero Only

Validate

Print

Help

Item Rate BoQ

Tender Inviting Authority: Projects & Development India Limited, Noida

Name of Work: TENDER FOR SUPPLY CUM ERECTION OF ELECTRICAL & INSTRUMENTATION WORKS ON ITEM RATE BASIS AT TALCHER FERTILIZERS LTD., ANGUL, ODISHA

Contract No: PNPM/PC-183/E/8003/NCB

NOTE : Quantities mentioned in the Schedule of Rates are indicative and not exhaustive in nature. Payment shall be made as per actual quantity used/certified at site by Owner's Engineer-in-charge. Quantities indicated in Schedule of Rates are approximate and subject to variation on either side. The quantity of individual item may be deleted. Contractor shall not be entitled for any compensation on this account and the quoted rates shall hold good for such quantity variations etc. Payments on bills shall, however, be made on actual measurements of quantities of work done as per approved drawings. Goods & Services Tax (GST) is applicable @ 18% on the quoted rates (being Works Contract)

Name of the Bidder/ Bidding Firm / Company :							
SCHEDULE OF RATE (Rev. 0) (This BOQ template must not be modified/replaced by the bidder and the same should be uploaded after filling the relevant columns, else the bidder is liable to be rejected for this tender. Bidders are allowed to enter the Bidder Name and Values only)							
NUMBER #	TEXT #	NUMBER #	TEXT #	NUMBER #	NUMBER #	NUMBER #	TEXT #
Sl. No.	Item Description	Quantity	Units	BASIC RATE In Figures To be entered by the Bidder in Rs. P	TOTAL AMOUNT Incl. All taxes & duties (Excl. GST) in Rs. P	TOTAL AMOUNT Incl. All taxes , duties and GST in Rs. P	TOTAL AMOUNT Incl. All taxes, duties and GST In Words
27.00	Erection/installation & commissioning of Telephone network The job includes the following: Glanding , termination,Fabrication of supports,installation of the same on supports / wall / ground by welding / clamping / grouting as per requirement. Any other material if required shall be in BIDDER's scope. Grouting material (cement, concrete, sand etc.) / welding material / clamping material shall be in BIDDER's scope.Cutting and modification of existing support if required.Painting of all erected structural items with one coat of ready mixed primer and two coats of approved quality synthetic enamel paint inclusive supply of paint and primer. (Paint and Primer make shall be Asian/Berger/Nerolac).Necessary skilled & unskilled manpower, supervision,Machines, tools & tackles, transporting vehicle, consumables will be in BIDDER's scope.The job shall be carried out as per specification and direction of Engineer-in-charge.(Sand removal and filling for cable laying shall be in bidders scope , there wont be any seperate price for the same bidder to quote accordingly)				0.00	0.00	INR Zero Only
27.11	SOR for Erection/installtion-Erection/installation of CCTV system as Section--A INSTRUMENT WORKS (SUPPLY) - CCTV for OSBL facilites and Surveillance Purpose of TFL Fertilizer complex : Design , Engineering & Supply				0.00	0.00	INR Zero Only
27.12	Installation of Telepone system as Per detailed Specification ncluding JB/Terminal Box(no special rate for terminal box)	8	Nos		0.00	0.00	INR Zero Only
27.13	Cable laying (20 Pair & 5 Pair)	5000	Mtr		0.00	0.00	INR Zero Only

Item Rate BoQ

Tender Inviting Authority: Projects & Development India Limited, Noida

Name of Work: TENDER FOR SUPPLY CUM ERECTION OF ELECTRICAL & INSTRUMENTATION WORKS ON ITEM RATE BASIS AT TALCHER FERTILIZERS LTD., ANGUL, ODISHA

Contract No: PNPM/PC-183/E/8003/NCB

NOTE : Quantities mentioned in the Schedule of Rates are indicative and not exhaustive in nature. Payment shall be made as per actual quantity used/certified at site by Owner's Engineer-in-charge. Quantities indicated in Schedule of Rates are approximate and subject to variation on either side. The quantity of individual item may be deleted. Contractor shall not be entitled for any compensation on this account and the quoted rates shall hold good for such quantity variations etc. Payments on bills shall, however, be made on actual measurements of quantities of work done as per approved drawings. Goods & Services Tax (GST) is applicable @ 18% on the quoted rates (being Works Contract).

Name of the Bidder/ Bidding Firm / Company :	
--	--

SCHEDULE OF RATE (Rev. 0) (This BOQ template must not be modified/replaced by the bidder and the same should be uploaded after filling the relevant columns, else the bidder is liable to be rejected for this tender. Bidders are allowed to enter the Bidder Name and Values only)

NUMBER #	TEXT #	NUMBER #	TEXT #	NUMBER #	NUMBER #	NUMBER #	TEXT #
Sl. No.	Item Description	Quantity	Units	BASIC RATE In Figures To be entered by the Bidder in Rs. P	TOTAL AMOUNT Incl. All taxes & duties (Excl. GST) in Rs. P	TOTAL AMOUNT Incl. All taxes , duties and GST in Rs. P	TOTAL AMOUNT Incl. All taxes, duties and GST In Words
28.00	Erection/installation & commissioning GPS System The job includes the following: This Job includes installation of GPS system in Urea bagging unit with associated electronics, softwares and hooking up the same with the urea network. Glandng , termination,Fabrication of supports,Installation of the same on supports / wall / ground by welding / clamping / grouting as per requirement. Any other material if required shall be in BIDDER's scope. Grouting material (cement, concrete, sand etc.) / welding material / clamping material shall be in BIDDER's scope.Cutting and modification of existing support if required.Painting of all erected structural items with one coat of ready mixed primer and two coats of approved quality synthetic enamel paint inclusive supply of paint and primer. (Paint and Primer make shall be Asian/Berger/Nerolac).Necessary skilled & unskilled manpower, supervision,Machines, tools & tackles, transporting vehicle, consumables will be in BIDDER's scope.The job shall be carried out as per specification and direction of Engineer-in-charge.				0.00	0.00	INR Zero Only
28.11	Erection/installation of GPS Antenna systemn, softwre with asociated electronics & cable laying	1	Nos		0.00	0.00	INR Zero Only

[Validate](#)[Print](#)[Help](#)

Item Rate BoQ

Tender Inviting Authority: Projects & Development India Limited, Noida

Name of Work: TENDER FOR SUPPLY CUM ERECTION OF ELECTRICAL & INSTRUMENTATION WORKS ON ITEM RATE BASIS AT TALCHER FERTILIZERS LTD., ANGUL, ODISHA

Contract No: PNPM/PC-183/E/8003/NCB

NOTE : Quantities mentioned in the Schedule of Rates are indicative and not exhaustive in nature. Payment shall be made as per actual quantity used/certified at site by Owner's Engineer-in-charge. Quantities indicated in Schedule of Rates are approximate and subject to variation on either side. The quantity of individual item may be deleted. Contractor shall not be entitled for any compensation on this account and the quoted rates shall hold good for such quantity variations etc. Payments on bills shall, however, be made on actual measurements of quantities of work done as per approved drawings. Goods & Services Tax (GST) is applicable @ 18% on the quoted rates (being Works Contract).

Name of the Bidder/ Bidding Firm / Company :	
--	--

SCHEDULE OF RATE (Rev. 0) (This BOQ template must not be modified/replaced by the bidder and the same should be uploaded after filling the relevant columns, else the bidder is liable to be rejected for this tender. Bidders are allowed to enter the Bidder Name and Values only)

NUMBER #	TEXT #	NUMBER #	TEXT #	NUMBER #	NUMBER #	NUMBER #	TEXT #
Sl. No.	Item Description	Quantity	Units	BASIC RATE In Figures To be entered by the Bidder in Rs. P	TOTAL AMOUNT Incl. All taxes & duties (Excl. GST) in Rs. P	TOTAL AMOUNT Incl. All taxes , duties and GST in Rs. P	TOTAL AMOUNT Incl. All taxes, duties and GST In Words
29.00	Erection/installation & commissioning CCTV System The job includes the following: This Job includes installation of GPS system in Urea bagging unit with associated electronics, softwares and hooking up the same with the urea network. Glandng , termination,Fabrication of supports,Installation of the same on supports / wall / ground by welding / clamping / grouting as per requirement. Any other material if required shall be in BIDDER's scope. Grouting material (cement, concrete, sand etc.) / welding material / clamping material shall be in BIDDER's scope.Cutting and modification of existing support if required.Painting of all erected structural items with one coat of ready mixed primer and two coats of approved quality synthetic enamel paint inclusive supply of paint and primer. (Paint and Primer make shall be Asian/Berger/Nerolac).Necessary skilled & unskilled manpower, supervision,Machines, tools & tackles, transporting vehicle, consumables will be in BIDDER's scope.The job shall be carried out as per specification and direction of Engineer-in-charge.				0.00	0.00	INR Zero Only

Item Rate BoQ

Tender Inviting Authority: Projects & Development India Limited, Noida

Name of Work: TENDER FOR SUPPLY CUM ERECTION OF ELECTRICAL & INSTRUMENTATION WORKS ON ITEM RATE BASIS AT TALCHER FERTILIZERS LTD., ANGUL, ODISHA

Contract No: PNPM/PC-183/E/8003/NCB

NOTE : Quantities mentioned in the Schedule of Rates are indicative and not exhaustive in nature. Payment shall be made as per actual quantity used/certified at site by Owner's Engineer-in-charge. Quantities indicated in Schedule of Rates are approximate and subject to variation on either side. The quantity of individual item may be deleted. Contractor shall not be entitled for any compensation on this account and the quoted rates shall hold good for such quantity variations etc. Payments on bills shall, however, be made on actual measurements of quantities of work done as per approved drawings. Goods & Services Tax (GST) is applicable @ 18% on the quoted rates (being Works Contract)

Name of the Bidder/ Bidding Firm / Company :	
---	--

SCHEDULE OF RATE (Rev. 0) (This BOQ template must not be modified/replaced by the bidder and the same should be uploaded after filling the relevant columns, else the bidder is liable to be rejected for this tender. Bidders are allowed to enter the Bidder Name and Values only)

NUMBER #	TEXT #	NUMBER #	TEXT #	NUMBER #	NUMBER #	NUMBER #	TEXT #
Sl. No.	Item Description	Quantity	Units	BASIC RATE In Figures To be entered by the Bidder in Rs. P	TOTAL AMOUNT Incl. All taxes & duties (Excl. GST) in Rs. P	TOTAL AMOUNT Incl. All taxes , duties and GST in Rs. P	TOTAL AMOUNT Incl. All taxes, duties and GST In Words
29.11	Erection/installation commissioning of CCTV system as Section--A INSTRUMENT WORKS (SUPPLY) - CCTV Complete system for whole fertiliser complex as per attached specification - Bidder shall engineering , supply, install, test and commissioning the ONVIF-IP based Closed circuit television (CCTV) Surveillance System, Complete CCTV System with all accessories like Cameras, power supply , JB , LIU, media convertor, OFC convertor, 22" LED workstation , server, VMS ,NAS for 365 days storage , one LED 72" ceiling mounted with 100 windows , software , license , surveillance software , analytical software , all cables, all mounting accessories , poles , civil works etc. (A at the TFL fertilizer complex . The purpose of the CCTV System is to monitor the facility operations & security surveillance from control room / Security room & Admin building to keep eye on facility covering Main gate entry /exit ,material gate exit / entry and other area of importance to the daily running of the complex by installing cameras to monitor resulting to enhancement in the Operational & Safety needs. It is intended to install CCTV system to track the Material movement, Recognition of persons and objects including vehicles through high quality images in and outside the plant by Security. The recording of the scene can be used in investigation, recreating the scene and establishing the truth.	1	Nos		0.00	0.00	INR Zero Only
29.12	Erection/installation commissioning Fixed Camera Section--A INSTRUMENT WORKS (SUPPLY) - Fixed Perimeter 1080p HD IP outdoor Cameras IP66 housing with Day/night fixed camera with advanced video analytics, Min 75 Mtrs IR range , Camera with 1/3" or better CMOS , 1920 (H) X 1080 (V); 2 MP or better , Inbuilt Min 128 GB or higher GB SD Card Storage for local recording etc. as per attached specification	60	Nos		0.00	0.00	INR Zero Only
29.13	Erection/installation commissioning PTZ Camera Section--A INSTRUMENT WORKS (SUPPLY) - 1080p HD IP Indoor / outdoor PTZ Cameras with 1/3" or better progressive scan Exmor CMOS , 1920 (H) X 1080 (V); 2 MP or better , Inbuilt Min 128 GB or higher GB SD Card Storage for local recording etc. as per attached specification	9	Nos		0.00	0.00	INR Zero Only

Item Rate BoQ

Tender Inviting Authority: Projects & Development India Limited, Noida

Name of Work: TENDER FOR SUPPLY CUM ERECTION OF ELECTRICAL & INSTRUMENTATION WORKS ON ITEM RATE BASIS AT TALCHER FERTILIZERS LTD., ANGUL, ODISHA

Contract No: PNPM/PC-183/E/8003/NCB

NOTE : Quantities mentioned in the Schedule of Rates are indicative and not exhaustive in nature. Payment shall be made as per actual quantity used/certified at site by Owner's Engineer-in-charge. Quantities indicated in Schedule of Rates are approximate and subject to variation on either side. The quantity of individual item may be deleted. Contractor shall not be entitled for any compensation on this account and the quoted rates shall hold good for such quantity variations etc. Payments on bills shall, however, be made on actual measurements of quantities of work done as per approved drawings. Goods & Services Tax (GST) is applicable @ 18% on the quoted rates (being Works Contract)

Name of the Bidder/ Bidding Firm / Company :							
SCHEDULE OF RATE (Rev. 0) (This BOQ template must not be modified/replaced by the bidder and the same should be uploaded after filling the relevant columns, else the bidder is liable to be rejected for this tender. Bidders are allowed to enter the Bidder Name and Values only)							
NUMBER #	TEXT #	NUMBER #	TEXT #	NUMBER #	NUMBER #	NUMBER #	TEXT #
Sl. No.	Item Description	Quantity	Units	BASIC RATE In Figures To be entered by the Bidder in Rs. P	TOTAL AMOUNT Incl. All taxes & duties (Excl. GST) in Rs. P	TOTAL AMOUNT Incl. All taxes , duties and GST in Rs. P	TOTAL AMOUNT Incl. All taxes, duties and GST In Words
30.00	Supply , Erection/installation & commissioning MISCELLANEOUS The job includes the following: Supply, erection/installation & commissioning , interface, all residual engineering to complete the Instrumentation works as per scope shall be in Bidder's scope				0.00	0.00	INR Zero Only
30.11	Supply, erection/installation & commissioning , interface, all residual engineering to complete the Instrumentation works as per scope shall be in Bidder's scope	1	LOT		0.00	0.00	INR Zero Only
Total in Figures					0.00	0.00	INR Zero Only
Quoted Rate in Figures			Select		0.0000	0.0000	Zero Only
Quoted Rate in Words			INR Zero Only				